



contents

Introduction	8/2
Solid-state switching devices	
General data	8/3
Solid-state switching devices for resistive loads	
<i>Solid-state relays</i>	
3RF21 solid-state relays, single-phase, 22.5 mm	8/8
3RF20 solid-state relays, single-phase, 45 mm	8/9
3RF22 solid-state relays, three-phase, 45 mm	8/10
<i>Solid-state contactors</i>	
General data	8/11
3RF23 solid-state contactors, single-phase	8/12
3RF24 solid-state contactors, 3-phase	8/14
Solid-state switching devices for switching motors	
<i>Solid-state contactors</i>	
General data	8/15
3RF34 solid-state contactors, 3-phase	8/16
3RF34 solid-state reversing contactors, 3-phase	8/17
3RF29 Function modules	
Assignment of modules	8/18
Converters	8/23
Load monitoring	8/24
Heating current monitoring	8/25
Power controllers	8/26
Power control regulators	8/27
Technical data	
<i>Solid-state relays</i>	
3RF21 solid-state relays, single-phase, 22.5 mm	8/29
3RF20 solid-state relays, single-phase, 45 mm	8/32
3RF22 solid-state relays, three-phase, 45 mm	8/34
<i>Solid-state contactors</i>	
3RF23 solid-state contactors, single-phase	8/36
3RF24 solid-state contactors, three-phase	8/39
3RF34 solid-state contactors, three-phase	8/41
3RF29 Function modules	
Converters, load monitors, power controller, heating current monitors	8/46
Power control regulators	8/48
Thermal data	8/49
Dimensions	8/63
Wiring diagrams	8/72

Introduction

Overview



3RF21 3RF20 3RF22 3RF23 3RF24 3RF34 (Motor) 3RF29

SIRIUS solid-state switching devices for switching resistive loads

	Order No.	Page
Solid-state relays		
22.5 mm solid-state relays, 45 mm solid-state relays	3RF21, 3RF20, 3RF22	8/9, 8/10, 8/43

Solid-state contactors		
Solid-state contactors	3RF23, 3RF24	8/24, 8/46
		8/8, 8/12

Function modules		
For extending the functionality of the 3RF21 solid-state relays and the 3RF23 solid-state contactors for many different applications:		
Converters	3RF29 00-0EA18	8/13
Load monitoring	3RF29 20-0FA08, 3RF29 .0-0GA..	8/14
Heating current monitoring	3RF29 ...0JA..	8/14
Power control regulators	3RF29 ...0KA.	8/14
Power controllers	3RF29 .0-0HA..	8/15

SIRIUS Innovations solid-state switching devices for switching motors

Solid-state contactors		
Solid-state contactors	3RF34	8/16
Solid-state reversing contactors		
		8/17

Nomenclature Guide

3RF2	0	20	-	1	A	A	0	2
SIRIUS SC	Type	Rating		Terminal Type	Switching	Control Phases	Coil Type	Power Voltage
	0 = 45 mm Relay 1 = 22.5 mm Relay 2 = 3-phase 45 mm Relay 3 = Contactor 4 = 3-phase Contactor 9 = Function Module			1 = Screw 2 = Spring 3 = Ring Tongue	A = Zero Point B = Instantaneous C = Low Noise D = Short Circuit	A = 1-phase B = 2-phase C = 3-phase	0 = 24 VDC 2 = 110 - 230 VAC 4 = 4 - 30 VDC 5 = 230 VAC	2 = 24 - 230 VAC 4 = 230 - 460 VAC 5 = 48 - 600 VAC 6 = 400 - 600 VAC

Note: This is only a guide to decode the model number. All possible combinations of these are not produced. Character of "3" in position four indicates Sirius Innovations

Overview

**SIRIUS 3RF2 solid-state switching devices**

Solid-state switching devices for resistive loads

- Solid-state relays
- Solid-state contactors
- Function modules

Solid-state switching devices for switching motors

- Solid-state contactors
- Solid state reversing contactors

The most reliable solution for any application

Compared to electro mechanical contactors, our SIRIUS 3RF2 solid-state switching devices stand out due to their considerably longer service life. Thanks to the high product quality, their switching is extremely precise, reliable and, above all, insusceptible to faults. With its variable connection methods and a wide spread of control voltages, the SIRIUS 3RF2 family is universally applicable. Depending on the individual requirements of the application, our modular switchgear can also be quite easily expanded by the addition of standardized function modules.

Semiconductor relays

SIRIUS SC semiconductor relays are suitable for surface mounting on existing cooling surfaces. Installation is quick and easy, involving just two screws. Depending on the nature of the heat sink, the capacity reaches up to 88 A on resistive loads. The 3RF21 semiconductor relays can be expanded with various function modules to adapt them to individual applications.

The semiconductor relays are available in 2 different widths:

- 3RF21 semiconductor relay with a width of 22.5 mm
- 3RF20 and 3RF22 semiconductor relay with a width of 45 mm

Both variants are only available in the "zero-point switching" version. This standard version is ideally suited for operation with resistive loads.

Selecting semiconductor relays

When selecting semiconductor relays, in addition to information about the power system, the load and the ambient conditions it is also necessary to know details of the planned design. The semiconductor relays can only conform to their specific technical specifications if they are mounted with appropriate care on an adequately dimensioned heat sink. The following procedure is recommended:

- Determine the rated current of the load and the mains voltage
- Select the relay design and choose a semiconductor relay with higher rated current than the load requires
- Determine the thermal resistance of the proposed heat sink
- Check the correct relay size with the aid of the diagram

Solid-state contactors for switching motors

The solid-state contactors for switching motors are intended for frequently switching on and off three-phase current operating mechanisms up to 5 HP and reversing up to 3 HP. The

devices are constructed with complete insulation and can be mounted directly to 3RV1 MSPs and SIRIUS overload relays, resulting in a very simple integration into motor feeders.

These three-phase solid-state contactors are equipped with a two-phase control which is particularly suitable for typical motor current circuits without connecting to the neutral conductor.

Important features:

- Insulated enclosure with integrated heat sink
- Degree of protection IP20
- Integrated mounting foot to snap on a standard mounting rail or for assembly onto a support plate
- Variety of connection methods
- Plug-in control connection
- Display via LEDs

Selecting solid-state contactors

The solid-state contactors are selected on the basis of details of the network, the load and the ambient conditions. As the solid-state contactors are already equipped with an optimally matched heat sink, the selection process is considerably simpler than that for solid-state relays.

The following procedure is recommended:

- Determine the rated current of the load and the mains voltage
- Select a solid-state contactor with the same or higher rated current than the load
- Testing the maximum permissible switching frequency based on the characteristic curves. To do this, the starting current, the starting time and the motor load in the operating phase must be known.
- If the permissible switching frequency is below the desired frequency, it is possible to achieve an increase by overdimensioning the motor.

Benefits

- Devices with integrated heat sink, "ready to use"
- Compact and space-saving design
- Reversing contactors with integrated interlocking

Application**Standards and approvals**

- IEC 60947-4-3
- UL 508, CSA for North America¹⁾
- CE marking for Europe
- C-Tick approval for Australia

¹⁾ Please note: For reversing motor applications use overvoltage protection device Type 3TX7462-3L; max. cut-off-voltage 6000 V; min. energy handling capability 100 J.

General data

Type	Solid-state relays			Solid-state contactors		Function modules					
	1-phase 22.5 mm	45 mm	3-phase 45 mm	1-phase	3-phase	Converter	Load monitoring Basic	Extended	Heating current monitoring	Power control- lers	Power regula- tors
Usage											
Simple use of existing solid-state relays	<input type="checkbox"/>	<input checked="" type="checkbox"/>	<input type="checkbox"/>	<input type="checkbox"/>	<input type="checkbox"/>	--	--	--	--	--	--
Complete device "Ready to use"	<input type="checkbox"/>	<input type="checkbox"/>	<input type="checkbox"/>	<input checked="" type="checkbox"/>	<input checked="" type="checkbox"/>	--	--	--	--	--	--
Space-saving	<input checked="" type="checkbox"/>	--	<input checked="" type="checkbox"/>	<input checked="" type="checkbox"/>	<input checked="" type="checkbox"/>	<input checked="" type="checkbox"/>	<input checked="" type="checkbox"/>	--	--	--	--
Can be extended with modular function modules	<input checked="" type="checkbox"/>	--	<input checked="" type="checkbox"/>	<input checked="" type="checkbox"/>	<input checked="" type="checkbox"/>	--	--	--	--	--	--
Frequent switching and monitoring of loads and solid-state relays/solid-state contactors	--	--	--	--	--	--	<input checked="" type="checkbox"/>	<input checked="" type="checkbox"/>	<input checked="" type="checkbox"/>	<input checked="" type="checkbox"/>	<input checked="" type="checkbox"/>
Monitoring of up to 6 partial loads	--	--	--	--	--	--	<input checked="" type="checkbox"/>	--	<input checked="" type="checkbox"/>	--	--
Monitoring of more than 6 partial loads	--	--	--	--	--	--	--	<input checked="" type="checkbox"/>	--	--	--
Control of the heating power through an analog input	--	--	--	--	--	<input checked="" type="checkbox"/>	--	--	--	<input checked="" type="checkbox"/>	<input checked="" type="checkbox"/>
Power control	--	--	--	--	--	--	--	--	--	--	<input checked="" type="checkbox"/>
Startup											
Easy setting of setpoints with "Teach" button	--	--	--	--	--	--	<input checked="" type="checkbox"/>	<input checked="" type="checkbox"/>	--	<input checked="" type="checkbox"/>	<input checked="" type="checkbox"/>
"Remote Teach" input for setting setpoints	--	--	--	--	--	--	--	--	<input checked="" type="checkbox"/>	--	--
Mounting											
Mounting onto mounting rails or mounting plates	--	--	--	<input checked="" type="checkbox"/>	<input checked="" type="checkbox"/>	--	--	--	--	--	--
Can be snapped directly onto a solid-state relay or contactor	--	--	--	--	--	<input checked="" type="checkbox"/>	<input checked="" type="checkbox"/>	<input checked="" type="checkbox"/>	<input checked="" type="checkbox"/>	<input checked="" type="checkbox"/>	<input checked="" type="checkbox"/>
For use with "Coolplate" heat sink	<input checked="" type="checkbox"/>	<input checked="" type="checkbox"/>	<input checked="" type="checkbox"/>	--	--	--	--	--	--	--	--
Cable routing											
Connection of load circuit as for controls	<input checked="" type="checkbox"/>	--	<input checked="" type="checkbox"/>	<input checked="" type="checkbox"/>	<input checked="" type="checkbox"/>	--	<input checked="" type="checkbox"/>	<input checked="" type="checkbox"/>	<input checked="" type="checkbox"/>	<input checked="" type="checkbox"/>	<input checked="" type="checkbox"/>
Connection of load circuit from above	--	<input checked="" type="checkbox"/>	--	--	--	--	--	--	--	--	--

- Function is available
- Function is possible

Note: Permissible for use at altitudes of more than 2500 m above sea level with the following derating for 3RF2 Devices:

Site altitude 2500 m above sea level:

- Reduction of rated insulation voltage to $0,93 \times U_i$
- Reduction of load current to $0,93 \times I_e$

Site altitude 3000 m above sea level:

- Reduction of rated insulation voltage to $0,88 \times U_i$
- Reduction of load current to $0,9 \times I_e$

Site altitude 4000 m above sea level:

- Reduction of rated insulation voltage to $0,79 \times U_i$
- Reduction of load current to $0,8 \times I_e$

Site altitude 5000 m above sea level:

- Reduction of rated insulation voltage to $0,75 \times U_i$
- Reduction of load current to $0,7 \times I_e$

These ratings apply to a maximum ambient temperature of 40 °C (140 °F).

General data

Benefits

- Considerable space savings thanks to a width of only 22.5 mm
- Variety of connection techniques: screw connection, spring-type connection or ring terminal end, makes for easy terminations
- Flexible for a wide range of applications with function modules for retrofitting
- Possibility of fuseless short-circuit resistant design

Advantages:

- Saves time and costs with easy wiring, simple installation and fast commissioning
- Extremely long life, low maintenance, rugged and reliable
- Space-saving and safe thanks to side-by-side mounting up to an ambient temperature of +60 °C
- Modular design: standardized function modules and heat sinks can be used in conjunction with 22.5 mm style semiconductor relays to satisfy unique application requirements
- Vibration-resistant and shock-resistant spring-loaded terminal connection system provides a superior connection even under tough conditions

Area of application**Applications****Solid-state relays**

SIRIUS solid-state relays are suitable for surface mounting on existing cooling surfaces. Installation is quick and easy, involving just two screws. The special technology of the power semiconductor ensures there is excellent thermal contact with the heat sink. Depending on the nature of the heat sink, the capacity reaches up to 88 A on resistive loads.

The solid-state relays are available in three different versions:

- 3RF21 single-phase solid-state relay with a width of 22.5 mm
- 3RF20 single-phase solid-state relay with a width of 45 mm
- 3RF22 three-phase solid-state relay with a width of 45 mm

The 3RF21 and 3RF22 solid-state relays can be expanded with various function modules to adapt them to individual applications.

Solid-state contactors

The complete units consist of a solid-state relay plus optimized heat sink, and are therefore ready to use. They offer defined rated currents to make selection as easy as possible. Depending on the version, current intensities of up to 88 A are achieved. Like all of our solid-state switching devices, one of their particular advantages is their compact and space-saving design.

With their insulated mounting foot they can easily be snapped onto a standard mounting rail, or they can be mounted on carrier plates with fixing screws. This insulation enables them to be used in circuits with protective extra-low voltage (PELV) or safety extra-low voltage (SELV) in building engineering. For other applications, such as for extended personal safety, the heat sink can be grounded through a screw terminal.

The solid-state contactors are available in two different versions:

- 3RF23 single-phase solid-state contactors
- 3RF24 three-phase solid-state contactors

3RF22 three-phase solid-state relay with a width of 45 mm

With its compact design, which stays the same even at currents of up to 55 A, the 3RF22 solid-state relay is the ultimate in space-saving construction, at a width of 45 mm. Installation on cooling surfaces is quick and easy, involving just two screws. The logical connection arrangement, with the power infeed from above and connection of the load from below, ensures tidy installation in the control cabinet.

3RF24 three-phase solid-state contactors

The compact design enables small compact units with currents up to 50 A. All special features of the solid-state relays for saving time and space are effective here too.

Example plastic machine industry:

Thanks to their high switching endurance, SIRIUS SC semiconductor switching devices are ideally suited for use in the control of electroheat. This is because the more precise the temperature regulation process has to be, the higher the switching frequency needs to be. The accurate regulation of electroheat is used for example in many processes in the plastic machine industry:

- Band heaters heat the extrudate to the correct temperature in plastic extruders
- Heat emitters heat plastic blanks to the correct temperature
- Heat drums dry plastic granules
- Heating channels keep molds at the correct temperature in order to manufacture different plastic parts without defects.

The powerful SIRIUS SC semiconductor relays and contactors can be used to control several heating loads at the same time. By using a load monitoring module the individual partial loads can easily be monitored, and in the event of a failure a signal is generated which can be sent to the controller.

Protecting the semiconductor relays and semiconductor contactors with 5 SY supplemental protectors.

Short-circuit protection and line protection with 5 SY supplemental protectors is easy to achieve with SIRIUS SC semiconductor relays and semiconductor contactors in comparison with designing load feeders with fuses. A special version of the semiconductor contactors can be protected against damage in the case of a short-circuit with 5 SY supplementary protector with type B tripping characteristic. This allows the low-cost and simple design of fuseless load feeders with full protection of the switching device.

Design

There is no typical design of a load feeder with semiconductor relays or semiconductor contactors; instead, the great variety of connection systems and control voltages offers universal application opportunities. SIRIUS SC semiconductor relays and semiconductor contactors can be installed in fuseless or fused feeders, as required.

There are special versions with which it is even possible to achieve short-circuit strength in a fuseless design.

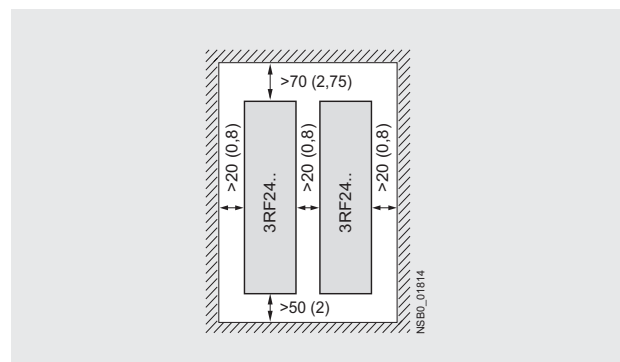
Mounting regulations

Distances for stand-alone installation

Functions

Connection

All SIRIUS SC semiconductor switching devices are characterized by the great variety of connection methods. You can choose between the following connection techniques:

SIGUT connection system (screw)

The SIGUT connection system is the standard among industrial switching devices. Open terminals and a plus-minus screw are just two features of this technology. Two conductors of up to 6 mm^2 ¹⁾ can be connected in just one terminal. As a result, loads of up to 50 A can be connected.

Spring-loaded connection system

This innovative technology holds the conductor without screw connection. This means that very high vibration resistance is achieved. Two conductors of up to 2.5 mm^2 ¹⁾ can be connected to each terminal. As a result, loads of up to 20 A can be dealt with.

Ring terminal end connection

The ring terminal end connection is equipped with an M5 screw. Ring terminal ends of up to 25 mm^2 can be connected. In this way it is possible to connect conductors with up to 88 A safely. Additional finger safety can be provided with a special cover.

Switching types

In order to guarantee an optimized control method for different loads, the functionality of our semiconductor switching devices can be adapted accordingly.

The "**zero-point switching**" method is ideal for resistive loads, i.e. where the power semiconductor is activated at zero voltage.

For inductive loads, on the other hand, for example in the case of valves, it is better to go with "**instantaneous switching**". By distributing the ON point over the entire sine curve of the mains voltage, disturbances are reduced to a minimum.

A special "low noise" version is available due to a special control, this special version can be used in public networks up to 16A without any additional measures such as interference suppressor filters. As a result, it conforms to limit value curve class B according to EN 60947-4-3 in terms of emitted interference.

Function

Two-phase controlled version

In many three-phase applications there is no need of a three-phase controller. Loads in a delta circuit or wye circuit, which have no connection to the neutral conductor, can be safely switched on and off using only two phases.

Nevertheless, the 3RF22 and 3RF24 three-phase solid-state switching devices provide the possibility of connecting all three phases to the switching device, with the middle phase looped directly through the device. Thanks to the lower power loss compared to a three-phase controlled device it is possible for the mounted accessories to be more compact.

Three-phase controlled version

This version is used in three-phase applications which have to switch all phases on and off for system reasons or in the case of loads in a wye circuit with connection to the neutral conductor.

Performance characteristics

The performance of the semiconductor switching devices are substantially determined by the type of power semiconductors used and the internal design. In the case of the SIRIUS SC semiconductor contactors and semiconductor relays, only thyristors are used instead of less powerful Triacs.

Two of the most important features of thyristors are the blocking voltage and the maximum load integral:

Blocking voltage

Thyristors with a high blocking voltage can also be operated without difficulty in power systems with high interference voltages. Separate protective measures, such as a protective circuit with a varistor, are not necessary in most cases.

With SIRIUS SC, for example, thyristors with 800 V blocking voltage are fitted for operation in power systems up to 230 V. Thyristors with up to 1600 V are used for power systems with higher voltages.

Maximum load integral

One of the purposes of specifying the maximum load integral (Pt) is to determine the rating of the short-circuit protection. Only a large power semiconductor with a correspondingly high Pt value can be given appropriate protection against destruction from a short-circuit by means of a protective device matched to the application. However, SIRIUS SC is also characterized by the optimum matching of the thyristors (Pt value) with the rated currents. The rated currents specified on the devices in conformance with EN 60947-4-3 were confirmed by extensive testing.

1) For mm^2 to AWG conversion see page 19/21 of Industrial Controls catalog.

General data

Selection and ordering data

Designation	Labeling area (W x H) mm x mm	Color	Order No.	Std. Pack Qty	Weight per pack approx. kg
Blank labels					
Unit labeling plates for "SIRIUS"¹⁾	10 x 7	Pastel turquoise	3RT19 00-1SB10	816 units	0.110
	20 x 7	Pastel turquoise	3RT19 00-1SB20	340 units	0.220
Labels for sticking for "SIRIUS"	19 x 6	Pastel turquoise	3RT19 00-1SB60	3060 unit	0.150
	19 x 6	Zinc yellow	3RT19 00-1SD60	3060 units	0.150

Unit labeling plates
(1 frame = 20 units)

1) Computer labeling system for individual inscription of unit labeling plates available from:
murrplastik Systemtechnik GmbH (<http://www.murrplastik.de>).

Integration

Notes on integration in the load feeders

The SIRIUS solid-state switching devices are very easy to integrate into the load feeders thanks to their industrial connection method and design.

Particular attention must however be paid to the circumstances of the installation and ambient conditions, as the performance of the solid-state switching devices is largely dependent on these. Depending on the version, certain restrictions must be observed. Detailed information, for example in relation to solid-state contactors about the minimum spacing and to solid-state relays about the choice of heat sink, is given in the technical specifications (see [Technical Information LV 1 T](#) or our [Mall](#)) and the product data sheets.

Despite the rugged power semiconductors that are used, solid-state switching devices respond more sensitively to short-circuits in the load feeder. Consequently, special precautions have to be taken against destruction, depending on the type of design.

Siemens generally recommends using SITOR semiconductor protection fuses. These fuses also provide protection against destruction in the event of a short-circuit even when the solid-state contactors and solid-state relays are fully utilized.

Alternatively, if there is lower loading, protection can also be provided by standard fuses or miniature circuit breakers. This protection is achieved by overdimensioning the solid-state switching devices accordingly. The technical specifications and the product data sheets contain details both about the solid-state fuse protection itself and about use of the devices with conventional protection equipment.

Semiconductor motor and reversing contactors can be easily combined with the 3RV motor starter protectors and 3RB2 overload relay from the SIRIUS modular system. Thus, fuseless and fuse motor feeders can be designed easily and in a space-saving manner.

The solid-state switching devices for resistive loads are suitable for interference-free operation in industrial networks without further measures. If they are used in public networks, it may be necessary for conducted interference to be reduced by means of filters. This does not include the special solid-state contactors of type 3RF23...-CA.. "Low Noise". These comply with the class B limit values up to a rated current of 16 A. If other versions are used, and at currents of over 16 A, standard filters can be used in order to comply with the limit values. The decisive factors when it comes to selecting the filters are essentially the current loading and the other parameters (operational voltage, design type, etc.) in the load feeder.

Suitable filters can be ordered from EPCOS AG.

You can find more information on the Internet at:

<http://www.epcos.com>

Solid-State Relays

22.5 mm semiconductor relays

Selection and ordering data



3RF21 20-1AA02



3RF21 20-2AA02



3RF21 20-3AA02

Type current ¹⁾	Maximum achievable power for type current and $U_e =$ 115 V 230 V 400 V			Screw connection ²⁾	Spring-loaded connection ³⁾	Ring cable connection	Std. Pack Qty	Weight per pack approx.
A	kW	kW	kW	Order No.	Order No.	Order No.		kg
Zero-point switching, rated operational voltage $U_e = 24$ V to 230 V								
20	2.3	4.6	-	3RF21 20-1AA□2	3RF21 20-2AA□2	3RF21 20-3AA□2	1 unit	0.075
30	3.5	6.9	-	3RF21 30-1AA□2	-	-	1 unit	0.075
50	5.8	11.5	-	3RF21 50-1AA□2	3RF21 50-2AA□2	3RF21 50-3AA□2	1 unit	0.075
70	8.1	16.1	-	3RF21 70-1AA□2	-	-	1 unit	0.075
90	10.4	20.7	-	3RF21 90-1AA□2	3RF21 90-2AA□2	3RF21 90-3AA□2	1 unit	0.075
Zero-point switching, rated operational voltage $U_e = 24$ V to 230 V, control DC 4 ... 30 V								
20	2.3	4.6	-	3RF21 20-1AA42	3RF21 20-2AA42	-	1 unit	0.075
30	3.5	6.9	-	3RF21 30-1AA42	-	-	1 unit	0.075
Zero-point switching, rated operational voltage $U_e = 48$ V to 460 V								
20	-	4.6	8	3RF21 20-1AA□4	3RF21 20-2AA□4	3RF21 20-3AA□4	1 unit	0.075
30	-	6.9	12	3RF21 30-1AA□4	-	-	1 unit	0.075
50	-	11.5	20	3RF21 50-1AA□4	3RF21 50-2AA□4 ⁴⁾	3RF21 50-3AA□4	1 unit	0.075
70	-	16.1	28	3RF21 70-1AA□4	-	-	1 unit	0.075
90	-	20.7	36	3RF21 90-1AA□4	3RF21 90-2AA□4	3RF21 90-3AA□4	1 unit	0.075
Zero-point switching, rated operational voltage $U_e = 48$ V to 600 V, control DC 4 ... 30 V								
20	-	4.6	8	3RF21 20-1AA45	3RF21 20-2AA45	-	1 unit	0.075
30	-	6.9	12	3RF21 30-1AA45	-	-	1 unit	0.075
50	-	11.5	20	3RF21 50-1AA45	-	-	1 unit	0.075
70	-	16.1	28	3RF21 70-1AA45	-	-	1 unit	0.075
90	-	20.7	36	3RF21 90-1AA45	-	3RF21 90-3AA44	1 unit	0.075
Zero-point switching, rated operational voltage $U_e = 48$ V to 600 V, blocking voltage 1600 V								
30	-	-	12	3RF21 30-1AA□6	-	-	1 unit	0.075
50	-	-	20	3RF21 50-1AA□6	3RF21 50-2AA□6	3RF21 50-3AA□6	1 unit	0.075
70	-	-	28	3RF21 70-1AA□6	-	-	1 unit	0.075
90	-	-	36	3RF21 90-1AA□6	3RF21 90-2AA□6	3RF21 90-3AA□6	1 unit	0.075
Zero-point switching, rated operational voltage $U_e = 48$ V to 600 V, control 24 V DC low power								
70	-	-	28	3RF21 70-1AA05-0KNO	-	-	1 unit	0.075
Zero-point switching, rated operational voltage $U_e = 24$ V to 230 V, control 110 V to 230 V								
50	-	-	-	3RF21 50-1BA22	-	-	1 unit	0.075
instantaneous switching, rated operational voltage $U_e = 48$ V to 460 V, control 24 V DC acc. to EN 61131-2								
20	-	-	-	3RF21 20-1BA04	-	-	1 unit	0.075
30	-	-	-	3RF21 30-1BA04	-	-	1 unit	0.075
50	-	-	-	3RF21 50-1BA04	-	-	1 unit	0.075
70	-	-	-	3RF21 70-1BA04	-	-	1 unit	0.075
90	-	-	-	3RF21 90-1BA04	-	-	1 unit	0.075
Zero-point switching, rated operational voltage $U_e = 48$ V to 600 V, control 24 V DC acc. to EN 61131-2, blocking voltage 1600 V								
50	-	-	-	3RF21 50-1BA06	-	-	1 unit	0.075
Low noise³⁾ - zero-point switching, rated operational voltage $U_e = 48$ V to 460 V, control 24 V DC acc. to EN 61131-2								
70	-	-	-	3RF21 70-1CA04	-	-	1 unit	0.075

Order No. extension for rated control supply voltage U_s

DC 24 V acc. to EN 61131-2
AC 110 V... 230 V

0
2

0
2

0
2

Other rated control supply voltages on request.

- The type current provides information about the performance of the semiconductor relay. The actual permitted operational current I_b can be smaller depending on the connection method and cooling conditions.
- Please note that this version can only be used for a rated current of up to 50 A and a conductor cross section of 10 mm².

- Please note that this version can only be used for a rated current of up to 20 A and a conductor cross section of 2.5 mm². See page 19/21 of Industrial controls catalog for mm² to AWG conversion chart.
- 50 A version with 24 AC/DC control - 3RF21 50-2AA14.

Note: See page 19/21 of Industrial Controls catalog for mm² to AWG conversion chart.

Solid-State Relays

45 mm semiconductor relays

Fused design with semiconductor protection (similar to type of coordination "2")¹⁾

The semiconductor protection for the SIRIUS SC control gear can be used with different protective devices. This allows protection by means of LV HRC fuses of operational class gL/gG or supplementary protectors. The table on page 7/21 lists the maximum permissible fuses for each SIRIUS SC controlgear.

If a fuse is used with a higher rated current than specified, semiconductor protection is no longer guaranteed. However, smaller fuses with a lower rated current for the load can be used without problems.

For protective devices with operational class gL/gG and for SITOR full range fuses 3NE1, the minimum cross-sections for the conductor to be connected must be taken into account.

Selection and ordering data



3RF20 20-1AA02

Type current ¹⁾	Maximum achievable power for type current and $U_e =$			Screw connection ²⁾	Spring-loaded connection ³⁾	Ring cable connection	Std. Pack Qty	Weight per pack approx.
	115 V	230 V	400 V					
A	kW	kW	kW	Order No.	Order No.	Order No.		kg
Zero-point switching, rated operational voltage $U_e = 24$ V to 230 V								
20	2.3	4.6	-	3RF20 20-1AA□2	-	-	1 unit	0.085
30	3.5	6.9	-	3RF20 30-1AA□2	-	-	1 unit	0.085
50	5.8	11.5	-	3RF20 50-1AA□2	-	-	1 unit	0.085
70	8.1	16.1	-	3RF20 70-1AA□2	-	-	1 unit	0.085
88	10.4	20.7	-	3RF20 90-1AA□2	-	-	1 unit	0.085
Zero-point switching, rated operational voltage $U_e = 24$ V to 230 V, control DC 4 ... 30 V								
20	-	-	-	-	3RF21 20-2AA42	-	1 unit	0.075
Zero-point switching, rated operational voltage $U_e = 48$ V to 460 V								
20	-	4.6	8	3RF20 20-1AA□4	-	-	1 unit	0.085
30	-	6.9	12	3RF20 30-1AA□4	-	-	1 unit	0.085
50	-	11.5	20	3RF20 50-1AA□4	-	-	1 unit	0.085
70	-	16.1	28	3RF20 70-1AA□4	-	-	1 unit	0.085
88	-	20.7	36	3RF20 90-1AA□4	-	-	1 unit	0.085
Zero-point switching, rated operational voltage $U_e = 24$ V to 230 V, control DC 4 ... 30 V								
20	-	-	-	3RF20 20-1AA42	3RF21 20-2AA42	-	1 unit	0.085
30	-	-	-	3RF20 30-1AA42	-	-	1 unit	0.085
Zero-point switching, rated operational voltage $U_e = 48$ V to 600 V, control DC 4 ... 30 V								
20	-	4.6	8	3RF20 20-1AA45	-	-	1 unit	0.085
50	-	11.5	20	3RF20 50-1AA45	-	-	1 unit	0.085
70	-	16.1	28	3RF20 70-1AA45	-	-	1 unit	0.085
90	-	20.7	36	3RF20 90-1AA45	-	-	1 unit	0.085
Zero-point switching, rated operational voltage $U_e = 48$ V to 600 V, blocking voltage 1600 V								
30	-	-	12	3RF20 30-1AA□6	-	-	1 unit	0.085
50	-	-	20	3RF20 50-1AA□6	-	-	1 unit	0.085
70	-	-	28	3RF20 70-1AA□6	-	-	1 unit	0.085
88	-	-	36	3RF20 90-1AA□6	-	-	1 unit	0.085
Zero-point switching, rated operational voltage $U_e = 48$ V to 460 V, control DC 4 ... 30 V switching								
50	-	-	-	3RF20 50-1BA44	-	-	1 unit	0.085
Instantaneous switching, rated operational voltage $U_e = 48$ V to 460 V, control 24 V DC acc. to EN 61131-2								
30	-	-	-	3RF20 30-1BA04	-	-	1 unit	0.085

Order No. extension for rated control supply voltage U_s

DC 24 V acc. to EN 61131-2 **0 2**

AC 110 V... 230 V **2**

Other rated control supply voltages on request.

1) The type current provides information about the performance of the semiconductor relay. The actual permitted operational current I_o can be smaller depending on the connection method and cooling conditions.

2) Please note that this version can only be used for a rated current of up to 50 A and a conductor cross section of 10mm².

3) Screw terminals and spring terminals (control current side).

Note: For mm² to AWG conversion chart see Industrial Controls catalog page 19/21.

Solid-State Relays

3RF22 solid-state relays, 3-phase, 45 mm

Selection and ordering data

Selecting solid-state relays

When selecting solid-state relays, in addition to information about the power system, the load and the ambient conditions it is also necessary to know details of the planned design. The solid-state relays can only conform to their specific technical specifications if they are mounted with appropriate care on an adequately dimensioned heat sink. The following procedure is recommended:

- Determine the rated current of the load and the mains voltage
- Select the relay design and choose a solid-state relay with higher rated current than the load
- Determine the thermal resistance of the proposed heat sink
- Check the correct relay size with the aid of the diagrams.

Type current ¹⁾	Rated control supply voltage	Screw terminal ²⁾	Weight per pack approx.
A	V	Order No.	kg

Zero-point switching Rated operational voltage U_o 48 V ... 600 V



3RF22 30-1AB45

Two-phase controlled			
30	4 ... 30 V DC	3RF22 30-1AB□5	0.150
55		3RF22 55-1AB□5	0.150
Three-phase controlled			
30	4 ... 30 V DC	3RF22 30-1AC□5	0.150
55		3RF22 55-1AC□5	0.150
	110 V AC		
	4 ... 30 V DC		

3
4

Type current ¹⁾	Rated control supply voltage	Spring-loaded terminals ³⁾	Weight per pack approx.
A	V	Order No.	kg

Zero-point switching Rated operational voltage U_o 48 V ... 600 V



3RF22 30-2AB45

Two-phase controlled			
30	4 ... 30 V DC	3RF22 30-2AB45	0.150
55		3RF22 55-2AB45	0.150
Three-phase controlled			
30	4 ... 30 V DC	3RF22 30-2AC45	0.150
55		3RF22 55-2AC45	0.150

Type current ¹⁾	Rated control supply voltage	Ring terminal end connection	Weight per pack approx.
A	V	Order No.	kg

Zero-point switching Rated operational voltage U_o 48 V ... 600 V



3RF22 30-3AB45

Two-phase controlled			
30	4 ... 30 V DC	3RF22 30-3AB45	0.150
55		3RF22 55-3AB45	0.150
Three-phase controlled			
30	4 ... 30 V DC	3RF22 30-3AC45	0.150
55		3RF22 55-3AC45	0.150

1) The type current provides information about the performance of the solid-state relay. The actual permitted rated operational current I_o can be smaller depending on the connection method and cooling conditions.

2) Please note that the version with an M4 screw terminal can only be used for a rated current of up to approx. 50 A and a conductor cross-section of 10 mm².

3) Please note that this version can only be used for a rated current of up to approx. 20 A and a conductor cross-section of 2.5 mm².

Solid-State Contactors

General data

Overview

Solid-state contactors

The complete units consist of a solid-state relay plus optimized heat sink, and are therefore ready to use. They offer defined rated currents to make selection as easy as possible. Depending on the version, current strengths of up to 88 A are achieved. Like all of our solid-state switching devices, one of their particular advantages is their compact and space-saving design.

With their insulated mounting foot they can easily be snapped onto a standard mounting rail, or they can be mounted on support plates with fixing screws. This insulation enables them to be used in circuits with protective extra-low voltage (PELV) or safety extra-low voltage (SELV) in building management systems. For other applications, such as for extended personal safety, the heat sink can be grounded through a screw terminal.

The solid-state contactors are available in 2 different versions:

- 3RF23 single-phase solid-state contactors,
- 3RF24 three-phase solid-state contactors

Single-phase versions

The 3RF23 solid-state contactors can be expanded with various function modules to adapt them to individual applications.

Version for resistive loads, "zero-point switching"

This standard version is often used for switching space heaters on and off.

Version for inductive loads, "instantaneous switching"

In this version the solid-state contactor is specifically matched to inductive loads. Whether it is a matter of frequent actuation of the valves in a filling plant or starting and stopping small operating mechanisms in packet distribution systems, operation is carried out safely and noiselessly.

Special "Low noise" version

Thanks to a special control circuit, this special version can be used in public networks up to 16 A without any additional measures such as interference suppressor filters. As a result it conforms to limit value curve class B according to EN 60947-4-3 in terms of emitted interference.

Special "Short-circuit-proof" version

Skilful matching of the power semiconductor with the performance capacity of the solid-state contactor means that "short-circuit strength" can be achieved with a standard miniature circuit breaker. In combination with a B-type MCB or a conventional line protection fuse, the result is a short-circuit resistant feeder.

In order to achieve problem-free short-circuit protection by means of miniature circuit breakers, however, certain boundary conditions must be observed. As the magnitude and duration of the short-circuit current are determined not only by the short-circuit breaking response of the miniature circuit breaker but also the properties of the wiring system, such as the internal resistance of the input to the network and damping by controls and cables, particular attention must also be paid to these parameters. The necessary cable lengths are therefore shown for the main factor, the line resistance, in the table above right.

The following miniature circuit breakers with a type B tripping characteristic and 10 kA or 6 kA breaking capacity protect the 3RF23...DA.. solid-state contactors in the event of short-circuits on the load and the specified conductor cross-sections and lengths:

Rated current of the miniature circuit breaker	Example Type ¹⁾	Max. conductor cross-section	Minimum cable length from contactor to load
6 A	5SY4 106-6, 5SX2 106-6	1 mm ²	5 m
10 A	5SY4 110-6, 5SX2 110-6	1.5 mm ²	8 m
16 A	5SY4 116-6, 5SX2 116-6	1.5 mm ²	12 m
16 A	5SY4 116-6, 5SX2 116-6	2.5 mm ²	20 m
20 A	5SY4 120-6, 5SX2 120-6	2.5 mm ²	20 m
25 A	5SY4 125-6, 5SX2 125-6	2.5 mm ²	26 m

1) The miniature circuit breakers can be used up to a maximum rated voltage of 480 V!

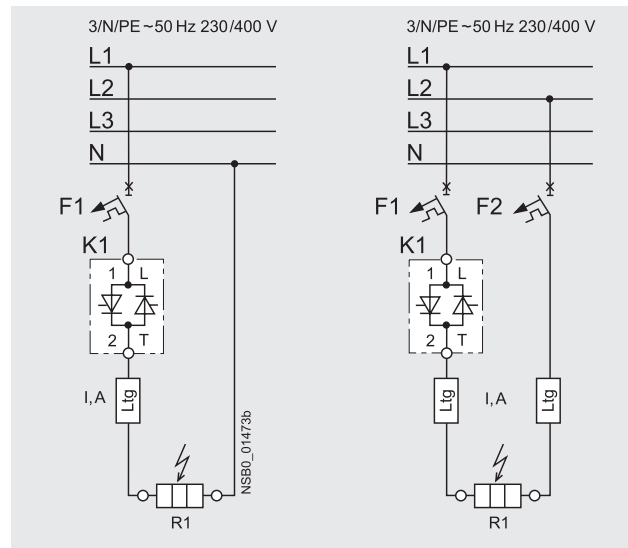

The setup and installation above can also be used for the solid-state relays with a I^2t value of at least 6600 A²s.

Three-phase versions

The three-phase solid-state contactors for resistive loads up to 50 A are available with

- two-phase control (suitable in particular for circuits without connection to the neutral conductor) and
- three-phase control (suitable for star circuits with connection to the neutral conductor or for applications in which the system requires all phases to be switched).

The converter function module can be snapped onto both versions for the simple power control of AC loads by means of analog signals.

- Check the correct contactor size with the aid of the rated current diagram, taking account of the design conditions.

Solid-State Relays

SIRIUS SC semiconductor contactors – single phase selection

Selection and ordering data

Selecting solid-state contactors

The semiconductor contactors are selected on the basis of details of the power system, the load and the ambient conditions. As the semiconductor contactors are already equipped with an optimally matched heat sink, the selection process is considerably simpler than that for semiconductor relays.

The following procedure is recommended:

- Determine the rated current of the load and the mains voltage
- Select a semiconductor contactor with the same or higher rated current than the load
- Check the correct contactor size with the aid of the rated current diagram, taking account of the design conditions



Type current 1)	Maximum achievable power for I_{max} and $U_e =$			Screw connection	Spring-loaded connection	Ring cable connection	Std. Pack Qty	Weight per pack approx.
I_{max}	115 V	230 V	400 V	Order No.	Order No.	Order No.		kg
A	kW	kW	kW					
Zero-point switching, rated operational voltage $U_e = 24$ V to 230 V								
10.5	1.2	2.4	-	3RF23 10-1AA□2	3RF23 10-2AA□2	3RF23 10-3AA□2	1 unit	0.136
20	2.3	4.6	-	3RF23 20-1AA□2	3RF23 20-2AA□2	3RF23 20-3AA□2	1 unit	0.204
30	3.5	6.9	-	3RF23 30-1AA□2	-	3RF23 30-3AA□2	1 unit	0.354
40	4.6	9.2	-	3RF23 40-1AA□2	-	3RF23 40-3AA□2	1 unit	0.496
50	6	12	-	3RF23 50-1AA□2	-	3RF23 50-3AA□2	1 unit	0.496
70	8	16	-	-	-	3RF23 70-3AA□2	1 unit	0.944
88	10	20	-	-	-	3RF23 90-3AA□2	1 unit	2.600
Zero-point switching, rated operational voltage $U_e = 24$ V to 230 V, control 24 V DC acc. to EN 61131-2³⁾								
50	-	-	-	3RF20 50-4AA02	-	-	1 unit	0.085
Zero-point switching, rated operational voltage $U_e = 24$ V to 230 V, control 24 V DC low power								
20	-	-	-	3RF23 20-1AA02-0KN0	-	-	1 unit	0.240
Zero-point switching, rated operational voltage $U_e = 48$ V to 460 V								
10.5	-	2.4	4.2	3RF23 10-1AA□4	3RF23 10-2AA□4	3RF23 10-3AA□4	1 unit	0.136
20	-	4.6	8	3RF23 20-1AA□4	3RF23 20-2AA□4	3RF23 20-3AA□4	1 unit	0.204
30	-	6.9	12	3RF23 30-1AA□4	-	3RF23 30-3AA□4	1 unit	0.354
40	-	9.2	16	3RF23 40-1AA□4	-	3RF23 40-3AA□4	1 unit	0.496
50	-	12	20	3RF23 50-1AA□4	-	3RF23 50-3AA□4	1 unit	0.496
70	-	16	28	-	-	3RF23 70-3AA□4	1 unit	0.944
88	-	20	35	-	-	3RF23 90-3AA□4	1 unit	2.600
Zero-point switching, rated operational voltage $U_e = 24$ V to 230 V, control 24 V AC/DC								
10.5	-	-	-	3RF23 10-1AA12	-	-	1 unit	0.165
Zero-point switching, rated operational voltage $U_e = 48$ V to 460 V, control 24 V DC low power								
50	-	-	-	3RF23 10-1AA04-0KN0	-	-	1 unit	0.165
Zero-point switching, rated operational voltage $U_e = 48$ V to 460 V, control 24 V AC/DC								
10.5	-	-	-	3RF23 10-1AA14	-	-	1 unit	0.165
20	-	-	-	3RF23 20-1AA14	-	-	1 unit	0.240
30	-	-	-	3RF23 30-1AA14	-	-	1 unit	0.400
40	-	-	-	3RF23 40-1AA14	-	-	1 unit	0.550
50	-	-	-	3RF23 50-1AA14	-	-	1 unit	0.550
Zero-point switching, rated operational voltage $U_e = 48$ V to 600 V, control DC 4 ... 30 V								
10.5	-	2.4	4.2	3RF23 10-1AA45	-	-	1 unit	0.135
20	-	4.6	8	3RF23 20-1AA45	-	-	1 unit	0.204
30	-	6.9	12	3RF23 30-1AA45	-	-	1 unit	0.354
40	-	9.2	16	3RF23 40-1AA45	-	3RF23 40-3AA45	1 unit	0.496
50	-	12	20	3RF23 50-1AA45	-	-	1 unit	0.496
70	-	16	26	-	-	3RF23 70-3AA45	1 unit	0.944
90	-	20	35	-	-	3RF23 90-3AA45	1 unit	2.600
Zero-point switching, rated operational voltage $U_e = 48$ V to 460 V, control 4 V ... 30 V DC								
10.5	-	-	-	3RF23 10-1AA44	-	-	1 unit	0.165
20	-	-	-	3RF23 20-1AA44	-	3RF23 20-3AA44	1 unit	0.240
30	-	-	-	3RF23 30-1AA44	-	3RF23 30-3AA44	1 unit	0.400
50	-	-	-	3RF23 50-1AA44	-	3RF23 50-3AA44	1 unit	0.400
Zero-point switching, rated operational voltage $U_e = 48$ V to 600 V, blocking voltage 1600 V								
10.5	-	-	4.2	3RF23 10-1AA□6	3RF23 10-2AA□6	3RF23 10-3AA□6	1 unit	0.136
20	-	-	8	3RF23 20-1AA□6	3RF23 20-2AA□6	3RF23 20-3AA□6	1 unit	0.204
30	-	-	12	3RF23 30-1AA□6	-	3RF23 30-3AA□6	1 unit	0.354
40	-	-	16	3RF23 40-1AA□6	-	3RF23 40-3AA□6	1 unit	0.496
50	-	-	20	3RF23 50-1AA□6	-	3RF23 50-3AA□6	1 unit	0.496
70	-	-	28	-	-	3RF23 70-3AA□6	1 unit	0.944
88	-	-	35	-	-	3RF23 90-3AA□6	1 unit	2.600

Order No. extension for rated control supply voltage U_c
 DC 24 V acc. to EN 61131-2 0
 AC 110 V ... 230 V 2

Other rated control supply voltages on request.

1) The type current provides information about the performance of the semiconductor contactor. The actual permitted operational current I_b can be smaller depending on the connection method and start-up conditions. Derating acc. to curves from page 7/45, 7/46, 7/47.

Solid-State Contactors

SIRIUS SC semiconductor contactors – single phase selection

Type current ¹⁾ I_{max}	Maximum achievable power for I_{max} and $U_e =$			Screw connection Order No.	Spring-loaded connection Order No.	Ring cable connection Order No.	Std. Pack Qty	Weight per pack approx. kg
	115 V	230 V	400 V					
A	kW	kW	kW					
Instantaneous switching, rated operational voltage $U_e = 24\text{ V to }230\text{ V}$								
10.5	1.2	2.4	-	3RF23 10-1BA□2	-	-	1 unit	0.136
20	2.3	4.6	-	3RF23 20-1BA□2	-	-	1 unit	0.204
30	3.5	6.9	-	3RF23 30-1BA□2	-	-	1 unit	0.354
40	4.6	9.2	-	3RF23 40-1BA□2	-	-	1 unit	0.496
50	6	12	-	3RF23 50-1BA□2	-	-	1 unit	0.496
70	8	16	-	3RF23 70-1BA□2	-	3RF23 70-3BA□2	1 unit	0.944
88	10	20	-	3RF23 90-1BA□2	-	3RF23 90-3BA□2	1 unit	2.600
Instantaneous switching, rated operational voltage $U_e = 48\text{ V to }460\text{ V}$								
10.5	-	2.4	4.2	3RF23 10-1BA□4	-	-	1 unit	0.136
20	-	4.6	8	3RF23 20-1BA□4	-	-	1 unit	0.204
30	-	6.9	12	3RF23 30-1BA□4	-	-	1 unit	0.354
40	-	9.2	16	3RF23 40-1BA□4	-	-	1 unit	0.496
50	-	12	20	3RF23 50-1BA□4	-	-	1 unit	0.496
70	-	16	28	3RF23 70-1BA□4	-	3RF23 70-3BA□4	1 unit	0.944
88	-	20	35	3RF23 90-1BA□4	-	3RF23 90-3BA□4	1 unit	2.600
Zero-point switching, rated operational voltage $U_e = 48\text{ V to }600\text{ V}$, control 110 V to 230 V								
30	-	-	-	3RF23 30-1AA25	-	-	1 unit	0.400
Instantaneous switching, rated operational voltage $U_e = 48\text{ V to }600\text{ V}$, blocking voltage 1600 V								
10.5	-	-	4.2	3RF23 10-1BA□6	-	-	1 unit	0.136
20	-	-	8	3RF23 20-1BA□6	-	-	1 unit	0.204
30	-	-	12	3RF23 30-1BA□6	-	-	1 unit	0.354
40	-	-	16	3RF23 40-1BA□6	-	-	1 unit	0.496
50	-	-	20	3RF23 50-1BA□6	-	-	1 unit	0.496
70	-	-	28	3RF23 70-1BA□6	-	3RF23 70-3BA□6	1 unit	0.944
88	-	-	35	3RF23 90-1BA□6	-	3RF23 90-3BA□6	1 unit	2.600
Low noise, zero-point switching, rated operational voltage $U_e = 24\text{ V to }230\text{ V}$								
20	2.3	4.6	-	3RF23 20-1CA□2	3RF23 20-2CA□2	-	1 unit	0.204
30	-	-	-	3RF23 30-1CA□2	-	-	1 unit	0.204
Low noise, zero-point switching, rated operational voltage $U_e = 48\text{ V to }460\text{ V}$								
20	-	4.6	8	3RF23 20-1CA□4	3RF23 20-2CA□4	-	1 unit	0.204
Instantaneous switching, rated operational voltage $U_e = 48\text{ V to }460\text{ V}$, control DC 4 ... 30 V switching								
20	-	-	-	3RF23 20-1BA44	-	-	1 unit	0.240
30	-	-	-	3RF23 30-1BA44	-	-	1 unit	0.400
50	-	-	-	3RF23 50-1BA44	-	-	1 unit	0.550
Short-circuit resistant with B-automatic device, zero-point switching, rated operational voltage $U_e = 24\text{ V to }230\text{ V}$								
20	2.3	4.6	-	3RF23 20-1DA□2	3RF23 20-2DA22	3RF23 20-3DA□2	1 unit	0.204
Short-circuit resistant with B-automatic device, zero-point switching, rated operational voltage $U_e = 48\text{ V to }460\text{ V}$								
20	-	4.6	8	3RF23 20-1DA□4	3RF23 20-2DA24	3RF23 20-3DA□4	1 unit	0.204
Low noise, zero-point switching, rated operational voltage $U_e = 48\text{ V to }460\text{ V}$, control 4 V to 30 V DC								
70	-	-	28	3RF21 70-1CA04	-	-	1 unit	0.240
Order No. extension for rated control supply voltage U_c								
DC 24 V acc. to EN 61131-2				0	0	0		
AC 110 V ... 230 V				2	2	2		

Other rated control supply voltages on request.

1) The type current provides information about the performance of the semiconductor contactor. The actual permitted operational current I_e can be smaller depending on the connection method and start-up conditions. Derating acc. to curves from page 7/45, 7/46, 7/47.



Version	Order No.	Std. Pack Qty	Weight per pack approx. kg
Accessories			
 Terminal cover for 3RF21 semiconductor relays and 3RF23 semiconductor contactors with ring terminal end (after simple adaptation, this terminal cover can also be used for screw connection).	3RF29 00-3PA88	10 units	0.010

3RF29 00-3PA88

Solid-State Contactors

3RF24 solid-state contactors, 3-phase

Selection and ordering data

Type current ¹⁾ I_{max}	Rated control supply voltage U_s	DT	Screw terminals		Std. Pack Qty	Weight per pack approx.
A	V		Order No.	List Price \$ per PU		kg
Zero-point switching						
Rated operational voltage U_e 48 V ... 600 V						
Two-phase controlled						
 3RF24 20-1AB45	10.5 20 30 40 50	4 ... 30 DC	A	3RF24 10-1AB45	1 unit	0.320
			B	3RF24 20-1AB45	1 unit	0.400
			B	3RF24 30-1AB45	1 unit	0.540
			B	3RF24 40-1AB45	1 unit	0.800
			B	3RF24 50-1AB45	1 unit	1.100
	10.5 20 30 40 50	110 AC	A	3RF24 10-1AB35	1 unit	0.320
			B	3RF24 20-1AB35	1 unit	0.400
			B	3RF24 30-1AB35	1 unit	0.540
			B	3RF24 40-1AB35	1 unit	0.800
			B	3RF24 50-1AB35	1 unit	1.100
	10.5 20 30 40 50	230 AC	B	3RF24 10-1AB55	1 unit	0.320
			B	3RF24 20-1AB55	1 unit	0.400
			B	3RF24 30-1AB55	1 unit	0.540
			B	3RF24 40-1AB55	1 unit	0.800
			B	3RF24 50-1AB55	1 unit	1.100
Three-phase controlled						
 3RF24 10-1AC45	10.5 20 30 40 50	4 ... 30 DC	B	3RF24 10-1AC45	1 unit	0.320
			B	3RF24 20-1AC45	1 unit	0.540
			A	3RF24 30-1AC45	1 unit	0.800
			B	3RF24 40-1AC45	1 unit	1.100
			B	3RF24 50-1AC45	1 unit	1.850
	10.5 20 30 40 50	110 AC	B	3RF24 10-1AC35	1 unit	0.320
			B	3RF24 20-1AC35	1 unit	0.540
			A	3RF24 30-1AC35	1 unit	0.800
			B	3RF24 40-1AC35	1 unit	1.100
			B	3RF24 50-1AC35	1 unit	1.850
	10.5 20 30 40 50	230 AC	B	3RF24 10-1AC55	1 unit	0.320
			B	3RF24 20-1AC55	1 unit	0.540
			B	3RF24 30-1AC55	1 unit	0.800
			B	3RF24 40-1AC55	1 unit	1.100
			B	3RF24 50-1AC55	1 unit	1.850

1) The type current provides information about the performance capacity of the solid-state contactor. The actual permitted rated operational current I_e can be smaller depending on the connection method and start-up conditions. For derating, see Technical Information on page 7/55, Characteristic Curves.

Solid-State Contactors for Switching Motors

General data

Overview

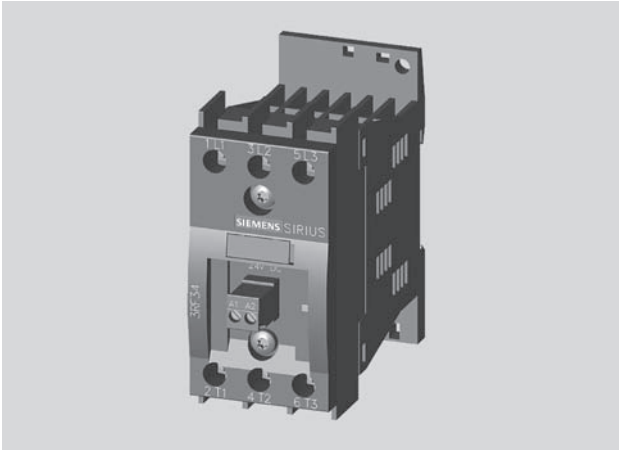

Solid-state contactor for direct-on-line starting

The solid-state contactors for switching motors are intended for frequently switching on and off three-phase current operating mechanisms up to 7.5 kW and reversing up to 3.0 kW. The devices are constructed with complete insulation and can be mounted directly on SIRIUS motor starter protectors, overload relays and current monitoring relays, resulting in a very simple integration into motor feeders.

These three-phase solid-state contactors are equipped with a two-phase control which is particularly suitable for typical motor current circuits without connecting to the neutral conductor.

Important features:

- Insulated enclosure with integrated heat sink
- Degree of protection IP20
- Integrated mounting foot to snap on a standard mounting rail or for assembly onto a support plate
- Variety of connection methods
- Plug-in control connection
- Display via LEDs
- Wide voltage range for AC control supply voltage

Switching functions

The solid-state contactors for switching motors are “instantaneous switching” because this method is particularly suited for inductive loads. By distributing the ON point over the entire sine curve of the mains voltage, disturbances are reduced to a minimum

Selecting solid-state contactors

The solid-state contactors are selected on the basis of details of the network, the load and the ambient conditions.

The following procedure is recommended:

- Determine the rated current of the load and the mains voltage
- Select a solid-state contactor with the same or higher rated current than the load
- Testing the maximum permissible switching frequency based on the characteristic curves (see “Technical Information”). To do this, the starting current, the starting time and the motor loaded in the operating phase must be known.
- If the permissible switching frequency is under the desired frequency, it is possible to achieve an increase only by overdimensioning the motor and the solid-state contactor!

Benefits

- Units with integrated heat sink, “ready to use”
- Compact and space-saving design
- Reversing contactors with integrated interlocking

Application

Use in load feeders

There is no typical design of a load feeder with solid-state relays or solid-state contactors; instead, the great variety of connection methods and control voltages offers universal application opportunities. SIRIUS solid-state relays and solid-state contactors can be installed in fuseless or fused feeders, as required.

Standards and approvals

- IEC 60947-4-2
- UL 508, CSA for North America¹⁾
- CE marking for Europe
- C-Tick approval for Australia
- CCC approval for China



¹⁾ Please note: Use overvoltage protection device; max. cut-off-voltage 6000 V; min. energy handling capability 100 J.

Solid-State Contactors for Switching Motors

3RF34 solid-state contactors, 3-phase

Selection and ordering data

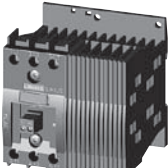
Motor contactors · Instantaneous switching · Two-phase controlled

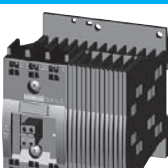
Rated operational current I_e	Rated power at I_e and U_e	Rated control supply voltage U_s	DT	Screw terminals		Std. Pack Qty
				Configurator		
A	400 V kW	V		Order No.	Price per PU	
Rated operational voltage U_e 48 ... 480 V AC						
	5.2	2.2	24 DC acc. to IEC 61131-2	A	3RF34 05-1BB04	1 unit
	9.2	4.0		B	3RF34 10-1BB04	1 unit
	12.5	5.5		B	3RF34 12-1BB04	1 unit
	16	7.5		B	3RF34 16-1BB04	1 unit
	5.2	2.2	110 ... 230 AC	B	3RF34 05-1BB24	1 unit
	9.2	4.0		B	3RF34 10-1BB24	1 unit
	12.5	5.5		B	3RF34 12-1BB24	1 unit
	16	7.5		B	3RF34 16-1BB24	1 unit
Rated operational voltage U_e 48 ... 600 V AC, blocking voltage 1600 V						
	5.2	2.2	24 DC acc. to IEC 61131-2	B	3RF34 05-1BB06	1 unit
	9.2	4.0		B	3RF34 10-1BB06	1 unit
	12.5	5.5		B	3RF34 12-1BB06	1 unit
	16	7.5		B	3RF34 16-1BB06	1 unit
	5.2	2.2	110 ... 230 AC	B	3RF34 05-1BB26	1 unit
	9.2	4.0		B	3RF34 10-1BB26	1 unit
	12.5	5.5		B	3RF34 12-1BB26	1 unit
	16	7.5		B	3RF34 16-1BB26	1 unit
Rated operational voltage U_e 48 ... 480 V AC						
	5.2	2.2	24 DC acc. to IEC 61131-2	B	3RF34 05-2BB04	1 unit
	9.2	4.0		B	3RF34 10-2BB04	1 unit
	12.5	5.5		B	3RF34 12-2BB04	1 unit
	16	7.5		B	3RF34 16-2BB04	1 unit
	5.2	2.2	110 ... 230 AC	B	3RF34 05-2BB24	1 unit
	9.2	4.0		B	3RF34 10-2BB24	1 unit
	12.5	5.5		B	3RF34 12-2BB24	1 unit
	16	7.5		B	3RF34 16-2BB24	1 unit
Rated operational voltage U_e 48 ... 600 V AC, blocking voltage 1600 V						
	5.2	2.2	24 DC acc. to IEC 61131-2	B	3RF34 05-2BB06	1 unit
	9.2	4.0		B	3RF34 10-2BB06	1 unit
	12.5	5.5		B	3RF34 12-2BB06	1 unit
	16	7.5		B	3RF34 16-2BB06	1 unit
	5.2	2.2	110 ... 230 AC	B	3RF34 05-2BB26	1 unit
	9.2	4.0		B	3RF34 10-2BB26	1 unit
	12.5	5.5		B	3RF34 12-2BB26	1 unit
	16	7.5		B	3RF34 16-2BB26	1 unit

For online configurator see www.siemens.com/sirius/configurators.

Solid-State Contactors for Switching Motors

3RF34 solid-state – reversing contactors, 3-phase

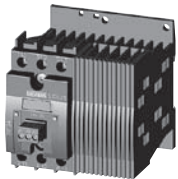

Selection and ordering data

Reversing contactors · Instantaneous switching · Two-phase controlled

Rated operational current I_e	Rated power at I_e and U_e	Rated control supply voltage U_s	DT	Screw terminals	Configurator	Std. Pack Qty
A	400 V kW	V		Order No.	Price per PU	
Rated operational voltage U_e 48 ... 480 V AC						
 3RF34 03-1BD	3.8	1.5	24 DC acc. to IEC 61131-2	B	3RF34 03-1BD04	1 unit
	5.4	2.2		B	3RF34 05-1BD04	1 unit
	7.4	3.0		B	3RF34 10-1BD04	1 unit
 3RF34 10-1BD	3.8	1.5	110 ... 230 AC	B	3RF34 03-1BD24	1 unit
	5.4	2.2		B	3RF34 05-1BD24	1 unit
	7.4	3.0		B	3RF34 10-1BD24	1 unit

For online configurator see www.siemens.com/sirius/configurators.

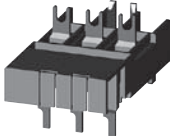
Accessories

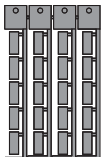
Version	DT	Order No.	Price per PU	Std. Pack Qty
Link modules for solid-state contactor to motor starter protector				
 3RA29 21-1BA00		Link module between solid-state reversing contactor and motor starter protector with screw terminals For 3RV2 motor starter protectors size S00/S0	Screw terminals	
	A	3RA29 21-1BA00		1 unit
Link adapters for solid-state contactor to overload relay				
 3RF39 00-0QA88		Link adapters for direct mounting of 3RB3 overload relays or 3RR2 current monitoring relays to the solid-state contactor with screw terminals The adapter is snapped onto the enclosure of the 3RF34 contactor and receives the fixing hooks of the 3RB3 overload relays or the 3RR2 current monitoring relays for direct mounting.		
	A	3RF39 00-0QA88		1 unit
Blank labels				
 3SB19 00-1SB20		Unit labeling plates¹⁾ for SIRIUS devices 20 mm × 7 mm, pastel turquoise		
	D	3RT19 00-1SB20		340 units

¹⁾ PC labeling system for individual inscription of unit labeling plates available from: murrplastik Systemtechnik GmbH

3RF29 Function Modules

Selection Tables

Overview

Function modules for SIRIUS 3RF2 solid-state switching devices

A great variety of applications demand an expanded range of functionality. With our function modules, these requirements can be met really easily. The modules are mounted simply by clicking them into place; straight away the necessary connections are made with the solid-state relay or contactor. The plug-in connection to control the solid-state switching devices can simply remain in use.

The following function modules are available:

- Converters
- Load monitoring
- Heating current monitoring
- Power controllers
- Power regulators

With the exception of the converter, the function modules can be used only with single-phase solid-state switching devices.

Recommended assignment of the function modules to the 3RF21 single-phase solid-state relays

Order No.	Accessories					Power controllers ¹⁾	Power regulators ¹⁾
	Converters	Load monitoring Basic	Extended	Heating current monitoring			
Type current = 20 A							
3RF21 20-1A.02	3RF29 00-0EA18	3RF29 20-0FA08	3RF29 20-0GA13	--	3RF29 20-0KA13	3RF29 20-0HA13	
3RF21 20-1A.04	3RF29 00-0EA18	3RF29 20-0FA08	3RF29 20-0GA16	3RF29 32-0JA16	3RF29 20-0KA16	3RF29 20-0HA16	
3RF21 20-1A.22	--	--	3RF29 20-0GA33	--	--	--	
3RF21 20-1A.24	--	--	3RF29 20-0GA36	--	--	--	
3RF21 20-1A.42	3RF29 00-0EA18	3RF29 20-0FA08	3RF29 20-0GA13	--	3RF29 20-0KA13	3RF29 20-0HA13	
3RF21 20-1A.45	3RF29 00-0EA18	3RF29 20-0FA08	3RF29 20-0GA16	3RF29 32-0JA16	3RF29 20-0KA16	3RF29 20-0HA16	
3RF21 20-1B.04	3RF29 00-0EA18	3RF29 20-0FA08	3RF29 20-0GA16	3RF29 32-0JA16	3RF29 20-0KA16	3RF29 20-0HA16	
3RF21 20-2A.02	3RF29 00-0EA18	--	--	--	--	--	
3RF21 20-2A.04	3RF29 00-0EA18	--	--	--	--	--	
3RF21 20-2A.22	--	--	--	--	--	--	
3RF21 20-2A.24	--	--	--	--	--	--	
3RF21 20-2A.42	3RF29 00-0EA18	--	--	--	--	--	
3RF21 20-2A.45	3RF29 00-0EA18	--	--	--	--	--	
3RF21 20-3A.02	3RF29 00-0EA18	--	3RF29 20-0GA13	--	--	3RF29 20-0HA13	
3RF21 20-3A.04	3RF29 00-0EA18	--	3RF29 20-0GA16	3RF29 32-0JA16	3RF29 20-0KA16	3RF29 20-0HA16	
3RF21 20-3A.22	--	--	3RF29 20-0GA33	--	3RF29 20-0KA13	3RF29 20-0HA13	
3RF21 20-3A.24	--	--	3RF29 20-0GA36	--	3RF29 20-0KA16	3RF29 20-0HA16	
Type current = 30 A							
3RF21 30-1A.02	3RF29 00-0EA18	3RF29 20-0FA08	3RF29 50-0GA13	--	--	3RF29 50-0HA13	
3RF21 30-1A.04	3RF29 00-0EA18	3RF29 20-0FA08	3RF29 50-0GA16	3RF29 32-0JA16	3RF29 50-0KA16	3RF29 50-0HA16	
3RF21 30-1A.06	3RF29 00-0EA18	3RF29 20-0FA08	3RF29 50-0GA16	3RF29 32-0JA16	3RF29 50-0KA16	3RF29 50-0HA16	
3RF21 30-1A.22	--	--	3RF29 50-0GA33	--	--	3RF29 50-0HA33	
3RF21 30-1A.24	--	--	3RF29 50-0GA36	--	--	3RF29 50-0HA36	
3RF21 30-1A.26	--	--	3RF29 50-0GA36	--	--	3RF29 50-0HA36	
3RF21 30-1A.42	3RF29 00-0EA18	3RF29 20-0FA08	3RF29 50-0GA13	--	--	3RF29 50-0HA13	
3RF21 30-1A.45	3RF29 00-0EA18	3RF29 20-0FA08	3RF29 50-0GA16	3RF29 32-0JA16	3RF29 50-0KA16	3RF29 50-0HA16	
3RF21 30-1B.04	3RF29 00-0EA18	3RF29 20-0FA08	3RF29 50-0GA16	3RF29 32-0JA16	3RF29 50-0KA16	3RF29 50-0HA16	
Type current = 50 A							
3RF21 50-1A.02	3RF29 00-0EA18	3RF29 20-0FA08	3RF29 50-0GA13	--	--	3RF29 50-0HA13	
3RF21 50-1A.04	3RF29 00-0EA18	3RF29 20-0FA08	3RF29 50-0GA16	3RF29 32-0JA16	3RF29 50-0KA16	3RF29 50-0HA16	
3RF21 50-1A.06	3RF29 00-0EA18	3RF29 20-0FA08	3RF29 50-0GA16	3RF29 32-0JA16	3RF29 50-0KA16	3RF29 50-0HA16	
3RF21 50-1A.22	--	--	3RF29 50-0GA33	--	--	3RF29 50-0HA33	
3RF21 50-1A.24	--	--	3RF29 50-0GA36	--	--	3RF29 50-0HA36	
3RF21 50-1A.26	--	--	3RF29 50-0GA36	--	--	3RF29 50-0HA36	
3RF21 50-1A.45	3RF29 00-0EA18	3RF29 20-0FA08	3RF29 50-0GA16	3RF29 32-0JA16	3RF29 50-0KA16	3RF29 50-0HA16	
3RF21 50-1B.04	3RF29 00-0EA18	3RF29 20-0FA08	3RF29 50-0GA16	3RF29 32-0JA16	3RF29 50-0KA16	3RF29 50-0HA16	
3RF21 50-1B.06	3RF29 00-0EA18	3RF29 20-0FA08	3RF29 50-0GA16	3RF29 32-0JA16	3RF29 50-0KA16	3RF29 50-0HA16	
3RF21 50-1B.22	--	--	3RF29 50-0GA33	--	--	3RF29 50-0HA33	
3RF21 50-2A.02	3RF29 00-0EA18	--	--	--	--	--	
3RF21 50-2A.04	3RF29 00-0EA18	--	--	--	--	--	
3RF21 50-2A.06	3RF29 00-0EA18	--	--	--	--	--	
3RF21 50-2A.14	3RF29 00-0EA18	--	--	--	--	--	
3RF21 50-2A.22	--	--	--	--	--	--	
3RF21 50-2A.24	--	--	--	--	--	--	
3RF21 50-2A.26	--	--	--	--	--	--	
3RF21 50-3A.02	3RF29 00-0EA18	--	3RF29 50-0GA13	--	--	3RF29 50-0HA13	
3RF21 50-3A.04	3RF29 00-0EA18	--	3RF29 50-0GA16	3RF29 32-0JA16	3RF29 50-0KA16	3RF29 50-0HA16	
3RF21 50-3A.06	3RF29 00-0EA18	--	3RF29 50-0GA16	3RF29 32-0JA16	3RF29 50-0KA16	3RF29 50-0HA16	
3RF21 50-3A.22	--	--	3RF29 50-0GA33	--	--	3RF29 50-0HA33	
3RF21 50-3A.24	--	--	3RF29 50-0GA36	--	--	3RF29 50-0HA36	
3RF21 50-3A.26	--	--	3RF29 50-0GA36	--	--	3RF29 50-0HA36	

1) The use of power controllers/regulators is also possible on zero-point switching versions for full-wave control mode. The generalized phase control mode is recommended only for the combination with instantaneous switching versions.

3RF29 Function Modules

Selection Tables

Order No.	Accessories					
	Converters	Load monitoring		Heating current monitoring	Power controllers ¹⁾	Power regulators ¹⁾
Type current = 70 A						
		Basic	Extended			
3RF21 70-1A.02	3RF29 00-0EA18	3RF29 20-0FA08	3RF29 50-0GA13	--	--	3RF29 50-0HA13
3RF21 70-1A.04	3RF29 00-0EA18	3RF29 20-0FA08	3RF29 50-0GA16	3RF29 32-0JA16	3RF29 50-0KA16	3RF29 50-0HA16
3RF21 70-1A.05	3RF29 00-0EA18	3RF29 20-0FA08	3RF29 50-0GA16	3RF29 32-0JA16	3RF29 50-0KA16	3RF29 50-0HA16
3RF21 70-1A.06	3RF29 00-0EA18	3RF29 20-0FA08	3RF29 50-0GA16	3RF29 32-0JA16	3RF29 50-0KA16	3RF29 50-0HA16
3RF21 70-1A.22	--	--	3RF29 50-0GA33	--	--	3RF29 50-0HA33
3RF21 70-1A.24	--	--	3RF29 50-0GA36	--	--	3RF29 50-0HA36
3RF21 70-1A.26	--	--	3RF29 50-0GA36	--	--	3RF29 50-0HA36
3RF21 70-1A.45	3RF29 00-0EA18	3RF29 20-0FA08	3RF29 50-0GA16	3RF29 32-0JA16	3RF29 50-0KA16	3RF29 50-0HA16
3RF21 70-1B.04	3RF29 00-0EA18	3RF29 20-0FA08	3RF29 50-0GA16	3RF29 32-0JA16	3RF29 50-0KA16	3RF29 50-0HA16
3RF21 70-1C.04	3RF29 00-0EA18	3RF29 20-0FA08	3RF29 50-0GA16	3RF29 32-0JA16	3RF29 50-0KA16	3RF29 50-0HA16
Type current = 90 A						
3RF21 90-1A.02	3RF29 00-0EA18	3RF29 20-0FA08	3RF29 50-0GA13	--	--	3RF29 50-0HA13
3RF21 90-1A.04	3RF29 00-0EA18	3RF29 20-0FA08	3RF29 50-0GA16	3RF29 32-0JA16	3RF29 50-0KA16	3RF29 50-0HA16
3RF21 90-1A.06	3RF29 00-0EA18	3RF29 20-0FA08	3RF29 50-0GA16	3RF29 32-0JA16	3RF29 50-0KA16	3RF29 50-0HA16
3RF21 90-1A.22	--	--	3RF29 50-0GA33	--	--	3RF29 50-0HA33
3RF21 90-1A.24	--	--	3RF29 50-0GA36	--	--	3RF29 50-0HA36
3RF21 90-1A.26	--	--	3RF29 50-0GA36	--	--	3RF29 50-0HA36
3RF21 90-1A.45	3RF29 00-0EA18	3RF29 20-0FA08	3RF29 50-0GA16	3RF29 32-0JA16	3RF29 50-0KA16	3RF29 50-0HA16
3RF21 90-1B.04	3RF29 00-0EA18	3RF29 20-0FA08	3RF29 50-0GA16	3RF29 32-0JA16	3RF29 50-0KA16	3RF29 50-0HA16
3RF21 90-2A.02	3RF29 00-0EA18	--	--	--	--	--
3RF21 90-2A.04	3RF29 00-0EA18	--	--	--	--	--
3RF21 90-2A.06	3RF29 00-0EA18	--	--	--	--	--
3RF21 90-2A.22	--	--	--	--	--	--
3RF21 90-2A.24	--	--	--	--	--	--
3RF21 90-2A.26	--	--	--	--	--	--
3RF21 90-3A.02	3RF29 00-0EA18	--	3RF29 90-0GA13	--	--	3RF29 90-0HA13
3RF21 90-3A.04	3RF29 00-0EA18	--	3RF29 90-0GA16	3RF29 32-0JA16	3RF29 90-0KA16	3RF29 90-0HA16
3RF21 90-3A.06	3RF29 00-0EA18	--	3RF29 90-0GA16	3RF29 32-0JA16	3RF29 90-0KA16	3RF29 90-0HA16
3RF21 90-3A.22	--	--	3RF29 90-0GA33	--	--	3RF29 90-0HA33
3RF21 90-3A.24	--	--	3RF29 90-0GA36	--	--	3RF29 90-0HA36
3RF21 90-3A.26	--	--	3RF29 90-0GA36	--	--	3RF29 90-0HA36
3RF21 90-3A.44	3RF29 00-0EA18	--	3RF29 90-0GA16	3RF29 32-0JA16	3RF29 90-0KA16	3RF29 90-0HA16

1) The use of power controllers/regulators is also possible on zero-point switching versions for full-wave control mode. The generalized phase control mode is recommended only for the combination with instantaneous switching versions.

Recommended assignment of the function modules to the 3RF22 three-phase solid-state relays

Order No.	Accessories					
	Converters	Load monitoring		Heating current monitoring	Power controllers	Power regulators
Type current up to 55 A						
		Basic	Extended			
3RF22 ..-1A...	3RF29 00-0EA18	--	--	--	--	--
3RF22 ..-2A...	3RF29 00-0EA18	--	--	--	--	--
3RF22 ..-3A...	3RF29 00-0EA18	--	--	--	--	--

Recommended assignment of the function modules to the 3RF23 single-phase solid-state contactors

Order No.	Accessories					
	Converters	Load monitoring		Heating current monitoring	Power controllers ¹⁾	Power regulators ¹⁾
Type current I _e = 10.5 A						
		Basic	Extended			
3RF23 10-1A.02	3RF29 00-0EA18	3RF29 20-0FA08	3RF29 20-0GA13	3RF29 16-0JA13	3RF29 20-0KA13	3RF29 20-0HA13
3RF23 10-1A.04	3RF29 00-0EA18	3RF29 20-0FA08	3RF29 20-0GA16	3RF29 32-0JA16	3RF29 20-0KA16	3RF29 20-0HA16
3RF23 10-1A.06	3RF29 00-0EA18	3RF29 20-0FA08	3RF29 20-0GA16	3RF29 32-0JA16	3RF29 20-0KA16	3RF29 20-0HA16
3RF23 10-1A.12	3RF29 00-0EA18	--	3RF29 20-0GA13	3RF29 16-0JA13	3RF29 20-0KA13	3RF29 20-0HA13
3RF23 10-1A.14	3RF29 00-0EA18	--	3RF29 20-0GA16	3RF29 32-0JA16	3RF29 20-0KA16	3RF29 20-0HA16
3RF23 10-1A.22	--	--	3RF29 20-0GA33	--	--	3RF29 20-0HA33
3RF23 10-1A.24	--	--	3RF29 20-0GA36	--	--	3RF29 20-0HA36
3RF23 10-1A.26	--	--	3RF29 20-0GA36	--	--	3RF29 20-0HA36
3RF23 10-1A.44	3RF29 00-0EA18	3RF29 20-0FA08	3RF29 20-0GA16	3RF29 32-0JA16	3RF29 20-0KA16	3RF29 20-0HA16
3RF23 10-1A.45	3RF29 00-0EA18	3RF29 20-0FA08	3RF29 20-0GA16	3RF29 32-0JA16	3RF29 20-0KA16	3RF29 20-0HA16

3RF29 Function Modules

Selection Tables

Order No.	Accessories					
	Converters	Load monitoring		Heating current monitoring	Power controllers ¹⁾	Power regulators ¹⁾
		Basic	Extended			
Type current $I_e = 10.5$ A						
3RF23 10-1B.02	3RF29 00-0EA18	3RF29 20-0FA08	3RF29 20-0GA13	3RF29 16-0JA13	3RF29 20-0KA13	3RF29 20-0HA13
3RF23 10-1B.04	3RF29 00-0EA18	3RF29 20-0FA08	3RF29 20-0GA16	3RF29 32-0JA16	3RF29 20-0KA16	3RF29 20-0HA16
3RF23 10-1B.06	3RF29 00-0EA18	3RF29 20-0FA08	3RF29 20-0GA16	3RF29 32-0JA16	3RF29 20-0KA16	3RF29 20-0HA16
3RF23 10-1B.22	--	--	3RF29 20-0GA33	--	--	3RF29 20-0HA33
3RF23 10-1B.24	--	--	3RF29 20-0GA36	--	--	3RF29 20-0HA36
3RF23 10-1B.26	--	--	3RF29 20-0GA36	--	--	3RF29 20-0HA36
3RF23 10-2A.02	3RF29 00-0EA18	--	--	--	--	--
3RF23 10-2A.04	3RF29 00-0EA18	--	--	--	--	--
3RF23 10-2A.06	3RF29 00-0EA18	--	--	--	--	--
3RF23 10-2A.22	--	--	--	--	--	--
3RF23 10-2A.24	--	--	--	--	--	--
3RF23 10-2A.26	--	--	--	--	--	--
3RF23 10-3A.02	3RF29 00-0EA18	--	3RF29 20-0GA13	3RF29 16-0JA13	3RF29 20-0KA13	3RF29 20-0HA13
3RF23 10-3A.04	3RF29 00-0EA18	--	3RF29 20-0GA16	3RF29 32-0JA16	3RF29 20-0KA16	3RF29 20-0HA16
3RF23 10-3A.06	3RF29 00-0EA18	--	3RF29 20-0GA16	3RF29 32-0JA16	3RF29 20-0KA16	3RF29 20-0HA16
3RF23 10-3A.22	--	--	3RF29 20-0GA33	--	--	3RF29 20-0HA33
3RF23 10-3A.24	--	--	3RF29 20-0GA36	--	--	3RF29 20-0HA36
3RF23 10-3A.26	--	--	3RF29 20-0GA36	--	--	3RF29 20-0HA36
Type current $I_e = 20$ A						
3RF23 20-1A.02	3RF29 00-0EA18	3RF29 20-0FA08	3RF29 20-0GA13	--	3RF29 20-0KA13	3RF29 20-0HA13
3RF23 20-1A.04	3RF29 00-0EA18	3RF29 20-0FA08	3RF29 20-0GA16	3RF29 32-0JA16	3RF29 20-0KA16	3RF29 20-0HA16
3RF23 20-1A.06	3RF29 00-0EA18	3RF29 20-0FA08	3RF29 20-0GA16	3RF29 32-0JA16	3RF29 20-0KA16	3RF29 20-0HA16
3RF23 20-1A.14	3RF29 00-0EA18	--	3RF29 20-0GA16	--	3RF29 20-0KA16	3RF29 20-0HA16
3RF23 20-1A.22	--	--	3RF29 20-0GA33	--	--	3RF29 20-0HA33
3RF23 20-1A.24	--	--	3RF29 20-0GA36	--	--	3RF29 20-0HA36
3RF23 20-1A.26	--	--	3RF29 20-0GA36	--	--	3RF29 20-0HA36
3RF23 20-1A.44	3RF29 00-0EA18	3RF29 20-0FA08	3RF29 20-0GA16	3RF29 32-0JA16	3RF29 20-0KA16	3RF29 20-0HA16
3RF23 20-1A.45	3RF29 00-0EA18	3RF29 20-0FA08	3RF29 20-0GA16	3RF29 32-0JA16	3RF29 20-0KA16	3RF29 20-0HA16
3RF23 20-1B.02	3RF29 00-0EA18	3RF29 20-0FA08	3RF29 20-0GA13	--	3RF29 20-0KA13	3RF29 20-0HA13
3RF23 20-1B.04	3RF29 00-0EA18	3RF29 20-0FA08	3RF29 20-0GA16	3RF29 32-0JA16	3RF29 20-0KA16	3RF29 20-0HA16
3RF23 20-1B.06	3RF29 00-0EA18	3RF29 20-0FA08	3RF29 20-0GA16	3RF29 32-0JA16	3RF29 20-0KA16	3RF29 20-0HA16
3RF23 20-1B.22	--	--	3RF29 20-0GA33	--	--	3RF29 20-0HA33
3RF23 20-1B.24	--	--	3RF29 20-0GA36	--	--	3RF29 20-0HA36
3RF23 20-1B.26	--	--	3RF29 20-0GA36	--	--	3RF29 20-0HA36
3RF23 20-1B.44	3RF29 00-0EA18	3RF29 20-0FA08	3RF29 20-0GA16	3RF29 32-0JA16	3RF29 20-0KA16	3RF29 20-0HA16
3RF23 20-1C.02	3RF29 00-0EA18	3RF29 20-0FA08	3RF29 20-0GA13	--	3RF29 20-0KA13	3RF29 20-0HA13
3RF23 20-1C.04	3RF29 00-0EA18	3RF29 20-0FA08	3RF29 20-0GA16	3RF29 32-0JA16	3RF29 20-0KA16	3RF29 20-0HA16
3RF23 20-1C.22	--	--	3RF29 20-0GA33	--	--	3RF29 20-0HA33
3RF23 20-1C.24	--	--	3RF29 20-0GA36	--	--	3RF29 20-0HA36
3RF23 20-1C.44	3RF29 00-0EA18	3RF29 20-0FA08	3RF29 20-0GA16	3RF29 32-0JA16	3RF29 20-0KA16	3RF29 20-0HA16
3RF23 20-1D.02	3RF29 00-0EA18	3RF29 20-0FA08	3RF29 20-0GA13	--	3RF29 20-0KA13	3RF29 20-0HA13
3RF23 20-1D.04	3RF29 00-0EA18	3RF29 20-0FA08	3RF29 20-0GA16	3RF29 32-0JA16	3RF29 20-0KA16	3RF29 20-0HA16
3RF23 20-1D.22	--	--	3RF29 20-0GA33	--	--	3RF29 20-0HA33
3RF23 20-1D.24	--	--	3RF29 20-0GA36	--	--	3RF29 20-0HA36
3RF23 20-1D.44	3RF29 00-0EA18	3RF29 20-0FA08	3RF29 20-0GA16	3RF29 32-0JA16	3RF29 20-0KA16	3RF29 20-0HA16
3RF23 20-2A.02	3RF29 00-0EA18	--	--	--	--	--
3RF23 20-2A.04	3RF29 00-0EA18	--	--	--	--	--
3RF23 20-2A.06	3RF29 00-0EA18	--	--	--	--	--
3RF23 20-2A.22	--	--	--	--	--	--
3RF23 20-2A.24	--	--	--	--	--	--
3RF23 20-2A.26	--	--	--	--	--	--
3RF23 20-2C.02	3RF29 00-0EA18	--	--	--	--	--
3RF23 20-2C.04	3RF29 00-0EA18	--	--	--	--	--
3RF23 20-2C.22	--	--	--	--	--	--
3RF23 20-2C.24	--	--	--	--	--	--
3RF23 20-2D.22	--	--	--	--	--	--
3RF23 20-2D.24	--	--	--	--	--	--
3RF23 20-3A.02	3RF29 00-0EA18	--	3RF29 20-0GA13	--	3RF29 20-0KA13	3RF29 20-0HA13
3RF23 20-3A.04	3RF29 00-0EA18	--	3RF29 20-0GA16	3RF29 32-0JA16	3RF29 20-0KA16	3RF29 20-0HA16
3RF23 20-3A.06	3RF29 00-0EA18	--	3RF29 20-0GA16	3RF29 32-0JA16	3RF29 20-0KA16	3RF29 20-0HA16
3RF23 20-3A.22	--	--	3RF29 20-0GA33	--	--	3RF29 20-0HA33
3RF23 20-3A.24	--	--	3RF29 20-0GA36	--	--	3RF29 20-0HA36
3RF23 20-3A.26	--	--	3RF29 20-0GA36	--	--	3RF29 20-0HA36
3RF23 20-3A.44	3RF29 00-0EA18	--	3RF29 20-0GA16	3RF29 32-0JA16	3RF29 20-0KA16	3RF29 20-0HA16

1) The use of power controllers/regulators is also possible on zero-point switching versions for full-wave control mode. The generalized phase control mode is recommended only for the combination with instantaneous switching versions.

3RF29 Function Modules

Selection Tables

Order No.	Accessories					
	Converters	Load monitoring		Heating current monitoring	Power controllers ¹⁾	Power regulators ¹⁾
		Basic	Extended			
Type current $I_e = 20\text{ A}$						
3RF23 20-3D.02	3RF29 00-0EA18	--	3RF29 20-0GA13	--	3RF29 20-0KA13	3RF29 20-0HA13
3RF23 20-3D.04	3RF29 00-0EA18	--	3RF29 20-0GA16	3RF29 32-0JA16	3RF29 20-0KA16	3RF29 20-0HA16
3RF23 20-3D.22	--	--	3RF29 20-0GA33	--	--	3RF29 20-0HA33
3RF23 20-3D.24	--	--	3RF29 20-0GA36	--	--	3RF29 20-0HA36
Type current $I_e = 30\text{ A}$						
3RF23 30-1A.02	3RF29 00-0EA18	3RF29 20-0FA08	3RF29 50-0GA13	--	--	3RF29 50-0HA13
3RF23 30-1A.04	3RF29 00-0EA18	3RF29 20-0FA08	3RF29 50-0GA16	3RF29 32-0JA16	3RF29 50-0KA16	3RF29 50-0HA16
3RF23 30-1A.06	3RF29 00-0EA18	3RF29 20-0FA08	3RF29 50-0GA16	3RF29 32-0JA16	3RF29 50-0KA16	3RF29 50-0HA16
3RF23 30-1A.14	3RF29 00-0EA18	--	3RF29 50-0GA16	3RF29 32-0JA16	3RF29 50-0KA16	3RF29 50-0HA16
3RF23 30-1A.22	--	--	3RF29 50-0GA33	--	--	3RF29 50-0HA33
3RF23 30-1A.24	--	--	3RF29 50-0GA36	--	--	3RF29 50-0HA36
3RF23 30-1A.25	--	--	3RF29 50-0GA36	--	--	3RF29 50-0HA36
3RF23 30-1A.26	--	--	3RF29 50-0GA36	--	--	3RF29 50-0HA36
3RF23 30-1A.44	3RF29 00-0EA18	--	3RF29 50-0GA16	3RF29 32-0JA16	3RF29 50-0KA16	3RF29 50-0HA16
3RF23 30-1A.45	3RF29 00-0EA18	--	3RF29 50-0GA16	3RF29 32-0JA16	3RF29 50-0KA16	3RF29 50-0HA16
3RF23 30-1B.02	3RF29 00-0EA18	3RF29 20-0FA08	3RF29 50-0GA13	--	--	3RF29 50-0HA13
3RF23 30-1B.04	3RF29 00-0EA18	3RF29 20-0FA08	3RF29 50-0GA16	3RF29 32-0JA16	3RF29 50-0KA16	3RF29 50-0HA16
3RF23 30-1B.06	3RF29 00-0EA18	3RF29 20-0FA08	3RF29 50-0GA16	3RF29 32-0JA16	3RF29 50-0KA16	3RF29 50-0HA16
3RF23 30-1B.22	--	--	3RF29 50-0GA33	--	--	3RF29 50-0HA33
3RF23 30-1B.24	--	--	3RF29 50-0GA36	--	--	3RF29 50-0HA36
3RF23 30-1B.26	--	--	3RF29 50-0GA36	--	--	3RF29 50-0HA36
3RF23 30-1B.44	3RF29 00-0EA18	--	3RF29 50-0GA16	3RF29 32-0JA16	3RF29 50-0KA16	3RF29 50-0HA16
3RF23 30-1C.02	3RF29 00-0EA18	3RF29 20-0FA08	3RF29 50-0GA13	--	--	3RF29 50-0HA13
3RF23 30-1D.44	3RF29 00-0EA18	--	3RF29 50-0GA16	3RF29 32-0JA16	3RF29 50-0KA16	3RF29 50-0HA16
3RF23 30-3A.02	3RF29 00-0EA18	--	3RF29 50-0GA13	--	--	3RF29 50-0HA13
3RF23 30-3A.04	3RF29 00-0EA18	--	3RF29 50-0GA16	3RF29 32-0JA16	3RF29 50-0KA16	3RF29 50-0HA16
3RF23 30-3A.066	3RF29 00-0EA18	--	3RF29 50-0GA16	3RF29 32-0JA16	3RF29 50-0KA16	3RF29 50-0HA16
3RF23 30-3A.22	--	--	3RF29 50-0GA33	--	--	3RF29 50-0HA33
3RF23 30-3A.24	--	--	3RF29 50-0GA36	--	--	3RF29 50-0HA36
3RF23 30-3A.26	--	--	3RF29 50-0GA36	--	--	3RF29 50-0HA36
3RF23 30-3A.44	3RF29 00-0EA18	--	3RF29 50-0GA16	3RF29 32-0JA16	3RF29 50-0KA16	3RF29 50-0HA16
Type current $I_e = 40\text{ A}$						
3RF23 40-1A.02	3RF29 00-0EA18	--	3RF29 50-0GA13	--	--	3RF29 50-0HA13
3RF23 40-1A.04	3RF29 00-0EA18	--	3RF29 50-0GA16	--	3RF29 50-0KA16	3RF29 50-0HA16
3RF23 40-1A.06	3RF29 00-0EA18	--	3RF29 50-0GA16	--	3RF29 50-0KA16	3RF29 50-0HA16
3RF23 40-1A.14	3RF29 00-0EA18	--	3RF29 50-0GA16	--	3RF29 50-0KA16	3RF29 50-0HA16
3RF23 40-1A.22	--	--	3RF29 50-0GA33	--	--	3RF29 50-0HA33
3RF23 40-1A.24	--	--	3RF29 50-0GA36	--	--	3RF29 50-0HA36
3RF23 40-1A.26	--	--	3RF29 50-0GA36	--	--	3RF29 50-0HA36
3RF23 40-1A.45	3RF29 00-0EA18	--	3RF29 50-0GA16	--	3RF29 50-0KA16	3RF29 50-0HA16
3RF23 40-1B.02	3RF29 00-0EA18	--	3RF29 50-0GA13	--	--	3RF29 50-0HA13
3RF23 40-1B.04	3RF29 00-0EA18	--	3RF29 50-0GA13	--	3RF29 50-0KA16	3RF29 50-0HA16
3RF23 40-1B.06	3RF29 00-0EA18	--	3RF29 50-0GA13	--	3RF29 50-0KA16	3RF29 50-0HA16
3RF23 40-1B.22	--	--	3RF29 50-0GA33	--	--	3RF29 50-0HA33
3RF23 40-1B.24	--	--	3RF29 50-0GA36	--	--	3RF29 50-0HA36
3RF23 40-1B.26	--	--	3RF29 50-0GA36	--	--	3RF29 50-0HA36
3RF23 40-3A.02	3RF29 00-0EA18	--	3RF29 50-0GA13	--	--	3RF29 50-0HA13
3RF23 40-3A.04	3RF29 00-0EA18	--	3RF29 50-0GA16	--	3RF29 50-0KA16	3RF29 50-0HA16
3RF23 40-3A.06	3RF29 00-0EA18	--	3RF29 50-0GA16	--	3RF29 50-0KA16	3RF29 50-0HA16
3RF23 40-3A.22	--	--	3RF29 50-0GA33	--	--	3RF29 50-0HA33
3RF23 40-3A.24	--	--	3RF29 50-0GA36	--	--	3RF29 50-0HA36
3RF23 40-3A.26	--	--	3RF29 50-0GA36	--	--	3RF29 50-0HA36
3RF23 40-3A.45	3RF29 00-0EA18	--	3RF29 50-0GA16	--	3RF29 50-0KA16	3RF29 50-0HA16
Type current $I_e = 50\text{ A}$						
3RF23 50-1A.02	3RF29 00-0EA18	--	3RF29 50-0GA13	--	--	3RF29 50-0HA13
3RF23 50-1A.04	3RF29 00-0EA18	--	3RF29 50-0GA16	--	3RF29 50-0KA16	3RF29 50-0HA16
3RF23 50-1A.06	3RF29 00-0EA18	--	3RF29 50-0GA16	--	3RF29 50-0KA16	3RF29 50-0HA16
3RF23 50-1A.14	3RF29 00-0EA18	--	3RF29 50-0GA16	--	3RF29 50-0KA16	3RF29 50-0HA16
3RF23 50-1A.22	--	--	3RF29 50-0GA33	--	--	3RF29 50-0HA33
3RF23 50-1A.24	--	--	3RF29 50-0GA36	--	--	3RF29 50-0HA36
3RF23 50-1A.26	--	--	3RF29 50-0GA36	--	--	3RF29 50-0HA36
3RF23 50-1A.45	3RF29 00-0EA18	--	3RF29 50-0GA16	--	3RF29 50-0KA16	3RF29 50-0HA16

1) The use of power controllers/regulators is also possible on zero-point switching versions for full-wave control mode. The generalized phase control mode is recommended only for the combination with instantaneous switching versions.

3RF29 Function Modules

Selection Tables

Order No.	Accessories					
	Converters	Load monitoring		Heating current monitoring	Power controllers ¹⁾	Power regulators ¹⁾
		Basic	Extended			
Type current $I_e = 50$ A						
3RF23 50-1B.02	3RF29 00-0EA18	--	3RF29 50-0GA13	--	--	3RF29 50-0HA13
3RF23 50-1B.04	3RF29 00-0EA18	--	3RF29 50-0GA16	--	3RF29 50-0KA16	3RF29 50-0HA16
3RF23 50-1B.06	3RF29 00-0EA18	--	3RF29 50-0GA16	--	3RF29 50-0KA16	3RF29 50-0HA16
3RF23 50-1B.22	--	--	3RF29 50-0GA33	--	--	3RF29 50-0HA33
3RF23 50-1B.24	--	--	3RF29 50-0GA36	--	--	3RF29 50-0HA36
3RF23 50-1B.26	--	--	3RF29 50-0GA36	--	--	3RF29 50-0HA36
3RF23 50-1B.44	3RF29 00-0EA18	--	3RF29 50-0GA16	--	3RF29 50-0KA16	3RF29 50-0HA16
3RF23 50-3A.02	3RF29 00-0EA18	--	3RF29 50-0GA13	--	--	3RF29 50-0HA13
3RF23 50-3A.04	3RF29 00-0EA18	--	3RF29 50-0GA16	--	3RF29 50-0KA16	3RF29 50-0HA16
3RF23 50-3A.06	3RF29 00-0EA18	--	3RF29 50-0GA16	--	3RF29 50-0KA16	3RF29 50-0HA16
3RF23 50-3A.22	--	--	3RF29 50-0GA33	--	--	3RF29 50-0HA33
3RF23 50-3A.24	--	--	3RF29 50-0GA36	--	--	3RF29 50-0HA36
3RF23 50-3A.26	--	--	3RF29 50-0GA36	--	--	3RF29 50-0HA36
3RF23 50-3A.44	3RF29 00-0EA18	--	3RF29 50-0GA16	--	3RF29 50-0KA16	3RF29 50-0HA16
Type current $I_e = 70$ A						
3RF23 70-1B.02	3RF29 00-0EA18	--	3RF29 50-0GA13	--	--	3RF29 50-0HA13
3RF23 70-1B.04	3RF29 00-0EA18	--	3RF29 50-0GA16	--	3RF29 50-0KA16	3RF29 50-0HA16
3RF23 70-1B.06	3RF29 00-0EA18	--	3RF29 50-0GA16	--	3RF29 50-0KA16	3RF29 50-0HA16
3RF23 70-1B.22	--	--	3RF29 50-0GA33	--	--	3RF29 50-0HA33
3RF23 70-1B.24	--	--	3RF29 50-0GA36	--	--	3RF29 50-0HA36
3RF23 70-1B.26	--	--	3RF29 50-0GA36	--	--	3RF29 50-0HA36
3RF23 70-3A.02	3RF29 00-0EA18	--	3RF29 90-0GA13	--	--	3RF29 90-0HA13
3RF23 70-3A.04	3RF29 00-0EA18	--	3RF29 90-0GA16	--	3RF29 90-0KA16	3RF29 90-0HA16
3RF23 70-3A.06	3RF29 00-0EA18	--	3RF29 90-0GA16	--	3RF29 90-0KA16	3RF29 90-0HA16
3RF23 70-3A.22	--	--	3RF29 90-0GA33	--	--	3RF29 90-0HA33
3RF23 70-3A.24	--	--	3RF29 90-0GA36	--	--	3RF29 90-0HA36
3RF23 70-3A.26	--	--	3RF29 90-0GA36	--	--	3RF29 90-0HA36
3RF23 70-3A.45	3RF29 00-0EA18	--	3RF29 90-0GA16	--	3RF29 90-0KA16	3RF29 90-0HA16
3RF23 70-3B.02	3RF29 00-0EA18	--	3RF29 90-0GA13	--	--	3RF29 90-0HA13
3RF23 70-3B.04	3RF29 00-0EA18	--	3RF29 90-0GA16	--	3RF29 90-0KA16	3RF29 90-0HA16
3RF23 70-3B.06	3RF29 00-0EA18	--	3RF29 90-0GA16	--	3RF29 90-0KA16	3RF29 90-0HA16
3RF23 70-3B.22	--	--	3RF29 90-0GA33	--	--	3RF29 90-0HA33
3RF23 70-3B.24	--	--	3RF29 90-0GA36	--	--	3RF29 90-0HA36
3RF23 70-3B.26	--	--	3RF29 90-0GA36	--	--	3RF29 90-0HA36
Type current $I_e = 90$ A						
3RF23 90-1B.02	3RF29 00-0EA18	--	3RF29 50-0GA13	--	--	3RF29 50-0HA13
3RF23 90-1B.04	3RF29 00-0EA18	--	3RF29 50-0GA16	--	3RF29 50-0KA16	3RF29 50-0HA16
3RF23 90-1B.06	3RF29 00-0EA18	--	3RF29 50-0GA16	--	3RF29 50-0KA16	3RF29 50-0HA16
3RF23 90-1B.22	--	--	3RF29 50-0GA33	--	--	3RF29 50-0HA33
3RF23 90-1B.24	--	--	3RF29 50-0GA36	--	--	3RF29 50-0HA36
3RF23 90-1B.26	--	--	3RF29 50-0GA36	--	--	3RF29 50-0HA36
3RF23 90-3A.02	3RF29 00-0EA18	--	3RF29 90-0GA13	--	--	3RF29 90-0HA13
3RF23 90-3A.04	3RF29 00-0EA18	--	3RF29 90-0GA16	--	3RF29 90-0KA16	3RF29 90-0HA16
3RF23 90-3A.06	3RF29 00-0EA18	--	3RF29 90-0GA16	--	3RF29 90-0KA16	3RF29 90-0HA16
3RF23 90-3A.22	--	--	3RF29 90-0GA33	--	--	3RF29 90-0HA33
3RF23 90-3A.24	--	--	3RF29 90-0GA36	--	--	3RF29 90-0HA36
3RF23 90-3A.26	--	--	3RF29 90-0GA36	--	--	3RF29 90-0HA36
3RF23 90-3A.45	3RF29 00-0EA18	--	3RF29 90-0GA16	--	3RF29 90-0KA16	3RF29 90-0HA16
3RF23 90-3B.02	3RF29 00-0EA18	--	3RF29 90-0GA13	--	--	3RF29 90-0HA13
3RF23 90-3B.04	3RF29 00-0EA18	--	3RF29 90-0GA16	--	3RF29 90-0KA16	3RF29 90-0HA16
3RF23 90-3B.06	3RF29 00-0EA18	--	3RF29 90-0GA16	--	3RF29 90-0KA16	3RF29 90-0HA16
3RF23 90-3B.22	--	--	3RF29 90-0GA33	--	--	3RF29 90-0HA33
3RF23 90-3B.24	--	--	3RF29 90-0GA36	--	--	3RF29 90-0HA36
3RF23 90-3B.26	--	--	3RF29 90-0GA36	--	--	3RF29 90-0HA36

1) The use of power controllers/regulators is also possible on zero-point switching versions for full-wave control mode. The generalized phase control mode is recommended only for the combination with instantaneous switching versions.

Recommended assignment of the function modules to the 3RF24 three-phase solid-state contactors

Order No.	Accessories					
	Converters	Load monitoring		Heating current monitoring	Power controllers	Power regulators
		Basic	Extended			
Type current up to 50 A						
3RF24 ..-1..4.	3RF29 00-0EA18	--	--	--	--	--
3RF24 ..-2..4.	--	--	--	--	--	--
3RF24 ..-3..4.	3RF29 00-0EA18	--	--	--	--	--
3RF24 ..-4..5.	--	--	--	--	--	--

Overview

Converter for SIRIUS SC semiconductor switching devices

This module is used to convert analog drive signals, such as those output from many temperature controllers, for example, into a pulse-width-modulated digital signal. The connected semiconductor contactors and relays can therefore regulate the output of a load as a percentage.

Area of application

The device is used for conversion from an analog input signal to an on/off ratio. The function module can only be used in conjunction with a 3RF21 semiconductor relay or a 3RF23 semiconductor contactor.

Design

Mounting

Simply snapping onto the 3RF21 semiconductor relays or 3RF23 semiconductor contactors establishes the connections to the semiconductor switching devices. The connector on the semiconductor switching devices from the control circuit can be used on the converter without rewiring.

Functions

The analog value from a temperature controller is present at the 0–10 V terminals. This controls the on-to-off period, as a function of voltage. The period duration is predefined at one second. Conversion of the analog voltage is linear in the voltage range from 0.1 to 9.9 V. At voltages below 0.1 V the connected switching device is not activated, while at voltages above 9.9 V the connected switching device is always activated.

Technical specifications

Control input for converter and load monitoring

Type		3RF29 00-0EA18	3RF29 ..-0HA.
Analog input	V	0 ... 10	0 ... 10
Permissible range	V	-1 ... 11	-1 ... 11
Input resistance	kΩ	100	8
Period duration	s	1	1

Selection and ordering data

Rated operational current I_e	Rated operational voltage U_e	Rated control supply voltage U_s AC/DC 24 V	Std. Pack Qty.	Weight per pack approx.
A	V	Order No.		kg
—	—	3RF29 00-0EA18	1 unit	0.025



3RF29 00-0EA18

Function Modules

Load monitoring

Overview

Load monitoring for SIRIUS SC semiconductor switching devices

With the addition of the load monitoring module many faults can be quickly detected by monitoring a load circuit connected to the semiconductor switching device. Examples include the failure of load elements (up to 6 in the basic version or up to 12 in the extended version), alloyed power semiconductors, a lack of voltage or a break in a load circuit. A fault is indicated by one or more LEDs and reported to the controller via a PLC-compatible output.

The operating principle is based on monitoring of the current. This figure is continuously compared with the reference value stored once during commissioning by the simple press of a button. In order to detect the failure of one of several loads, the current decrease must be 1/6 (in the basic version) or 1/12 (in the extended version) of the reference value. In the event of a fault, a contact (NC) is actuated and one or more LEDs indicate the fault.

Area of application

The device is used for monitoring one or more loads (partial loads). The function module can only be used in conjunction with a 3RF21 semiconductor relay or a 3RF23 semiconductor contactor. The devices with spring-loaded connections in the load circuit are not suitable for use with load monitoring modules.

Design

Mounting

Simply snapping the load monitoring module onto the 3RF21 semiconductor relays or 3RF23 semiconductor contactors establishes the control connections to the semiconductor switching devices. Because of the special design, the straight-through transformer of the load monitoring module covers the lower main power connection. The cable to the load is simply pushed through and secured with the terminal screw.

Functions

The function module is activated when an "ON" signal is applied (IN terminal). The module constantly monitors the current level and compares this with the setpoint value.

Start-up

Pressing the "Teach" button switches the device on; the current through the semiconductor switching device is measured and is stored as the setpoint. During this process the two lower (red¹⁾) LEDs flash alternately; simultaneous maintained light from the 3 (red¹⁾) LEDs indicates the conclusion of the teaching process.

The "Teach" button can also be used to switch on the connected semiconductor switching device briefly for test purposes. In this case the "ON" LED is switched on.

Partial load faults, "basic" load monitoring

If a decrease of at least 1/6 of the stored setpoint value is detected, a fault is signaled. The fault is indicated via a "Fault" LED and by activation of the fault signaling output.

LEDs	OK	Fault		
		Partial load failure/ load short-circuit	Thyristor defect	Mains failure/ fuse rupture
ON/OFF	✓	✓	-	✓
Current flowing	✓	✓	✓	-
Group fault	-	✓	✓	✓

✓ Function is available
- Function not available

Partial load faults, "extended" load monitoring

Depending on the setting of the "response time" potentiometer, a decrease of at least 1/12 of the stored setpoint value after a response time of between 100 ms and 3 s is signaled as a fault. The fault is indicated via a "Load" LED and by activation of the fault signaling output.

The potentiometer can also be used to determine the response behavior of the fault signaling output. When delay values are set in the left-hand half, the fault signal is stored. This can only be reset by switching on and off by means of the control supply voltage.

When settings are made on the right-hand side, the fault output is automatically reset after the deviation has been corrected.

Voltage compensation, "extended" load monitoring

In addition to the current, the load voltage is also monitored. This makes it possible to compensate for influences on the current strength resulting from voltage fluctuations.

Thyristor fault

If a current greater than the residual current of the switching device is measured in the deenergized state, the device triggers a thyristor fault after the set time delay. This means that the fault output is activated and the "Fault" ("Thyristor"¹⁾) LED lights up.

Supply fault

If no current is measured in the energized state, the device triggers a supply fault after the set time delay. This means that the fault output is activated and the "Fault" ("Supply"¹⁾) LED lights up.

1) "Extended" load monitoring

Selection and ordering data

Rated operational current I_e A	Rated operational voltage U_e V	Rated control supply voltage U_s AC 110 V	Rated control supply voltage U_s AC/DC 24 V	Std. Pack Qty	Weight per pack approx. kg	Rated control supply voltage U_s DC 24 V	Std. Pack Qty	Weight per pack approx. kg
		Order No.	Order No.			Order No.		
Basic load monitoring								
6	-	-	-			3RF29 06-0FA08 ¹⁾	1 unit	0.050
20	-	-	-			3RF29 20-0FA08		
Extended load monitoring								
20	110 ... 230	3RF29 20-0GA33	3RF29 20-0GA13	1 unit	0.120	-		
20	400 ... 600	3RF29 20-0GA36	3RF29 20-0GA16	1 unit	0.120	-		
50	110 ... 230	3RF29 50-0GA33	3RF29 50-0GA13	1 unit	0.120	-		
50	400 ... 600	3RF29 50-0GA36	3RF29 50-0GA16	1 unit	0.120	-		
90	110 ... 230	3RF29 90-0GA33	3RF29 90-0GA13	1 unit	0.120	-		
90	400 ... 600	3RF29 90-0GA36	3RF29 90-0GA16	1 unit	0.120	-		

1) To order with mounted 3RF29 00-ORA88 cover, add -0KH0 to part number.

3RF29 Function Modules

Heating current monitoring

Overview

Heating current monitoring for 3RF2 single-phase solid-state switching devices

Many faults can be quickly detected by monitoring a load circuit connected to the solid-state switching device, as made possible with this module. Examples include the failure of up to 6 load elements, alloyed power semiconductors, a lack of voltage or a break in a load circuit. A fault is indicated by LEDs and reported to the controller by way of a relay output (NC contact).

The principle of operation is based on permanent monitoring of the current strength. This figure is continuously compared with the reference value stored once during start-up. In order to detect the failure of one of several loads, the current difference must be 1/6 of the reference value. In the event of a fault, an output is actuated and the LEDs indicate the fault.

The heating current monitoring has a teach input and therefore differs from the load monitoring. This remote teaching function enables simple adjustment to changing loads without manual intervention.

Special versions: deviations from the standard version

3RF29 ...0JA1.-1KK0

If the current is below 50 % of the lower teach current during the teach routine, the device will go into "Standby" mode; the LOAD LED will flicker. The device thus detects a non-connected load, e. g. channels not required for tool heaters, and does not signal a fault. This mode can be reset by re-teaching.

Application

The device is used for monitoring one or more loads (partial loads). The function module can only be used in conjunction with a 3RF21 solid-state relay or a 3RF23 solid-state contactor. The devices with spring-loaded connections in the load circuit are not suitable.

Selection and ordering data

Rated operational current I_e	Rated operational voltage U_e	Order No.	Std. Pack Qty	Weight per pack approx. kg
---------------------------------	---------------------------------	-----------	---------------	----------------------------

Heating current monitoring¹⁾



Rated control supply voltage 24 V AC/DC

16	110 ... 230	3RF29 16-0JA13	1 unit	0.175
16	110 ... 230	3RF29 16-0JA13-1KK0	1 unit	0.175
16	400 ... 600	3RF29 16-0JA16-1KK0	1 unit	0.175
32	110 ... 230	3RF29 32-0JA13-1KK0	1 unit	0.175
32	400 ... 600	3RF29 32-0JA16	1 unit	0.175
32	400 ... 600	3RF29 32-0JA16-1KK0	1 unit	0.175

1) Supplied without control connector. The control connector can be purchased from Phoenix Contact by quoting Order No. 1982 790 (2.5 HC/6-ST-5.08).

Version	Order No.	Std. Pack Qty	Weight per pack approx. kg
---------	-----------	---------------	----------------------------

Optional accessories



3RF29 00-0RA88

Sealable covers for function modules (not for converters)	3RF29 00-0RA88	10 units	0.001
--	-----------------------	----------	-------

* You can order this quantity or a multiple thereof.

3RF29 Function Modules

Power controllers

Overview

Power controllers for 3RF2 single-phase solid-state switching devices

The power controller is a function module for the autonomous power control of complex heating systems and inductive loads.

The following functions have been integrated:

- **Power controller** for adjusting the power of the connected load. Here, the setpoint value is set with a rotary knob on the module as a percentage with reference to the 100 % power stored as a setpoint value.
- **Inrush current limitation:** With the aid of an adjustable voltage ramp, the inrush current is limited by means of phase control. This is useful above all with loads such as lamps or infrared lamps which have an inrush transient current.
- **Load circuit monitoring** for detecting load failure, partial load faults, alloyed power semiconductors, lack of voltage or a break in the load circuit.

Special versions: deviations from the standard version

3RF29 04-0KA13-0KC0

During the teaching process the connected solid-state relay or contactor is not activated; i. e. no current flow takes place. No current reference value is stored. No part-load monitoring!

3RF29 ...0KA1.-0KT0

No part-load monitoring!

Application

The power controller can be used for:

- Complex heating systems
- Inductive loads
- Loads with temperature-dependent resistor
- Loads with ageing after long-time service
- Simple indirect control of temperature

The power controller can be used on the instantaneously switching 3RF21 and 3RF23 solid-state switching devices (single-phase). If only the full-wave operating mode is used, the power controller can also be used on the "zero-point switching" solid-state relays and contactors.

Power control

The power controller adjusts the power in the connected load by means of a solid-state switching device depending on the setpoint selection. It does not compensate for changes in the mains voltage or load resistance. The setpoint value can be predefined externally as a 0 to 10 V signal or internally by means of a potentiometer. Depending on the setting of the potentiometer (t_p), the control is carried out according to the principle of full-wave control or generalized phase control.

Full-wave control

In this operating mode the output is adjusted to the required setpoint value changing the on-to-off period. The period duration is predefined at one second.

Generalized phase control

In this operating mode the output is adjusted to the required setpoint value by changing the current flow angle. In order to observe the limit values of the conducted interference voltage for industrial networks, the load circuit must include a reactor with a rating of at least 200 μ H.

Selection and ordering data

Rated operational current I_e	Rated operational voltage U_e	Order No.	Std. Pack Qty	Weight per pack approx.
A	V			kg

Power controllers



Rated control supply voltage 24 V AC/DC				
4	110 ... 230	3RF29 04-0KA13-0KC0	1 unit	0.175
4		3RF29 04-0KA13-0KT0	1 unit	0.175
20		3RF29 20-0KA13	1 unit	0.175
50		3RF29 50-0KA13	1 unit	0.175
90		3RF29 90-0KA13	1 unit	0.175
20	400 ... 600	3RF29 20-0KA16	1 unit	0.175
50		3RF29 50-0KA16	1 unit	0.175
50		3RF29 50-0KA16-0KT0	1 unit	0.175
90		3RF29 90-0KA16	1 unit	0.175

Version	Order No.	Std. Pack Qty	Weight per pack approx.
			kg

Optional accessories



3RF29 00-0RA88

Sealable covers for function modules (not for converters)	3RF29 00-0RA88	10 units	0.001
--	-----------------------	----------	-------

Function Modules

Power control regulators

Overview

Power controllers for SIRIUS SC semiconductor switching devices

This module provides similar functionality to a power control regulator.

The following functions are integrated:

Power control regulator with proportional-action control for adjusting the power of the connected load. Here, the setpoint is set with a rotary knob on the module as a percentage with reference to the 100% power stored as a setpoint. In this way the power is kept constant even in the event of voltage fluctuations or a change in load resistance.

Inrush current limitation: With the aid of an adjustable voltage ramp, the inrush current is limited by means of phase control. This is useful above all with loads such as lamps which have an inrush transient current.

Load circuit monitoring for detecting load failure, alloyed power semiconductors, lack of voltage or a break in the load circuit.

Area of application

The power controller adjusts the current in the connected load by means of a semiconductor switching device depending on a setpoint. This compensates for changes in the mains voltage or in the load resistance. The setpoint can be predefined externally as a 0 to 10 V signal or internally by means of a potentiometer. Depending on the setting of the potentiometer (t_R), the adjustment is carried out according to the principle of full-wave control or generalized phase control.

Full-wave control

In this operating mode the output is adjusted to the required setpoint by changing the on-to-off period. The period duration is predefined at one second.

Generalized phase control

In this operating mode the output is adjusted to the required setpoint by changing the current flow angle. In order to observe the limit values of the conducted interference voltage for industrial power systems, a choke rated at at least 200 μ H must be included in the load circuit.

Design

Mounting

Easy snapping onto the 3RF21 semiconductor relays or 3RF23 semiconductor contactors establishes the connections to the semiconductor switching devices. Because of the special design, the straight-through transformer of the power controller module covers the lower main power connection. The cable to the load is simply pushed through and secured with the terminal screw.

Selection and ordering data

Rated operational current I_e	Rated operational voltage U_e	Rated control supply voltage U_s AC 110 V	Rated control supply voltage U_s AC/DC 24 V	Std. Pack Qty	Weight per pack approx.
A	V	Order No.	Order No.		kg
Power controllers¹⁾					
20	110 ... 230	3RF29 20-0HA33	3RF29 20-0HA13	1 unit	0.120
20	400 ... 600	3RF29 20-0HA36	3RF29 20-0HA16	1 unit	0.120
50	110 ... 230	3RF29 50-0HA33	3RF29 50-0HA13	1 unit	0.120
50	400 ... 600	3RF29 50-0HA36	3RF29 50-0HA16	1 unit	0.120
90	110 ... 230	3RF29 90-0HA33	3RF29 90-0HA13	1 unit	0.120
90	400 ... 600	3RF29 90-0HA36	3RF29 90-0HA16	1 unit	0.120

1) Optional sealable cover - 3RF29 00-ORA88 can be used.

Functions

Start-up

Pressing the "Teach" button switches the device on; the current through the semiconductor switching device and the mains voltage are detected and stored. The resultant output is taken as the 100% output for the setpoint selection. During this process the two lower red LEDs flash alternately. Simultaneous maintained light from the three red LEDs indicates the completion of the "Teach" process.

The "Teach" button can also be used to switch on the connected semiconductor switching device briefly for test purposes. In this case the "ON" LED is switched on.

Setpoint selection

The setting on the setpoint potentiometer (P) determines how the setpoint selection is to be made:

External setpoint selection

At 0 % the setpoint selection is set via an external 0 – 10 V analog signal (terminals IN / 0 – 10 V). The device is switched on and off via the power supply (terminals A1 / A2).

Internal setpoint selection

Above 0 % the setpoint is set using the potentiometer. To allow this, the potential at terminal A1 must additionally be applied at the IN terminal. After removal of the "ON" signal, the switching module is switched off.

Inrush current limitation

The ramp time (t_R) for a voltage ramp on switching on is set with the potentiometer for the purpose of inrush current limitation. If a time longer than 0 s is set, the device operates according to the phase-angle principle. If 0 s is set, there is no voltage ramp and the device operates according to the principle of full-wave control.

Load fault

If upon switching on with voltage applied the current flowing is not greater than the residual current of the switching device, the device triggers a load fault. The fault relay is activated and the "Load" LED lights up.

Thyristor fault

If a current greater than the residual current of the switching device is measured in the deenergized state, the device triggers a thyristor fault. The fault relay is activated and the "Thyristor" LED lights up.

Supply fault

If no current is measured in the energized state, the device triggers a supply fault. The fault relay is activated and the "Supply" LED lights up.

Overview**Power control regulators for SIRIUS solid-state switching devices**

The power control regulator is a function module for the autonomous power control regulation of complex heating systems and inductive loads, for the operation of loads with temperature-dependent resistors or long-term aging, and for simple indirect temperature control.

The power control regulator can be used on the 3RF21 and 3RF23 instantaneous switching solid-state switching devices (single-phase). If only the full-wave control mode is used, the power control regulator can also be used on the zero-point-switching solid-state relays and contactors.

Application

The power control regulator sets the load current of the solid-state switching device depending on a setpoint value as a percentage. Changes in the mains voltage or in the load resistance are not compensated in this case. The modulation, the On/off ratio or the phase angle, remains unchanged in accordance with the setpoint. The autonomous power control regulation is performed between 0 and 100 % of the setpoint value

Full-wave control

If the left potentiometer t_R is set to 0 s (= far left), the power control regulator works according to the principle of full-wave control. The power set, be it internal or external, is converted into a pulse-width-modulated digital signal. The power control regulator controls the On and Off time of the solid-state switching device within a fixed period duration of 1 s so that the specified power is applied to the load. The "ON" LED flashes in the same rhythm as the solid-state switching device switches on and off.

Generalized phase control

If the left potentiometer t_R is set to higher than 0 s, the power control regulator works according to the principle of generalized phase control. With generalized phase control, a choke rated at at least 200 μH must be included in the load circuit in order to observe the limit values of the conducted interference voltage for industrial networks.

Design**Mounting**

Easy snapping onto the 3RF21 solid-state relays or 3RF23 solid-state contactors establishes the connections to the solid-state switching devices. Because of the special design, the straight-through transformer of the function module covers the lower main power connection. The cable to the load is simply pushed through and secured with the terminal screw.

Function**Setpoint selection**

The setpoint is selected either internally using the right-hand potentiometer P with 0 ... 100 % on the module or externally through the analog input 0 ... 10 V.

100 % corresponds in full-wave control to permanently On and in generalized phase control to a conduction angle of 180° and hence maximum power.

When the setpoint is selected internally the module is controlled through the IN terminal. The terminal 10 then has no function.

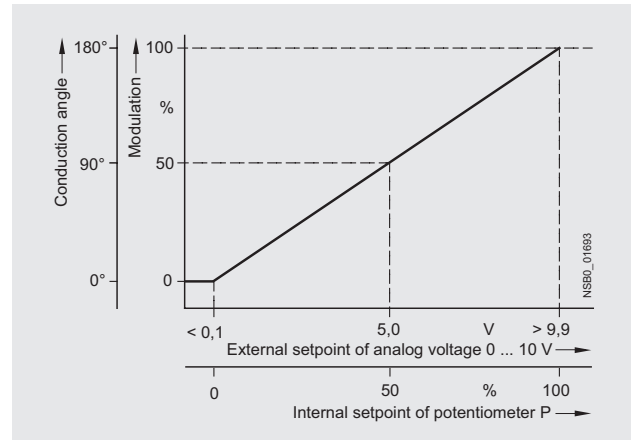

Input characteristic curve

When the setpoint is selected externally (potentiometer P set far left = 0 %) the module is controlled by applying the analog voltage 0 ... 10 V. 0 ... 10 V corresponds to 0 ... 100 % power. Conversion of the voltage is linear between 0.1 and 9.9 V. Below 0.1 V the switching device remains off; at voltages above 9.9 V the power is always set to 100 %.

Inrush current limitation

The ramp time (t_R) for a voltage ramp on switching on is set with the left potentiometer for the purpose of inrush current limitation. The set time refers to a power of 100 %. If, for example, a ramp time of 10 s is set and the selected power is 60 %, then a power of 60 % is reached after approx. 6 s.

Line and thyristor monitoring

The power control regulator recognizes supply failures and thyristor faults. The faults are indicated by the LEDs on the module and the fault output is activated.

Solid-State Relays

3RF21 Solid-state relays – technical data

Overview

22.5 mm semiconductor relays

With its compact design, which stays the same even at currents of up to 88 A, the 3RF21 semiconductor relay is the ultimate in space-saving construction, at a width of 22.5 mm. The logical connection arrangement, with the power infeed from above and connection of the load from below, ensures clean installation in the control cabinet.

Technical specifications

Type		3RF21 ..-1....	3RF21 ..-2....	3RF21 ..-3....
General data				
Ambient temperature				
during operation, derating from 40 °C	°C	-25 ... +60		
when stored	°C	-55 ... +80		
Site altitude	m	0 ... 1000; derating from 1000		
Shock resistance acc. to IEC 60068-2-27	g/ms	15/11		
Vibration resistance acc. to IEC 60068-2-6	g	2		
Degree of protection		IP20		
Electromagnetic compatibility (EMC)				
Emitted interference				
• Conducted interference voltage acc. to IEC 60947-4-3				
Class A for industrial applications				
• Emitted, high-frequency interference voltage acc. to IEC 60947-4-3				
Class A for industrial applications				
Noise immunity				
• Electrostatic discharge acc. to IEC 61000-4-2 (corresponds to degree of severity 3)				
kV Contact discharge 4; air discharge 8; behavior criterion 2				
• Induced RF fields acc. to IEC 61000-4-6				
MHz 0.15 ... 80; 140 dBµV; behavior criterion 1				
• Burst acc. to IEC 61000-4-4				
kV 2/5.0 kHz; behavior criterion 1				
• Surge acc. to IEC 61000-4-5				
kV Conductor - ground 2; conductor - conductor 1; behavior criterion 2				
Connection technique				
		Screw-type connection	Spring-loaded connection	Ring cable connection
Main contact connection				
Conductor cross-section				
Solid				
mm ²		2 x (1.5 ... 2.5), 2 x (2.5 ... 6)		2 x (0.5 ... 2.5)
mm ²		2 x (1.5 ... 2.5), 2 x (2.5 ... 6), 1 x 10		2 x (0.5 ... 1.5)
Finely stranded with end sleeve				
mm ²		2 x (1.5 ... 2.5), 2 x (2.5 ... 6), 1 x 10		-
Finely stranded without end sleeves				
mm ²		2 x (14 ... 10)		2 x (0.5 ... 2.5)
AWG		2 x (14 ... 10)		-
mm		10		-
mm		10		-
Terminal screw		M 4		M 5
• Tightening torque		Nm 2 ... 2.5		2 ... 2.5
lb.in		18 ... 22		18 ... 22
Cable lug				
• DIN				
-		-		DIN 46234
-		-		-5-2.5, -5-6, -5-10, -5-16, -5-25
• JIS		-		JIS C 2805 R 2-5, 5.5-5, 8-5, 14-5
Auxiliary/control contact connections				
Conductor cross-section				
mm ²		1x (0.5 ... 2.5); 2x (0.5 ... 1)		1x (0.5 ... 2.5); 2x (0.5 ... 1)
AWG		20 ... 12		20 ... 12
mm		7		7
mm		7		7
Terminal screw		M 3		M 3
• Tightening torque		Nm 0.5 ... 0.6		0.5 ... 0.6
lb.in		4.5 ... 5.3		4.5 ... 5.3
Main circuit				
Rated operational voltage U_e				
V		24 ... 230		230 ... 460
• Tolerance		%		48 ... 600
• Rated frequency		Hz		400 ... 600
Hz		50/60		
Rated insulation voltage U_i				
V		600		
Blocking voltage				
V		800		1200
V		1200		1600
Rate of voltage rise				
V/µs		1000		

Solid-State Relays

3RF21 Solid-state – technical data

Order No.	$I_{\max}^{1)}$ at $R_{\text{thha}}/T_U = 40\text{ °C}$		I_e acc. to IEC 60947-4-3 at $R_{\text{thha}}/T_U = 40\text{ °C}$		I_e acc. to UL/CSA at $R_{\text{thha}}/T_U = 50\text{ °C}$		Power loss at I_{\max} W	Minimum load current A	Leakage current mA
	A	K/W	A	K/W	A	K/W			
Main circuit									
3RF21 20-....	20	2.0	20	1.7	20	1.3	28.6	0.1	10
3RF21 30-1....	30	1.1	30	0.79	30	0.56	44.2	0.5	10
3RF21 50-1....	50	0.68	50	0.48	50	0.33	66	0.5	10
3RF21 50-2....	50	0.68	20	2.6	20	2.9	66	0.5	10
3RF21 50-3....	50	0.68	50	0.48	50	0.33	66	0.5	10
3RF21 70-1....	70	0.40	50	0.77	50	0.6	94	0.5	10
3RF21 90-1....	88	0.33	50	0.94	50	0.85	118	0.5	10
3RF21 90-2....	88	0.33	20	2.8	20	3.5	118	0.5	10
3RF21 90-3....	88	0.33	88	0.22	83	0.19	118	0.5	10

¹⁾ I_{\max} provides information about the performance of the solid-state relay. The actual permitted rated operational current I_e can be smaller depending on the connection method and cooling conditions.

Note: The required heat sinks for the corresponding load currents can be determined from the characteristic curves, page 4/10. The minimum thickness values for the mounting surface must be observed.

Order No.	Rated impulse withstand capacity I_{tsm}	I^2t value
	A	A ² s
Main circuit		
3RF21 20-....	200	200
3RF21 30-..A.2	300	450
3RF21 30-..A.4	300	450
3RF21 30-..A.5	300	450
3RF21 30-..A.6	400	800
3RF21 50-....	600	1800
3RF21 70-..A.2	1200	7200
3RF21 70-..A.4	1200	7200
3RF21 70-..A.5	1200	7200
3RF21 70-..A.6	1150	6600
3RF21 90-....	1150	6600

Type		3RF21 ...-...2	3RF21 ...-...4	3RF21 ...-...5	3RF21 ...-...6
Main circuit					
Rated operational voltage U_e	V	24 ... 230	48 ... 460	48 ... 600	48 ... 600
• Operating range	V	20 ... 253	40 ... 506	40 ... 660	40 ... 660
• Rated frequency	Hz	50/60 ± 10 %			
Rated insulation voltage U_i	V	600			
Blocking voltage	V	800	1200		1600
Rate of voltage rise	V/μs	1000			

Type		3RF21 ...-...0.	3RF21 ...-...1.	3RF21 ...-...2.	3RF21 ...-...4.
Control circuit					
Method of operation		DC operation	AC/DC operation	AC operation	DC operation
Rated control supply voltage U_s	V	24 acc. to EN 61131-2	24 AC	24 DC	110 ... 230
Rated frequency of the control supply voltage	Hz	--	50/60 ± 10 %	--	50/60 ± 10 %
Control supply voltage, max.	V	30	26.5 AC	30 DC	253
Typical actuating current	mA	20 / Low Power: 6.5 ¹⁾	20	20	15
Response voltage	V	15	14 AC	15 DC	90
Drop-out voltage	V	5	5 AC	5 DC	40
Operating times					
• ON-delay	ms	1 + max. one half-wave ²⁾	10 + max. one half-wave ²⁾	40 + max. one half-wave ²⁾	1 + max. one half-wave ²⁾
• OFF-delay	ms	1 + max. one half-wave	15 + max. one half-wave	40 + max. one half-wave	1 + max. one half-wave

¹⁾ Applies to the version "Low Power" 3RF21 ...-AA...-0KNO.

²⁾ Only for zero-point-switching devices.

Solid-State Relays

3RF21 solid-state relays – technical data

Fused version with semiconductor protection (similar to type of coordination "2")¹⁾

The semiconductor protection for the SIRIUS controls can be used with different protective devices. This allows protection by means of LV HRC fuses of gG operational class or miniature circuit breakers. Siemens recommends the use of special SITOR semiconductor fuses. The table below lists the maximum permissible fuses for each SIRIUS control.

If a fuse is used with a higher rated current than specified, semiconductor protection is no longer guaranteed. However, smaller fuses with a lower rated current for the load can be used without problems.

For protective devices with gG operational class and for SITOR 3NE1 all-range fuses, the minimum cross-sections for the conductor to be connected must be taken into account.

Order No.	All-range fuses		Semiconductor fuses/partial-range fuses			
	LV HRC design gR/SITOR	Cylindrical design gR/NEOZED ²⁾	LV HRC design aR/SITOR	Cylindrical design aR/SITOR	aR/SITOR	aR/SITOR
	3NE1	SILIZED 5SE1	3NE8	10 mm x 38 mm 3NC1 0	14 mm x 51 mm 3NC1 4	22 mm x 58 mm 3NC2 2
3RF21 20-...2 3RF21 20-...4 3RF21 20-...5³⁾	3NE1 814-0 3NE1 813-0 ⁴⁾ 3NE1 813-0 ⁴⁾	5SE1 325 5SE1 320 5SE1 320	3NE8 015-1 3NE8 015-1 3NE8 015-1	3NC1 020 3NC1 016 ⁴⁾ 3NC1 016 ⁴⁾	3NC1 420 3NC1 420 3NC1 420	3NC2 220 3NC2 220 3NC2 220
3RF21 30-...2 3RF21 30-...4 3RF21 30-...5³⁾ 3RF21 30-...6	3NE1 815-0 ⁴⁾ 3NE1 815-0 ⁴⁾ 3NE1 815-0 ⁴⁾ 3NE1 815-0 ⁴⁾	5SE1 335 5SE1 325 ⁴⁾ 5SE1 325 ⁴⁾ --	3NE8 003-1 3NE8 003-1 3NE8 003-1 3NE8 003-1	3NC1 032 3NC1 025 ⁴⁾ 3NC1 025 ⁴⁾ 3NC1 032	3NC1 432 3NC1 430 3NC1 430 3NC1 432	3NC2 232 3NC2 232 3NC2 232 3NC2 232
3RF21 50-...2 3RF21 50-...4 3RF21 50-...5³⁾ 3RF21 50-...6	3NE1 817-0 3NE1 802-0 ⁴⁾ 3NE1 802-0 ⁴⁾ 3NE1 803-0 ⁴⁾	5SE1 350 5SE1 335 ⁴⁾ 5SE1 335 ⁴⁾ --	3NE8 017-1 3NE8 017-1 3NE8 017-1 3NE8 017-1	-- -- -- --	3NC1 450 3NC1 450 3NC1 450 3NC1 450	3NC2 250 3NC2 250 3NC2 250 3NC2 250
3RF21 70-...2⁵⁾ 3RF21 70-...4⁵⁾ 3RF21 70-...5³⁾⁵⁾ 3RF21 70-...6⁵⁾	3NE1 820-0 3NE1 020-2 3NE1 020-2 3NE1 020-2	5SE1 363 ⁴⁾ 5SE1 363 ⁴⁾ -- --	3NE8 020-1 3NE8 020-1 3NE8 020-1 3NE8 020-1	-- -- -- --	-- -- -- --	3NC2 280 3NC2 280 3NC2 280 3NC2 280
3RF21 90-...2⁵⁾ 3RF21 90-...4⁵⁾ 3RF21 90-...5³⁾⁵⁾ 3RF21 90-...6⁵⁾	3NE1 021-2 3NE1 021-2 3NE1 021-2 3NE1 817-0 ⁴⁾	-- -- -- --	3NE8 021-1 3NE8 021-1 3NE8 021-1 3NE8 021-1	-- -- -- --	-- -- -- --	3NC2 200 3NC2 280 ⁴⁾ 3NC2 280 ⁴⁾ 3NC2 280 ⁴⁾

Order No.	Cable and line protection fuses				
	LV HRC design ⁴⁾ gG	Cylindrical design ⁴⁾ gG	gG	gG	DIAZED ⁴⁾ quick
	3NA2	10 mm x 38 mm 3NW6 0	14 mm x 51 mm 3NW6 1	22 mm x 58 mm 3NW6 2	5SB
3RF21 20-...2 3RF21 20-...4 3RF21 20-...5³⁾	3NA2 803 3NA2 801 3NA2 801	3NW6 000-1 -- --	3NW6 101-1 3NW6 101-1 3NW6 101-1	-- -- --	5SB1 41 5SB1 41 5SB1 41
3RF21 30-...2 3RF21 30-...4 3RF21 30-...5³⁾ 3RF21 30-...6	3NA2 803 3NA2 803 3NA2 803 3NA2 803-6	-- -- -- --	3NW6 103-1 3NW6 101-1 3NW6 101-1 --	-- -- -- --	5SB1 71 5SB1 71 5SB1 71 --
3RF21 50-...2 3RF21 50-...4 3RF21 50-...5³⁾ 3RF21 50-...6	3NA2 810 3NA2 807 3NA2 807 3NA2 807-6	-- -- -- --	3NW6 107-1 -- -- --	3NW6 207-1 3NW6 205-1 3NW6 205-1 --	5SB3 11 5SB3 11 5SB3 11 --
3RF21 70-...2⁵⁾ 3RF21 70-...4⁵⁾ 3RF21 70-...5³⁾⁵⁾ 3RF21 70-...6⁵⁾	3NA2 817 3NA2 812 3NA2 812 3NA2 812-6	-- -- -- --	-- -- -- --	3NW6 217-1 3NW6 212-1 3NW6 212-1 --	5SB3 31 5SB3 31 -- --
3RF21 90-...2⁵⁾ 3RF21 90-...4⁵⁾ 3RF21 90-...5³⁾⁵⁾ 3RF21 90-...6⁵⁾	3NA2 817 3NA2 812 3NA2 812 3NA2 812-6	-- -- -- --	-- -- -- --	3NW6 217-1 3NW6 212-1 3NW6 212-1 --	-- -- -- --

Suitable fuse holders, fuse bases and controls can be found in Catalog LV 1, Chapter 19.

- 1) Type of coordination "2" according to EN 60947-4-1:
In the event of a short-circuit, the controls in the load feeder must not endanger persons or the installation. They must be suitable for further operation. For fused configurations, the protective device must be replaced.
- 2) For use only with operational voltage U_o up to 400 V.
- 3) For use only with operational voltage U_o up to 506 V.
- 4) These fuses have a smaller rated current than the solid-state relays.
- 5) These versions can also be protected against short-circuits with miniature circuit breakers as described in the notes on "SIRIUS Solid-State Contactors → Special Version Short-Circuit Resistant".

Solid-State Relays

3RF20 Solid-state relays – technical data

Overview

45 mm semiconductor relays

The semiconductor relays with a width of 45 mm provide for connection of the power supply lead and the load from above. This makes it easy to retrofit existing semiconductor relays. The connection of the control cable also saves space in much the same way as the 22.5 mm design, as it is simply plugged on.

Technical specifications

Type	3RF20		
General data			
Ambient temperature			
during operation, derating at 40 °C	°C	-25 ... +60	
when stored	°C	-55 ... +80	
Site altitude	m	0 ... 1000; derating from 1000	
Shock resistance	g/ms	15/11	
acc. to IEC 60068-2-27			
Vibration resistance	g	2	
acc. to IEC 60068-2-6			
Degree of protection		IP20	
Electromagnetic compatibility (EMC)			
Emitted interference			
• Conducted interference voltage IEC acc. to 60947-4-3			
Class A for industrial applications			
• Emitted, high-frequency interference voltage acc. to IEC 60947-4-3			
Class A for industrial applications			
Noise immunity			
• Electrostatic discharge acc. to IEC 61000-4-2 (corresponds to degree of severity 3)			
	kV	Contact discharge 4; air discharge 8; behavior criterion 2	
• Induced RF fields acc. to IEC 61000-4-6			
	MHz	0.15 ... 80; 140 dBµV; behavior criterion 1	
• Burst acc. to IEC 61000-4-4			
	kV	2/5.0 kHz; behavior criterion 1	
• Surge acc. to IEC 61000-4-5			
	kV	Conductor - ground 2; conductor - conductor 1; behavior criterion 2	
Connection, main contacts, screw connection			
Conductor cross-section			
Solid	mm ²	2 x (1.5 ... 2.5); 2 x (2.5 ... 6)	
Finely stranded with end sleeve	mm ²	2 x (1.5 ... 2.5); 2 x (2.5 ... 6); 1 x 10	
Solid or stranded AWG conductors	AWG	2 x (14 ... 10)	
Insulation stripping length	mm	10	
Terminal screw		M 4	
• Tightening torque			
	Nm	2 ... 2.5	
	lb.in	18 ... 22	
Connection, auxiliary/control contacts, screw connection			
Conductor cross-section			
	mm ²	1x (0.5 ... 2.5); 2x (0.5 ... 1.0); AWG 20 ... 12	
Insulation stripping length	mm	7	
Terminal screw		M 3	
• Tightening torque			
	Nm	0.5 ... 0.6	
	lb.in	4.5 ... 5.3	

Type	3RF20 .0-1AA.2	3RF20 .0-1AA.4	3RF20..-.....5	3RF20 .0-1AA.6
Main circuit				
Rated operational voltage U_e	V	24 ... 230	230 ... 460	48 ... 600
• Tolerance				
	%	-15/+10		
• Rated frequency				
	Hz	50/60		
Rated insulation voltage U_i	V	600		
Blocking voltage	V	800	1200	1200
Rate of voltage rise	V/µs	1000		

Solid-State Relays

3RF20 Solid-state relays – technical data

Order No.	$I_{max}^{1)}$ at $R_{thha}/T_u = 40\text{ °C}$		I_e to IEC 60947-4-3 at $R_{thha}/T_u = 40\text{ °C}$		I_e to UL/CSA at $R_{thha}/T_u = 50\text{ °C}$		Power loss for I_{max}	Minimum load current	Leakage current
	A	K/W	A	K/W	A	K/W			
Main circuit									
3RF20 20-1AA..	20	2.0	20	2.0	20	1.7	28.6	0.5	10
3RF20 30-1AA..	30	1.1	30	1.1	30	0.88	44.2	0.5	10
3RF20 50-1AA..	50	0.68	50	0.68	50	0.53	66	0.5	10
3RF20 70-1AA..	70	0.4	50	0.95	50	0.8	94	0.5	10
3RF20 90-1AA..	88	0.33	50	1.25	50	1.02	118	0.5	10

1) I_{max} provides information about the performance of the semiconductor relay. The actual permitted operational current I_e can be smaller depending on the connection method and cooling conditions.

Order No.	Rated impulse withstand capacity I_{sm}	βt value
Main circuit		
3RF20 20-1AA..	200	200
3RF20 30-1AA.2	300	450
3RF20 30-1AA.4	300	450
3RF20 30-1AA.6	400	800
3RF20 50-1AA..	600	1800
3RF20 70-1AA.2	1200	7200
3RF20 70-1AA.4	1200	7200
3RF20 70-1AA.6	1150	6600
3RF20 90-1AA..	1150	6600

Type		3RF20 .0-1AA0.	3RF20 .0-1AA4.	3RF20 .0-1AA2.
Control circuit				
Method of operation		DC operation	DC operation	AC operation
Rated control supply voltage U_s	V	24 acc. to EN 61131-2	4 ... 30V DC	110 ... 230
Max. rated control voltage	V	30	30	253
Rated control current at U_s	mA	15	15	6
Rated frequency of the control supply voltage	Hz	-	-	50/60
Response voltage current	V mA	15 >2	4 >2	90 2
Drop-out voltage	V	5	1	40
Operating times				
closing time	ms	1 + max. one half wave	1 + max. one half wave	40 + max. one half wave
opening time	ms	1 + max. one half wave	1 + max. one half wave	40 + max. one half wave

Fused design with semiconductor protection

Order No.	All-range fuse LV design gR/SITOR 3NE1	Semiconductor protection fuse Cylindrical design			Cable and line protection fuse			DIAZED quick 5SB
		10 x 38 mm aR/SITOR 3NC1 0	14 x 51 mm aR/SITOR 3NC1 4	22 x 58 mm aR/SITOR 3NC2 2	LV design gL/gG/3NA	Cylindrical design		
					10 x 38 mm gL/gG 3NW	14 x 51 mm gL/gG 3NW	22 x 58 mm gL/gG 3NW	
3RF20 20-1AA.2	3NE1 814-0	3NC1 020	3NC1 420	3NC2 220	3NA2 803	3NW6 001-1	3NW6 101-1	5SB1 71
3RF20 20-1AA.4	3NE1 813-0	3NC1 016	3NC1 420	3NC2 220	3NA2 801	-	3NW6 101-1	5SB1 41
3RF20 30-1AA.2	3NE1 815-0	3NC1 032	3NC1 432	3NC2 232	3NA2 803	-	3NW6 103-1	5SB3 11
3RF20 30-1AA.4	3NE1 815-0	3NC1 025	3NC1 432	3NC2 232	3NA2 803	-	3NW6 101-1	5SB1 71
3RF20 30-1AA.6	3NE1 815-0	3NC1 032	3NC1 432	3NC2 232	3NA2 803-6	-	-	-
3RF20 50-1AA.2	3NE1 817-0	-	3NC1 450	3NC2 250	3NA2 810	-	3NW6 107-1	5SB3 21
3RF20 50-1AA.4	3NE1 802-0	-	3NC1 450	3NC2 250	3NA2 807	-	3NW6 205-1	5SB3 11
3RF20 50-1AA.6	3NE1 803-0	-	3NC1 450	3NC2 250	3NA2 807-6	-	-	-
3RF20 70-1AA.2 ²⁾	3NE1 820-0	-	-	3NC2 280	3NA2 817	-	-	5SB3 31
3RF20 70-1AA.4 ²⁾	3NE1 020-2	-	-	3NC2 280	3NA2 812	-	3NW6 212-1	5SB3 21
3RF20 70-1AA.6 ²⁾	3NE1 020-2	-	-	3NC2 280	3NA2 812-6	-	-	-
3RF20 90-1AA.2 ²⁾	3NE1 021-2	-	-	3NC2 200	3NA2 817	-	3NW6 217-1	5SB3 31
3RF20 90-1AA.4 ²⁾	3NE1 021-2	-	-	3NC2 280	3NA2 812	-	3NW6 212-1	5SB3 21
3RF20 90-1AA.6 ²⁾	3NE1 020-2	-	-	3NC2 280	3NA2 812-6	-	-	-

1) Type of coordination "2" acc. to EN 60947-4-1:
In the event of a short-circuit, the control gear in the load feeder must not endanger persons or the installation. They must be suitable for further operation. For fused configurations, the protective device must be replaced.

2) These versions can also be protected against short-circuit with miniature circuit-breakers as described on page 7/11.

Solid-State Relays

3RF22 Solid-state relays – technical data

Overview

45 mm solid-state relays

The 3RF22 solid-state relays with a width of 45 mm provide space advantages over solutions with single-phase versions. The logical connection arrangement, with the power infeed from above and connection of the load from below, ensures tidy installation in the control cabinet.

Important features:

- LED indicators
- Variety of connection techniques
- Plug-in control connection
- Degree of protection IP20
- Zero-point switching,
- Two or three-phase controlled

Technical specifications

Type	3RF22 ..-1....	3RF22 ..-2....	3RF22 ..-3....
General data			
Ambient temperature			
• During operation, derating from 40 °C	°C	-25 ... +60	
• During storage	°C	-55 ... +80	
Site altitude	m	0 ... 1000; > 1000 ask Technical Assistance	
Shock resistance acc. to IEC 60068-2-27	g/rms	15/11	
Vibration resistance acc. to IEC 60068-2-6	g	2	
Degree of protection	IP20		
Insulation strength at 50/60 Hz (main/control circuit to ground)	V rms	4000	
Electromagnetic compatibility (EMC)			
• Emitted interference			
- Conducted interference voltage acc. to IEC 60947-4-3	Class A for industrial applications ¹⁾		
- Emitted, high-frequency interference voltage acc. to IEC 60947-4-3	Class A for industrial applications		
• Interference immunity			
- Electrostatic discharge acc. to IEC 61000-4-2 (corresponds to degree of severity 3)	kV	Contact discharge 4; air discharge 8; behavior criterion 2	
- Induced RF fields acc. to IEC 61000-4-6	MHz	0.15 ... 80; 140 dBµV; behavior criterion 1	
- Burst acc. to IEC 61000-4-4	kV	2/5.0 kHz; behavior criterion 1	
- Surge acc. to IEC 61000-4-5	kV	Conductor – ground 2; conductor – conductor 1; behavior criterion 2	
Connection technique	Screw terminal	Spring-loaded connection	Ring terminal end connection
Main contact connection			
• Conductor cross-section			
- Solid	mm ²	2 x (1.5 ... 2.5), 2 x (2.5 ... 6)	2 x (0.5 ... 2.5)
- Finely stranded with end sleeve	mm ²	2 x (1 ... 2.5), 2 x (2.5 ... 6), 1 x 10	2 x (0.5 ... 1.5)
- Finely stranded without end sleeve	mm ²	--	2 x (0.5 ... 2.5)
- Solid or stranded, AWG conductors		2 x (AWG 14 ... 10)	2 x (AWG 18 ... 14)
• Stripped length	mm	10	10
• Terminal screw		M4	--
- Tightening torque, Ø 5 ... 6 mm, PZ 2	Nm	2 ... 2.5	M5
	lb.in	18 ... 22	2.5 ... 2
			18 ... 22
• Cable lug		--	--
- acc. to DIN 46234			5-2.5 ... 5-25
- acc. to JIS C 2805			R 2-5 ... 14-5
Connection, auxiliary/control contacts			
• Conductor cross-section, with or without end sleeve	mm	1 x (0.5 ... 2.5), 2 x (0.5 ... 1.0)	1 x (0.5 ... 2.5), 2 x (0.5 ... 1.0)
	AWG	20 ... 12	20 ... 12
• Stripped length	mm	7	7
• Terminal screw		M3	M3
- Tightening torque, Ø 3.5, PZ 1	Nm	0.5 ... 0.6	0.5 ... 0.6
	lb.in	4.5 ... 5.3	4.5 ... 5.3

1) These products were built as Class A devices. The use of these devices in residential areas could result in radio interference. In this case they may be required to introduce additional damping measures.

Solid-State Relays

3RF22 Solid-state relays – technical data

Type	3RF22 ...-AB.5		3RF22 ...-AC.5	
Main circuit				
Controlled phases	Two-phase		Three-phase	
Rated operational voltage U_e	V	48 ... 600	48 ... 600	
• Operating range	V	40 ... 660	40 ... 660	
• Rated frequency	Hz	50/60 ± 10 %	50/60 ± 10 %	
Rated insulation voltage U_i	V	600	600	
Rated impulse withstand voltage U_{imp}	kV	6	6	
Blocking voltage	V	1200	1200	
Rate of voltage rise	V/μs	1.000	1.000	

Order No.	$I_{max}^{1)}$ at $R_{thha}/T_u = 40\text{ °C}$		I_e acc. to IEC 60947-4-3 at $R_{thha}/T_u = 40\text{ °C}$		I_e acc. to UL/CSA at $R_{thha}/T_u = 50\text{ °C}$		Power loss at I_{max} W	Minimum load current A	Max. leakage current mA
	A	K/W	A	K/W	A	K/W			
Main circuit									
3RF22 30-. AB..	30	0.57	30	0.57	30	0.44	81	0.5	10
3RF22 55-1AB..	55	0.18	50	0.27	50	0.19	151	0.5	10
3RF22 55-2AB..			20	1.83	20	1.58			
3RF22 55-3AB..			50	0.27	50	0.19			
3RF22 30-. AC..	30	0.33	30	0.33	30	0.25	122	0.5	10
3RF22 55-1AC..	55	0.09	50	0.15	50	0.1	226	0.5	10
3RF22 55-2AC..			20	1.19	20	1.02			
3RF22 55-3AC..			88	0.15	83	0.1			

1) I_{max} provides information about the performance of the solid-state relay.
The actual permitted rated operational current I_e can be smaller depending on the connection method and cooling conditions.

Order No.	Rated impulse withstand capacity I_{tsm}		I^2t value A ² s
	A		
Main circuit			
3RF22 30-....5	300		450
3RF22 55-....5	600		1800

Type	3RF22 ...-AB4. / 3RF22 ...-AC4.	
Control circuit		
Method of operation	DC operation	
Rated control supply voltage U_c	V	4 ... 30
Response voltage	V	15
• For tripping current	mA	2
Drop-out voltage	V	1
Operating times		
• ON-delay	ms	1 + max. one half-wave
• OFF delay	ms	1 + max. one half-wave

Solid-State Contactors

3RF23 Solid-state contactors- technical data

Technical specifications

Order No.	3RF23 ..-A...	3RF23 ..-B...	3RF23 ..-C...	3RF23 ..-D...
General data				
Ambient temperature				
during operation, derating at 40 °C	°C	-25 ... +60		
when stored	°C	-55 ... +80		
Site altitude	m	0 ... 1000; derating from 1000		
Shock resistance acc. to IEC 60068-2-27	g/ms	15/11		
Vibration resistance acc. to IEC 60068-2-6	g	2		
Degree of protection		IP20		
Electromagnetic compatibility (EMC)				
Emitted interference acc. to IEC 60947-4-3				
<ul style="list-style-type: none"> Conducted interference voltage Emitted high-frequency interference voltage 		Class A for industrial applications	Class A for industrial applications; Class B for residential/business/commercial areas up to 16 A, AC51 Low Noise	Class A for industrial applications
Noise immunity				
<ul style="list-style-type: none"> Electrostatic discharge acc. to IEC 61000-4-2 (corresponds to degree of severity 3) Induced RF fields acc. to IEC 61000-4-6 Burst acc. to IEC 61000-4-4 Surge acc. to IEC 61000-4-5 		kV	Contact discharge 4; air discharge 8; behavior criterion 2	
		MHz	0.15 ... 80; 140 dBµV; behavior criterion 1	
		kV	2/5.0 kHz; behavior criterion 1	
		kV	Conductor - ground 2; conductor - conductor 1; behavior criterion 2	

Order No.	3RF23 ..-1...	3RF23 ..-2...	3RF23 ..-3...
General data			
Connection technique			
Main contact connection			
Conductor cross-section			
Solid	mm ²	2 x (1.5 ... 2.5); 2 x (2.5 ... 6)	2 x (0.5 ... 2.5)
Finely stranded with end sleeve	mm ²	2 x (1.5 ... 2.5); 2 x (2.5 ... 6), 1 x 10	2 x (0.5 ... 1.5)
Finely stranded without end sleeves	mm ²	-	2 x (0.5 ... 2.5)
Solid or stranded AWG conductors	AWG	2 x (14 ... 10)	2 x (18 ... 14)
Insulation stripping length	mm	10	10
Terminal screw		M 4	M 5
• Tightening torque	Nm	2 ... 2.5	2 ... 2.5
• Tightening torque	lb.in	18 ... 22	18 ... 22
Cable lug		-	-
• DIN		-	DIN 46234
• JIS		-	-5-2.5, -5-6, -5-10, -5-16, -5-25 JIS C 2805 R 2-5, 5.5-5, 8-5, 14-5
Auxiliary/control contact connections			
Conductor cross-section			
	mm ²	1x (0.5 ... 2.5); 2x (0.5 ... 1.0)	1x (0.5 ... 2.5); 2x (0.5 ... 1.0)
	AWG	20 ... 12	20 ... 12
Insulation stripping length	mm	7	7
Terminal screw		M 3	M 3
• Tightening torque	Nm	0.5 ... 0.6	0.5 ... 0.6
	lb.in	4.5 ... 5.3	4.5 ... 5.3

Type	3RF23 ..-...2	3RF23 ..-...4	3RF21 ..-...5	3RF23 ..-...6
Main circuit				
Rated operational voltage U_e	V	24 ... 230	230 ... 460	48 ... 600
• Tolerance	%	-15/+10		
• Rated frequency	Hz	50/60 Hz		
Rated insulation voltage U_i	V	600		
Blocking voltage	V	800	1200	1200
Rate of voltage rise	V/µs	1000		

Type	3RF23 ..-...0.	3RF23 ..-...2.
Control circuit		
Method of operation		
		DC operation
		AC operation
Rated control supply voltage U_s	V	24 to EN 61131-2
Max. rated control voltage	V	30
Rated control current at U_s	mA	15
Rated frequency of the control supply voltage	Hz	50/60
Response voltage	V	15
for tripping current	mA	2
Drop-out voltage	V	5
Operating times		
closing time	ms	1 + max. one half-wave
opening time	ms	1 + max. one half-wave

Solid-State Contactors

3RF23 Solid-state contactors – technical data

Technical specifications

Order No.	Type current AC-51 ¹⁾			Power loss at I_{max}	Minimum load current	Leakage current	Rated impulse withstand capacity I_{tsm}	βt value
	I_{max} at 40 °C	acc. to IEC 60947-4-3 at 40 °C	UL/CSA at 50 °C					
	A	A	A	W	A	mA	A	A ² s
Main circuit								
3RF23 1.-.A..2 3RF23 1.-.A..4 3RF23 1.-.A.45 3RF23 1.-.A..6	10.5	7.5	9.6	11	0.5	10	200 200 400	200 200 800
3RF23 2.-.A..2 3RF23 2.-.C..2 3RF23 2.-.D..2 3RF23 2.-.A..4 3RF23 2.-.C..4 3RF23 2.-.D..4 3RF23 2.-.A.45 3RF23 2.-.A..6	20	13.2	17.6	20	0.5	10 25 10 10 25 10	600 600 1150 600 600 1150	1800 1800 6600 1800 1800 6600
3RF23 3.-.A..2 3RF23 3.-.A..4 3RF23 3.-.A.45 3RF23 3.-.A..6	30	22	27	33	0.5	10	600	1800
3RF23 4.-.A..2 3RF23 4.-.A..4 3RF23 4.-.A.45 3RF23 4.-.A..6	40	33	36	44	0.5	10	1200 1200 1150	7200 7200 6600
3RF23 5.-.A..2 3RF23 5.-.A..4 3RF23 5.-.A.45 3RF23 5.-.A..6	50	36	45	54	0.5	10	1150	6600
3RF23 7.-.A..2 3RF23 7.-.A..4 3RF23 7.-.A.45 3RF23 7.-.A..6	70	70	62	83	0.5	10	1150	6600
3RF23 9.-.A..2 3RF23 9.-.A..4 3RF23 9.-.A.45 3RF23 9.-.A..6	88	88	80	117	0.5	10	1150	6600

Order No.	Type current AC-51 ¹⁾			AC-15 Parameters		Power loss at I_{max}	Minimum load current	Leakage current	Rated impulse withstand capacity I_{tsm}	βt value
	I_{max} at 40 °C	acc. to IEC 60947-4-3 at 40 °C	UL/CSA at 50 °C	A						
	A	A	A	A		W	A	mA	A	A ² s
Main circuit										
3RF23 1.-.B..2 3RF23 1.-.B..4 3RF23 1.-.B..6	10.5	7.5	9.6	6	1200 1/h 50 % ED	11	0.5	10	200 200 400	200 200 800
3RF23 2.-.B..2 3RF23 2.-.B..4 3RF23 2.-.B..6	20	13.2	17.6	12	1200 1/h 50 % ED	20	0.5	10	600	1800
3RF23 3.-.B..2 3RF23 3.-.B..4 3RF23 3.-.B..6	30	22	27	15	1200 1/h 50 % ED	33	0.5	10	600	1800
3RF23 4.-.B..2 3RF23 4.-.B..4 3RF23 4.-.B..6	40	33	36	20	1200 1/h 50 % ED	44	0.5	10	1200 1200 1150	7200 7200 6600
3RF23 5.-.B..2 3RF23 5.-.B..4 3RF23 5.-.B..6	50	36	45	25	1200 1/h 50 % ED	54	0.5	10	1150	6600
3RF23 7.-.B..2 3RF23 7.-.B..4 3RF23 7.-.B..6	70	70	62	27.5	1200 1/h 50 % ED	83	0.5	10	1150	6600
3RF23 9.-.B..2 3RF23 9.-.B..4 3RF23 9.-.B..6	88	88	80	30	1200 1/h 50 % ED	117	0.5	10	1150	6600

1) The type current provides information about the performance of the semi-conductor contactor. The actual permitted operational current I_b can be smaller depending on the connection method and start-up conditions. Derating acc. to curves from page 7/34, 7/35, 7/36.

Solid-State Contactors

3RF23 Solid-state contactors – technical data

Fused design with semiconductor protection (similar to type of coordination "2")¹⁾

The semiconductor protection for the SIRIUS SC controlgear can be used with different protective devices. This allows protection by means of LV HRC fuses of operational class gL/gG or supplementary protectors. Siemens recommends the use of special SITOR semiconductor fuses. The table below lists the maximum permissible fuses for each SIRIUS SC control gear.

If a fuse is used with a higher rated current than specified, semiconductor protection is no longer guaranteed. However, smaller fuses with a lower rated current for the load can be used without problems.

For protective devices with operational class gL/gG and for SITOR full range fuses 3NE1, the minimum cross-sections for the conductor to be connected must be taken into account.

Order No.	All-range fuse LV HRC design gR/SITOR 3NE1	Semiconductor protection fuse Cylindrical design			Cable and line protection fuse LV HRC design gL/gG 3NA	Cylindrical design			DIAZED quick 5SB
		10 x 38 mm aR/SITOR 3NC1 0	14 x 51 mm aR/SITOR 3NC1 4	22 x 58 mm aR/SITOR 3NC2 2		10 x 38 mm gL/gG 3NW	14 x 51 mm gL/gG 3NW	22 x 58 mm gL/gG 3NW	
3RF23 1-.....2	3NE1 813-0	3NC1 010	3NC1 410	3NC2 220	3NA2 803	3NW6 001-1	3NW6 101-1	-	5SB1 41
3RF23 1-.....4	3NE1 813-0	3NC1 010	3NC1 410	3NC2 220	3NA2 801	3NW6 001-1	3NW6 101-1	-	5SB1 41
3RF23 1-.....6	3NE1 813-0	3NC1 010	3NC1 410	3NC2 220	3NA2 803-6	-	-	-	-
3RF23 2-.....2	3NE1 814-0	3NC1 020	3NC1 420	3NC2 220	3NA2 807	3NW6 007-1	3NW6 107-1	3NW6 207-1	5SB1 71
3RF23 2-.....4	3NE1 814-0	3NC1 020	3NC1 420	3NC2 220	3NA2 807	3NW6 005-1	3NW6 105-1	3NW6 205-1	5SB1 71
3RF23 2-.....6	3NE1 814-0	3NC1 020	3NC1 420	3NC2 220	3NA2 807-6	-	-	-	-
3RF23 3-.....2	3NE1 803-0	3NC1 032	3NC1 432	3NC2 232	3NA2 810	-	3NW6 107-1	3NW6 207-1	5SB3 11
3RF23 3-.....4	3NE1 803-0	3NC1 032	3NC1 432	3NC2 232	3NA2 807	-	3NW6 105-1	3NW6 205-1	5SB3 11
3RF23 3-.....6	3NE1 803-0	3NC1 032	3NC1 432	3NC2 232	3NA2 807-6	-	-	-	-
3RF23 4-.....2	3NE1 802-0	-	3NC1 440	3NC2 240	3NA2 817	-	3NW6 117-1	3NW6 217-1	5SB3 21
3RF23 4-.....4	3NE1 802-0	-	3NC1 440	3NC2 240	3NA2 812	-	3NW6 112-1	3NW6 212-1	5SB3 21
3RF23 4-.....6	3NE1 802-0	-	3NC1 440	3NC2 240	3NA2 812-6	-	-	-	-
3RF23 5-.....2	3NE1 817-0	-	3NC1 450	3NC2 250	3NA2 817	-	3NW6 117-1	3NW6 217-1	5SB3 21
3RF23 5-.....4	3NE1 817-0	-	3NC1 450	3NC2 250	3NA2 812	-	-	3NW6 210-1	5SB3 21
3RF23 5-.....6	3NE1 817-0	-	3NC1 450	3NC2 250	3NA2 812-6	-	-	-	-
3RF23 7-.....2	3NE1 820-0	-	-	3NC2 280	3NA2 817	-	-	3NW6 217-1	5SB3 31
3RF23 7-.....4	3NE1 020-2	-	-	3NC2 280	3NA2 812	-	-	3NW6 210-1	5SB3 21
3RF23 7-.....6	3NE1 020-2	-	-	3NC2 280	3NA2 812-6	-	-	-	-
3RF23 9-.....2	3NE1 021-2	-	-	3NC2 200	3NA2 817	-	-	3NW6 217-1	5SB3 31
3RF23 9-.....4	3NE1 021-2	-	-	3NC2 280	3NA2 812	-	-	3NW6 210-1	5SB3 21
3RF23 9-.....6	3NE1 020-2	-	-	3NC2 280	3NA2 812-6	-	-	-	-

1) Type of coordination "2" acc. to EN 60947-4-1:
In the event of a short-circuit, the controlgear in the load feeder must not endanger persons or the installation. They must be suitable for further operation. For fused configurations, the protective device must be replaced.

Solid-State Contactors

3RF24 Solid-state contactors – technical data

Overview

The complete units consist of a solid-state relay plus optimized heat sink, and are therefore ready to use. They offer defined rated currents to make selection as easy as possible. Depending on the version, current intensities of up to 50 A are achieved. Like all of our solid-state switching devices, one of their particular advantages is their compact and space-saving design. With their insulated mounting foot they can easily be snapped onto a standard mounting rail, or they can be mounted on carrier plates with fixing screws. This insulation enables them to be used in

circuits with protective extra-low voltage (PELV) or safety extra-low voltage (SELV) in building engineering. For other applications, such as for extended personal safety, the heat sink can be grounded through a screw terminal.

Version for resistive loads, "zero-point switching"

This standard version is often used for switching space heaters on and off.

Technical specifications

Order No.	3RF24 ..-1....	3RF24 ..-2....	3RF24 ..-3....
General data			
Ambient temperature			
• During operation, derating from 40 °C	°C	-25 ... +60	
• During storage	°C	-55 ... +80	
Site altitude	m	0 ... 1000; derating from 1000	
Shock resistance acc. to IEC 60068-2-27	g/ms	15/11	
Vibration resistance acc. to IEC 60068-2-6	g	2	
Degree of protection		IP20	
Insulation strength at 50/60 Hz (main/control circuit to ground)	V rms	4000	
Electromagnetic compatibility (EMC)			
• Emitted interference acc. to IEC 60947-4-3 - Conducted interference voltage - Emitted, high-frequency interference voltage		Class A for industrial applications ¹⁾ Class A for industrial applications	
• Interference immunity - Electrostatic discharge acc. to IEC 61000-4-2 (corresponds to degree of severity 3)	kV	Contact discharge 4; air discharge 8; behavior criterion 2	
- Induced RF fields acc. to IEC 61000-4-6	MHz	0.15 ... 80; 140 dBµV; behavior criterion 1	
- Burst acc. to IEC 61000-4-4	kV	2/5.0 kHz; behavior criterion 1	
- Surge acc. to IEC 61000-4-5	kV	Conductor – ground 2; conductor – conductor 1; behavior criterion 2	
Connection technique		Screw terminal	Spring-loaded connection
Main contact connection			
• Conductor cross-section	mm ²	2 x (1.5 ... 2.5), 2 x (2.5 ... 6)	2x (0.5 ... 2.5)
- Solid	mm ²	2 x (1 ... 2.5), 2 x (2.5 ... 6), 1 x 10	2x (0.5 ... 1.5)
- Finely stranded with end sleeve	mm ²	--	2x (0.5 ... 2.5)
- Finely stranded without end sleeve	mm ²	2 x (AWG 14 ... 10)	2 x (AWG 18 ... 14)
- Solid or stranded, AWG conductors			
• Stripped length	mm	10	10
• Terminal screw		M4	--
- Tightening torque	NM	2 ... 2.5	
	lb.in	18 ... 22	
• Cable lug		--	--
- acc. to DIN 46234			5-2.5 ... 5-25
- acc. to JIS C 2805			R 2-5 ... 14-5
Connection, auxiliary/control contacts			
• Conductor cross-section	mm	1 x (0.5 ... 2.5), 2 x (0.5 ... 1.0)	0.5 ... 2.5
	AWG	AWG 20 ... 12	AWG 20 ... 12
• Stripped length	mm	7	10
• Terminal screw		M3	--
- Tightening torque,	NM	0.5 ... 0.6	
∅ 3.5, PZ 1	lb.in	4.5 ... 5.3	
			M3
			0.5 ... 0.6
			4.5 ... 5.3

1) These products were built as Class A devices. The use of these devices in residential areas could result in radio interference. In this case they may be required to introduce additional damping measures.

Solid-State Contactors

3RF24 Solid-state contactors – technical data

Type		3RF24 ..-AB.5	3RF24 ..-AC.5
Main circuit			
Controlled phases		Two-phase	Three-phase
Rated operational voltage U_e	V	48 ... 600	48 ... 600
• Operating range	V	40 ... 660	40 ... 660
• Rated frequency	Hz	50/60 ± 10 %	50/60 ± 10 %
Rated insulation voltage U_i	V	600	600
Rated impulse withstand voltage U_{imp}	kV	6	6
Blocking voltage	V	1200	1200
Rate of voltage rise	V/μs	1000	1000

Order No.	Type current I_{AC-51} at 40 °C	Rated operational current I_e acc. to IEC 60947-4-3 for 40°C	Rated operational current I_e acc. to UL/CSA for 50 °C	Power loss at I_{AC-51}	Minimum load current	Max. leakage current	Rated impulse withstand current I_{tsm}	I^2t value
	A	A	A	w	A	mA	A	A ² s
Main circuit								
3RF24 10-.AB.5	10.5	7.5	9.5	21	0.1	10	200	200
3RF24 20-.AB.5	20	15	18	39	0.5	10	500	1800
3RF24 30-.AB.5	30	22	26	61	0.5	10	1200	7200
3RF24 40-.AB.5	40	32	35	81	0.5	10	1150	6600
3RF24 50-.AB.5	50	38	45	105	0.5	10	1150	6600
3RF24 10-.AC.5	10.5	7	9	32	0.1	10	300	450
3RF24 20-.AC.5	20	15	18	67	0.5	10	600	1800
3RF24 30-.AC.5	30	22	26	93	0.5	10	1200	7200
3RF24 40-.AC.5	40	29	35	121	0.5	10	1150	6600
3RF24 50-.AC.5	50	38	45	160	0.5	10	1150	6600

1) The type current provides information about the performance of the solid-state contactor. The actual permitted rated operational current I_e can be smaller depending on the connection method and start-up conditions. For derating see the characteristic curves on page 4/18.

Type		3RF24 ...-4.	3RF24 ...-5.
Control circuit			
Method of operation		DC operation	AC operation
Rated control supply voltage U_c	V	4 ... 30	190 ... 230
Rated frequency of the control supply voltage	Hz	--	50/60 ± 10%
Actuating voltage, max.	V	30	253
• For actuating current	mA	15	6
Response voltage	V	4	180
• For tripping current	mA	> 3	> 2
Drop-out voltage	V	< 1	< 40
Operating times			
• ON-delay	ms	1 + max. one half-wave	40 + max. one half-wave
• OFF delay	ms	1 + max. one half-wave	40 + max. one half-wave



Solid-State Contactors

3RF34 Solid-state contactors – technical data

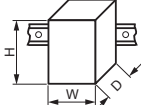
Technical specifications

Type		3RF34 05-1BB..	3RF34 10-1BB..	3RF34 05-2BB..	3RF34 10-2BB..
		3RF34 03-1BD.. 3RF34 05-1BD..	3RF34 12-1BB.. 3RF34 16-1BB.. 3RF34 10-1BD..		3RF34 12-2BB.. 3RF34 16-2BB..
Dimensions (W x H x D)	mm	45 x 95 x 96.5	90 x 95 x 96.5	45 x 95 x 96.5	90 x 95 x 96.5

General technical specifications

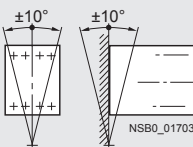
Ambient temperature			
• During operation, derating from 40 °C	°C	-25 ... +60	
• During storage	°C	-55 ... +80	
Installation altitude		m	0 ... 1000; derating from 1000 on request
Shock resistance acc. to IEC 60068-2-27		g/ms	15/11
Vibration resistance acc. to IEC 60068-2-6		g	2
Degree of protection			IP20
Insulation strength at 50/60 Hz (main/control circuit to floor)		V rms	4000
Electromagnetic compatibility (EMC)			
• Emitted interference according to IEC 60947-4-2			Class A for industrial applications ¹⁾
- Conducted interference voltage			Class A for industrial applications
- Emitted, high-frequency interference voltage			
• Interference immunity			
- Electrostatic discharge according to IEC 61000-4-2 (corresponds to degree of severity 3)		kV	Contact discharge: 4; Air discharge: 8; Behavior criterion 2
- Induced RF fields according to IEC 61000-4-6		MHz	0.15 ... 80; 140 dBµV; behavior criterion 1
- Burst acc. to IEC 61000-4-4		kV	2; at 5 kHz; behavior criterion 2
- Surge according to IEC 61000-4-5 ²⁾		kV	Conductor - Ground: 2; Conductor - Conductor: 1; Behavior criterion 2
Connection type		 Screw terminals	 Spring-type terminals
Operating devices		Standard screwdriver size 2 and Pozidriv 2	3.0 x 0.5 and 3.5 x 0.5
Conductor cross-sections, main contacts			
• Solid	mm ²	2 x (1.5 ... 2.5) ³⁾ , 2 x (2.5 ... 6) ³⁾	2 x (0.5 ... 2.5)
• Finely stranded with end sleeve	mm ²	2 x (1 ... 2.5) ³⁾ ; 2 x (2.5 ... 6) ³⁾ ; 1 x 10	2 x (0.5 ... 1.5)
• Finely stranded without end sleeve	mm ²	--	2 x (0.5 ... 2.5)
• AWG cables, solid or stranded		2 x (AWG 14 ... 10)	2 x (AWG 18 ... 14)
Conductor cross-sections, auxiliary/control contacts			
• With/without end sleeve	mm ²	1 x (0.5 ... 2.5), 2 x (0.5 ... 1.0)	0.5 ... 2.5
• AWG cables, solid or stranded		AWG 20 ... 12	AWG 20 ... 12
Permissible mounting positions			

¹⁾ These products were built as Class A devices. The use of these devices in residential areas could result in radio interference. In this case these may be required to introduce additional interference suppression measures.

²⁾ The following applies for reversing contactors: To maintain the values, a 3TX7 462-3L surge suppressor (see "3TB Contactors", Chapter 3) should be used between the phases L1 and L3 as close as possible to the reversing contactor.

³⁾ If two different conductor cross-sections are connected to one clamping point, both cross-sections must lie in one of the ranges specified.

Solid-State Contactors

3RF34 Solid-state contactors – technical data

Overview

These two-phase controlled, instantaneous switching solid-state contactors in the insulating enclosure are offered in 45 mm width to 5.2 A – and in 90 mm width to 16 A. This means that it is possible to operate motors up to 7.5 kW.

Technical specifications

Type		3RF34 05-.BB..	3RF34 10-.BB..	3RF34 12-.BB..	3RF34 16-.BB..
Fuseless design with 3RV2 motor starter protector, CLASS 10					
Rated operational current I_{AC-53}¹⁾ according to IEC 60947-4-2					
• At 40 °C	A	5.2 (4.5)	9.2	12.5	16
• UL/CSA, at 50 °C	A	4.6 (4.0)	8.4	11.5	14
• At 60 °C	A	4.2 (3.5)	7.6	10.5	12.5
Power loss at I_{AC-53}					
• At 40 °C	W	10 (8)	16	22	28
Short-circuit protection with type of coordination "1" at an operational voltage of U_e to 440 V					
• Motor starter protector, type		3RV20 11-1GA10	3RV20 11-1JA10	3RV20 11-1KA10	3RV20 11-4AA10
• Current I_q	kA	50	5	5	3

¹⁾ The reduced values in brackets apply to a directly mounted circuit breaker and simultaneous butt-mounting.

Type		3RF34 05-.BB.4	3RF34 05-.BB.6	3RF34 10-.BB..	3RF34 12-.BB.4	3RF34 12-.BB.6	3RF34 16-.BB..
Fused design with directly connected 3RB3 overload relay							
Rated operational current I_{AC-53} according to IEC 60947-4-2							
• At 40 °C	A	4		7.8	9.5		11
• UL/CSA, at 50 °C	A	3.6		7	8.5		10
• At 60 °C	A	3.2		6.2	7.6		9
Power loss at I_{AC-53}							
• At 40 °C	W	7		13	16		18
Minimum load current							
	A	0.5					
Max. off-state current							
	mA	10					
Rated peak withstand current I_{tsm}							
	A	200	600	600	1200	1150	1150
I^2t value							
	A ² s	200	1800	1800	7200	6600	6600

Type		3RF34 ..-.BB.4		3RF34 ..-.BB.6	
Main circuit					
Controlled phases					
		2-phase		2-phase	
Rated operational voltage U_e					
	V AC	48 ... 480		48 ... 600	
• Operating range	V AC	40 ... 506		40 ... 660	
• Rated frequency	Hz	50/60 ± 10 %		50/60 ± 10 %	
Rated insulation voltage U_i					
	V	600		600	
Rated impulse withstand voltage U_{imp}					
	kV	6		6	
Blocking voltage					
	V	1200		1600	
Rate of voltage rise					
	V/μs	1000		1000	

Solid-State Contactors

3RF34 Solid-state contactors – technical data

Type		3RF34 ...BB0.	3RF34 ...BB2.
Control circuits			
Method of operation		DC operation	AC operation
Rated control supply voltage U_s	V	24 acc. to IEC 61131-2	110 ... 230
Rated frequency of the control supply voltage	Hz	--	50/60 ± 10 %
Control supply voltage, max.	V	30	253
Typical actuating current	mA	20	15
Response voltage	V	15	90
Drop-out voltage	V	5	< 40
Operating times			
• ON-delay	ms	1	5
• OFF-delay	ms	1 + max. one half-wave	30 + max. one half-wave

Circuit diagrams

DC control supply voltage

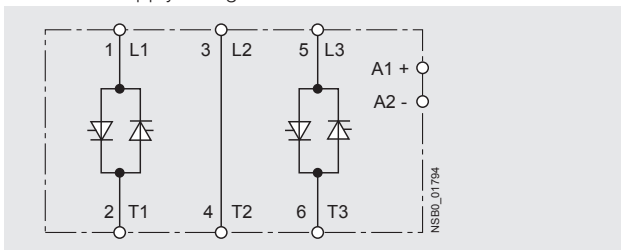

AC control supply voltage

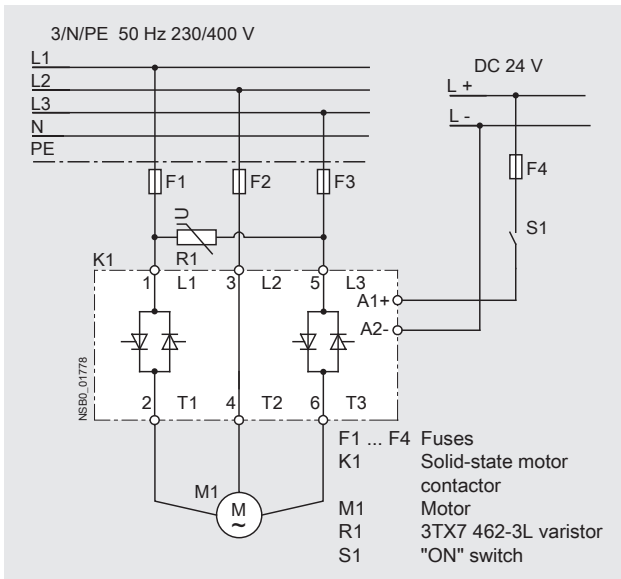
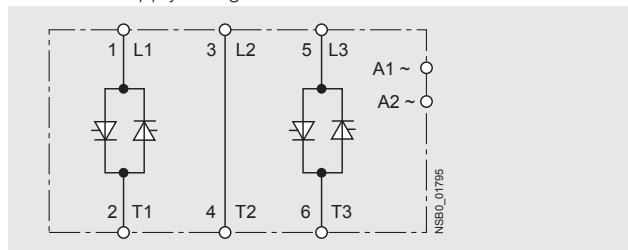

Solid-State Contactors

3RF34 Solid-state reversing contactors – technical data

Overview

The integration of four conducting paths to a reverse switch, combined in one enclosure makes this device a particularly compact solution. Compared to conventional systems, for which two contactors are required, it is possible to save up to 50 %

width with the three-phase reversing contactors. Devices with 45 mm width cover motors up to 2.2 kW – and those with 90 mm width up to 3 kW.

Technical specifications

Type		3RF34 03-.BD.4	3RF34 05-.BD.4	3RF34 10-.BD.4
Fuseless design with 3RV2 motor starter protector, CLASS 10				
Rated operational current I_{AC-53}¹⁾ according to IEC 60947-4-2				
• At 40 °C	A	3.8 (3.4)	5.4 (4.8)	7.4
• UL/CSA, at 50 °C	A	3.5 (3.1)	5 (4.3)	6.8
• At 60 °C	A	3.2 (2.8)	4.6 (3.8)	6.2
Power loss at I_{AC-53}				
• At 40 °C	W	7 (6)	9 (8)	13
Short-circuit protection with type of coordination "1" at an operational voltage of U_g to 440 V				
• Motor starter protector, type		3RV20 11-1FA10	3RV20 11-1GA10	3RV20 11-1JA10
• Current I_q	kA	50	50	10

¹⁾ The reduced values in brackets apply to a directly mounted circuit breaker and simultaneous butt-mounting.

Type		3RF34 03-.BD.4	3RF34 05-.BD.4	3RF34 10-.BD.4
Fused design with directly connected 3RB3 overload relay				
Rated operational current I_{AC-53} according to IEC 60947-4-2				
• At 40 °C	A	3.8	5.4	7.4
• UL/CSA, at 50 °C	A	3.5	5	6.8
• At 60 °C	A	3.2	4.6	6.2
Power loss at I_{AC-53}				
• At 40 °C	W	6	8	16
Minimum load current	A	0.5		
Max. off-state current	mA	10		
Rated peak withstand current I_{ISM}	A	200	600	
I^2t value	A ² s	200	1800	

Type		3RF34 ...-BD.4	
Main circuit			
Controlled phases		2-phase	
Rated operational voltage U_e¹⁾	V AC	48 ... 480	
• Operating range	V AC	40 ... 506	
• Rated frequency	Hz	50/60 ± 10 %	
Rated insulation voltage U_i	V	600	
Rated impulse withstand voltage U_{imp}	kV	6	
Blocking voltage	V	1 200	
Rate of voltage rise	V/μs	1 000	

¹⁾ To reduce the risk of a phase short circuit due to overvoltage, we recommend using a varistor type 3TX7 462-3L between the phases L1 and L3 and as close as possible to the switchgear.

We recommend a design with semiconductor protection as short-circuit protection.

Solid-State Contactors

3RF34 Solid-state reversing contactors – technical data

Type	3RF34 ...-BD0.	3RF34 ...-BD2.
Control circuits		
Method of operation	DC operation	AC operation
Rated control supply voltage U_s	V 24 acc. to IEC 61131-2	110 ... 230
Rated frequency of the control supply voltage	Hz --	50/60 ± 10 %
Control supply voltage, maximum	V 30	253
Typical actuating current	mA 15	10
Response voltage	V 15	90
Drop-out voltage	V 5	< 40
Operating times¹⁾		
• ON-delay	ms 5	20
• OFF-delay	ms 5 + max. one half-wave	10 + max. one half-wave
• Interlocking time	ms 60 ... 100	50 ... 100

¹⁾ Caution! Risk of phase short circuit in automatic mode.
The control inputs must not be actuated until after a delay time of 40 ms after the main voltage is applied

Circuit diagrams

DC control supply voltage

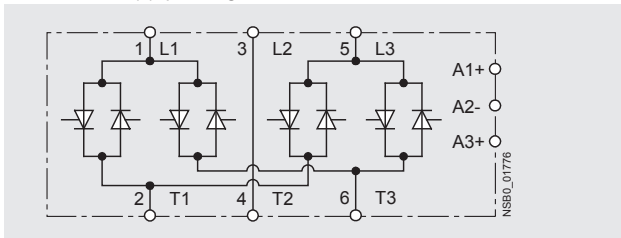

AC control supply voltage

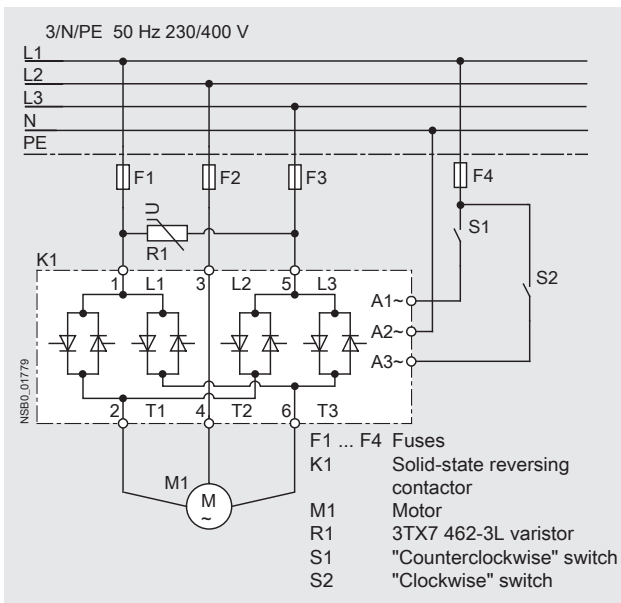
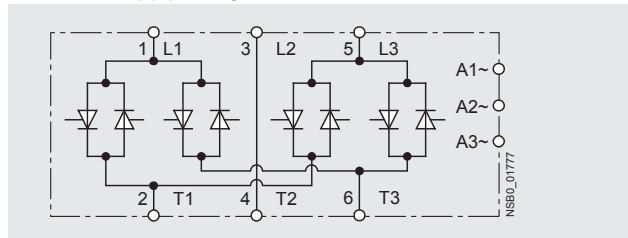

Function Modules

General and technical data

Overview

Function modules for SIRIUS SC semiconductor switching devices

A great variety of applications demand an expanded range of functionality. These applications can easily be met with Sirius SC function modules. The modules are mounted simply by clicking them into place; straight away the necessary connections are made with the semiconductor relay or contactor.

The plug-in connection to control the semiconductor switching devices can simply remain in use.

The following function modules are available:

- Converter
- Load monitors (basic and enhanced)
- Power controller

Technical specifications

Type	3RF29 ...E...	3RF29 ...F...	3RF29 ...G...	3RF29 ...H...
General data				
Ambient temperature				
during operation, derating at 40 °C	°C	-25 ... +60		
when stored	°C	-55 ... +80		
Site altitude	m	0 ... 1000; derating from 1000		
Shock resistance acc. to IEC 60068-2-27	g/ms	15/11		
Vibration resistance acc. to IEC 60068-2-6	g	2		
Degree of protection	IP20			
Electromagnetic compatibility (EMC)				
Emitted interference				
• Conducted interference voltage acc. to IEC 60947-4-3				
Class A for industrial applications ¹⁾				
• Emitted, high-frequency interference voltage acc. to IEC 60947-4-3				
Class A for industrial applications				
Noise immunity				
• Electrostatic discharge acc. to IEC 61000-4-2 (corresponds to degree of severity 3)				
Contact discharge 4; air discharge 8; behavior criterion 2				
• Induced RF fields acc. to IEC 61000-4-6				
0.15 ... 80; 140 dBµV; behavior criterion 1				
• Burst acc. to IEC 61000-4-4				
2 kV/5.0 kHz; behavior criterion 1				
• Surge acc. to IEC 61000-4-5				
Conductor - ground 2; conductor - conductor 1; behavior criterion 2				
Connection, auxiliary/control contacts, screw connection				
Conductor cross-section	mm ²	1x (0.5 ... 2.5); 2x (0.5 ... 1) AWG 20 ... 12		
• Insulation stripping length	mm	7		
Terminal screw		M3		
• Tightening torque	Nm	0.5 ... 0.6		
Converter diameter of hole	mm	-	7	17

1) Note limitations for power controller function module on page 2/31.

Type	3RF29 ...E.8	3RF29 ...F.8	3RF29 ...G.3	3RF29 ...G.6	3RF29 ...H.3	3RF29 ...H.6
Main circuit						
Rated operational voltage U_e	V	110 ... 230		400 ... 600	110 ... 230	400 ... 600
• Tolerance	%	-15 / +10				
• Rated frequency	Hz	50/60				
Rated insulation voltage U_i	V	600				
Voltage detection						
Measuring range	V	-	93.5 ... 253	340 ... 660	93.5 ... 253	340 ... 660
Mains voltage fluctuation compensation	%	-	20			

1) Versions do not depend on main circuit.

Type	3RF29 ...0.	3RF29 ...1.	3RF29 ...3.	
Control circuit				
Method of operation				
DC operation				
AC/DC operation				
AC operation				
Rated control supply voltage U_s	V	24	24	110
Rated operating current	mA	15	15	15
Max. rated control voltage	V	30	30	121
Rated control current at maximum voltage	mA	15	15	15
Rated frequency of the control supply voltage	Hz	-	50/60	50/60
Response voltage for tripping current	V	15	15	90
	mA	2	2	2
Drop-out voltage	V	5	5	-

Type	3RF29 2-.F...	3RF29 2-.G...	3RF29 2-.H...	3RF29 5-.G...	3RF29 5-.H...	3RF29 9-.G...	3RF29 9-.H...
Current detection							
Rated operational current I_e	A	20		50	90		
Measuring range	A	4 ... 22		4 ... 55	4 ... 99		
Number of partial loads		6	12	-	12	-	12

3RF29 Function Modules

General and technical data

Overview

Function modules for SIRIUS SC solid-state switching devices

A great variety of applications demand an expanded range of functionality. With our function modules, these requirements can be met really easily. The modules are mounted simply by clicking them into place; straight away the necessary connections are made with the solid-state relay or contactor. The plug-in connection to control the solid-state switching devices can simply remain in use.

The following function modules are available:

- Converter
- Load monitoring
- Heating current monitoring
- Power control regulators
- Power controller

Technical specifications

Type	3RF29 ...K...	
General data		
Ambient temperature		
• During operation, derating from 40 °C	°C	-25 ... +60
• During storage	°C	-55 ... +80
Site altitude	m	0 ... 1000; derating from 1000
Shock resistance acc. to IEC 60068-2-27	g/ms	15/11
Vibration resistance acc. to IEC 60068-2-27	g	2
Degree of protection	IP20	
Insulation resistance between load and control circuit	MΩ	1.5
Electromagnetic compatibility (EMC)		
• Emitted interference		
- Conducted interference voltage acc. to IEC 60947-4-3	Class A for industrial applications ¹⁾	
- Emitted, high-frequency interference voltage acc. to IEC 60947-4-3	Class A for industrial applications	
• Interference immunity		
- Electrostatic discharge acc. to IEC 61000-4-2 (corresponds to degree of severity 3)	kV	Contact discharge 4; air discharge 8; behavior criterion 2
- Induced RF fields acc. to IEC 61000-4-6	MHz	0.15 ... 80; 140 dBμV; behavior criterion 1
- Burst acc. to IEC 61000-4-4	2 kV/5.0 kHz; behavior criterion 1	
- Surge acc. to IEC 61000-4-5	kV	Conductor – ground 2; conductor – conductor 1; behavior criterion 2
Connection, auxiliary/control contacts, screw terminal		
• Conductor cross-section	mm ²	1 x (0.5 ... 2.5), 2 x (0.5 ... 1.0), 1 x (AWG 20 ... 12)
• Stripped length	mm	7
• Terminal screw	M3	
- Tightening torque	Nm	0.5 ... 0.6
	lb.in	4.5 ... 5.3
Converter, diameter of hole	mm	17

1) These products were built as Class A devices. The use of these devices in residential areas could result in radio interference. In this case the user may require to introduce additional damping measures.

3RF29 Function Modules

Power control regulators

Technical specifications

Type	3RF29 ...0KA.3		3RF29 ...0KA.6	
Main circuit				
Rated operational voltage U_e	V	110 ... 230	400 ... 600	
• Tolerance	%	-15/+10		
• Rated frequency	Hz	50/60		
Rated insulation voltage U_i	V	600		
Voltage detection				
• Measuring/teach range	V	93.5 ... 253	340 ... 660	
Compensation of mains voltage fluctuation	%	20 (only within the measuring range)		

Type	3RF29 04-0KA..		3RF29 20-0KA..		3RF29 50-0KA..		3RF29 90-0KA..	
Current measurement								
Rated operational current I_e	A	4	20	50	90			
Current measurement								
• Teach range	A	0.15 ... 4	0.65 ... 20	1.6 ... 50	2.9 ... 90			
• Measuring range	A	0 ... 4	0 ... 22	0 ... 55	0 ... 99			
• Minimum partial load current	A	--	0.65	1.6	2.9			
Number of partial loads		1 ... 6						

Type	3RF29 ...0KA1.		3RF29 ...0KA3.	
Control circuit A1–A2				
General data				
Rated control supply voltage U_s	V	24 AC/DC		AC 110
• Operating range	V	20.5 ... 26.5	DC 18 ... 30	90 ... 121
Rated frequency of the control supply voltage	Hz	50/60 ± 10%	--	50/60 ± 10%
Current consumption	mA	< 40		< 20
Control input IN				
Rated control voltage U_c	V	24 AC/DC		AC 110
• For actuating current	mA	< 15		< 15
• Actuating voltage, max.	mA	AC 26.5	DC 30	121
Control supply voltage, min./max.	V	AC 20.5 ... 26.5	DC 18 ... 30	90 ... 121
Response voltage	V	AC 14	DC 15	79
• For tripping current	mA	> 2	> 2	> 2
Drop-out voltage	V	5	5	15
Control input 0 ... 10 V				
Input analog	V	0 ... 10		
• Permissible range	V	-1 ... 11		
Input resistance	kΩ	8		
Period duration	s	1		
Auxiliary circuit 11–12				
Switching voltage	V	24 AC/DC		AC 110
• Actuating current (utilization category)	A	0.5 (DC-12)		0.5 (AC-12)
• Switching voltage, min./max.	V	15 ... 30		90 ... 121
Continuous thermal current, max. I_{th}	A	1		1

Semiconductor Relays and Contactors, Function Modules

Project planning aids

Characteristics

SIRIUS SC semiconductor relays

Dependence of the device current I_e on the ambient temperature T_a (Chart data for SIRIUS SC relays based on I max)

SIRIUS SC semiconductor relay with 20 A type current (3RF21 20/3RF20 20)¹⁾

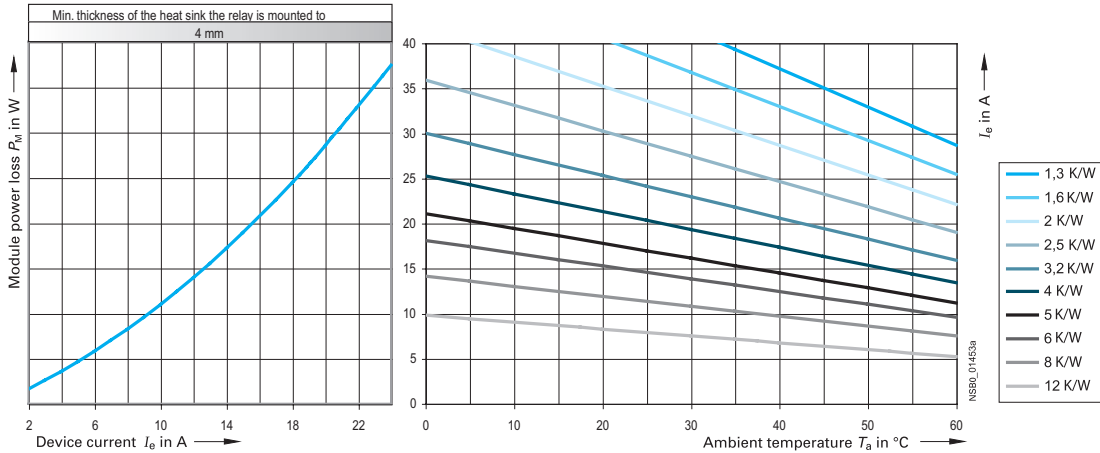

SIRIUS SC semiconductor relay with 30 A type current (3RF21 30/3RF20 30)

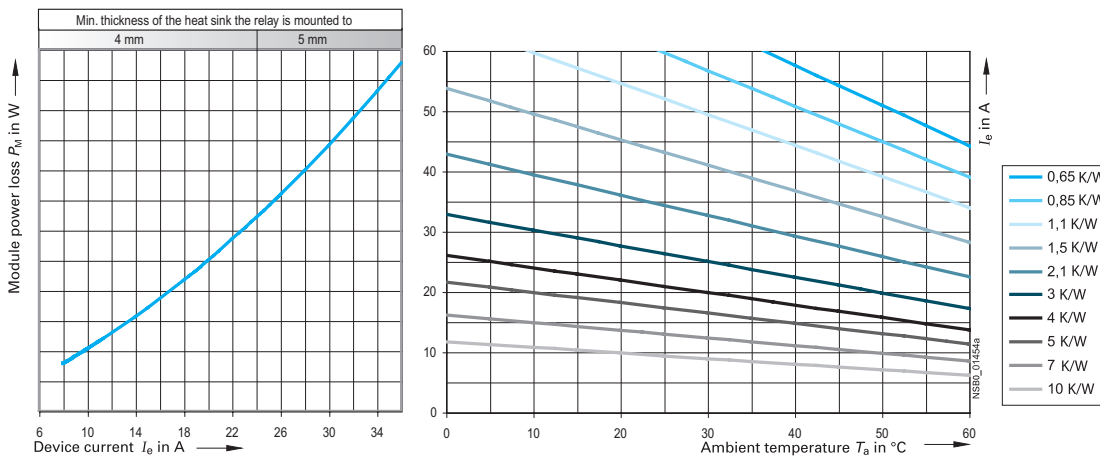

SIRIUS SC semiconductor relay with 50 A type current (3RF21 50/3RF20 50)

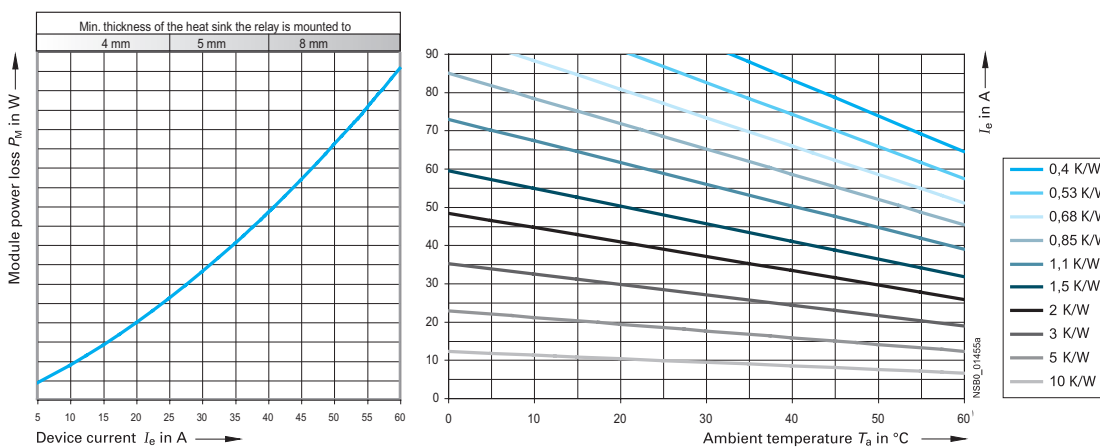

1) Arrangement example for $I_e = 20$ A and $T_a = 40$ C:
The task is to find the thermal resistance R_{thha} and the heat-sink overtemperature dT_{ha} : From the diagram on the left $\rightarrow P_M = 28$ W, from the diagram on the right $\rightarrow R_{thha} = 1.7$ K/W.

This results in: $dT_{ha} = R_{thha} \times P_M = 1.7$ K/W \times 28 W = 47.6 K. At $dT_{ha} = 47.6$ K the heat sink must therefore have an $R_{thha} = 1.7$ K/W. (Chart data for SIRIUS SC relays based on I max)

Semiconductor Relays and Contactors, Function Modules

Project planning aids

Dependence of the device current I_e on the ambient temperature T_a (Chart data for SIRIUS SC relays based on I_{max})

SIRIUS SC semiconductor relay with 70 A type current (3RF21 70/3RF20 70)

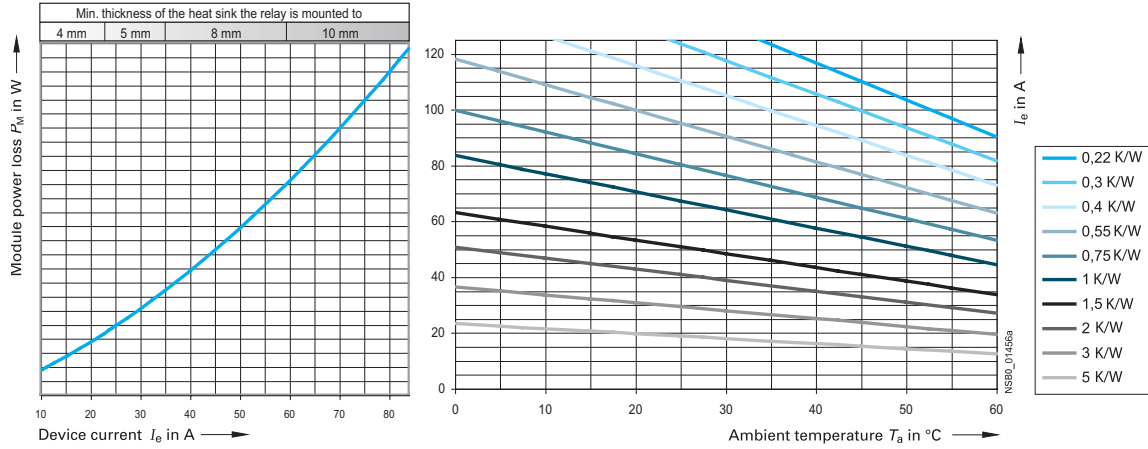

SIRIUS SC semiconductor relay with 88 A type current (3RF21 90/3RF20 90)

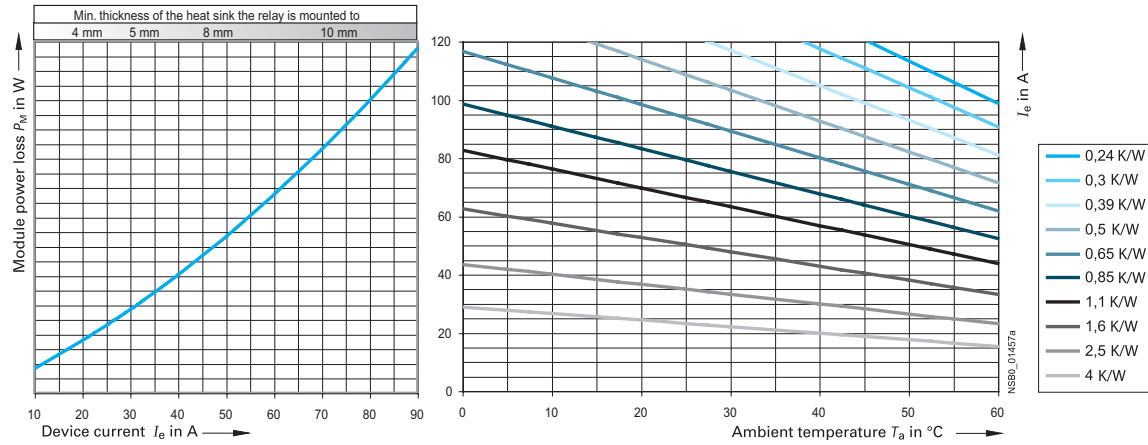

SIRIUS SC semiconductor contactors

Derating curves

SIRIUS SC semiconductor contactor with 10 A type current (3RF23 10)

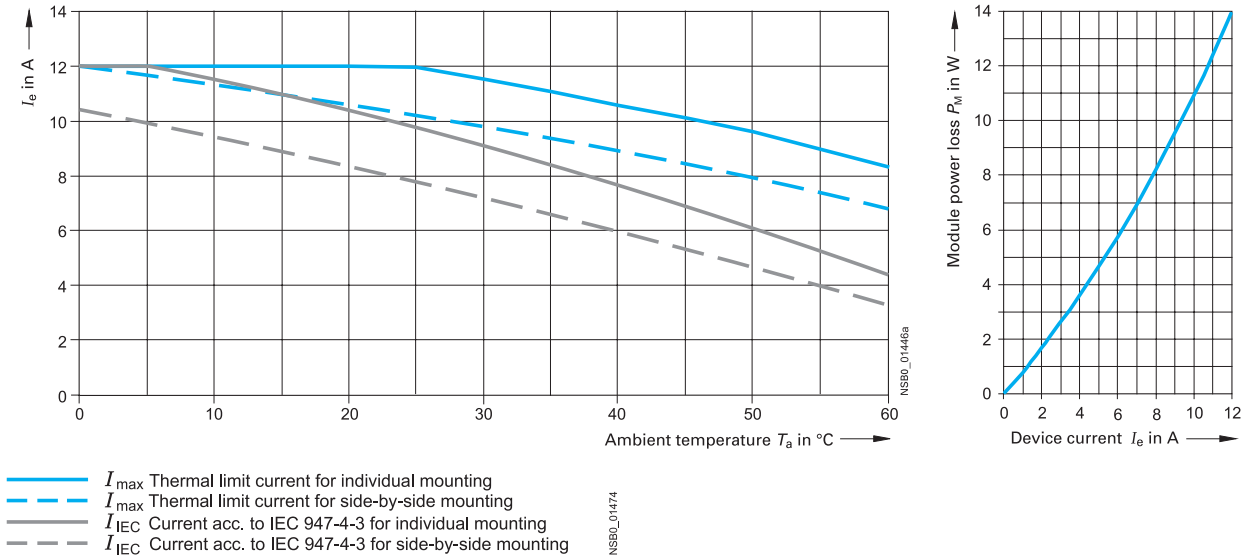

Semiconductor Relays and Contactors, Function Modules

Project planning aids

Derating curves

SIRIUS SC semiconductor contactor with 20 A type current (3RF23 20)

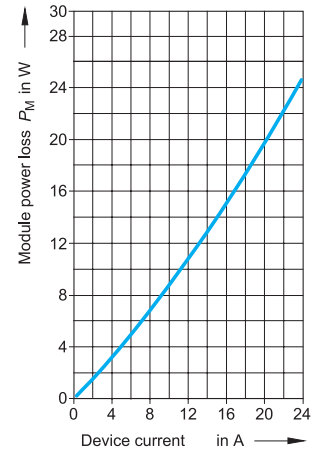
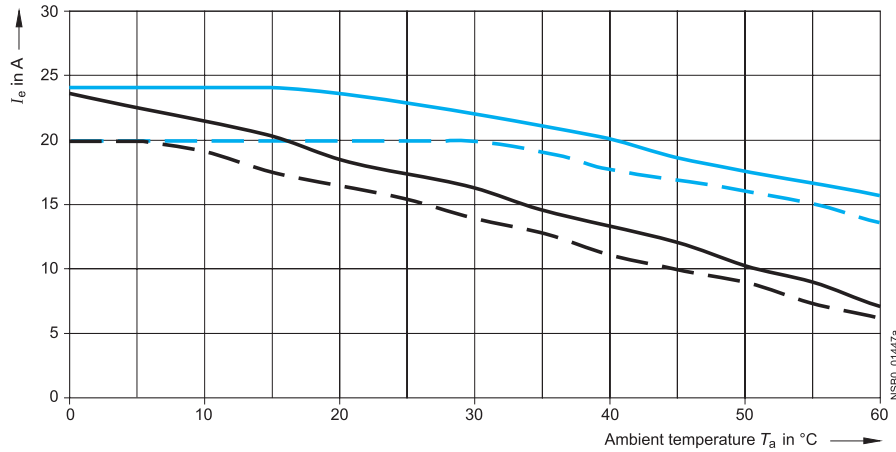

SIRIUS SC semiconductor contactor with 30 A type current (3RF23 30)

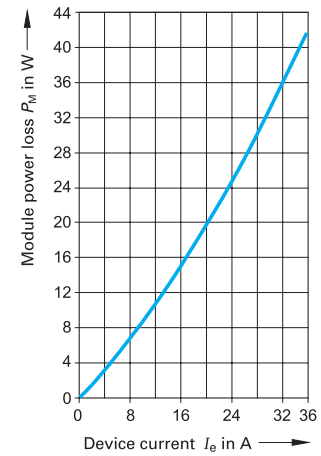
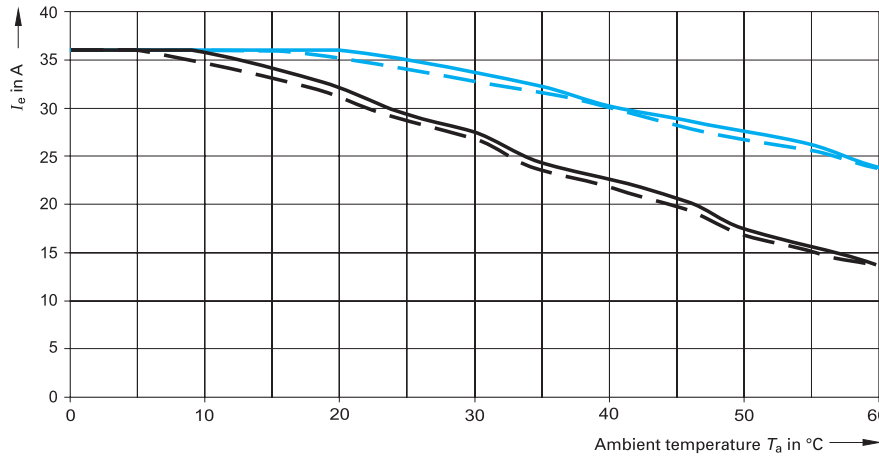

SIRIUS SC semiconductor contactor with 40 A type current (3RF23 40)¹⁾

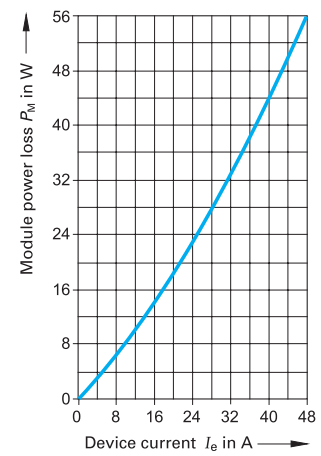
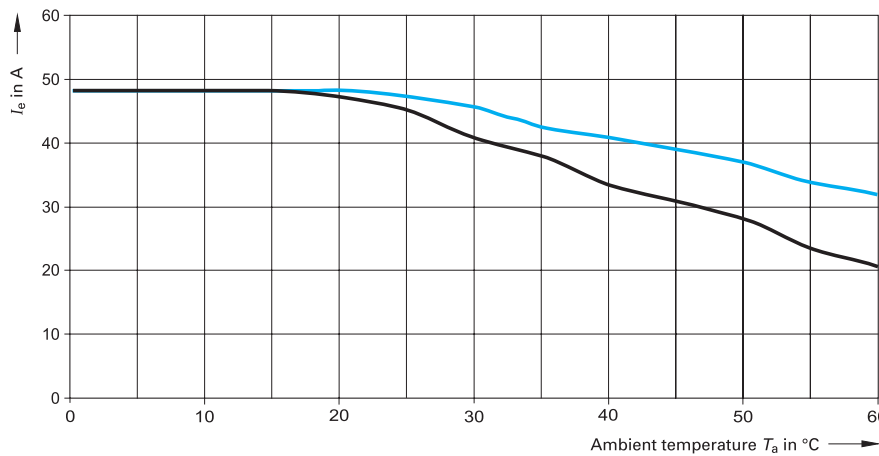

- I_{max} Thermal limit current for individual mounting
- - - I_{max} Thermal limit current for side-by-side mounting
- I_{IEC} Current acc. to IEC 947-4-3 for individual mounting
- - - I_{IEC} Current acc. to IEC 947-4-3 for side-by-side mounting

1) Identical current/temperature curves for individual and side-by-side mounting.

Semiconductor Relays and Contactors, Function Modules

Project planning aids

Derating curves

SIRIUS SC semiconductor contactor with 50 A type current (3RF23 50)¹⁾

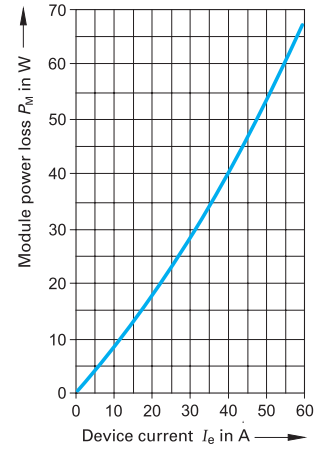
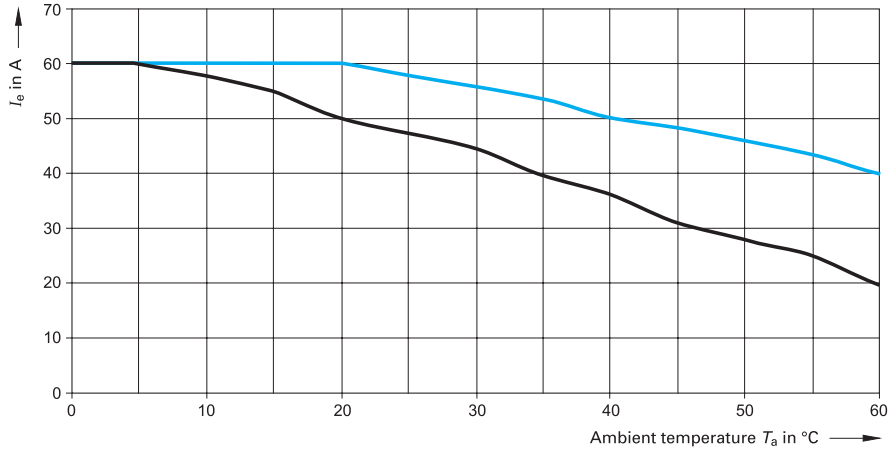

SIRIUS SC semiconductor contactor with 70 A type current (3RF23 70)¹⁾

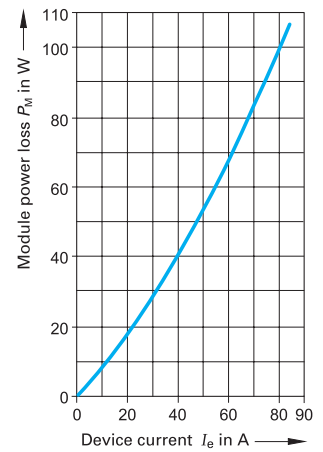
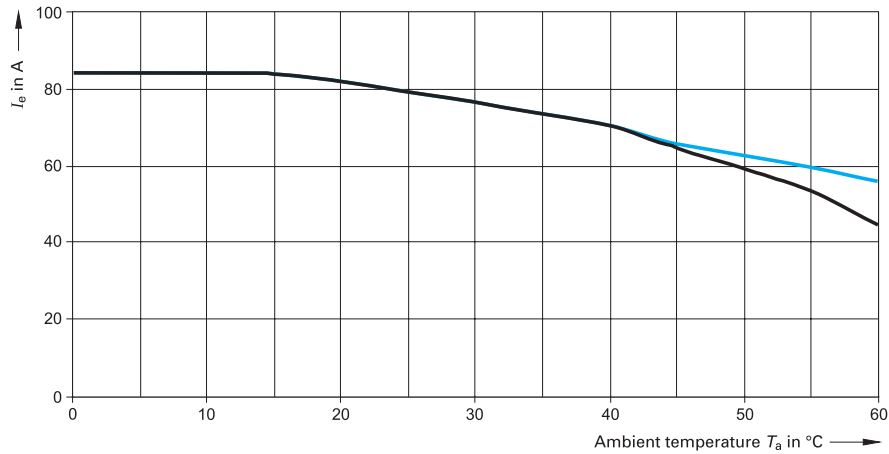

SIRIUS SC semiconductor contactor with 88 A type current (3RF23 90)¹⁾

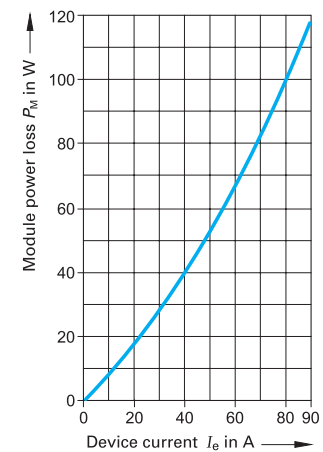
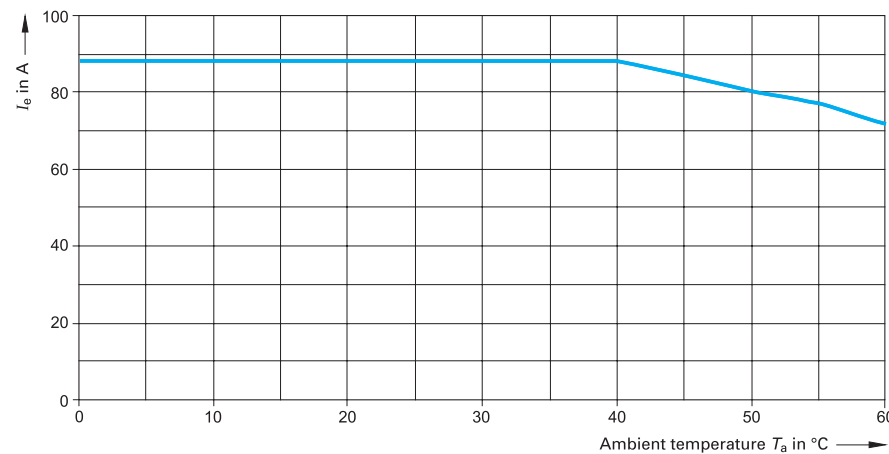

- I_{max} Thermal limit current for individual mounting
- - - I_{max} Thermal limit current for side-by-side mounting
- I_{IEC} Current acc. to IEC 947-4-3 for individual mounting
- - - I_{IEC} Current acc. to IEC 947-4-3 for side-by-side mounting

1) Identical current/temperature curves for individual and side-by-side mounting.

Solid-State Relays

3RF22 solid-state relays, 3-phase, 45 mm

Characteristic curves

Dependence of the device current I_e on the ambient temperature T_a (two-phase controlled)

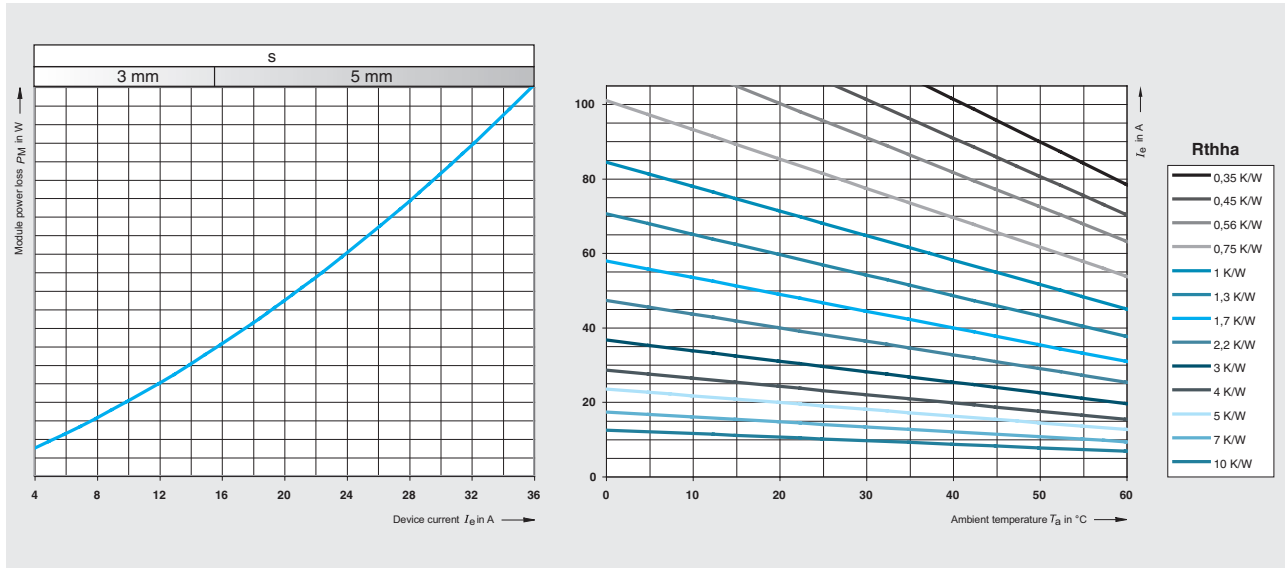

Type current 30 A (3RF22 30-AB..)

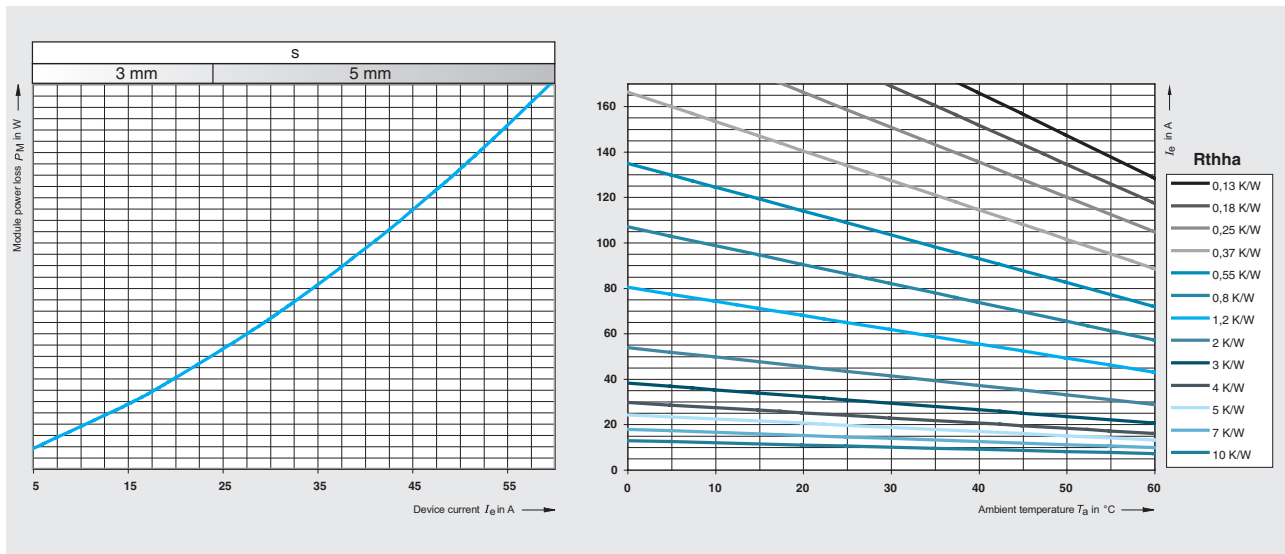

Type current 55 A (3RF22 55-AB..)

Solid-State Relays

3RF22 solid-state relays, 3-phase, 45 mm

Dependence of the device current I_e on the ambient temperature T_a (three-phase controlled)

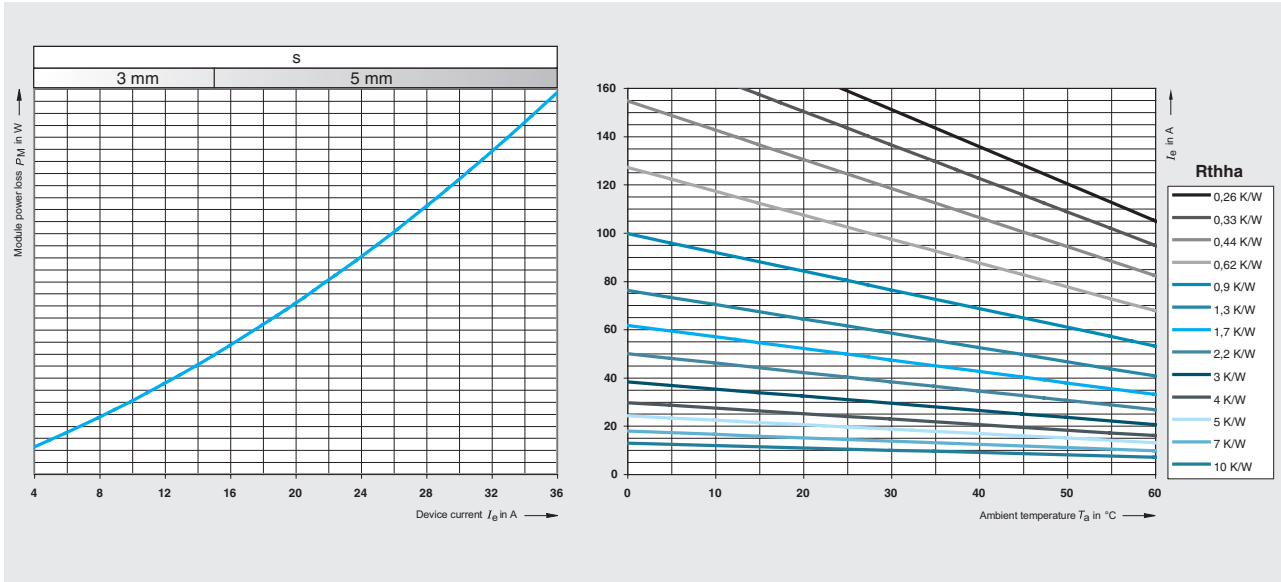

Type current 30 A (3RF22 30-.AC..)

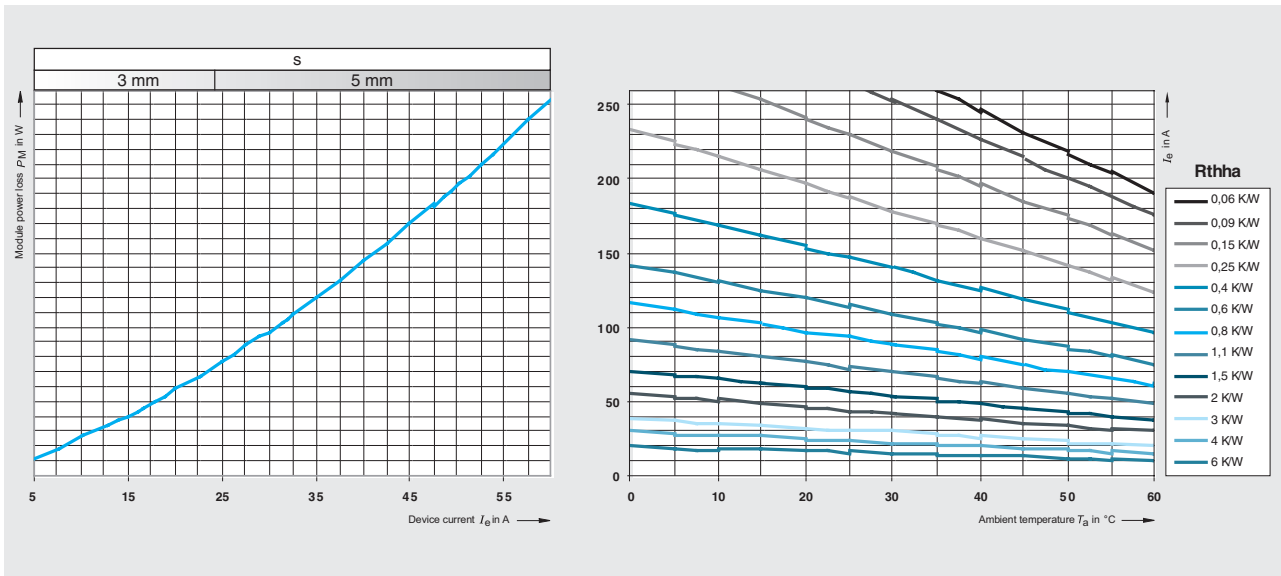

Type current 55 A (3RF22 55-.AC..)

Arrangement example

Given conditions: $I_e = 55$ A and $T_a = 40$ C.

The task is to find the thermal resistance R_{thha} and the heat sink overtemperature dT_{ha} .

From the diagram from the left $\rightarrow P_M = 227$ W,
from the diagram on the right $\rightarrow R_{thha} = 0.09$ K/W.

This results in:

$$dT_{ha} = R_{thha} \times PM = 0.09 \text{ K/W} \times 227 \text{ W} = 20.4 \text{ K.}$$

At $dT_{ha} = 20.4$ K the heat sink must therefore have an $R_{thha} = 0.09$ K/W.

Solid-State Contactors

3RF24 solid-state contactors, 3-phase

Characteristic curves

Derating curves, two-phase controlled

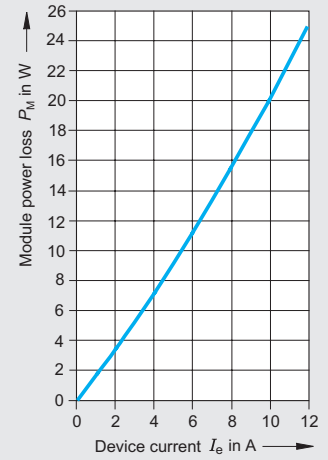
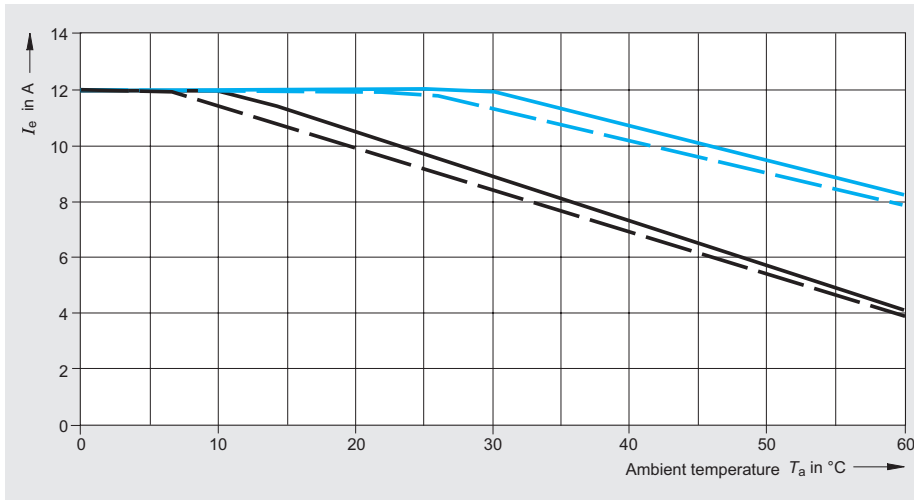

Type current 10.5 A (3RF24 10-AB..)

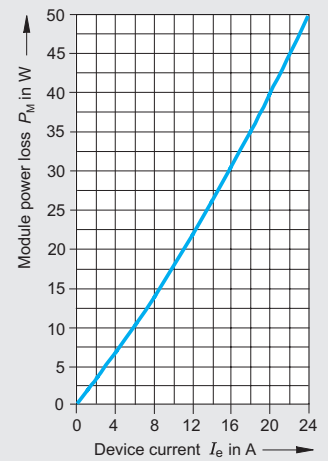
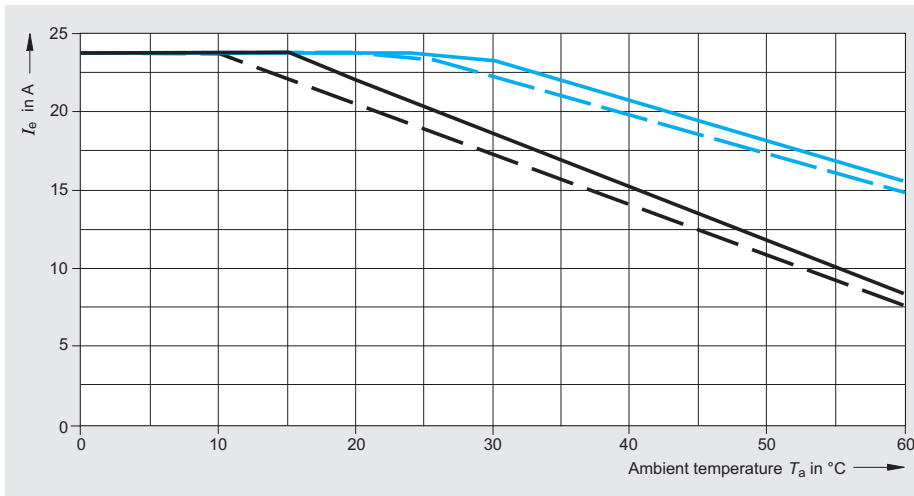

Type current 20 A (3RF24 20-AB..)

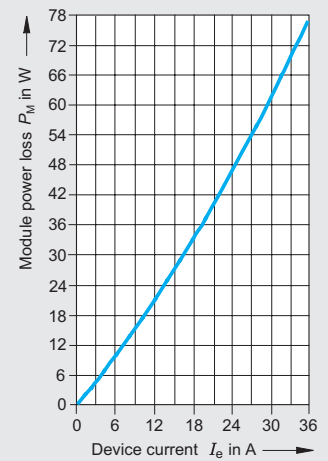
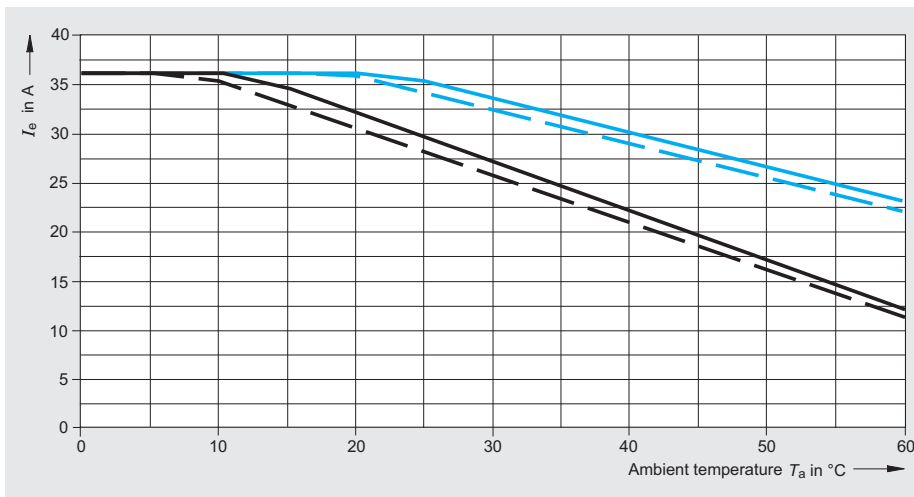

Type current 30 A (3RF24 30-AB..)

Solid-State Contactors

3RF24 solid-state contactors, 3-phase

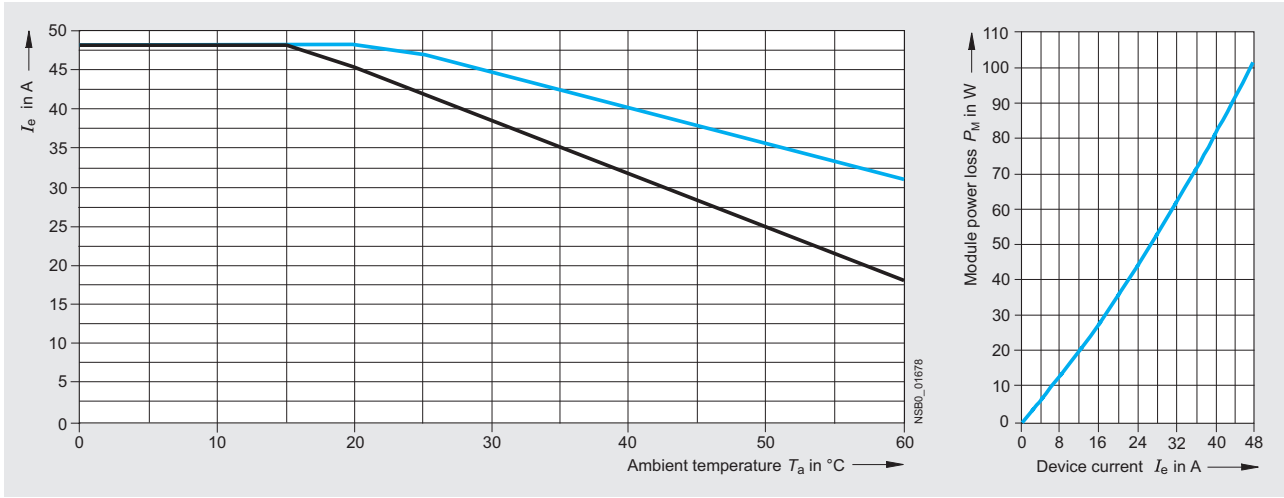

Type current 40 A (3RF24 40-.AB..)¹)

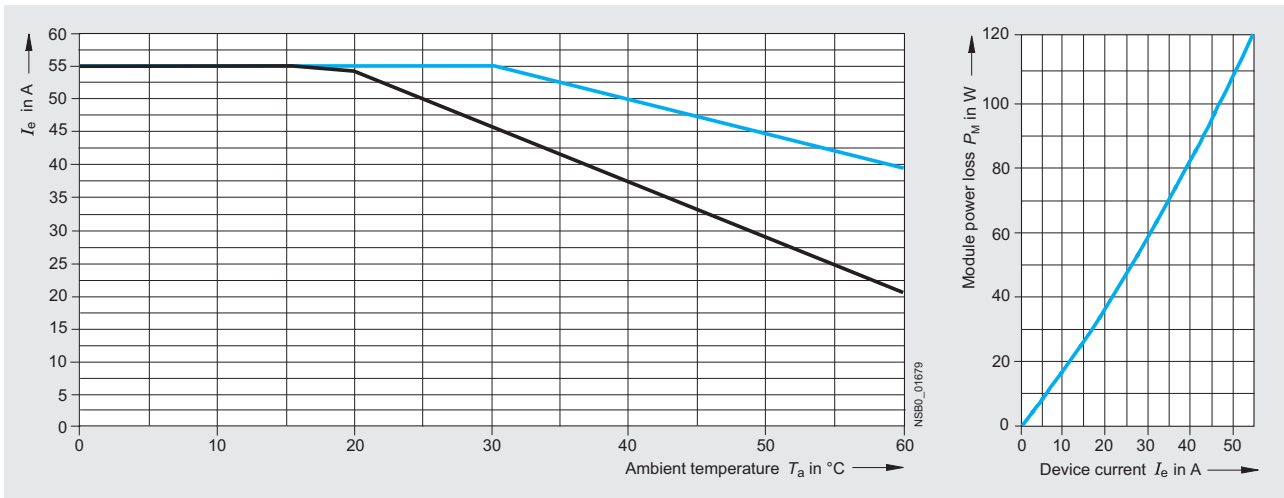

Type current 50 A (3RF24 50-.AB..)¹)

- I_{max} Thermal limit current for individual mounting
- - - I_{max} Thermal limit current for side-by-side mounting
- I_{IEC} Current acc. to IEC 947-4-3 for individual mounting
- - - I_{IEC} Current acc. to IEC 947-4-3 for side-by-side mounting

1) Identical current/temperature curves for stand-alone and side-by-side installation.

Solid-State Contactors

3RF24 solid-state contactors, 3-phase

Derating curves, three-phase controlled

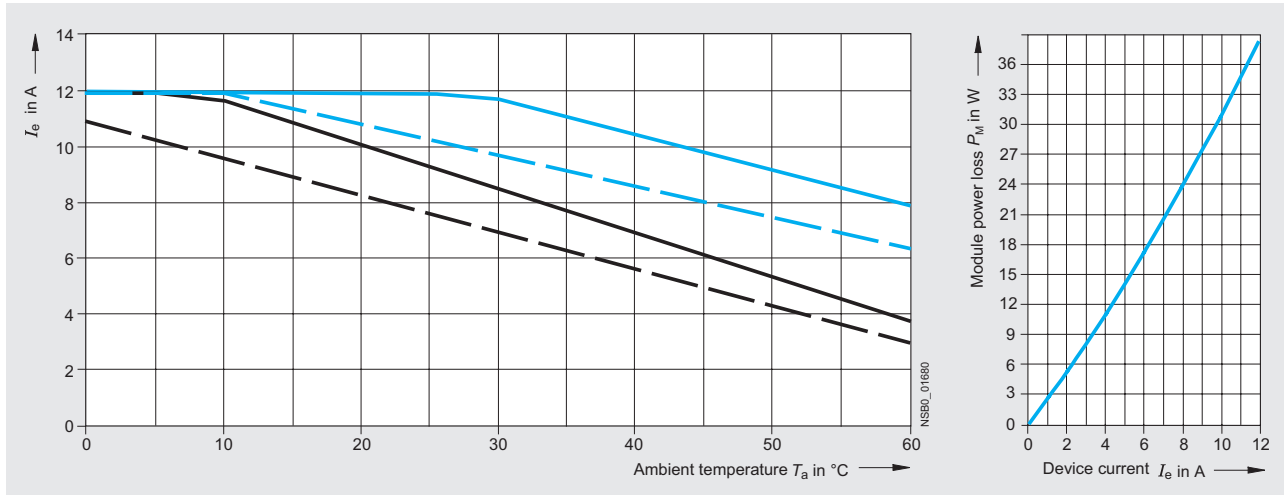

Type current 10.5 A (3RF24 10-.AC..)

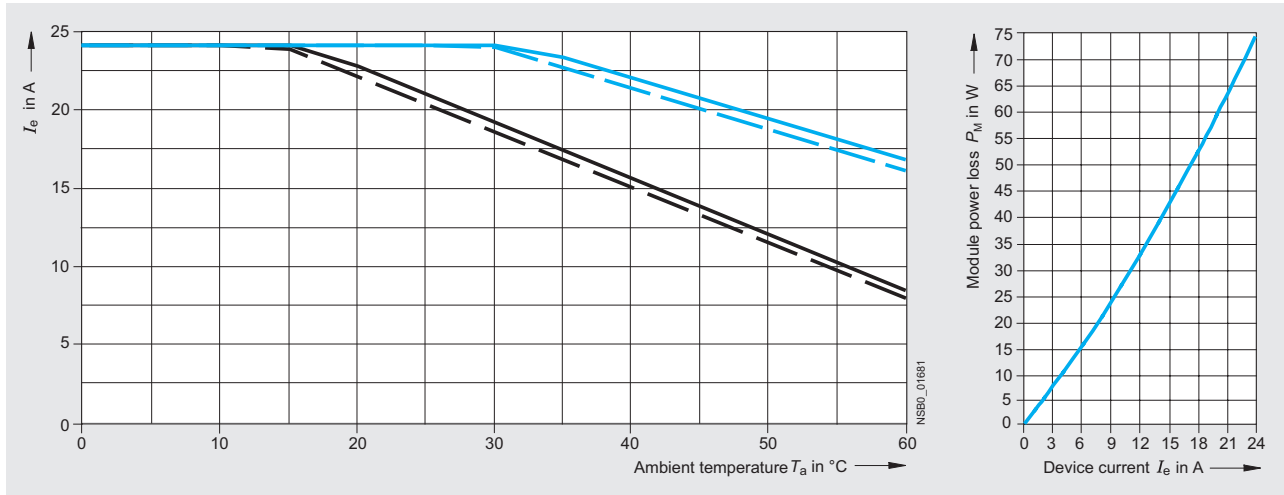

Type current 20 A (3RF24 20-.AC..)

1) Identical current/temperature curves for stand-alone and side-by-side installation.

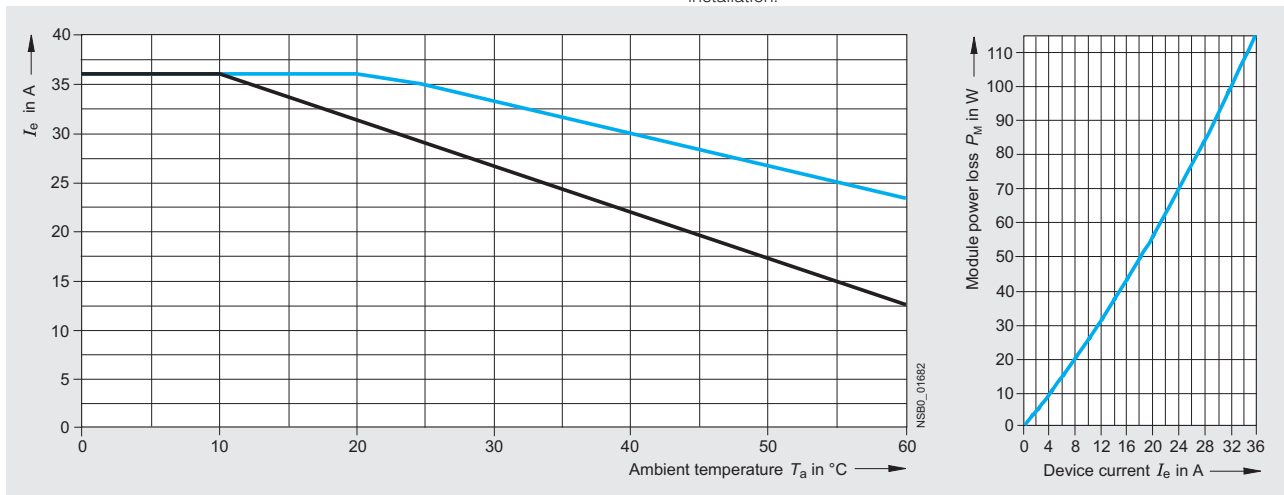

Type current 30 A (3RF24 30-.AC..)¹)

1) Identical current/temperature curves for stand-alone and side-by-side installation.

Solid-State Contactors

3RF24 solid-state contactors, 3-phase

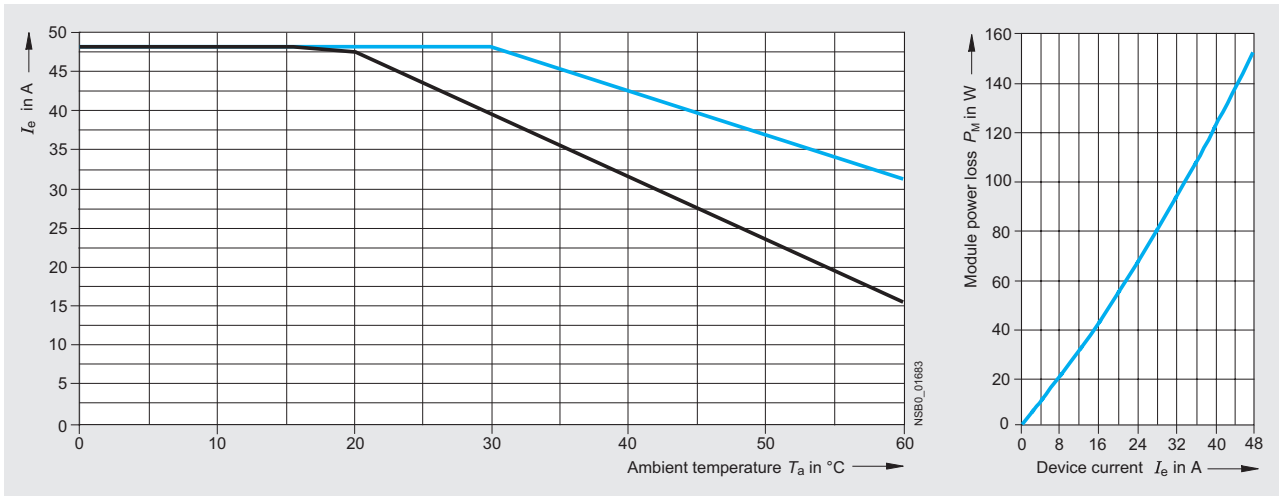

Type current 40 A (3RF24 40-.AC..)¹)

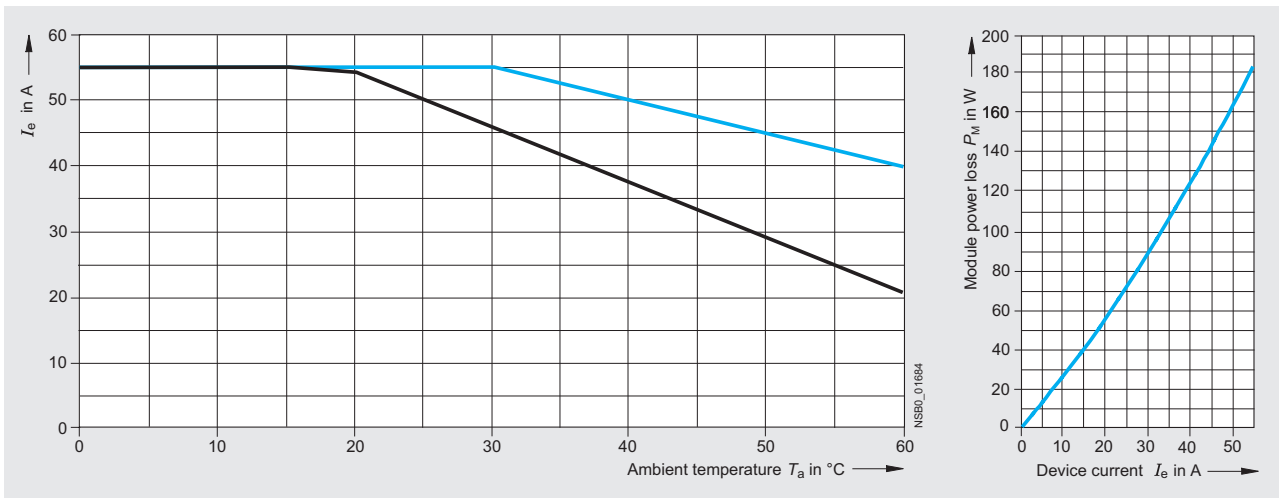

Type current 50 A (3RF24 50-.AC..)¹)

- I_{max} Thermal limit current for individual mounting
- - - I_{max} Thermal limit current for side-by-side mounting
- I_{IEC} Current acc. to IEC 947-4-3 for individual mounting
- - - I_{IEC} Current acc. to IEC 947-4-3 for side-by-side mounting

1) Identical current/temperature curves for stand-alone and side-by-side installation.

Solid-State Contactors

3RF34 solid-state contactors, 3-phase

Maximum permissible switching frequency depending on the starting time t_a and the ON period t_{ED}

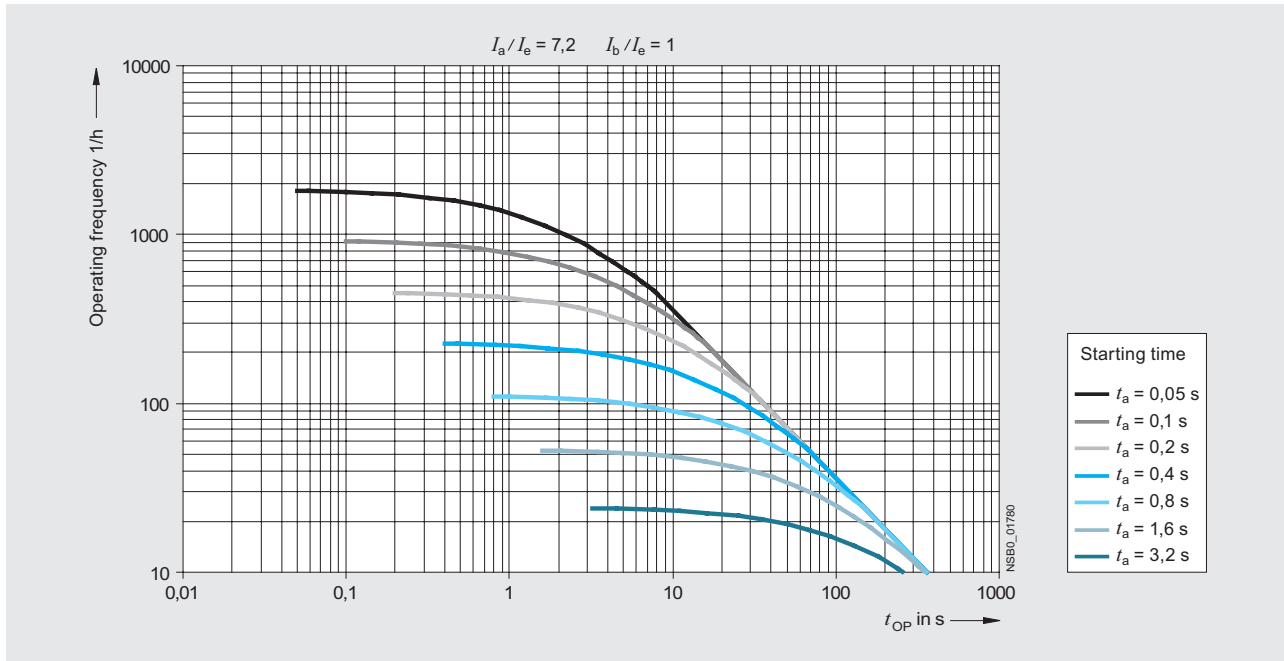

For motors with a starting current of 4- to 7.2 times the rated current and with a full load

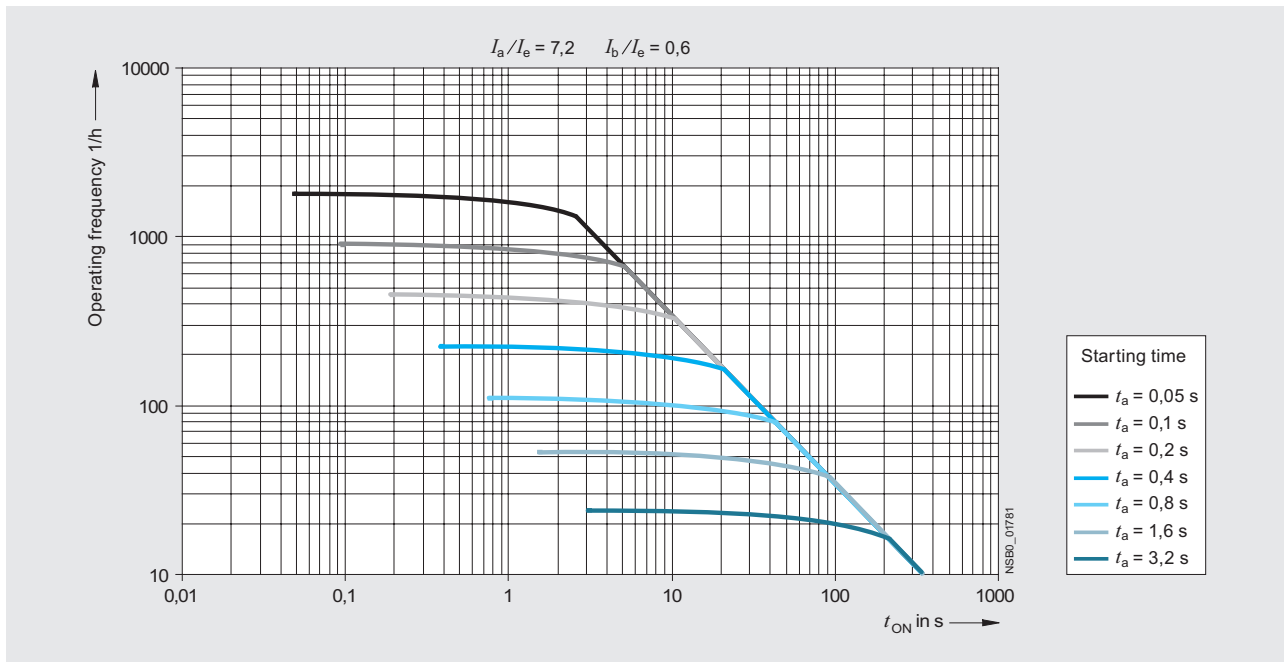

For motors with a starting current of 4- to 7.2 times the rated current and with a 60% load

Solid-State Contactors

3RF34 solid-state contactors, 3-phase

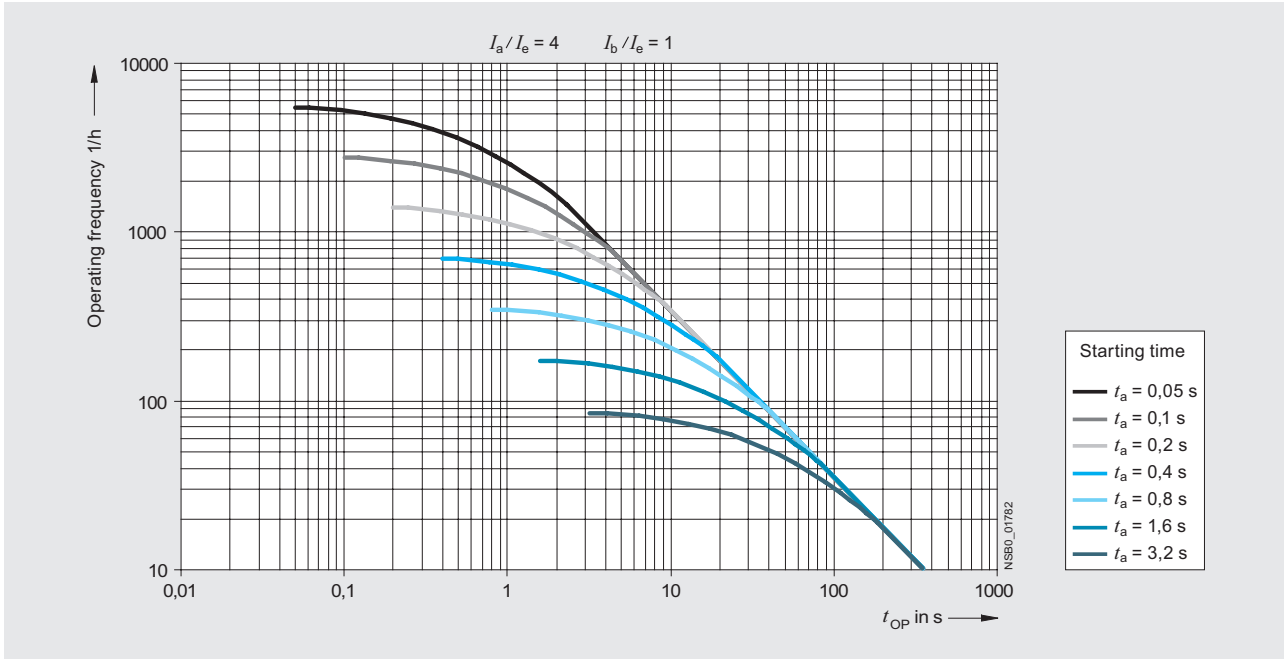

For motors with a starting current of up to 4 times the rated current and with a full load

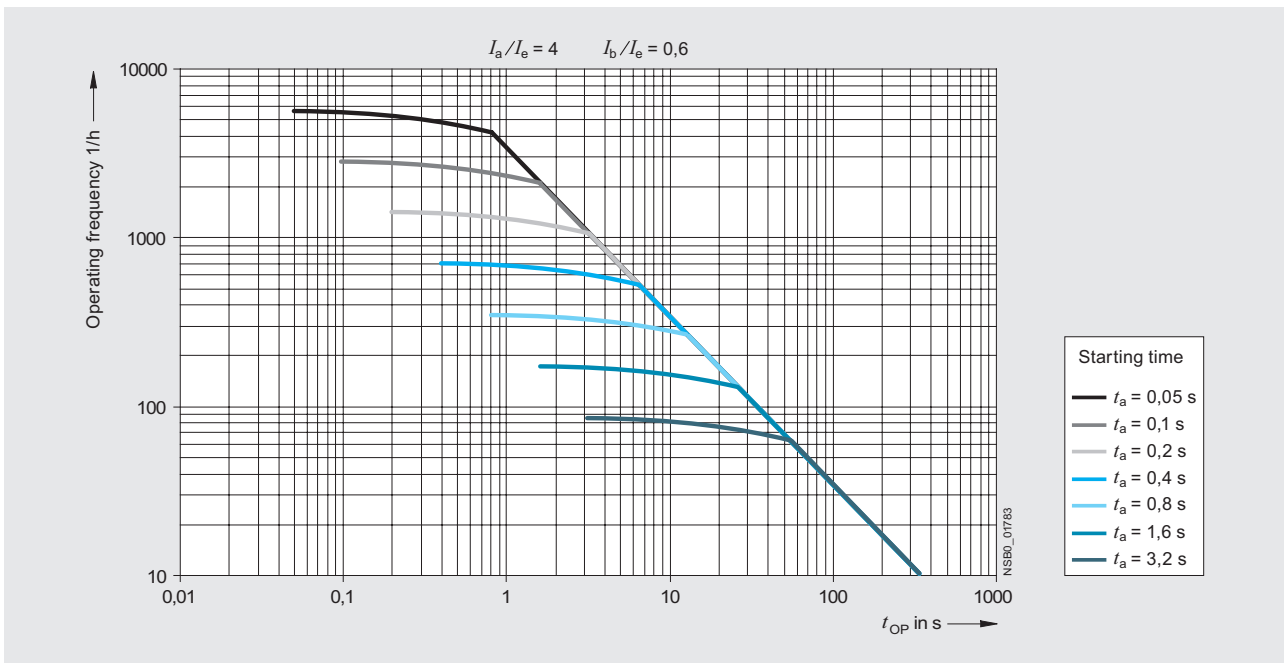

For motors with a starting current of up to 4 times the rated current and with a 60 % load

Solid-State Contactors

3RF34 solid-state reversing contactors, 3-phase

Maximum permissible switching frequency depending on the starting time t_a and the ON period t_{ED}

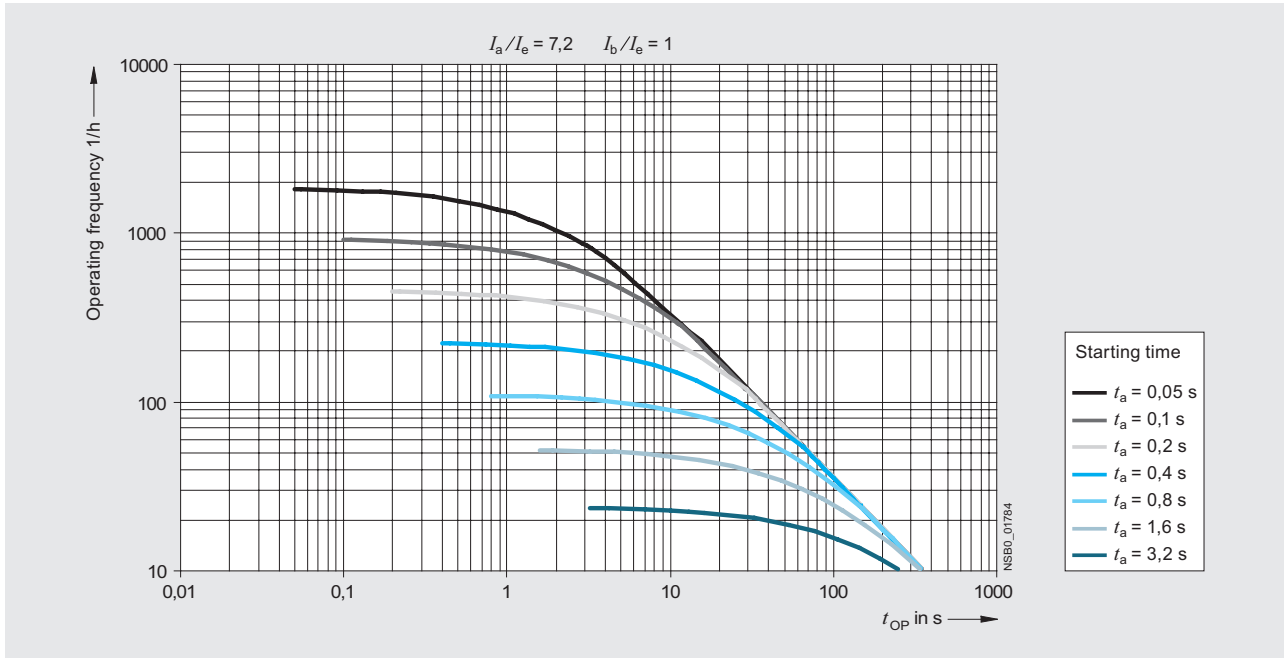

For motors with a starting current of 4- to 7.2 times the rated current and with a full load

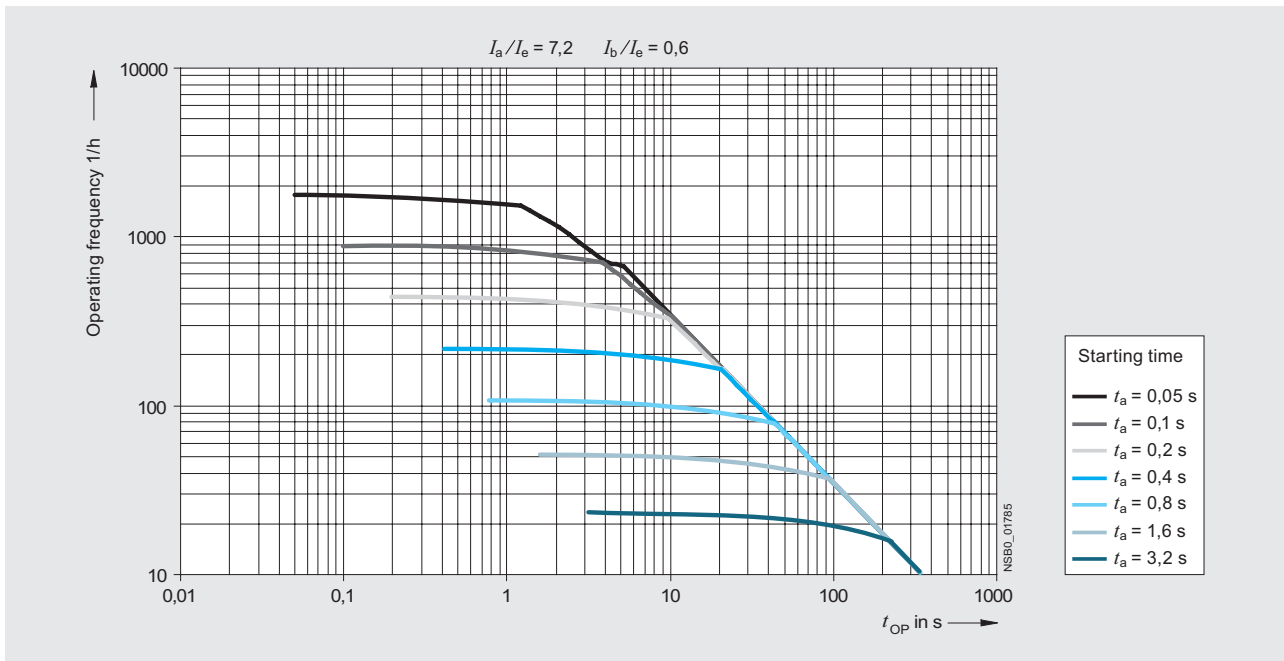

For motors with a starting current of 4- to 7.2 times the rated current and with a 60 % load

Solid-State Contactors

3RF34 solid-state reversing contactors, 3-phase

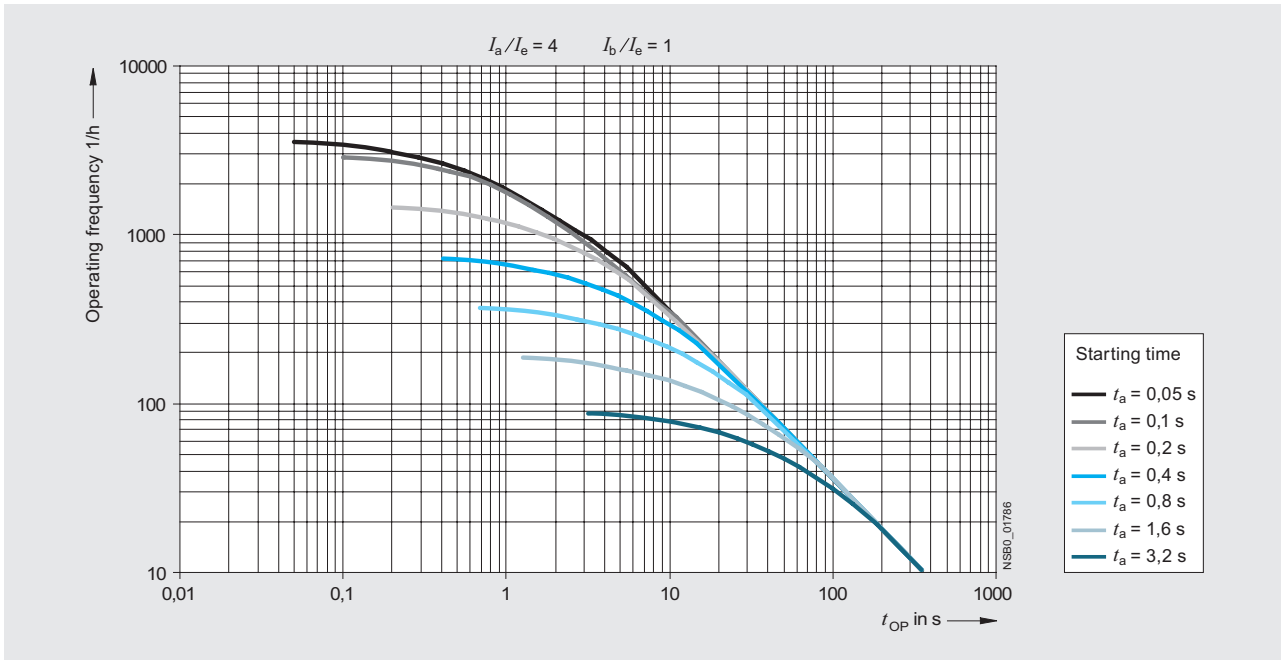

For motors with a starting current of up to 4 times the rated current and with a full load

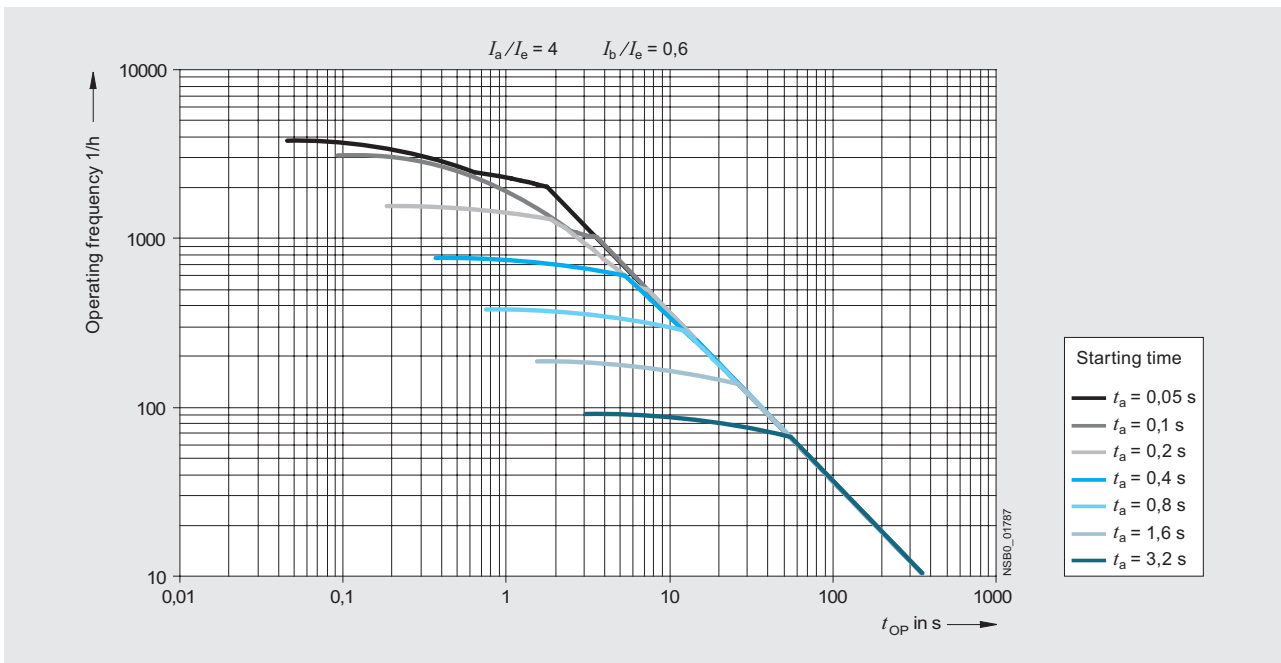

For motors with a starting current of up to 4 times the rated current and with a 60 % load

Dimension drawings

SIRIUS SC semiconductor relays

22.5 mm semiconductor relays

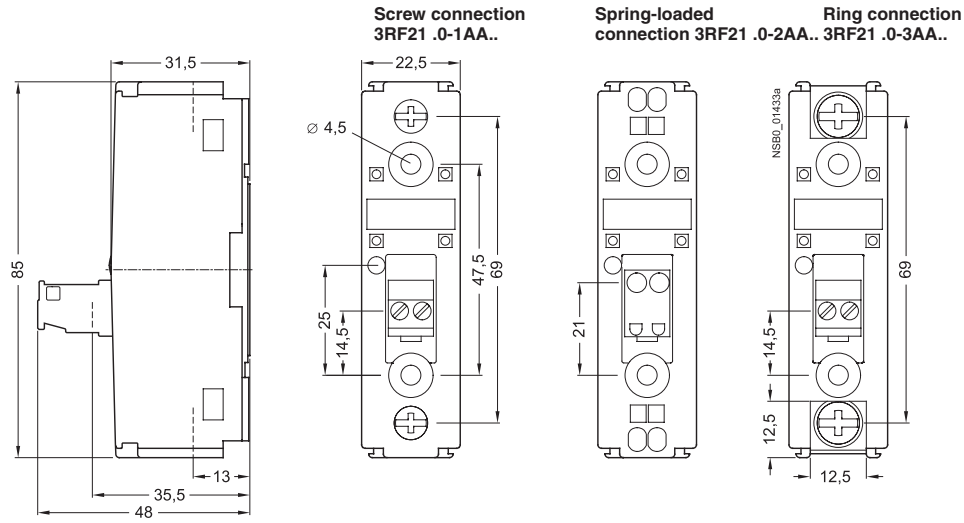

45 mm semiconductor relays

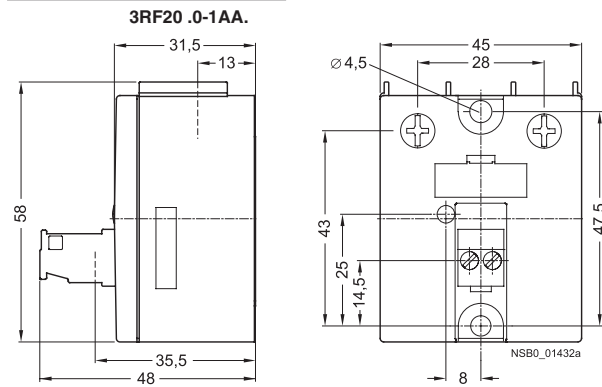

Solid-State Relays

3RF22 solid-state relays, 3-phase, 45 mm

Dimensional drawings

Solid-state relays

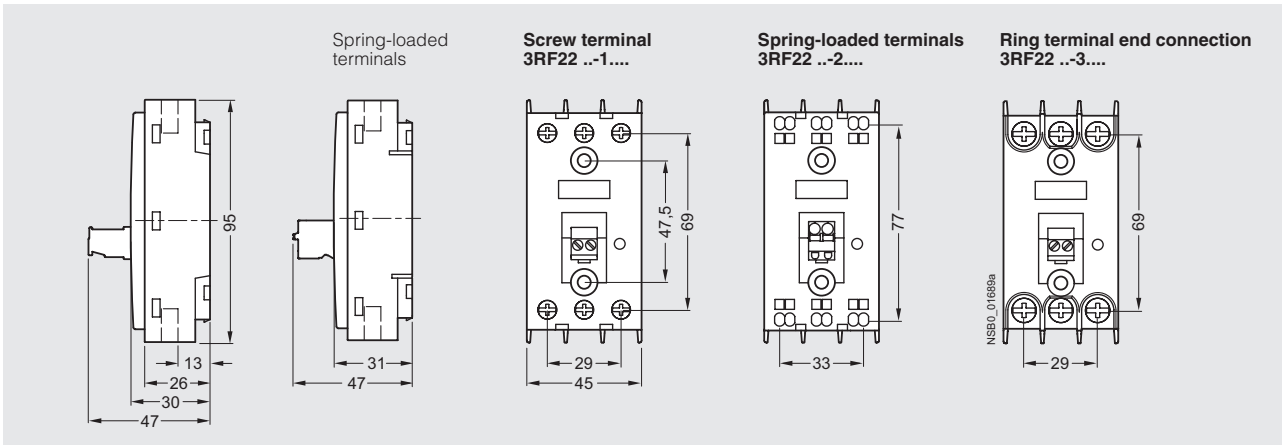

Schematics

Two-phase controlled DC control supply voltage

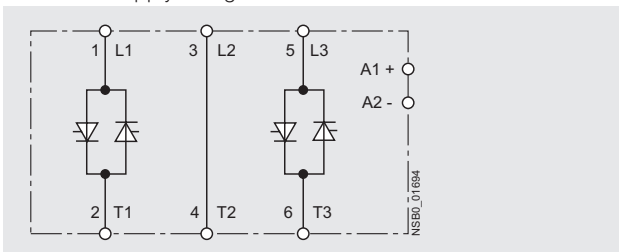

Three-phase controlled DC control supply voltage

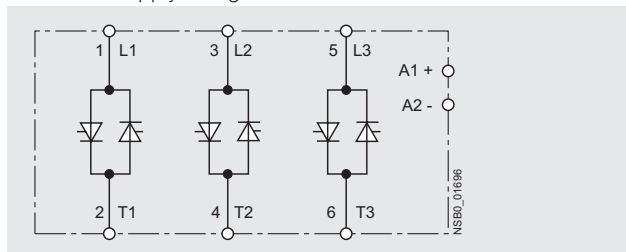

Semiconductor Relays and Contactors, Function Modules

Dimensions

Function modules for SIRIUS SC semiconductor switching devices

Converters

3RF29 00-0EA18

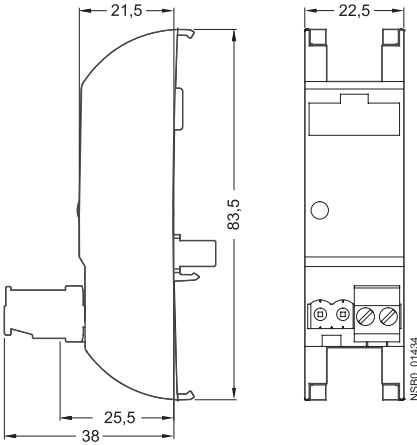

Basic load monitoring

3RF29 00-0FA08

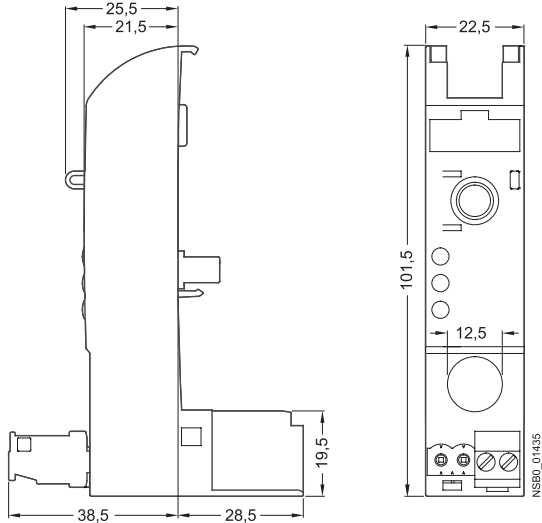

Extended load monitoring

3RF29 .0-0GA..

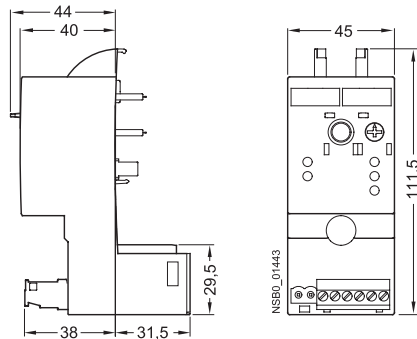

Power controllers

3RF29 .0-0HA..

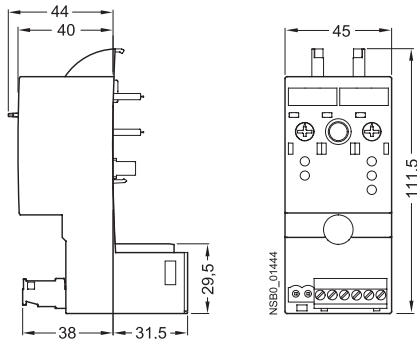

Accessories for SIRIUS SC semiconductor switching devices

Terminal cover for SIRIUS semiconductor switching devices

3RF29 00-3PA88

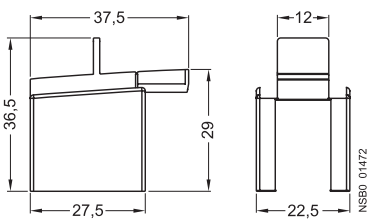

Semiconductor Relays and Contactors, Function Modules

Dimensions

SIRIUS SC semiconductor contactors

Semiconductor contactors with 10 A and 20 A type current

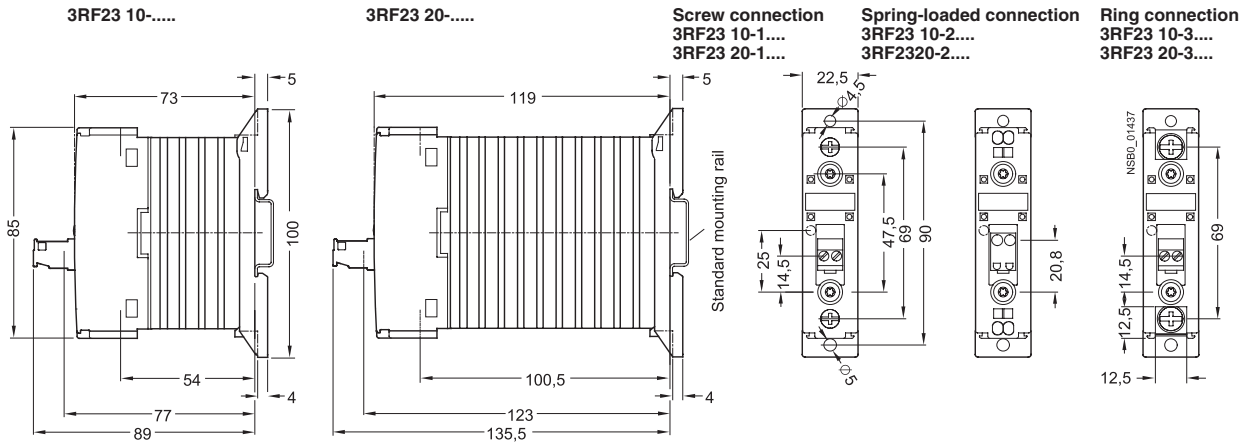

Semiconductor contactors with 30 A type current

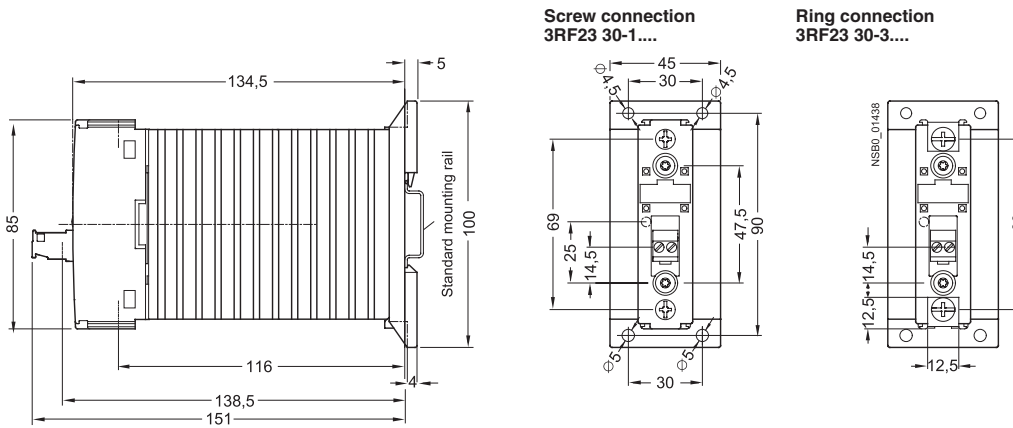

Semiconductor contactors with 40 A and 50 A type current

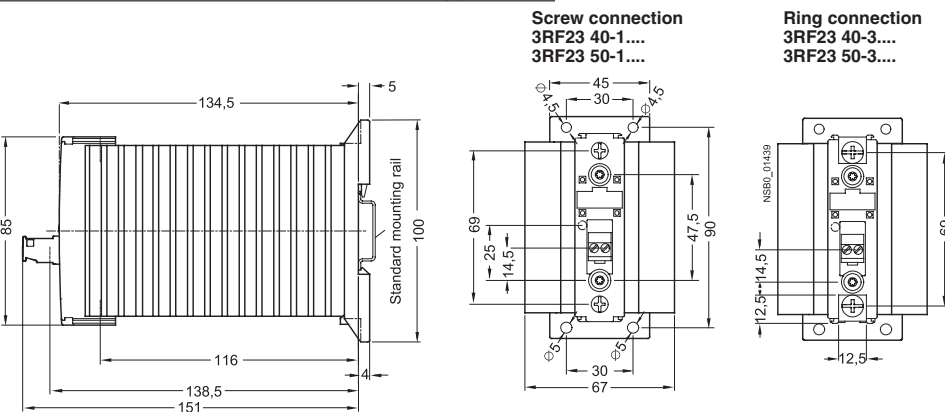

Semiconductor Relays and Contactors, Function Modules

Dimensions

Semiconductor contactors with 70 A type current

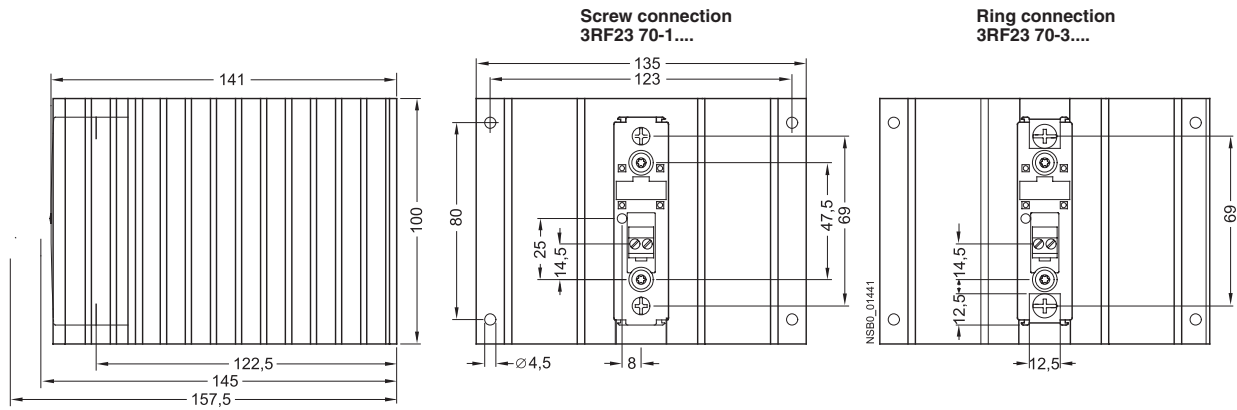

Semiconductor contactors with 88 A type current

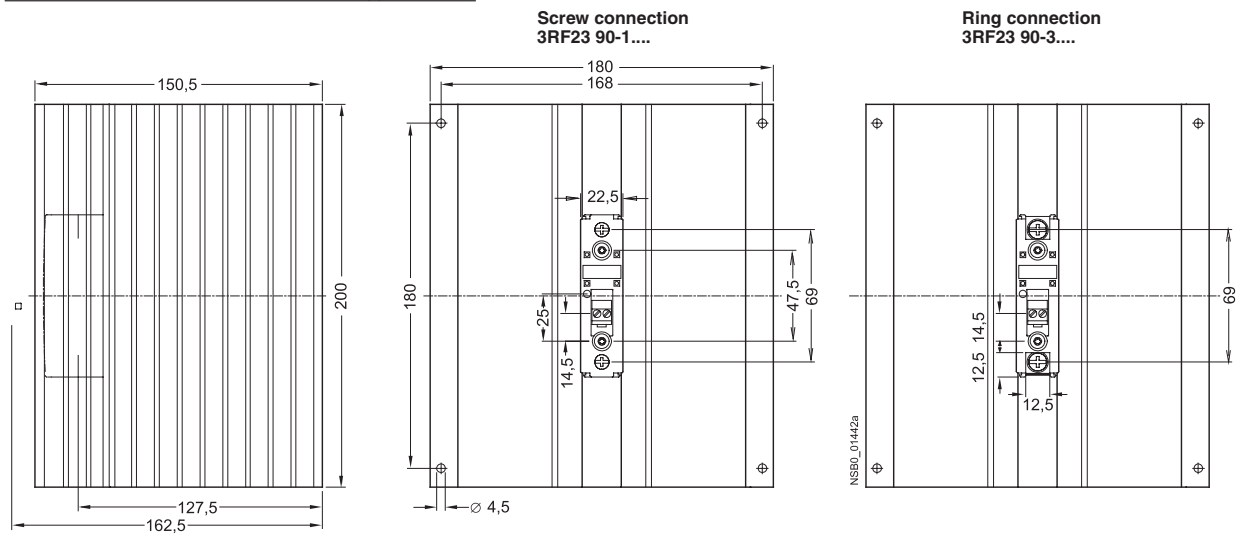

Solid-State Contactors

Dimensions

Dimensional drawings

Type current 10.5 A

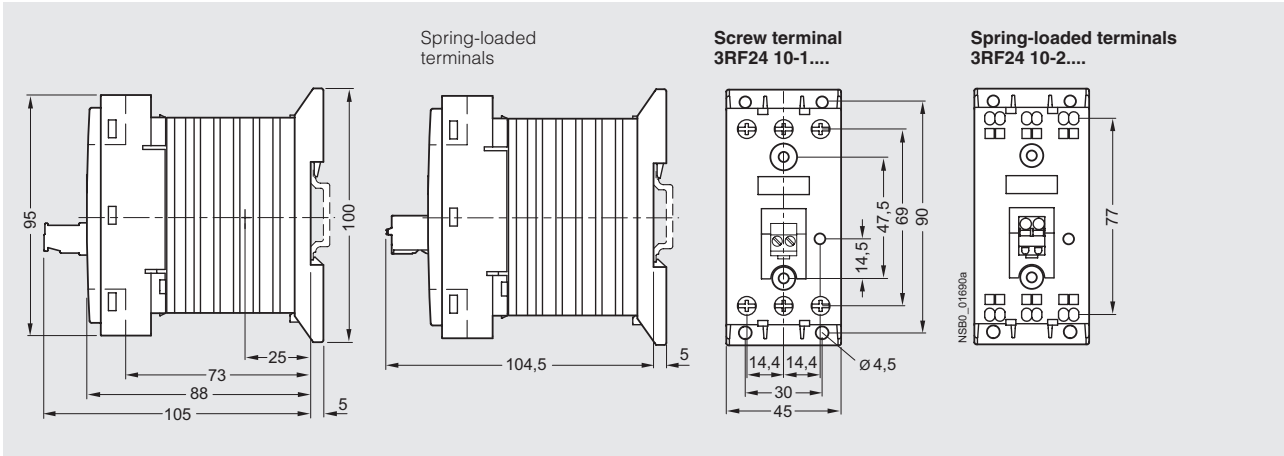

Type current 20 A; 30 A (2-phase controlled)

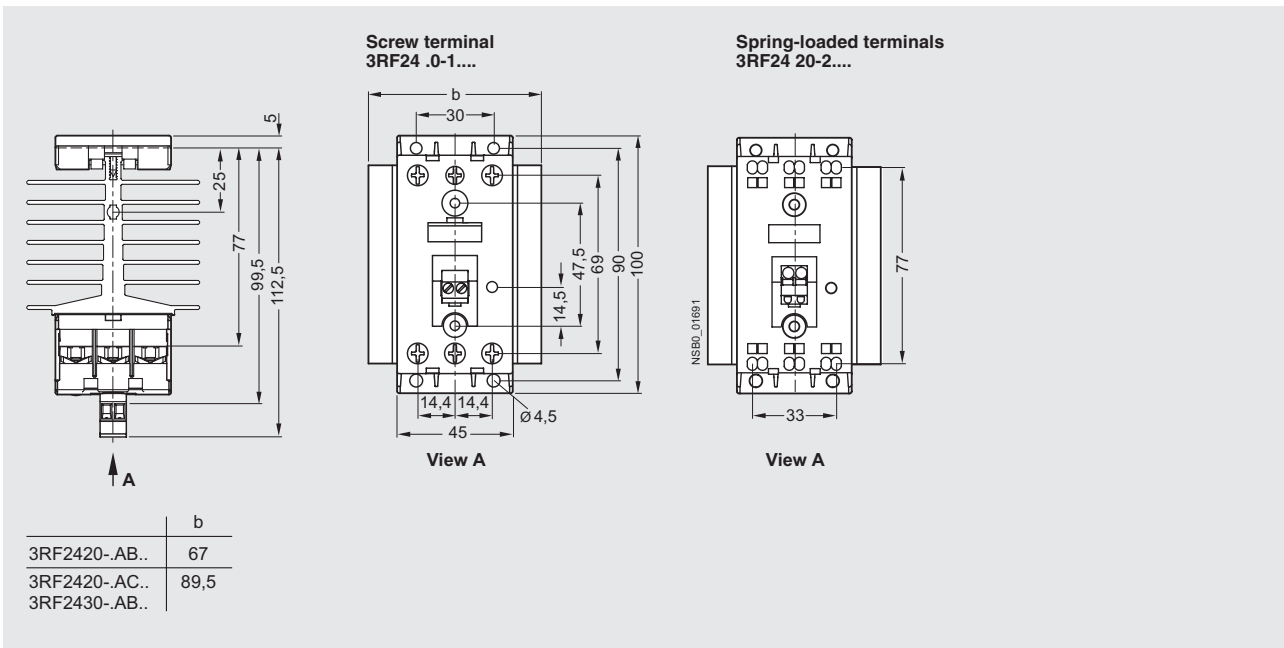

Solid-State Contactors

Dimensions

Type current 30 A (3-phase controlled); 40 A, 50 A

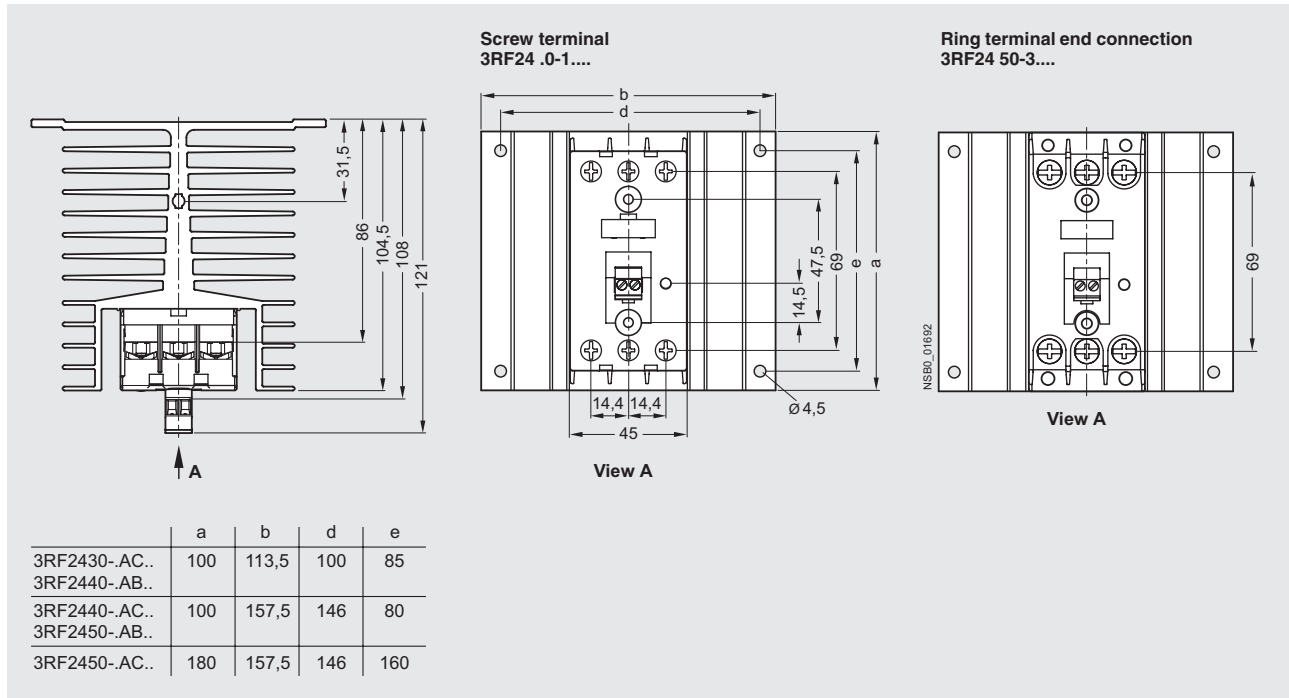

Schematics

Two-phase controlled
DC control supply voltage

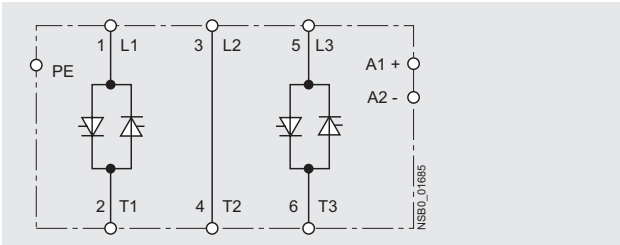

Three-phase controlled
DC control supply voltage

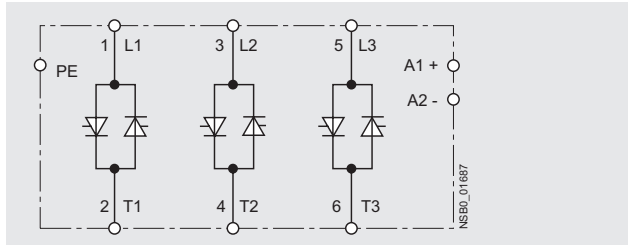

Two-phase controlled
AC control supply voltage

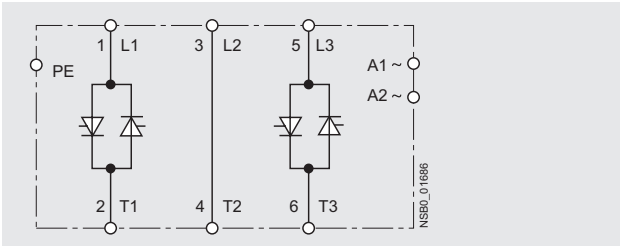

Three-phase controlled
AC control supply voltage

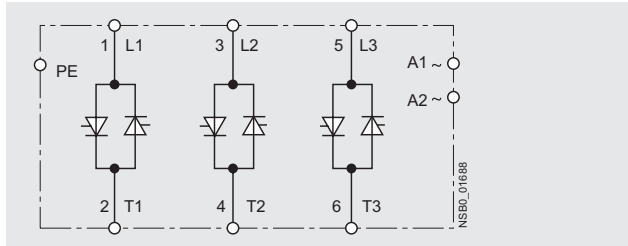

Solid-State Contactors

Dimensions

Dimensional drawings

Screw terminals

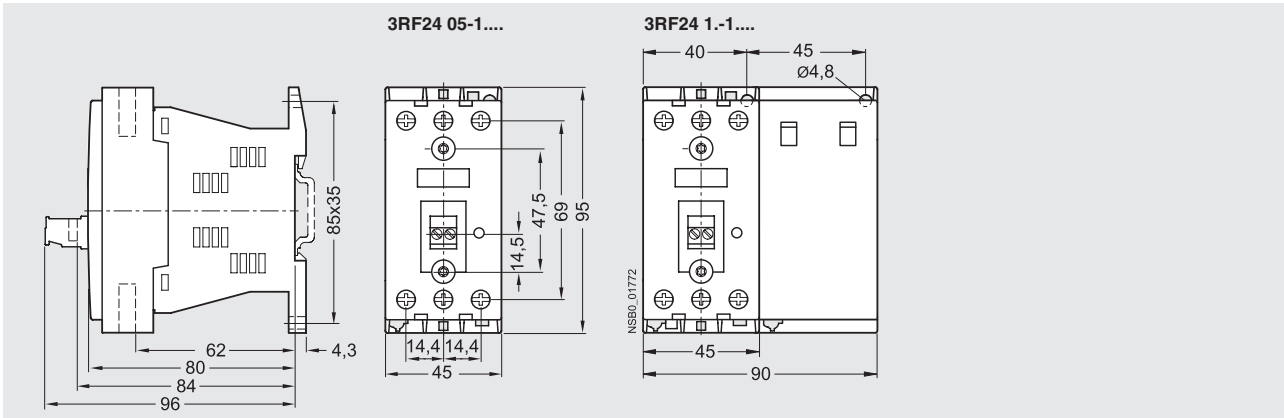

Spring-loaded terminals

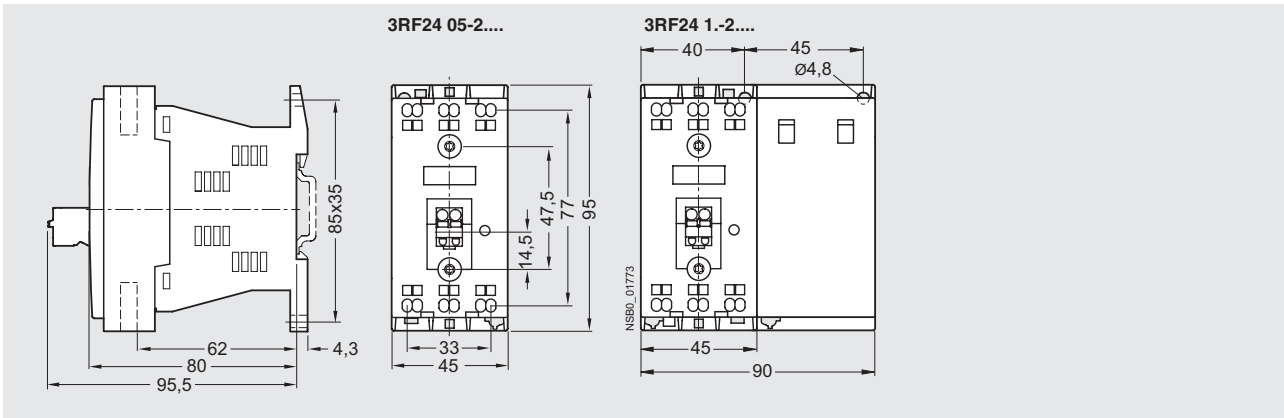

Solid-State Contactors

Dimensions

Dimensional drawings

Screw terminals

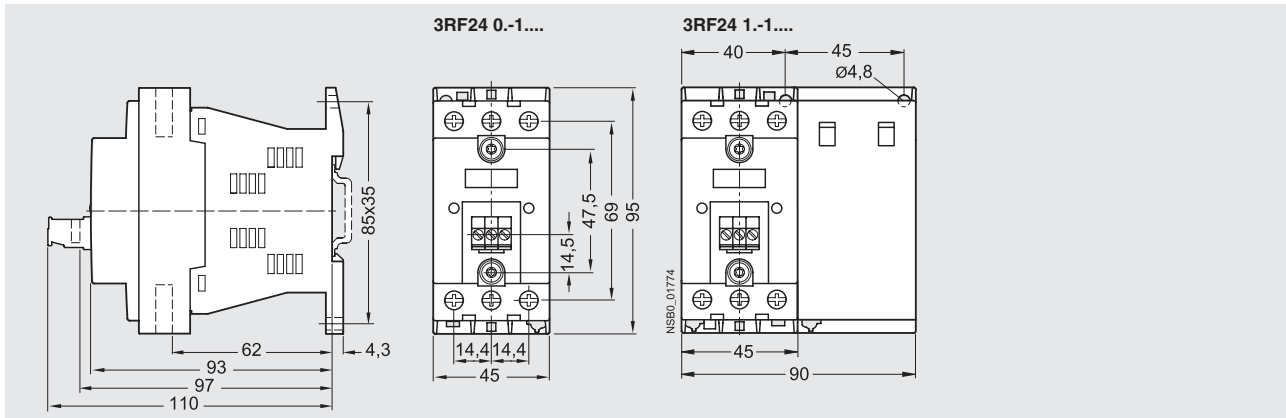

Semiconductor Relays and Contactors, Function Modules

Wiring diagrams

Circuit diagrams

SIRIUS SC semiconductor relays

DC control version

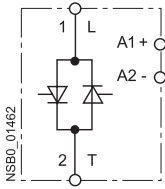

AC control version

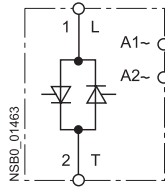

SIRIUS SC semiconductor contactors

DC control version

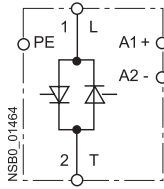

AC control version

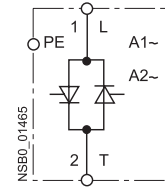

Function modules for SIRIUS SC semiconductor switching devices

Converters

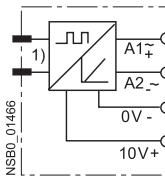

Basic load monitoring

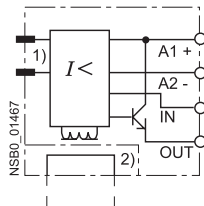

Extended load monitoring

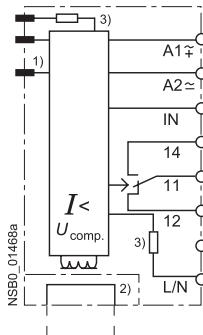

Power controllers

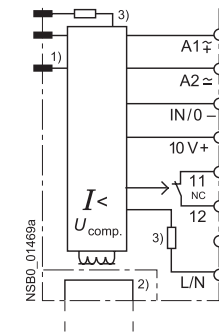

- 1) Internal connection.
- 2) Straight-through transformer.

SIRIUS SC semiconductor relays

Typical circuit diagram

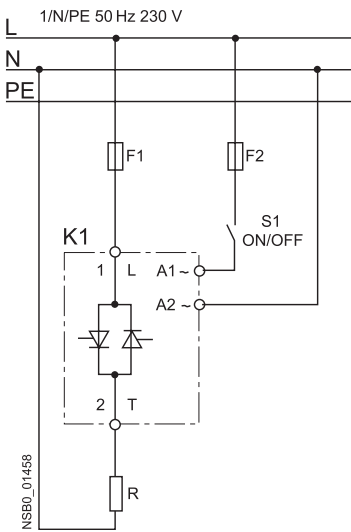

Semiconductor Relays and Contactors, Function Modules

Wiring diagrams

Function modules for SIRIUS SC semiconductor switching devices

Converters Typical circuit diagram

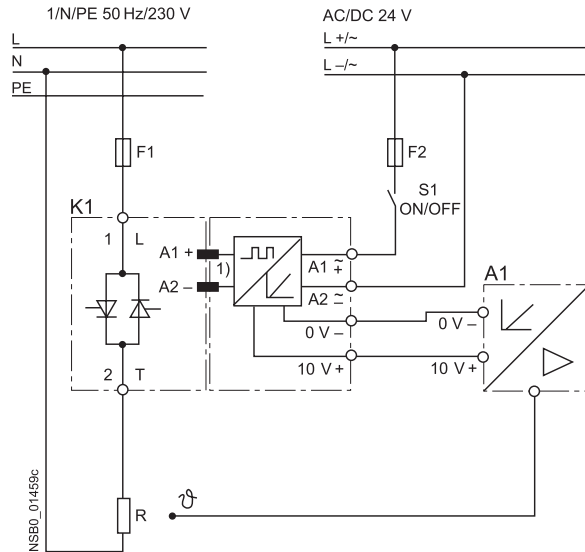

Basic load monitoring Typical circuit diagram

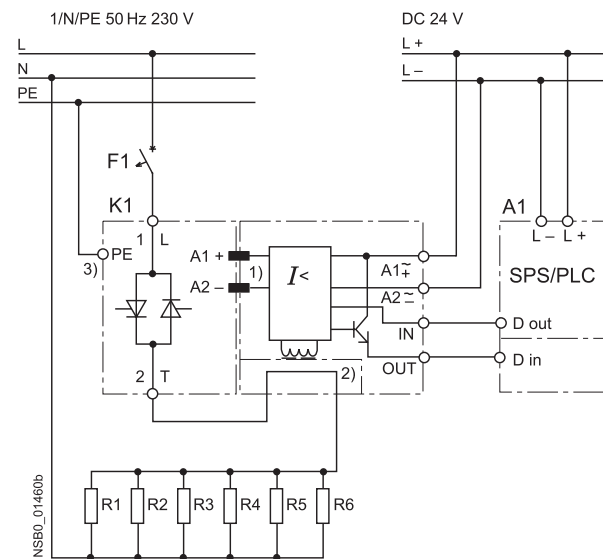

Extended load monitoring Typical circuit diagram

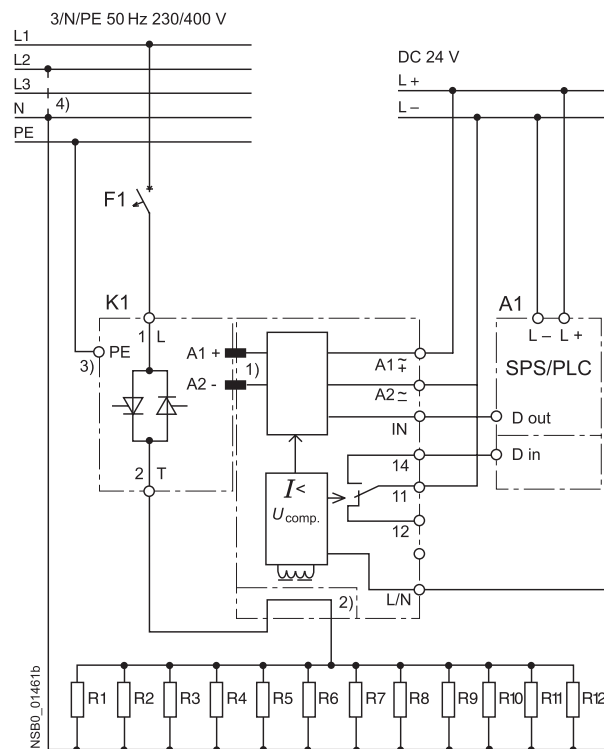

Power controllers Typical circuit diagram

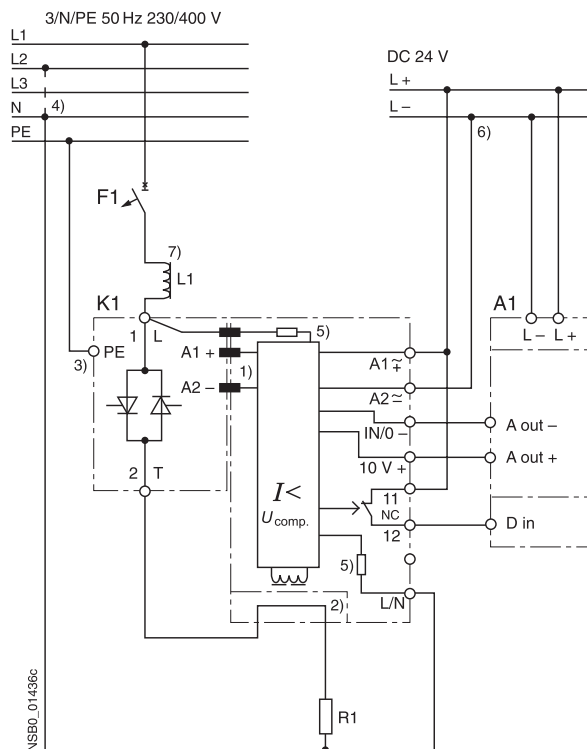

- 1) Internal connection.
- 2) Straight-through transformer.
- 3) PE/ground connection for semiconductor contactors according to installation regulations.
- 4) Connection of contact L/N to N conductor or a second phase according to the rated operational voltage of the function module.
- 5) In order to observe the limit values of the conducted interference voltage for generalized phase control, a choke rated at at least 200 μ H must be included in the load circuit.

- 1) Internal connection to the solid state relay/contactor.
- 2) Straight-through.
- 3) Make PE/ground connection according to installation regulations.
- 4) Connection of L/N contact with
 - 3RF29 ..-0GA.3 load monitoring on neutral conductor N (e.g. 230 V),
 - 3RF29 ..-0GA.6 load monitoring on a second phase (e.g. 400V).
- 5) Voltage detection not electrically isolated (3M Ω per path).
- 6) Grounding of connection L- is recommended.
- 7) A200 μ H choke must be used when operating with leading-edge phase in order to observe the limit values of the conducted interference voltage according to Class A.

Solid-State Contactors

3RF24 solid-state contactors, 3-phase

Schematics

Two-phase controlled,
DC control supply voltage

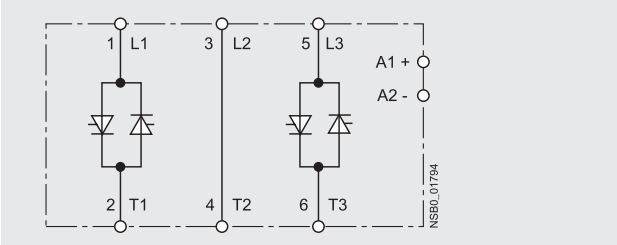

Two-phase controlled,
AC control supply voltage

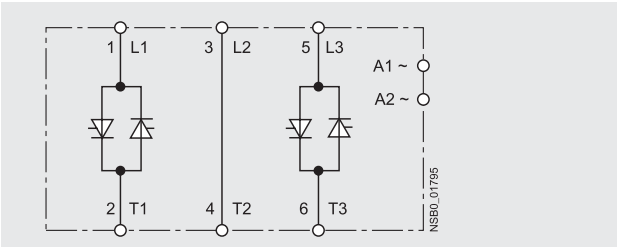

Sample schematic

