

# IO-Link

## Introduction

### Communication overview

#### Overview

IO-Link is an open communication standard for sensors and actuators – defined by the PROFIBUS User Organization (PNO). IO-Link technology is based on the point-to-point connection of sensors and actuators to the control system.

Parameter and diagnostics data are transmitted in addition to the cyclic operating data for the connected sensors/actuators. The simple, unshielded three-wire cable customary for standard sensors is used for this purpose.

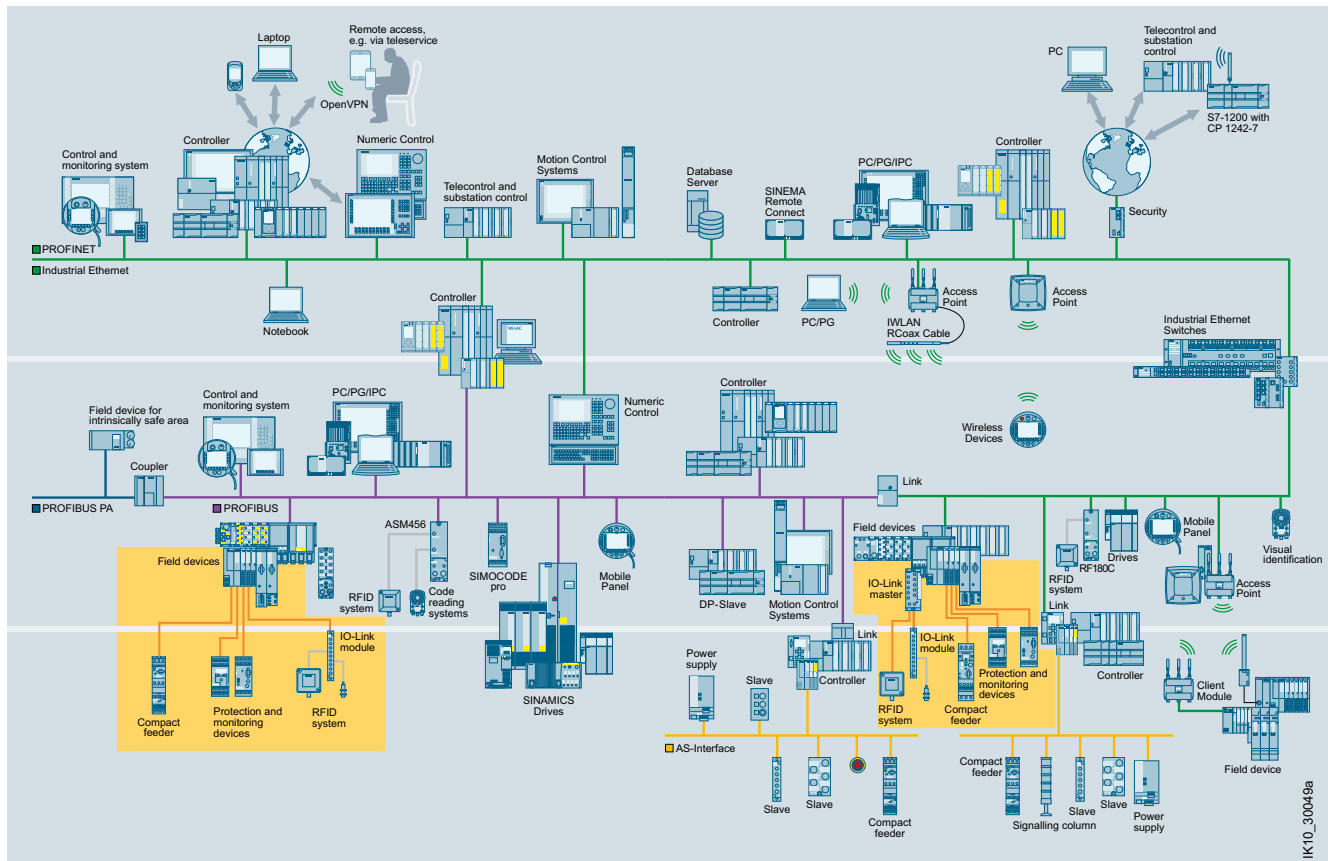

IO-Link in the SIMATIC NET communications landscape

#### Benefits

##### Engineering

- Standardized, open system for greater flexibility (non-Siemens IO-Link devices can be integrated in engineering)
- Uniform, transparent configuring and programming through integrated engineering (SIMATIC STEP 7)
- Unassigned SIMATIC function blocks for easy parameterization, diagnostics and readout of measured values
- Efficient engineering thanks to pre-integration into SIMATIC HMI
- Low error rate in CAD circuit diagram design as a result of reduced control current wiring

##### Installation and commissioning

- Faster assembly with minimized error rate as a result of reduced control current wiring
- Less space required in the control cabinet
- Low-cost circuitry where there are several feeders by making full use of existing components

##### Operation and maintenance

- High transparency in the system right down to field level and integration into power management systems
- Reduction in downtimes and maintenance times thanks to system-wide diagnostics and faster fault correction
- Support of predictive maintenance
- Shorter changeover times, even for field devices, by means of parameter and recipe management

#### Application

IO-Link can be used in the following main applications:

- Easy connection of complex IO-Link sensors/actuators with a large number of parameters and diagnostic data to the control system
- Replacement of sensor boxes for connecting binary sensors with the IO-Link input modules optimized in terms of cabling
- Optimized cable connection of switching devices to the control system
- Simple transmission of energy values from the device to the control system for integration into a user program or power management

In these cases, all the diagnostics data is transmitted to the higher-level control system through IO-Link. The parameter settings can be changed during operation.

##### Integration in STEP 7

Integration of the device configuration in the STEP 7 environment guarantees:

- Quick and easy engineering
- Consistent data storage
- Quick localization and rectification of faults

IK10\_30049a

Overview

More information

Homepage, see [www.siemens.com/io-link](http://www.siemens.com/io-link)

For important topics at a glance, see <https://support.industry.siemens.com/cs/ww/en/view/109737170>



IO-Link product family

To implement communication, a system installation has the following main components:

- An IO-Link master
- One or more IO-Link devices, such as sensors (e.g. RFID systems), actuators or combinations thereof
- A standard 3-wire sensor/actuator cable

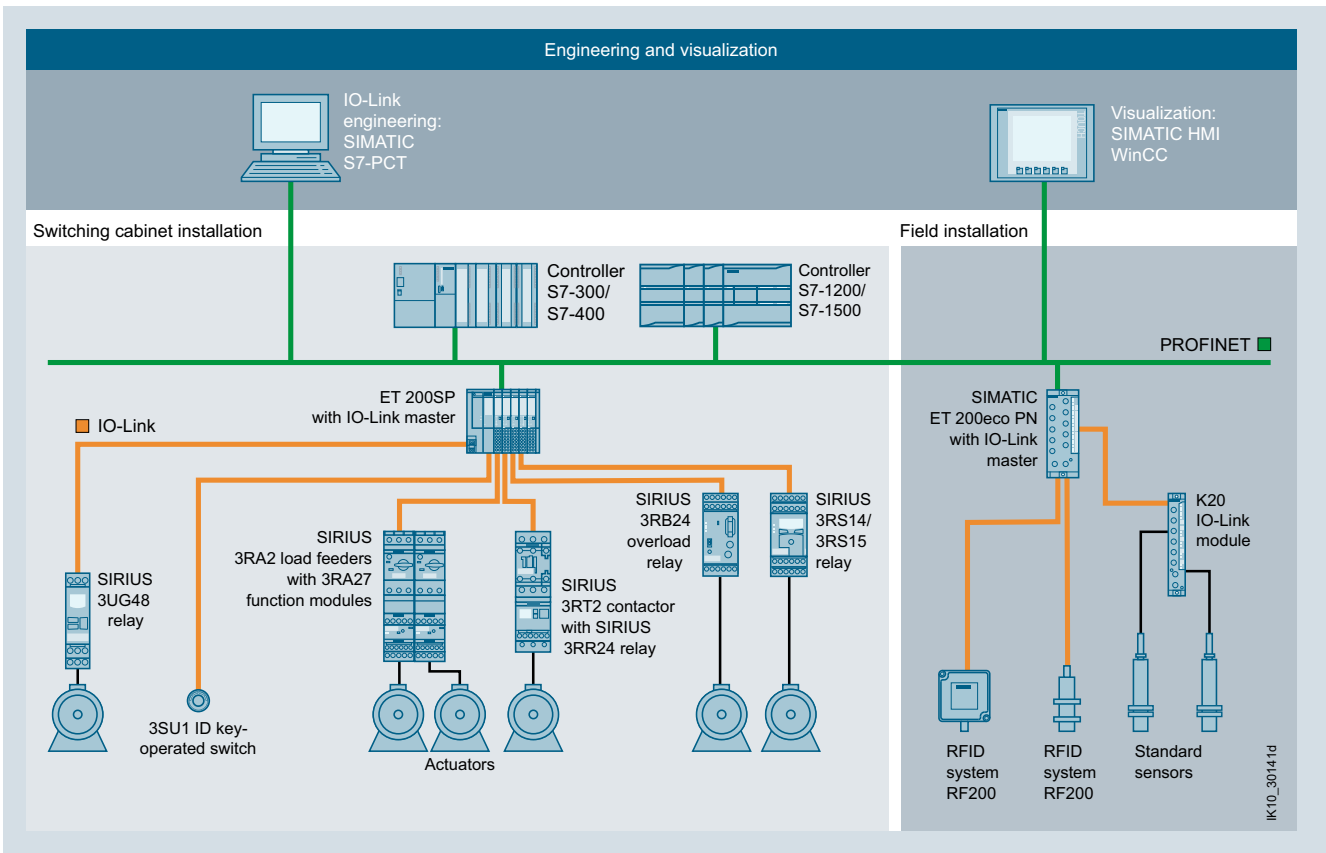

Example of a configuration with the system components



## IO-Link Introduction

### System components

#### IO-Link compatibility

IO-Link ensures compatibility between IO-Link-capable modules and standard modules as follows:

- IO-Link sensors can generally be operated both on IO-Link modules (masters) and standard input modules.
- IO-Link sensors/actuators as well as today's standard sensors/actuators can be used on IO-Link masters.
- If conventional components are used in the IO-Link system, then of course only the standard functions are available at this point.

#### Analog signals

Another advantage of IO-Link technology is that analog signals are already digitized in the IO-Link sensor itself and are digitally transmitted via IO-Link communication. As the result, faults are prevented and there is no extra cost for cable shielding.

#### Enhancement with IO-Link input modules

IO-Link compatibility also permits connection of standard sensors/actuators, i.e. conventional sensors/actuators can also be connected to IO-Link. This is particularly cost-effective with the IO-Link input modules, which allow several sensors to be connected at one time via a cable to the controller.

#### Overload relays

A starter combination, for example, consists of one or more SIRIUS 3RT contactors and one 3RB24 electronic overload relay for IO-Link plus its 3RB29 current measuring module.

3RB24 overload relays with IO-Link are basically designed to provide current-dependent protection for loads against inadmissibly high temperature rises due to overload, phase asymmetry or phase failure.

Direct-on-line starters can, therefore, as shown in the image, be connected to the control system via IO-Link without much wiring. Remote control of connected contactors, current value transmission and immediate remote fault diagnosis are just some examples of the large number of functions that can be implemented with this device.

It is also possible to directly address a drive on-site via IO-Link using the optional hand-held device.

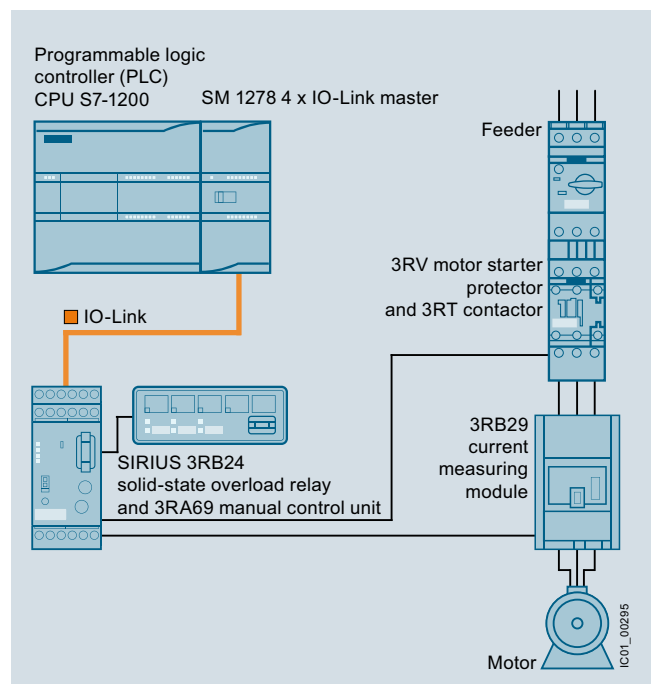

Connection of an IO-Link-capable overload relay to a SIMATIC S7-1200 controller

#### Load feeders and motor starters

Through IO-Link it is possible to control not only sensors but also actuators in the form of load feeders and motor starters.

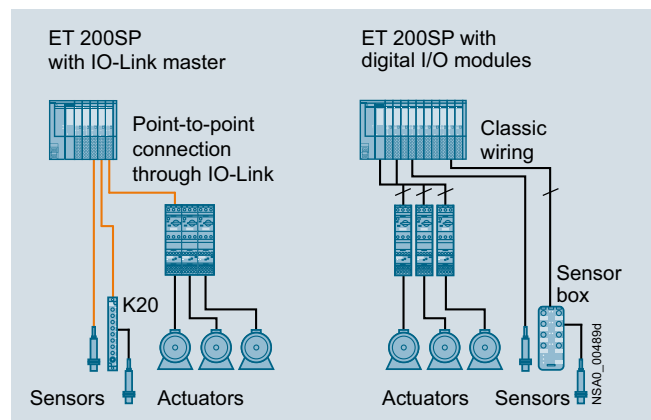

Possibilities for connecting load feeders and motor starters to IO-Link or in the conventional way

**Monitoring relays**

By using monitoring relays with IO-Link it is now possible to send data that has already been recorded and evaluated in the devices directly to the controller. This avoids the use of duplicated sensors.

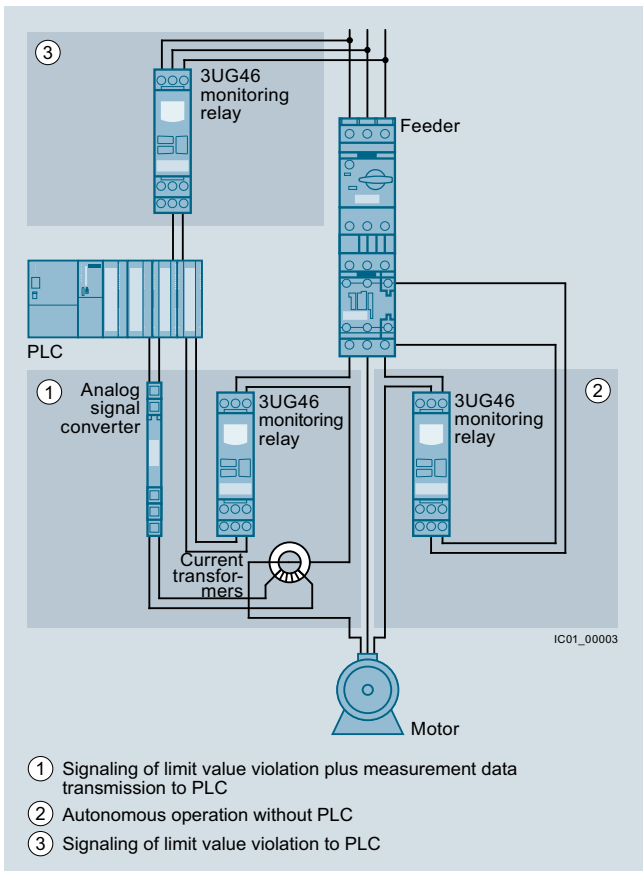

Possibilities for interfacing conventional 3UG46 monitoring relays (in comparison with 3UG48)

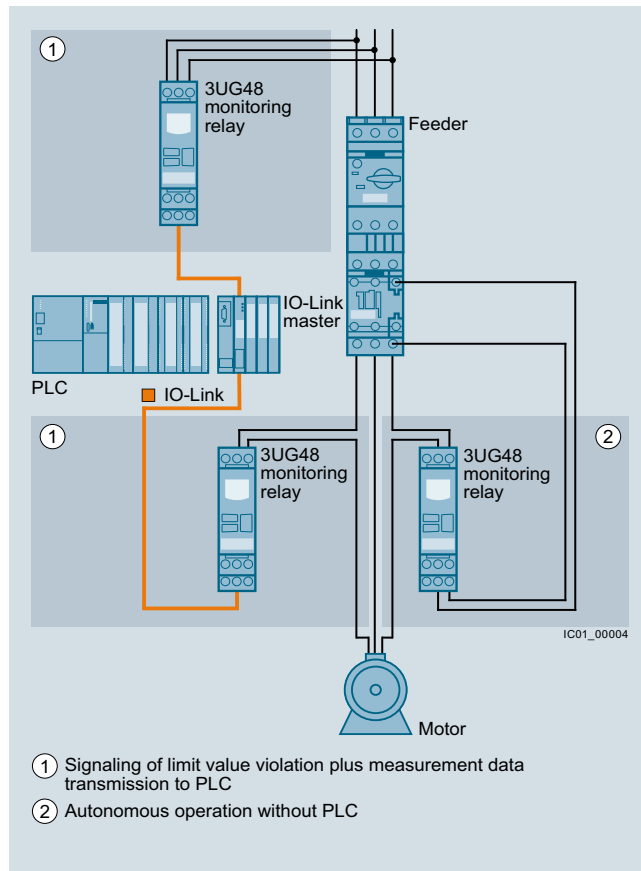

Possibilities of interfacing 3UG48 monitoring relays for IO-Link

## IO-Link Introduction

### System components

#### Wireless communication

Using an upstream IWLAN client module, such as SCALANCE W722-1 RJ45, allows IO-Link to be integrated into the PROFINET world via a distributed I/O. Possible uses include acting as an alternative to fault-prone cable carrier or collector wire technology.

The individual diagnostics options offered by the various IO-Link devices provide greater transparency for the production process. Just like the parameter data for a device, these diagnostics data can be evaluated remotely using the possibilities offered by SIMATIC. This supports remote maintenance down to the lowest level in the field.

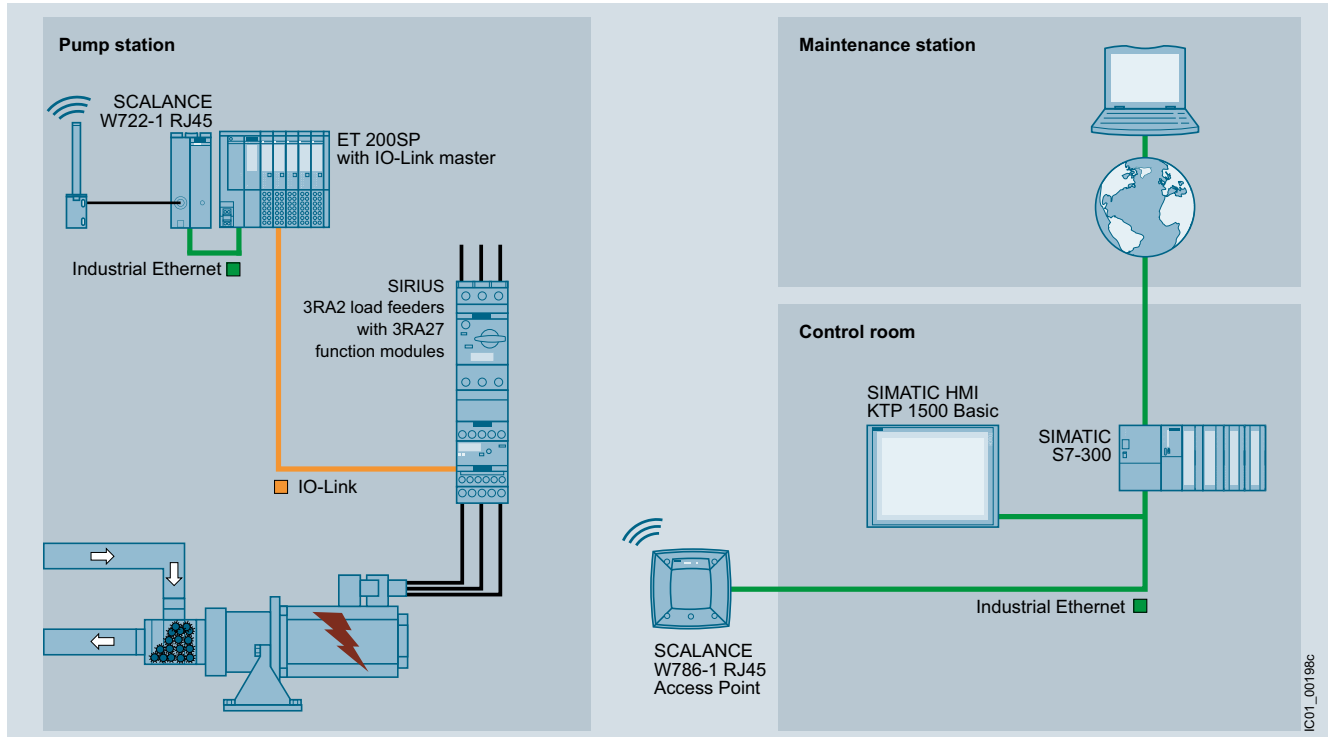

Wireless communication between Industrial Ethernet and IO-Link components

#### IO-Link components

##### IO-Link masters

###### Masters

- IO-Link master module for S7-1200
- SM 1278 4xIO-Link signal module: [see page 2/105](#)
- IO-Link master module for ET 200SP
- CM IO-Link communication module: [see page 2/106](#)
- IO-Link master module for ET 200pro
- 4 IO-Link HF electronic module [see page 2/109](#)
- IO-Link master module for ET 200eco PN
- IO-Link master 4 IO-L + 8DI + 4DO 24 V DC/1.3 A
- IO-Link master 4 IO-L

[See page 2/110](#)

IO-Link master module for ET 200AL

- CM IO-Link communication module, [see page 2/112](#)

##### IO-Link devices

###### Detection with IO-Link

###### IO-Link input modules

- K20 input module
  - 4 inputs, M12 connections
  - 8 inputs, standard M8 connections
- [See page 2/116](#)



K20 input module

##### IO-Link devices (continued)

###### Switching with IO-Link

###### Contactors and contactor assemblies

- SIRIUS 3RT contactors, 3-pole up to 250 kW, [see page 3/14 onwards](#)
- SIRIUS 3RA23 reversing contactor assemblies, up to 55 kW, [see page 3/150 onwards](#)
- SIRIUS 3RA24 contactor assemblies for wye-delta starting, up to 90 kW, [see page 3/165 onwards](#)
- SIRIUS 3RA27 function modules
- For direct-on-line, reversing, and star-delta (wye-delta) starting with IO-Link connection, [see page 3/102 onwards](#)

###### Motor starters for operation in the control cabinet

SIRIUS 3RA64, 3RA65 compact starters for IO-Link

- 3RA64 direct-on-line starters
- 3RA65 reversing starters

[See page 8/56 onwards](#)

Infeed system for 3RA6, [see page 8/78 onwards](#)

Accessories, [see page 8/70 onwards](#)

###### Contactors with IO-Link

###### Overload relays

SIRIUS 3RB24 solid-state overload relays for IO-Link

- Evaluation modules
- Current measuring modules from 0.3 to 630 A
- Controlling direct-on-line, reversing and star-delta starters via IO-Link in conjunction with contactors
- Full motor protection
- Diagnostics and current value transmission via IO-Link

[See page 7/126 onwards](#)



SIRIUS 3RA2711 function modules for IO-Link



SIRIUS 3RA64 direct-on-line starter



SIRIUS 3RB24 overload relays

IC01\_00198c

### IO-Link devices (continued)

#### Monitoring with IO-Link

##### SIRIUS 3RR24 monitoring relays for mounting onto 3RT2 contactors for IO-Link

- Monitoring of current, phase failure, open circuit and phase sequence
- Designed for mounting on 3RT2 contactors
- Terminal supports for stand-alone installation for separate mounting

See page 10/72 onwards

##### SIRIUS 3UG48 monitoring relays for stand-alone installation for IO-Link

- Monitoring network, voltage, current, power factor, residual current or speed depending on device design
- On/tripping delay time can be adjusted

See page 10/112 onwards

##### SIRIUS 3RS14, 3RS15 temperature monitoring relays for IO-Link

- Temperature monitoring with connected sensors
- Two limit values, can be adjusted separately

See page 10/146 onwards

#### Actuating and indicating with IO-Link

##### SIRIUS ACT 3SU1 ID key-operated switches for IO-Link

- Access system and selection system for four authorization levels
- Authentication of groups and persons
- Five ID keys with different coding
- Option for individual coding via IO-Link
- For installation in enclosures or fastening on front plate
- Electronic module for ID key-operated switches must be ordered separately

See page 13/10 onwards

##### SIRIUS ACT 3SU1 electronic modules for IO-Link

- Eight digital inputs and outputs possible
- DI and DQ freely selectable (programmable)
- Input and output functions parameterizable
- Connection system (push-in)
- For fastening on front plate, see page 13/94
- For installation in enclosure, see page 13/108



SIRIUS 3RR24 monitoring relays



SIRIUS 3UG48 monitoring relays



SIRIUS 3RS14 temperature monitoring relay



SIRIUS ACT 3SU1 ID key-operated switches



SIRIUS ACT 3SU1 electronic module

### IO-Link RFID systems

#### SIMATIC RF200 RFID system in the HF range

Products SIMATIC RF210R, SIMATIC RF220R, SIMATIC RF240R, SIMATIC RF250R, SIMATIC RF260R



RFID system for IO-Link

- Simple identification tasks such as reading an ID number (UID)
- Reading of user data
- Writing of user data
- No RFID-specific programming, ideal for those new to RFID
- Simple connection via master modules for IO-Link, such as SIMATIC S7-1200, ET 200SP, ET 200pro, ET 200eco PN and ET 200AL
- Use with the tried and tested ISO 15693 transponders (MDS xxx)

See Catalog ID 10 "Industrial Identification Systems"

### IO-Link Device Description (IODD)



IODD files for IO-Link

#### IODD files

These files provide the device description for IO-Link devices.

- Comprehensive IODD catalog of SIEMENS IO-Link devices
- Freely available for download from Industry Online Support, see <https://support.industry.siemens.com/cs/ww/en/ps/15851>



IODDfinder for IO-Link

#### IODDfinder **NEW**

The entire world of IO-Link under one roof

The IODDfinder is a service provided by the IO-Link community. It is a central cross-vendor database for descriptive files (IODDs). In addition, the platform provides an overview of the available IO-Link devices.

For more information, see <https://ioddfinder.io-link.com/#/>.

### IO-Link software



STEP 7 PCT

#### STEP 7 PCT (Port Configuration Tool)

Engineering software for configuring the IO-Link master modules for SIMATIC S7-1200, ET 200SP, ET 200pro, ET 200eco PN and ET 200AL

- Available as a stand-alone version or integrated into STEP 7 (V5.5 SP1 or later) and TIA (V12 or later)
- Engineering of the IO-Link devices connected to the master
- Monitoring of the process image of the IO-Link devices
- Open interface for importing further IODDs
- Freely available for download from Industry Online Support, see <https://support.industry.siemens.com/cs/ww/en/view/32469496>

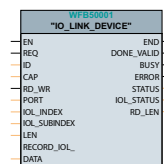

IO-Link device function block

#### IO-Link function blocks

(IO-Link device and IO-Link master)

STEP 7 function block for easy acyclical data exchange in the user program

- Freely available for download from Industry Online Support, see <https://support.industry.siemens.com/cs/ww/en/view/82981502>

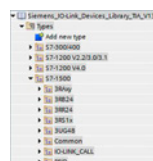

"Siemens IO-Link Devices" function block library

#### "Siemens IO-Link Devices" function block library

This library provides function blocks and user-defined data types (UDTs) for all IO-Link devices from the Siemens portfolio. These blocks and UDTs standardize and simplify communication with IO-Link devices.

- Freely available for download from Industry Online Support, see <https://support.industry.siemens.com/cs/ww/en/view/90629409>



## IO-Link Introduction

### IO-Link Specification

#### Overview

##### Principles of the IO-Link specification

According to the IO-Link specification, communication functions as follows:

- Transmission takes place via an unshielded three-wire cable no more than 20 m long, of the kind normally used for standard sensors
- Digital communication from 0 to 24 V on the so-called C/Q cable
- Most of the values transmitted are measured values from the sensors
- The sensors and actuators are described by the IO Device Description (IODD)
- As a matter of principle, one IO-Link device can be connected to one IO-Link port of the master (point-to-point connection)
- The transmission rates between IO-Link master and the devices are as follows:
  - Via COM1: 4 800 Bd
  - Via COM2: 38 400 Bd
  - Via COM3: 230 400 Bd
- The average cycle time is 2 ms for the reading/writing of 16 data bits at a transmission rate of 38 400 Bd

##### IO-Link protocol

The IO-Link protocol supports both the Standard IO mode (SIO) and the IO-Link communication mode (COM).

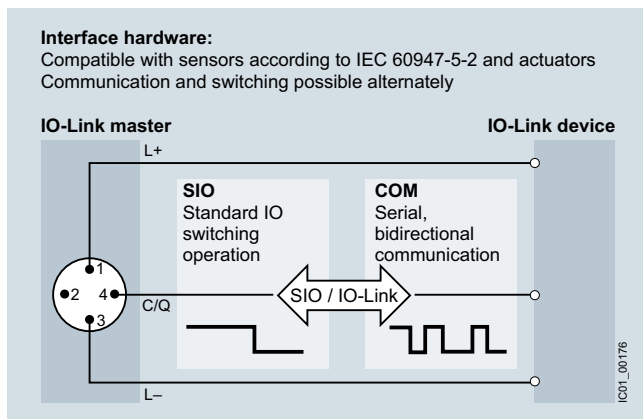

The structure of the protocol and its message frames depends on the types of data to be transmitted.

##### Data types

The IO-Link specification makes a distinction between the following data types:

##### Process data

The process data of the devices are transferred cyclically in a data frame, with the process data width defined by the device. Process data of 0 to 32 bytes are possible per device (input and output in each case). The consistency width of the transmission is not fixed and therefore depends on the master.

##### Value status

Each port has a value status (PortQualifier). The value status indicates whether the process data are valid or invalid. The value status can be transferred cyclically with the process data.

##### Device data

Device data can be parameters, identification data and diagnostics information. Device data replacement is acyclic and in response to an inquiry from the IO-Link master. Device data can be written into the device (Write) and also read from the device (Read).

##### Events

When an event occurs, the device sends a signal to the master to report that an event is active. The master then reads out the event. Events can be fault messages (e.g. short-circuit) and warnings/maintenance data (e.g. contamination, overheating). Fault messages are transferred from the device via the IO-Link master to the controller or HMI. The IO-Link master can also transfer events and states. Events include, for example, cable break or communication breakdown.

Device parameters and events are sent independently of the cyclic transmission of process data. The transmissions do not affect or impair each other.

##### Data storage

As of Specification V1.1, a data storage concept has been created for IO-Link. In this concept, the IO-Link device initiates storage of its data on a higher-level parameter server. In the event that a device is replaced, the parameter server can restore the original parameterization. It is therefore possible to replace the devices without re-parameterization.

The IO-Link master contains the parameter server. The parameter server can also be implemented centrally in the PLC or in a system server. In this case the data must be downloaded to the control system by means of the function blocks provided.

##### IO-Link masters

The IO-Link master is the interface to higher-level control systems. The IO-Link master presents itself to the fieldbus as a normal fieldbus node, and is integrated into the appropriate network configurator via the relevant device description (GSD file).

##### IO Device Description (IODD)

The IO Device Description (IODD) has been defined to provide a full, transparent description of system characteristics as far as the IO-Link device.

The IODD contains information on communication characteristics, device parameters, identification, process and diagnostics data, and is supplied by the manufacturer. The design of the IODD is the same for all devices from all manufacturers, and is always presented in the same way by the IODD Interpreter Tools. This therefore ensures that the handling is the same for all IO-Link devices, whatever the manufacturer.

##### New in IO-Link Specification V1.1

The IO-Link Specification is currently available in Version 1.1, and standardized in accordance with IEC 61131-9.

Specification V1.1 offers the following new features compared with the previous Specification V1.0:

- Transmission of up to 32 bytes of process data in one cycle
- Parameter server function

### Overview



SM 1278 4xIO-Link master

Module for connecting up to four IO-Link devices in accordance with the IO Link specification V1.1. The IO-Link parameters are configured by means of the Port Configuration Tool (PCT) with version V3.2 and higher.

### Application

The SM 1278 module enables an exchange of data with up to four external IO Link devices through one three-wire cable each or four standard actuators or standard encoders. Control can be flexibly adapted to the communication partners using the comprehensive parameter assignment options. Since IO-Link is compatible with standard sensors, commercially available sensors compliant with IEC 61131 Type 1 can also be operated on the IO-Link master.

### Design

- Expansion limits
  - Cable length: Max. 20 m
  - Max. 32 bytes of input data and 32 bytes of output data per port
  - Max. 32 bytes of input data and 32 bytes of output data per module

#### LED displays

- DIAG: Operating state display (green/red) of the module
- C1..C4: Port status display (green) for ports 1, 2, 3 and 4
- Q1..Q4: Channel status display (green) for ports 1, 2, 3 and 4
- F1..F4: Port error display (red) for ports 1, 2, 3 and 4

Depending on the CPU type used, up to 8 SM 1278 units can be used on one S7-1200 CPU.

### Function

#### Supported functions

- I&M identification data
- Firmware update
- SIO Mode (standard IO mode)
- IO-Link parameter assignment with the S7-PCT interface configuration tool, TIA V13 or higher and an S7-1200 CPU V4.0 or higher

#### Supported data transmission rates

- COM1 (4.8 kBd)
- COM2 (38.4 kBd)
- COM3 (230.4 kBd)

### Selection and ordering data

Version	SD	Article No.	Price per PU	PU (UNIT, SET, M)	PS*	PG
d						



6ES7278-4BD32-0XB0

#### SM 1278 4xIO-Link master signal module

For connecting up to four IO-Link devices in accordance with the IO Link Specification V1.1

1		<b>6ES7278-4BD32-0XB0</b>		1	1 unit	212
---	--	---------------------------	--	---	--------	-----

### Accessories

Version	SD	Article No.	Price per PU	PU (UNIT, SET, M)	PS*	PG
d						

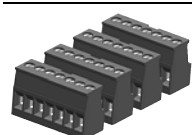

6ES7292-1AG30-0XA0

#### Terminal block (spare part)

With 7 screws, zinc-plated; 4 units

1		<b>6ES7292-1AG30-0XA0</b>		1	4 units	212
---	--	---------------------------	--	---	---------	-----



# IO-Link Masters IO-Link Master Module for ET 200SP

## CM 4xIO-Link

### Overview



CM 4x IO-Link communication module

- Serial communication module for connecting up to four IO-Link devices in accordance with the IO Link specification V1.0 and V1.1. The IO-Link parameters are configured by means of the Port Configuration Tool (PCT) with version V3.0 and higher.
- Time-based IO ensures that signals are output with a precisely defined response time. By combination of inputs and outputs, products passing by, for example, can be measured exactly or liquids can be perfectly dosed.
- Supported data transmission rates
  - COM1 (4.8 kBd)
  - COM2 (38.4 kBd)
  - COM3 (230.4 kBd)
- Expansion limits
  - Cable length: Max. 20 m
  - Max. 32 bytes of input data and 32 bytes of output data per port
  - Max. 144 bytes of input data and 128 bytes of output data per module
- ET 200SP system functions supported
  - Exchange of IO-Link device parameters (V1.1 devices only) and of IO-Link master parameters without a PG including automatic backup recovery without an engineering tool by means of redundant parameter storage on the e-coding element
  - Reparameterization during ongoing operation
  - I&M identification data
  - Firmware update
  - PROFlenergy
- Can be plugged onto type A0 BaseUnits (BU) with automatic e-coding
- LED displays
  - DIAG: Operating state display (green/red) of the module
  - C1..C4: Port status display (green) for ports 1, 2, 3 and 4
  - Q1..Q4: Channel status display (green) for ports 1, 2, 3 and 4
  - F1..F4: Port error display (red) for ports 1, 2, 3 and 4
  - PWR: Supply voltage display (green)
- Informative front-side module inscription
  - Plain-text marking of the module type and function class
  - 2D matrix code (article number and serial number)
  - Connection diagram
  - CM module class color coding: Silver
  - Hardware and firmware version
  - Complete Article No.
- Optional accessories
  - Labeling strips
  - Reference identification label
  - Color-coded label with color code CC04
- Optional system-integrated shield connection

### CM 4xIO-Link overview

Communication module	Article number	CC code	BU type	P. unit
CM 4xIO-Link	6ES7137-6BD00-0BA0	CC04	A0	1

### Overview of BaseUnits

BaseUnit	Article number	CC codes for process terminals	CC codes for AUX terminals	P. unit
<b>BU type A0</b> • New load group (light) • 16 process terminals • With 10 AUX terminals	6ES7193-6BP20-0DA0	CC01 to CC05	CC71 to CC73	1
<b>BU type A0</b> • New load group (light) • 16 process terminals • With 10 AUX terminals	6ES7193-6BP20-2DA0	CC01 to CC05	CC71 to CC73	10
<b>BU type A0</b> • New load group (light) • 16 process terminals • Without AUX terminals	6ES7193-6BP00-0DA0	CC01 to CC05	--	1
<b>BU type A0</b> • New load group (light) • 16 process terminals • Without AUX terminals	6ES7193-6BP00-2DA0	CC01 to CC05	--	10
<b>BU type A0</b> • Load group forwarding (dark) • 16 process terminals • With 10 AUX terminals	6ES7193-6BP20-0BA0	CC01 to CC05	CC71 to CC73	1
<b>BU type A0</b> • Load group forwarding (dark) • 16 process terminals • With 10 AUX terminals	6ES7193-6BP20-2BA0	CC01 to CC05	CC71 to CC73	10
<b>BU type A0</b> • Load group forwarding (dark) • 16 process terminals • Without AUX terminals	6ES7193-6BP00-0BA0	CC01 to CC05	--	1
<b>BU type A0</b> • Load group forwarding (dark) • 16 process terminals • Without AUX terminals	6ES7193-6BP00-2BA0	CC01 to CC05	--	10

### Application

- The CM 4x IO-Link communication module enables an exchange of data with up to 4 external IO-Link devices through one three-wire cable each.
- Control can be flexibly adapted to the communication partners using the comprehensive parameter assignment options.
- Since IO-Link is compatible with standard sensors, commercially available sensors compliant with IEC 61131 Type 1 can also be operated on the IO-Link master.

### Design

#### Supported BaseUnits (BU)

All BUs of the A0 type are available for the CM 4x IO-Link communication module.

#### Load group formation

A light BU isolates the self-establishing internal voltage buses (P1, P2, AUX), thus opening a new load group. A load group's supply voltage must be fed in on this load group's light BU.

A dark BU passes on the supply voltage of the adjacent light BU on the left through the self-establishing voltage buses P1, P2 and AUX. Therefore, a supply again is only necessary at the following light BU on the right. Setting of a further light BU is always necessary if

- a new load group is to be formed (for example, to isolate the supply voltage from module groups) or
- the maximum simultaneously required current of the load group exceeds the permissible limit of 10 A.

#### Color coding of terminals

The potentials at the terminals of the BaseUnit are defined by the inserted I/O module. To avoid wiring errors, the terminals' potentials can be optionally identified by module-specific color-coded labels. The color-coded label matching the relevant I/O module is defined by the I/O module's color code CCxx. This color code is also printed onto the front of the module.

The color-coded label with the color code CC04 must be used for the "CM 4x IO-Link" communication module.

In the case of BaseUnits with the additional ten internally jumpered AUX terminals, these can also be color-coded with color-coded labels. Color-coded labels are available in red, blue and yellow-green for the ten AUX terminals.

### Labeling

#### Labeling strips

Labeling strips can be inserted into the front of the interface or I/O modules and can be labeled individually via STEP 7, macros, etc. A special additional support is not required. They can be replaced easily with the component as necessary.

#### Reference identification labels

Reference identification labels enable easy equipment identification (e.g. in accordance with EN 81346). They are simply plugged onto the required component (interface module, I/O modules and BaseUnits) and can thus be replaced easily with the component, whenever required.

The following labeling components are available for selection:

- Film labeling strips, light gray, roll with 500 strips, pre-perforated, for thermal transfer roll printer
- Film labeling strips, yellow, roll with 500 strips, pre-perforated, for thermal transfer roll printer
- Cardboard labeling strips (180 g/m<sup>2</sup>), light gray, ten A4 sheets of 100 strips each, pre-perforated, for laser printer
- Cardboard labeling strips (180 g/m<sup>2</sup>), yellow, ten A4 sheets of 100 strips each, pre-perforated, for laser printer
- Reference identification labels, white, ten mats of 16 plates each, for thermal transfer card printer or labels

#### System-integrated shield connection

A shield terminal that can be fitted quickly and easily is available for space-saving and EMC-optimized connection of cable shields. It consists of a shield connection element and a shield terminal that can be plugged onto the BaseUnit for each module. Low-impedance connection to functional ground (DIN rail) is carried out by the user without additional wiring

### Selection and ordering data

Version	SD	Article No.	Price per PU	PU (UNIT, SET, M)	PS*	PG
	d					
	15	<b>6ES7137-6BD00-0BA0</b>		1	1 unit	255
<p><b>CM 4xIO-Link V1.1 Standard communication module</b></p> <ul style="list-style-type: none"> <li>• Serial communication module for connecting up to 4 IO-Link devices, time-based IO, BU type A0, color code CC04</li> </ul>						

6ES7137-6BD00-0BA0

# IO-Link Masters IO-Link Master Module for ET 200SP

## CM 4xIO-Link

### Accessories

Version	SD	Article No.	Price per PU	PU (UNIT, SET, M)	PS*	PG
	d					

#### Accessories

##### Usable type A0 BaseUnits



6ES7193-6BP20-0DA0

##### BU15-P16+A10+2D

BU type A0; BaseUnit (light) with 16 process terminals (1...16) to the module and additionally 10 internally jumpered AUX terminals (1 A to 10 A); for beginning a new load group (max. 10 A)

- 1 unit
- 10 units

1	<b>6ES7193-6BP20-0DA0</b>	1	1 unit	255
1	<b>6ES7193-6BP20-2DA0</b>	1	10 units	255



6ES7193-6BP00-0DA0

##### BU15-P16+A0+2D

BU type A0; BaseUnit (light) with 16 process terminals to the module; for beginning a new load group (max. 10 A)

- 1 unit
- 10 units

1	<b>6ES7193-6BP00-0DA0</b>	1	1 unit	255
1	<b>6ES7193-6BP00-2DA0</b>	1	10 units	255



6ES7193-6BP20-0BA0

##### BU15-P16+A10+2B

BU type A0; BaseUnit (dark) with 16 process terminals (1...16) to the module and additionally 10 internally jumpered AUX terminals (1 A to 10 A); for load group continuation

- 1 unit
- 10 units

1	<b>6ES7193-6BP20-0BA0</b>	1	1 unit	255
1	<b>6ES7193-6BP20-2BA0</b>	1	10 units	255



6ES7193-6BP00-0BA0

##### BU15-P16+A0+2B

BU type A0; BaseUnit (dark) with 16 process terminals to the module; for load group continuation

- 1 unit
- 10 units

1	<b>6ES7193-6BP00-0BA0</b>	1	1 unit	255
1	<b>6ES7193-6BP00-2BA0</b>	1	10 units	255

##### Reference identification label

10 sheets of 16 labels, for printing with thermal transfer card printer or plotter

1	<b>6ES7193-6LF30-0AW0</b>	1	10 units	255
---	---------------------------	---	----------	-----

##### Labeling strips

500 labeling strips on roll, light gray, for inscription with thermal transfer roll printer

1	<b>6ES7193-6LR10-0AA0</b>	1	1 unit	255
---	---------------------------	---	--------	-----

500 labeling strips on roll, yellow, for inscription with thermal transfer roll printer

1	<b>6ES7193-6LR10-0AG0</b>	1	1 unit	255
---	---------------------------	---	--------	-----

1 000 labeling strips DIN A4, light gray, card, perforated, for inscription with laser printer

1	<b>6ES7193-6LA10-0AA0</b>	1	1 unit	255
---	---------------------------	---	--------	-----

1 000 labeling strips DIN A4, yellow, card, perforated, for inscription with laser printer

1	<b>6ES7193-6LA10-0AG0</b>	1	1 unit	255
---	---------------------------	---	--------	-----

##### Color-coded labels

Color code CC04, for 16 push-in terminals, BU type A0, A1, gray (terminals 1 to 8), red (terminals 9 to 12), blue (terminals 13 to 16); 10 units

1	<b>6ES7193-6CP04-2MA0</b>	1	10 units	255
---	---------------------------	---	----------	-----

Color code CC71, for 10 AUX terminals, BU type A0, yellow/green (terminals 1 A to 10 A); 10 units

1	<b>6ES7193-6CP71-2AA0</b>	1	10 units	255
---	---------------------------	---	----------	-----

Color code CC72, for 10 AUX terminals, BU type A0, red (terminals 1 A to 10 A); 10 units

1	<b>6ES7193-6CP72-2AA0</b>	1	10 units	255
---	---------------------------	---	----------	-----

Color code CC73, for 10 AUX terminals, BU type A0, blue (terminals 1 A to 10 A); 10 units

1	<b>6ES7193-6CP73-2AA0</b>	1	10 units	255
---	---------------------------	---	----------	-----

#### Spare parts

##### Electronic coding element type H

Pack containing 5 units; included in the scope of supply of the CM 4x IO-Link module

1	<b>6ES7193-6EH00-1AA0</b>	1	5 units	256
---	---------------------------	---	---------	-----

### Overview



4 IO-Link HF electronic module

- 45-mm-wide 4 IO-Link HF electronic module
- 4 IO-Link ports acc. to IO Link Specification V1.1
- Port class B
- The IO-Link parameters are configured using the Port Configuration Tool (S7-PCT), version V3.4 and higher

### Application

The 4 IO-Link HF electronic module enables the exchange of data with up to 4 IO-Link devices.

Since IO-Link is compatible with standard sensors, commercially available sensors compliant with IEC 61131 Type 1 can also be operated on the IO-Link master.

### Design

The 4 IO-Link HF electronic module is used together with the CM IO-LK 4 X M12 P connection module. Sensors and actuators are integrated using commercially available 3- or 5-pin M12 connectors on the CM IO-LINK 4 X M12 P.

IO-Link devices (e.g. sensors) with a class A port are interconnected by means of a 3-wire cable. IO-Link devices that require an additional supply voltage and have a class B port (e.g. actuators) are interconnected by means of a 5-wire cable.

### Selection and ordering data

Version	SD	Article No.	Price per PU	PU (UNIT, SET, M)	PS*	PG
d						
 <b>4 IO-Link HF electronic module</b>	1	<b>6ES7147-4JD00-0BA0</b>		1	1 unit	250
<ul style="list-style-type: none"> <li>• 4 IO-Link ports acc. to IO-Link Specification V1.1</li> <li>• Port class B</li> <li>• High Feature</li> <li>• Channel diagnostics</li> <li>• Including bus module</li> <li>• Connection module must be ordered separately</li> </ul>						

6ES7147-4JD00-0BA0

### Accessories

Version	SD	Article No.	Price per PU	PU (UNIT, SET, M)	PS*	PG
d						
<b>CM IO-LINK 4 X M12 P connection module</b>	1	<b>6ES7194-4CA20-0AA0</b>		1	1 unit	250
4 M12 sockets for connection of IO-Link devices to ET 200pro 4 IO-Link HF electronic module						
<b>Module labeling plates</b>	1	<b>6ES7194-4HA00-0AA0</b>		1	500 units	250
For color coding of CM IOs in the colors white, red, blue and green; pack of 100						
<b>M12 sealing caps</b>	▶	<b>3RX9802-0AA00</b>		100	10 units	42C
For protection of unused M12 terminals on ET 200pro						

# IO-Link Masters

## IO-Link Master Module for ET 200eco PN

### ET 200eco PN IO-Link master

#### Overview



ET 200eco PN IO-Link master modules

The ET200eco PN IO-Link master modules belong to the ET 200eco PN compact block I/O device family and are distinguished by the following features:

- Compact block I/O devices for connection of IO-Link devices and connection to the PROFINET bus system
- Design without a control cabinet in IP67 degree of protection with M12 connection system
- Very rugged and resistant encapsulated metal enclosure
- Compact module in an enclosure width of 30 mm or 60 mm
- PROFINET connection: 2 x M12 and automatic PROFINET addressing
- 100 MBit/s data transmission rate
- LLDP neighborhood detection without PG
- Supply and load voltage connection: 2 x M12
- Channel-exact diagnostics

#### Application

IO-Link enables easy integration of sensors and actuators from different manufacturers. ET200eco PN IO-Link master modules enable an exchange of data with up to 4 IO-Link devices. Since IO-Link is compatible with standard sensors, commercially available sensors compliant with IEC 61131 Type 1 can also be operated on the IO-Link master.

With a high degree of protection, ruggedness and small dimensions, the IO-Link master modules are especially well-suited for use at the machine level in confined spaces. They

have adjustable parameters and diagnostic functions and can therefore be flexibly adapted to individual process requirements.

The following IO-Link masters are available:

- Compact module in an enclosure width of 30 mm for connecting up to 4 IO-Link devices in accordance with the IO-Link Specification V1.0 and V1.1 and Port Class B
- Compact module in an enclosure width of 60 mm for connecting up to 4 IO-Link devices in accordance with the IO Link specification V1.0 and port class A and an additional 8 digital inputs and 4 digital outputs.



#### Design

The IO-Link master modules have a screw mounting hole at the front and side, and can be mounted in any position. As a result, they are extremely flexible to install on either a level surface or on aluminum mounting rails using sliding blocks.

ET 200eco PN IO-Link masters are compact modules with M12 connection technology.

Two load power supplies (4 A each) are available that can be used by the compact module or also be looped through to another compact module (line topology). PROFINET is connected via an M12 connection and can be looped through to a further PROFINET device. The maximum cable length to the IO-Link device is 20 m.

#### Selection and ordering data

Version	SD	Article No.	Price per PU	PU (UNIT, SET, M)	PS*	PG
<b>ET 200eco PN IO-Link master</b>						
 6ES7148-6JA00-0AB0	1	<b>6ES7148-6JA00-0AB0</b>		1	1 unit	250
	<ul style="list-style-type: none"> <li>• 4 IO-L + 8 DI + 4 DO, 24 V DC/1.3 A; 8 x M12, degree of protection IP67, enclosure width 60 mm; for connecting up to 4 IO-Link devices according to IO-Link Specification V1.0 and port Class A as well as 8 digital inputs and 4 digital outputs</li> </ul>					
 6ES7148-6JD00-0AB0	1	<b>6ES7148-6JD00-0AB0</b>		1	1 unit	250
	<ul style="list-style-type: none"> <li>• 4 IO-L 4 x M12, degree of protection IP67, enclosure width 30 mm; for connecting up to 4 IO-Link devices according to IO-Link Specification V1.0 and V1.1 and port Class B</li> </ul>					

### Accessories

Version	SD	Article No.	Price per PU	PU (UNIT, SET, M)	PS*	PG
	d					
<b>Voltage distributor</b> Voltage distributor PD 24 V DC; 1 X 7/8", 4 X M12	1	<b>6ES7148-6CB00-0AA0</b>		1	1 unit	250
<b>Terminal block</b> For ET 200eco PN, 10 A insulation displacement terminations	1	<b>6ES7194-6CA00-0AA0</b>		1	1 unit	250
<b>Replacement fuses</b> For terminal block, 10 units	1	<b>6ES7194-6HB00-0AA0</b>		1	10 units	250
<b>Mounting rail</b> 0.5 m	1	<b>6ES7194-6GA00-0AA0</b>		1	1 unit	250
<b>Profile screw</b> For the mounting rail, 50 units	1	<b>6ES7194-6MA00-0AA0</b>		1	50 units	250
<b>Sealing caps</b> M12 for IP67 modules, 10 units	▶	<b>3RK1901-1KA00</b>		100	10 units	42C
<b>Labels</b> 10 mm x 7 mm, pastel turquoise, 816 units	15	<b>3RT1900-1SB10</b>		100	816 units	41B
<b>PROFINET M12 connection plug, can be pre-assembled</b> IE FC M12 connector PRO, can be pre-assembled						
• 1 unit	1	<b>6GK1901-0DB20-6AA0</b>		1	1 unit	5K1
• 8 units	1	<b>6GK1901-0DB20-6AA8</b>		1	8 units	5K1
<b>PROFINET M12 plug-in cables</b> Pre-assembled connecting cables with 2 M12 plugs (D-coded), in various lengths:						
• 0.3 m	1	<b>6XV1870-8AE30</b>		1	1 unit	5K1
• 0.5 m	1	<b>6XV1870-8AE50</b>		1	1 unit	5K1
• 1.0 m	1	<b>6XV1870-8AH10</b>		1	1 unit	5K1
• 1.5 m	1	<b>6XV1870-8AH15</b>		1	1 unit	5K1
• 2.0 m	1	<b>6XV1870-8AH20</b>		1	1 unit	5K1
• 3.0 m	1	<b>6XV1870-8AH30</b>		1	1 unit	5K1
• 5.0 m	1	<b>6XV1870-8AH50</b>		1	1 unit	5K1
• 10.0 m	1	<b>6XV1870-8AN10</b>		1	1 unit	5K1
• 15.0 m	1	<b>6XV1870-8AN15</b>		1	1 unit	5K1
<b>M12 connection plug for 24 V DC load supply</b> Connection socket for 24 V DC incoming supply; 4-pin, A-coded, 3 units	1	<b>6GK1907-0DC10-6AA3</b>		1	3 units	5W3
Connector for loop-through of 24 V DC; 4-pin, A-coded, 3 units	1	<b>6GK1907-0DB10-6AA3</b>		1	3 units	5W3
<b>M12 power connector cables</b> Pre-assembled power connector cables with M12 box and plug, 4 x 0.75 mm <sup>2</sup> on both sides, in various lengths:						
• 0.3 m	1	<b>6XV1801-5DE30</b>		1	1 unit	5K2
• 0.5 m	1	<b>6XV1801-5DE50</b>		1	1 unit	5K2
• 1.0 m	1	<b>6XV1801-5DH10</b>		1	1 unit	5K2
• 1.5 m	1	<b>6XV1801-5DH15</b>		1	1 unit	5K2
• 2.0 m	1	<b>6XV1801-5DH20</b>		1	1 unit	5K2
• 3.0 m	1	<b>6XV1801-5DH30</b>		1	1 unit	5K2
• 5.0 m	1	<b>6XV1801-5DH50</b>		1	1 unit	5K2
• 10.0 m	1	<b>6XV1801-5DN10</b>		1	1 unit	5K2
• 15.0 m	1	<b>6XV1801-5DN15</b>		1	1 unit	5K2
<b>M12 Y-cables</b> For double connection of I/O by means of a single-cable on ET 200, 5-pole	1	<b>6ES7194-6KA00-0XA0</b>		1	1 unit	250



## IO-Link Masters IO-Link Master Module for ET 200AL

### CM IO-Link

#### Overview



CM IO-Link communication module

- 30-mm-wide CM IO-Link communication module
- For connecting up to 4 IO-Link devices in accordance with the IO-Link Specification V1.0 and V1.1 and Port Class B
- The IO-Link parameters are configured by means of the Port Configuration Tool (PCT) with version V3.2 and higher.

#### Application

The CM IO-Link communication module supports data exchange between up to four IO-Link devices.

IO-Link devices (e.g. sensors) with a class A port are interconnected by means of a 3-wire cable. IO-Link devices that require an additional supply voltage and have a class B port (e.g. actuators) are interconnected by means of a 5-wire cable.

Since IO-Link is compatible with standard sensors, commercially available sensors compliant with IEC 61131 Type 1 can also be operated on the IO-Link master.

The 30-mm-wide I/O modules are ideally suited for use in extremely confined spaces. They have adjustable parameters and diagnostic functions and can therefore be flexibly adapted to individual process requirements.

The following IO-Link masters are available:

- CM 4xIO-Link communication modules, 4XM12

#### Design

The I/O modules have a screw mounting hole at the front and side, and can be mounted in any position. As a result, they are extremely flexible to install on either a level surface or on aluminum mounting rails using sliding blocks.

The CM IO-Link communication module features:

- A backplane bus connection (Ethernet connection) with M8 connection system for connection to an interface module or other I/O modules
- A power supply connection with M8 connection system with loop-through
- LED display for port status
- LED display for channel status in SIO mode
- LED display for module status (DIAG)

- LED display for load voltage 2L+ (PWR)
- Labeling plates for channel, module and slot identification
- Integrated cable tie holder
- Meaningful module inscription on front panel:
  - Plain text marking of module type
  - Interface marking
  - LED label
- Meaningful module inscription on side panel:
  - Article number, function level and FW version
  - 2D matrix code (Article No. and serial number)
  - Pin assignments of all interfaces

Labeling plates for channel, module and slot identification are supplied with the modules. These labeling plates can be inscribed using commercially available inscription machines.

#### Function







- IO-Link master according to IO-Link specification V1.1
- 4 ports, Class B type
- Supported data transmission rates
  - COM1 (4.8 kBd)
  - COM2 (38.4 kBd)
  - COM3 (230.4 kBd)
- Expansion limits
  - Cable length: max. 20 m
  - Max. 32 bytes of input data and 32 bytes of output data per port
  - Max. 32 bytes of input data and 32 bytes of output data per module
- Automatic backup of device parameters when the IO-Link device is replaced (V1.1 devices only)
- Reparameterization during ongoing operation
- Standardized display and diagnostics concept:
  - Port status display (port activated or deactivated, green LED)
  - Channel status display for signal state in SIO mode (green LED)
  - Module status display (DIAG, red/green LED)
  - Display for monitoring the load voltage 2L+ (PWR, green LED)
- Supported functions:
  - Detailed module diagnostics and diagnostic interrupt
  - Identification and maintenance data IMO ... IM3
  - Firmware update
  - PROFlenergy

### Selection and ordering data

Version	SD	Article No.	Price per PU	PU (UNIT, SET, M)	PS*	PG
	d					
		<b>6ES7147-5JD00-0BA0</b>		1	1 unit	254
6ES7147-5JD00-0BA0						

**CM IO-Link**  
CM 4X IO-Link, 4XM12; for the connection of up to 4 IO-Link devices according to IO-Link Specification V1.0 and V1.1 and port Class B





### Accessories

Version	SD	Article No.	Price per PU	PU (UNIT, SET, M)	PS*	PG
	d					
<b>Bus cable for backplane bus (ET connection)</b>						
4-pole, shielded						
		• Pre-assembled on both sides, 2 M8 plugs				
		- Length 0.19 m	1	<b>6ES7194-2LH02-0AA0</b>	1	1 unit 254
		- Length 0.3 m	1	<b>6ES7194-2LH03-0AA0</b>	1	1 unit 254
		- Length 1 m	1	<b>6ES7194-2LH10-0AA0</b>	1	1 unit 254
		- Length 2 m	1	<b>6ES7194-2LH20-0AA0</b>	1	1 unit 254
		- Length 5 m	1	<b>6ES7194-2LH50-0AA0</b>	1	1 unit 254
		- Length 10 m	1	<b>6ES7194-2LN10-0AA0</b>	1	1 unit 254
	- Length 15 m	1	<b>6ES7194-2LN15-0AA0</b>	1	1 unit 254	
6ES7194-2L...-0AA0						
		• Pre-assembled on both sides, 2 M8 angular plugs				
		- Length 0.3 m	1	<b>6ES7194-2LH03-0AB0</b>	1	1 unit 254
		- Length 1 m	1	<b>6ES7194-2LH10-0AB0</b>	1	1 unit 254
		- Length 2 m	1	<b>6ES7194-2LH20-0AB0</b>	1	1 unit 254
		- Length 5 m	1	<b>6ES7194-2LH50-0AB0</b>	1	1 unit 254
		- Length 10 m	1	<b>6ES7194-2LN10-0AB0</b>	1	1 unit 254
		- Length 15 m	1	<b>6ES7194-2LN15-0AB0</b>	1	1 unit 254
6ES7194-2L...-0AB0						
		• Pre-assembled on one side, 1 M8 plug				
		- Length 2 m	1	<b>6ES7194-2LH20-0AC0</b>	1	1 unit 254
		- Length 5 m	1	<b>6ES7194-2LH50-0AC0</b>	1	1 unit 254
		- Length 10 m	1	<b>6ES7194-2LN10-0AC0</b>	1	1 unit 254
		- Length 15 m	1	<b>6ES7194-2LN15-0AC0</b>	1	1 unit 254
6ES7194-2L...0-0AC0						
<b>M8 power cable</b>						
4-pole						
		• Pre-assembled on both sides, M8 plug and M8 socket				
		- Length 0.19 m	1	<b>6ES7194-2LH02-1AA0</b>	1	1 unit 254
		- Length 0.3 m	1	<b>6ES7194-2LH03-1AA0</b>	1	1 unit 254
		- Length 1 m	1	<b>6ES7194-2LH10-1AA0</b>	1	1 unit 254
		- Length 2 m	1	<b>6ES7194-2LH20-1AA0</b>	1	1 unit 254
		- Length 5 m	1	<b>6ES7194-2LH50-1AA0</b>	1	1 unit 254
		- Length 10 m	1	<b>6ES7194-2LN10-1AA0</b>	1	1 unit 254
	- Length 15 m	1	<b>6ES7194-2LN15-1AA0</b>	1	1 unit 254	
6ES7194-2L...-1AA0						
		• Pre-assembled on both sides, M8 angular plug and M8 angular socket				
		- Length 0.3 m	1	<b>6ES7194-2LH03-1AB0</b>	1	1 unit 254
		- Length 1 m	1	<b>6ES7194-2LH10-1AB0</b>	1	1 unit 254
		- Length 2 m	1	<b>6ES7194-2LH20-1AB0</b>	1	1 unit 254
		- Length 5 m	1	<b>6ES7194-2LH50-1AB0</b>	1	1 unit 254
		- Length 10 m	1	<b>6ES7194-2LN10-1AB0</b>	1	1 unit 254
		- Length 15 m	1	<b>6ES7194-2LN15-1AB0</b>	1	1 unit 254
6ES7194-2L...-1AB0						
		• Pre-assembled on one side, one M8 socket				
		- Length 2 m	1	<b>6ES7194-2LH20-1AC0</b>	1	1 unit 254
		- Length 5 m	1	<b>6ES7194-2LH50-1AC0</b>	1	1 unit 254
		- Length 10 m	1	<b>6ES7194-2LN10-1AC0</b>	1	1 unit 254
		- Length 15 m	1	<b>6ES7194-2LN15-1AC0</b>	1	1 unit 254
6ES7194-2L...0-1AC0						

# IO-Link Masters

## IO-Link Master Module for ET 200AL

### CM IO-Link

Version	SD	Article No.	Price per PU	PU (UNIT, SET, M)	PS*	PG
 6ES7194-2AB00-0AA0	d	<b>6ES7194-2AB00-0AA0</b>		1	1 unit	254
<b>M8 plug for Ethernet connection</b> 4-pole, shielded						
 6ES7194-2AA00-0AA0		<b>6ES7194-2AA00-0AA0</b>		1	1 unit	254
<b>M8 power plug</b> • Male contact insert, 4-pole						
 6ES7194-2AA00-0AA0		<b>6ES7194-2AC00-0AA0</b>		1	1 unit	254
• Female insert, 4-pole						
 6ES7194-2KA00-0AA0		<b>6ES7194-2KA00-0AA0</b>		1	1 unit	254
<b>Ethernet connection Fast Connect Stripping Tool</b> Stripping tool for stripping the Ethernet connection bus cable						
 6ES7194-2BA00-0AA0		<b>6ES7194-2BA00-0AA0</b>		1	1 unit	254
<b>Labeling plates</b> 10 x 5 mm, RAL 9016, 5 frames with 40 labels each						

## Overview



IO-Link input modules

Using IO-Link technology, it is basically possible to connect standard sensors to IO-Link masters. However, connecting standard sensors directly to the IO-Link master does not exploit the full potential of IO-Link.

The solution lies in the technology of the IO-Link modules. Their use is a more economically attractive solution in comparison to the direct connection of a sensor.

The IO-Link input module technology enhances IO-Link via a pure point-to-point cable connection towards decentralized structures. The maximum cable length of an IO-Link connection between an IO-Link module and an IO-Link master is 20 m. The use of sensor boxes with accordingly complex and error-prone wiring is no longer necessary.

### Transmission of parameter and diagnostic signals

The IO-Link input modules also offer the possibility of transmitting parameters and diagnostic signals. This enables for example the inputs of modules to be parameterized as NC contacts or NO contacts through IO-Link. An overload or short-circuit in the sensor supply is signaled to the control system through the IO-Link master.

### M8 and M12 terminals

M8 and M12 terminals are available for connecting the sensors. Connection to the IO-Link master is made using a standard M12 connecting cable.

## Benefits

Benefits of using IO-Link input modules:

- Economical use of innovative IO-Link technology also for binary sensors
- Optimum use of all ports of the IO-Link master
- Connection of several binary sensors/actuators to one port of the IO-Link master, hence low-cost connection also of binary sensors/actuators to the control system through IO-Link
- Reduction of digital input modules in the peripheral station
- Use of parameters also for binary sensors (e.g. NC contacts, NO contacts and input delay can be parameterized)
- Reduction of cabling and hence less risk of wiring errors by dispensing with sensor boxes
- Expansion toward distributed structures using pure point-to-point wiring
- Easy and elegant integration of sensors within a radius of 20 m around an IO-Link master, e.g. in an ET 200 station
- Possibility of transmitting parameter and diagnostic signals (e.g. sensor supply overload)
- Can also be used in harsh ambient conditions thanks to a very compact design and degree of protection IP67

## Application

IO-Link input modules are particularly used where sensor boxes had previously been used for the connection of binary sensors.

Application example:

Replacement of sensor boxes by using IO-Link input modules

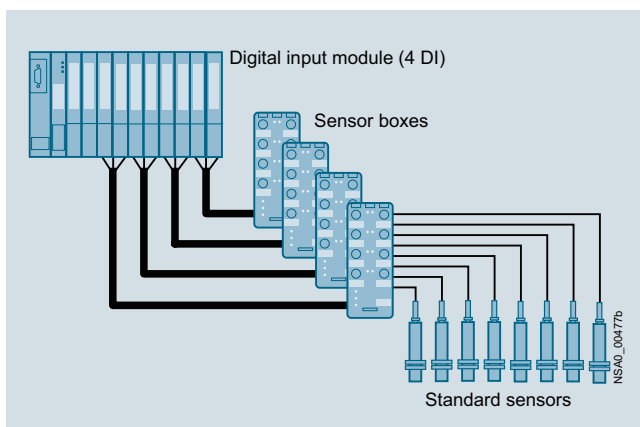

Former technology with sensor boxes

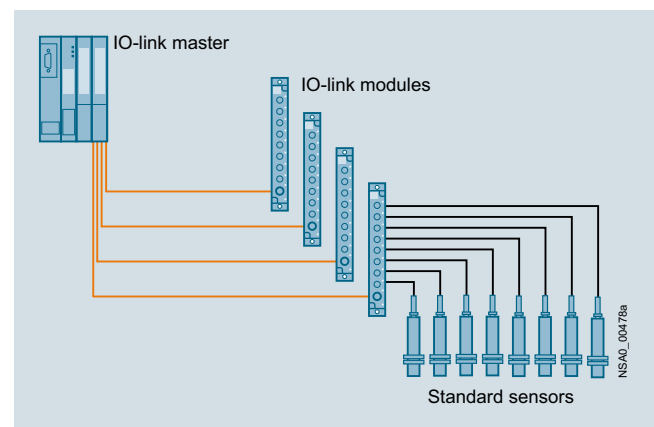



Technology with IO-Link input modules

# IO-Link Input Modules

## K20 IO-Link modules











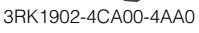

### Selection and ordering data

Type	Pin assignment	Connection	SD	Article No.	Price per PU	PU (UNIT, SET, M)	PS*	PG
<b>K20 IO-Link modules</b>								
	• 4 inputs	Y	M12	5	<b>3RK5010-0BA10-0AA0</b>	1	1 unit	42C
	• 8 inputs	Standard	M8	5	<b>3RK5010-0CA00-0AA0</b>	1	1 unit	42C
								

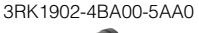
3RK5010-0BA10-0AA0

3RK5010-0CA00-0AA0

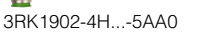
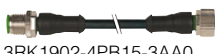
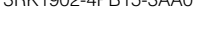
### Accessories

Version	SD	Article No.	Price per PU	PU (UNIT, SET, M)	PS*	PG
<b>Sealing caps</b>						
	▶	<b>3RK1901-1KA00</b>		100	10 units	42C
	2	<b>3RK1901-1PN00</b>		100	10 units	42C
						
<b>Control cable, assembled at one end</b>						
						
	10	<b>3RK1902-4GB50-4AA0</b>		1	1 unit	42D
						
<b>M12 socket, angled</b>						
						
	10	<b>3RK1902-4CA00-4AA0</b>		1	1 unit	42D
						
<b>M12 connector</b>						
						
	10	<b>3RK1902-4BA00-5AA0</b>		1	1 unit	42D
	10	<b>3RK1902-4DA00-5AA0</b>		1	1 unit	42D
						
						
						
<b>Control cable, assembled at one end</b>						
						
	10	<b>3RK1902-4HB15-5AA0</b>		1	1 unit	42D
	10	<b>3RK1902-4HB50-5AA0</b>		1	1 unit	42D
	10	<b>3RK1902-4HC01-5AA0</b>		1	1 unit	42D
						
<b>Control cable, assembled at both ends</b>						
						
	10	<b>3RK1902-4PB15-3AA0</b>		1	1 unit	42D
						
<b>M12 Y-shaped coupler plugs</b>						
						
	1	<b>6ES7194-1KA01-0XA0</b>		1	1 unit	250
						

6ES7194-1KA01-0XA0