



**INSTALLATION & OPERATION**

# **A53680 AIRLINK WAYSIDE COMMUNICATIONS PACKAGE (WCP)**

**DECEMBER 2022**

**DOCUMENT NO. COM-00-21-01**

**VERSION B.1**

Siemens Mobility, Inc.  
One Penn Plaza  
Suite 1100  
New York, NY 10119-1101  
1-800-793-SAFE  
[www.usa.siemens.com/rail-manuals](http://www.usa.siemens.com/rail-manuals)

Copyright © 2022 Siemens Mobility, Inc.

All Rights Reserved

**PRINTED IN THE U.S.A.**

## PROPRIETARY INFORMATION

The material contained herein constitutes proprietary and confidential information, and is the intellectual property of Siemens Mobility, Inc. (Siemens) protected under United States patent, copyright and/or other laws and international treaty provisions. This information and the software it describes are for authorized use only, and may not be: (i) modified, translated, reverse engineered, decompiled, disassembled or used to create derivative works; (ii) copied or reproduced for any reason other than specific application needs; or (iii) rented, leased, lent, sublicensed, distributed, remarketed, or in any way transferred; without the prior written authorization of Siemens. This proprietary notice and any other associated labels may not be removed.

## TRANSLATIONS

The manuals and product information of Siemens Mobility, Inc. are intended to be produced and read in English. Any translation of the manuals and product information are unofficial and can be imprecise and inaccurate in whole or in part. Siemens Mobility, Inc. does not warrant the accuracy, reliability, or timeliness of any information contained in any translation of manual or product information from its original official released version in English and shall not be liable for any losses caused by such reliance on the accuracy, reliability, or timeliness of such information. Any person or entity that relies on translated information does so at his or her own risk.

## WARRANTY INFORMATION

Siemens Mobility, Inc. warranty policy is as stated in the current Terms and Conditions of Sale document. Warranty adjustments will not be allowed for products or components which have been subjected to abuse, alteration, improper handling or installation, or which have not been operated in accordance with Seller's instructions. Alteration or removal of any serial number or identification mark voids the warranty.

## SALES AND SERVICE LOCATIONS

Technical assistance and sales information on Siemens Mobility, Inc. products may be obtained at the following locations:

SIEMENS MOBILITY, INC.

2400 NELSON MILLER PARKWAY

LOUISVILLE, KENTUCKY 40223

TELEPHONE: (502) 618-8800

FAX: (502) 618-8810

SALES & SERVICE: (800) 626-2710

WEB SITE: [www.usa.siemens.com/rail-manuals](http://www.usa.siemens.com/rail-manuals)

SIEMENS MOBILITY, INC.

939 S. MAIN STREET

MARION, KENTUCKY 42064

TELEPHONE: (270) 918-7800

CUSTOMER SERVICE: (800) 626-2710

TECHNICAL SUPPORT: (800) 793-7233

FAX: (270) 918-7830

## FCC RULES COMPLIANCE

The equipment covered in this manual has been tested and found to comply with the limits for Class A digital devices, pursuant to part 15 of the FCC Rules. These limits are designed to provide reasonable protection against harmful interference when the equipment is operated in a commercial environment. This equipment generates, uses, and can radiate radio frequency energy and, if not installed and used in accordance with the instruction manual, may cause harmful interference to radio communications. Operation of this equipment in a residential area is likely to cause harmful interference in which case the user will be required to correct the interference at his/her own expense.

## DOCUMENT HISTORY

Version	Release Date	Sections Changed	Details of Change
A	Nov 2021		Initial release
B	Oct 2022	1.2 1.4.1 2.1 4.3.3. 4.4.1  Ch. 6 Ch. 7  Ch. 8	Updated to include MC-IoT Mode information. Added new configuration chart. Updated to include MC-IoT Mode information. Removed Grounding & Surge Protection section. Added figure for A47723 Cable Assy, Airlink WCP to ElectroLogIXS CIO-1A Unit. Updated various screenshots for front panel. General update throughout to content and various figures. Added MC-IoT information to Apollo Section. Added MC-IoT information to CLI Configuration Section. Updated troubleshooting section to include MC-IoT Mode information.
B.1	Dec 2022	1.4.1	Updated the value of the frequencies listed for the A1 and A10 channels in Figure 1-3.

## Table of Contents

PROPRIETARY INFORMATION .....	ii
DOCUMENT HISTORY .....	iii
NOTES, CAUTIONS, AND WARNINGS .....	xiv
ELECTROSTATIC DISCHARGE (ESD) PRECAUTIONS .....	xv
HUMAN EXPOSURE STATEMENT .....	xvi
GLOSSARY .....	xvii
CHAPTER 1 – INTRODUCTION .....	1-1
1.1 Scope .....	1-1
1.2 System Features .....	1-3
1.3 Specifications .....	1-4
1.4 Ordering Information.....	1-5
1.4.1 Configuration Options.....	1-5
1.4.2 RF Cable and Antenna Installation Options .....	1-7
CHAPTER 2 – FUNCTIONAL DESCRIPTION .....	2-1
2.1 Airlink WCP Overview .....	2-1
2.1.1 ATCS Mode .....	2-1
2.1.2 IEEE 802.16 MC-IoT Mode .....	2-1
2.2 Airlink WCP Functional Description.....	2-2
2.2.1 Power Supply Unit.....	2-2
2.2.2 Communications Base Board .....	2-3
2.2.3 Radio Frequency Module .....	2-3
2.2.4 Power Amplifier .....	2-4
2.2.5 Complimentary Radio Module .....	2-4
2.2.6 System Status Display.....	2-4
2.2.7 RF Antenna .....	2-4
2.2.8 GPS Antenna.....	2-4
CHAPTER 3 – AIRLINK WCP CONNECTORS.....	3-1
3.1 General.....	3-1
3.2 Airlink WCP External Connectors.....	3-1
3.2.1 25-Pin D-Type Client Port Connectors (Female).....	3-1
3.2.2 Serial Console Connector (RJ45).....	3-4
3.2.3 2-Pin Power Connector (Male) .....	3-5
3.2.4 Ethernet Port Connectors .....	3-6

CHAPTER 4 – INSTALLATION .....	4-1
4.1    General.....	4-1
4.2    Power .....	4-2
4.3    Mounting the Airlink WCP .....	4-2
4.3.1    Rack/Shelf Mounting .....	4-3
4.3.2    Instructions for Wall Mounting .....	4-7
4.4    Equipment Interconnect Cabling .....	4-8
4.4.1    Airlink WCP Basic Cabling .....	4-9
CHAPTER 5 – AIRLINK WCP OPTIONS .....	5-1
5.1    General.....	5-1
5.2    Basic Configuration Options .....	5-1
5.2.1    Installation Options .....	5-1
5.3    Peripheral Interconnection Cables .....	5-1
CHAPTER 6 – FRONT PANEL DESCRIPTION .....	6-1
6.1    General details Menu .....	6-3
6.2    RF Port Details Menu .....	6-4
6.3    Serial Port J1 Details & Serial Port J2 Details Menus .....	6-5
6.3.1    Asynchronous Mode.....	6-7
6.3.2    Synchronous Mode.....	6-7
6.4    Restore Default Settings Menu.....	6-8
CHAPTER 7 – CONFIGURATION & ALIGNMENT .....	7-1
7.1    Introduction.....	7-1
7.2    Configuration .....	7-1
7.3    Apollo User Information .....	7-1
7.3.1    Introduction.....	7-1
7.3.2    Installation .....	7-1
7.3.2.1    Discovery Application (9VE46).....	7-1
7.3.2.2    Apollo tool .....	7-2
7.3.2.3    Prerequisites .....	7-2
7.3.3    Discovery Application Initial Configuration Steps .....	7-3
7.3.4    Apollo Menu Descriptions.....	7-7
7.3.4.1    Configurations Screen.....	7-7
7.3.4.2    Diagnostics Screen .....	7-10
7.3.4.3    Scanner Screen .....	7-12
7.3.4.4    Actions Screen .....	7-13

7.3.4.5	Logging Screen .....	7-16
7.3.4.6	Info Screen .....	7-17
7.3.4.7	Common Features .....	7-17
7.4	Command Line Interface (CLI) Operations & Configuration .....	7-18
7.4.1	Common Information for both modes of Operation .....	7-18
7.4.1.1	Console Access.....	7-18
7.4.1.2	Basic Login Instructions .....	7-18
7.4.1.3	Operator User.....	7-19
7.4.1.4	Admin User .....	7-19
7.4.2	Commands Applicable to ATCS Mode Only.....	7-20
7.4.2.1	Read Configuration Information .....	7-20
7.4.2.2	Read Statistics and Measurement Information .....	7-28
7.4.2.3	Volatile Configuration Change.....	7-32
7.4.2.4	Setting Log Levels.....	7-35
7.4.2.5	Log to File Parameter.....	7-36
7.4.3	Commands Applicable to MC-IoT Mode Only .....	7-36
7.4.3.1	Console Access.....	7-36
7.4.3.2	Read Configuration Information .....	7-36
7.4.3.3	Read Statistics and Measurement Information .....	7-40
7.4.3.4	Volatile Configuration Change.....	7-45
7.4.3.5	Setting Log Levels.....	7-46
CHAPTER 8	– TROUBLESHOOTING .....	8-1
8.1	General.....	8-1
8.2	Code System Application .....	8-1
8.2.1	RF Link .....	8-1
8.2.2	Code System Troubleshooting .....	8-2
A	ADVANCED TRAIN CONTROL SYSTEM .....	A-1
A.1	Overview.....	A-1
A.2	ATCS Addressing.....	A-2
A.2.1	Locomotive Addresses (Type 1).....	A-2
A.2.2	Office Equipment Addresses (Type 2).....	A-2
A.2.3	Base Station Address (Type 3).....	A-3
A.2.4	Wayside Equipment (Type 5) .....	A-3
A.2.5	Wayside Equipment (Type 7) .....	A-4
A.2.6	Other Address Types.....	A-4

A.3	ATCS Message Formats .....	A-5
A.4	ATCS Radio Network – Layer 1 .....	A-5
B	RAILROAD CODE LISTING .....	B-1
C	GENERIC GROUNDING PROCEDURES .....	C-1
C.1	General .....	C-1
C.2	External Building Ground .....	C-1
C.3	Internal Building Ground .....	C-3
C.4	Antenna Ground .....	C-4
C.4.1	Antenna Ground – Roof-Mount Yagi .....	C-4
C.4.2	Antenna Ground – Towers and Poles .....	C-4
C.5	AC Power Ground .....	C-6
C.6	Communications Ground .....	C-7
C.7	Cabling .....	C-7
C.8	Surge Protection .....	C-7
D	RF CABLE AND CONNECTOR REFERENCE DATA .....	D-1
D.1	Jumper Applications .....	D-1
D.2	Connectors .....	D-1
D.3	Accessories (Recommended) .....	D-1
E	RF PROPAGATION BRIEF .....	E-1
E.1	Wavelength vs Frequency .....	E-1
E.1.1	Quarter and Half Wavelength Lines .....	E-2
E.2	Current and Voltage Distributions .....	E-2
E.3	Effective Radiated Power (ERP) .....	E-3
E.4	Resonant Antennas .....	E-4
F	VOLTAGE DROP TABLES .....	F-1

## List of Figures

Figure 1-1	Airlink Wayside Communications Package (WCP) – Front/Top View .....	1-1
Figure 1-2	Airlink Wayside Communications Package (WCP) – Top/Right Side View .....	1-2
Figure 1-3	Airlink WCP Configuration Chart .....	1-5
Figure 2-1	Airlink WCP System Block Diagram .....	2-2
Figure 3-1	Airlink WCP – Front View .....	3-2
Figure 3-2	Airlink WCP – Top View.....	3-3
Figure 3-3	RJ45 Serial Console Adapter Cable .....	3-4
Figure 3-4	Phoenix Connector: Part Number 1828249.....	3-5
Figure 4-1	Airlink WCP Dimensions.....	4-1
Figure 4-2	Airlink WCP Rear Panel Dimensions.....	4-2
Figure 4-3	Airlink WCP Top View when Mounted to Rack.....	4-4
Figure 4-4	Airlink WCP Bottom View when Mounted to Rack.....	4-5
Figure 4-5	Airlink WCP Rear View when Mounted to Rack .....	4-6
Figure 4-6	Typical Airlink WCP Wall Installation – Front View.....	4-7
Figure 4-7	Typical Airlink WCP Wall Installation – Top View .....	4-8
Figure 4-8	Airlink WCP Typical Interconnect Diagram – Top.....	4-9
Figure 4-9	Airlink WCP Typical Interconnect Diagram – Front Panel .....	4-10
Figure 4-10	A26560 Cable Assy, Airlink WCP to Local Control Panel.....	4-11
Figure 4-11	A26562 Cable Assy, Airlink WCP to Devtronics ATCS CPU Card .....	4-12
Figure 4-12	A47715 Cable Assy, Airlink WCP to Harmon HLC Unit.....	4-13
Figure 4-13	A47719 Cable Assy, Airlink WCP to ElectroLogIXS Unit.....	4-14
Figure 4-14	A47723 Cable Assy, Airlink WCP to ElectroLogIXS CIO-1A Unit.....	4-15
Figure 6-1	Airlink WCP Front Panel showing Push Buttons .....	6-1
Figure 6-2	Front Panel Display Primary Level Menu Options .....	6-2
Figure 6-3	Front Panel Display Message to confirm Restore of Factory Default Settings .....	6-8
Figure 6-4	Front Panel Display Message after Restoring Default Settings.....	6-8
Figure 7-1	Discovery Application .....	7-3
Figure 7-2	Discovery Application: After Clicking Discover .....	7-3
Figure 7-3	Popup - No Radio Found .....	7-4
Figure 7-4	Discovery Application: Add Radio Manually .....	7-4
Figure 7-5	Discovery Application After Adding Radio Manually.....	7-5
Figure 7-6	Logging into Radio.....	7-5
Figure 7-7	Message to User .....	7-6



Figure 7-8	Static Configurations Screen (in ATCS Mode)	7-8
Figure 7-9	Static Configurations Screen (in MC-IoT Mode)	7-8
Figure 7-10	Dynamic Configurations Screen (in MC-IoT Mode only)	7-9
Figure 7-11	Diagnostics Screen (in MC-IoT Mode only)	7-10
Figure 7-12	Diagnostics Screen – One Graph Plotting (in MC-IoT Mode only)	7-11
Figure 7-13	Diagnostics Screen – Two Graph Plotting (in MC-IoT Mode only)	7-11
Figure 7-14	Diagnostics Screen – Four Graph Plotting (in MC-IoT Mode only)	7-12
Figure 7-15	Scanner Screen (both modes of operation)	7-13
Figure 7-16	Actions Screen (in ATCS Mode)	7-15
Figure 7-17	Actions Screen (in MC-IoT Mode)	7-15
Figure 7-18	Logging Screen (in ATCS Mode)	7-16
Figure 7-19	Logging Screen (in MC-IoT Mode)	7-16
Figure 7-20	Info Screen (in MC-IoT Mode only)	7-17
Figure 7-21	Admin Login	7-18
Figure 7-22	Available Options in Operator Mode	7-19
Figure 7-23	Available Options in Admin Mode	7-20
Figure 7-24	View System Configuration - 1	7-21
Figure 7-25	View System Configuration – 2	7-22
Figure 7-26	View System Configuration - 3	7-23
Figure 7-27	View ATCS Address Configuration	7-24
Figure 7-28	View Higher Layer Configuration	7-25
Figure 7-29	View Radio Configuration	7-25
Figure 7-30	View Higher Layer Configuration - UDP network	7-26
Figure 7-31	View IP Configuration	7-26
Figure 7-32	View PHY Configuration	7-26
Figure 7-33	View Serial Port 0 Configuration	7-27
Figure 7-34	View Serial Port 1 Configuration	7-27
Figure 7-35	View WCP Info	7-28
Figure 7-36	View Measurement Info	7-29
Figure 7-37	View RFM Configurations	7-29
Figure 7-38	View RF Frames Statistics	7-29
Figure 7-39	View RF and Serial Ports Statistics	7-30
Figure 7-40	View GPS Time	7-30
Figure 7-41	View CBB Temperature	7-30
Figure 7-42	View System Uptime	7-31

Figure 7-43	View Current Time and Date .....	7-31
Figure 7-44	RF Port Frame Statistics.....	7-31
Figure 7-45	Available Volatile Configuration Parameters .....	7-32
Figure 7-46	Rx Gain Configuration .....	7-33
Figure 7-47	Tx Power Configuration (1).....	7-33
Figure 7-48	Tx Power Configuration (2).....	7-33
Figure 7-49	BERT Tx Mode .....	7-33
Figure 7-50	BERT Rx Mode.....	7-33
Figure 7-51	Disable BERT Mode .....	7-33
Figure 7-52	Date and Time Configuration.....	7-34
Figure 7-53	Enable Carrier Mode.....	7-34
Figure 7-54	Disable Carrier Mode.....	7-34
Figure 7-55	Enable Tx Calibration Mode .....	7-34
Figure 7-56	Disable Tx Calibration Mode.....	7-34
Figure 7-57	Debug Modules .....	7-35
Figure 7-58	Debug Log Levels.....	7-35
Figure 7-59	Setting the Log Level 'Major' for Controller Module.....	7-36
Figure 7-60	View Radio Configuration .....	7-37
Figure 7-61	View IP Configuration .....	7-38
Figure 7-62	View System Configuration-1 .....	7-38
Figure 7-63	View System Configuration-2 .....	7-39
Figure 7-64	View MS SW version .....	7-40
Figure 7-65	View Measurement Info .....	7-41
Figure 7-66	View RF Frames Statistics.....	7-42
Figure 7-67	View RFM Configuration.....	7-42
Figure 7-68	View System Statistics.....	7-43
Figure 7-69	View GPS Location.....	7-44
Figure 7-70	View GPS Time .....	7-44
Figure 7-71	View CBB Temperature .....	7-44
Figure 7-72	View System Uptime.....	7-44
Figure 7-73	Available Volatile Configuration Parameters .....	7-45
Figure 7-74	Tx Power Configuration .....	7-45
Figure 7-75	Rx Gain Configuration .....	7-45
Figure 7-76	Debug Modules .....	7-46
Figure 7-77	Debug ms Log Levels.....	7-46

Figure 7-78	Debug phy Log Levels .....	7-47
Figure A-1	Typical ATCS Network .....	A-1
Figure A-2	Major Fields of an ATCS Message.....	A-5
Figure C-1	Typical Ground Connections.....	C-2
Figure C-2	Typical Internal Building Ground .....	C-3
Figure C-3	Typical Tower and Pole Ground Connections.....	C-5
Figure C-4	Typical Connections for Grounding and Bonding.....	C-6
Figure E 1	Wavelength vs Frequency .....	E-1
Figure E 2	Loaded Line.....	E-2
Figure E 3	Current Distribution on Resonant Dipoles .....	E-3

## List of Tables

Table 1-1	RF Cable and Installation Material Options .....	1-7
Table 3-1	25-Pin D-Type Connector Pin Assignments .....	3-1
Table 3-2	RJ45 Serial Console Connector Pin Assignments.....	3-4
Table 3-3	Phoenix Connector Pin Assignments.....	3-5
Table 3-4	RJ45 Serial Console Connector Pin Assignments.....	3-6
Table 4-1	Airlink WCP Interconnect Cable Descriptions.....	4-9
Table 5-1	Peripheral Interconnection Cables.....	5-1
Table 7-1	Default Login Information.....	7-2
Table 7-2	Default Login Information.....	7-5
Table 7-3	CLI Commands to Retrieve Different Configuration Sets .....	7-24
Table 7-4	CLI Commands for Viewing Statistics.....	7-28
Table 7-5	CLI Commands for Volatile Configuration Changes .....	7-32
Table 7-6	CLI Commands for System Configurations.....	7-37
Table 7-7	CLI Commands for Viewing Statistics.....	7-40
Table 7-8	CLI Commands for Volatile Configuration Changes .....	7-45
Table 8-1	Connection Troubleshooting Issue and Corrective Action .....	8-4
Table D-1	Transmission Line System Components.....	D-1
Table D-2	Coaxial Cable Selection Guide 50-ohm, Foam Dielectric .....	D-2
Table D-3	3/8" 50-ohm Foam Dielectric Coaxial Cable Attenuation and Average Power .....	D-2
Table D-4	1/2" 50-ohm Foam Dielectric Coaxial Cable Attenuation and Average Power .....	D-2
Table D-5	1/2" N-Connector Loss VSWR, Low VSWR Specifications, Type N .....	D-3
Table D-6	7/8" 50-ohm Foam Dielectric Coaxial Cable .....	D-3
Table D-7	7/8" N-Connector Loss VSWR, Low VSWR Specifications, Type N .....	D-3
Table D-8	1/2" Coaxial Cable Loss dB Comparison Reference.....	D-3
Table D-9	Base Radio Main Feeder Cable Coaxial Cable Selection Guide – 50 ohm “Air” Dielectric..	D-4
Table D-10	1-1/4" 50-ohm Foam Dielectric Coaxial Cable .....	D-4
Table D-11	1-1/4" Connector LOSS Low VSWR Specifications .....	D-4
Table D-12	1-5/8" 50-ohm Foam Dielectric Coaxial Cable .....	D-5
Table D-13	1-5/8" Connector LOSS Low VSWR Specifications .....	D-5
Table D-14	1-5/8" 50-ohm Air Dielectric Coaxial Cable .....	D-5
Table D-15	1/2" N-Connector.....	D-5
Table F 1	Conductor Size for 10% Voltage Drop - 12 Volts.....	F-1
Table F 2	Conductor Sizes for 10% Voltage Drop – 24 Volts .....	F-2

Table F 3 Conductor Sizes for 10% Voltage Drop - 32 Volts ..... F-3  
Table F 4 Conductor Sizes for 3% Voltage Drop - 12 Volts ..... F-4  
Table F 5 Conductor Size for 3% Voltage Drop – 24 Volts ..... F-5  
Table F 6 Conductor Sizes for 3% Voltage Drop - 32 Volts ..... F-6

## NOTES, CAUTIONS, AND WARNINGS

Throughout this manual, notes, cautions, and warnings are frequently used to direct the reader's attention to specific information. Use of the three terms is defined as follows:

### **WARNING**

#### **WARNING**

**INDICATES A POTENTIALLY HAZARDOUS SITUATION WHICH, IF NOT AVOIDED, COULD RESULT IN DEATH OR SERIOUS INJURY. WARNINGS ALWAYS TAKE PRECEDENCE OVER NOTES, CAUTIONS, AND ALL OTHER INFORMATION.**

### **CAUTION**

#### **CAUTION**

REFERS TO PROPER PROCEDURES OR PRACTICES WHICH IF NOT STRICTLY OBSERVED, COULD RESULT IN A POTENTIALLY HAZARDOUS SITUATION AND/OR POSSIBLE DAMAGE TO EQUIPMENT. CAUTIONS TAKE PRECEDENCE OVER NOTES AND ALL OTHER INFORMATION, EXCEPT WARNINGS.

### **NOTE**

#### **NOTE**

Generally used to highlight certain information relating to the topic under discussion.

If there are any questions, contact Siemens Mobility, Inc. Application Engineering

## ELECTROSTATIC DISCHARGE (ESD) PRECAUTIONS

Static electricity can damage electronic circuitry, particularly low voltage components such as the integrated circuits commonly used throughout the electronics industry. Therefore, procedures have been adopted industry-wide which make it possible to avoid the sometimes invisible damage caused by electrostatic discharge (ESD) during the handling, shipping, and storage of electronic modules and components. Siemens Mobility, Inc. has instituted these practices at its manufacturing facility and encourages its customers to adopt them as well to lessen the likelihood of equipment damage in the field due to ESD. Some of the basic protective practices include the following:

- Ground yourself before touching card cages, assemblies, modules, or components.
- Remove power from card cages and assemblies before removing or installing modules.
- Remove circuit boards (modules) from card cages by the ejector lever only. If an ejector lever is not provided, grasp the edge of the circuit board but avoid touching circuit traces or components.
- Handle circuit boards by the edges only.
- Never physically touch circuit board or connector contact fingers or allow these fingers to come in contact with an insulator (e.g., plastic, rubber, etc.).
- When not in use, place circuit boards in approved static-shielding bags, contact fingers first. Remove circuit boards from static-shielding bags by grasping the ejector lever or the edge of the board only. Each bag should include a caution label on the outside indicating static-sensitive contents.
- Cover workbench surfaces used for repair of electronic equipment with static dissipative workbench matting.
- Use integrated circuit extractor/inserters tools designed to remove and install electrostatic-sensitive integrated circuit devices such as PROM's (OK Industries, Inc., Model EX-2 Extractor and Model MOS-40 Inserter (or equivalent) are highly recommended).
- Utilize only anti-static cushioning material in equipment shipping and storage containers.

For information concerning ESD material applications, please contact the Technical Support Staff at 1-800-793-7233. ESD Awareness Classes and additional ESD product information are also available through the Technical Support Staff.



### **RF EXPOSURE WARNING**



This equipment complies with the FCC RF radiation exposure limits set forth for an uncontrolled environment. This transmitter must follow the specific operating instructions for satisfying RF exposure compliance. This transmitter must be at least 8 inches (20 cm) from the user and must not be co-located or operating in conjunction with any other antenna or transmitter.

All antenna installation and servicing are to be performed by qualified technical personnel only. When servicing or working at distances closer than 7 feet (2 meters), ensure the transmitter has been disabled. Depending upon the application and the gain of the antenna, the total composite power could exceed 100 watts EIRP. The antenna location should be such that only qualified technical personnel can access it, and under normal operating conditions no other person can come in contact or approach within 7 feet (2 meters) of the antenna.

## HUMAN EXPOSURE STATEMENT

This equipment is designed to generate and radiate radio frequency (RF) energy using an external antenna.

When terminated into a non-radiating RF load, the radio is certified to comply with FCC regulations pertaining to human exposure to RF radiation in accordance with the FCC Rules Part 1 section 1.1310 as published in title 47 code of federal regulations and procedures established in TIA/EIA TSB92, Report On EME Evaluation for RF Cabinet Emissions Under FCC MPE Guidelines. Compliance with FCC regulations of the final installation should be assessed and take into account site-specific characteristics such as type and location of antennas, as well as site accessibility of occupational personnel (controlled environment) and the general public (uncontrolled environment). This equipment should only be installed and maintained by trained technicians. Whether a given installation meets FCC limits for human exposure to radio frequency radiation may depend not only on this equipment but also on whether the environments being assessed are being affected by radio frequency fields from other equipment, which may add to the level of exposure. Accordingly, the overall exposure may be affected by radio frequency generating facilities that exist at the time the licensee's equipment is being installed or even by equipment installed later. The effects of any such facilities must be considered in site selection and in determining whether a particular installation meets the FCC requirements.

FCC OET Bulletin 65 provides materials to assist in making determinations if a given facility is compliant with the human exposure to RF radiation limits. Determining the compliance of transmitter sites of various complexities may be accomplished through computational methods. For more complex sites, direct measurement of the power density may be more expedient. Personnel responsible for installing this equipment are urged to consult the listed reference material to assist in determining whether a given installation complies with the applicable limits.



## GLOSSARY

AAR	<u>Association of American Railroads</u> - An organization that establishes uniformity and standardization among different railroad systems.
ABM	<u>Asynchronous Balance Mode</u> – Used as an identifier for a HDLC protocol.
ADM	<u>Asynchronous Disconnect Mode</u> – Used as an identifier for a HDLC protocol.
ATCS	<u>Advanced Train Control System</u> - A set of standards compiled by the AAR for controlling all aspects of train operation.
BCP	<u>Base Communications Package</u> - Defined by the ATCS specifications as the transmitter / receiver base station and associated processors to handle communications between mobile and central office equipment.
BER	<u>Bit Error Rate</u> - Expresses the quality of a communications in the number of errors per bits sent.
BPSK	<u>Binary Phase Shift Keying</u> - A method of modulating a carrier signal to carry two bits of information in every cycle.
CBB	<u>Communications Base Board</u>
CC	<u>Cluster Controller</u> - An ATCS ground network node responsible for the control of BCP II's.
CLI	<u>Command Line Interface</u>
CRC	<u>Cyclic Redundancy Check</u> - The CRC on a data packet is normally calculated and appended to the data so that the receiver can verify that no data was lost or corrupted during transit.
CRM	<u>Complimentary Radio Module</u>
CSMA/CA	<u>Carrier-Sense-Multiple-Access/Collision Avoidance</u> - A scheme for allowing multiple transmitters sharing a single medium to cooperatively timeshare with a minimum of overlap and interference.
CTC	<u>Central Traffic Control System</u>
CTS	<u>Clear To Send</u>
CPU	<u>Central Processing Unit</u>
DATAGRAM	In general, any ATCS packet. Several types of datagrams are defined for specific functions within an ATCS environment.
dB	Abbreviation for decibel. The standard unit for expressing transmission gain or loss and relative power levels. Decibels indicate the log ratio of power output to power input.

dB <sub>i</sub>	Abbreviation for decibels referenced to an isotropic (unipole) antenna.
dB <sub>m</sub>	Abbreviation for decibels above (or below) one milliwatt.
DCE	<u>Data Communications Equipment</u> - A device that merely transports but does not originate or consume data.
DM DISC	<u>Disconnect Mode Disconnect Frame</u>
DSP	<u>Digital Signal Processor</u>
DTE	<u>Data Terminal Equipment</u> - Any device (printer, terminal, PC, host computer) that originates or consumes data over a transmission facility.
EIA	<u>Electronics Industries Association</u> - A standards organization in the U.S. specializing in the electrical and functional characteristics of interface equipment.
ERP	<u>Effective Radiated Power</u> - The product of the antenna power (transmitter power less transmission-line loss) times either the antenna power gain or the antenna field gain squared.
FDD	<u>Frequency Division Duplexing</u>
FEP	<u>Front End Processor</u> - An ATCS ground network node responsible for providing network access to ground host and terminal users (provides network interfacing).
FIFO	<u>First In, First Out</u> - A buffer or shift register configured so that the first data queued is the first data dequeued - i.e. the sequence is preserved.
FM	<u>Frequency Modulation</u>
FPGA	<u>Field Programmable Gate Array</u>
FRMR	<u>Frame Reject</u>
FSK	<u>Frequency Shift Keying</u> - A baseband modulation technique that conveys digital information over analog facilities by associative discrete logical states with pre-defined frequencies.
GMSK	<u>Gaussian Mask Shift Keying</u> - A complex signal conditioning process employed by the BCM II prior to audio transmission.
GPS	<u>Global Positioning System</u>
GRS	<u>General Railway Signal</u>
HD-FDD	<u>Half Duplex Frequency Division Duplexing</u>
HDLC	<u>High-level Data Link Control</u> - A serial protocol for exchanging synchronous information.

HW	<u>Hardware</u>
IEEE	<u>Institute of Electrical and Electronic Engineers</u>
IF	<u>Intermediate Frequency</u>
IP	<u>Internet Protocol</u> - ISO Model Layer 3 (network) protocol that performs proper routing of packets.
LAN	<u>Local Area Network</u> - A limited network where the data transfer medium is generally wires or cable.
LINK MARGIN	The amount of received signal strength beyond the receiver threshold reserved to compensate for normal signal fluctuations.
NMS	Network Management System
NUL	<u>Null</u> – Used as an identifier for a HDLC protocol.
NULL MODEM	A cable or other device that connects two DTE devices directly by emulating the physical connections of a DCE (the Transmit output of each DTE is connected to the Receive input of the other DTE).
PA	<u>Power Amp</u>
POL	<u>Polled</u> – Used as an identifier for a HDLC protocol.
PSU	<u>Power Supply Unit</u>
QPSK	<u>Quadrature Phase Shift Keying</u> - A method of modulating a carrier signal in such a way that each cycle carries four bits of information.
RCI	<u>Receive Clock In</u>
REJ	<u>Reject frame</u>
RF	<u>Radio Frequency</u>
RFM	<u>Radio Frequency Module</u>
RNR	<u>Receiver Not Ready frame</u>
RS232	EIA interface standard between DTE and DCE, employing serial binary data interchange.
RS422	EIA interface standard that extends transmission speeds and distances beyond RS232, employing a balanced-voltage system with a high level of noise immunity.
RSSI	<u>Received Signal Strength Indication</u> - A numerical value indicating the relative strength of received carrier.

RTS	<u>Ready To Send</u>
RXD	<u>Receive Data</u>
SABM	Set Asynchronous Balanced Mode
SMA	<u>Sub-Miniature version A</u>
SSD	<u>System Status Display</u>
SSH	<u>Secure Shell</u>
SSI	<u>Signal Strength Indicator</u> - A measure of the relative strength of an incoming RF signal when it was received by a BCP II.
SSR	<u>Spread Spectrum Radio</u> - A transmitter/receiver that uses a method of radio transmission in which the transmitted energy is evenly spread over the complete bandwidth of the radio, resulting in small RF signature.
SW	<u>Software</u>
TCI	<u>Transmit Clock In</u>
TCO	<u>Transmit Clock Out</u>
TCP/IP	<u>Transmission Control Protocol / Internet Protocol</u> - The Internet protocol used to connect a world-wide internetwork of universities, research laboratories, military installations, organizations, and corporations. The TCP/IP includes standards for how computers communicate and conventions for connecting network and routing traffic.
TDD	<u>Time Division Duplexing</u>
TTL	<u>Transistor-Transistor Logic</u>
TXD	<u>Transmit Data</u>
UA	<u>Unnumbered Acknowledgment frame</u>
UI	<u>Unnumbered Information frame</u>
UDP	<u>User Datagram Protocol</u> - A transport protocol used primarily for the transmission of network management information. Not as reliable as TCP.
VSWR	<u>Voltage Standard Wave Ratio</u>
WCP	<u>Wayside Communications Package</u> – The transmitter/receiver and associated control processors that handle communications between field equipment and BCP II equipment.
WIU	<u>Wayside Interface Unit</u>

## CHAPTER 1 – INTRODUCTION

### 1.1 SCOPE



#### WARNING

#### WARNING

THE A53680 AIRLINK WAYSIDE COMMUNICATIONS PACKAGE (WCP) IS A NON-VITAL PRODUCT.

CAUTION MUST BE TAKEN WHEN INTERFACING THE AIRLINK WCP TO ANY VITAL SIGNAL OR CROSSING EQUIPMENT AS THE AIRLINK WCP CAN NOT BE USED TO PERFORM, EITHER DIRECTLY OR INDIRECTLY, ANY VITAL FUNCTIONS.

ENSURE THE AIRLINK WCP IS INSTALLED PER MANUFACTURER'S INSTRUCTIONS AND/OR ALL EQUIPMENT INTERCONNECTIONS ARE IN COMPLIANCE WITH RAILROAD PROCEDURES AND SPECIFICATIONS.

This manual is the installation guide for the Siemens A53680 Airlink Wayside Communications Package (WCP) Radio System.

The WCP is periodically upgraded with additional features; therefore, prospective users are encouraged to contact Siemens Mobility for the latest technical information, or to request customization.



Figure 1-1 Airlink Wayside Communications Package (WCP) – Front/Top View



**Figure 1-2 Airlink Wayside Communications Package (WCP) – Top/Right Side View**

## 1.2 SYSTEM FEATURES

The following is a list of system features for the Airlink WCP:

- Uses integrated DC-DC converter with AREMA-compliant isolation. No external DC-DC required.
- Uses built-in fuse for protection with easily replaceable automotive fuses.
- Provides two client ports with configurable RS-232 and RS-422 line levels and synchronous and asynchronous operation.
- Provides a front panel display and pushbuttons for clear diagnostic messages and troubleshooting information.
- Provides Power, Rx, and Tx status indicator LEDs.
- Provides 10/100 Mb Ethernet ports for connection to diagnostic tools and network enabled devices.
- Supports protocol emulation and conversion of many industry standard code-line protocols.
- Provides a non-volatile log.
- Uses a hardware real-time clock for time keeping.
- Supports automatic gain control.
- Uses closed loop power control.
- Supports two modes of operation: ATCS or IEEE 802.16 MC-IoT.

When in ATCS mode, the Airlink WCP:

- Supports all legacy ATCS frequency channel pairs.
- Supports A-block channel pairs A1 and A10.
- Uses half-duplex FDD operation at 4800 baud with GMSK direct FM signaling and Reed-Solomon forward error correction.

When in IEEE 802.16 MC-IoT mode, the Airlink WCP:

- Supports the ATCS channels and AAR A-block frequencies.
- Supports channel bandwidth from 12.5 to 125 KHz.
- Supports aggregation of multiple (up to 12) non-adjacent channels.
- Uses IP-based network traffic routing.
- Supports routing of client port serial ATCS messages to the office.
- Supports GPS antenna for time synchronization and location information.
- Uses half-duplex TDD and FDD at automatically selected modulation, and forward error correction based on configuration settings and channel quality.
- Uses AES 256 for over-the-air encryption.
- Supports quality of service options for throughput and latency.
- Supports configurable uplink and downlink bandwidth utilization.

### 1.3 SPECIFICATIONS

Input Voltage:	10 to 36 VDC
Input Isolation:	2000 V rms
Peak Power Consumption:	10.1 A at 13.5 V
Dimensions:	9 inches (22.86 centimeters) Height 9 inches (22.86 centimeters) Width 10 inches (25.4 centimeters) Depth
Weight:	23.0 pounds (10.4 kilograms)
Operating Temperature Range:	-40 °F to +160 °F (-40 °C to +70 °C)



## 1.4 ORDERING INFORMATION

### 1.4.1 CONFIGURATION OPTIONS

The various configuration options available for the Airlink WCP are provided in the following figure. To order, specify the basic Airlink WCP part number (NYK:9000-53680) plus the applicable dash numbers. Refer also to Section 5.2.

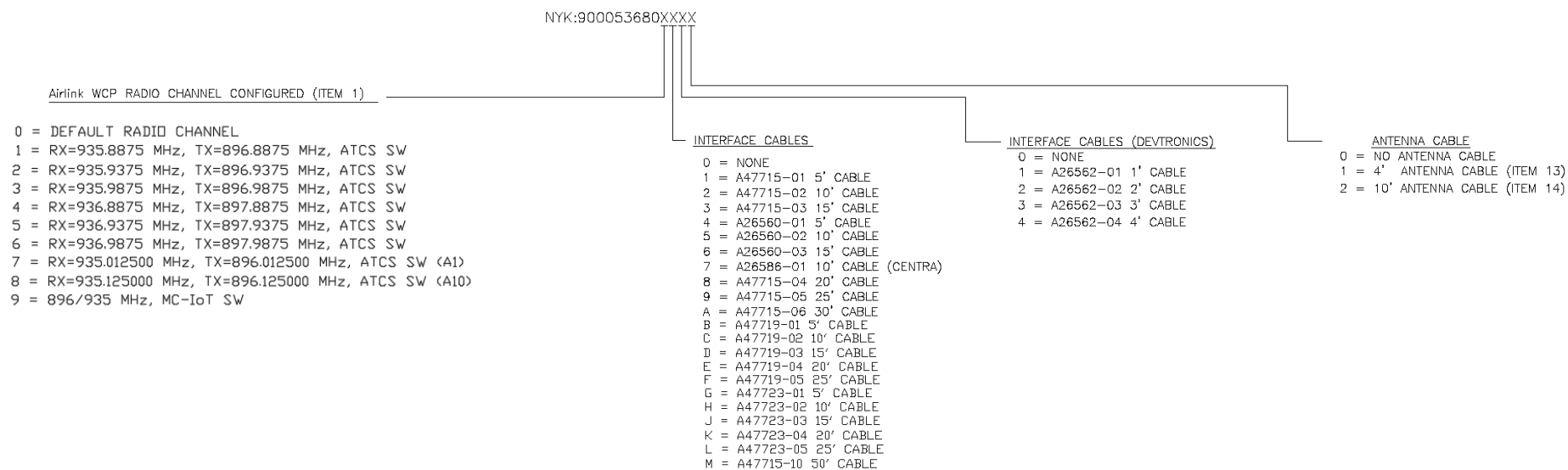

Figure 1-3 Airlink WCP Configuration Chart

This Page Intentionally Left Blank

## 1.4.2 RF CABLE AND ANTENNA INSTALLATION OPTIONS

The RF cable and antenna installation options available for the Airlink WCP are listed in the following table. The listed items are not included with an Airlink WCP order and would need to be ordered if the user requires additional or replacement items.

**Table 1-1 RF Cable and Installation Material Options**

Description	Quantity Included	Siemens Order Number
Yagi antenna	1	Z913-00001-0000
Antenna mast mount, 90 degree. Accommodates masts up to 2.38 inch in diameter.	1	Z801-08468-0000
Pole mast mounting bracket. Accommodates masts between 1.5 and 3.5 inches.	1	Z801-08469-0000
Coaxial RF cable, ½ inch, 50-ohm, foam dielectric	*	Z935-00006-0000
Coaxial RF cable, 7/8 inch, 50-ohm foam dielectric	*	Z935-00008-0000
Coaxial RF cable assembly, 4 foot, ½ inch, 50 ohm super flexible foam dielectric, type mini-UHF male to type N male	1	9000-26561-0001
Coaxial RF cable assembly, 3 foot, ½ inch, 50 ohm super flexible foam dielectric, type N male to type N male	1	Z801-08460-0000
Coaxial RF cable assembly, 10 foot, ½ inch, 50 ohm super flexible foam dielectric, type N male to type N male	1	Z801-08474-0000
Antenna surge arrester, bulkhead mount	1	Z803-22710-0000
RF multi-hit arrester, panel mount	1	Z803-22721-0000
Multi-hit arrester mounting hardware kit	1	Z803-22722-0000
Wall feed-through for ½ inch cable	1	Z918-00012-0000
Connector, type N female, for ½ inch RF cable	1	Z709-01006-0000
Connector, type N male, for ½ inch RF cable	1	Z709-01007-0000
Connector, type N male, for 7/8 inch cable	1	Z709-01011-0000
Connector, type N female, for 7/8 inch RF cable	1	Z709-01012-0000
Grounding kit for ½ inch cable	1	Z801-08458-0000
Grounding kit for 7/8 inch cable	1	Z801-08470-0000

---

Weatherproofing tubing for Bulk-head RF arrester connector, type N to ½ inch RF cable	1	Z801-08462-0000
Weatherproofing tubing for Yagi antenna connector, type N to ½ inch RF cable	1	Z801-08461-0000
Weatherproofing tubing for Bulk-head RF arrester connector, type N to 3/8 inch RF cable	1	Z801-08471-0000
Weatherproofing tubing for Yagi antenna connector, type N to 3/8 inch RF cable	1	Z801-08472-0000
RF multi-hit arrester, panel mount	1	Z803-22721-0000
Hangers for ½ inch cable	10	Z801-08473-0000
Hangers for 7/8 inch cable	10	Z801-08473-0000
D connector/splice weather proofing kit	1	Z801-08467-0000
Band clamp, 2 to 3 inch diameter	10	Z918-00013-0000

\* Quantity determined by installation requirements

## CHAPTER 2 – FUNCTIONAL DESCRIPTION

### 2.1 AIRLINK WCP OVERVIEW

The Airlink WCP supports two modes of operation: ATCS or IEEE 802.16 MC-IoT.

#### 2.1.1 ATCS MODE

In ATCS mode the Airlink WCP is used in an Advanced Train Control System (ATCS) data network to perform the following general functions:

- Provide the interface between the Base Control Package (BCP) and the wayside equipment.
- Deliver ATCS messages to, and receive messages from, wayside equipment via an RF link.
- Deliver application messages to, and receive messages from, vital and non-vital code units, and RS-232/RS-422 communication devices via the serial ports.

Refer to Appendix A for further information on the ATCS data network.

#### 2.1.2 IEEE 802.16 MC-IoT MODE

In MC-IoT mode the Airlink WCP operates as a Remote Station in an IEEE 802.16 data network to perform the following general functions:

- Connect to an Airlink BCP operating in Dual or MC-IoT, or other IEEE 802.16 Base Station.
- Operate as a Layer 2 Bridge between its Ethernet ports and those of the Airlink BCP or other IEEE 802.16 Base Station.
- Support all IEEE 802.16 functionality including Adaptive Modulation and Coding, Automatic Power Control, Quality of Service, and Security features.
- ATCS messages can be sent between BCP and WCP in MC-IoT mode using discrete service flows.

## 2.2 AIRLINK WCP FUNCTIONAL DESCRIPTION

The Airlink WCP integrates an isolated DC-DC conversion module, CPU module, and software-defined radio module into one package. The software-defined radio module allows for advanced configurability and flexibility.

The main functional components of the Airlink WCP are shown in Figure 2-1.

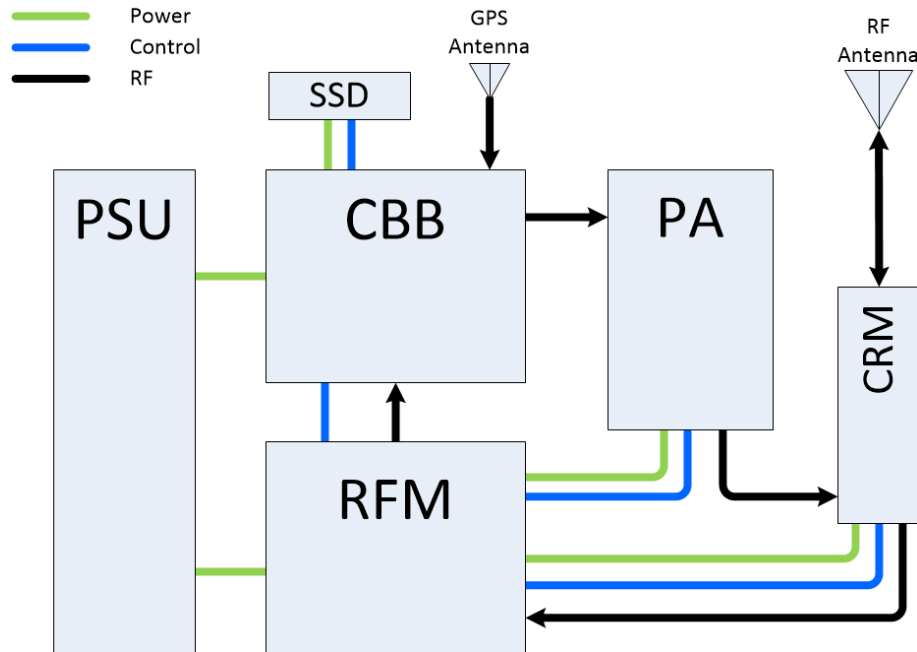

**Figure 2-1 Airlink WCP System Block Diagram**

The Airlink WCP radio platform system is comprised of the following sub-systems as shown in the figure above:

- PSU: Power Supply Unit
- CBB: Communications Base Board
- RFM: Radio Frequency Module
- PA: Power Amplifier
- CRM: Complimentary Radio Module
- SSD: System Status Display
- RF Antenna: Transmit Receive Signal
- GPS Antenna: GPS Signal

The following sections describe each subsystem within the Airlink WCP radio platform.

### 2.2.1 POWER SUPPLY UNIT

The Airlink WCP Power Supply Unit (PSU) converts the system input voltage to the voltages required by different elements of the system.

The input voltage range is 10 to 36 VDC. The internal voltages are:

- 5 VDC
- 7 VDC
- 12 VDC
- 28 VDC
- 150 VDC

## 2.2.2 COMMUNICATIONS BASE BOARD

The Airlink WCP Communications Base Board (CBB) acts as the main controller for the system. It provides general purpose computing resources based on an embedded Linux Operating System.

The CBB also includes logic implemented in FPGAs, DSPs, and a programmable RF Transceiver.

The CBB supports the following user interfaces:

- Reset button with embedded power LED.
- 2x 10/100 Mb Ethernet through onboard RJ45 sockets.
- Combined Serial Data and Console interface through onboard RJ45 socket.
- GPS antenna connection.

The CBB includes a GPS receiver to provide system and network synchronization using the 1-PPS signal, and GPS data to provide location, time of day, speed, and heading information.

**NOTE****NOTE**

GPS is optional.

The CBB provides the TX signal directly to Power Amplifier.

The CBB has a control and status interface with the Radio Frequency Module (RFM) and receives RX signal as an Intermediate Frequency (IF) from the RFM. The CBB also provides the RFM with a 40 MHz reference clock signal.

The CBB provides status information to the System Status Display under software control.

## 2.2.3 RADIO FREQUENCY MODULE

The Airlink WCP Radio Frequency Module (RFM) supports a wide range of operational frequencies that are converted into an Intermediate Frequency (IF) for common filtering. The IF RX signal is routed to the CBB.

The RFM provides a power, control, and status interface to the Power Amplifier. The RFM provides a power and control interface to the Complimentary Radio Module (CRM) to switch the

system between TX and RX modes for Time Division Duplexing (TDD) and Half Duplex Frequency Division Duplexing (HD-FDD).

#### **2.2.4 POWER AMPLIFIER**

In general applications, the PA board supports a frequency range of 890 – 950 MHz and provides an output power of up to 30 Watts.

The PA uses a 28 VDC power supply from the RFM. The RFM uses a TTL logic line to turn the PA on or off according to the TX and RX phases of system operation in TDD or HD-FDD modes.

The PA status interface provides the RFM with its internal temperature in °C and current consumption in milli-Amps.

#### **2.2.5 COMPLIMENTARY RADIO MODULE**

The Airlink WCP Complimentary Radio Module (CRM) switches between TX and RX modes for Time Division Duplexing (TDD) and Half Duplex Frequency Division Duplexing (HD-FDD).

#### **2.2.6 SYSTEM STATUS DISPLAY**

The Airlink WCP uses a Vacuum Florescent Display (VFD) module as a system status display. The display comprises a 2x16 character interface to provide the user with system status information under the control of the CBB.

#### **2.2.7 RF ANTENNA**

The Airlink WCP RF antenna is typically provided by the end-user based on operational requirements. The antenna should be matched to the operational frequency, with an impedance of 50 ohm.

#### **2.2.8 GPS ANTENNA**

The Airlink WCP GPS antenna is used to provide the GPS signal to the CBB.

The antenna should be an active device to support the 5 VDC provided by the CBB.

**NOTE****NOTE**

The GPS antenna is optional.



## CHAPTER 3 – AIRLINK WCP CONNECTORS

### 3.1 GENERAL

This section describes the connectors associated within the A53680 Airlink WCP equipment installation.

### 3.2 AIRLINK WCP EXTERNAL CONNECTORS

The Airlink WCP is equipped with eight connectors (see Figure 3-1) which include:

- two 25-pin D-type client port connectors.
- a type N RF antenna connector.
- an SMA GPS antenna connector.
- a 2-pin power connector.
- an RJ45 for a serial console connection to a PC.
- two RJ45 connectors for connection to a local network.

The pin assignments for each of these connectors are described in the following paragraphs.

#### 3.2.1 25-PIN D-TYPE CLIENT PORT CONNECTORS (FEMALE)

The female, 25-pin, D-type connectors (J1 and J2) located on the top of the Airlink WCP enclosure provide serial client ports that can be configured for RS-232 or RS-422 operation during configuration. Similarly, for synchronous protocols, the direction of the transmit clock for each port is software configurable to work either as a DCE or DTE device. Table 3-1 lists the pin assignments for the 25-pin connectors.

**Table 3-1 25-Pin D-Type Connector Pin Assignments**

Pin	RS-232	RS-422
2	Tx Data out	Tx data (-) out
3	Rx Data in	Rx data (-) in
4	RTS out	RTS (-) out
5	CTS in	CTS (-) in
7	Common	Common
9		Rx Clock (+) in
12		Tx Clock (+) in
13		CTS (+) in
14		Tx data (+) out
15	Tx clock in	Tx clock (-) in
16		Rx data (+) in

Pin	RS-232	RS-422
17	Rx clock in	Rx clock (-) in
18		Tx clock (+) out
19		RTS (+) out
24	Tx clock out	Tx clock (-) out

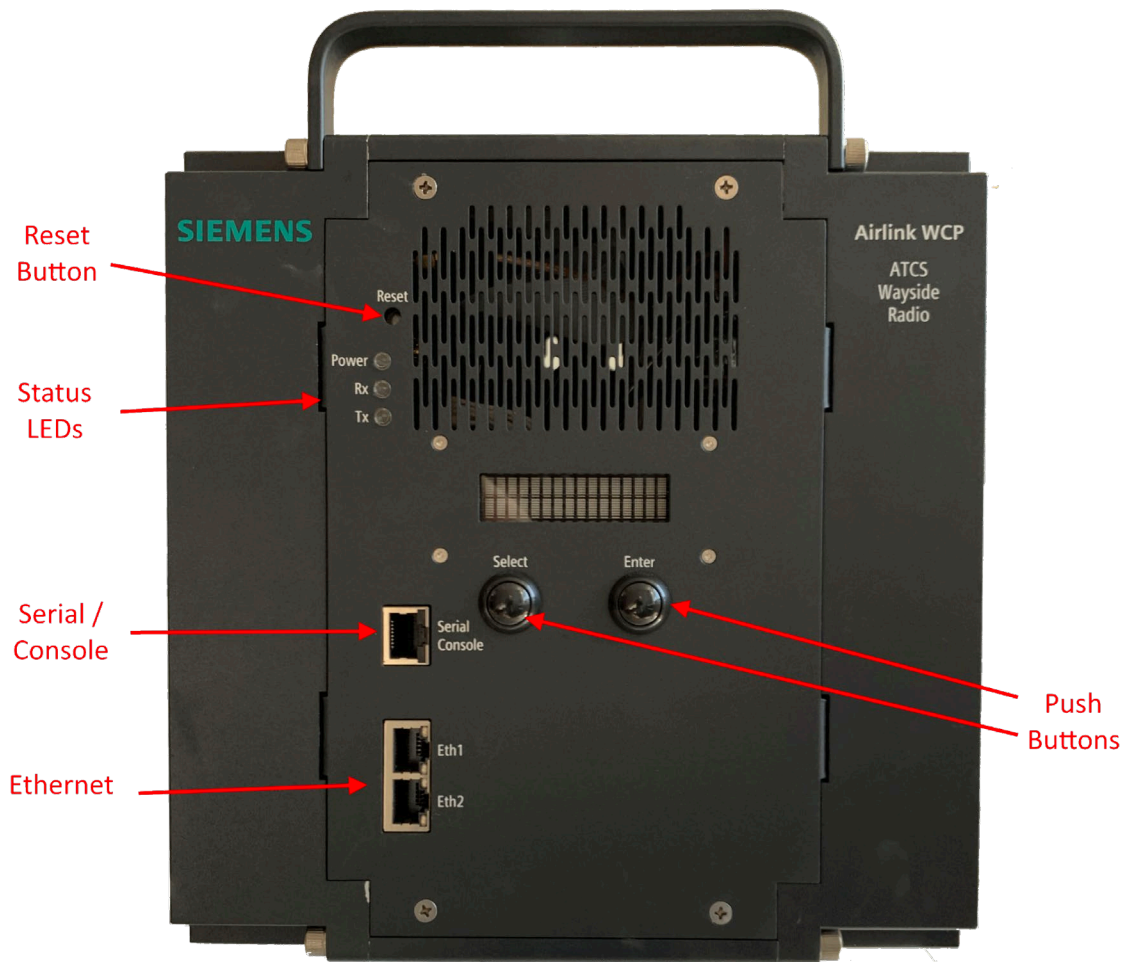

Figure 3-1 Airlink WCP – Front View

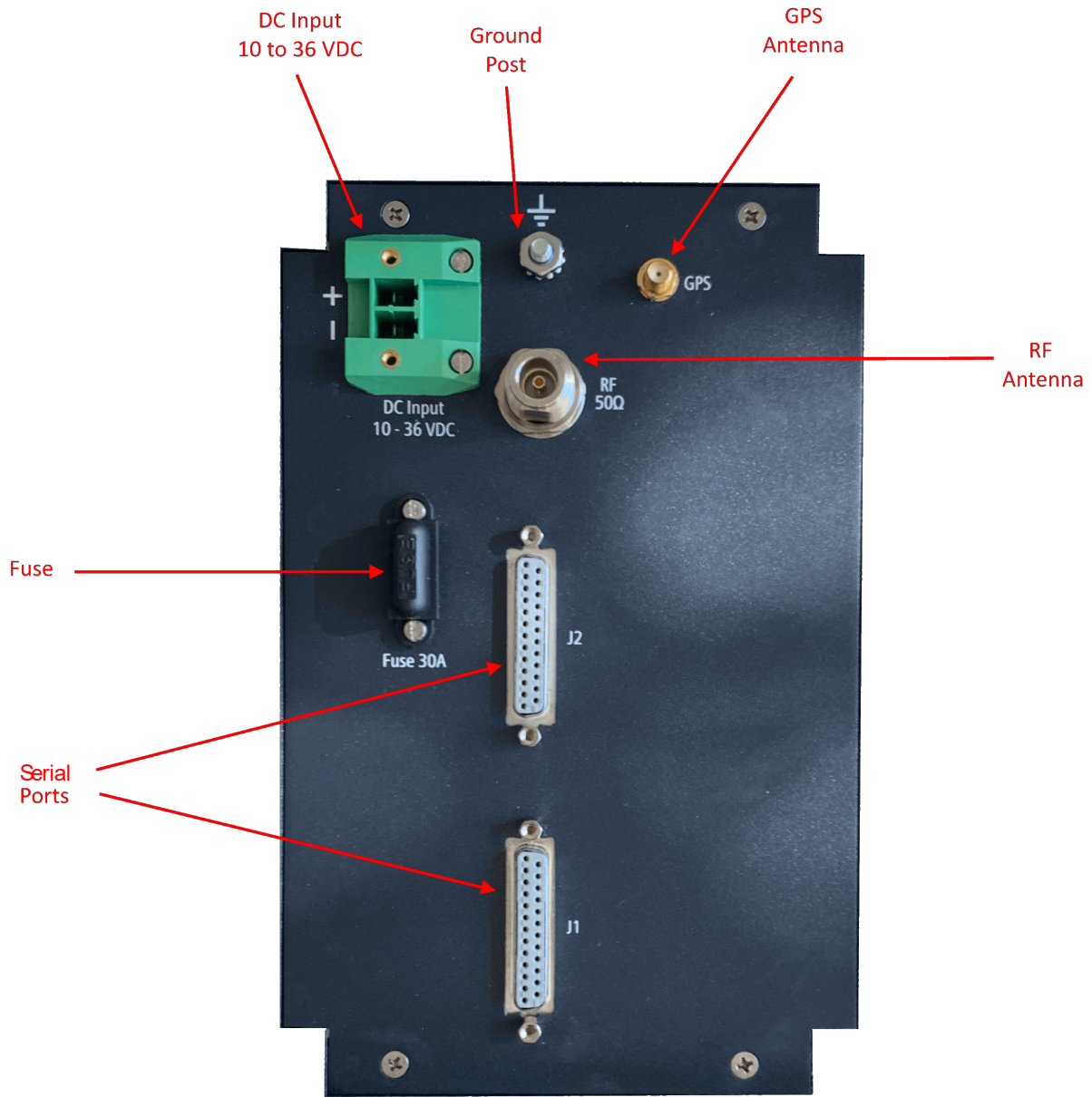

Figure 3-2 Airlink WCP – Top View

### 3.2.2 SERIAL CONSOLE CONNECTOR (RJ45)

The RJ45 socket provides a combined serial data and console interface according to the following pinout.

**Table 3-2 RJ45 Serial Console Connector Pin Assignments**

Pin	Function
1	Ground
2	Ground
3	Serial Data RX
4	Ground
5	Ground
6	Serial Data TX
7	Console RX
8	Console TX

The serial data pins match those used by the Cisco RS232 standard. An adapter cable is available to convert the console interface to the same standard.



**Figure 3-3 RJ45 Serial Console Adapter Cable**

### 3.2.3 2-PIN POWER CONNECTOR (MALE)

The male, 2-pin, Phoenix power connector has 2 connector pin assignments. The Phoenix connector part number is 1828249.



**Figure 3-4 Phoenix Connector: Part Number 1828249**

**Table 3-3 Phoenix Connector Pin Assignments**

Pin	Function
1	DC Power +
2	DC Power -

### 3.2.4 ETHERNET PORT CONNECTORS

The RJ45 Ethernet connectors “Eth1” and “Eth2” are wired according to the 10/100 Mbit standard as described in the following table.

**Table 3-4 RJ45 Serial Console Connector Pin Assignments**

<b>Pin</b>	<b>Function</b>
1	Receive +
2	Receive -
3	Transmit +
4	Not used
5	Not used
6	Transmit -
7	Not used
8	Not used

## CHAPTER 4 – INSTALLATION

### 4.1 GENERAL

The Airlink WCP can be wall or shelf mounted, or mounted on a standard GRS Style B relay rack as shown in Figure 4-2. The unit is secured at the top by a teardrop arrangement and at the bottom by a retaining bolt.

The Airlink WCP is equipped with a bracket to permit mounting in a relay rack. The following figure provides the dimensions of the Airlink WCP.

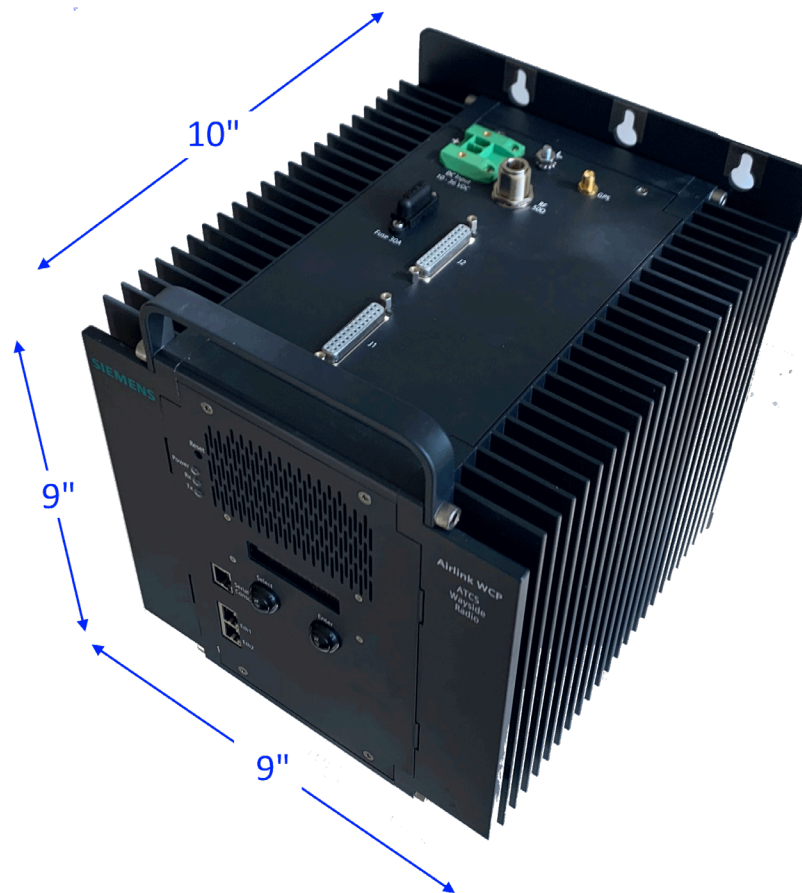

Figure 4-1 Airlink WCP Dimensions

## 4.2 POWER

The Airlink WCP has a built-in isolated DC-DC converter and can be powered directly from a battery. It supports 10 to 36 VDC input power.

### NOTE

### NOTE

The transmit current requires use of number 10 AWG or larger wire to ensure that significant voltage drop does not occur when the transmitter is keyed.

## 4.3 MOUNTING THE AIRLINK WCP

The following figure provides a view of the back plate of the Airlink WCP and dimensions for when mounting to a rack or wall.

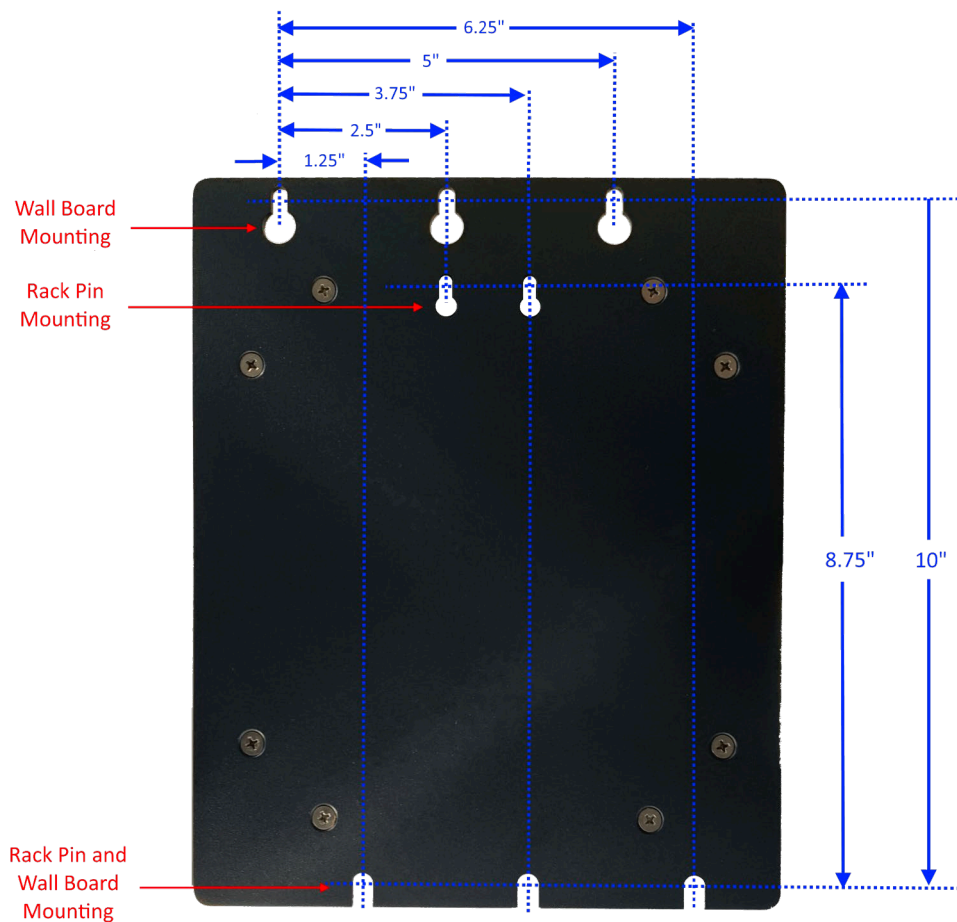

Figure 4-2 Airlink WCP Rear Panel Dimensions



**⚠ CAUTION****CAUTION**

**DO NOT** INSTALL PRIMARY SURGE PROTECTION, OTHER THAN ARRESTERS AND EQUALIZERS ON THE INPUT TO THE AIRLINK WCP AS THE ADDED INDUCTANCE MAY CAUSE THE UNIT TO WORK ERRATICALLY AT LOW INPUT VOLTAGES.

**NOTE****NOTE**

At low input voltages, instantaneous current can exceed 25A, and it is therefore extremely important to ensure tight connections and adequate wire gauge (minimum #10 AWG).

#### 4.3.1 RACK/SHELF MOUNTING

The following figures show a typical rack mounted Airlink WCP from various angles to assist with installation.

**⚠ CAUTION****CAUTION**

WHEN RACK MOUNTED THE AIRLINK WCP IS USUALLY GROUNDED THROUGH THE MOUNTING BOLTS.

IF THIS IS NOT THE CASE, A SEPARATE GROUNDING WIRE (MINIMUM #10 AWG) MUST BE CONNECTED BETWEEN THE GROUND POST ON THE TOP PANEL (AS SHOWN IN Figure 4-3) AND THE BUILDING GROUND.



**Figure 4-3 Airlink WCP Top View when Mounted to Rack**



**Figure 4-4 Airlink WCP Bottom View when Mounted to Rack**



**Figure 4-5 Airlink WCP Rear View when Mounted to Rack**

### 4.3.2 INSTRUCTIONS FOR WALL MOUNTING

The following figure shows a typical wall mounted Airlink WCP.



#### CAUTION

WHEN MOUNTED ON A WALL BOARD THE AIRLINK WCP REQUIRES A GROUNDING WIRE (MINIMUM #10 AWG) FROM THE GROUND POST ON THE TOP PANEL (AS SHOWN IN Figure 4-7) TO THE BUILDING GROUND.



Figure 4-6 Typical Airlink WCP Wall Installation – Front View



Figure 4-7 Typical Airlink WCP Wall Installation – Top View

#### 4.4 EQUIPMENT INTERCONNECT CABLING

Once the Airlink WCP equipment is installed, connect the equipment as described in the following section.

### 4.4.1 AIRLINK WCP BASIC CABLING

The equipment cabling for a basic Airlink WCP installation is shown in Figure 4-8 and Figure 4-9. All necessary information is provided in the following figures and in Table 4-1. The cable numbers listed in the left column of Table 4-1 correspond to the cable numbers (e.g. #2 and #3 Customer Battery Lines) appearing in Figure 4-8.

**Table 4-1 Airlink WCP Interconnect Cable Descriptions**

Cable #	Part Number	Where Used	Termination
1	See Appendix E	Airlink WCP to Antenna	Male N to male N
2	Customer supplied	Airlink WCP to battery	Phoenix Power Connector to 10/12 AWG insulated ring lug
3	Customer supplied	Airlink WCP to battery	Phoenix Power Connector to 10/12 AWG insulated ring lug
4	See Figure 4-10 to Figure 4-13.	Airlink WCP to Code Unit	Figure 4-10 and Figure 4-11

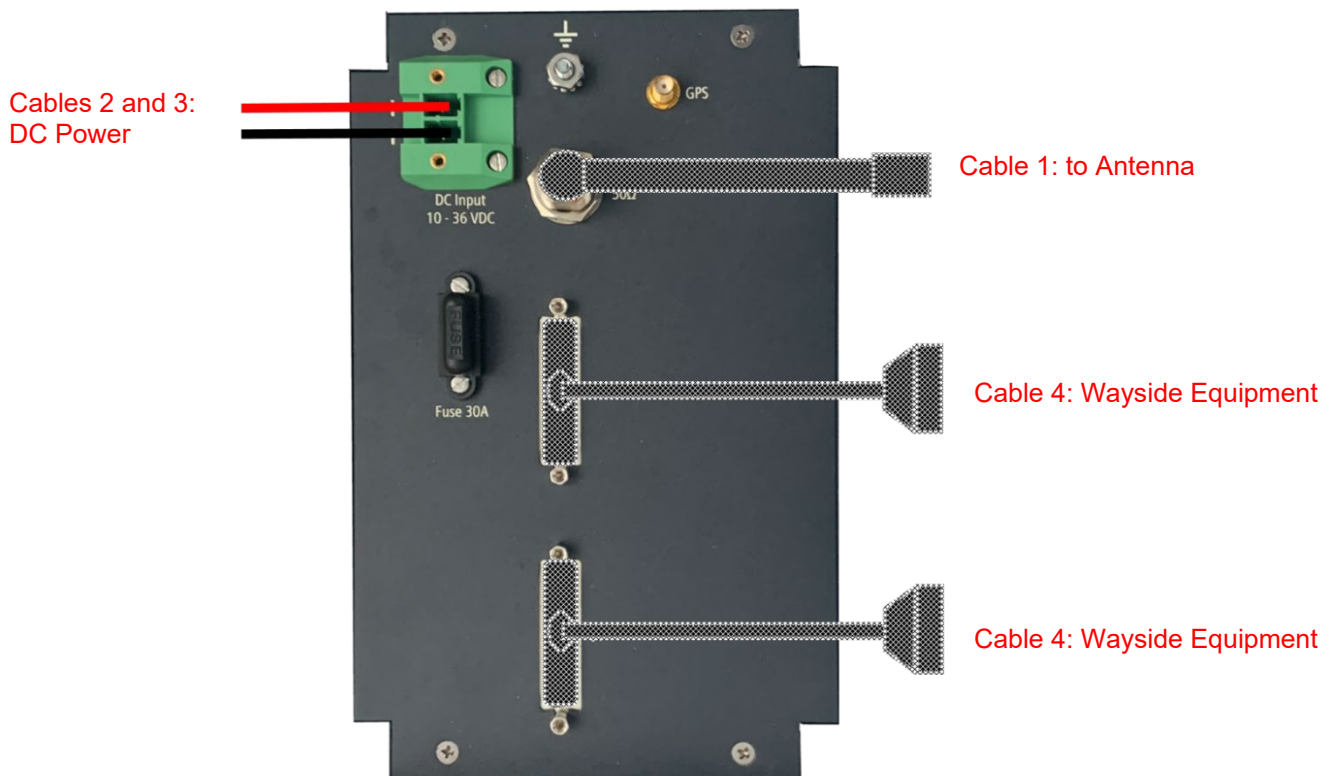

**Figure 4-8 Airlink WCP Typical Interconnect Diagram – Top**

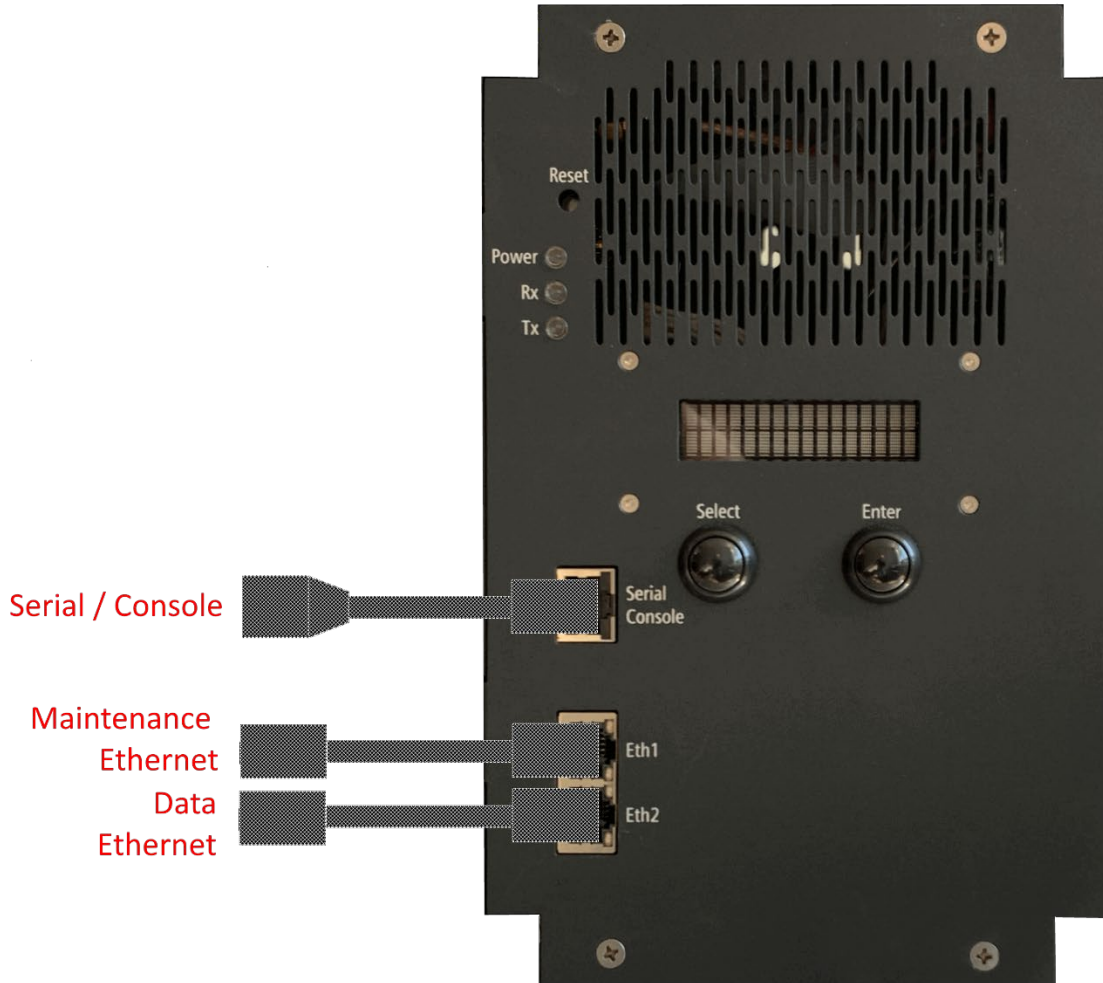

**Figure 4-9 Airlink WCP Typical Interconnect Diagram – Front Panel**



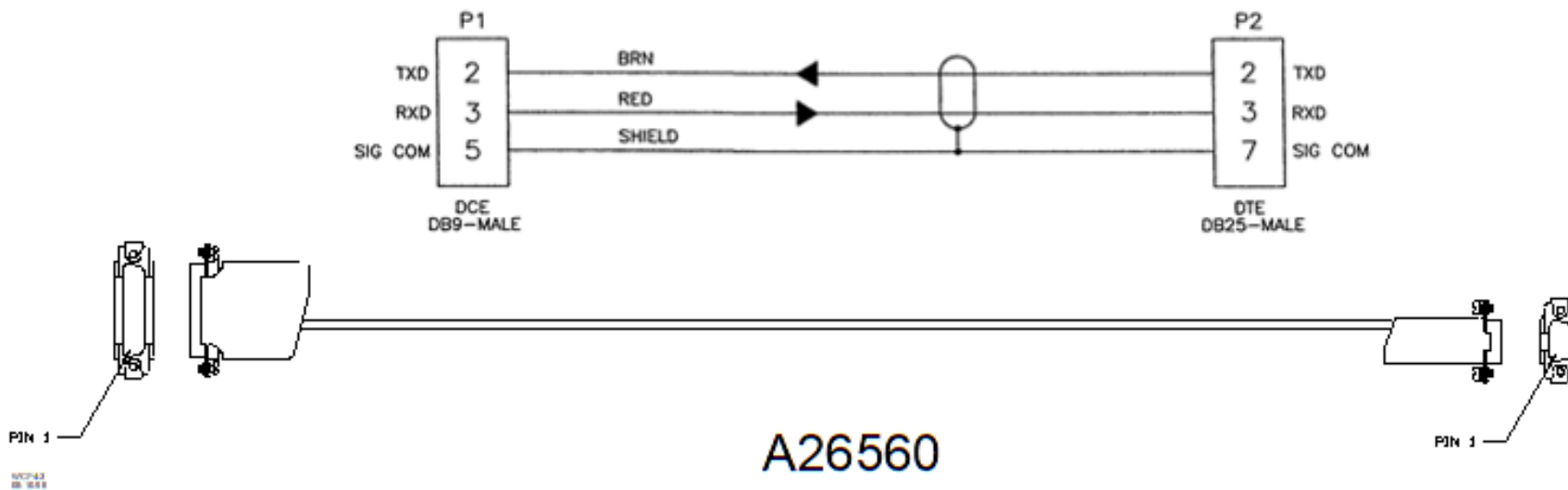

Figure 4-10 A26560 Cable Assy, Airlink WCP to Local Control Panel

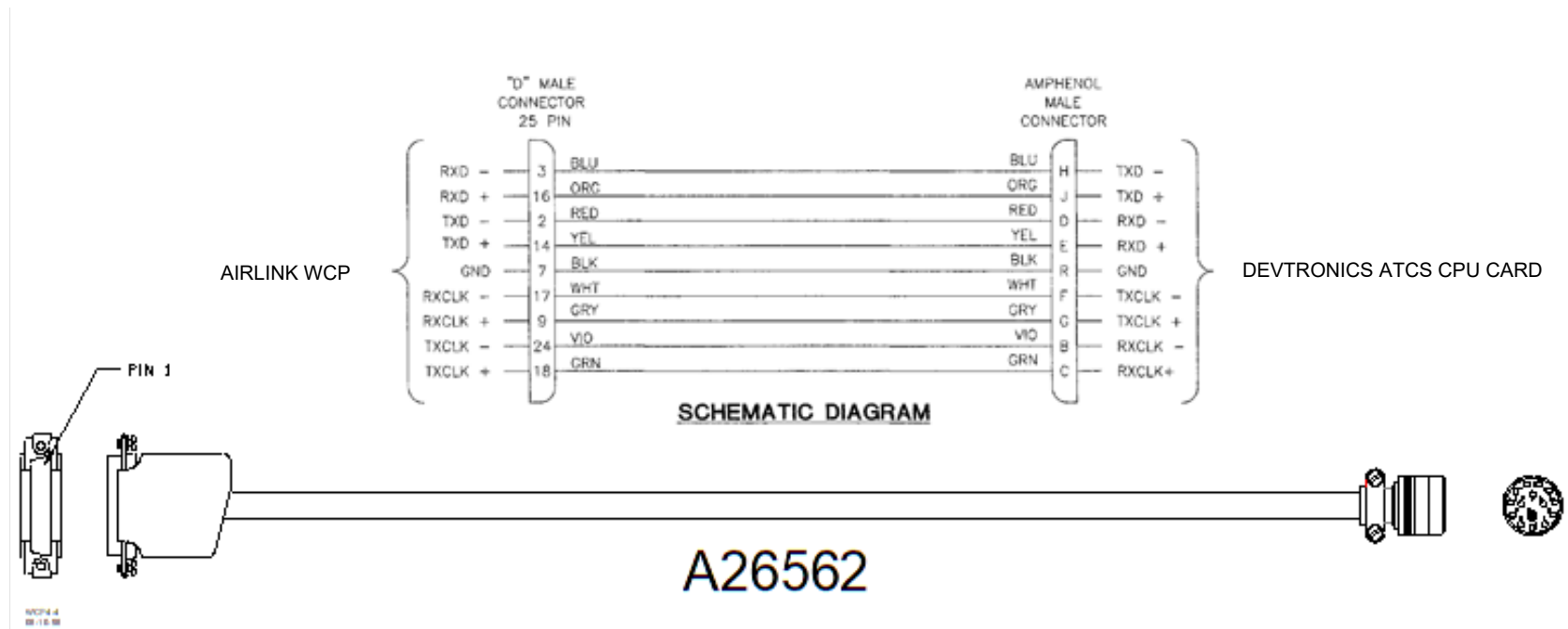
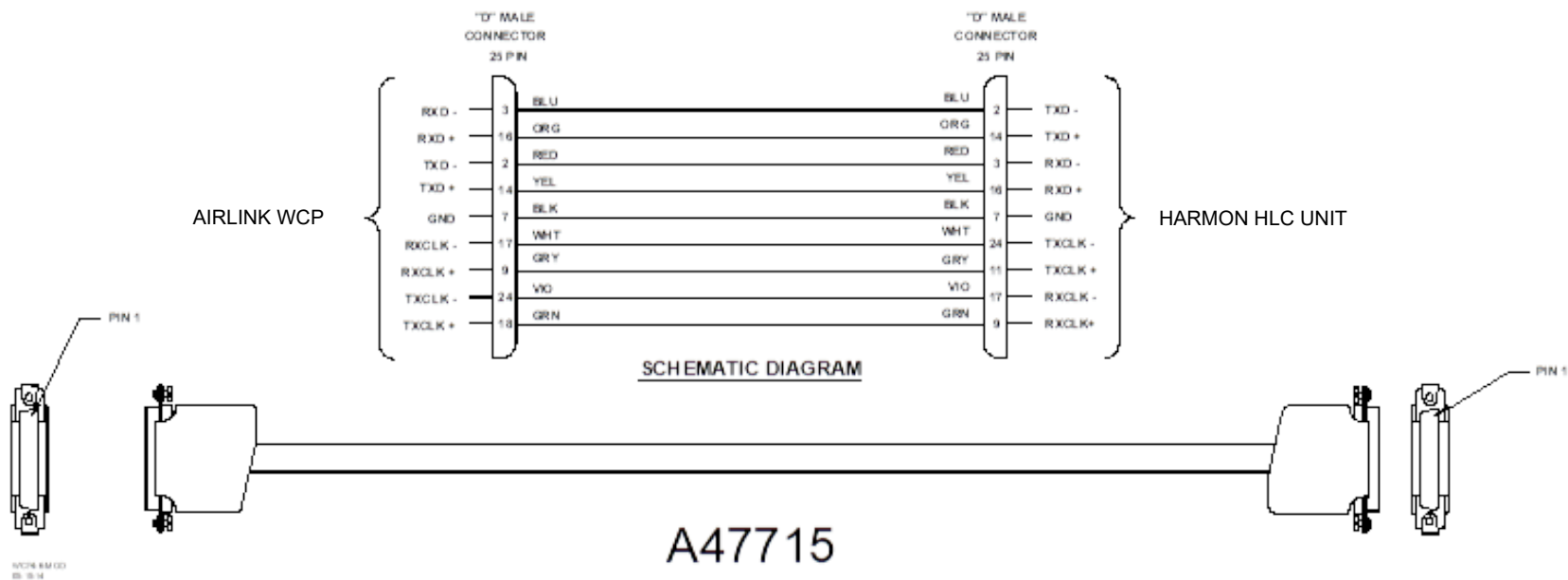
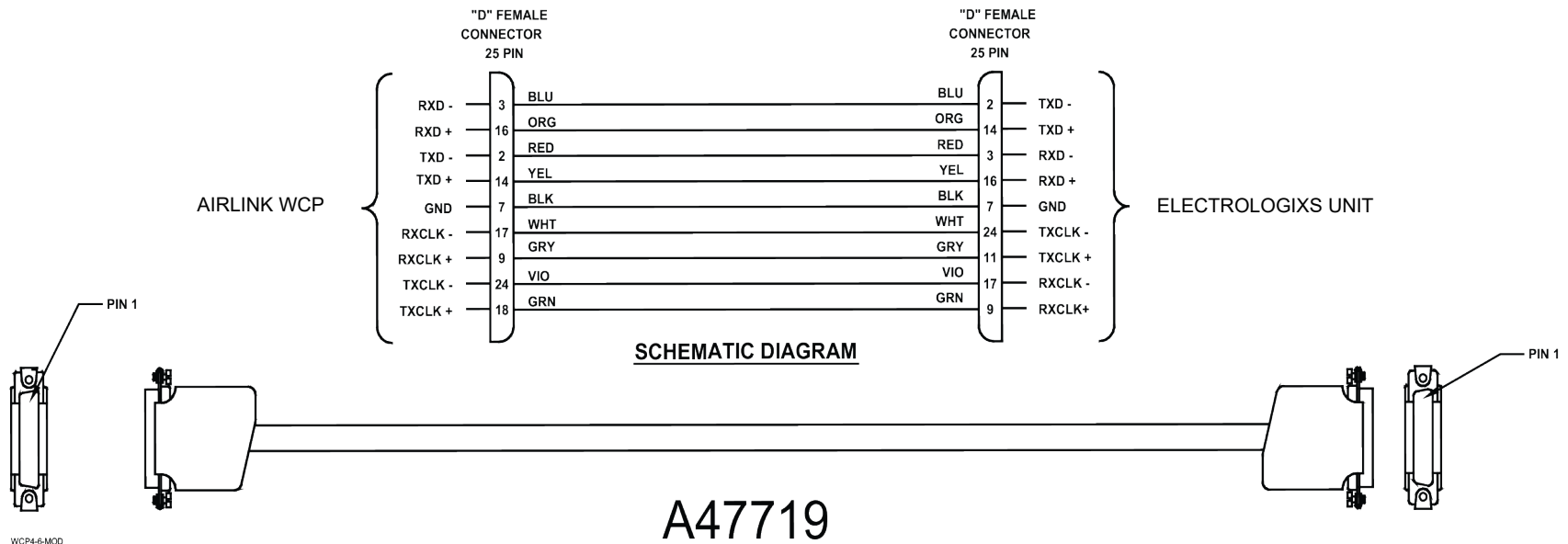
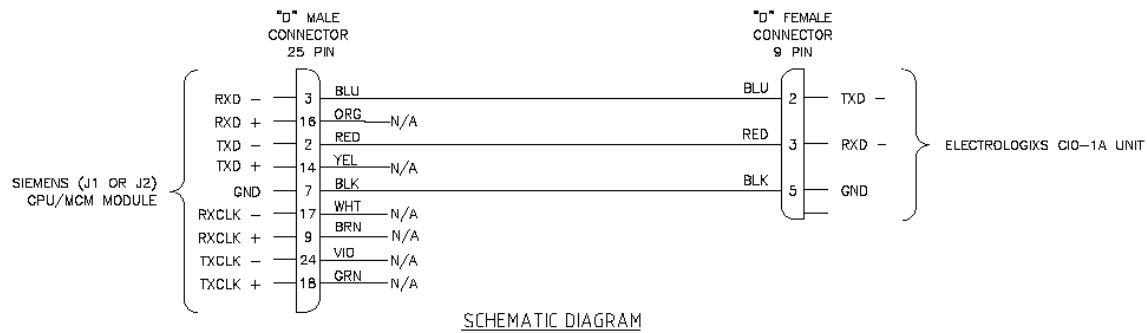
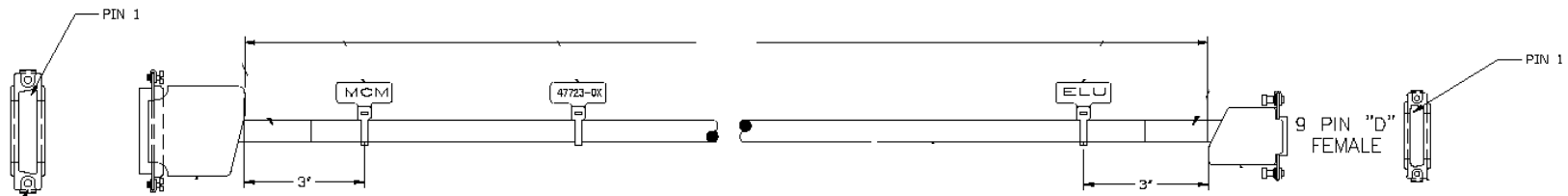

Figure 4-11 A26562 Cable Assy, Airlink WCP to Devtronics ATCS CPU Card



**Figure 4-12 A47715 Cable Assy, Airlink WCP to Harmon HLC Unit**





**Figure 4-14 A47723 Cable Assy, Airlink WCP to ElectroLogIXS CIO-1A Unit**

This Page Intentionally Left Blank

## CHAPTER 5 – AIRLINK WCP OPTIONS

### 5.1 GENERAL

This section lists the options available for Airlink WCP installations. For further information, contact Siemens Mobility, Inc. Technical Support.

### 5.2 BASIC CONFIGURATION OPTIONS

The basic configuration options available for the Airlink WCP are provided in Chapter 1, Figure 1-3. To order, specify the basic Airlink WCP part number (NYK:9000-53680) plus the applicable dash numbers. Refer to the ordering information in Chapter 1.

#### 5.2.1 INSTALLATION OPTIONS

The Airlink WCP can be wall, shelf, or rack mounted. Refer to Section 4.3 for typical mounting options. The equipment cabling for a typical installation is shown in Figure 4-8 and Figure 4-9. All necessary interconnect information is provided in Table 4-1.

### 5.3 PERIPHERAL INTERCONNECTION CABLES

The peripheral interconnection cables used with the Airlink WCP are provided in the following table.

**Table 5-1 Peripheral Interconnection Cables**

<u>WCP TO DEVTRONICS ATCS CABLE</u>			
NYK:9000	-	26562	-
00		XX	
Reserved		Reserved	02 2 Foot Length
			04 4 Foot Length

  

<u>WCP TO MCM/CPU-LCP PANEL SERIAL CABLE</u>			
NYK:9000	-	26560	-
000		X	
Reserved		Reserved	01 5 Foot Length
			02 10 Foot Length
			03 15 Foot Length

  

<u>WCP TO CENTRACODE CABLE</u>			
NYK:9000	-	26586	-
00		XX	
Reserved		Reserved	01 10 Foot Length

**WCP TO HARMON LOGIC CONTROLLER CABLE**

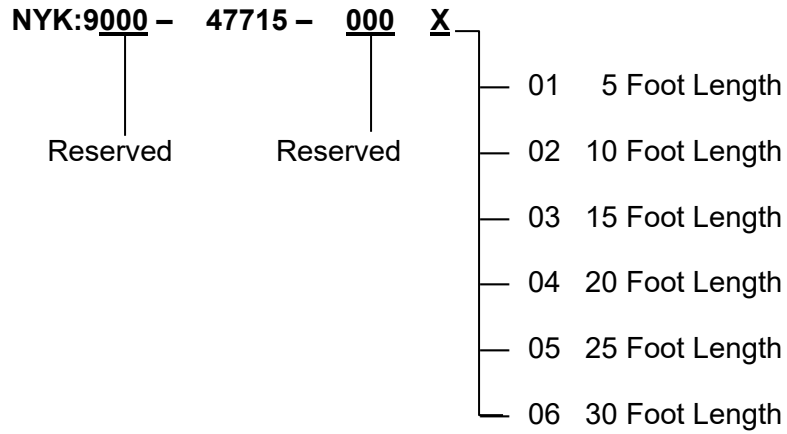

**WCP TO MCP ELECTROLOGIXS CABLE**

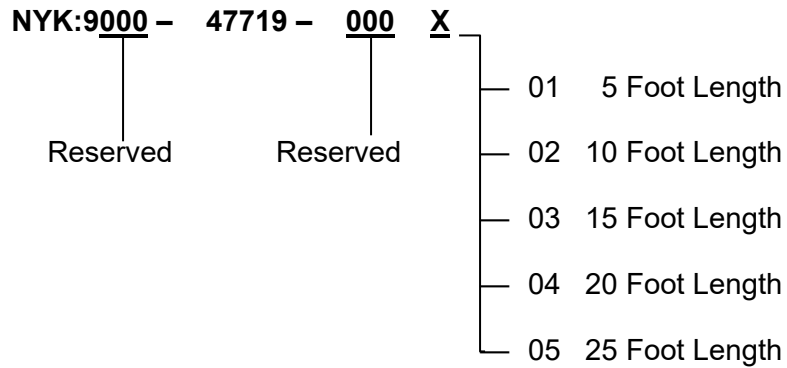

**WCP TO MCP ELECTROLOGIXS CIO-1A CABLE**

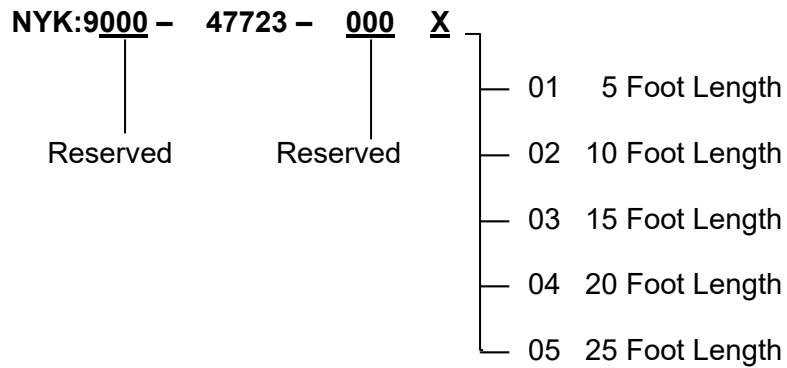



## CHAPTER 6 – FRONT PANEL DESCRIPTION

The following chapter describes the functions of the push buttons on the front panel display of the Airlink WCP.

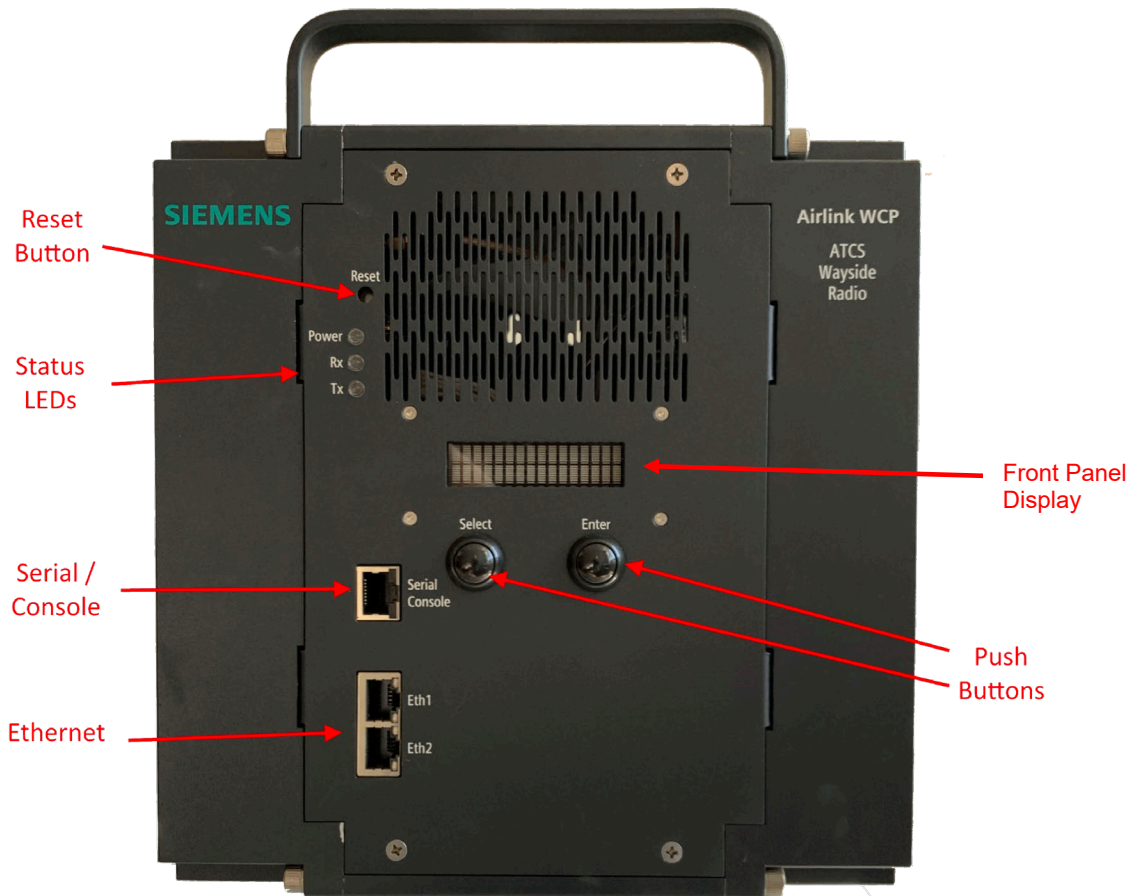

**Figure 6-1 Airlink WCP Front Panel showing Push Buttons**

The front panel display design is based on the following menu tree. Display information is categorized as follows:

1. General details
2. RF port details
3. Serial J1 port details
4. Serial J2 port details
5. Restore default settings

The above menu options are shown at the primary level. They can be viewed sequentially by pressing the 'Select' push button. Press the 'Enter' push button to enter into the secondary level. Secondary level information can be viewed sequentially by pressing the 'Select' push button. On pressing the 'Enter' button in the secondary level, the menu will return to the primary level.

The following are screenshots of the 2x16 Vacuum Florescent Display (VFD) display showing the primary level menu options.

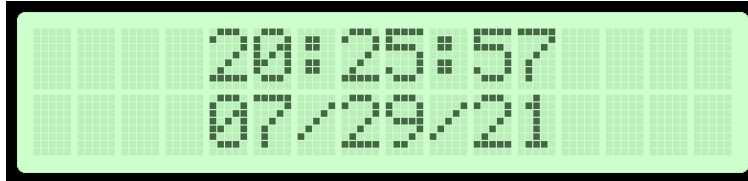

**Figure 6-2 Front Panel Display Primary Level Menu Options**

## 6.1 GENERAL DETAILS MENU

The following information can be viewed sequentially on entering the *General details* Menu.

1. Time and date



2. Device Type

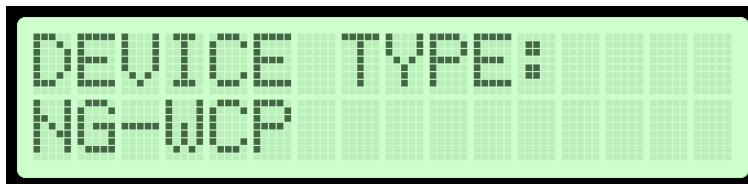

3. SW Package version

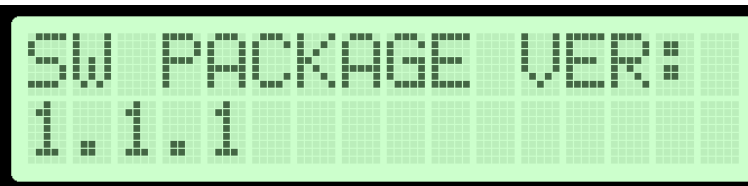

4. Siemens SW version

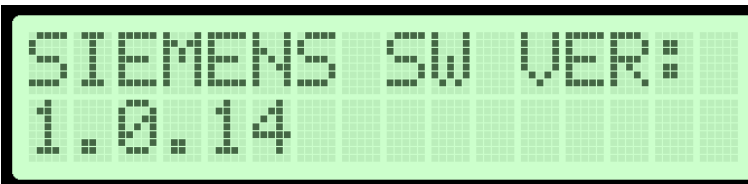

5. ATCS address

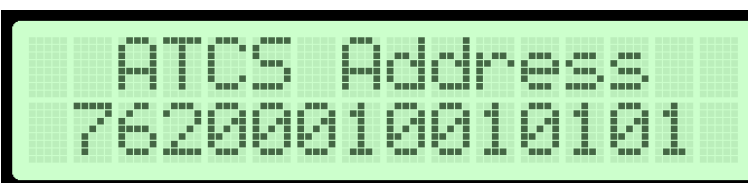

## 6. IP address

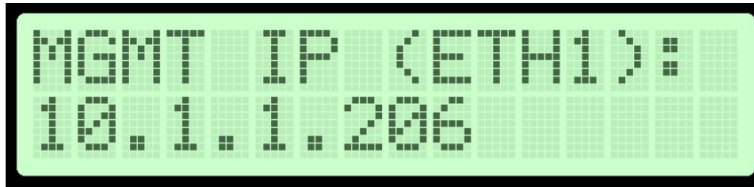

## 7. Ground contact status – Success/Failure

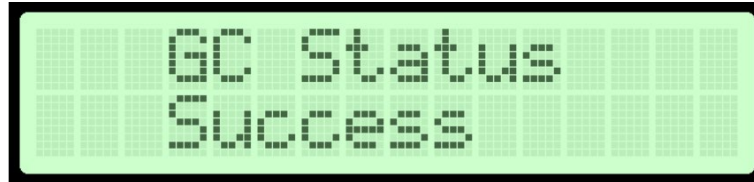
**6.2 RF PORT DETAILS MENU**

The following information can be viewed sequentially on entering the *RF port details* menu. When the WCP is in MC-IoT Mode, only Received Signal Strength Indication (RSSI) information and RF Port Data count details are viewable.

## 1. Operating frequency



## 2. RSSI info

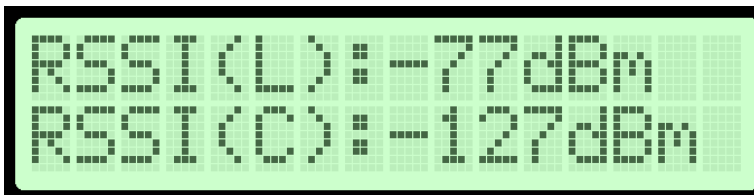

(L) represents RSSI of the last received ATCS packet.

(C) represents the current RSSI reading.

3. RF power level

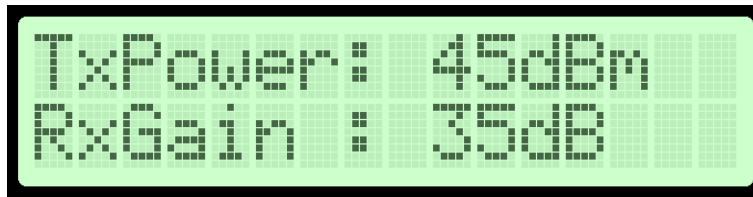

4. RF port Data Count

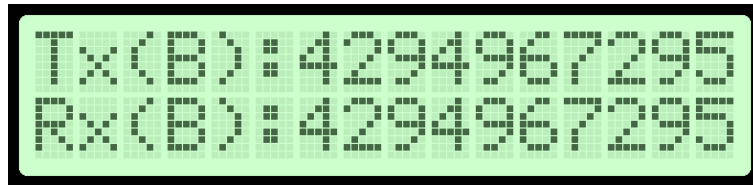

**6.3 SERIAL PORT J1 DETAILS & SERIAL PORT J2 DETAILS MENUS**

In these menus, the list of parameters viewed are based on the configured Communication mode: Synchronous or Asynchronous mode.

The following screenshots are the common parameters displayed for both modes.

1. Communication mode – Synchronous (or) Asynchronous

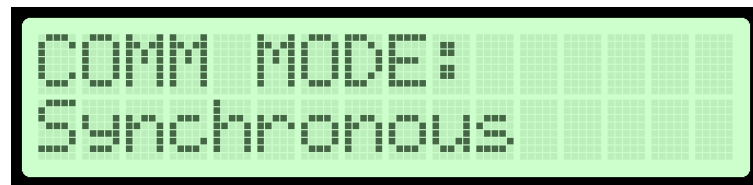

2. Tx/Rx activity of serial port

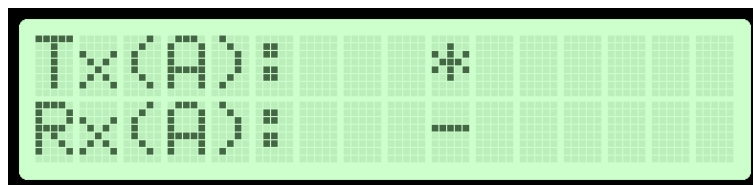

(A) denotes Activity.  
 Asterisk (\*) represents active.  
 Dash (-) represents non-active.

3. Baud Rate

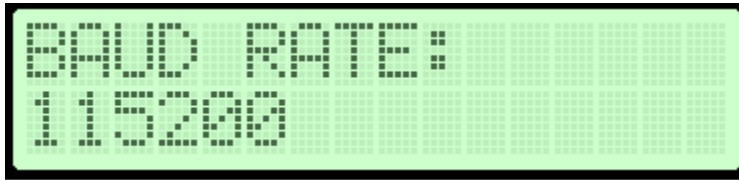

4. Protocol

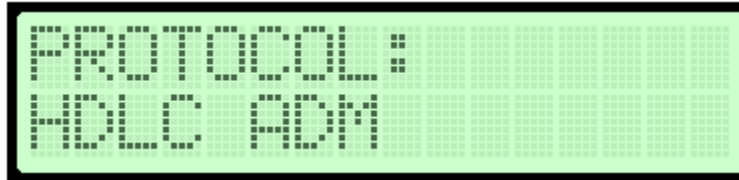

5. Tx/Rx Valid Frame Count

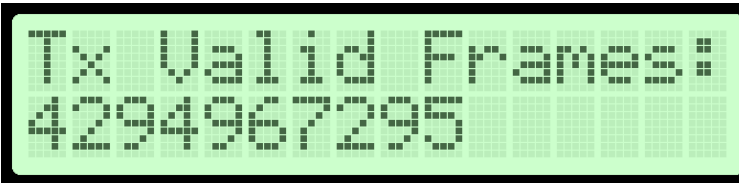

6. Tx/Rx Data Count

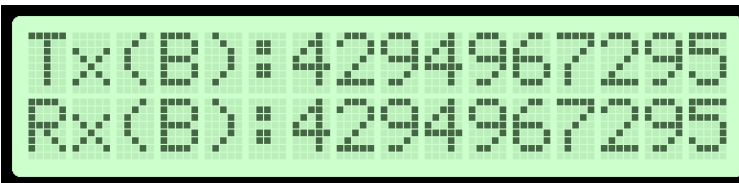

(B) denotes bytes count

7. CRC Error Count

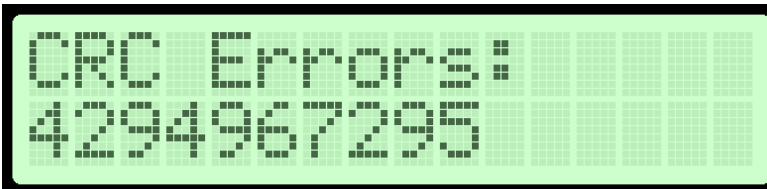

## 8. Overrun Count

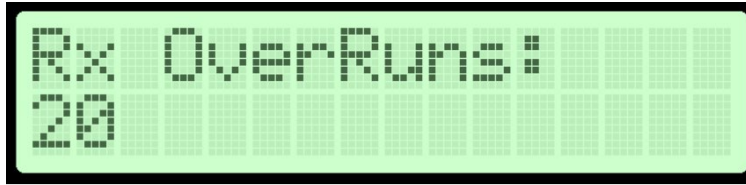

### 6.3.1 ASYNCHRONOUS MODE

The following are the list of parameters displayed when Asynchronous mode is configured:

1. Parity Error Count
2. Framing Error Count

### 6.3.2 SYNCHRONOUS MODE

The following are the list of parameters displayed when Synchronous mode is configured:

1. Tx/Rx HDLC Frame Count
2. Tx/Rx SABM Frame Count
3. Tx/Rx Info Frame Count
4. Tx/Rx FRMR Frame Count
5. Tx/Rx UI Frame Count
6. Tx/Rx UA Frame Count
7. Tx/Rx DM DISC Frame Count
8. Tx/Rx RNR Frame Count
9. Tx/Rx REJ Frame Count

## 6.4 RESTORE DEFAULT SETTINGS MENU

This menu option is used to restore factory default settings from the front panel. On entering this menu, confirmation is requested before performing restore.



**Figure 6-3 Front Panel Display Message to confirm Restore of Factory Default Settings**

The user needs to press and hold the “Enter” button (pressing the button for at least 5 seconds) to confirm the operation.

The following message is displayed after completing the operation. The device will undergo reboot automatically to apply the changes.

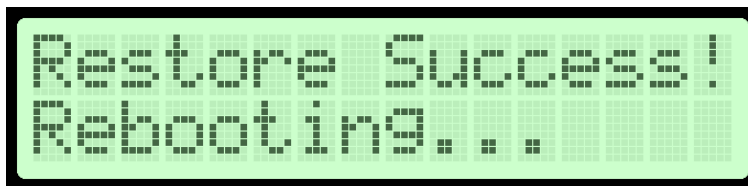

**Figure 6-4 Front Panel Display Message after Restoring Default Settings**



## CHAPTER 7 – CONFIGURATION & ALIGNMENT

### 7.1 INTRODUCTION

Airlink WCP configuration data identifies the Airlink WCP with a specific location and establishes its communications, I/O, and ancillary function parameters.

### 7.2 CONFIGURATION

Ordinarily, initial setup and routine maintenance tasks consist of making changes to the site configuration and storing the data permanently in the Airlink WCP. While most of the parameters are factory set and do not require user alteration, site-specific data such as local ATCS address, remote FEP/CC address, client port assignments, system timers, hardware configuration etc. may be programmed on site by field maintenance personnel. This is accomplished by using the Apollo configuration editor and uploading the complete modified configuration information.

When using the Apollo configuration editor, all configuration data (as well as other site data) may be stored in a PC data file. The Apollo configuration editor is detailed in the following section.

### 7.3 APOLLO USER INFORMATION

#### 7.3.1 INTRODUCTION

This section describes the installation steps and procedures to use the Apollo and Radio Discovery applications for the Airlink WCP. Apollo is a web based application which is used to configure, diagnose, scan bandwidth, and perform actions and logging on the Airlink WCP radio. Radio Discovery is a desktop application which is used to discover radios in the network and runs the Apollo tool for the user.

#### 7.3.2 INSTALLATION

##### 7.3.2.1 DISCOVERY APPLICATION (9VE46)

The Discovery Application is available for installation on the Windows system using the provided Windows Installer (.exe).

To install:

- Ensure the application will be installed on a Windows 7, Windows 8, or Windows 10 - 64-bit operating system. The recommended operating system is Windows 10.
- Double-click the Discovery Application file to begin the installation process.

The Discovery Application has a software identification number of 9VE46.

### 7.3.2.2 APOLLO TOOL

The Apollo tool supports three levels of users. Each user level allows for a different set of permissions. The following table lists the default login information for each user level.

**Table 7-1 Default Login Information**

<b>Username</b>	<b>Default Password</b>
level1	level100
level2	level200
level3	level300

These credentials are used by the Discovery Application to load Apollo from the target Airlink WCP. Once the user has logged in with their login credentials, the corresponding screens and permissions will be available in the Apollo tool.

### 7.3.2.3 PREREQUISITES

- Connect Windows PC ethernet interface to Management Port (eth1) of the Airlink WCP.
- Set static IP on the Windows PC interface on which the Airlink WCP is connected.
- Static IP needs to be in the same subnet of Management IP used in the Airlink WCP.

### 7.3.3 DISCOVERY APPLICATION INITIAL CONFIGURATION STEPS

After successful installation of the Discovery Application, the user can search “Discovery Application” in the start menu and double click to run it.

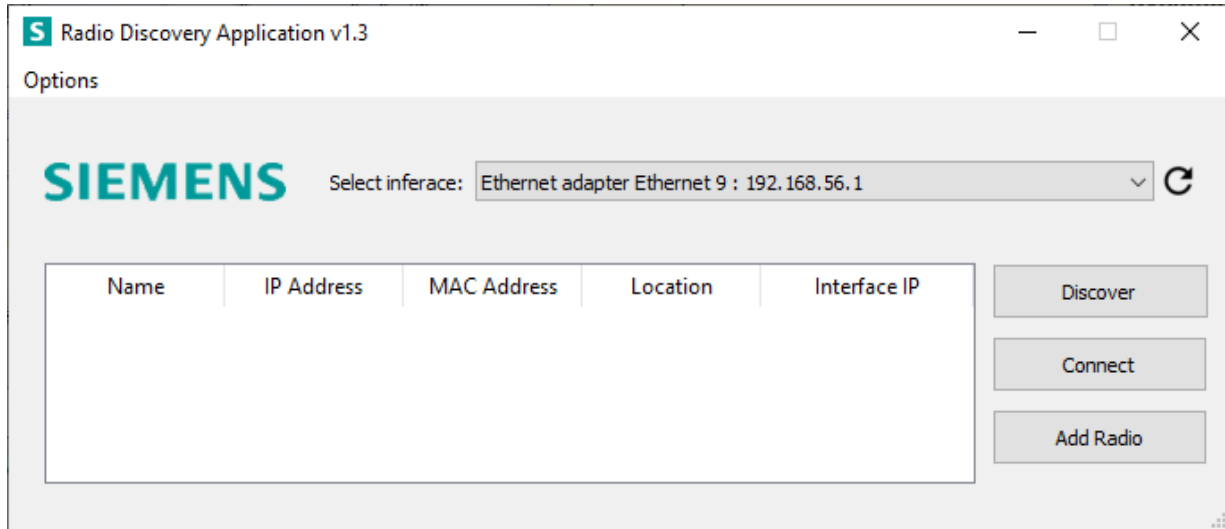
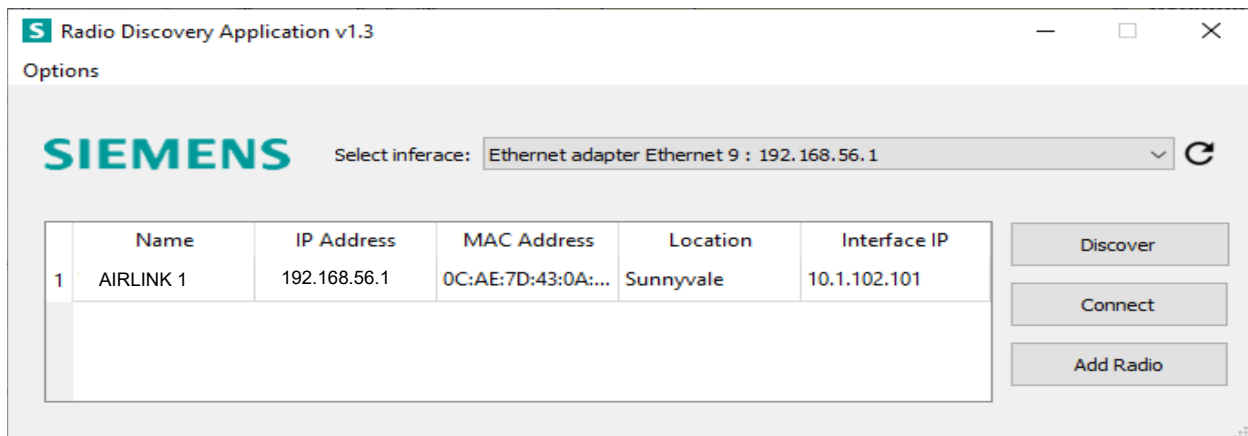

**Figure 7-1 Discovery Application**

The user PC can have multiple network interfaces. The user must select the interface on which the radios are connected from the Discovery App drop-down menu shown above (select interface).

Click on “Discover” to display the list of radios present on the selected network interface. The radio should be in a normal running state (all the applications of the radio should be up) for it to be discovered.

Discovered radio details are shown in the radio information table shown in the following figure.



**Figure 7-2 Discovery Application: After Clicking Discover**

If radios are not available/discoverable, the below popup will be shown.

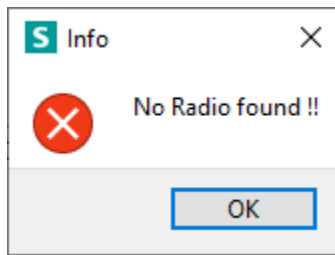

**Figure 7-3 Popup - No Radio Found**

In certain cases, the radio might be ON, but the application may not be running. In such cases, the radio will not be discovered by the Discovery Application. To overcome this, the user can add the radio details manually to connect and use Apollo. Click on the "Add Radio" button. Fill in the details and click 'Add' to register it to the radio information table. The user should carefully select the interface on which the radio is connected. A wrong selection will lead to an unsuccessful connection.

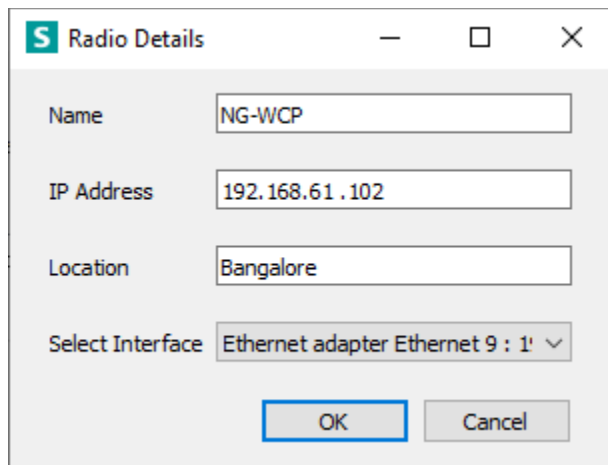

**Figure 7-4 Discovery Application: Add Radio Manually**

Select any of the radios listed and click on the 'Connect' button.

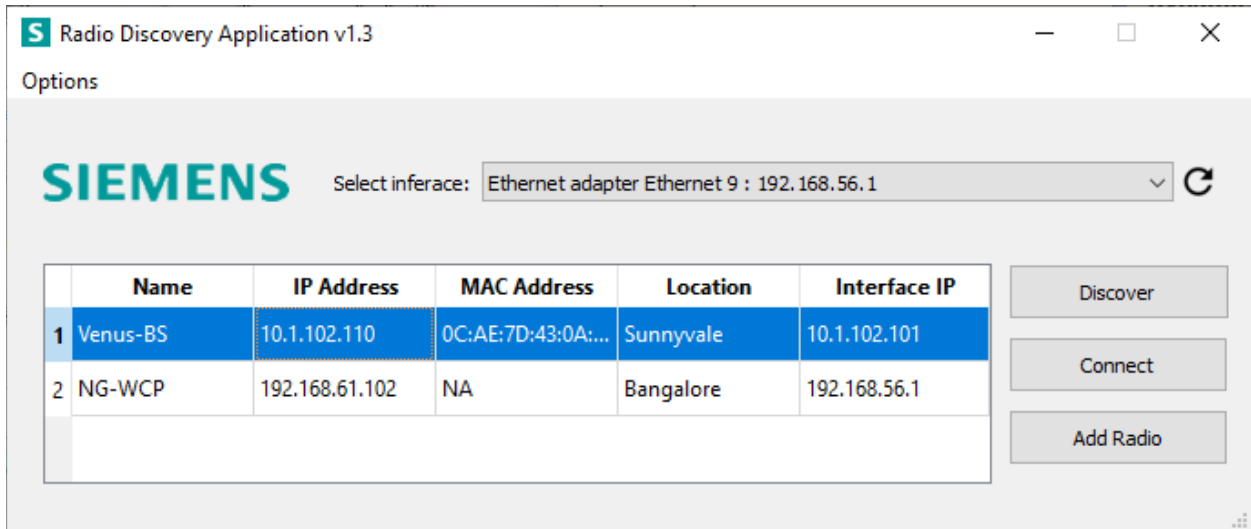

**Figure 7-5 Discovery Application After Adding Radio Manually**

The application will now ask for remote login credentials. The default login information for each user level is listed in the following table.

**Table 7-2 Default Login Information**

Username	Default Password
level1	level100
level2	level200
level3	level300

The user can use any of the above default credentials to log in and use the Apollo tool.

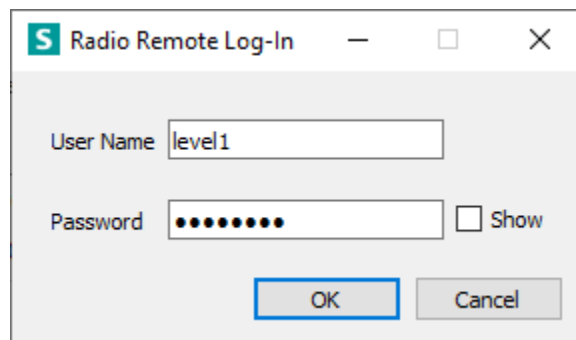

**Figure 7-6 Logging into Radio**

Click on OK to connect to the radio. Upon successful connection, the Discovery application will load the Apollo tool from the radio and launch it.

The default web browser opens automatically and connects to the Apollo tool. The user can now use Apollo to configure and manage the radio.

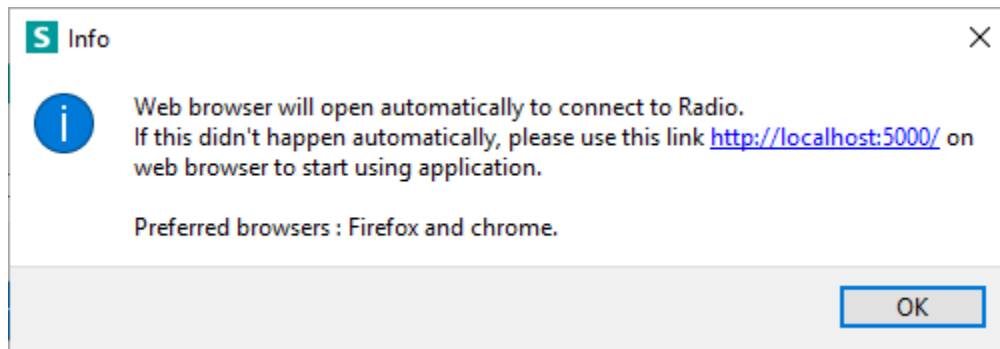

Figure 7-7 Message to User

**CAUTION**

**CAUTION**

Avoid having multiple instances of the Discovery application as it could lead to unexpected behaviour in the application.

**NOTE**

**NOTE**

Apollo works best on Firefox and Chrome browsers. The Discovery application will open the default browser of the user's PC. If a browser other than Firefox or Chrome is prompted by the Discovery App, it is recommended to close such browser and use Firefox or Chrome browser with address <http://localhost:5000/> to access the Apollo tool.

**NOTE**

**NOTE**

The Apollo server will remain running unless the user manually exits Apollo or closes the Discovery application. The user can access the Apollo tool using <http://localhost:5000/> at any time.

### 7.3.4 APOLLO MENU DESCRIPTIONS

The Apollo tool can be used in one of two modes, one for ATCS operation and one for MC-IoT operation. These menus may vary depending on which mode is in use. Any variations are detailed in the sections that follow.

The Apollo tool has six main menus, divided based on function. These are:

1. Configurations
2. Diagnostics
3. Scanner
4. Actions
5. Logging
6. Info

These menus are available in six different tabs at the top of the main screen of the Apollo tool.

#### 7.3.4.1 CONFIGURATIONS SCREEN

The Configurations menu is used to manage configurations of the Airlink WCP. It has two submenus:

1. Static Configurations
2. Dynamic Configurations

##### Static Configurations Page

The Static Configurations submenu is used to modify ATCS configurations in the “*wcp\_config.xml*” configuration file of the radio.

This page has configuration fields and two buttons: Save and Revert. Initially these buttons are disabled. On changing the configuration, the Save button is enabled and the selected configuration field outline color turns yellow. This is to differentiate between saved and unsaved configuration changes.

Press the Save button to update the changed configurations in the configuration file present at the radio.

Press the *Revert* button to change back to the last set of configurations. One level of backup configuration file is maintained by the Apollo tool.

After pressing Save or Revert, a Radio reboot/Application restart action needs to be performed for the changes to take effect. It is highly recommended to perform these actions immediately after a Save or Revert, to avoid conflicts for other users. The tool automatically redirects to the “Actions” page after pressing Save or Revert.

The following figures show the ‘Static Configurations’ page while in either ATCS operating mode or MC-IoT operating mode.

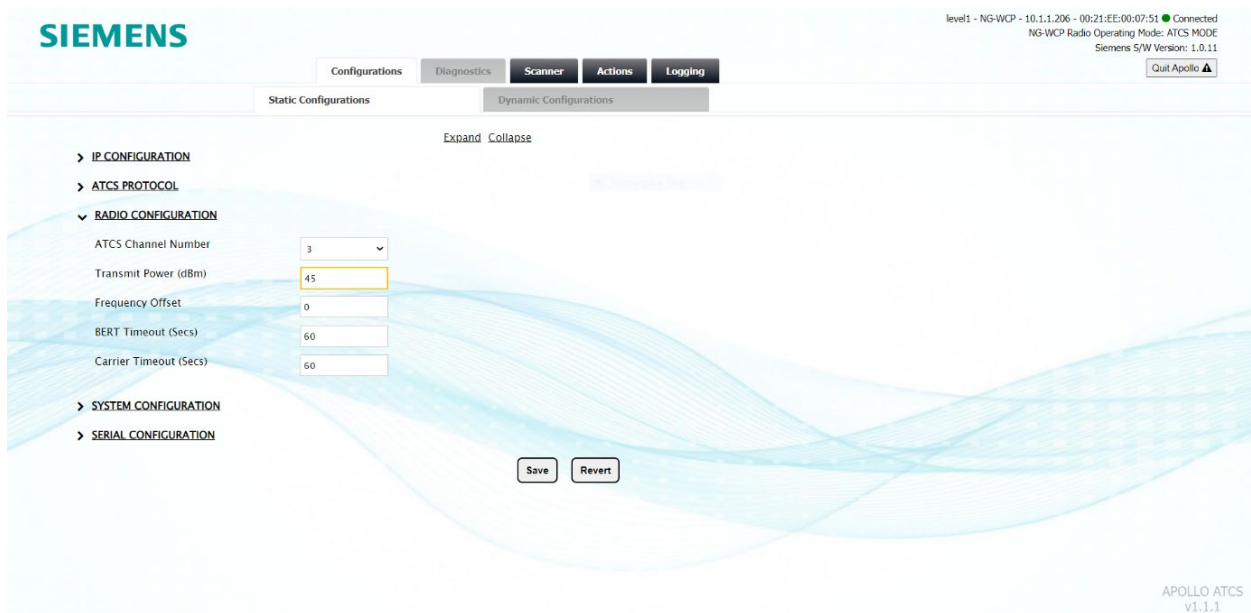

Figure 7-8 Static Configurations Screen (in ATCS Mode)

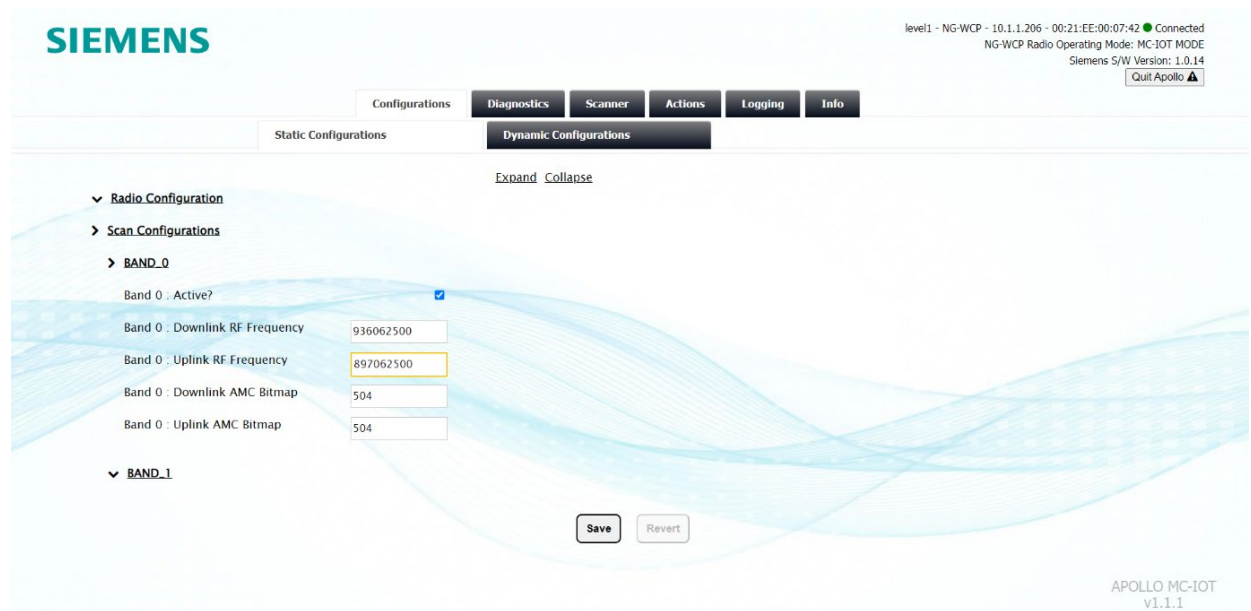

Figure 7-9 Static Configurations Screen (in MC-IoT Mode)



## Dynamic Configurations Page

For the Airlink WCP Apollo tool, the Dynamic Configurations submenu is available in MC-IoT mode only.

Configuration changes made on the Dynamic Configurations page will take effect immediately in the radio. This page has three options: Modify, Revert, and Commit. When changing the configuration of a specific field, the field outline color will turn yellow (as shown). This is to differentiate between saved and unsaved configuration changes.

**Modify** – After changing the configuration on the tool page, click the Modify button to update it on the radio. The outline color of the field will turn blue. This tells the user that the changes are not yet committed. The changes are volatile, meaning that they have not been updated into the configuration file yet, so on reboot, any changes would be lost.

**Commit** – Use the commit option to make the changes non-volatile and saved onto the configuration file. The outline color of the field will now turn back to normal (transparent).

**Revert** – Use the revert option to change the configuration file back to the last committed values.

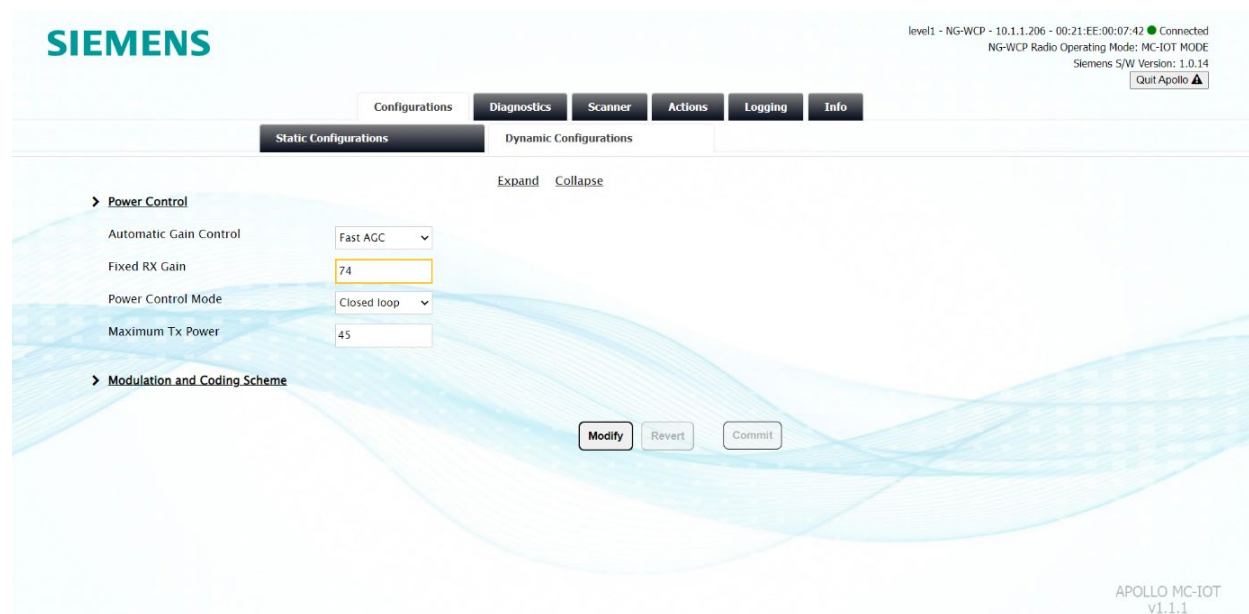

**Figure 7-10 Dynamic Configurations Screen (in MC-IoT Mode only)**

### 7.3.4.2 DIAGNOSTICS SCREEN

For the Airlink WCP Apollo tool, the Diagnostics menu is available in MC-IoT mode only.

The Diagnostics page is used to plot a graph using the values of the radio's parameters, which can be used to diagnose issues with the performance of the radio.

There are three types of graph plotting: one graph, two graph or four graph plotting. The user can select the type of graph plotting by going to settings and using the 'number of Diagnostics' option. The settings menu shows on the left side of the Diagnostics page as shown in the following figure.

In the settings menu, the user can select the parameter to be plotted and the time interval for plotting new values. The available time intervals are 1, 5, 10, and 15 second(s). Once all settings are entered, click the Start button to begin plotting.

Use the 'Show Data' field to view the last set of data, for example the data from the last 30 seconds. Available options are All, Last 10 sec, Last 20 sec, Last 30 sec and Last 1 min. The default option is "All" i.e. the graph will show all data. The user can stop the plotting at any time using the Stop button in the settings menu.

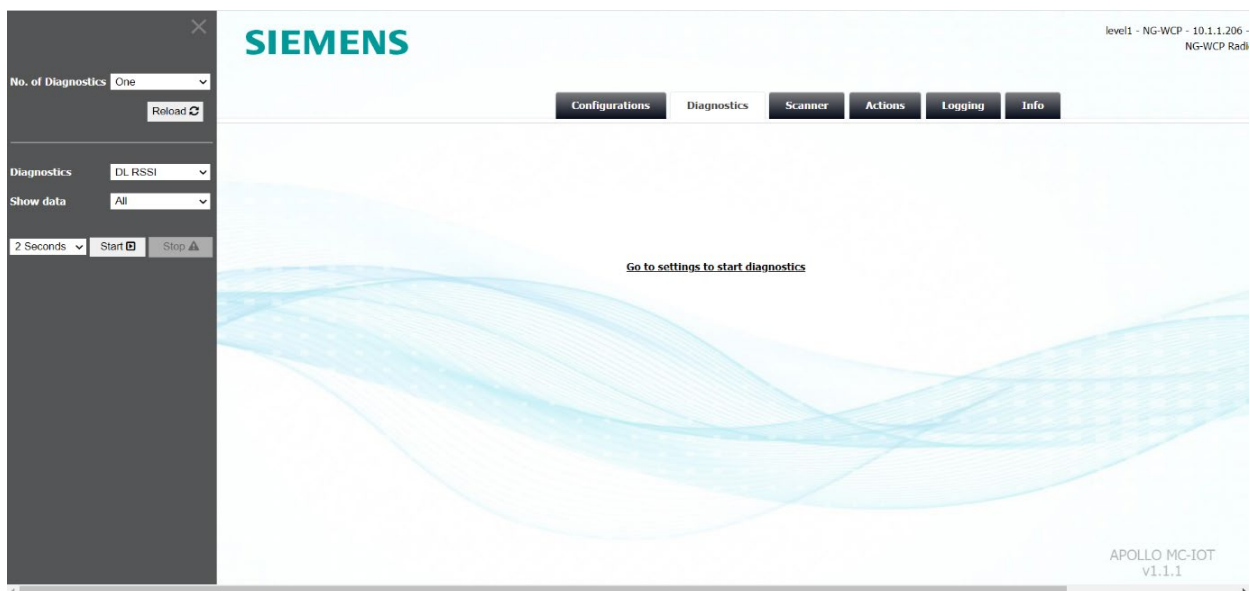

**Figure 7-11 Diagnostics Screen (in MC-IoT Mode only)**

The following figures show the various options for plotting graphs on the Diagnostics page.



Figure 7-12 Diagnostics Screen – One Graph Plotting (in MC-IoT Mode only)



Figure 7-13 Diagnostics Screen – Two Graph Plotting (in MC-IoT Mode only)

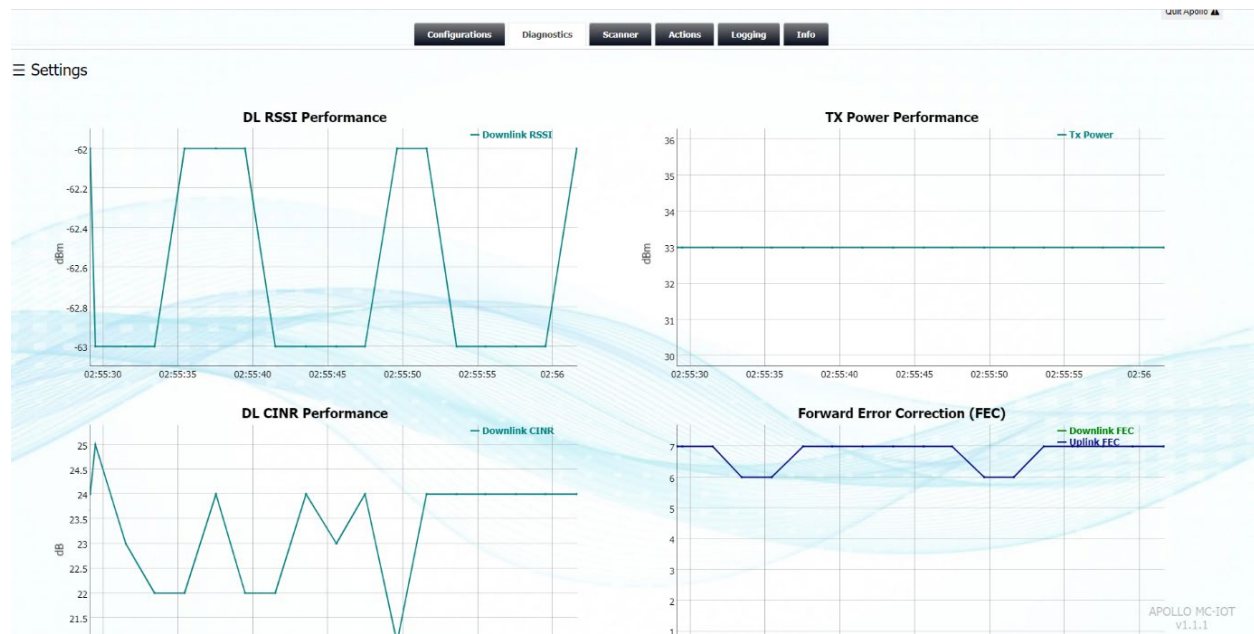

**Figure 7-14 Diagnostics Screen – Four Graph Plotting (in MC-IoT Mode only)**

## Zoom

When in ‘one graph plotting’, zoom in on the graph by clicking on the desired start point of the graph, and dragging the cursor to the desired end point. The graph will display the selected section and freeze. In the background, new values continue to be collected. To return the graph to its original state, double click on any part of the graph.

In ‘two graph plotting’ and ‘four graph plotting’ the zoom function performs as a global zoom for the other graphs, i.e. when the user zooms in on one graph, the other graphs will also zoom in at the same range. To remove the zoomed in area and resume as before, double click on any graph and all graphs will resume at the same time.

### 7.3.4.3 SCANNER SCREEN

The Scanner menu is used for scanning the spectrum. The Apollo tool performs real time plotting of values generated by the radio’s internal scanner application. Normal radio operation is suspended while the scanner application is running.

The user needs to input the following configurations to start the scanner application:

- Scanner Mode
- Center Frequency
- Span (Hz)
- Rx Gain
- Resolution Bandwidth
- Number of cycles

The “Stop Button” can be used to stop scanner operations at any time.

The “Export” option is used to download the values generated by the scanner application in CSV format.

### NOTE

### NOTE

Turn off the firewall before using the scanner feature in Apollo. Windows firewall blocks UDP traffic in certain scenarios, therefore the user must turn off the firewall in order for this feature to function.

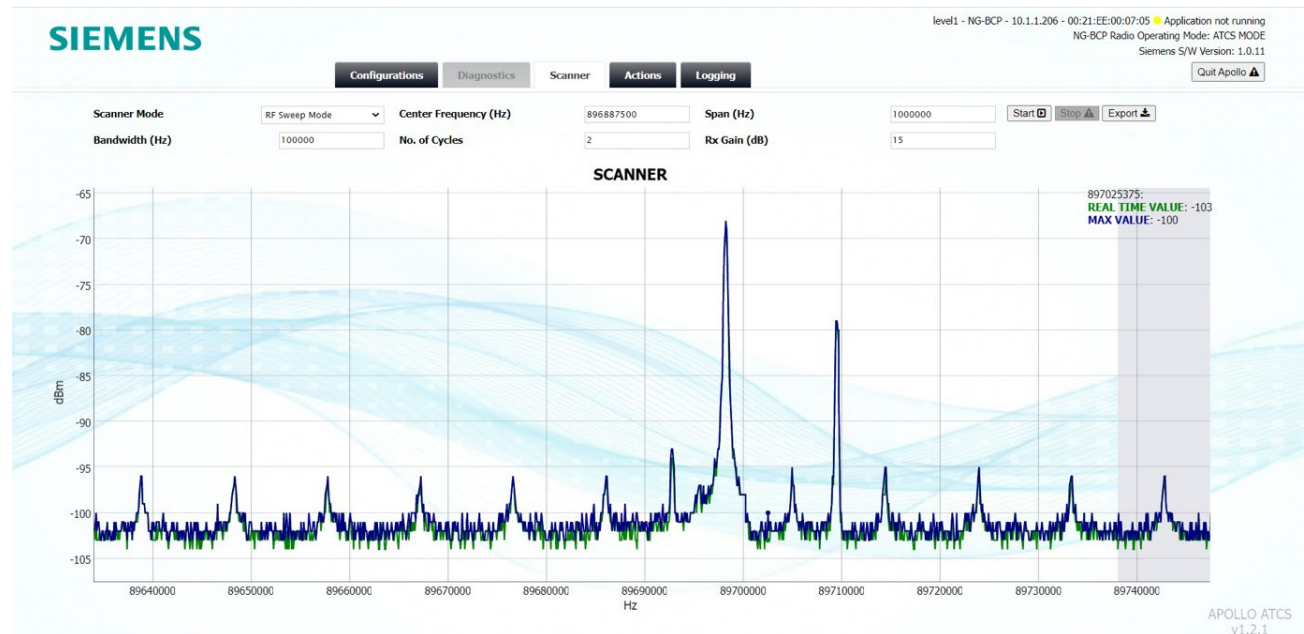

Figure 7-15 Scanner Screen (both modes of operation)

## Zoom

Zoom in on the graph by clicking the desired start point of the graph and dragging the cursor to the desired end point. The graph will display the selected section and freeze. In the background, new values continue to be collected. To return the graph to its original state, double click on any part of the graph.

### 7.3.4.4 ACTIONS SCREEN

In the Actions menu, the user can perform multiple actions on the radio. The Actions page has the following functions:

1. Operations:
  - a. Reboot – Performs a system reboot of the radio.
  - b. Restart – Quits radio applications and restarts them.

- c. Rescan – Radio performs a rescan and tries for network entry. **This option is not used on Apollo Airlink WCP.**
2. Stop Radio – Stops the radio applications.
3. Start Radio – Starts the radio applications.
4. Upload Configuration file – Uploads the configuration file onto the radio (wcp\_config.xml). On the user's PC, use the browse option to select the configuration file and click upload.
5. Download Configuration file – Downloads the configuration file from the radio to the user's PC (wcp\_config.xml).
6. Revert Configuration file – After upload, this function can be used to revert back to the last configuration file. One level of backup is maintained in the Apollo tool.
7. Flash new image – This function is used to program (flash) the file-system image, FPGA image, RFM Controller, and U-boot of processor 2 on the non-active partition. On the user's PC, use the browse option to select 'Flash Image' and click 'Flash'.
8. Swap partition – This function is used to switch to another partition and reboot. It can also be used to enable a Sanity reboot, meaning if there is an issue in the other partition, the radio automatically reverts back to the old partition and reboots.  
**NOTE:** After a successful 'flash and swap', it is recommended to quit the Apollo tool and reconnect to ensure the user has the latest Apollo from the flashed partition.
9. Update Docker Application – This function is used to upload the docker image to the radio and load it to the docker repository. On the user's PC, use the browse option to select the docker image to be updated and click update.
10. Restore factory settings – This function uses the default factory file present on the radio to restore the factory settings on the radio.
11. Upload factory settings – Uploads the factory settings file onto the radio. On the user's PC, use the browse option to select the factory settings file and click upload.
12. Download factory settings – Downloads the factory settings file from the radio to the user's PC.
13. BERT test – This function is used to enable or disable a BERT Tx or BERT Rx test. It is applicable for ATCS mode.
14. Carrier Tx test – This function is used to enable or disable a Carrier Tx test. It is applicable for ATCS mode.
15. Tx Calibration test – This function is used to enable or disable a Tx Calibration test mode. It is applicable for ATCS mode.
16. Apply Patch – This function is used to apply a patch on the active partition. It will also check and program (flash) the FPGA, RFM Controller, U-boot, and kernel present on the active partition. On the user's PC, use the browse option to select the patch file and click the Patch button.
17. Switch NGWCP Operating Mode – This function is used to change the Airlink WCP operating modes (i.e. ATCS Mode and MC-IoT Mode).

18. Switch Apollo Mode – This function is used to switch the Apollo Tool Mode to either ATCS or MC-IoT mode. This can be switched only if the Airlink WCP is in MC-IoT mode.

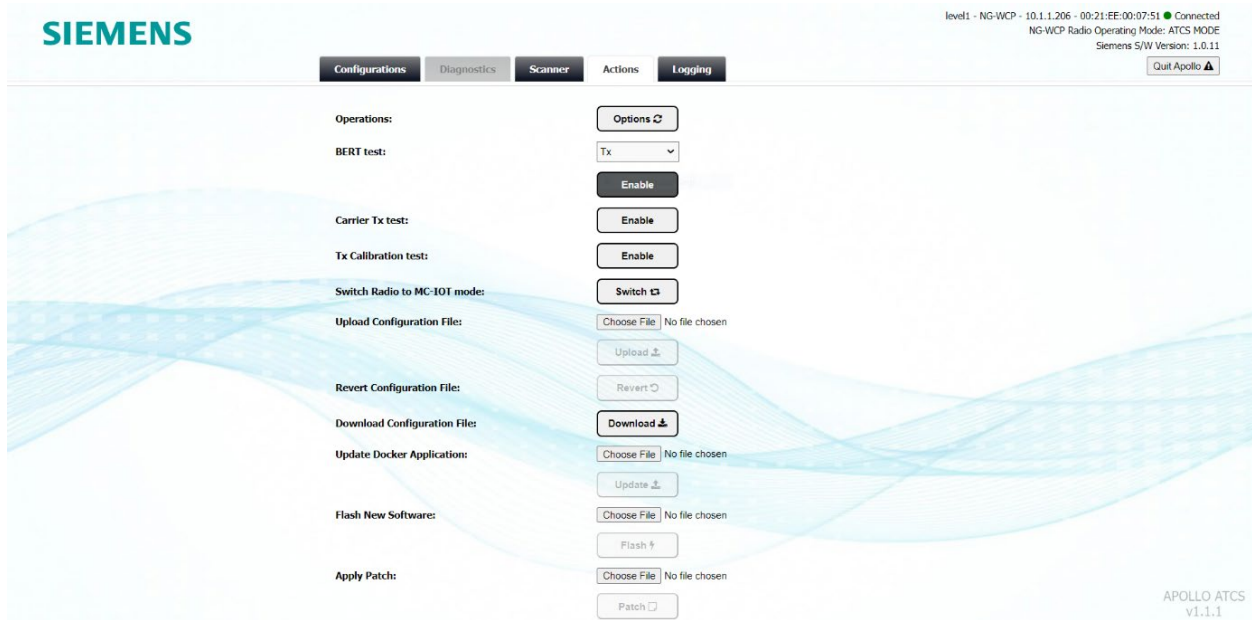

Figure 7-16 Actions Screen (in ATCS Mode)

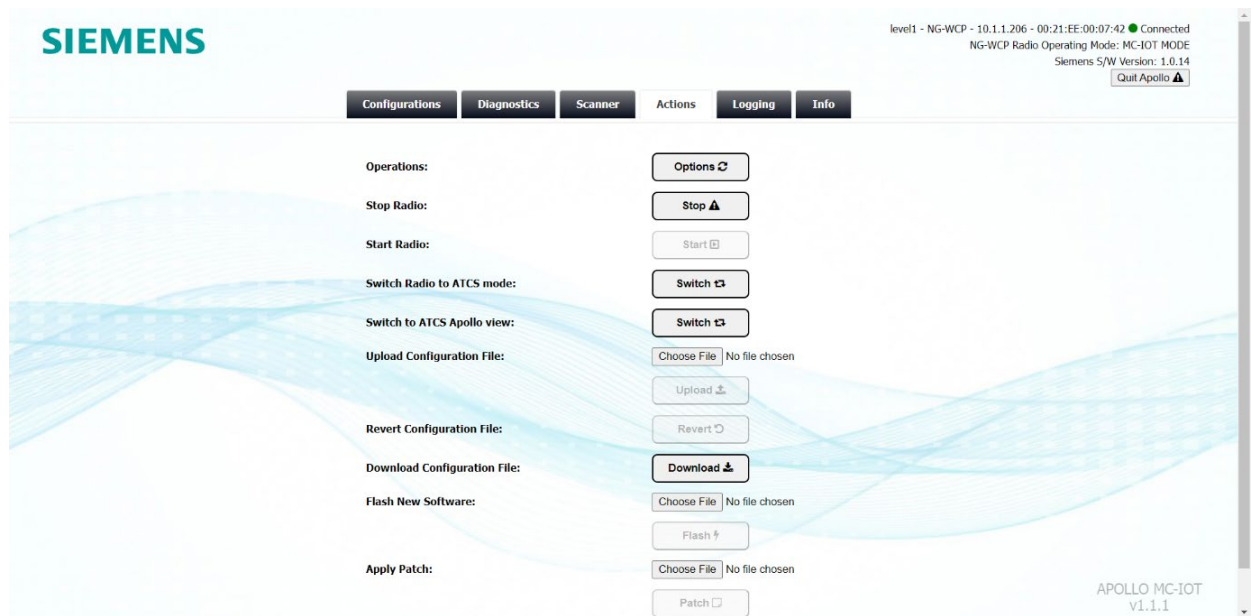

Figure 7-17 Actions Screen (in MC-IoT Mode)

### 7.3.4.5 LOGGING SCREEN

The Logging menu is used to display the radio application logs on the Apollo tool. Click 'Start Logging' to receive logs from the radio. Ensure the **LOG\_TO\_FILE** value is enabled in the radio configuration file. If it is not enabled, Apollo will not display any logs.

On this page, the user can also download the Application and System log file to their PC.

When in Apollo MC-IoT mode only, the user can use the Logging page to set different log levels for MAC logging and PHY logging, as shown in Figure 7-19.

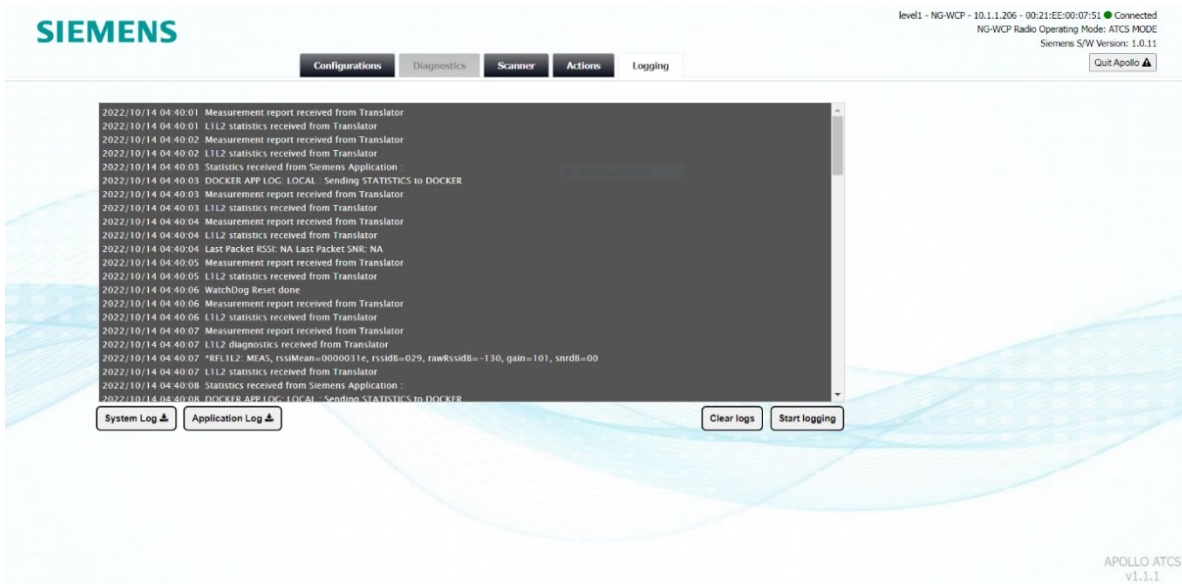

Figure 7-18 Logging Screen (in ATCS Mode)

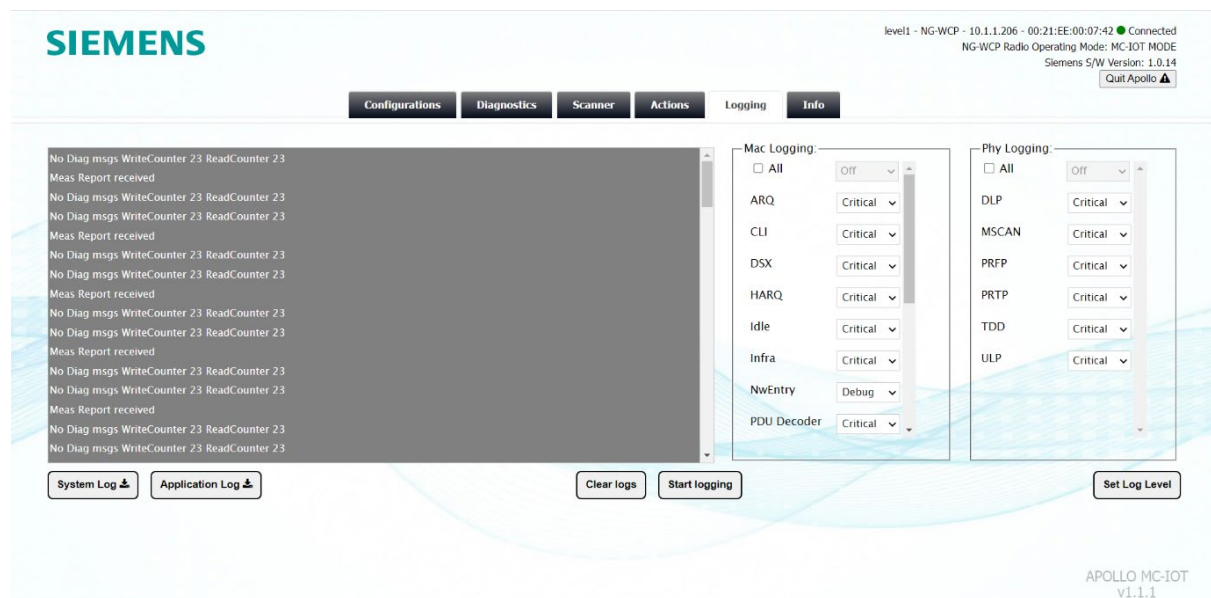

Figure 7-19 Logging Screen (in MC-IoT Mode)



### 7.3.4.6 INFO SCREEN

For the Airlink WCP Apollo tool, the Info Menu is available in MC-IoT mode only.

The Info page is used to display information such as the hardware serial number, the connected base station ID and the software package version.

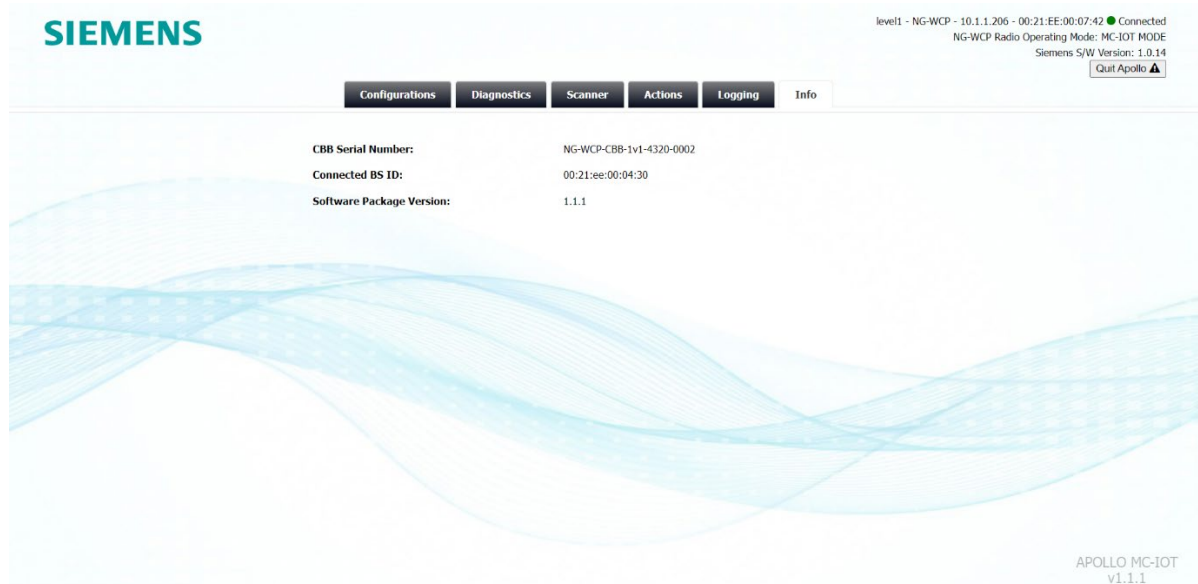

Figure 7-20 Info Screen (in MC-IoT Mode only)

### 7.3.4.7 COMMON FEATURES

At the top right corner of the Apollo tool, the radio details and state is shown to the user. There are three possible states:

- Connected.
- Application not running.
- Disconnected.

In the connected state, all features of the tool remain activated. The tool shows the state as “Connected”.

If the application stops running and the radio is reachable, the tool shows the state as “Application not running”. In this state, some features such as the scanner, are disabled. When the radio application is run again and is back to its normal state, all features will be reactivated.

When the radio is in an unreachable state like during reboot and shutdown, the Apollo tool shows the state as “Disconnected”. The tool automatically redirects to the Logging page and the last few logs of the radio are displayed, which may help the user to understand what is happening in the radio. These logs are not received in real time. All features of the tool are disabled in this state. When the radio is reachable and back to its normal state, all features will be reactivated.

To quit/exit the Apollo tool, click on the “**Quit Apollo**” button located at the top right of the Apollo screen, below the status bar.

## 7.4 COMMAND LINE INTERFACE (CLI) OPERATIONS & CONFIGURATION

The Airlink WCP CLI can manipulate key configuration parameters, perform volatile configuration changes, and read measurement and statistic information.

The Airlink WCP may operate in one of two modes for the Command Line Interface, one for ATCS operation and one for Mission Critical Internet-of-Things (MC-IoT) operation. Some commands are common for both modes, whereas other commands vary depending on which mode is in use. Any variations are detailed in the sections that follow. The following sections provide an overview of the CLI configuration and operational aspects of the Airlink WCP for both of these modes.

### 7.4.1 COMMON INFORMATION FOR BOTH MODES OF OPERATION

#### 7.4.1.1 CONSOLE ACCESS

Airlink WCP radios may be accessed locally using the serial port as a console or remotely using SSH. The following instructions apply when accessing the Airlink WCP CLI using the serial console.

**NOTE****NOTE**

When accessing the CLI over SSH session, use the following login credentials to access the CLI:  
User name: admin  
Default Password: admin100

#### 7.4.1.2 BASIC LOGIN INSTRUCTIONS

There are two CLI users available – operator and administrator.

The default CLI user is “operator”. The command prompt is shown as “operator@AirlinkWCP”.

To log in as an administrator, use the “su admin” command in CLI and press Enter. It will prompt for a password. Use password “FullMax” and press Enter. Refer to the following figure.

```
operator@AirlinkWCP-$ su admin
su admin
Enter Password:

admin@AirlinkWCP-$
admin@AirlinkWCP-$
```

Figure 7-21 Admin Login

These keys perform the following functions:

- Tab: Auto complete commands.
- History: Prints recent history of commands.
- Clear: Clear screen.
- Back: Move prompt back by one level.
- Quit: Move all the way back.
- Exit: Go back to operator user.

### 7.4.1.3 OPERATOR USER

The operator user can read all CLI non-security related parameters and change log levels. This user cannot change any parameter values. Options available in Operator Mode are shown in the following figure:

- The “show” command is used to read the configuration values and statistics.
- The “debug” command is used to set log levels.
- The “su” command is used to log in as an administrator user.

```
operator@AirlinkWCP-$
change
debug
reboot
show
stop
su
```

Figure 7-22 Available Options in Operator Mode

### 7.4.1.4 ADMIN USER

The Administrator user can read all CLI non-security related parameters and change log levels. This user can change some parameters in volatile memory. These parameters will return to their original value after reset. Options available in Administrator Mode are shown in the following figure:

- The “show” command is used to read the configuration values and statistics.
- The “debug” command is used to set log levels.
- The “config” command is used for volatile configuration changes and to enable/disable BERT mode.

```
admin@AirlinkWCP-$
change
config
debug
exit
reboot
show
stop
su
```

**Figure 7-23 Available Options in Admin Mode**

## **7.4.2 COMMANDS APPLICABLE TO ATCS MODE ONLY**

This section provides an overview of the CLI configuration and operational aspects of the Airlink WCP when in ATCS operating mode only.

### **7.4.2.1 READ CONFIGURATION INFORMATION**

To view the complete listing of system configurations such as IP config, ATCS Address config, Radio config, etc. the user can issue the “show wcp sysconfig” command. An example of this is shown in the following figures.

```

operator@AirlinkWCP-$ show wcp sysconfig
show wcp sysconfig
*****Ip Configuration*****
Management IP Address (ETH1)           : 10.1.1.206
Management Netmask (ETH1)             : 255.255.255.0
Management Gateway (ETH1)            : 10.1.1.1
DNS Server 1 IP Address                : 0.0.0.0
DNS Server 2 IP Address                : 0.0.0.0

----- ATCS Address information-----
Cluster Controller Address             : 2.620,00,0000
Local Address                          : 7.620,001,001,01,01
Health Address                         : 2.620,00,0000
Beacon Address                         : 2.620,00,0000

-----PHY Cofiguration-----
Minimum Retry value for Idle channel   : 1300
Maximum Retry value for Idle channel   : 1300
Minimum Retry value for Synchronization bits channel : 10
Maximum Retry value for synchronization bits channel : 800
Minimum Retry value for Busybits channel : 10
Maximum Retry value for Busybits channel : 2000
Minimum Retry value for undefined Busybits channel : 10
Maximum Retry value for undefined Busybits channel : 50
Minimum channel Idle Time              : 750
Maximum channel Idle Time              : 1500

-----Radio Configuration-----
Device Type                            : NG-WCP
Configured Frequency Index             : 1
AGC Mode                               : Enable
Receive gain (If AGC is disabled)      : 25 (dB)
Power Control Mode                     : Disabled
Tx power                               : 38,00 (dBm)
RF Filter                              : 0 (BW: 6 (MHz) CF: 938 (MHz))
IF Filter                              : 2 (BW: 15 (kHz) CF: 70 (MHz))
Tx Frequency                           : 896,8875 (MHz)
Rx Frequency                           : 935,8875 (MHz)
Frequency Deviation                    : 1300 (Hz)
Frequency Offset                       : 0 (Hz)
Bert Timeout                           : 60 (sec)
Carrier Timeout                         : 60 (sec)

----- Higher Layer Information -----
Number of fast Beacons                  : 5
Maximum number of beacon retries        : 6
Number of Ground Contact Attempts      : 6
Regain contact message count           : 0
NAK packets to ground network          : Disabled
Suppress layer 3 duplicate elimination  : Disabled

```

Figure 7-24 View System Configuration - 1

```

----- Log Configuration Information -----
Log To File                : Enabled
Log Level                  : 5 (DEBUG)

----- Timer information-----
ATCS Beacon Timer         : 0
ATCS Time between ground contact attempts : 6000
Channel Group 0 RF retry interval : 400
Channel Group 2 RF retry interval : 490
Channel Group 4 RF retry interval : 760
Channel Group 6 RF retry interval : 1080
Channel Group 8 RF retry interval : 1450
Channel Group 10 RF retry interval : 2000
Channel Group 12 RF retry interval : 2900
Channel Group 14 RF retry interval : 3900

-----ATCS Udp Network Information -----
Selected ATCS UDP Network : None
Circuit ID Line           : 1
Circuit ID Port           : 1
Circuit ID Poll           : 0
Routing Region1           : 0,0,0,0
Routing Region2           : 0,0,0,0
Port Number               : 5361
Path Value                : 72
Route Search Time         : 15
Route Refresh Time        : 5
Route Search Tries        : 4
Broadcast Ip Address      : 255,255,255,255

```

**Figure 7-25 View System Configuration – 2**

```

----- Serial Port 0 (J1) Information -----
Interface Type                : RS-232
Line Code                     : NRZ
Transmitter clock source     : Internal
Communication Mode           : Asynchronous
Baud Rate                    : 9600 (bps)
Data bits                    : 8
Parity Bit                   : None
Stop bits                    : 1
Flow Control                 : None
Serial Protocol              : 1 (Genisys Office)
Poll range Start             : 1
Number of Stations           : 1
Short Port Delay             : 1000
Long Poll Delay              : 10000
Retry Count                  : 3
Response Fail Count          : 3
Message Response Timer       : 1500
Poll Address                 : 1

----- Serial Port 1 (J2) Information -----
Interface Type                : RS-232
Line Code                     : NRZ
Transmitter clock source     : Internal
Communication Mode           : Synchronous
Baud Rate                    : 9600 (bps)
Data bits                    : 8
Parity Bit                   : None
Stop bits                    : 1
Flow Control                 : None
Serial Protocol              : 1 (Genisys Office)
Poll range Start             : 1
Number of Stations           : 1
Short Port Delay             : 1000
Long Poll Delay              : 10000
Retry Count                  : 3
Response Fail Count          : 3
Message Response Timer       : 1500
Poll Address                 : 1

```

**Figure 7-26 View System Configuration - 3**

In addition to viewing the complete system configuration, individual configuration sets can be viewed by issuing the corresponding command. The following table lists the commands available to view different configuration sets.

**Table 7-3 CLI Commands to Retrieve Different Configuration Sets**

CLI Command	Configuration Description
"show wcp phyconfig"	RF L1L2 (Phy) Application configuration like Channel access timers (Figure 7-32).
"show wcp radioconfig"	Radio configurations like Frequency Index, Tx Power, Rx Gain, etc. (Figure 7-29).
"show wcp atcs higherlayerconfig"	Siemens Docker App configuration (Figure 7-28).
"show wcp atcs addressconfig"	ATCS Address configuration (Figure 7-27).
"show wcp ipconfig"	IP Address configuration (Figure 7-31).
"show wcp timerconfig"	Siemens Docker App configuration.
"show wcp atcs udpnetworkconfig"	Siemens Docker App configuration (Figure 7-30).
"show wcp serialport0config"	Serial port P1 configurations used by both ONDAS App and Siemens Docker App configuration (Figure 7-33).
"show wcp serialport1config"	Serial port P2 configurations used by both ONDAS App and Siemens Docker App configuration (Figure 7-34).

```
admin@AirlinkWCP-$ show wcp atcs addressconfig
show wcp atcs addressconfig

----- ATCS Address information-----
Cluster Controller Address      : 2.620.00.0000
Local Address                   : 7.620.001.001.01.01
Health Addresss                : 2.620.00.0000
Beacon Address                 : 2.620.00.0000
```

**Figure 7-27 View ATCS Address Configuration**



```
operator@AirlinkWCP-$ show wcp atcs higherlayerconfig
show wcp atcs higherlayerconfig

----- Higher Layer Information -----
Number of fast Beacons           : 5
Maximum number of beacon retries : 6
Number of Ground Contact Attempts : 6
Regain contact message count     : 0
NAK packets to ground network    : Disabled
Suppress layer 3 duplicate elimination : Disabled
```

Figure 7-28 View Higher Layer Configuration

```
admin@AirlinkWCP-$ show wcp radioconfig
show wcp radioconfig

-----Radio Configuration-----
Device Type           : NG-WCP
Configured Frequency Index : 3
AGC Mode              : Enable
Receive gain (If AGC is disabled) : 25 (dB)
Power Control Mode    : Disable
Tx power              : 45.00 (dBm)
RF Filter              : 0 (BW: 6 (MHz) CF: 938 (MHz))
IF Filter              : 2 (BW: 15 (kHz) CF: 70 (MHz))
Tx Frequency           : 896.9875 (MHz)
Rx Frequency           : 935.9875 (MHz)
Frequency Deviation    : 1300 (Hz)
Frequency Offset       : 0 (Hz)
Bert Timeout           : 60 (sec)
Carrier Timeout        : 60 (sec)
```

Figure 7-29 View Radio Configuration

```

operator@AirlinkWCP-$ show wcp atcs udpnetworkconfig
show wcp atcs udpnetworkconfig

-----ATCS Udp Network Information -----
Selected ATCS UDP Network      : Office
Circuit ID Line                : 0
Circuit ID Port                : 1
Circuit ID Poll                : 0
Routing Region1                : 0.0.0.0
Routing Region2                : 0.0.0.0
Port Number                    : 5361
Path Value                     : 72
Route Search Time              : 15
Route Refresh Time             : 5
Route Search Tries             : 4
Broadcast Ip Address           : 255.255.255.255

```

Figure 7-30 View Higher Layer Configuration - UDP network

```

admin@AirlinkWCP-$ show wcp ipconfig
show wcp ipconfig
Management IP Address (ETH1)   : 10.1.1.206
Management Netmask (ETH1)     : 255.255.255.0
Management Gateway (ETH1)     : 10.1.1.1
DNS Server 1 IP Address       : 0.0.0.0
DNS Server 2 IP Address       : 0.0.0.0

```

Figure 7-31 View IP Configuration

```

admin@AirlinkWCP-$ show wcp phyconfig
show wcp phyconfig

-----PHY Cofiguration-----
Minimum Retry value for Idle channel      : 1300
Maximum Retry value for Idle channel     : 1300
Minimum Retry value for Synchronization bits channel : 10
Maximum Retry value for synchronization bits channel : 800
Minimum Retry value for Busybits channel  : 10
Maximum Retry value for Busybits channel  : 2000
Minimum Retry value for undefined Busybits channel : 10
Maximum Retry value for undefined Busybits channel : 50
Minimum channel Idle Time                 : 750
Maximum channel Idle Time                 : 1500

```

Figure 7-32 View PHY Configuration

```
admin@AirlinkWCP-$ show wcp serialport0config
show wcp serialport0config

----- Serial Port 0 (J1) Information -----
Interface Type      : RS-232
Line Code          : NRZ
Transmitter clock source : Internal
Communication Mode  : Asynchronous
Baud Rate          : 9600 (bps)
Data bits          : 8
Parity Bit         : None
Stop bits          : 1
Flow Control       : None
Serial Protocol    : 1 (Genisys Office)
Poll range Start   : 5
Number of Stations : 1
Short Port Delay   : 1000
Long Poll Delay    : 10000
Retry Count        : 3
Response Fail Count : 3
Message Response Timer : 1500
Poll Address       : 1
```

Figure 7-33 View Serial Port 0 Configuration

```
admin@AirlinkWCP-$ show wcp serialport1config
show wcp serialport1config

----- Serial Port 1 (J2) Information -----
Interface Type      : RS-232
Line Code          : NRZ
Transmitter clock source : Internal
Communication Mode  : Synchronous
Baud Rate          : 9600 (bps)
Data bits          : 8
Parity Bit         : None
Stop bits          : 1
Flow Control       : None
Serial Protocol    : 1 (Genisys Office)
Poll range Start   : 1
Number of Stations : 1
Short Port Delay   : 1000
Long Poll Delay    : 10000
Retry Count        : 3
Response Fail Count : 3
Message Response Timer : 1500
Poll Address       : 1
```

Figure 7-34 View Serial Port 1 Configuration

### 7.4.2.2 READ STATISTICS AND MEASUREMENT INFORMATION

The following table lists the CLI commands available to view real time statistics information.

**Table 7-4 CLI Commands for Viewing Statistics**

CLI Command	Description
"show wcp info"	Mode and SW, HW version details (Figure 7-35).
"show wcp l1l2statistics"	RF Frame statistics (Figure 7-38).
"show wcp rfmconfig"	RFM configurations (Figure 7-37).
"show wcp statistics"	RF and Serial ports statistics in bytes count (Figure 7-39).
"show wcp gps location"	GPS Latitude and Longitude information (If GPS antenna connected).
"show wcp gps time"	GPS time UTC (If GPS antenna connected) (Figure 7-40).
"show wcp temperature"	CBB Board temperature (Figure 7-41).
"show wcp uptime"	System uptime (Figure 7-42).
"show wcp frameCount"	RF Port Frame Count (Figure 7-44).
"show wcp currenttime"	Current Date and Time (Figure 7-43).

```
operator@AirlinkWCP-$ show wcp info
show wcp info
System Mode           + ATCS
Application Mode      + OPERATIONAL
Radio Application Version + 1.1.1
Docked Application Version + 1.0.11
FPGA Version          + TBD
CBB Board Version     + TBD
RFM Board Version     + TBD
PA Version            + TBD
PSU Version           + TBD
T/R Switch Version    + TBD
```

**Figure 7-35 View WCP Info**

```
admin@AirlinkWCP-$ show wcp measurement report
show wcp measurement report

-----MEASUREMENT REPORT -----
Last Packet RSSI           : -85 (dBm)
Last Packet SNR            : 43 (dB)
CBB Rx Gain                 : 49 (dB)
CBB Temperature             : 32 (degree C)
PA Temperature              : 32 (degree C)
Tx Power                    : 44.75 (dBm)
Current Drawn               : 4100 (mA)
```

Figure 7-36 View Measurement Info

```
admin@AirlinkWCP-$ show wcp rfmconfig
show wcp rfmconfig

----- RFM CONFIGURATION -----
RF Filter Frequency        : 938000 (kHz)
IF Filter Frequency        : 70000 (kHz)
IF Filter Bandwidth        : 15 (kHz)
Max Pa Power               : 48 (dBm)
Tx Gain                    : 68 (dB)
Rx Gain                    : 26 (dB)
```

Figure 7-37 View RFM Configurations

```
operator@AirlinkWCP-$ show wcp l1l2statistics
show wcp l1l2statistics

----- L1L2 STATISTICS -----
Tx Frame Count             : 12
Rx Frame Count             : 12
Header CRC Pass Count      : 12
Header CRC Fail Count      : 4
Packet CRC Pass Count      : 12
Packet CRC Fail Count      : 0
Frame Sync Count           : 16
```

Figure 7-38 View RF Frames Statistics

```

operator@AirlinkWCP-$ show wcp statistics
show wcp statistics

-----RF PORT STATISTICS -----
Tx Byte Count           : 376
Rx Byte Count           : 161
Tx ATCS Datagram Count  : 0
Rx ATCS Datagram Count  : 0
Ground contact          : In progress

-----SERIAL PORT J1 STATISTICS -----
Serial Port J1 Operates in Asynchronous Mode

Tx Byte Count           : 2669
Rx Byte Count           : 2304
Tx Byte Count (Driver)  : 2663
Rx Byte Count (Driver)  : 2299
Parity Error Count      : 0
Rx Overrun Count        : 0
CRC Error Count         : 0
Framing Error Count     : 0
Tx Frame Count          : 0
Rx Frame Count          : 0

-----SERIAL PORT J2 STATISTICS -----
Port Disabled

```

Figure 7-39 View RF and Serial Ports Statistics

```

operator@AirlinkWCP-$ show wcp gps time
show wcp gps time
UTC 2080-01-09 05:00:35

```

Figure 7-40 View GPS Time

```

admin@AirlinkWCP-$ show wcp temperature
show wcp temperature
TSTAMP 2022/09/09 03:02:43
CBB Temperature        : 33 (degree C)
PA Temperature         : 32 (degree C)

```

Figure 7-41 View CBB Temperature

```
operator@AirlinkWCP-$ show wcp uptime
show wcp uptime
0 days, 0:15:18
```

Figure 7-42 View System Uptime

```
operator@AirlinkWCP-$ show wcp currenttime
show wcp currenttime
Thu Aug 19 15:44:35 UTC 2021
```

Figure 7-43 View Current Time and Date

```
admin@AirlinkWCP-$ show wcp frameCount
show wcp frameCount

----- RF PORT FRAME STATISTICS -----
Tx Frame Count      : 14556
Rx Frame Count      : 17101
```

Figure 7-44 RF Port Frame Statistics

### 7.4.2.3 VOLATILE CONFIGURATION CHANGE

An administrator user can configure the Airlink WCP dynamically (while the application is running) via the CLI. This function is only available in admin mode. These configuration changes are not saved permanently. On reboot, the parameter values will revert to their original values. BERT mode configurations are completed here. The available volatile configuration parameters are shown in the following figure. The following table and figures describe the CLI commands for volatile configuration changes.

```
admin@AirlinkWCP-$ con
bertMode
carrierMode
dateAndTime
rxgain
txCalibrationMode
txPower
```

Figure 7-45 Available Volatile Configuration Parameters

Table 7-5 CLI Commands for Volatile Configuration Changes

CLI Command	Description
"config wcp radio rxgain <gainIndB>"	Dynamically configuring Rx gain which takes effect immediately. Use "?" at the end of command to know the present value (Figure 7-46).
"config wcp radio maxTxPower <pwrlIndB>"	Dynamically configuring Tx power which takes effect immediately. Use "?" at the end of command to know the present value (Figure 7-47 and Figure 7-48).
"config wcp radio bertMode txEnable"	Disable operational mode and enable BERT Tx mode. BERT packets are transmitted by Airlink WCP (Figure 7-49).
"config wcp radio bertMode rxEnable"	Disable operational mode and enable BERT Rx mode. BERT packets are received by Airlink WCP (Figure 7-50).
"config wcp radio bertMode disable"	Disabled BERT mode and enter into operational mode (Figure 7-51).
"config wcp radio dateAndTime <yr-mon-date;hr:min:sec>"	Configuring the date and time (Figure 7-52).
"config wcp radio carrierMode enable"	Enable Carrier Tx Mode (Figure 7-53)
"config wcp radio carrierMode disable"	Disable Carrier Tx Mode (Figure 7-54)
"config wcp radio txCalibrationMode enable"	Enable Tx Calibration Mode in which a non-continuous test signal is transmitted every 1 second (Figure 7-55).
"config wcp radio txCalibrationMode disable"	Disable Tx Calibration Mode (Figure 7-56).



```
admin@AirlinkWCP-$ config wcp radio rxgain 25
config wcp radio rxgain 25
Rx Gain set: 25 (dB)
```

Figure 7-46 Rx Gain Configuration

```
admin@AirlinkWCP-$ config wcp radio tx
<prIndBm>
admin@AirlinkWCP-$ config wcp radio txPower
?
config wcp radio txPower ?
45.00 (dBm)
```

Figure 7-47 Tx Power Configuration (1)

```
admin@AirlinkWCP-$ config wcp radio txPower 45
config wcp radio txPower 45
Max Tx power set: 45.00 (dBm)
```

Figure 7-48 Tx Power Configuration (2)

```
admin@AirlinkWCP-$ config wcp radio bertMode txEnable
config wcp radio bertMode txEnable
BERT Mode Tx enabled
```

Figure 7-49 BERT Tx Mode

```
admin@AirlinkWCP-$ config wcp radio bertMode rxEnable
config wcp radio bertMode rxEnable
BERT Mode Rx enabled
```

Figure 7-50 BERT Rx Mode

```
admin@AirlinkWCP-$ config wcp radio bertMode disable
config wcp radio bertMode disable
BERT Mode disabled
```

Figure 7-51 Disable BERT Mode

```
admin@AirlinkWCP-$ config wcp radio dateAndTime 2021-08-19;03:24:45
config wcp radio dateAndTime 2021-08-19;03:24:45
Thu Aug 19 03:24:45 UTC 2021
```

**Figure 7-52 Date and Time Configuration**

```
admin@AirlinkWCP-$ config wcp radio carrierMode enable
config wcp radio carrierMode enable
Carrier Tx Mode Enabled
```

**Figure 7-53 Enable Carrier Mode**

```
admin@AirlinkWCP-$ config wcp radio carrierMode disable
config wcp radio carrierMode disable
Carrier Tx Mode Disabled
```

**Figure 7-54 Disable Carrier Mode**

```
admin@AirlinkWCP-$ config wcp radio txCalibrationMode enable
config wcp radio txCalibrationMode enable
Tx Calibration Mode Enabled
```

**Figure 7-55 Enable Tx Calibration Mode**

```
admin@AirlinkWCP-$ config wcp radio txCalibrationMode disable
config wcp radio txCalibrationMode disable
Tx Calibration Mode Disabled
```

**Figure 7-56 Disable Tx Calibration Mode**

#### 7.4.2.4 SETTING LOG LEVELS

This function is available in both operator and administrator mode using the “debug” command.

The modules available for logging are:

- controller – ATCS controller application logging
- dockerapp – Docker application logs
- phy – RF L1L2 application logging
- all – Sets log level for both modules.

```
admin@AirlinkWCP-$ de
all
controller
dockerapp
phy
```

Figure 7-57 Debug Modules

The controller and phy log modules have the following standard log levels:

- Critical
- Debug
- Error
- Inform
- Major
- Off
- Trace
- Warning

```
operator@AirlinkWCP-$ debug wcp module co
critical
debug
error
inform
major
off
trace
warning
```

Figure 7-58 Debug Log Levels

The Docker application module has options only to enable or off.

Users other than developers use log levels from Critical to Major. An example is shown in the following figure. Other levels are mostly used by developers for debugging.

```
operator@AirlinkWCP-$ debug wcp module controller major
debug wcp module controller major

operator@AirlinkWCP-$
```

**Figure 7-59 Setting the Log Level ‘Major’ for Controller Module**

#### **7.4.2.5 LOG TO FILE PARAMETER**

The path to access the log file is as follows: /media/common/Logfile.txt

When the LOG\_TO\_FILE parameter is set to 1 in the configuration file, logs are written to the configuration file and only critical logs will be shown on the console. If it is disabled, all logs will be shown on the console and not written to file.

### **7.4.3 COMMANDS APPLICABLE TO MC-IOT MODE ONLY**

This section provides an overview of the CLI configuration and operational aspects of the Airlink WCP when in mission critical Internet-of-Things (MC-IoT) operating mode only.

While many aspects of a link are determined by the Base Station and learned by the remote radio during network entry and regular operation (e.g. provisioning and Quality of Service), certain elements are preconfigured in the remote radio.

#### **7.4.3.1 CONSOLE ACCESS**

MC-IoT CLI can be accessed via SSH using Radio Management IP, using the username “admin-mciot”. MC-IoT CLI is accessible during MC-IoT mode.

#### **7.4.3.2 READ CONFIGURATION INFORMATION**

To view the complete listing of system configurations i.e. IP config, System config, Radio config, etc. the user can issue the “show ms sysconfig” command.

The following table lists CLI commands for system configurations, and these commands are shown in the figures that follow.

**Table 7-6 CLI Commands for System Configurations**

CLI Command	Configuration Description
"show ms phyconfig"	Radio Phy configurations such as Tx Power, CP length, DL/UL symbols etc. (Figure 7-60).
"show ms ipconfig"	IP Address configuration (Figure 7-61).
"show ms sysconfig"	All System configurations such as Radio config, PHY & MAC config, and Scan config etc. (Figure 7-62 and Figure 7-63).

```

show ms phyconfig
-----
FFT Size           : 128
Preamble Type     : Six-symbol Confined Preamble
CP Length         : 32
DL symbols        : 108
UL symbols        : 90
Frame duration code : 14 (200.00 ms)
Zone Type         : AMC 1x6
TX Antenna Selected : TX2
RX Antenna Selected : RX2
GPS enabled       : GPS OFF PREAMBLE ON
GPS delay         : 0
Fixed Timing Enable : Disabled
Base Band Scaling : Dynamic
-----DL Config-----
BS EIRP           : 40 (dBm)
EIRxP - IR_max   : -87 (dBm)
TTG               : 960
RTG               : 960
DIUC # 0         : FEC : 0
DIUC # 1         : FEC : 1
DIUC # 2         : FEC : 2
DIUC # 3         : FEC : 3
DIUC # 4         : FEC : 4
DIUC # 5         : FEC : 5
DIUC # 6         : FEC : 6
DIUC # 7         : FEC : 7
-----UL Config-----
Start of Ranging code : 5
End of Ranging code   : 12
-----

```

**Figure 7-60 View Radio Configuration**

```

show ms ipconfig
*****Ip Configuration*****
Static Ip Configuration      : ENABLED
MS IP Address                : 1.1.1.3
Netmask                      : 255.255.255.0
Gateway                     : 1.1.1.1
MS MAC Address              : 00:21:ee:00:04:30
Vlan Enable                  : 0
Vlan Id                      : 0
Vlan Ip Address             : 0.0.0.0
Vlan Netmask                 : 255.255.255.0
Gateway Vlan Id             : 0
Vlan Gateway                 : 0.0.0.0

```

Figure 7-61 View IP Configuration

```

operator@airlink-$ show ms sysconfig
show ms sysconfig
*****Profile Configuration*****
DL symbols                   : 108
UL symbols                   : 90
Frame duration code         : 14 (200.00 ms)
Zone Type                   : AMC 1X6
*****Radio Configuration*****
AGC Mode                    : Fast AGC mode
Rx Gain                     : 75 (dB)
Power Control mode          : Closed loop power control mode
Max Tx power                : 45 (dBm)
Min Tx power                : -39 (dBm)
Sampling clock              : 168000 (Hz)
Duplex mode                 : HD-FDD
DPD                         : Disabled
Digital Filter              : Enabled
*****Scan Configuration*****
BAND_ID                     : 0
DL RF frequency             : 936062500 (Hz)
UL RF frequency             : 897062500 (Hz)
Preamble Id                 : 0
Sector Id                   : 0
Cell Id                     : 0
DL AMC Bitmap               : 0x1F8
UL AMC Bitmap               : 0x1F8
*****PHY Configuration*****
Preamble Type               : Six-symbol Confined Preamble
Fixed Timing Enable         : Disabled
CP Length                   : 32
Base Band Scaling           : Dynamic
Initial timing adjust       : 0
GPS enabled                 : GPS OFF PREAMBLE ON
GPS delay                   : 0
TX Window                   : Enabled
*****MAC Configuration*****
Max DL Fec                  : 6

```

Figure 7-62 View System Configuration-1

```
*****MAC Configuration*****
Max DL Fec           : 6
Max UL Fec           : 7
Authentication       : Disabled
Encryption           : Disabled
Log To File Enable   : Disabled
SDU Expiry Intvl     : 10000
Schedule Frame Advance : Only UL scheduling
Remote Type          : 0
*****Sys Timer Configuration*****
Lost DL MAP Interval : 10000 (ms)
Lost UL MAP Interval : 10000 (ms)
DCD Timeout value    : 20000 (ms)
UCD Timeout value    : 8000 (ms)
Broadcast Ranging Timeout : 9600 (ms)
T3 Timeout value     : 4000 (ms)
Periodic Ranging time : 10000 (ms)
T6 Timeout value     : 72000 (ms)
T7 Timeout value     : 4000 (ms)
T8 Timeout value     : 4000 (ms)
T10 Timeout value    : 3000 (ms)
T14 Timeout value    : 4000 (ms)
T18 Timeout value    : 14400 (ms)
T42 Timeout value    : 250 (ms)
T43 Timeout value    : 1000 (ms)
T44 Timeout value    : 250 (ms)
T45 Timeout value    : 500 (ms)
Traffic monitoring timeout : 300000 (ms)
*****Debug Nodes Configuration*****
Debug Node 01        : 0
Debug Node 02        : 0
Debug Node 03        : 0
Debug Node 04        : 0
```

Figure 7-63 View System Configuration-2

### 7.4.3.3 READ STATISTICS AND MEASUREMENT INFORMATION

The following table lists the CLI commands available to view real time statistics information, and these commands are shown in the figures that follow.

**Table 7-7 CLI Commands for Viewing Statistics**

CLI Command	Description
"show ms version"	Mode and SW, HW version details (Figure 7-64).
"show ms measurement report"	System measurement report when connected with remote (Figure 7-65).
"show ms l1l2statistics"	L1/L2 RF Frame statistics (Figure 7-66).
"show ms rfmType"	RFM configurations (Figure 7-67).
"show ms statistics"	RF and Serial ports statistics in bytes count (Figure 7-68).
"show ms gps location"	GPS Latitude and Longitude information (if GPS antenna is connected) (Figure 7-69).
"show ms gps time"	GPS time UTC (if GPS antenna is connected) (Figure 7-70).
"show ms temperature"	CBB Board temperature (Figure 7-71).
"show ms uptime"	System uptime (Figure 7-72).

```
operator@airlink-$ show ms version
show ms version
MAC Load : Rev177MsMac_snwe_al.pc7205
PHY Load : cobaltMsPhy_Rev171_dlCC_ulCTC-wcp.pa
```

**Figure 7-64 View MS SW version**



```

show ms measurement report
-----
PA Measurements:
Tx Power Detected      : 35 (mV)
Forward voltage        : 2887 (mV)
Reflected voltage     : 0 (mV)
PA Current             : 2700 (mA)
-----
DL Preamble CINR Reuse 3      : 3 (dB)
Rx Gain                  : 76 (dB)
DL-FreqErr              : -791 (Hz)
UL-FreqErr              : -758 (Hz)
DL Preamble RSSI        : -114 (dBm)
DL RPD                  : -38 (dBm)
DL Path loss           : 154 (dB)
Mean Preamble CINR Reuse 1   : 54 (dB)
Mean Preamble CINR Reuse 3   : 2 (dB)
Mean Preamble RSSI       : -115 (dBm)
MS Tx Power             : 45 (dBm)
Current UL FEC Code      : 0
Current DL FEC Code     : 0
Power Control mode      : Closed loop power control mode

AMC Bands                Effective CINR      Physical CINR
Band [ 3]                2 dB              2 dB
Band [ 4]                7 dB              7 dB
Band [ 5]                6 dB              6 dB
Band [ 6]                1 dB              1 dB
Band [ 7]                6 dB              6 dB
Band [ 8]                3 dB              3 dB

```

Figure 7-65 View Measurement Info

```
admin@airlink-$ show ms llIf statistics
show ms llIf statistics
L1 SOF : 7009
UL Subframe request : 7009
PHY Config REQ sent : 1
PHY Config RSP received : 15
Initial scan sent : 28
Radio config sent : 0
DL Burst received : 2540
DL measurement received : 3810
DL measurement processed : 3810
L1 diag msgs received : 2267
UL subframe sent : 1221
UL control channels : 1221
UL Data bursts sent : 14
UL control msgs sent : 15
UL PDUs : 14
```

Figure 7-66 View RF Frames Statistics

```
operator@airlink-$ show ms rfmType
show ms rfmType
Max Tx Power : 48 (dBm)
Tx Gain : 68 (dB)
Rx Gain : 26 (dB)
DPD Support : No
IF Filter : 0 (BW: 200 (KHz) CF: 241 (MHz))
RF Filter : 0 (BW: 6 (MHz) CF: 938 (MHz))
Mimo Type : SISO
```

Figure 7-67 View RFM Configuration

```

show ms statistics
DL preamble CINR                :    2 dB
DL preamble RSSI                 :  -125 dBm
DL Path loss                     :   165 dB
System frame number              :    268
Number of Frames                 :   7618
Number of DL-MAP Error           :    22
Number of UL-MAP Error           :    25
DL HCS error                     :    0
DL Mgmt CRC error                :    0
DL Data CRC error                :    0
Number of DL Burst received      :   2732
Number of DL PDU received        :    94
Number of DL ARQ PDU received    :    0
Number of DL-MAP received        :   1307
Number of UL-MAP received        :   1324
Number of DCD received           :    0
Number of UCD received           :    0
Number of DL Mgmt SDU received   :    94
Number of DL Data SDU received   :    0
Number of DL out of order packets :    0
Number of UL Burst               :    15
Number of UL slots allocated     :    0
Number of UL SDU's Enqueued      :    30
Number of Mgmt SDU's received    :    94
Number of Mgmt SDU's sent        :    30
Number of UL PDU's sent          :    15
Number of UL ARQ PDU's sent      :    0
Number of UL SDU's Sent          :    0
Number of UL SDU's dropped       :    0
Number of Initial ranging codes sent :   16
Number of Periodic ranging codes sent :    0
Number of HO CDMA Code sent      :    0
Number of BW request codes sent  :    0
Number of CDMA alloc rcvd        :    0
Number of unused CDMA alloc      :    0
Number of Broadcast RNG-RSP rcvd :   27
Number of CDMA RNG-RSP rcvd      :    0
Number of Mgmt RNG-RSP rcvd      :    0
Number of SDU buffer get failed   :    0
Number of BW req and Ul Tx Pwr Hdr sent :    0
Number of aggr BW request        :    0
Number of burst per frame        : #1 15 #2 0 #3 0
Number of PDUs per burst         : #1 15 #2 0 #3 0
Number of padding PDUs           :    15
Number of padding bytes          :    90
Serial communication baud rate    : 115200

```

Figure 7-68 View System Statistics

```
operator@airlink-$ show ms gps location
show ms gps location

+37.410600, -122.020378 , 24.8 M
```

Figure 7-69 View GPS Location

```
operator@airlink-$ show ms gps time
show ms gps time
UTC 2022-10-12 07:51:56
```

Figure 7-70 View GPS Time

```
operator@airlink-$ show ms temperature
show ms temperature
CBB Temperature      : 29 (degree C)
PA Temperature       : 25 (degree C)
```

Figure 7-71 View CBB Temperature

```
operator@airlink-$ show ms uptime
show ms uptime
0 days, 4:04:19
```

Figure 7-72 View System Uptime

### 7.4.3.4 VOLATILE CONFIGURATION CHANGE

An administrator user can configure the Airlink WCP dynamically (while the application is running) via the CLI. This function is only available in administrator mode. These configuration changes are not saved permanently. On reboot, the parameter values will revert to their original values. The following figure shows the available volatile configuration parameters.

```
admin@airlink-$ con
mac
radio
admin@airlink-$ config ms
```

Figure 7-73 Available Volatile Configuration Parameters

The following table lists possible commands for volatile configuration changes and these are shown in the figures that follow.

Table 7-8 CLI Commands for Volatile Configuration Changes

CLI Command	Description
"config ms radio rxgain <gainIndB>"	Dynamically configuring Rx gain which takes effect immediately. Use "?" at the end of the command to know the present value. This configuration is valid in AGC disable case (Figure 7-74).
"config ms radio maxtxpower <pwrIndB>"	Dynamically configuring Tx power which takes effect immediately. Use "?" at the end of the command to know the present value (Figure 7-75).

```
admin@airlink-$ config ms radio maxtxpower 43
config ms radio maxtxpower 43
Max Tx power set:43 (dBm)
```

Figure 7-74 Tx Power Configuration

```
admin@airlink-$ config ms radio rxgain 50
config ms radio rxgain 50
Rx Gain set:50 (dB)
```

Figure 7-75 Rx Gain Configuration

### 7.4.3.5 SETTING LOG LEVELS

This function is available in both operator and administrator mode using the “debug” command.

The modules available for logging are:

- ms – RF L1/L2 application logging
- phy – Users other than developers use log levels from Critical to Major. Other levels are mostly used by developers for debugging.

The Debug modules and log levels are shown in the figures that follow.

```
admin@airlink-$ de
ms
phy
admin@airlink-$ debug
```

Figure 7-76 Debug Modules

```
admin@airlink-$ debug ms
all
arq
cli
dsx
eap
harq
idle
infra
llif
l3
l3if
mobility
nentry
pdudecoder
pduencoder
pkm
ranging
rrm
scheduler
sleep
admin@airlink-$ debug ms module
```

Figure 7-77 Debug ms Log Levels

```
admin@airlink-$ debug p
all
dlp
mscan
prfp
prtp
reset
tdd
ulp
admin@airlink-$ debug phy module

admin@airlink-$ debug phy module a
critical
debug
error
inform
major
off
trace
warning
admin@airlink-$ debug phy module all
```

Figure 7-78 Debug phy Log Levels

This Page Intentionally Left Blank



## CHAPTER 8 – TROUBLESHOOTING

### 8.1 GENERAL

Extensive error and status indications are provided to aid in maintaining and troubleshooting the Airlink WCP. Two information levels are obtainable, depending on whether a laptop computer is available.

### 8.2 CODE SYSTEM APPLICATION

Initial troubleshooting involves determining the most likely location of the fault. On a code line with a number of field and base stations, it is relatively simple to locate the common denominator if more than one location is not responding. This could be a shared base station, shared wire line, or leased circuit between base stations and the office, or the office equipment. If the fault is isolated to a specific location, the following information may be helpful.

#### 8.2.1 RF LINK

ATCS code systems transmit periodic messages (about once every minute) from the field to the office. By detecting and following the flow of this traffic, the fault can quickly be localized.

RF traffic can be monitored on a laptop, or by the LED display. The TX LED lights each time the Airlink WCP transmits, while the RX LED lights each time a valid ATCS header is received.

The Apollo tool monitors the data messages. Refer to Section 7.3.4.5 of this manual for information on using the Apollo tool to view the log. By using the ATCS datagram structure provided, the messages can be decoded to determine their labels, destinations, and source addresses.

**NOTE****NOTE**

In the destination and source address fields, a zero (0) is always represented by the character A (e.g., 50 is written as 5A).

The log output messages are displayed in the Apollo Tool Log as shown in the following samples:

**RF Data message:**

```

2021/09/03 20:58:25 DOCKER APP LOG: RADIO : RX [FIELD] [ 23] [CODELINE_INDICATION]: 68 00 68 00 E0 76 2A AA 2A 14 A1 A2 00 68
02 02 12 8B 04 01 00 08 B4
2021/09/03 20:58:25 DOCKER APP LOG: ROUTER: RX [RADIO] [ 23] [CODELINE_INDICATION]: 68 00 68 00 E0 76 2A AA 2A 14 A1 A2 00 68
02 02 12 8B 04 01 00 08 B4
2021/09/03 20:58:25 DOCKER APP LOG: ROUTER: TX [NETWRK] [ 23] [CODELINE_INDICATION]: 68 00 68 00 E0 76 2A AA 2A 14 A1 A2 00
68 02 02 12 8B 04 01 00 08 B4
2021/09/03 20:58:25 DOCKER APP LOG: NETWRK: RX [ROUTER] [ 23] [CODELINE_INDICATION]: 68 00 68 00 E0 76 2A AA 2A 14 A1 A2 00
68 02 02 12 8B 04 01 00 08 B4
2021/09/03 20:58:26 DOCKER APP LOG: NETWRK: TX [OFFICE] [ 29] [CODELINE_INDICATION]: 93 8A 8C 54 1B 21 68 48 68 00 E0 76 2A AA
2A 14 A1 A2 00 68 02 02 12 8B 04 01 00 08 B4
2021/09/03 20:58:26 DOCKER APP LOG: NETWRK: RX [OFFICE] [ 16] [L3_ACK           ]: 23 39 8C 54 1B 21 38 6A 0E 76 2A AA 2A 14 A1 A2
2021/09/03 20:58:26 DOCKER APP LOG: NETWRK: TX [ROUTER] [ 10] [L3_ACK           ]: 38 6A 0E 76 2A AA 2A 14 A1 A2
2021/09/03 20:58:26 DOCKER APP LOG: ROUTER: RX [NETWRK] [ 10] [L3_ACK           ]: 38 6A 0E 76 2A AA 2A 14 A1 A2
2021/09/03 20:58:26 DOCKER APP LOG: ROUTER: TX [RADIO] [ 10] [L3_ACK           ]: 38 6A 0E 76 2A AA 2A 14 A1 A2

```

**Serial Data message:**

```

2021/08/18 16:11:53 SER_1 : TX [OFFICE] [ 13] [HDLC_UI           ]: 01 13 34 04 E0 76 2A AA 2A A1 A1 A2 BA
2021/08/18 16:11:57 SER_1 : RX [OFFICE] [ 31] [HDLC_UI           ]: 01 13 64 00 02 00 AE 76 2A AA 2A A1 A1 A2 26 2A A2 5A A2 00 0E 02
02 12 01 03 01 02 08 00 04

```

Normal traffic on this link consists of indication, control, and recheck messages which are approximately 26 bytes in length. The RF acknowledged messages are considerably shorter at approximately 12 bytes each. Activity is present only when controls, indications, or rechecks are being sent (no polling).

**8.2.2 CODE SYSTEM TROUBLESHOOTING**

1. Verify that the location transmits at least once each minute by observing the RF TX LED indicator on the Airlink WCP front panel, or by monitoring message traffic using Apollo. If the LED lights, proceed to step 4.
2. Verify that the office equipment acknowledges the transmission. The RF RX LED normally flashes in response to each transmission. If the RX LED does not flash, or if the radio rejects the response, the transmission is repeated five times with a delay between transmissions of approximately 6 seconds. If the RF RX response is seen each time with no retries, the problem is not associated with the indication messages.
3. If the radio transmits at least once each minute but there is no response from the office, check the following:
  - a. Antenna connections and reflected power.
  - b. Radio power supply voltage - Verify that the voltage level does not drop during transmissions.
  - c. Radio output power - Verify peak transmit current ( $\pm 10$  Amperes) or use an RF wattmeter.
  - d. Radio frequency – Set on radio using the Apollo tool.
  - e. Verify ATCS message format using Apollo. Ensure the correct site address and code line number are used and that an indication message is being sent periodically to the proper office address.

If all of the above items are normal, the base station location must be monitored to determine if the problem is at the base site or along the line to the office equipment.

4. No transmissions from the field:
  - a. Verify that the PWR LED on the Airlink WCP front panel is lighted.
  - b. Verify that all self-tests are passed.
  - c. Attempt a manual key-up by initiating the bit error rate test (BERT) using the command line (refer to section 7.4.3.6).
  - d. Verify that the Airlink WCP has acquired its client IDs. These are available in the Docker application only. Most Airlink WCPs are configured such that their ID is supplied by the attached code system.
  - e. Check the ground contact status on the front panel. Normally, after a reset, the Airlink WCP attempts to establish ground contact with the office.

### 8.2.3 MC-IoT TROUBLESHOOTING

If properly configured, the base station and the Airlink WCP should connect within one minute after being turned on. If the connection is not established, refer to the following table for troubleshooting issues and corrective actions.

**Table 8-1 Connection Troubleshooting Issue and Corrective Action**

Connection Issue	Corrective Action
Configuration Mismatch	<p>Verify that both the Airlink WCP and the base station are configured for the same configuration.</p> <p>Note that if the configuration is to be changed over the radio link, then it is essential to configure all base station units before configuring the Airlink WCP unit, as connectivity to the base station unit will be lost after the new configuration is implemented.</p> <p>Symbolic Link: It is important to note that the system relies on symbolic links to the desired configuration file.</p> <p>Multiple configurations can be stored on each radio, but only the one linked is active. If the symbolic link is to the wrong configuration file, then the unit will not connect.</p>
Excessive Pathloss	<ul style="list-style-type: none"> <li>• In a lab setup, verify that the attenuation between the Airlink WCP and the base station is set properly and does not exceed 90 dB. Do not power on the radios without the proper attenuation between the units.</li> <li>• In an operational environment, verify that the path loss is acceptable and that the connections to the antennas are secure and proper.</li> <li>• Verify that the antennas are correctly installed per the RF plan.</li> </ul>
Cabling & Antennas	Verify that both the Airlink WCP and base station along with their associated RF cabling and antennas are properly grounded.
Interference	<p>Perform an RF scan using Apollo to verify that the channel is clear of RF interference.</p> <p>Note that the radio has an very large RF range and as such, out of TX/RX band RF energy can affect the radio's sensitivity. Proper use of external filters can reduce this interference.</p>
Airlink WCP Detected & No Connection	If the Airlink WCP is detected (DL ACQUIRED) but a connection is not established, then the user must carry out the following steps to determine the cause:

	<ul style="list-style-type: none"> <li>• Perform an RF scan using Apollo to verify that there is no interference in the channel. This needs to be performed at both the base station site and the Airlink WCP site. Note that in most installations, the Airlink WCP site is normally installed on a high tower and as such, the antenna is more susceptible to interference which could obscure the reception of the base station signal. Given this, a highly directional Yagi antenna, aligned properly is always preferred.</li> <li>• Verify the orientation (both horizontal and vertical) of the antennas.</li> <li>• Check the TX power of each unit. If both units are transmitting at maximum power, then there is most likely an issue with the RF path. Note that the Airlink WCP actively controls the TX power of the base station. So, if the base station is transmitting at maximum power, then that is an indication that the signal level is too low at the Airlink WCP. In this case, there is either interference obscuring the signal, the antennas are misaligned (which reduces the signal level), the RF cabling or lightning protector are damaged or possibly water has entered the connectors or cables.</li> </ul>																											
<p>Low Throughput</p>	<p>The throughput is dynamically determined based on the RF environment and the default configuration for this is shown in the following table:</p> <table border="1" data-bbox="683 1073 1318 1503"> <thead> <tr> <th>FEC</th> <th>CINR</th> <th>Modulation</th> </tr> </thead> <tbody> <tr> <td>0</td> <td>0-5</td> <td>QPSK 1/2</td> </tr> <tr> <td>1</td> <td>6-8</td> <td>QPSK 3/4</td> </tr> <tr> <td>2</td> <td>9-12</td> <td>QAM 16 1/2</td> </tr> <tr> <td>3</td> <td>13-17</td> <td>QAM 16 3/4</td> </tr> <tr> <td>4</td> <td>N/A</td> <td>QAM 64 1/2*</td> </tr> <tr> <td>5</td> <td>18-19</td> <td>QAM 64 2/3</td> </tr> <tr> <td>6</td> <td>20-21</td> <td>QAM 64 3/4</td> </tr> <tr> <td>7</td> <td>22+</td> <td>QAM 64 5/6</td> </tr> </tbody> </table> <p>*QAM 64 1/2 is not implemented.</p> <p>To increase throughput, the CINR needs to increase to support the higher modulation techniques as shown.</p>	FEC	CINR	Modulation	0	0-5	QPSK 1/2	1	6-8	QPSK 3/4	2	9-12	QAM 16 1/2	3	13-17	QAM 16 3/4	4	N/A	QAM 64 1/2*	5	18-19	QAM 64 2/3	6	20-21	QAM 64 3/4	7	22+	QAM 64 5/6
FEC	CINR	Modulation																										
0	0-5	QPSK 1/2																										
1	6-8	QPSK 3/4																										
2	9-12	QAM 16 1/2																										
3	13-17	QAM 16 3/4																										
4	N/A	QAM 64 1/2*																										
5	18-19	QAM 64 2/3																										
6	20-21	QAM 64 3/4																										
7	22+	QAM 64 5/6																										
<p>Console Messages are slow or garbled</p>	<p>Verify correct interface settings for console</p>																											

This Page Intentionally Left Blank

## APPENDIX A – ADVANCED TRAIN CONTROL SYSTEM

### A. ADVANCED TRAIN CONTROL SYSTEM

#### A.1 OVERVIEW

The Advanced Train Control System (ATCS) standardizes the message formats and addressing scheme used by all railroads for train control applications. The system operates by sending and receiving standard datagrams (using a standard addressing scheme) between the various ATCS compatible signaling and operating equipment. Addresses are provided for wayside equipment, central office equipment, on-board equipment, base stations, maintenance equipment, railcars, and anything else found in a railroad environment. These messages convey operating instructions and status information such as track-and-time permits, codeline controls and indications, hot-box data, etc.

A typical ATCS network is shown in Figure A-1. Centralized Train Control (CTC) office equipment communicates with the onboard and wayside equipment via Base Communication Packages (BCPs), controlled by Cluster Controllers (CCs). Network Management System (NMS) office equipment monitors the dynamic performance of the network. Field radios are a mixture of Wayside Communication Packages (WCPs) and Spread-Spectrum Radios (SSRs). All communications use ATCS datagrams or packets.

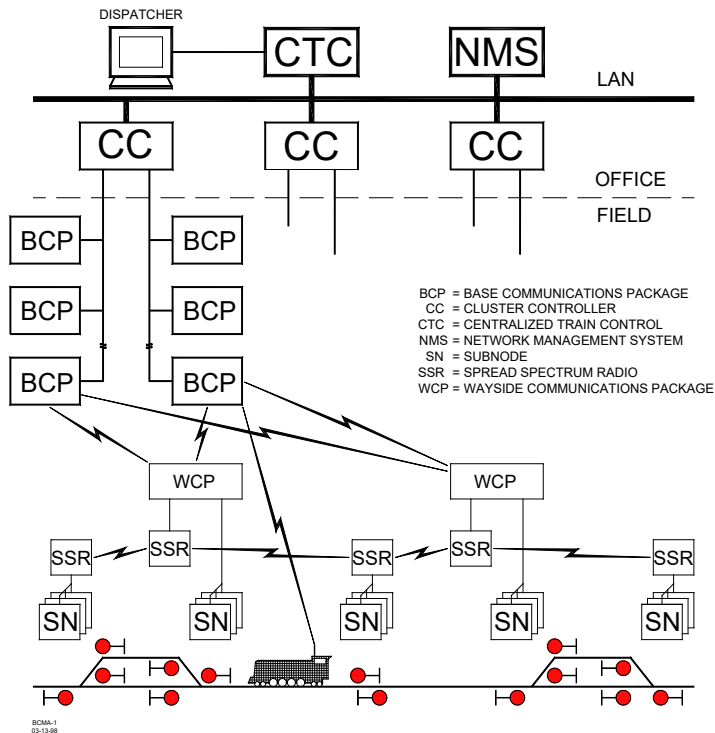

Figure A-1 Typical ATCS Network

## A.2 ATCS ADDRESSING

Each ATCS datagram carries with it a destination address (i.e., the address of the equipment it is destined for), and a source address (i.e., the equipment that generated it). These addresses are constructed with slight differences for the various uses. For example, on-board equipment will have a Type 1 (locomotive) address while wayside equipment will have a Type 7 (wayside) address. A number of the various types of addresses used are described in the following paragraphs. For further information concerning ATCS addressing, refer to the following specifications:

- ATCS Specification 200 (March 1993) - ATCS Protocols
- ATCS Specification 250 (March 1993) - ATCS Message Formats
- ATCS Specification 700 (March 1993) - CPC Specification
- ATCS Specification 157 (March 1993) - CPC Operation
- R/Link ATCS Radio Code Line System Application Logic Generation Guide (Siemens Mobility, Inc. Document No. C-00-94-06).

### A.2.1 LOCOMOTIVE ADDRESSES (TYPE 1)

Each locomotive address consists of twelve digits in the following format: **1.RRR.VVVVV.DD** where:

1	=	Locomotive address type
RRR	=	Railroad number (see Appendix D)
VVVVV	=	Locomotive number
DD	=	Device on board locomotive (e.g., Engineers display)

### A.2.2 OFFICE EQUIPMENT ADDRESSES (TYPE 2)

Each office equipment address consists of ten digits in the following format: **2.RRR.NN.DDDD** where:

2	=	Office equipment address type
RRR	=	Railroad number (see Appendix D)
NN	=	Unit in the office (e.g., CTC computer, A53401 Packet Switch, etc.)
DDDD	=	Application in the office (e.g., maintenance alarm monitoring)



### A.2.3 BASE STATION ADDRESS (TYPE 3)

Each address consists of ten digits in the following format: **3.RRR.NN.DDDD**  
where:

3	=	Wire line address type
RRR	=	Railroad number (see Appendix D)
NN	=	Node number (railroad defined)
DDDD	=	Base device number (railroad defined)

The ATCS specification recommends that the BCP node number be the same as the node number of the CC (A47620) to which it is connected. The device number is user defined and can be set to any convenient value.

### A.2.4 WAYSIDE EQUIPMENT (TYPE 5)

The type 5 wayside address was used on earlier ATCS systems and is the default addressing scheme for Advanced Railroad Electronic System (ARES) wayside equipment. Although the ARES network differs slightly from the ATCS specification, for purposes of this discussion, the two can be considered identical systems.

Each address consists of ten digits in the following format: **5.RRR.NN.LL.GG**  
where:

5	=	Wayside address type
RRR	=	Railroad number (see Appendix D)
NN	=	Node or routing region number
LL	=	Code-line number
GG	=	Group or location number

This addressing scheme does not have the ability to address multiple devices at each location. The node number typically follows the node number of the CC controlling the base stations for the location.

### A.2.5 WAYSIDE EQUIPMENT (TYPE 7)

This is the default ATCS wayside addressing scheme.

Each address consists of fourteen digits in the following format: **7.RRR.LLL.GGG.SS.DD** where:

7	=	Wayside address type
RRR	=	Railroad number (see Appendix D)
LLL	=	Code-line or region number
GGG	=	Group or location number
SS	=	Equipment or subnode at location
DD	=	Device controlled by this equipment

The LLL fields are normally assigned by each railroad according to internal conventions, and may represent a region, district, code line, or other area designation that shows it is part of the railroad.

The GGG field must be coordinated between the CTC equipment and field equipment configuration.

For the SS field, two subnode numbers are always pre-assigned at each location. The wayside-to-office communications device is defined as number 01, and number 02 is reserved for the wayside-to-wayside communications system. Any additional equipment (e.g., the R/Link™ I/O modules), will therefore have subnode numbers starting with 03.

Device numbers (DD field) are allocated in sequence beginning at 01. Each piece of field equipment has at least one internal device, but it may have more depending on the equipment.

Examples of full ATCS addresses for a wayside code system would be as follows:

For CP Rail, code line 8, control point 1: 7.105.008.001.03.02.

For the MCP radio at the same location: 7.105.008.001.01.01.

### A.2.6 OTHER ADDRESS TYPES

Other address types are defined in ATCS for future applications. Please refer to the appropriate ATCS specifications for full details.

### A.3 ATCS MESSAGE FORMATS

The major fields in an ATCS message are shown in Figure A-2.



**Figure A-2 Major Fields of an ATCS Message**

The **Destination** field is the address of the recipient equipment. For example, if this is an indication message coming from a wayside code unit, the destination address will be the CTC dispatching equipment (2.RRR.NN.DDDD).

The **Source** field is the sender’s address (e.g., 7.RRR.LLL.GGG.SS.DD).

The number in the message number (**M#**) field is allocated by the sender in a sequential fashion so that the recipient can detect duplicate, missing, or out of order messages.

The **Label** field describes the type of data carried by the message. Many different labels have been defined in ATCS Specification 250. Additional labels are defined by suppliers to perform custom functions.

The **Data** field carries the particular data required for the type of message defined by the Label field.

### A.4 ATCS RADIO NETWORK – LAYER 1

The ATCS radio network consists of pairs of UHF channels. These channels are as follows:

Channel Number	Base to Mobile Frequency	Mobile to Base Frequency
1	935.8875	896.8875
2	935.9375	896.9375
3	935.9875	896.9875
4	936.8875	897.8875
5	936.9375	897.9375
6	936.9875	897.9875

<b>NOTE</b>	<b>NOTE</b>
	Transmission on the channels is baseline FSK. The deviation of the carrier to a higher frequency is interpreted as a logical 0 and to a lower frequency as a logical 1. The bit rate is 4800 bits per second. Nominal channel separation is 12.5kHz.

This Page Intentionally Left Blank

## APPENDIX B – ATCS SPECIFICATION 250 RAILROAD CODE LIST

### B. RAILROAD CODE LISTING

The following chart lists the codes assigned to all carriers in accordance with ATCS Specification No. 250 and includes the railway carrier name along with the alphabetical and numerical codes assigned to each. In the event a discrepancy exists between the information in the following list and the current AAR specification, the AAR specification shall prevail.

ID	Company Name	RR Mark	ATCS
001	Aberdeen And Rockfish Railroad Company	AR	009
002	Akron & Barberton Belt Railroad Company	ABB	002
003	Alabama & Florida Railway Co	AF(LR)	917
004	Alameda Belt Line	ABL	014
005	Alameda Corridor Transportation Authority	ACTA	015
006	Alaska Hydro-Train	AHT	039
007	Alaska Railroad Corporation	ARR	005
008	Alexander Railroad Company	ARC	049
009	Algers Winslow And Western Railway Company	AWW	004
010	Algoma Central Railroad Inc	AC	008
011	Allegheny & Eastern Railroad Inc	ALY	532
012	Alley Railroad Company		664
013	Almanor Railroad Company	AL	046
014	Alton & Southern Railway Company	ALS	032
015	Amador Central Railroad Company	AMC	019
016	Andalusia & Conecuh Railroad Company	ACRC	173
017	Angelina & Neches River Railroad Company	ANR	035
018	Anthracite Railway Inc	ATRW	176
019	Apache Railway Company	APA	011
020	Apalachicola Northern Railroad Company	AN	012
021	Appanoose County Community Railroad Inc	APNC	226

<b>ID</b>	<b>Company Name</b>	<b>RR Mark</b>	<b>ATCS</b>
022	Arcade And Attica Railroad Corporation	ARA	013
023	Arkansas And Missouri Railroad Co	AM	906
024	Arkansas Louisiana & Mississippi (Missouri) Railroad	ALM	016
025	ARTC		047
026	Ashley, Drew & Northern Railway Company	AND	020
027	Ashtabula Carson & Jefferson Railroad	ACJR	235
028	Atchison, Topeka And Santa Fe Railway Company ATS	ATSF	022
029	ATCS Shared Network	ATCS	340
030	ATCS Testing & Field Evaluation	ATCR	050
031	ATCS Testing & Field Evaluation	ATCT	620
032	Atlantic & Western Railway, L P	ATW	025
033	Austin Railroad	AUNW	924
034	Austin, Todd And Ladd Railroad Company	ATLT	514
035	Baltimore And Annapolis Railroad Company	BLA	053
036	Bangor & Aroostook Railroad Company	BAR	056
037	Bath and Hammondsport Railroad Company	BH	079
038	Batten Kill Railroad Inc	BKRR	086
039	Bauxite & Northern Railway Company	BXN	084
040	Bay Colony Railroad Corporation	BCLR	082
041	Bayside Railway Co		021
042	BC HYDRO RAIL	BCE	072
043	BC RAIL LTD	BCOL	997
044	Beaufort And Morehead Railroad Company	BMH	068
045	Beech Mountain Railroad Company	BEEM	060
046	Belfast And Moosehead Lake Railroad Company	BML	087
047	Belt Railway Company Of Chicago	BRC	083
048	Belton Railroad Company	BRR	207
049	Berlin Mills Railway	BMS	073

<b>ID</b>	<b>Company Name</b>	<b>RR Mark</b>	<b>ATCS</b>
050	Bessemer And Lake Erie Railroad Company	BLE	061
051	Birmingham Southern Rr Co	BS	065
052	Black River & Western Corporation	BRW	066
053	Bloomer Line, The	BLOL	223
054	Blue Mountain And Reading Railroad	BMRG	256
055	Border Pacific Railroad Co	BOP	225
056	Boston And Maine Corporation	BM	069
057	Brandon Corporation	BRAN	081
058	Brandywine Valley Railroad Company	BVRY	067
059	Broken Hill Proprietary Co.		042
060	Brownsville And Rio Grande International Rr	BRG	170
061	Buffalo Southern Railroad Inc	BSOR	085
062	Burlington Junction Railway	BJRY	383
063	Burlington Northern (Manitoba) Ltd	BNML	457
064	Burlington Northern Railroad Company	BN	076
065	Burlington Northern Santa Fe	BNSF	777
066	C&J Railroad Investment Company	CJRR	565
067	Cadillac And Lake City Railway Co	CLK	093
068	Cadiz Railroad Company	CAD	092
069	Cairo Terminal	CTML	162
070	California Western	CWR	100
071	CALTRAIN	CALTRAIN	708
072	Camas Prairie Railnet, Inc	CSP	952
073	Cambria And Indiana Railroad Company	CI	101
074	Canada And Gulf Terminal Railway Company, The	CGT	116
075	Canadian National Railways	CN	103
076	Caney Fork And Western Rr	CFWR	187
077	Canton Railroad Company	CTN	097

<b>ID</b>	<b>Company Name</b>	<b>RR Mark</b>	<b>ATCS</b>
078	Cape Fear Railways Inc	CF	099
079	Carolina Rail Services Inc	CRIJ	988
080	Carrollton Railroad	CARR	113
081	Carthage Knightstown & Shirley Railroad	CKSI	396
082	Cedar Rapids & Iowa City Railway Company	CIC	111
083	Cedar Valley	CVAR	313
084	Central California Traction Company	CCT	112
085	Central Indiana & Western Railroad Co Inc	CEIW	949
086	Central Michigan Railway Co	CMGN	472
087	Central Montana Rail Inc	CM	374
088	Central New York Railroad Corporation	CNYK	151
089	Central Vermont Railway	CV	120
090	Central Western Railway Corp	CWRL	527
091	Charles City Rail Lines	CCRY	967
092	Chattahoochee Industrial Railroad	CIRR	222
093	Chattahoochee Valley	CHV	124
094	Chelatchie Prairie Railroad	CCPR	155
095	Chesapeake And Ohio Railway Company	CO	125
096	Chesapeake Western	CHW	179
097	Chestnut Ridge Railway Company	CHR	117
098	Chicago And Northwestern	CNW	131
099	Chicago And West Pullman	CWP	172
100	Chicago And Western Indiana	CWI	132
101	Chicago Central & Pacific Railroad Co	CC	569
102	Chicago Heights Terminal Transfer Railroad Company	CHTT	139
103	Chicago Illinois Midland	CIM	130
104	Chicago Short Line Railway Company	CSL	147
105	Chicago Southshore & South Bend Railroad	CSS	168



<b>ID</b>	<b>Company Name</b>	<b>RR Mark</b>	<b>ATCS</b>
106	Cimarron Valley Railroad, L C	CVR	378
107	City Of Columbia	CT	090
108	City Of Prineville Railway	COP	166
109	Claremont Concord Railroad Corporation	CCRR	188
110	Clarendon And Pittsford Railroad Company, The	CLP	169
111	Cliffside Railroad Company	CLIF	181
112	Colonels Island Railroad Co	CISD	164
113	Colorado & Wyoming Railway Co	CW	158
114	Colorado Springs & Eastern	CSE	319
115	Columbia & Cowlitz Railway Company	CLC	163
116	Columbia & Silver Creek Railroad Company	CLSL	165
117	Columbus And Greenville Railway	CAGY	177
118	Conemaugh & Black Lick Railroad Company	CBL	215
119	Connecticut Central	CCCL	416
120	Connecticut Department of Transportation	CDOT	007
121	Consolidated Rail Corporation	CR	190
122	Cooperstown and Charlotte Valley Rwy	CACV	114
123	Copper Basin Railway Inc	CBRY	909
124	Corinth and Counce	CCR	201
125	Corman	RJCR	970
126	Cotton Belt (St. Louis Southwestern Rwy Company)	SSW	694
127	CP RAIL SYSTEM	CP	105
128	Crab Orchard & Egyptian Railroad	COER	089
129	CSXT	CSXT	171
130	Curtin Milburn	CMER	180
131	Cuyahoga Valley Railway Company, The	CUVA	186
132	D & I Railroad Company	DAIR	211
133	Dakota Minnesota & Eastern Railroad Corp	DME	912

<b>ID</b>	<b>Company Name</b>	<b>RR Mark</b>	<b>ATCS</b>
134	Dakota Rail Inc	DAKR	221
135	Dakota Southern Railway Company	DSRC	526
136	Dansville And Mount Morris Railroad Company, The	DMM	220
137	Dardanelle & Russellville Railroad Company,	DR	191
138	Davenport Rock Island And North Western Railway Co	DRI	192
139	Delaware & Hudson Railway Company Inc	DH	195
140	Delaware Coast Line Rr Co	DCLR	214
141	Delta Valley & Southern Railway Company	DVS	193
142	Denver Union Terminal Ry Co.	DUT	288
143	Dequeen And Eastern Railroad Company,	DQE	200
144	Des Moines Union	DMU	202
145	Detroit And Mackinac	DM	204
146	Dominion And Atlantic	DA	209
147	Doniphan Kensett & Searcy Railway	DKS	210
148	DRGW	DRGW	197
149	Duluth & Northeastern Railroad Company,	DNE	212
150	Duluth Missabe And Iron Range Railway Company	DMIR	213
151	Duluth Winnipeg And Pacific Railway Company	DWP	216
152	Dunn-Erwin Railway Corporation	DER	219
153	East Camden & Highland Rr Co	EACH	242
154	East Cooper And Berkeley Railroad Company	ECBR	229
155	East Erie Commercial Railroad	EEC	040
156	East Jersey Railroad And Terminal Company	EJR	245
157	East St. Louis Junction Rr	ESLJ	233
158	East Tennessee Railway, L P	ETRY	257
159	Eastern Shore Railroad Inc	ESHR	251
160	Edgemoor & Manetta	EM	232
161	El Dorado And Wesson Railway Company	EDW	247

<b>ID</b>	<b>Company Name</b>	<b>RR Mark</b>	<b>ATCS</b>
162	Elgin Joliet & Eastern Railway Company	EJE	238
163	EsCANABA And Lake Superior Railroad Company	ELS	241
164	Esquimalt And Nanaimo	EN	246
165	Essex Terminal Railway Company The	ETL	228
166	Eureka Southern	EUKA	368
167	Everett Railroad	EV	231
168	Falls Creek	FCRK	267
169	Farmrail Corporation	FMRC	280
170	FCA - Ferrovía Centro - Atlántica SA	??	029
171	Ferdinand & Huntingburg	FRDN	273
172	Ferrocarril De Chihuahua Al Pacifico,	CHP	284
173	Ferrocarriles Nacionales De Mexico	NDM	266
174	Ferrocarriles Nacionales De Mexico	SBC	283
175	Ferrocarriles Nacionales De Mexico -	FCP	738
176	Ferrocarriles Unidos Del Sureste, S.A.	SE	281
177	Florida Central Railroad Co	FCEN	986
178	Florida East Coast Railway Company	FEC	263
179	Florida Midland Railroad Co Inc	FMID	507
180	Fonda, Johnstown And Groversville	FJG	264
181	Fordyce And Princeton Railroad Co	FP	265
182	Fore River	CRY	908
183	Fort Smith And Van Buren	FSVB	279
184	Fort Worth & Western Railroad	FWWR	277
185	Galveston Railroad L P	GVSR	567
186	Galveston Wharves	GWF	303
187	Galveston, Houston And Henderson	GHH	293
188	Garden City Western Railway Company, The	GCW	287
189	Genesee And Wyoming Railroad Company	GNWR	320

<b>ID</b>	<b>Company Name</b>	<b>RR Mark</b>	<b>ATCS</b>
190	Georgetown Railroad Company	GRR	302
191	Gettysburg Railway	GBRY	294
192	Gloster Southern Railroad Company	GLSR	916
193	GO TRANSIT	GOT	954
194	Goderich - Exeter Railway Company	??	027
195	Golden Triangle Railroad	GTRA	295
196	Grafton And Upton Railroad Company	GU	323
197	Grainbelt Corporation	GNBC	443
198	Grand River	GRNR	322
199	Grand Trunk Western Railroad Incorporated	GTW	308
200	Graysonia, Nashville And Western	GNA	307
201	Great River Railroad	GTR	271
202	Great Southwestern	GSWR	305
203	Great Western Railway Company, The	GWR	311
204	Green Bay And Western	GBW	312
205	Green Hills Rural Development	GHRD	980
206	Green Mountain Railroad Corporation	GMRC	314
207	Gulf And Mississippi	GMSR	392
208	Hammersley Iron (Australia)		041
209	Hampton & Branchville Railroad Company	HB	330
210	Hartford And Slocomb Railroad Company	HS	366
211	Hartwell Railway Company	HRT	334
212	Helena Southwestern Railroad Company	HSW	331
213	High Point Thomasville & Denton Railroad Company	HPTD	366
214	Hillsboro And North Eastern Railway	HLNE	338
215	Hillsdale County Railway Company, Inc.	HCRC	326
216	Hillside (Australia)		018
217	Hollis & Eastern RR Co	HE	328

<b>ID</b>	<b>Company Name</b>	<b>RR Mark</b>	<b>ATCS</b>
218	Houston Belt & Terminal Railway Company	HBT	342
219	Huntsville & Madison County Railroad Authority	HMCR	391
220	Huron And Eastern Railway Company Inc	HESR	890
221	Hutchinson And Northern Railway Company, The	HN	332
222	Illinois Central Railroad Company	IC	360
223	Indian Creek Railroad Company	ICRK	380
224	Indiana & Ohio Rail Corp.	INOH	344
225	Indiana Hi-Rail Corporation	IHRC	352
226	Indiana Railroad Corporation	INRD	780
227	Indianapolis Union Railway	IU	363
228	Indonesia (Indonesian State Railways)		093
229	International Bridge And Terminal Company, The	IBT	358
230	Interstate Railroad Company	SOU	381
231	Iowa Interstate Railroad Ltd	IAIS	316
232	Iowa Northern Railroad	IANR	341
233	Iowa Southern Railroad Company	ISR	272
234	Iowa Traction Railroad Company	IATR	994
235	ITS - Highway Advanced Transportation Controller		051
236	ITS - Non-ATCS Railroad		052
237	Jefferson Warrior Railroad Co Inc	JEFW	254
238	Kankakee Beaverville And Southern Railroad Company	KBSR	399
239	Kansas And Missouri Railway	KM	414
240	Kansas City Southern Railway Company	KCS	400
241	Kansas City Terminal Railway Company	KCT	401
242	Kentucky And Tennessee Railway	KT	405
243	Keokuk Junction Railway	KJRY	365
244	Kiamichi Railroad Company LLC	KRR	424
245	Knox & Kane Railroad Company	KKRR	376

<b>ID</b>	<b>Company Name</b>	<b>RR Mark</b>	<b>ATCS</b>
246	KWT Railway Inc	KWT	996
247	Kyle Railroad Company	KYLE	377
248	Lake Erie & Northern	LEN	421
249	Lake Erie, Franklin & Clarion Railroad Company	LEF	423
250	Lake Superior & Ishpeming Railroad Company	LSI	425
251	Lake Terminal Railroad Company, The	LT	404
252	Lamoille Valley Railroad Company	LVRC	452
253	Lancaster And Chester Railway Company	LC	426
254	Landisville Railroad Inc (Formerly Amherst Industry)	AMHR	071
255	Laurinburg And Southern Railroad Company	LRS	427
256	Levin-Richmond Terminal Corporation	PRT	606
257	Lewis & Clark Railway Co	LINC	355
258	Little Rock & Western Railway, L P	LRWN	485
259	Little Rock Port Railroad	LRPA	435
260	Livonia, Avon & Lakeville Railroad Corporation	LAL	398
261	Logansport & Eel River Short-Line Co Inc	LER	304
262	Long Island Railroad Company	LIRR	436
263	Longview, Portland & Northern Railway Company	LPN	450
264	Los Angeles Junction Railway Company	LAJ	428
265	Louisiana & Arkansas Railway Company	LA	441
266	Louisiana & Delta Railroad Inc	LDRR	972
267	Louisiana And North West Railroad Company, The	LNW	442
268	Louisville And Wadley Railway Company	LW	451
269	Louisville New Albany & Corydon Railroad	LNAL	446
270	Lowville And Beaver River Railroad Company, The	LBR	447
271	Ludington & Northern Railway	LUN	430
272	Madison Railroad	CMPA	144
273	Magma Arizona Railroad Company	MAA	463

<b>ID</b>	<b>Company Name</b>	<b>RR Mark</b>	<b>ATCS</b>
274	Mahoning Valley Railway Company, The	MVRY	504
275	Maine Central Railroad Company	MEC	456
276	Manufacturers Junction Railway Company	MJ	459
277	Manufacturers Railway Company	MRS	460
278	Marinette, Tomahawk & Western Railroad	MTW	520
279	Maryland And Delaware Railroad Company	MDDE	454
280	Maryland And Pennsylvania Railroad Company	MPA	463
281	Maryland Midland Railway Inc	MMID	495
282	Maryland Rail Commuter	MARC	003
283	Massachusetts Bay Transportation Authority	MBTA	006
284	Massachusetts Central Railroad Corporation	MCER	461
285	Massena Terminal Railroad Company, The	MSTR	471
286	McCloud Railway Company	MCR	466
287	McKeesport Connecting Railroad Company	MKC	583
288	Meridian & Bigbee Railroad Company	MBRR	462
289	Metra		892
290	Mexican Pacific Railroad Company, Inc.	MDP	285
291	Mg Rail Inc	MGRI	388
292	Michigan-Wisconsin Transportation Company	MWTT	512
293	Mid Atlantic Railroad Co., Inc.	MRR	877
294	Middletown & Hummelstown Railroad Company	MIDH	479
295	Middletown & New Jersey Railway Company Inc	MNRR	475
296	Midland Terminal Co, The	MDLR	385
297	MidLouisana Rail Corporation	MDR	919
298	Midsouth Corporation	MSRC	905
299	Milwaukee Road	MILW	140
300	Minnesota Commercial Railway Co	MNNR	973
301	Minnesota Dakota & Western Railway Company	MDW	610

<b>ID</b>	<b>Company Name</b>	<b>RR Mark</b>	<b>ATCS</b>
302	Mississippi & Skuna Valley Railroad Company	MSV	503
303	Mississippi Delta Railroad	MSDR	786
304	Mississippi Export Railroad Company	MSE	506
305	Mississippian Railway Cooperative Inc	MSRW	502
306	Missouri Pacific Railroad Company	MP	494
307	Missouri-Kansas-Texas Railroad Co.	MKT	490
308	Mobile & Gulf Railroad Company	MG	483
309	Modesto And Empire Traction Company	MET	524
310	Monongahela Connecting Rr Co.	MCRR	498
311	Monongahela Railway Company	MGA	497
312	Montana Rail Link Inc	MRL	671
313	Morristown & Erie Railway Inc	ME	511
314	Moscow, Camden & San Augustine Railroad	MCSA	548
315	MRS Logistics of South America	??	028
316	Muncie And Western Railroad Company	MWR	464
317	N D C Railroad Company	NDCR	902
318	N J Transit Rail Operations (Commuter Carrier)	NJTR	574
319	Napa Valley Railroad Co	NVRR	402
320	Nash County Railroad Corp	NCYR	776
321	Nashville And Eastern Railroad Corp	NERR	934
322	National Railroad Passenger Corporation	AMTRAK	891
323	National Railways Of Mexico (Ferrocarriles Naciona)	NDM	286
324	New Hampshire North coast Corp	NHN	787
325	New Hope & Ivyland Railroad	NHRR	585
326	New York & Lake Erie Railroad	NYLE	545
327	New York Cross Harbor Railroad Terminal Corp	NYCH	573
328	New York Susquehanna And Western Railway Corp	NYSW	546
329	Nicolet Badger Northern Railroad Inc	NBNR	476



<b>ID</b>	<b>Company Name</b>	<b>RR Mark</b>	<b>ATCS</b>
330	Nittany & Bald Eagle Railroad Co	NBER	249
331	Norfolk & Portsmouth Belt Line Railroad Company	NPB	549
332	Norfolk And Western Railway Company	NW	550
333	Norfolk Southern	NS	555
334	North Carolina & Virginia Railroad Co Inc	NCVA	531
335	North Shore Railroad Co	NSHR	248
336	North Stratford Railroad Corporation	NSCR	570
337	Northwestern Oklahoma Railroad Company	NOKL	591
338	Northwestern Pacific Railroad Company	NWP	559
339	Oakland Terminal Railroad Company	OTR	586
340	Octoraro Railway, Inc.	OCTR	587
341	Ogden Union Railway And Depot Company, The	OURD	956
342	Ohio-Rail Corporation	OHIC	579
343	Oil Creek & Titusville Lines	OCTL	948
344	Okanagan Valley Railway Company	OKAN	945
345	Oklahoma Central Railroad Co	OCR	270
346	Oklahoma, Kansas And Texas Railroad	OKKT	593
347	Old Augusta Railroad Company	OAR	578
348	Omaha Lincoln And Beatrice Railway Company	OLB	598
349	Ontario Central Railroad Corporation	ONCT	589
350	Ontario Midland Railroad Corporation	OMID	588
351	Ontario Northland Railway (Ontario Northland Trans	ONT	754
352	Oregon & Northwestern Railroad Co.	ONW	596
353	Oregon Pacific & Eastern Railway Company	OPE	597
354	Oregon, California & Eastern Railway	OCE	603
355	Ottertail Valley Railroad Co Inc	OTVR	983
356	Ottumwa Terminal Railroad Co	OTT	276
357	Paducah & Illinois Railroad Company	PI	614

<b>ID</b>	<b>Company Name</b>	<b>RR Mark</b>	<b>ATCS</b>
358	Paducah & Louisville Railroad	PAL	907
359	Panther Valley Railroad Corporation	PVAL	575
360	Patapsco & Back Rivers Railroad Company	PBR	609
361	Pearl River Valley Railroad Company	PRV	636
362	Pecos Valley Southern Railway Company, The	PVS	644
363	Pee Dee River Railroad Corp	PDRR	010
364	Peninsula Terminal Company	PT	643
365	Peoria And Pekin Union Railway Company	PPU	645
366	Philadelphia Belt Line Railroad Company, The	PBL	608
367	Philadelphia Bethlehem And New England Railroad Co	PBNE	659
368	Pickens Railway Company	PICK	624
369	Pioneer And Fayette Railroad Company	PF	630
370	Pioneer Valley Railroad Company	PVRR	611
371	Pittsburg & Shawmut Railroad Inc	PSR	627
372	Pittsburgh Chartiers & Youghiogheny Railway Company	PCY	629
373	Pittsburgh, Allegheny & McKees Rocks Rr Co	PAM	607
374	Plymouth Short Line Ltd	PSLL	566
375	Pocono Northeast Railway, Inc.	PNER	618
376	Point Comfort & Northern Railway Company	PCN	651
377	Port Bienville Railroad	PBVR	677
378	Port Of Tillamook Bay Railroad	POTB	637
379	Port Royal Railroad	PRYL	393
380	Portland Terminal Company	PTM	619
381	Portland Traction Company	PRTD	632
382	Prescott And Northwestern Railroad Company	PNW	634
383	Providence And Worcester Railroad Company	PW	631
384	Quebec Central Railway Company	QC	658
385	Queensland Rail (Australia)		036

<b>ID</b>	<b>Company Name</b>	<b>RR Mark</b>	<b>ATCS</b>
386	Quincy Railroad Company	QRR	656
387	RAC (Railway Association Of Canada)		033
388	Rarus Railway Company	RARW	516
389	Red River Valley & Western Railroad Co	RRVW	321
390	Renfe (National Railways Of Spain)		119
391	River Terminal Railway Company, The	RT	665
392	Robe (Australia)		044
393	Roberval And Saguenay Railway Company, The	RS	669
394	Rochester & Southern Railroad Inc	RSR	941
395	Rockdale Sandow & Southern Railroad Company	RSS	675
396	Rocky Mountain Railcar And Railroad Inc	RMRR	915
397	Roscoe Snyder & Pacific Railway Company	RSP	673
398	Sabine River & Northern Railroad Company	SRN	678
399	Saint Lawrence Railroad	SLAW	705
400	Saint Mary's Railroad Company	SM	682
401	Salt Lake Garfield And Western Railway Company	SLGW	690
402	San Diego & Imperial Valley Railroad Co Inc	SDIY	315
403	San Luis Central Railroad Company	SLC	696
404	San Manuel Arizona Railroad Company	SMA	794
405	Sand Springs Railway Company	SS	707
406	Sandersville Railroad Company	SAN	691
407	Santa Maria Valley Railroad Company	SMV	741
408	Savannah State Docks Railroad Company	SSDK	679
409	Sequatchie Valley Railroad Inc	SQVR	910
410	Shore Fast Line Railroad Company	SFLR	255
411	Sierra Railroad Company	SERA	716
412	Singapore (Singapore)		076
413	Sisseton Southern Railway Co	SSOR	440

<b>ID</b>	<b>Company Name</b>	<b>RR Mark</b>	<b>ATCS</b>
414	Somerset Railroad Corporation	SOM	772
415	SOO Line Rail Company	SOO	030
416	South Branch Valley Railroad	SBVR	732
417	South Brooklyn Railway Company	SBK	718
418	South Buffalo Railway Company	SB	719
419	South Carolina Central Railroad Co Inc	SCRF	582
420	South Central Tennessee Railroad Corporation	SCTR	672
421	Southeast Kansas Railroad Company	SEKR	944
422	Southeastern Penn Transportation Authority	SEPTA	024
423	Southern Indiana Railway Inc	SIND	720
424	Southern New Jersey Light Rail Transit	??	026
425	Southern Pacific Transportation Company	SP	721
426	Southern Railway Company	SOU	724
427	Southern San Luis Valley Railroad Company	SSLV	706
428	St Maries River Railroad Company	STMA	698
429	STA		048
430	Staten Island Railway Corporation	SIRY	389
431	Steelton & Highspire Railroad Company	SH	799
432	Stewartstown Railroad Co	STRT	729
433	Stockton Terminal And Eastern Railroad	STE	739
434	Strasburg Railroad Company	SRC	686
435	Strouds Creek And Muddlety Railroad	SCM	687
436	Sunset Railway Company	SUN	734
437	Tacoma Municipal Belt Line Railway	TMBL	759
438	TasRail		119
439	Tennessee Railway Company	SCM	767
440	Tennessee, Alabama And Georgia Railway	SOU	755
441	Tennken Railroad Company Inc	TKEN	745

<b>ID</b>	<b>Company Name</b>	<b>RR Mark</b>	<b>ATCS</b>
442	Terminal Railroad Association Of St Louis	TRRA	757
443	Terminal Railway Alabama State Docks	TASD	758
444	Texas & Northern	TN	795
445	Texas Central Railroad Company	TEXC	750
446	Texas City Terminal Railway Company	TCT	761
447	Texas Mexican Railway Company, The	TM	762
448	Texas North Western Railway Company	TXNW	747
449	Texas South-Eastern Railroad Company	TSE	765
450	Texas, Oklahoma & Eastern Railroad Company	TOE	764
451	Thailand (Thai State Railways)		102
452	Tippecanoe Railroad Company	TIPP	753
453	Tonawanda Island Railroad Inc	TIRL	743
454	Towanda And Monroeton Shippers Lifeline, Inc.	TMSS	752
455	Transkentucky Transportation Railroad Co Inc	TTIS	773
456	Tranz Rail (Tasmania)		057
457	Trinity Railway Express		751
458	Trona Railway Company	TRC	779
459	TTCI Test Unit 1	TTCI	884
460	TTCI Test Unit 2	TTCI	885
461	TTCI Test Unit 3	TTCI	886
462	TTCI Test Unit 4	TTCI	887
463	TTCI Test Unit 5	TTCI	888
464	TTCI Test Unit 6	TTCI	889
465	Tucson, Cornelia & Gila Bend Railroad Company	TCG	783
466	Tulsa-Sapulpa Union Railway Company LLC	TSU	709
467	Turtle Creek Industrial Railroad Inc	TCKR	744
468	Tuscola And Saginaw Bay Railway Company Inc	TSBY	770
469	Union Pacific Railroad Company	UP	802

<b>ID</b>	<b>Company Name</b>	<b>RR Mark</b>	<b>ATCS</b>
470	Union Railroad Company	URR	803
471	Union Railroad Of Oregon	UO	800
472	United South Eastern Railways Company	SE	281
473	Unity Railways Company	UNI	806
474	Upper Merion And Plymouth Railroad Company	UMP	808
475	Utah Railway Company	UTAH	811
476	Valdosta Southern Railroad	VSO	816
477	Vandalia Railroad Company	VRRC	781
478	Ventura County Railway Company	VCY	821
479	Vermont Railway Inc	VTR	817
480	Via Rail Canada Inc	VIA	818
481	VicTrack (Australia)		017
482	Virginia Railway Express	VRE	023
483	Visalia Electric Railroad Company	VE	824
484	Walking Horse & Eastern Railroad Co Inc	WHOE	390
485	Warren & Saline River Railroad Company	WSR	832
486	Washington Central Railroad Company, Inc.	WCRC	943
487	Washington County Railroad Corporation	WACR	812
488	Washington Terminal	WATC	849
489	Waterloo Railway Company	WLO	835
490	WCTU Railway Company	WCTR	844
491	Weatherford Mineral Wells & Northwestern	WMWN	837
492	West Jersey Short Line, Inc.	WJSL	387
493	West Shore Railroad Corp	WTSE	882
494	West Tennessee Railroad Corp	WTNN	258
495	West Virginia Northern Railroad	WVN	866
496	Western Railroad Company	WRRC	838
497	Westrail (Australia)		038

<b>ID</b>	<b>Company Name</b>	<b>RR Mark</b>	<b>ATCS</b>
498	White Pass & Yukon	WPY	845
499	Willamette Valley Railway Company, Inc	WVR	863
500	Wilmington Terminal Railroad Inc	WTRY	981
501	Winchester And Western Railroad Company	WW	850
502	Winifrede Railroad Company	WNFR	852
503	Winston-Salem Southbound Railway Company (CSX Tran)	WSS	854
504	Wisconsin & Calumet Railroad	WICT	382
505	Wisconsin & Southern Railroad Company	WSOR	879
506	Wisconsin Central Limited	WC	260
507	Yancey Railroad Company	YAN	876
508	Youngstown & Austintown Railroad Co	YARR	372
509	Youngstown & Southern Railway Company	YS	875
510	Yreka Western Railroad Company	YW	873
511	UK ATCS Testing and Field Evaluations	????	974
512	Network Rail - London North Eastern - UK	????	975
513	Network Rail - London North Western - UK	????	976
514	Network Rail - Scotland - UK	????	977
515	Network Rail - South East - UK	????	978
516	Network Rail - Western - UK	????	979

This Page Intentionally Left Blank



## APPENDIX C – GENERIC GROUNDING PROCEDURES

### c GENERIC GROUNDING PROCEDURES

#### C.1 GENERAL

With all R-Link radio applications care should be taken to prevent ground differentials between the grounding points that can cause equipment damage. Perform the following recommendations when grounding equipment and enclosures.

#### C.2 EXTERNAL BUILDING GROUND

Grounding electrodes should be a minimum of 8 feet in length and located approximately 2 feet away from each corner of the building with the top of each element at least 6 inches below grade. Spacing between electrodes should not exceed 15 feet. The ground elements should be bonded together with a ring of #2 AWG solid copper wire. All below grade connections shall be Cadwelded. Refer to the following figure.

The following items should be connected to the ground ring using a #2 AWG solid copper conductor:

- All hydro ground elements within 6 feet of the ground ring
- All metal objects within 50 feet of the building (e.g., fuel storage tanks)
- Air gap surge protectors on the common ground side of the arrestors (as direct as possible through the floor)
- A conductor from each ground electrode to the closest corner of the building, passed up through the floor and up the inside wall to connect with an internal ground ring located 6 inches from the inside ceiling.

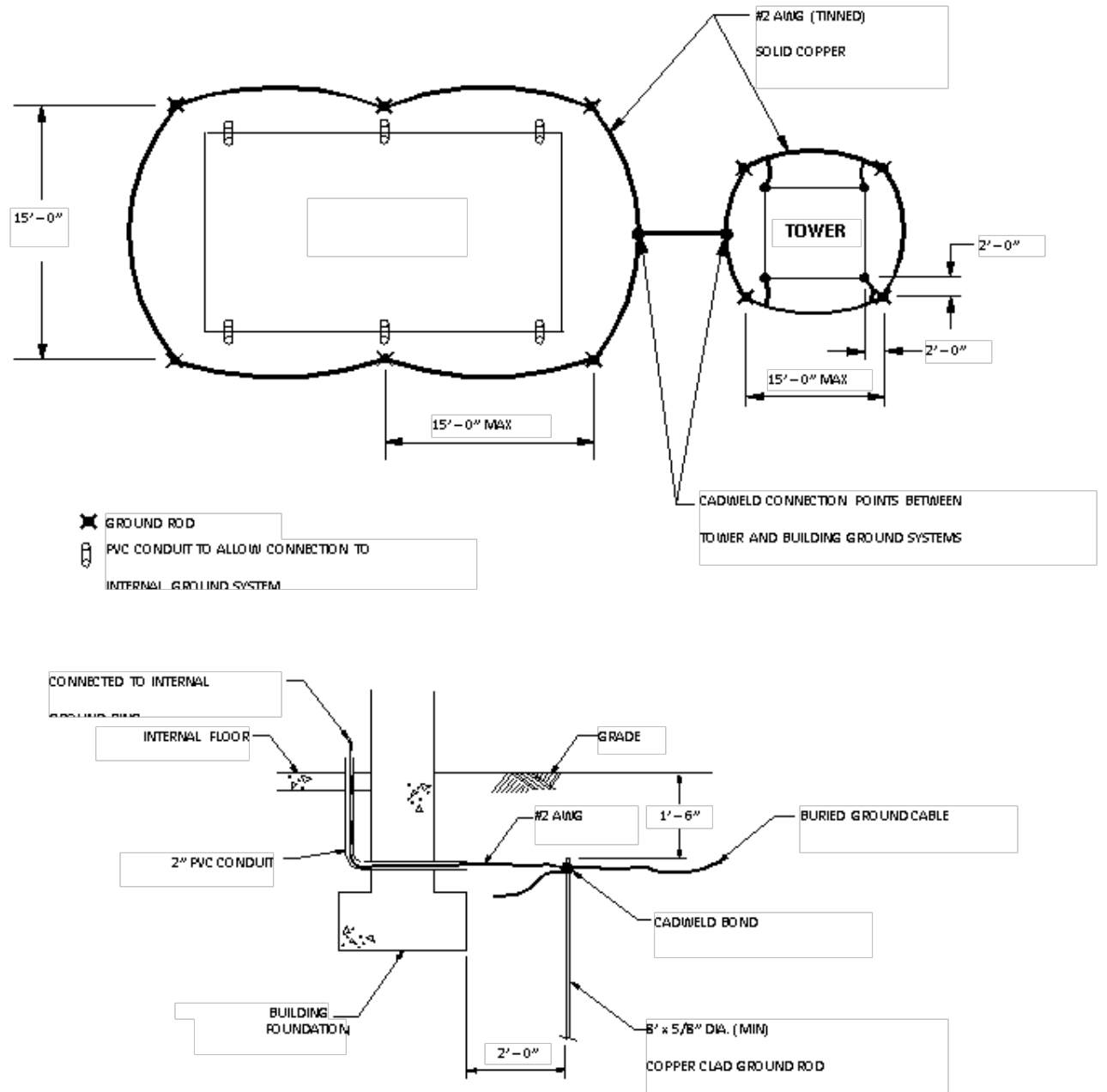

Figure C-1 Typical Ground Connections

### C.3 INTERNAL BUILDING GROUND

The internal ground ring should be #2 AWG copper, and may be stranded. The following items should be connected to the internal ground ring using a minimum #6 AWG stranded copper conductor:

- All relay racks
- AC panels
- Battery system surge protectors
- Building doors
- Cable trays

**NOTE**

**NOTE**

Bonding conductor connections to the ground ring should be made using split brass bolts (see Figure C-4).

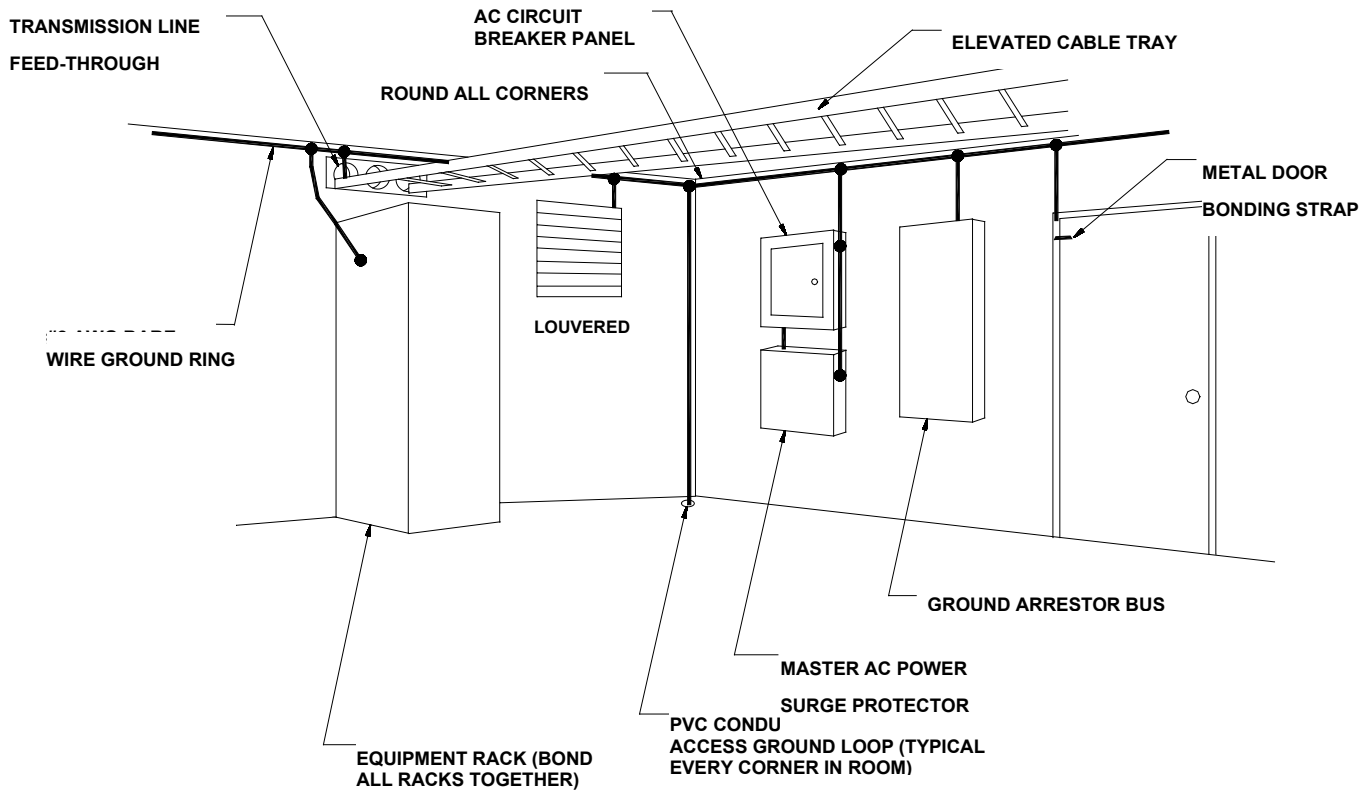

Figure C-2 Typical Internal Building Ground

## **C.4 ANTENNA GROUND**

A good RF ground will determine the quality of a radio antenna system. Poor grounds result in antennas not operating efficiently. It is possible to burn up between 50 and 90 percent of the RF power heating the ground losses under the antenna instead of propagating into the air. Ground resistances can vary from very low values of 5 ohms to more than 100 ohms. RF power is dissipated in the ground resistance. The following factors that affect ground resistance are:

- The conductivity of the soil
- The composition of the soil
- The water content of the soil

Note that the ideal ground depth depends on the level of the local water table; it is rarely at ground level and can be several feet below grade.

### **C.4.1 ANTENNA GROUND – ROOF-MOUNT YAGI**

Roof-mounted Yagi antennae should have the pipe mast grounded to the outside grounding ring with a minimum #2 AWG solid copper conductor. The Heliacx ground kit should be connected within 1 foot of the cable entry to the building and connected to the copper conductor. A lightning surge protector is not required if the Yagi antenna is less than 10 feet above the building roof. The inside terminating connector on the antenna Heliacx should be bonded to the internal ground ring.

### **C.4.2 ANTENNA GROUND – TOWERS AND POLES**

As with all elevated metal objects, antennas will attract lightning strikes. This necessitates the need for an adequate and effective ground to minimize electrical noise and interference (Figure C-3) On tower and pole equipped sites, the antenna must be well grounded by means of a #2 AWG solid copper conductor connection from the ground ring to the tower or pole grounding element(s). The tower ground system must have 5 ohms or less earth resistance. The antenna cable should be grounded to the tower/pole-grounding conductor where the cable bends and leaves the tower/pole towards the building.

The messenger wire for the cable should be bonded to the tower/pole ground and the external building ground ring. The antenna cable should be grounded outside the building, within 1 foot of the building entry, to the external building ground ring via a #2 AWG solid conductor. A lightning arrester should be installed on the Heliacx cable within 1 foot of the building entrance, and bonded to the internal ground ring.

Surge arrestors or a lightning protector should be installed at the point where the antenna cable enters the building or cabinet. The lightning protector should be properly grounded at the single-point chassis ground. Connectors must be weatherproofed to prevent corrosion to enable efficient grounding.

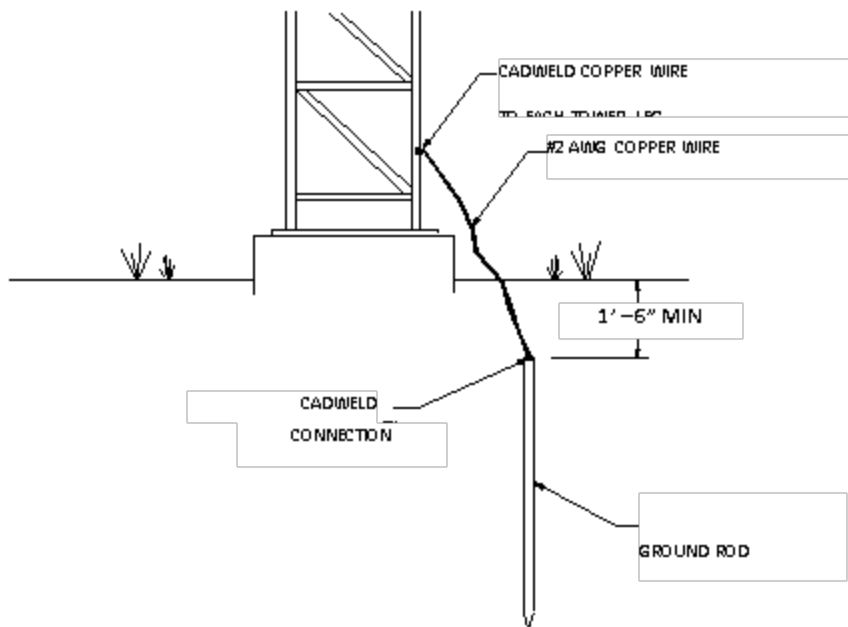
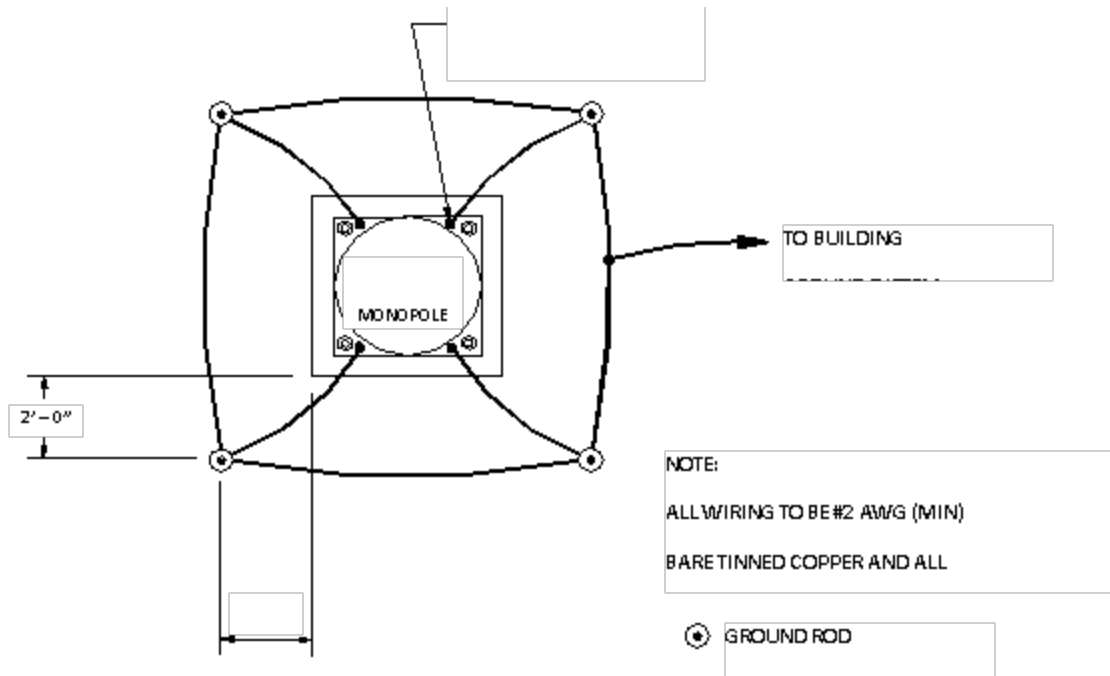
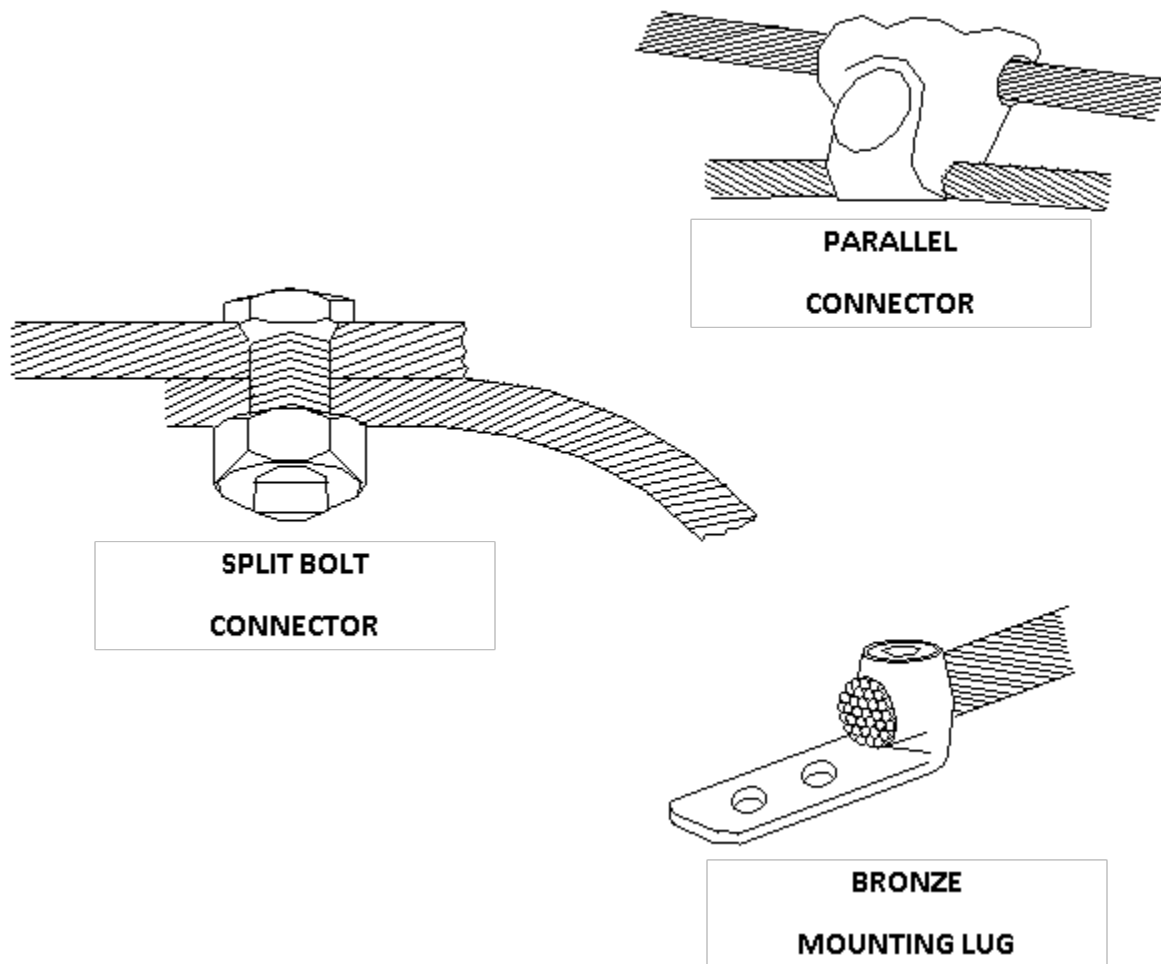

Figure C-3 Typical Tower and Pole Ground Connections



**Figure C-4 Typical Connections for Grounding and Bonding**

### **C.5 AC POWER GROUND**

AC power grounding should be to the standards set forth by the applicable local or regional electrical code. When bonding AC panels to the internal ground ring, the connection should be made to the outside surface of the panel. Hydro ground electrodes should be bonded to the building ground electrodes only if they are within 6 feet of each other. A surge protector should be installed on the main electrical panel for any ungrounded electrical feed in or out of the building, and the connection to all air gap suppressors removed.

## **C.6 COMMUNICATIONS GROUND**

All power and telephone company grounds should be made common to the communications ground. A surge arrester such as a Polyphaser™ should be installed at the point where the cable enters the building.

## **C.7 CABLING**

Cabling shall be installed to minimize inductive coupling that would otherwise allow surge energy to bypass the protective and isolating elements in the system. The input/output conductors entering the building shall follow a path as short as possible to the air gap surge protectors. These conductors shall not be within 3 inches of other conductors including the signal wires from the surge protectors to the relay racks. The signal wires from the surge protectors to the relay rack shall be dressed together and separated from power and other signal wires by 3 inches. The signal wires between the relay isolation and the Siemens equipment shall be dressed together and separated from power or other signal wires by 3 inches. Where physical separation is not possible, the wires should be run at right angles to each other.

## **C.8 SURGE PROTECTION**

Surge protection should be provided on battery/charger systems to prevent the system from rising to dangerous voltages with reference to building ground. The protectors should be installed in series with a circuit breaker so if they fail in the short mode the circuit breaker will open and the system will remain isolated from ground.

This Page Intentionally Left Blank



## APPENDIX D – RF CABLE AND CONNECTOR REFERENCE DATA

### D RF CABLE AND CONNECTOR REFERENCE DATA

#### D.1 JUMPER APPLICATIONS

In confined spaces (for example on combiners or equipment racks) use ¼” super-flexible cables. In applications where a small bending radius is not usually required (for example jumpers between main feeders and antennas) the larger 3/8” and ½” cables are preferred. Their lower attenuation compared to super-flexible cables makes them ideal for longer jumper cables.

#### D.2 CONNECTORS

Coaxial cable N-connectors provide excellent electrical matching of the connector to the cable and ensure low VSWR (typically 1/10 dB). Excellent mechanical matching will ensure weatherproofing. They have the following features:

- Silver-plated connectors to reduce Intermodulation
- DIN connectors for higher power applications

#### D.3 ACCESSORIES (RECOMMENDED)

The following accessories used in conjunction with coaxial cables will help to ensure a long lasting and cost-effective system:

- Cold-shrink for weatherproofing
- Snap-in hangers for easier installation
- Surge arrestors for equipment protection

**Table D-1 Transmission Line System Components**

<b>Foam Coaxial Cable</b>					
	3/8”	½”	7/8”	1-1/4”	1-5/8”
<b>Attenuation dB / 100ft (dB / 100m)</b>					
875 MHz	3.27 (10.8)	2.17 (7.13)	1.21 (3.98)	0.896 (2.94)	0.757 (2.49)
960 MHz	3.47 (11.4)	2.29 (7.52)	1.28 (4.20)	0.945 (3.10)	0.80 (2.62)
<b>Average Power Rating, KW</b>					
875 MHz	0.712	1.07	2.29	3.45	4.57
960 MHz	0.678	1.01	2.16	3.27	4.32
<b>Suggested Cable Length, ft (m)</b>					
806 – 960 MHz	40 (12)	65 (20)	115 (35)	155 (47)	185 (56)

**Table D-2 Coaxial Cable Selection Guide 50-ohm, Foam Dielectric**

<b>Attenuation dB / 100ft (dB / 100m)</b> <b>Standard Conditions: VSWR 1.0; Ambient Temp 75°F (24°C)</b>					
3/8"	1/2"	7/8"	1-1/4"	1-5/8"	High Power Plenum Foam
3.55 (11.6)	2.34 (7.68)	1.31 (4.30)	0.96 (3.17)	0.82 (2.69)	Not recommended
<b>Average Power Rating, KW</b> <b>Standard Conditions: VSWR 1.0; Ambient Temp 104°F (40°C)</b> <b>Inner Conductor 212°F (100°C)</b>					
3/8"	1/2"	7/8"	1-1/4"	1-5/8"	High Power Plenum Foam
0.663	0.994	2.11	3.20	4.22	1.90

**Table D-3 3/8" 50-ohm Foam Dielectric Coaxial Cable Attenuation and Average Power**  
(Not recommended for SSR or R-Link applications)

<b>Frequency (MHz)</b>	<b>Attenuation dB/100ft (dB /100m)</b>	<b>Average Power (kW)</b>
894	3.34 (11.0)	0.704
960	3.47 (11.4)	0.678

**Table D-4 1/2" 50-ohm Foam Dielectric Coaxial Cable Attenuation and Average Power**  
(Suitable for SSR or R-Link applications)

<b>Frequency (MHz)</b>	<b>Attenuation dB/100ft (dB /100m)</b>	<b>Average Power (kW)</b>
894	2.20 (7.22)	1.05
960	2.29 (7.51)	1.01

**Table D-5 1/2" N-Connector Loss VSWR, Low VSWR Specifications, Type N**

Frequency Band (GHz)	Connector Type	Assembly VSWR, Maximum (R.L., dB)				
		1-25 ft (0.3-8m)	25-100 ft (8-30m)	100-200 ft (30-60m)	200-500 ft (60-150m)	> 500 ft (150m)
0.824 – 0.960	N Male	1.08 (28.3)	1.08 (28.3)	1.10 (26.4)	1.12 (24.9)	1.12 (24.9)
	N Female	1.08 (28.3)	1.08 (28.3)	1.10 (26.4)	1.12 (24.9)	1.12 (24.9)

**Table D-6 7/8" 50-ohm Foam Dielectric Coaxial Cable  
(Recommended for Long Range SSR and MCP RF Data Links)**

Frequency (MHz)	Attenuation dB/100ft (dB /100m)	Average Power (kW)
894	1.23 (4.03)	2.25
960	1.28 (4.20)	2.16

**Table D-7 7/8" N-Connector Loss VSWR, Low VSWR Specifications, Type N**

Frequency Band (GHz)	Connector Type	Assembly VSWR, Maximum (R.L., dB)				
		1-25 ft (0.3-8m)	25-100 ft (8-30m)	100-200 ft (30-60m)	200-500 ft (60-150m)	> 500 ft (150m)
0.824 – 0.960	Male and Female	1.06 (28.3)	1.07	1.10 (26.4)	1.10 (26.4)	1.10 (26.4)

**Table D-8 1/2" Coaxial Cable Loss dB Comparison Reference**

Manufacturer (Part No.)	894 MHz	960 MHz
Cableware (FLC12-50J)	2.20 dB	2.29 dB
Celldyne by Eupen (5128)	2.12 dB	2.20 dB
Amphenol (AFC4-50J)	2.20 dB	2.29 dB
Andrew (LDF4-50A)	2.20 dB	2.29 dB
Hi Tech Soft Flex	2.489 dB	2.589 dB

**Table D-9 Base Radio Main Feeder Cable Coaxial Cable Selection Guide - 50 ohm "Air" Dielectric**

<b>Attenuation dB / 100ft (dB / 100m)</b> <b>Standard Conditions: VSWR 1.0; Ambient Temp 75°F (24°C)</b>					
	1-5/8"	2-1/4"	3"	4"	5"
1000 MHz	0.70 (2.30)	0.59 (1.93)	0.56 (1.84)	0.43 (1.41)	---
<b>Average Power Rating, kW</b> <b>Standard conditions: VSWR 1.0; Ambient Temp 104°F (40°C)</b> <b>Inner Conductor 212°F (100°C)</b>					
	1-5/8"	2-1/4"	3"	4"	5"
1000 MHz	4.94	6.61	10.7	17.2	---

**Table D-10 1-1/4" 50-ohm Foam Dielectric Coaxial Cable****Base Radio Main Feeder**

<b>Frequency (MHz)</b>	<b>Attenuation (dB/100ft)</b>	<b>Average Power (kW)</b>
894	0.907	3.41
960	3.10	3.27

**Table D-11 1-1/4" Connector LOSS Low VSWR Specifications****Base Radio Main Feeder**

<b>Frequency Band (GHz)</b>	<b>Connector Type</b>	<b>Assembly VSWR, Maximum (R.L., dB)</b>				
		<b>1-25 ft (0.3-8m)</b>	<b>25-100 ft (8-30m)</b>	<b>100-200 ft (30-60m)</b>	<b>200-500 ft (60-150m)</b>	<b>&gt; 500 ft (150m)</b>
0.824 – 0.894	N Male	1.08 (28.3)	1.09 (27.3)	1.12 (24.9)	1.15 (23.1)	1.20 (20.8)
	7/16 DIN	1.08 (28.3)	1.09 (27.3)	1.10 (26.4)	1.15 (23.1)	1.20 (20.8)

**Table D-12 1-5/8" 50-ohm Foam Dielectric Coaxial Cable****Base Radio Main Feeder**

Frequency (MHz)	Attenuation (dB/100ft)	Average Power (kW)
894	0.767	4.51
960	0.800	4.32

**Table D-13 1-5/8" Connector LOSS Low VSWR Specifications****Base Radio Main Feeder**

Frequency Band (GHz)	Connector Type	Assembly VSWR, Maximum (R.L., dB)				
		1-25 ft (0.3-8m)	25-100 ft (8-30m)	100-200 ft (30-60m)	200-500 ft (60-150m)	> 500 ft (150m)
0.824 – 0.894	7/16 DIN Male	1.06 (30.7)	1.08 (28.3)	1.10 (26.4)	1.15 (23.1)	1.20 (20.8)
	7/16 DIN Female	1.10 (26.4)	1.13 (24.3)	1.18 (21.6)	1.20 (20.8)	1.22 (20.1)

**Table D-14 1-5/8" 50-ohm Air Dielectric Coaxial Cable****Base Radio Main Feeder**

Frequency (MHz)	Attenuation (dB/100ft)	Average Power (kW)
894	0.658	5.24
960	0.684	5.05

**Table D-15 1/2" N-Connector**

Frequency Band GHz	Connector Type	Assembly VSWR, Maximum (R.L., dB)			
		0-10 ft (0-3m)	10-20 ft (3-6m)	20-100 ft (6-30m)	> 100 ft (> 30m)
0.01 – 2.3	N-Males	1.10 (26.4)	1.10 (26.4)	1.15 (23.1)	1.15 (23.1)
	N-Females	1.15 (23.1)	1.15 (23.1)	1.15 (23.1)	1.20 (20.8)

This Page Intentionally Left Blank

## APPENDIX E - RF PROPAGATION BRIEF

### E.1 WAVELENGTH VS FREQUENCY

The frequency of an electromagnetic wave is the number of cycles that occur in one second. If either the frequency or length of a wave is known, the unknown value can be calculated as follows:

Where  $C = 3 \times 10^8$  meters per second (mps)

$$\text{Frequency (Hz)} = C / \text{Wavelength } (\lambda)$$

$$\text{Wavelength } (\lambda) = C / \text{Frequency (Hz)}$$

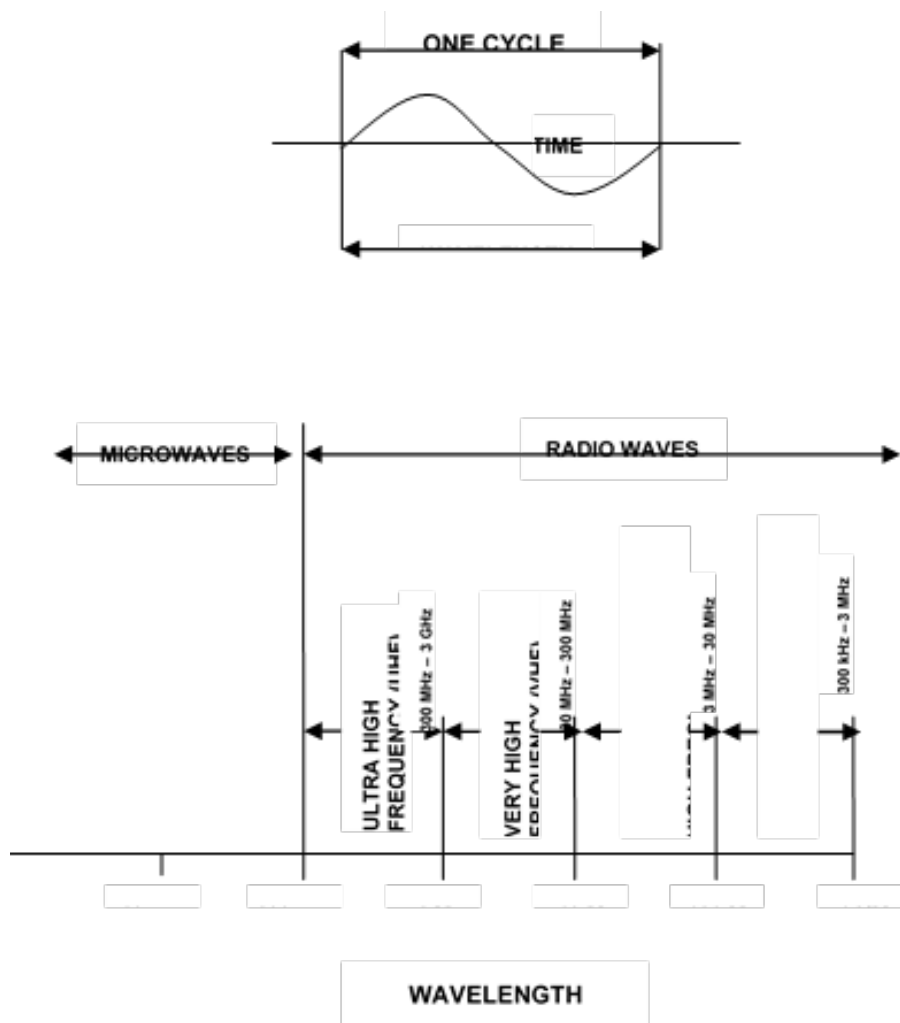

Figure E-1 Wavelength vs Frequency

### E.1.1 QUARTER AND HALF WAVELENGTH LINES

Sections of transmission lines that are exactly a quarter-wavelength or a half-wavelength in length have important impedance-transforming properties and are often used at radio frequencies.

Impedance inversion by quarter-wavelength lines. Refer to Figure F-2. The load of impedance  $Z_L$  connected to a piece of transmission line of length  $s$  is exactly a quarter-wavelength (or an odd number of quarter-wavelengths) and line is lossless. Therefore, the formula for impedance  $Z_g$ , seen when looking toward the load, is as follows:

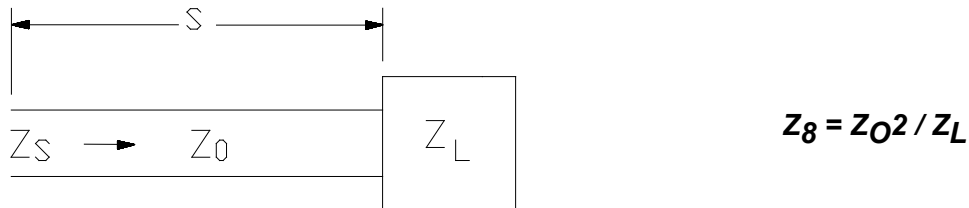

Figure E-2 Loaded Line

### E.2 CURRENT AND VOLTAGE DISTRIBUTIONS

The length of an antenna, like a transmission line, is a sizable portion of a wavelength – even several wavelengths. It is a circuit with distributed constants. A voltage is applied at one point, resulting in a voltage and current at that point. Traveling waves are then initiated, and possibly standing waves are set up, resulting in voltage and current on the antenna that will generally vary from one point to the next. This antenna voltage and current distribution will have an effect on the radiated field. The field depends chiefly on the antenna length measured in wavelengths, its power losses, and the terminations at its ends, if any. In addition, the thickness of the antenna wire is of importance, but for practical purposes antennas may be assumed to be lossless, and of wire whose diameter is infinitely small when compared to a wavelength.

There is a similarity to the distribution of voltage and current on a piece of quarter-wave transmission line that is open-circuited at the far end. Just as a voltage minimum and current maximum appear at the antenna feed point, so an identical situation exists  $\lambda/4$  away from the open circuit on a transmission line.

Refer to Figure F-3 below. The current distributions on antennas with lengths that are multiples of  $\lambda/2$  are logical extensions of those of the half-wave antenna, and similarly comparable to equivalent transmission lines. The voltage distributions are omitted for simplicity.



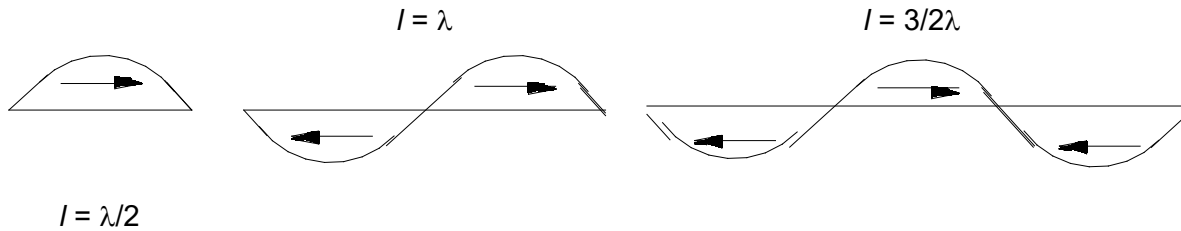

**Figure E-3 Current Distribution on Resonant Dipoles**

### E.3 EFFECTIVE RADIATED POWER (ERP)

There is an importance difference between output power and Effective Radiated Power (ERP): output power is regulated by the FCC for bands below 470 MHz, and ERP is not regulated. This lack of regulation can potentially impact a system's transmission capabilities and may be the reason for interference problems.

ERP is the transmitter output power multiplied by the net gain of the antenna system.

$$\text{ERP} = \text{transmitter output power} \times \text{net gain of antenna system}$$

The net gain of the antenna system is equal to the transmission losses (caused by transmission lines, duplexers, cavity filters, and isolators) subtracted from the gain of the antenna.

To calculate the ERP, convert all components to decibels (dB) and then add the losses (-) and gains (+) of the antenna system to get the result. Perform the following steps:

1. Convert the output power ( $P_o$ ) from watts to dB above a watt (dBW)

$$\text{dBW} = 10 \text{ LOG } P_o$$

2. Add the net gain of the antenna system to get the ERP in dBW

3. Convert the ERP in dBW back to watts

$$\text{Watts} = 10^{\text{dBW}/10}$$

Example:

$$P_o = 250 \text{ watts} \quad = \quad +24.0 \text{ dBW}$$

$$\text{Antenna system losses} \quad = \quad -2.5 \text{ dB}$$

$$\text{Antenna gain} \quad = \quad +6.5 \text{ dB}$$

$$\text{ERP} \quad = \quad +28.0 \text{ dBW} = 631 \text{ watts}$$

ERP is used in determining a coverage area because it includes power from the antenna, rather than simply the output power from the transmitter.

#### **E.4 RESONANT ANTENNAS**

A resonant antenna corresponds to a resonant transmission line. All antennas described after the elementary doublet have been resonant. An antenna is an opened-out transmission line, open-circuited at the far end and of resonant length. The source is low-impedance, and must be placed at a low-impedance point to avoid upsetting the standing-wave pattern. The nearest suitable point for this, from an open circuit, is a quarter-wavelength away.

## APPENDIX F – VOLTAGE DROP TABLES

### F VOLTAGE DROP TABLES

Table F-1 Conductor Size for 10% Voltage Drop - 12 Volts

<b>12 Volts – 10% Drop Wire Sizes (gauge) – Based on Minimum CM Area</b>																			
Total Current on Circuit (Amps)	Length of Conductor from Source of Current to Device and Back to Source - Feet																		
	10	15	20	25	30	40	50	60	70	80	90	100	110	120	130	140	150	160	170
5	18	18	18	18	18	16	16	14	14	14	12	12	12	12	12	10	10	10	10
10	18	18	16	16	14	14	12	12	10	10	10	10	8	8	8	8	8	8	6
15	18	16	14	14	12	12	10	10	8	8	8	8	8	6	6	6	6	6	6
20	16	14	14	12	12	10	10	8	8	8	6	6	6	6	6	4	4	4	4
25	16	14	12	12	10	10	8	8	6	6	6	6	6	4	4	4	4	4	2
30	14	12	12	10	10	8	8	6	6	6	6	4	4	4	4	2	2	2	2
40	14	12	10	10	8	8	6	6	6	4	4	4	2	2	2	2	2	2	2
50	12	10	10	8	8	6	6	4	4	4	2	2	2	2	2	1	1	1	1
60	12	10	8	8	6	6	4	4	2	2	2	2	2	1	1	1	0	0	0
70	10	8	8	6	6	6	4	2	2	2	2	1	1	1	0	0	0	2/0	2/0
80	10	8	8	6	6	4	4	2	2	2	1	1	0	0	0	2/0	2/0	2/0	2/0
90	10	8	6	6	6	4	2	2	2	1	1	0	0	0	2/0	2/0	2/0	3/0	3/0
100	10	8	6	6	4	4	2	2	1	1	0	0	0	2/0	2/0	2/0	2/0	3/0	3/0

**Table F-2 Conductor Sizes for 10% Voltage Drop - 24 Volts**

<b>24 Volts – 10% Drop Wire Sizes (gauge) – Based on Minimum CM Area</b>																				
<b>Total Current on Circuit (Amps)</b>	<b>Length of Conductor from Source of Current to Device and Back to Source - Feet</b>																			
	10	15	20	25	30	40	50	60	70	80	90	100	110	120	130	140	150	160	170	
5	18	18	18	18	18	18	18	18	18	16	16	16	16	14	14	14	14	14	14	12
10	18	18	18	18	18	16	16	14	14	14	12	12	12	12	12	10	10	10	10	10
15	18	18	18	16	16	14	14	12	12	12	10	10	10	10	10	8	8	8	8	8
20	18	18	16	16	14	14	12	12	10	10	10	10	8	8	8	8	8	8	8	6
25	18	16	16	14	14	12	12	10	10	10	8	8	8	8	8	6	6	6	6	6
30	18	16	14	14	12	12	10	10	8	8	8	8	8	6	6	6	6	6	6	6
40	16	14	14	12	12	10	10	8	8	8	6	6	6	6	6	6	4	4	4	4
50	16	14	12	12	10	10	8	8	6	6	6	6	6	4	4	4	4	4	4	2
60	14	12	12	10	10	8	8	6	6	6	6	4	4	4	4	2	2	2	2	2
70	14	12	10	10	8	8	6	6	6	6	4	4	4	2	2	2	2	2	2	2
80	14	12	10	10	8	8	6	6	6	4	4	4	2	2	2	2	2	2	2	2
90	12	10	10	8	8	6	6	6	4	4	4	2	2	2	2	2	2	2	1	1
100	12	10	10	8	8	6	6	4	4	4	2	2	2	2	2	1	1	1	1	1

Table F-3 Conductor Sizes for 10% Voltage Drop - 32 Volts

32 Volts – 10% Drop Wire Sizes (gauge) – Based on Minimum CM Area																			
Total Current on Circuit (Amps)	Length of Conductor from Source of Current to Device and Back to Source - Feet																		
	10	15	20	25	30	40	50	60	70	80	90	100	110	120	130	140	150	160	170
5	18	18	18	18	18	18	18	18	18	18	18	16	16	16	16	14	14	14	14
10	18	18	18	18	18	18	16	16	14	14	14	14	14	12	12	12	12	12	12
15	18	18	18	18	18	16	14	14	14	12	12	12	12	10	10	10	10	10	10
20	18	18	18	16	16	14	14	12	12	12	10	10	10	10	10	8	8	8	8
25	18	18	16	16	14	14	12	12	10	10	10	10	10	8	8	8	8	8	8
30	18	18	16	14	14	12	12	10	10	10	10	8	8	8	8	8	6	6	6
40	18	16	14	14	12	12	10	10	8	8	8	8	8	6	6	6	6	6	6
50	16	14	14	12	12	10	10	8	8	8	6	6	6	6	6	6	6	4	4
60	16	14	12	12	10	10	8	8	8	6	6	6	6	6	6	4	4	4	4
70	14	14	12	10	10	8	8	8	6	6	6	6	6	4	4	4	4	2	2
80	14	12	12	10	10	8	8	6	6	6	6	4	4	4	4	2	2	2	2
90	14	12	10	10	10	8	6	6	6	6	4	4	4	4	2	2	2	2	2
100	14	12	10	10	8	8	6	6	6	4	4	4	4	2	2	2	2	2	2

**Table F-4 Conductor Sizes for 3% Voltage Drop - 12 Volts**

12 Volts – 3% Drop Wire Sizes (gauge) – Based on Minimum CM Area																			
Total Current on Circuit (Amps)	Length of Conductor from Source of Current to Device and Back to Source - Feet																		
	10	15	20	25	30	40	50	60	70	80	90	100	110	120	130	140	150	160	170
5	18	16	14	12	12	10	10	10	8	8	8	6	6	6	6	6	6	6	6
10	14	12	10	10	10	8	6	6	6	6	4	4	4	4	2	2	2	2	2
15	12	10	10	8	8	6	6	6	4	4	2	2	2	2	2	1	1	1	1
20	10	10	8	6	6	6	4	4	2	2	2	2	1	1	1	0	0	0	2/0
25	10	8	6	6	6	4	4	2	2	2	1	1	0	0	0	2/0	2/0	2/0	3/0
30	10	8	6	6	4	4	2	2	1	1	0	0	0	2/0	2/0	3/0	3/0	3/0	4/0
40	8	6	6	4	4	2	2	1	0	0	2/0	2/0	3/0	3/0	3/0	4/0	4/0	4/0	4/0
50	6	6	4	4	2	2	1	0	2/0	2/0	3/0	3/0	4/0	4/0	4/0				
60	6	4	4	2	2	1	0	2/0	3/0	3/0	4/0	4/0	4/0						
70	6	4	2	2	1	0	2/0	3/0	3/0	4/0	4/0								
80	6	4	2	2	1	0	3/0	3/0	4/0	4/0									
90	4	2	2	1	0	2/0	3/0	4/0	4/0										
100	4	2	2	1	0	2/0	3/0	4/0											

Table F-5 Conductor Size for 3% Voltage Drop - 24 Volts

24 Volts – 3% Drop Wire Sizes (gauge) – Based on Minimum CM Area																			
Total Current on Circuit (Amps)	Length of Conductor from Source of Current to Device and Back to Source - Feet																		
	10	15	20	25	30	40	50	60	70	80	90	100	110	120	130	140	150	160	170
5	18	18	18	16	16	14	12	12	12	10	10	10	10	10	8	8	8	8	8
10	18	16	14	12	12	10	10	10	8	8	8	6	6	6	6	6	6	6	6
15	16	14	12	12	10	10	8	8	6	6	6	6	6	4	4	4	4	4	4
20	14	12	10	10	10	8	6	6	6	6	4	4	4	4	2	2	2	2	2
25	12	12	10	10	8	6	6	6	4	4	4	4	2	2	2	2	2	2	2
30	12	10	10	8	8	6	6	4	4	4	2	2	2	2	2	1	1	1	1
40	10	10	8	6	6	6	4	4	2	2	2	2	1	1	1	0	0	0	2/0
50	10	8	6	6	6	4	4	2	2	2	1	1	0	0	0	2/0	2/0	2/0	3/0
60	10	8	6	6	4	4	2	2	1	1	0	0	0	2/0	2/0	3/0	3/0	3/0	3/0
70	8	6	6	4	4	2	2	1	1	0	0	2/0	2/0	3/0	3/0	3/0	3/0	4/0	4/0
80	8	6	6	4	4	2	2	1	0	0	2/0	2/0	3/0	3/0	3/0	4/0	4/0	4/0	4/0
90	8	6	4	4	2	2	1	0	0	2/0	2/0	3/0	3/0	4/0	4/0	4/0	4/0	4/0	
100	6	6	4	4	2	2	1	0	2/0	2/0	3/0	3/0	4/0	4/0	4/0				

**Table F-6 Conductor Sizes for 3% Voltage Drop - 32 Volts**

<b>32 Volts – 3% Drop Wire Sizes (gauge) – Based on Minimum CM Area</b>																			
<b>Total Current on Circuit (Amps)</b>	<b>Length of Conductor from Source of Current to Device and Back to Source - Feet</b>																		
	10	15	20	25	30	40	50	60	70	80	90	100	110	120	130	140	150	160	170
5	18	18	18	18	16	16	14	14	12	12	12	12	10	10	10	10	10	10	8
10	18	16	16	14	14	12	12	10	10	10	8	8	8	8	8	6	6	6	6
15	16	14	14	12	12	10	10	8	8	8	6	6	6	6	6	6	6	4	4
20	16	14	12	12	10	10	8	8	6	6	6	6	6	4	4	4	4	4	2
25	14	12	12	10	10	8	8	6	6	6	6	4	4	4	4	2	2	2	2
30	14	12	10	10	8	8	6	6	6	4	4	4	4	2	2	2	1	1	1
40	12	10	10	8	8	6	6	4	4	4	2	2	2	2	2	1	1	1	1
50	12	10	8	8	6	6	4	4	2	2	2	2	2	1	1	0	0	0	0
60	10	8	8	6	6	4	4	2	2	2	2	1	1	0	0	0	2/0	2/0	2/0
70	10	8	6	6	6	4	2	2	2	1	1	0	0	0	2/0	2/0	2/0	3/0	3/0
80	10	8	6	6	4	4	2	2	1	1	0	0	0	2/0	2/0	3/0	3/0	3/0	3/0
90	8	6	6	6	4	2	2	2	1	0	0	2/0	2/0	2/0	3/0	3/0	3/0	4/0	4/0
100	8	6	6	4	4	2	2	1	0	0	2/0	2/0	2/0	3/0	3/0	3/0	4/0	4/0	4/0