

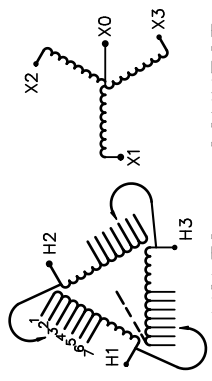

REVISION	DATE	BY	DATE	BY
			16/05/12	GP

Confidential - Property of <b>Siemens Industry, Inc.</b>	
CUSTOMER	
ORDER NO.	DWG. NO.
	3F3Y300D16IR
	SH 1 OF 2

# SIEMENS

<p>CATALOG NO. 3F3Y300D16IR</p> <p>SERIAL NO.</p> <p><b>300</b> kVA    <b>60</b> Hz    <b>3</b> PHASE</p> <p><b>4.7</b> % IMP AT    <b>170</b> °C</p> <p><b>150</b> °C RISE    <b>30</b> °C AVG. AMBIENT</p> <p><b>220</b> °C TEMP CLASS    <b>40</b> °C MAX. AMBIENT</p> <p>PRIMARY ( H1 H2 H3 )    <b>480</b> V 10 kV BIL</p> <p>SECONDARY( X0 X1 X2 X3 )    <b>208Y/120</b> V 10 kV BIL</p> <p>WINDING MATERIAL    <b>AL</b></p> <p>ENCLOSURE TYPE 3R    WEIGHT 1850 LBS</p> <p>ENERGY EFFICIENCY EXCEEDS CSA C802.2-2012    DOE 10 CFR PART 431:2016</p> <p>SPACINGS BETWEEN ANY VENTILATED ENCLOSURE PANEL AND ANY ADJACENT WALL SHALL BE A MINIMUM OF 5 INCHES EXCEPT WHEN WALL MOUNTED USING APPROVED WALL MOUNTING KIT</p> <p>SUITABLE FOR INDOOR OR OUTDOOR LOCATIONS BEFORE HANDLING, INSTALLING AND OPERATING; SEE INSTRUCTION MANUAL</p> <p>NEMA Class <b>ANN</b> Dry Type Transformer    Siemens Industry, Inc. Norcross, GA <small>dsu0086e</small></p>	<div style="text-align: center;">  <p>VOLTS CONNECT</p> <p>504 492 480 468 456 444 432</p> </div> <div style="text-align: center;"> <p>TYPE K</p>   <p>DRY TYPE TRANSFORMER</p> <p>SEISMIC QUALIFICATIONS, FLOOR MOUNT ONLY OSP-0136-10 IBC 2012/ASCE 7-10 SDS&lt;=2.0g z/h=1 p=1.5</p> </div>
---	---



FRONT VIEW

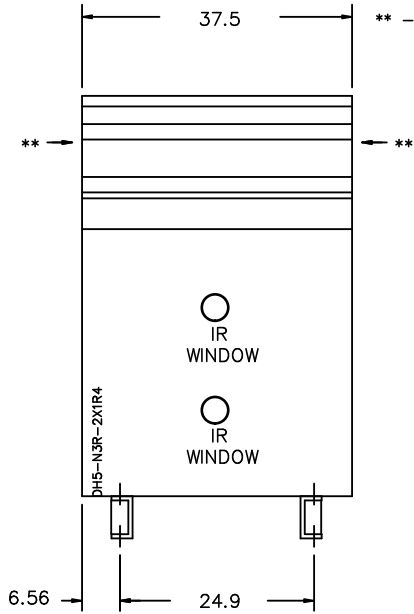

\*\* - Recommended cable entry locations only  
cutouts & gland plates not provided.

SIDE VIEW

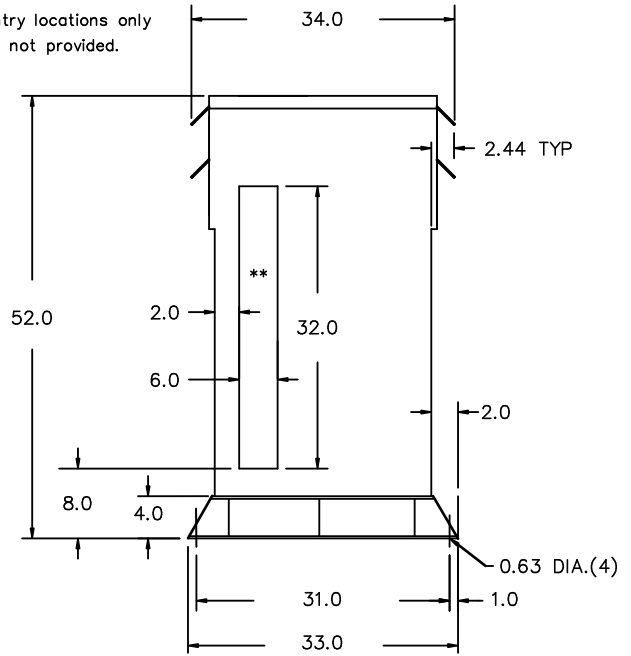

IR Window Diameter d=4  
All Dimensions in inches

ENCLOSURE COLOR : ANSI 61 GREY - OUTDOOR

H.V.1. TERMINAL DETAIL

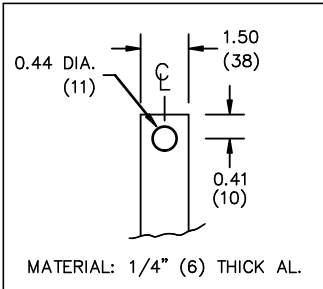

L.V.1. TERMINAL DETAIL

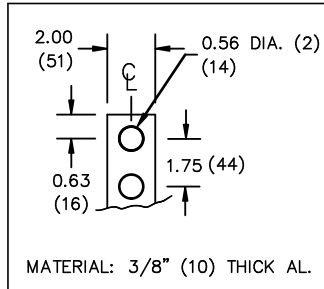

CUSTOMER NOTES:

- HV1 TERMINATED AT TOP FRONT
- LV1 TERMINATED AT BOTTOM FRONT

Confidential - Property of  
Siemens Industry, Inc.

REVISION	DATE	BY	DATE	BY
		DRAWN	16/05/12	GP
		CHEK'D		
		VERIF'D		

CUSTOMER	
ORDER NO.	DWG. NO.
	3F3Y300D16IR
SH 2 OF 2	

0.1 gpatel 2016/05/13 09:41