

# Catalog Number: UAT115-0G

## Features and Ratings

- Ringless Type Meter Socket
- 150A Continuous, 150A Max., 600V AC
- Outdoor Enclosure (NEMA Type 3R)
- Painted Steel Enclosure
- 1 Phase, 3 Wire
- 4 Jaw Meter Socket
- Meter Socket Type UAT1
- For Overhead & Underground Service
- RX Type Hub Opening

## Accessories

CONDUIT HUBS (RX Type)	
TRADE SIZE	CATALOG No.
1-1/4 INCH	EC38597 or H38597-2
1-1/2 INCH	EC38598 or H38598-2
2 INCH	EC38599 or H38599-2
2-1/2 INCH	EC38600 or H38600-2

Hub Cover Plate EC38595 or H38595-1

Meter Opening Cover Plate

Cat No: H659-0162

5th Jaw Kit

Cat. No: EC659-0121

## Connectors, Wire Sizes and Torques

CONNECTOR	WIRE SIZE	TORQUE
LINE, LOAD, NEUTRAL*	2/0 - 14 AWG	50 IN.-LBS.
GROUND	#2 - 14 AWG	50 IN.-LBS.

\* External Hex Drive 5/16"

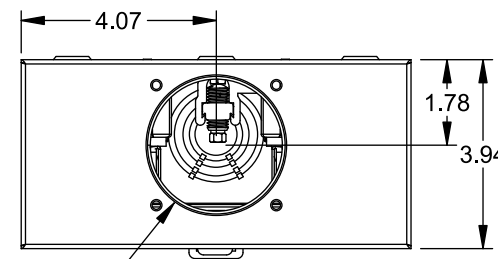

TYPE RX (SMALL) HUB OPENING

VIEW SHOWN WITH COVER REMOVED

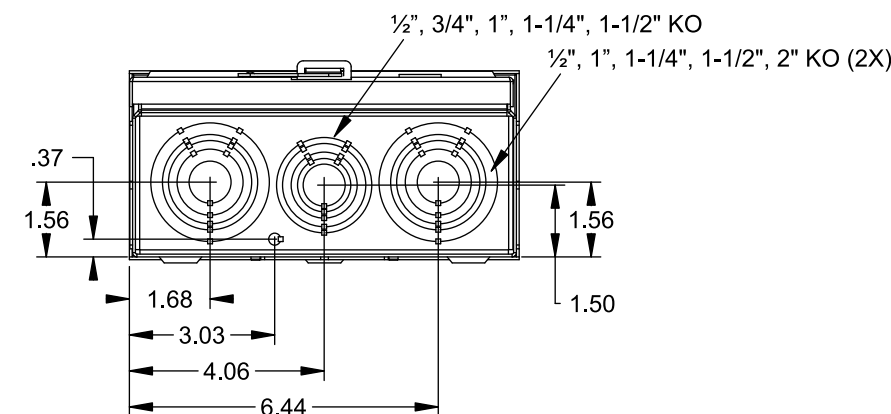
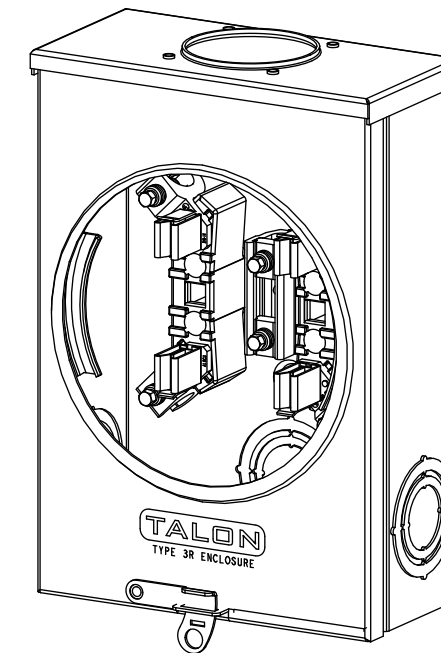
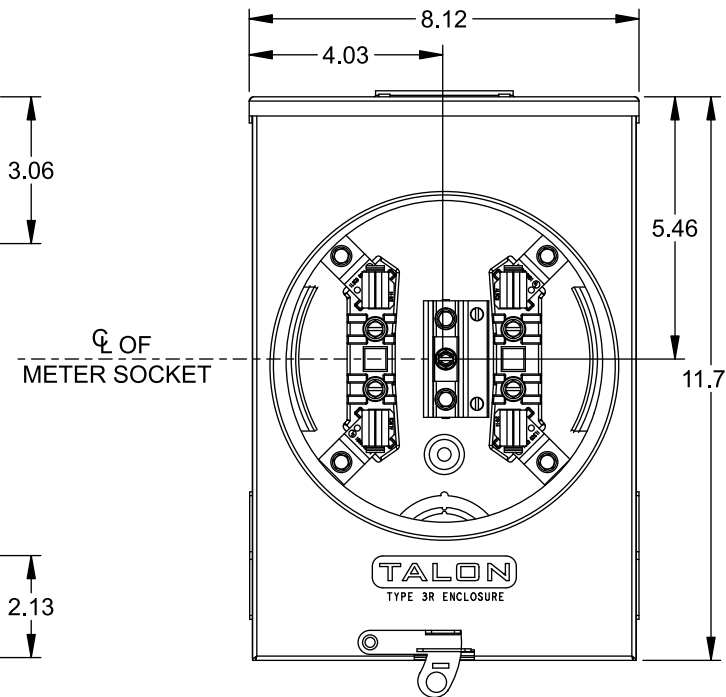
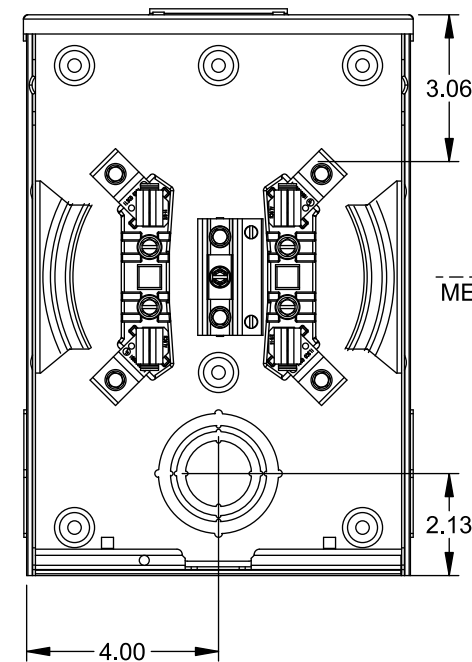
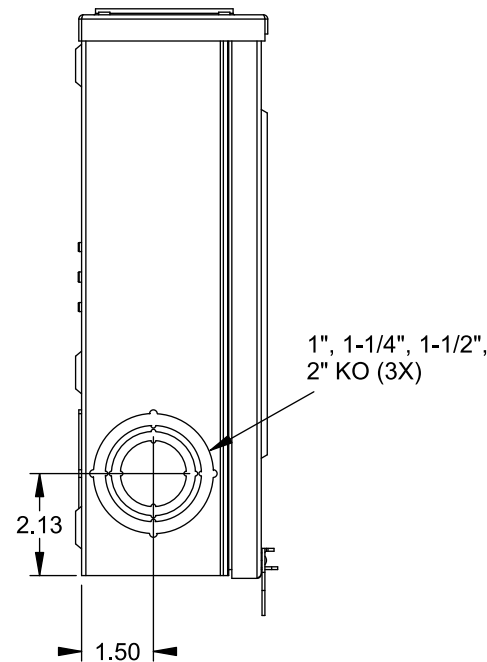

© 2015 Copyright Siemens Industry, Inc.

**TALON**

**Meter Socket**

Description: **150A Cont, 4 Jaw, UAT1, 600V AC, Painted Steel Enclosure**

JEL 8/30/15 DO NOT SCALE DRAWING Dwg No: **UAT115-0G**