

SIPROTEC 3/4 central operation via Ethernet Serial-Hub

7XV5655

General

The serial hub and the associated configuration software may be used to serially operate SIPROTEC protection devices with a PC or Notebook PC and DIGSI 4 via an Ethernet network. The configuration software installs virtual serial interfaces (COM-Ports) on the operating PC. Each COM-port is assigned with a serial hub and fixed IP address in the network. This IP address must be set in the serial hub. The connection of the PC to the network is done via the Ethernet interface. The protection devices are connected to the serial hub via an RS232/RS485 or FO – interface. The connection with DIGSI 4 is established via the virtual COM-port on the PC and the IP-address of the serial hub in the substation. The serial data are packed as user data into the Ethernet protocol on the PC and transferred to the serial hub via the Ethernet connection. The requirement of a standard conforming gap-free transmission of serial DIGSI or IEC 60870-5-103/101 telegrams via the network is complied with by the communication driver on the PC as well as the serial hub listening into the serial telegram traffic. The serial IEC telegrams are transmitted via the Ethernet in complete blocks. The data traffic of the serial interface via RS232 and FO is full duplex. In the case of RS485 it is half duplex. The control lines of RS232-interfaces are not supported.

The example describes the operation of V3 protection devices with FO interface and SIPROTEC 4 devices on a RS485-Bus in a private network, each via a serial hub with DIGSI 4. The operating PC and the Ethernet serial hub are all located in a subnet (network segment). The direct connection of a SIPROTEC 4 device with Ethernet module (EN 100) is not described here.

NOTE: This application aid only serves as additional user information and requires knowledge of the general guidelines for the operation of the product as well as its basic functions as described in the manual.

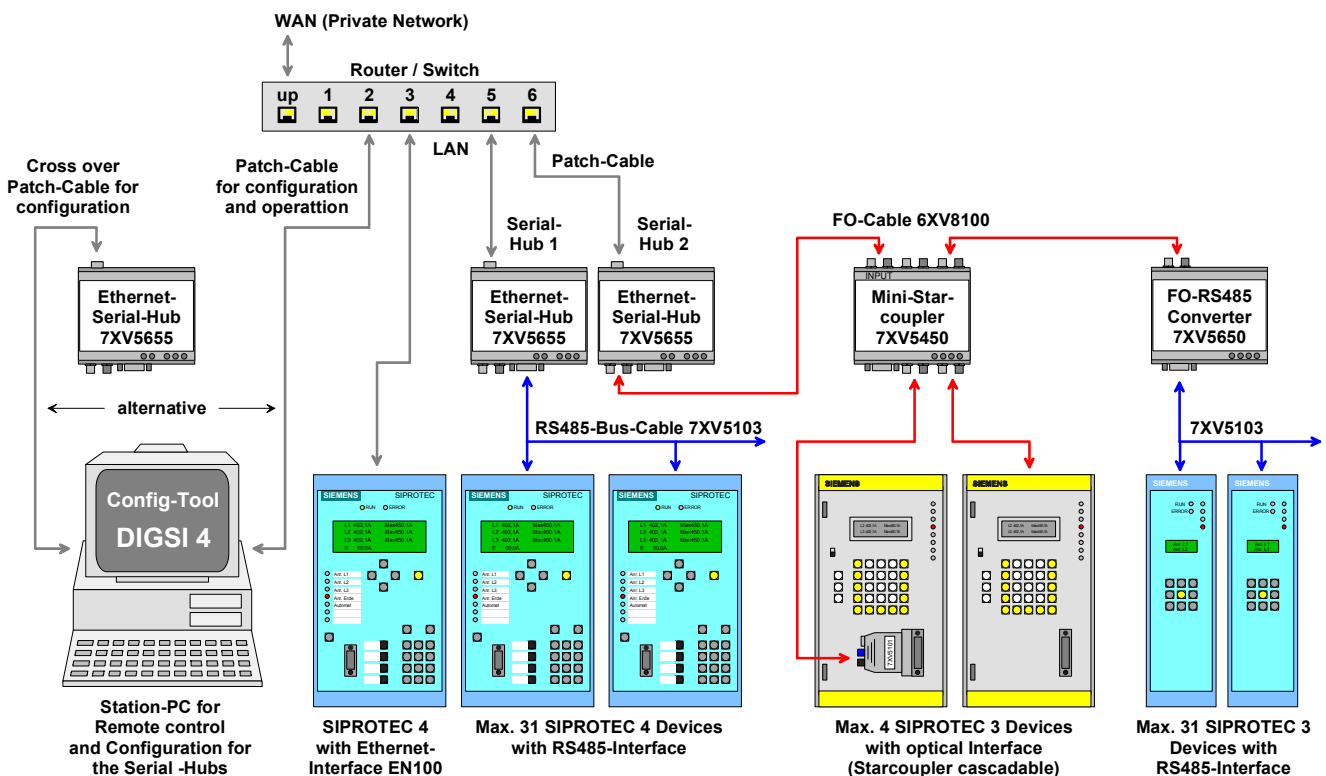

Procedure:

- **Preparing the operating PC**
 - Install configuration tool (Configtool).
 - Define IP-addresses in the PC.
- **Setting serial hubs with the configuration tool**
 - Setting the basic data (IP-address, name, password) of the serial hub.
 - Connecting the-PC and Ethernet-Hubs to the Ethernet.
 - Setting the communication parameters of the serial hubs (TC57, RS485, etc.).
- **Establishing a connection to the protection devices**
 - Start making the connection
 - Connection to the protection device is being established

Installing the Configtool on the operating PC

The Configtool must be installed on the operating PC using the available CD. Details on how this is done are included in the manual.

Note: In our Download-Area in the Internet under www.siprotec.com / Accessories / 7XV5655 you may find current updates regarding the Configtool as well as a new Firmware Version for downloading.

Setting an IP-Address for the operating PC

A fixed IP address should be set in the operating PC. In this application the **IP-address 192.168.10.100** with the **subnet-mask 255.255.255.0** was set.

If the operating PC is connected to a company network with automatic IP allocation (DHCP), the IP address of the network segment (here 192.168.10.xxx) must be known. The fixed IP addresses of the serial hub must then accordingly be set and made available by the network administrator.

Note: The serial hub does not support DHCP, and requires a fixed and unique IP address in the network.

Setting serial hubs with the Configtool

A factory pre-setting is loaded on all serial hubs, which must be adapted to the various applications. This is done with a Configtool on an operating PC which is connected to the serial hub with a crossed patch cable.

After connecting auxiliary voltage to the serial hub, and connecting it to the operating PC with the crossed patch cable, the configuration tool is started. The serial hub should be identified immediately after the start and the delivery settings should be displayed (see below).

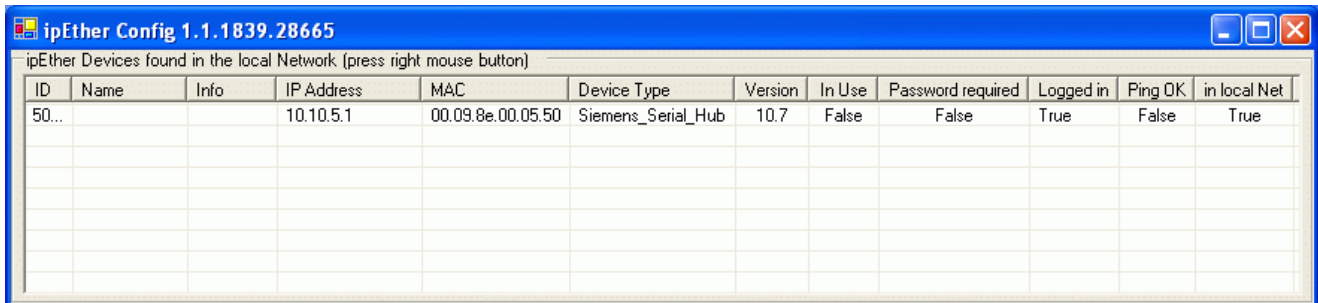

The screenshot shows the 'ipEther Config 1.1.1839.28665' window. The title bar includes standard Windows window controls. Below the title bar, a text label reads 'ipEther Devices found in the local Network (press right mouse button)'. A table displays the following data:

ID	Name	Info	IP Address	MAC	Device Type	Version	In Use	Password required	Logged in	Ping OK	in local Net
50...			10.10.5.1	00.09.8e.00.05.50	Siemens_Serial_Hub	10.7	False	False	True	False	True

If more than one serial hub is connected in the same network segment to a switch with an uncrossed patch cable, they are all displayed in the Configtool. In the figure below two devices are displayed with their pre-settings. They are differentiated by their unique MAC addresses, which are firmly set by the manufacturer and cannot be changed.

The setting of the two serial hubs is done with the Configtool on an operating PC, which is also connected to the switch with an uncrossed patch cable.

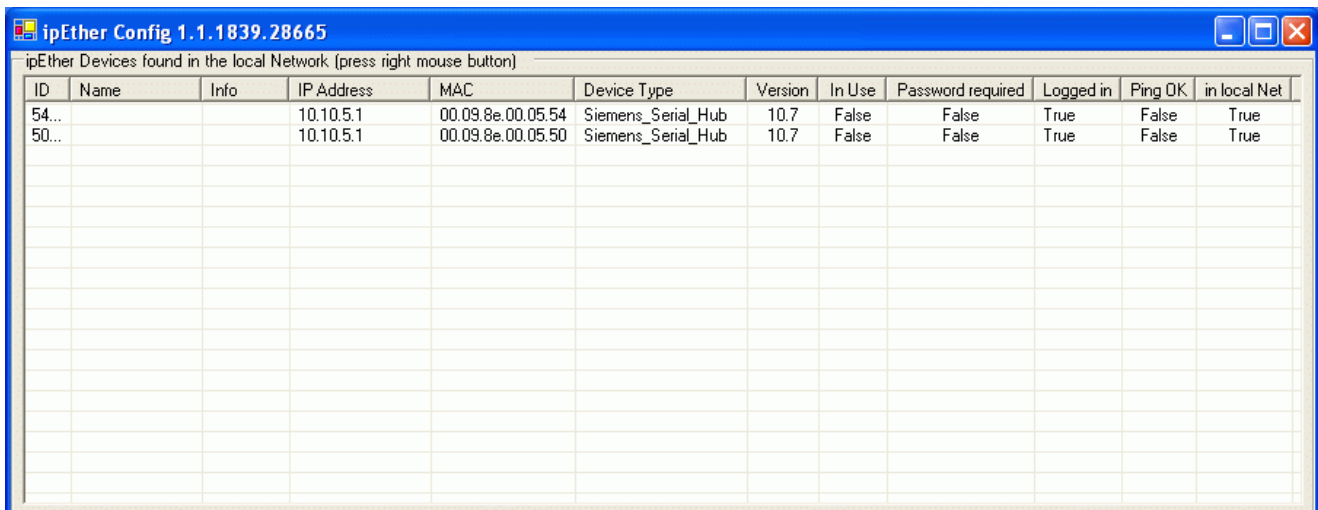

The screenshot shows the 'ipEther Config 1.1.1839.28665' window. The title bar includes standard Windows window controls. Below the title bar, a text label reads 'ipEther Devices found in the local Network (press right mouse button)'. A table displays the following data:

ID	Name	Info	IP Address	MAC	Device Type	Version	In Use	Password required	Logged in	Ping OK	in local Net
54...			10.10.5.1	00.09.8e.00.05.54	Siemens_Serial_Hub	10.7	False	False	True	False	True
50...			10.10.5.1	00.09.8e.00.05.50	Siemens_Serial_Hub	10.7	False	False	True	False	True

Note: In these examples fixed IP addresses are allocated to the operating PC:
IP-address: 192.168.10.100 / subnet mask: 255.255.255.0

Allocating the IP-address and name to the serial hub 1

Each device, also the Ethernet serial hub must be allocated with an own, unique IP address in a private network (LAN) or public network (WAN).

In a subnet mask 255.255.255.0 the first 3 blocks if the IP address in the subnet mask (network segment) must be identical, the last block may be between 1 and 254.

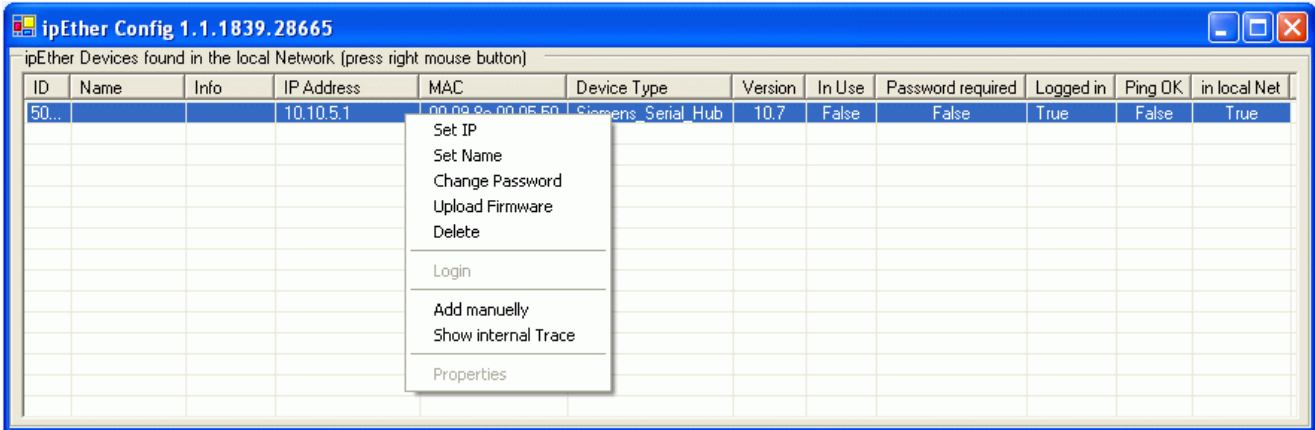

Click on the pre-set IP address (10.10.5.1) with the right mouse button
A selection box opens.

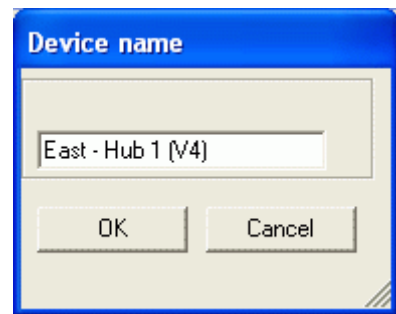
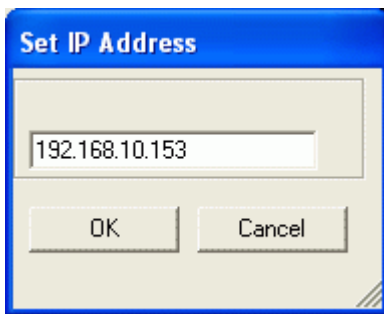

In the selection box, select „Set IP“ and enter the new IP-address, e.g 192.168.10.153 and confirm with “OK”.

In the selection box select „Set Name“ and enter a name, e.g. East–Hub 1 (V4); confirm with “OK”.

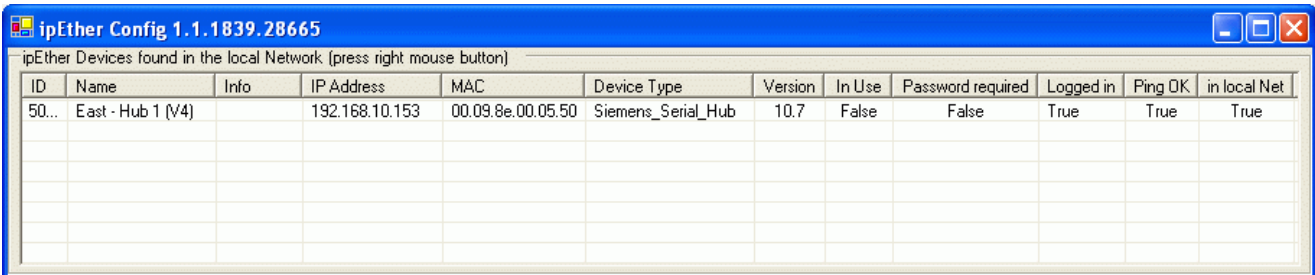

When the settings are confirmed with “OK“, these are saved in the serial hub.
The information window is automatically updated and the serial hub is displayed with its new settings.

After a new start of the Configtool the serial hub is located with its current settings and displayed. In the columns “Ping OK” and “in local Net” the message “True” means that the serial hub is now located in the same network segment as the operating PC and is answering to a “Ping”. The column “Logged in” is “True” means that other parameters may now be set without entering a password (see the following chapters).

Allocating an IP-address and name to serial hub 2

Each device, also the Ethernet serial hub must be allocated with an own, unique IP address in a private network (LAN) or public network (WAN).

In a subnet mask 255.255.255.0 the first 3 blocks if the IP address in the subnet mask (network segment) must be identical, the last block may be between 1 and 254.

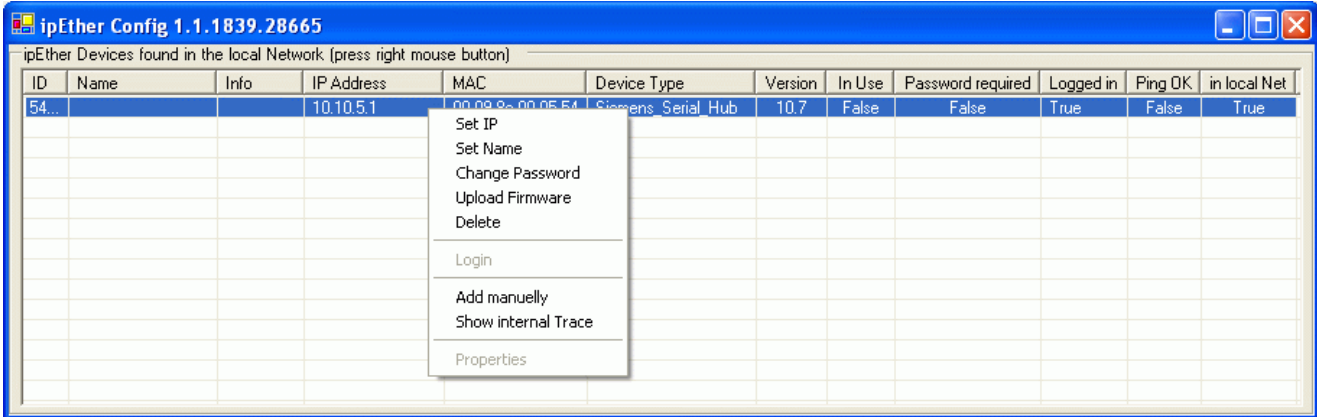

Click on the pre-set IP address (10.10.5.1) with the right mouse button
A selection box opens.

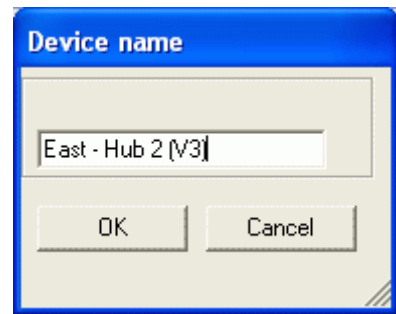
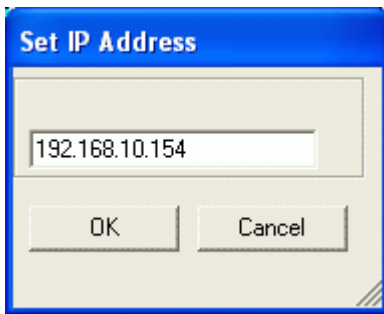

In the selection box, select „Set IP“ and enter the new IP-address, e.g 192.168.10.154 and confirm with “OK”.

In the selection box select „Set Name“ and enter a name, e.g. East–Hub 2 (V3); confirm with “OK”.

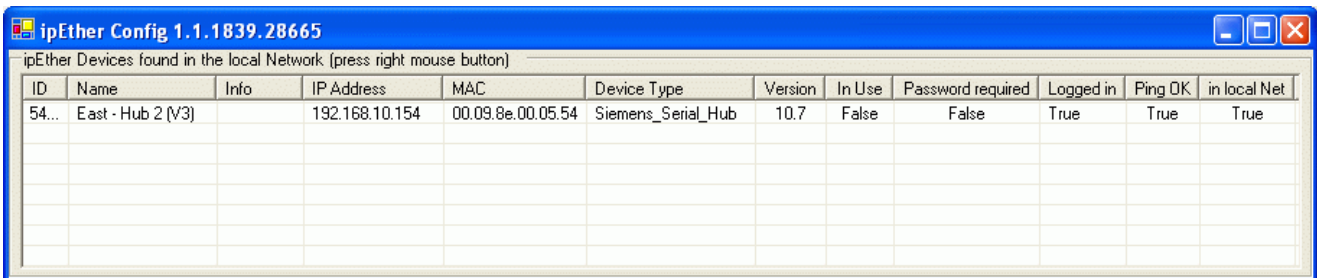

When the settings are confirmed with “OK“, these are saved in the serial hub.
The information window is automatically updated and the serial hub is displayed with its new settings.

After a new start of the Configtool the serial hub is located with its current settings and displayed. In the columns “Ping OK” and “in local Net” the message “True” means that the serial hub is now located in the same network segment as the operating PC and is answering to a “Ping”. The column “Logged in” is “True” means that other parameters may now be set without entering a password (see the following chapters).

Integrating the serial hub in a network

After the serial hubs have been allocated with unique IP addresses, they may be integrated in the network. The simplest local network may be established with a central router or switch, at the outputs of which all participants can be connected with a uncrossed patch cable (see figure).

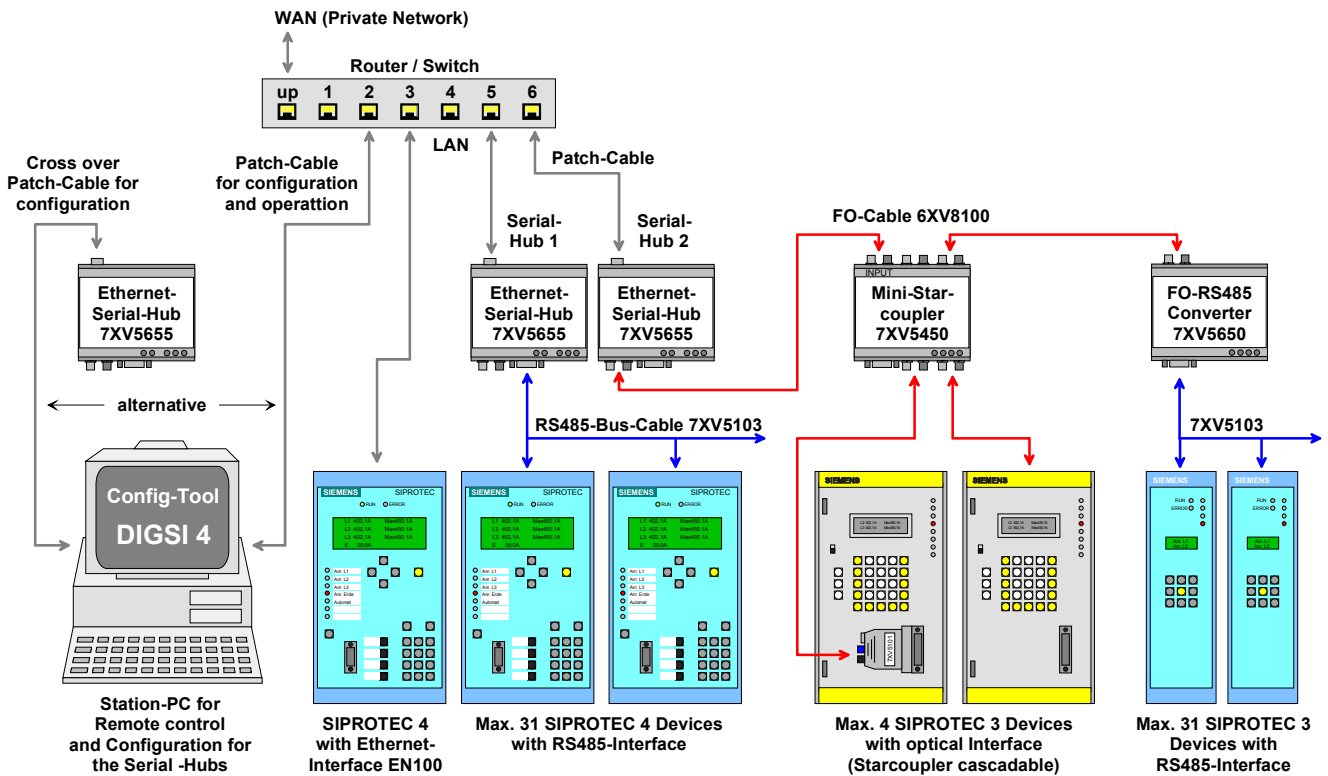

In this application, all serial hubs used in the network, as well as all protection devices can be operated with the “Station PC” and DIGSI 4.

If SIPROTEC 4 protection devices with fast communication and “slow” V3 protection devices (e.g. 7SD600) are used together in one substation, 2 serial hubs may be used to establish a separation of these two systems, to reach the optimum operational performance for each device.

Setting the protection devices V4 with serial hub 1 “East-Hub1 (V4)”

All protection devices connected to the RS485 bus, must have unique (different) device addresses. The data format (e.g. 8N1) and the baudrate (e.g. 57,6 kB) must be the same for all devices. The maximum baudrate is accordingly designated by the slowest device

Setting the protection devices V3 with serial-Hub 2 “East-Hub3 (V3)”:

All protection devices connected to the star-coupler or RS485 bus must have unique (different) device addresses.

The data format (e.g. 8E1) and the baudrate (e.g. 9,6 kB) must be the same for all devices. The maximum baudrate is accordingly designated by the slowest device

The data format set with DIGSI 4 and the baudrate for each protection device are transmitted to the serial hub for communication when the connection is made.

Configuration of serial hub 1 with SIPROTEC 4 devices

The configuration of serial hub 1 (East hub 1 (V4)) is done with the Configtool on the “Station PC”. Data transmission takes place via the Ethernet interface of the PC to the router or switch and on to the serial hubs. After starting the Configtool, all serial hubs with allocated names and IP addresses are identified and displayed.

ID	Name	Info	IP Address	MAC	Device Type	Version	In Use	Password required	Logged in	Ping OK	in local Net
50...	East - Hub 1 (V4)		192.168.10.153	00.09.8e.00.05.50	Siemens_Serial_Hub	10.7	False	False	True	True	True
54...	East - Hub 2 (V3)		192.168.10.154	00.09.8e.00.05.54	Siemens_Serial_Hub	10.7	False	False	True	True	True

A click with the right mouse button on the serial hub “East-Hub 1 (V4)” opens a pull-down menu.

ID	Name	Info	IP Address	MAC	Device Type	Version	In Use	Password required	Logged in	Ping OK	in local Net
50...	East - Hub 1 (V4)		192.168.10.153	00.09.8e.00.05.50	Siemens_Serial_Hub	10.7	False	False	True	True	True
54...	East - Hub 2 (V3)		192.168.10.154	00.09.8e.00.05.54	Siemens_Serial_Hub	10.7	False	False	True	True	True

- Set IP
- Set Name
- Change Password
- Upload Firmware
- Delete
-
- Login
-
- Add manually
- Show internal Trace
-
- Properties

A further click with the left mouse button on “Properties” opens the menu for the various settings.

On **TCP/IP** page the **MAC-address**, the **IP-address** as well as the **name** of the selected serial hub are displayed for checking purposes.

These settings are saved in the serial hub, they cannot be changed here.

Siemens Serial Hub Properties 10.0.1839.28664

TCP/IP | RS232 | PortAssignment | INet Info | About

Info

MAC: 00.09.8e.00.05.50

IP: 192.168.10.153

Name: East - Hub 1 (V4)

OK Apply Cancel

Note: The following settings are saved in the Registry of the operating PC. When the COM-Port is started these settings are transmitted to the serial hub; they are saved there until the COM-port is again closed by all applications. If operation is to be carried out from more than one operation PCs, a Configtool must be installed on each of these PCs. The following settings must also be done; the COM-port may be freely selected.

The setting **use TC57** under **TC57** must be activated and the **Format FT 1.2** must be checked.

This function optimises the timing in DIGSI and the IEC 60870-5-103 / 101-protocol.

The **Fixed Frame length** remains at **2 byte**.

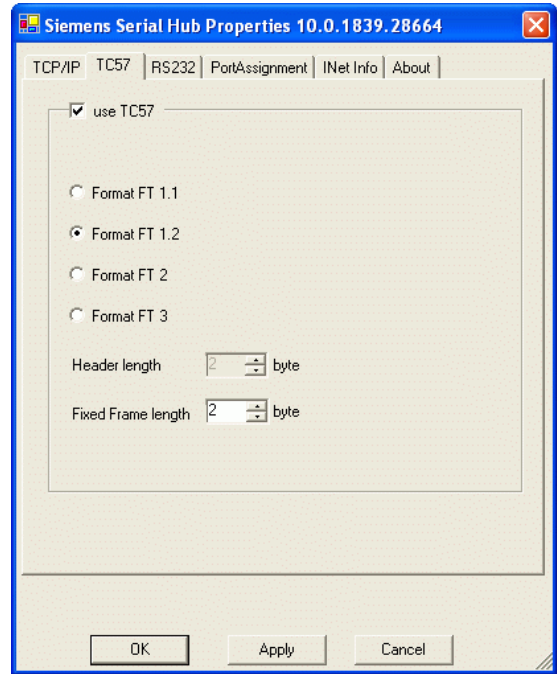

In the **RS232**-window, all available virtual **COM-ports** of the operating PC are displayed for selection. A maximum of 254 COM-ports are available if these are not occupied by other applications (e.g. USB-interface-Adapter).

The selected Com-port (here COM 11) is saved on the operating PC and allocated to the IP address of the serial hub.

As all V4 protection devices are operated via the RS485 interface at the RS485 bus, and as the DIGSI protocol only has to operate in the half-duplex mode, the **Half Duplex (RS485)** button must be checked.

No change is required for the settings under **Timeouts**.

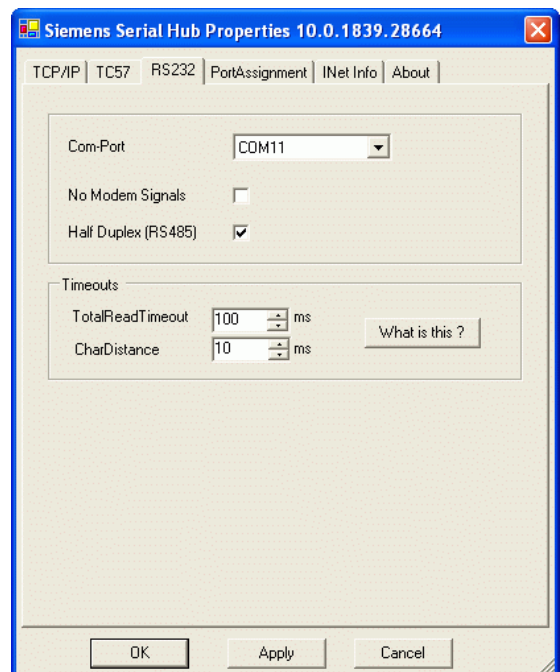

Configuration of the serial hub 2 with V3 devices

The configuration of the serial hub 2 (East – Hub2 (V3)) is done with the Configtool on the “substation PC”. The data traffic is transmitted via the Ethernet interface of the PC to the router or switch and on to the serial hubs. After starting the Configtool, all serial hubs with allocated names and IP addresses are identified and displayed.

ID	Name	Info	IP Address	MAC	Device Type	Version	In Use	Password required	Logged in	Ping OK	in local Net
50...	East - Hub 1 (V4)		192.168.10.153	00.09.8e.00.05.50	Siemens_Serial_Hub	10.7	False	False	True	True	True
54...	East - Hub 2 (V3)		192.168.10.154	00.09.8e.00.05.54	Siemens_Serial_Hub	10.7	False	False	True	True	True

A click with the right mouse button on the serial hub “East-Hub 2 (V3)” opens a pull-down menu.

ID	Name	Info	IP Address	MAC	Device Type	Version	In Use	Password required	Logged in	Ping OK	in local Net
50...	East - Hub 1 (V4)		192.168.10.153	00.09.8e.00.05.50	Siemens_Serial_Hub	10.7	False	False	True	True	True
54...	East - Hub 2 (V3)		192.168.10.154	00.09.8e.00.05.54	Siemens_Serial_Hub	10.7	False	False	True	True	True

- Set IP
- Set Name
- Change Password
- Upload Firmware
- Delete
-
- Login
-
- Add manually
- Show internal Trace
-
- Properties

A further click with the left mouse button on “Properties” opens the menu for the various settings.

On **TCP/IP** page the **MAC-address**, the **IP-address** as well as the **name** of the selected serial hub are displayed for checking purposes.

These settings are saved in the serial hub, they cannot be changed here.

Siemens Serial Hub Properties 10.0.1839.28664

TCP/IP | RS232 | PortAssignment | INet Info | About

Info

MAC: 00.09.8e.00.05.54

IP: 192.168.10.154

Name: East - Hub 2 (V3)

OK Apply Cancel

Note: The following settings are saved in the Registry of the operating PC. When the COM-Port is started these settings are transmitted to the serial hub; they are saved there until the COM-port is again closed by all applications. If operation is to be carried out from more than one operation PCs, a Configtool must be installed on each of these PCs. The following settings must also be done; the COM-port may be freely selected.

The setting **use TC57** under **TC57** must be activated and the **Format FT 1.2** must be checked.

This function optimises the timing in DIGSI and the IEC 60870-5-103 / 101-protocol.

The **Fixed Frame length** remains at **2 byte**.

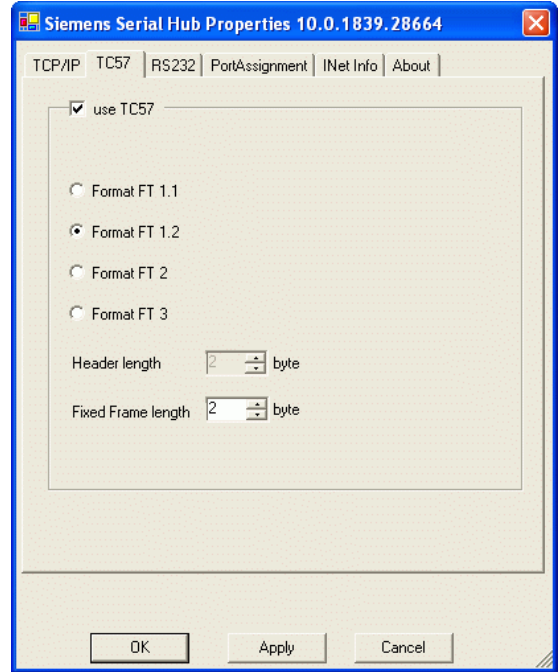

In the **RS232**-window, all available virtual **COM-ports** of the operating PC are displayed for selection. A maximum of 254 COM-ports are available if these are not occupied by other applications (e.g. USB-interface-Adapter).

The selected Com-port (here COM 12) is saved on the operating PC and allocated to the IP address of the serial hub.

As V3 protection devices are operated behind the optical star-coupler and FO RS485 converter at the RS485 bus, and as the DIGSI protocol only has to operate in the half-duplex mode, the **Half Duplex (RS485)** button must be checked.

No change is required for the settings under **Timeouts**.

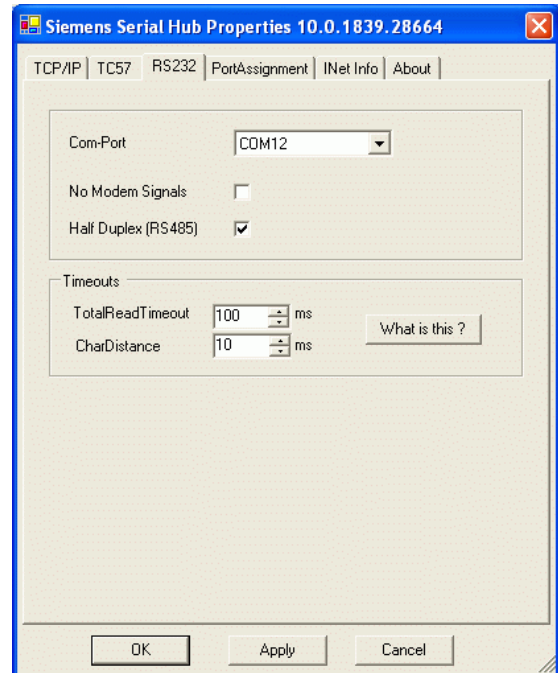

Under “**PortAssignment**“ as list of the assigned COM-ports with their allocated IP addresses are displayed.

In the column “**Comment**“ the “name” e.g. the name of the substation is displayed.

This display represents the allocation of the COM-ports to the serial hubs and may be used as a reference guide during selection of a COM-port in DIGSI 4.

Note: In case of establishing a direct connection, only the available COM-ports are displayed in DIGSI 4. The allocated serial hubs are not displayed in this case.

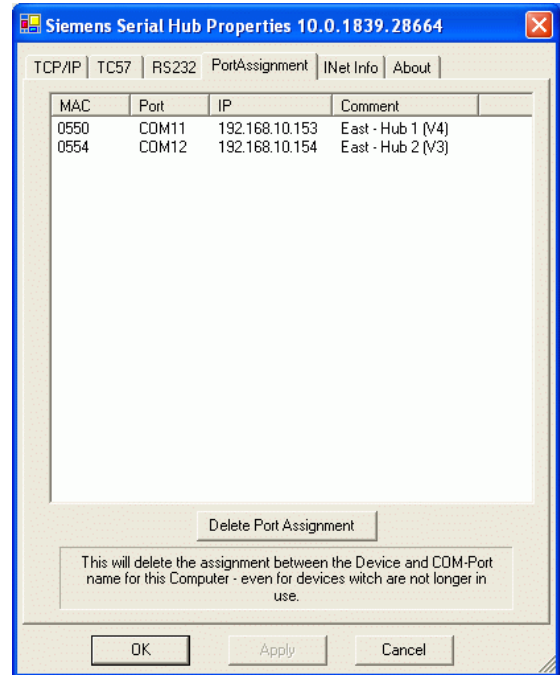

Under „**INet Info**“ a route trace may be started by means of multiple “Pings”.

The results of a successful ping are then displayed with response lines.

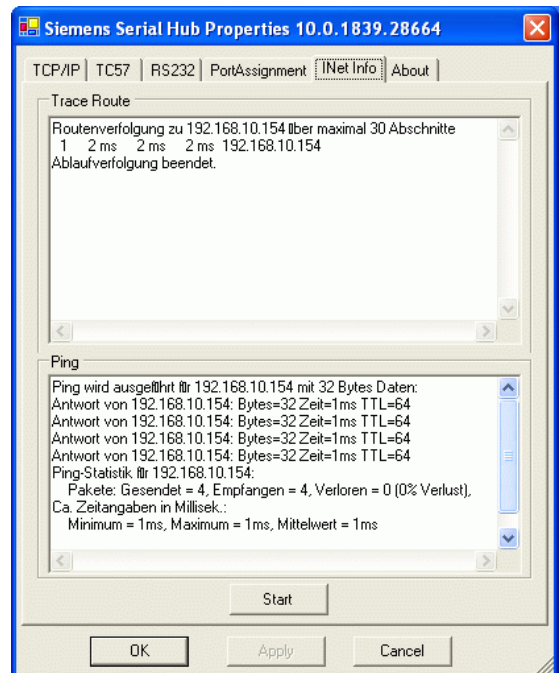

Creating a project and substation in DIGSI 4

SIPROTEC devices are integrated in a clear and transparent structure in DIGSI 4. This structure may be substation oriented, but may in addition be V3/V4 device oriented.

The serial hubs do not have to be created in DIGSI 4 nor do they need to be taken into consideration in any way.

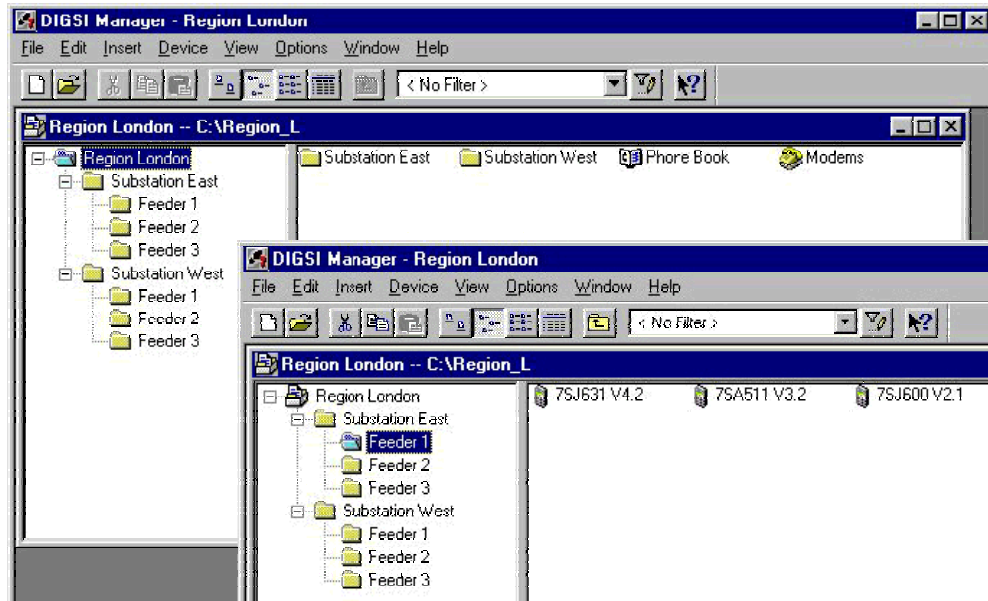

Establishing a connection via a serial hub

By double-clicking on the desired protection device (here the SIPROTEC 4 device 7SJ63), a dialog box is opened (see below).

The connection type “**Direct**” via COM port 11 (which was assigned to the serial hub in the Configtool) is selected.

If the operation takes place via the service interface, “**back**” must be selected under “**device interface**”.

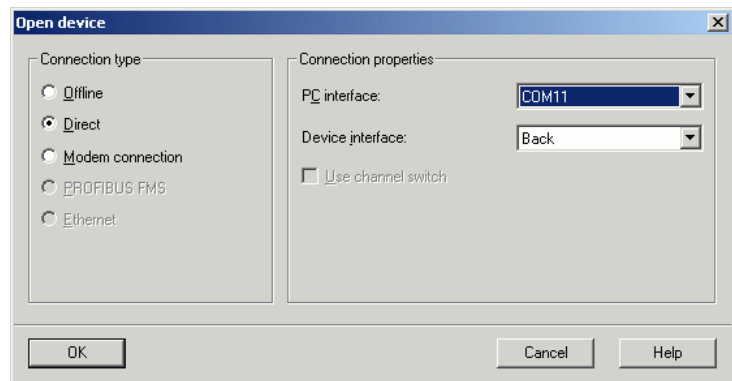

Note: Before the connection to the protection device is established, the communication parameters (baudrate and data format) of the protection device interface (here service interface back) are automatically transmitted to the serial hub by DIGSI.

The allocation of COM-ports to the serial hubs cannot be displayed in DIGSI. The most recent selection is however saved in DIGSI. A reference list with COM-port, IP address and assigned name is displayed in the Configtool under “Port-Assignment” for this operating PC, and may be used as a reminder. Additionally the user may individually create a table for himself (e.g. in Excel).

Substation	Feeder	Device	Conn. Type	COM-Port	Hub-Name	IP
Subst. East	Feeder 1	7SJ631 V4.2	Direct	11	East-Hub 1 (V4)	192.168.10.153
Subst. East	Feeder 1	7SA511 V3.2	Direct	12	East-Hub 2 (V3)	192.168.10.154
Subst. East	Feeder 1	7SA522 V4.2	Ethernet	--	--	192.168.10.123

We wish a lot of success!