



IRIG STANDARD 200-98

**TELECOMMUNICATIONS
AND TIMING GROUP**

IRIG SERIAL TIME CODE FORMATS

**WHITE SANDS MISSILE RANGE
KWAJALEIN MISSILE RANGE
YUMA PROVING GROUND
DUGWAY PROVING GROUND
ABERDEEN TEST CENTER
NATIONAL TRAINING CENTER**

**ATLANTIC FLEET WEAPONS TRAINING FACILITY
NAVAL AIR WARFARE CENTER WEAPONS DIVISION
NAVAL AIR WARFARE CENTER AIRCRAFT DIVISION
NAVAL UNDERSEA WARFARE CENTER DIVISION, NEWPORT
PACIFIC MISSILE RANGE FACILITY
NAVAL UNDERSEA WARFARE CENTER DIVISION, KEYPORT**

**30TH SPACE WING
45TH SPACE WING
AIR FORCE FLIGHT TEST CENTER
AIR FORCE DEVELOPMENT TEST CENTER
AIR WARFARE CENTER
ARNOLD ENGINEERING DEVELOPMENT CENTER
GOLDWATER RANGE
UTAH TEST AND TRAINING RANGE**

**DISTRIBUTION A: APPROVED FOR PUBLIC RELEASE;
DISTRIBUTION IS UNLIMITED**

IRIG STANDARD 200-98

IRIG SERIAL TIME CODE FORMATS

MAY 1998

Prepared by

**TIMING COMMITTEE
TELECOMMUNICATIONS AND TIMING GROUP
RANGE COMMANDERS COUNCIL**

Published by

**Secretariat
Range Commanders Council
U.S. Army White Sands Missile Range,
New Mexico 88002-5110**

PREFACE

This document was updated in February 1995. It defined the characteristics of the serial time code formats A, B, D, E, G, and H. The task of revising this standard was assigned to the Telecommunications and Timing Group of the Range Commanders Council. This 1998 edition of the document incorporates Manchester modulation for codes so designated. This standard should be adhered to by all U.S. Government ranges and facilities where serial time codes are generated for correlation of data with time.

TABLE OF CONTENTS

	<u>Page</u>
PREFACE	iii
LIST OF FIGURES	vi
LIST OF TABLES	vi
ABBREVIATIONS AND TERMS	vii
DEFINITIONS	viii
GLOSSARY OF SELECTED TIME TERMS	x
INTRODUCTION	1
1.0 General Description of Standard.....	3
2.0 General Description of Formats	3
2.1 Pulse Rise Time	3
2.2 Jitter	3
2.3 Bit Rates and Index Count	3
2.4 Time Frame, Time Frame Reference, and Time Frame Rates	4
2.5 Position Identifiers	4
2.6 Time Code Words	5
2.7 BCD Time-of-Year Code Word.....	5
2.8 Control Functions	6
2.9 Index Markers	6
2.10 Amplitude Modulated Carrier	6
3.0 Detail Description of Formats	9
4.0 General Description of Time Codes	15
4.1 Time Code Format A.....	15
4.2 Time Code Format B.....	15
4.3 Time Code Format D	16
4.4 Time Code Format E	16
4.5 Time Code Format G.....	16
4.6 Time Code Format H.....	17
5.0 Detailed Description of Time Codes	17
5.1 Format A, Signal A000.....	17
5.2 Format B, Signal B000	19
5.3 Format D, Signal D001.....	24
5.4 Format E, Signal E001	27
5.5 Format G, Signal G001	30
5.6 Format H, Signal H001.....	33

APPENDIXES

Page

A	Leap Year/Leap Second Convention	A-1
B	BCD Count/Binary Count.....	B-1
C	Time Code Generator Hardware Design Considerations	C-1

LIST OF FIGURES

1.	Typical modulated carrier signal.....	7
2.	IRIG-B coding comparisons: level shift, 1kHz am, and Modified Manchester.....	13
3.	Modified Manchester Coding	14
4.	Format A: BCD time-of-year in days, hours, minutes, seconds, and fractions of seconds; straight binary seconds-of-day plus optional control bits	18
5.	Format B: BCD time-of-year in days, hours, minutes, and seconds; straight binary seconds-of-day plus optional control bits	21
6.	Format D: BCD time-of-year in days and hours plus optional control Bits	25
7.	Format E: BCD time-of-year in days, hours, minutes, and seconds plus optional control bits	28
8.	Format G: BCD time-of-year in days, hours, minutes, seconds and fractions of seconds plus optional control bits	31
9.	Format H: BCD time-of-year in days, hours and minutes plus optional control bits	34

LIST OF TABLES

1.	Typical modulated carrier signal.....	8
2.	Format A: Signal A000	20
3.	Format B: Signal B000	23
4.	Format D: Signal D001	26
5.	Format E: Signal E001.....	29
6.	Format G: Signal G001	32
7.	Format H: Signal H001	35

ABBREVIATIONS AND TERMS

<u>ABBREVIATION</u>	<u>TERM</u>
CF	Control Function
Hz	an abbreviation for Hertz (cycles per second)
kHz	kilohertz (1000 Hz)
fph	frames per hour
fpm	frames per minute
fps	frames per second
pph	pulses per hour
ppm	pulses per minute
pps	pulses per second
y	year
mo	month
d	day
h	hour
m	minute
s	second
ms	millisecond (10^{-3} s)
1s	microsecond (10^{-6} s)
ns	nanosecond (10^{-9} s)
DoY	day-of-year
DoM	day-of-month
HoD	hour-of-day
MoH	minutes-of-hour
SoD	seconds-of-day (86.4×10^3)
MoD	milliseconds-of-day (86.4×10^6)
MioD	microseconds-of-day (86.4×10^9)
BCD	binary coded decimal
SBS	straight binary second(s)
SB	straight binary
LSB	least significant bit
MSB	most significant bit

DEFINITIONS

The following terms are defined as they are used in this document.

ACCURACY -- Systematic uncertainty (deviation) of a measured value with respect to a standard reference.

BINARY CODED DECIMAL (BCD) -- A numbering system which uses decimal digits encoded in a binary representation ($1n\ 2n\ 4n\ 8n$) where $n=1, 10, 100, 1\ k, 10\ k\dots N$ (see appendix B).

BINARY NUMBERING SYSTEM (Straight Binary) -- A numbering system which has two as its base and uses two symbols, usually denoted by 0 and 1 (see appendix B).

BIT -- An abbreviation of binary or binary-coded decimal digits which forms each subword and which determines the granularity or resolution of the time code word.

FRAME RATE -- The repetition rate of the time code.

INDEX COUNT -- The number which identifies a specific bit position with respect to a reference marker.

INDEX MARKERS -- Uncoded, periodic, interpolating bits in the time code.

INSTRUMENTATION TIMING -- A parameter serving as the fundamental variable in terms of which data may be correlated.

LEAP SECOND -- See appendix A.

LEAP YEAR -- See appendix A.

ON-TIME -- The state of any bit being coincident with a Standard Time Reference (U.S. Naval Observatory or National Bureau of Standards or other national laboratory).

ON-TIME REFERENCE MARKER -- The leading edge of the reference bit P_r of each time frame.

POSITION IDENTIFIER -- A particular bit denoting the position of a portion or all of a time code.

PRECISION -- An agreement of measurement with respect to a defined value.

DEFINITIONS (CONT'D)

REFERENCE MARKER -- A periodic combination of bits which establishes that instant of time defined by the time code word.

RESOLUTION (of a time code) -- The smallest increment of time or least significant bit which can be defined by a time code word or subword.

SECOND -- Basic unit of time or time interval in the International System of Units (SI) which is equal to 9 192 631 770 periods of radiation corresponding to the transition between the two hyperfine levels of the ground state of Cesium 133.

SUBWORD -- A subdivision of the time code word containing only one type of time unit, for example, days, hours, seconds or milliseconds.

TIME -- Signifies epoch, that is, the designation of an instant of time on a selected time scale such as astronomical, atomic or UTC.

TIME CODE -- A system of symbols used for identifying specific instants of time.

TIME CODE WORD -- A specific set of time code symbols which identifies one instant of time. A time code word may be subdivided into subwords.

TIME FRAME -- The time interval between consecutive reference markers that contains all the bits that determine the time code format.

TIME INTERVAL -- The duration between two instants read on the same time scale, usually expressed in seconds or in a multiple or submultiple of a second.

TIME REFERENCE -- The basic repetition rate chosen as the common time reference for all instrumentation timing (usually 1 pps).

TIME T_0 -- The initial time 0^h 0^m 0^s January 1 or the beginning of an epoch.

GLOSSARY OF SELECTED TIME TERMS

These definitions of time-related terms are useful in understanding the text of the standard and the relationship between the various time scales.

COORDINATED UNIVERSAL TIME (UTC) -- is maintained by the Bureau International de l'Heure (BIH) which forms the basis of a coordinated dissemination of standard frequencies and time signals. A UTC clock has the same rate as a TAI clock, but differs by an integral number of seconds. The step-time adjustments are called "leap seconds." Leap seconds are subtracted or added to UTC to keep in synchronism with UT1 to within ± 0.9 seconds (see appendix A).

DUT1 -- is the predicted difference between UT1 and UTC and is given by $DUT1 = UT1 - UTC$.

EPHEMERIS TIME (ET) -- is obtained from observations of the motion of the moon about the earth.

EPOCH -- signifies the beginning of an event.

INTERNATIONAL ATOMIC TIME (TAI) -- is atomic time scale based on data from a worldwide set of clocks and is the internationally agreed to time reference. The TAI is maintained by the BIH, Paris, France. Its epoch was set such that TAI was in approximate agreement with UT1 on 1 January 1958.

INTERNATIONAL ATOMIC TIME (TAI) TIME CODE -- represents a binary count of elapsed time in seconds since the 1 January 1958 epoch. The Bureau International de l'Heure (BIH), the U.S. Naval Observatory (USNO), and other national observatories and laboratories maintain this count which accumulates at 86,400 seconds per day.

SIDEREAL TIME -- is determined and defined by observations of the earth with respect to the stars. A mean sidereal day is approximately $23^{\text{h}} 56^{\text{m}} 4.09^{\text{s}}$. A solar year contains 366.24 sidereal days.

SOLAR TIME -- is based on the rotation of the earth about the sun.

TIME SCALE -- is a reference system for specifying occurrences with respect to time.

GLOSSARY OF SELECTED TIME TERMS (CONT'D)

UNIVERSAL TIME (UT) -- is the mean solar time of the prime meridian plus 12^h, determined by measuring the angular position of the earth about its axis. The UT is sometimes designated GMT, but this designation should be avoided. The official U.S. Naval Observatory designation is "Z" or Zulu for UT.

UT0 -- measures UT with respect to the observer's meridian (position on earth) which varies because of the conical motion of the poles.

UT1 -- is UT0 corrected for variations in the polar motion and is proportional to the rotation of the earth in space. In its monthly bulletin, Circular-D, the Bureau International de l'Heure (BIH) publishes the current values of UT1 with respect to International Atomic Time (TAI).

UT2 -- is UT1 corrected empirically for annual and semiannual variations of the rotation rate of the earth. The maximum correction is about 30 ms.

INTRODUCTION

Modern day electronic systems such as communication systems, data handling systems, missile and spacecraft tracking, and telemetry systems require time-of-day information for data correlation with time. Parallel and serial formatted time codes are used to efficiently interface the timing system (time-of-day source) to the user system. Parallel time codes are defined in IRIG Standard 205-87. Standardization of time codes is necessary to ensure system compatibility among the various ranges, ground tracking networks, spacecraft and missile projects, data reduction and processing facilities, and international cooperative projects.

This standard defines the characteristics of six serial time codes presently used by U.S. Government agencies and private industry. Four new combinations have been added to the list of standard formats: A002, A132, B002, and B122. Moreover, this standard reflects the state of the art and is not intended to constrain proposals for new serial time codes with greater resolution.

1.0 GENERAL DESCRIPTION OF STANDARD

This standard consists of a family of rate-scaled serial time codes with formats containing up to three-coded expressions or words. The first word of the time-code frame is time-of-year in binary coded decimal (BCD) notation in days, hours, minutes, seconds, and fractions of seconds depending on the code-frame rate. The second word is a set of bits reserved for encoding of various control, identification, and other special purpose functions. The third word is seconds-of-day weighted in straight binary seconds (SBS) notation.

Manufacturers of time code generating equipment today do not include the seconds-of-day code or the control bits in their design of IRIG serial time code generators. Fill bits of all 0s are added to achieve the desired frame length and code repetition rate. If the user desires the SBS code or control bits, it must be specified (see section 3 for standard code formats).

2.0 GENERAL DESCRIPTION OF FORMATS

An overview of the formats is described in the following subparagraphs.

2.1 Pulse Rise Time

The specified pulse (dc level shift bit) rise time shall be obtained between the 10 and 90 percent amplitude points (see appendix C).

2.2 Jitter

The modulated code is defined as ≤ 1 percent at the carrier frequency. The dc level shift code is defined as the pulse-to-pulse variation at the 50 percent amplitude points on the leading edges of successive pulses or bits (see appendix C).

2.3 Bit Rates and Index Count

Each pulse in a time code word/subword is called a bit. The "on-time" reference point for all bits is the leading edge of the bit. The repetition rate at which the bits occur is called the bit rate. Each bit has an associated numerical index count identification. The time interval between the leading edge of two consecutive bits is the index count interval. The index count begins at the frame reference point with index count 0 and increases one count each index count until the time frame is complete.

The bit rates and index count intervals of the time code formats are

Format	Bit Rate	Index Count Interval
A	1 kpps	1 millisecond
B	100 pps	10 milliseconds
D	1 ppm	1 minute
E	10 pps	0.1 second
G	10 kpps	0.1 millisecond
H	1 pps	1 second

2.4 Time Frame, Time Frame Reference, and Time Frame Rates

A time code frame begins with a frame reference marker P_0 (position identifier) followed by a reference bit P_r with each having a duration equal to 0.8 of the index count interval of the respective code. The on-time reference point of a time frame is the leading edge of the reference bit P_r . The repetition rate at which the time frames occur is called the time frame rate.

The time frame rates and time frame intervals of the formats are

Format	Time Frame Rate	Time Frame Interval
A	10 fps	0.1 second
B	1 fps	1 second
D	1 fph	1 hour
E	6 fpm	10 seconds
G	100 fps	10 ms
H	1 fpm	1 minute

2.5 Position Identifiers

Position identifiers have a duration equal to 0.8 of the index count interval of the respective code. The leading edge of the position identifier P_0 occurs one index count interval before the frame reference point P_r and the succeeding position identifiers ($P_2, P_2...P_0$) occur every succeeding tenth bit. The repetition rate at which the position identifiers occur is always 0.1 of the time format bit rate.

2.6 Time Code Words

The two time code words employed in this standard are

BCD time-of-year
SBS time-of-day (seconds-of-day)

All time code formats are pulse-width coded. A binary (1) bit has a duration equal to 0.5 of the index count interval, and a binary (0) bit has a duration equal to 0.2 of the index count interval. The BCD time-of-year code reads 0 hours, minutes, seconds, and fraction of seconds at 2400 each day and reads day 001 at 2400 of day 365 or day 366 (leap year). The SBS time-of-day code reads 0 seconds at 2400 each day excluding leap second days when a second may be added or subtracted. Coordinated Universal Time (UTC) is generated for all interrange applications.

2.7 BCD Time-of-Year Code Word

The BCD time-of-year code word consists of subwords in days, hours, minutes, seconds, and fractions of a second encoded in a binary representation ($1n\ 2n\ 4n\ 8n$) where $n=1, 10, 100, 1\ k\dots N$. Time code digit values less than N are considered zero and are encoded as a binary 0.

The position identifiers preceding the decimal digits and the index count locations of the decimal digits (if present) are

BCD Code Decimal Digits	Decimal Digits Follow Position Identifier	Digits Occupy Index Count Positions
Units of Seconds Tens of Seconds	P_0	1-4 6-8
Units of Minutes Tens of Minutes	P_1	10-13 15-17
Units of Hours Tens of Hours	P_2	20-23 25-26
Units of Days Tens of Days	P_2	30-33 35-38
Hundreds of Days Tenths of Seconds	P_4	40-41 45-48
Hundredths of Seconds	P_5	50-53

Format A and B include an optional straight binary seconds-of-day (SBS) time code word in addition to the BCD time-of-year time code word. The SBS word follows position identifier P₈ beginning with the least significant binary bit (2⁰) at index count 80 and progressing to the most significant binary bit (2¹⁶) at index count 97 with a position identifier P₉ occurring between the ninth (2⁸) and tenth (2⁹) binary bits.

2.8 Control Functions

All time code formats reserve a set of bits known as control functions (CF) for the encoding of various control, identification, or other special purpose functions. The control bits may be programmed in any predetermined coding system. A binary 1 bit has a duration equal to 0.5 of the index count interval, and a binary (0) has a duration equal to 0.2 of the index count interval. Control function bits follow position identifier P₅ or P₆ beginning at index count 50 or 60 with one control function bit per index count, excepting each tenth bit which is a position identifier. The number of available control bits in each time code format are

Format	Control Functions
A	27
B	27
D	9
E	45
G	36
H	9

Control functions are presently intended for intrarange use but not for interrange applications; therefore, no standard coding system exists. The inclusion of control functions into a time code format as well as the coding system employed is an individual user defined option.

2.9 Index Markers

Index markers occur at all index count positions which are not assigned as a reference marker, position identifier, code, or control function bit. Index marker bits have a duration equal to 0.2 of the index count interval of the respective time code format.

2.10 Amplitude Modulated Carrier

A standard sine wave carrier frequency to be amplitude modulated by a time code is synchronized to have positive-going, zero-axis crossings coincident with the leading edges of the modulating code bits. A mark-to-space ratio of 10:3 is standard with a range of 3:1 to 6:1 (see figure 1 and table 1, Typical Modulated Carrier Signals).

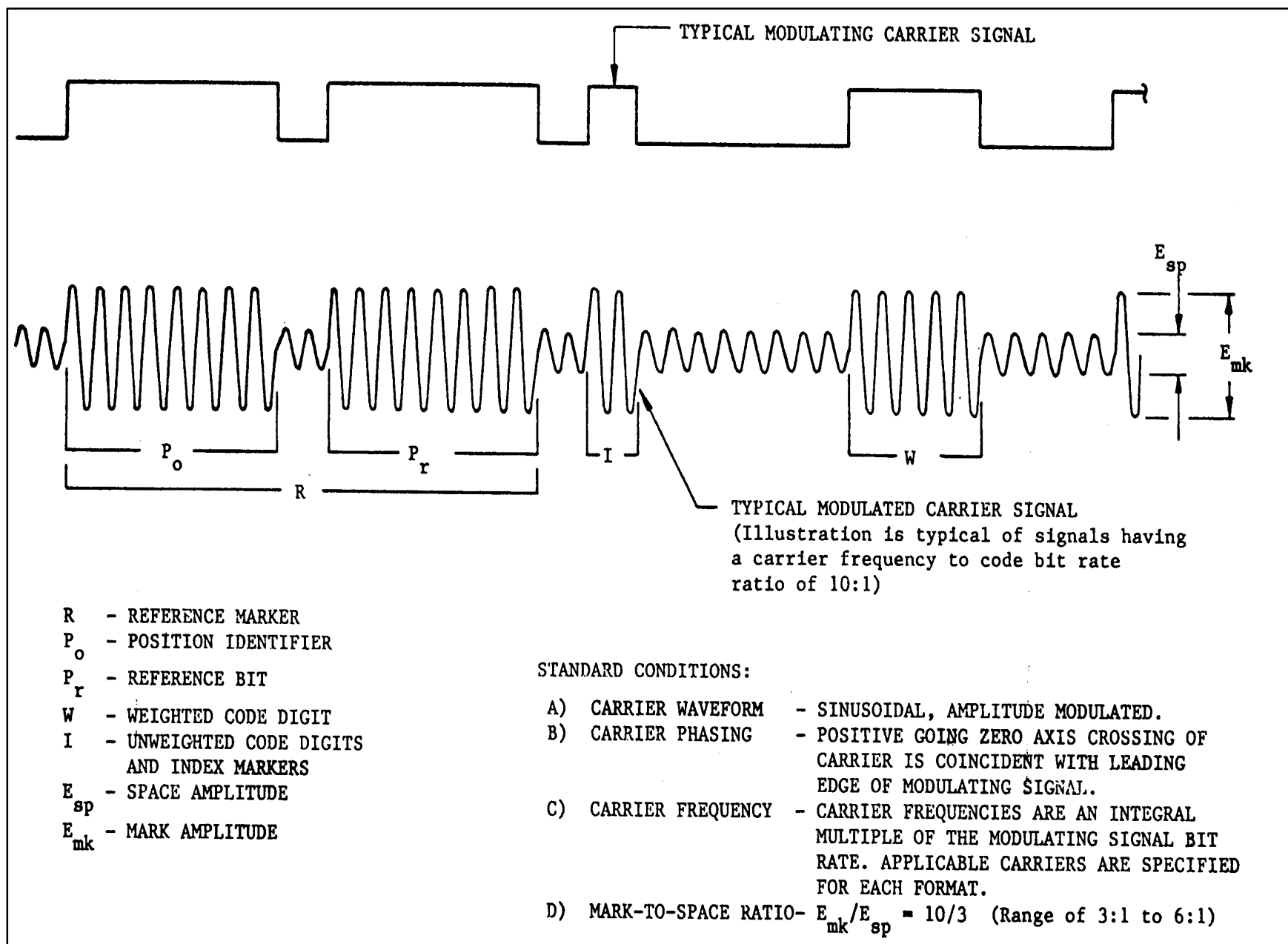

Figure 1. Typical modulated carrier signal.

TABLE 1. TYPICAL MODULATED CARRIER SIGNAL

					MARK INTERVAL NUMBER OF CYCLES			
FORMAT	SIGNAL NO.	TIME FRAME RATE	CARRIER FREQUENCY F	SIGNAL BIT RATE ER	RATIO F/ER	CODE "0" & INDEX	CODE "1"	POSITION IDENTIFIER & REF.
A	A130,132 133	10 per sec.	10 kHz	1 kpps	10:1	2	5	8
B	B120,122 123	1 per sec.	1 kHz	100 pps	10:1	2	5	8
D	D111, 112 121,122	1 per hr.	100 Hz 1 kHz	1 ppm 1 ppm	6000:1 60000:1	1200 12000	3000 30000	4800 48000
E	E111,112 121,122	6 per min.	100 Hz 1 kHz	10 pps 10 pps	10:1 100:1	2 20	5 50	8 80
G	G141,142	100 per sec.	100 kHz	10 kpps	10:1	2	5	8
H	H111,112 121,122	1 per min.	100 Hz 1 kHz	1 pps 1 pps	100:1 1000:1	20 200	50 500	80 800

3.0 DETAILED DESCRIPTION OF FORMATS

The family of rate scaled serial time code formats is alphabetically designated A, B, D, E, G, and H. Various combinations of subwords and signal forms make up a time code word. All formats do not contain each standard coded expression, and various signal forms are possible. To differentiate between these forms, signal identification numbers are assigned to each permissible combination according to the following procedure.

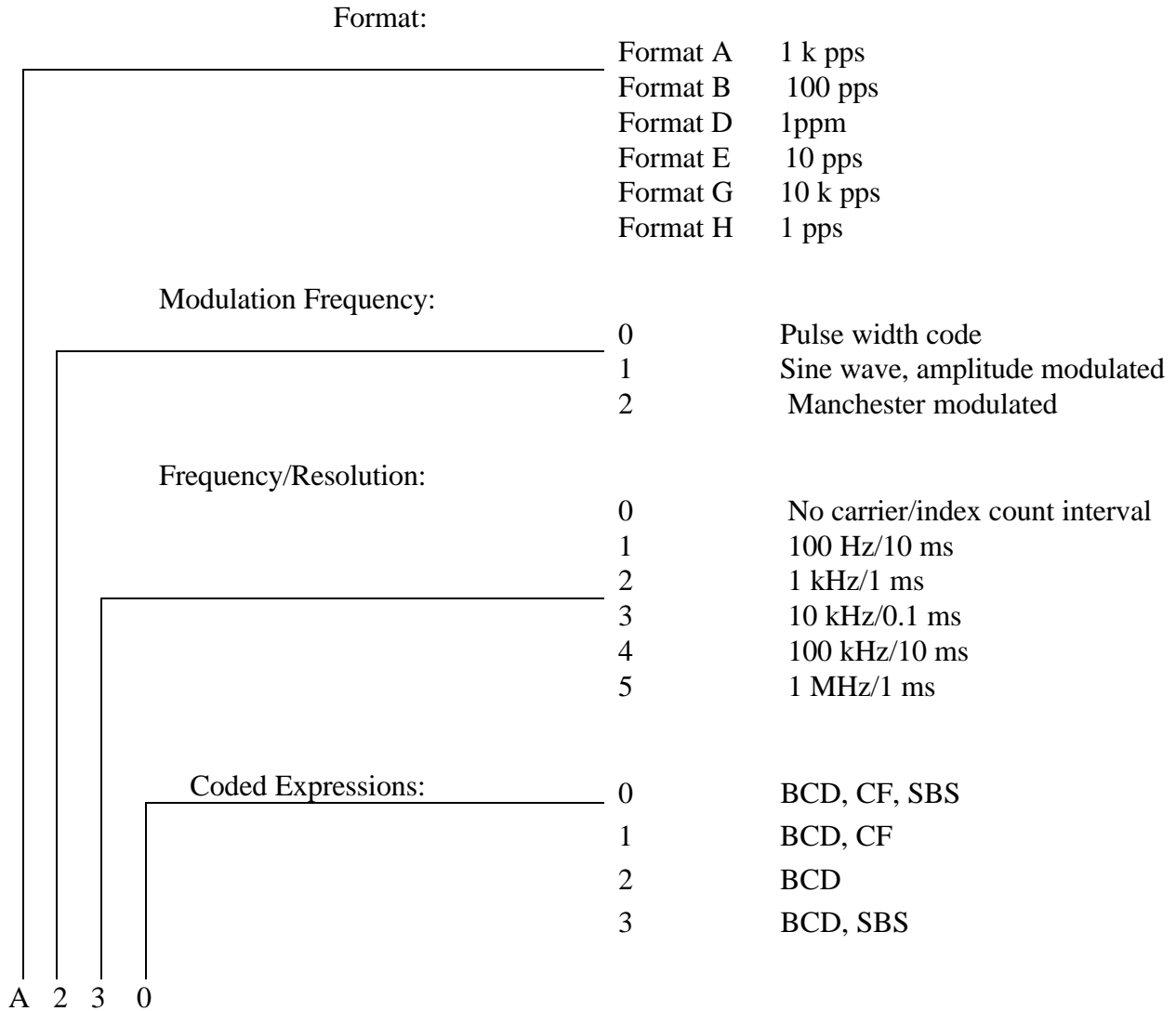

The resolution of a time code is that of the smallest increment of time or the least significant bit which can be defined by a time code word or subword. The accuracy of a modified, Manchester time code can be determined by the risetime of the on-time pulse in the Manchester code which marks the beginning of the on-time one-pulse-per-second as shown in Figure 1. The accuracy can be milliseconds to nanoseconds or better depending on equipment and measurement

technique. For the case of the unmodulated Manchester codes, the Position Marker, PO, which marks the beginning of the second can be used.

The following chart shows the permissible code formats. Codes D, E and H remain unchanged. Codes A, B and G have changed to permit 1MHz and Manchester modulation as indicated in the chart shown below. No other combinations are standard.

FORMAT	MODULATION FREQUENCY	FREQUENCY/ RESOLUTION	CODED EXPRESSIONS
A	0,1,2	0,3,4,5	0,1,2,3
B	0,1,2	0,2,3,4,5	0,1,2,3
D	0,1	0,1,2	1,2
E	0,1	0,1,2	1,2
G	0,1,2	0,4,5	1,2
H	0,1	0,1,2	1,2

EXAMPLES:

Signal A 1 3 0 : Format A, amplitude modulated, 10 kHz carrier/0.1 ms resolution, containing BCD, CF and SBS code expressions.

Signal A 2 4 3 : Format A, Manchester modulated, 100 kHz carrier/10 ms resolution, containing BCD and SBS code expressions.

Signal B 0 0 3 : Format B, pulse-width coded, dc level shift/10 ms resolution, containing BCD and SBS code expressions

Signal H 1 2 2 : Format H, amplitude modulated, 1 kHz carrier/1 ms resolution, containing BCD code expression.

The Telecommunications and Timing Group (TTG) of the Range Commanders Council (RCC) has adopted a Modified Manchester modulation technique as an option for the IRIG serial time codes A, B, and G as an addition to the standard AM modulation and level shift modulation now permitted.

It should be noted that at present, the assignment of control bits (control functions) to specific functions in the IRIG serial time codes is left to the end-user of the time codes. However, since none of the IRIG codes have a “year” designation in their formats, (“day-of-year” but not “year”),

the TTG is looking at the possibility of adding “year” to specific codes such as IRIG-A to accommodate the “year 2000” rollover. As an example, for IRIG-A, selected control bits between P50 and P80 would be assigned for the “year” designation. Codes being considered are IRIG A, B, E, and G.

MANCHESTER II CODING

Standard Manchester modulation or encoding is a return-to-zero type, where a rising edge in the middle of the clock window indicates a binary one (1) and a falling edge indicates a binary zero (0). This modification to the Manchester code shifts the data window so the data are at the edge of the clock window which is on-time with the one-pulse-per-second clock Universal Time Coordinated (UTC). Thus, the data edge is the on-time mark in the code. This code is easy to generate digitally, easy to modulate onto fiber or coaxial cable, simple to decode, and has a zero mean, thus it is easy to detect even at low levels.

Figures 2 and 3 show the basic Modified Manchester modulation, compared with the AM and level shift modulations. The Manchester encoding uses a square-wave as the encoding (data) clock, with the rising edge on-time with UTC. The frequency of the encoding clock shall be ten times the index rate of the time code generated. Example: The clock rate for IRIG B230 will be 10 kHz.

This modulation technique has several advantages: no dc component, can be ac coupled, better signal-to-noise ratio, good spectral power density, easily decoded, and has better timing resolution. Also, the link integrity monitoring capability is intrinsic to bipolar pulse modulation. The Modified Manchester coding technique is designed to operate over fiber-optic or coaxial lines for short distances.

MANCHESTER II DECODING

A Manchester II encoded sequence is shown below, where each symbol is “subbit” encoded, i.e., a data one equals a zero-one, and a data zero equals a one-zero:

A Manchester II Encoded Sequence

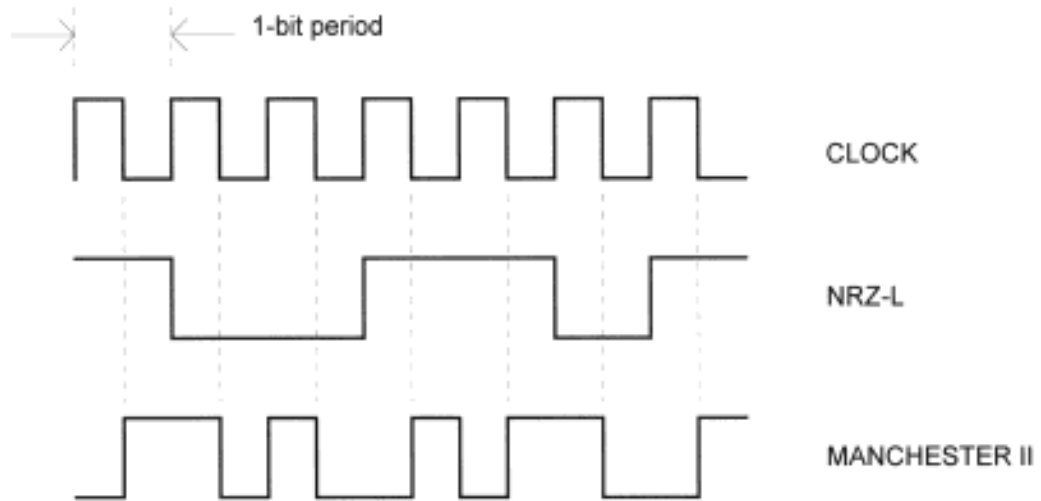

The above encoded sequence is formed by modulo-2 adding the NRZ-L sequence with the clock. The truth table is shown below for a modulo-2 adder, i.e., an Exclusive-Or (XOR):

INPUT A	INPUT B	OUTPUT
0	0	0
0	1	1
1	0	1
1	1	0

To decode the encoded sequence, it is only necessary to modulo-2 add the clock with the encoded sequence and the original NRZ-L sequence results. It should be noted that the bit determination is made after integrating across a bit period. In this way, the maximum amount of bit energy is used in the determination of each bit. Likewise, one could have integrated or sampled both halves of the encoded sequence, and reconstructed the original NRZ-L sequence by applying the encoding rule; that is, if sampled halves are 0-1, then a data 1 is reconstructed, or if the sampled halves are 1-0, then a data 0 is reconstructed. Once again, as much energy as possible is used from the encoded sequence to reconstruct the original NRZ-L sequence. This procedure minimizes the probability of error.

NOTE: When the above procedure is used, the reconstructed data are coherent with the clock; that is, the NRZ-L data transitions will agree with the positive going edge of the clock. However, since the decisions are made at the end of the symbol period, the reconstructed NRZ-L data are delayed one clock period which means that when the entire time is received, the received time code or local clock needs to be advanced by one clock period. Also, if desired, one can correct the receive clock for significant signal propagation delays.

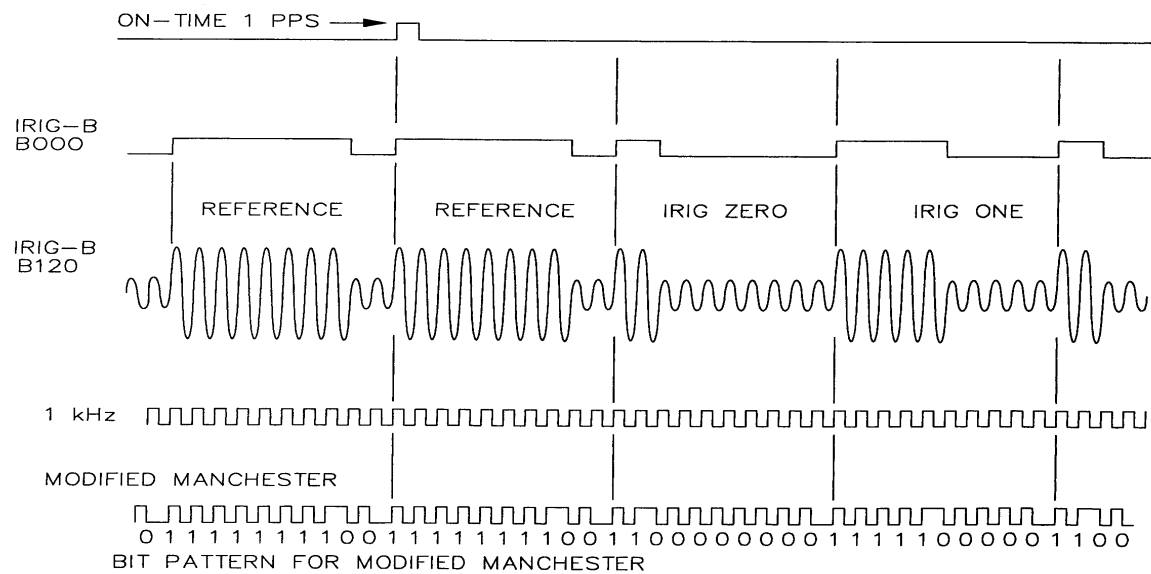

Figure 2. IRIG-B coding comparisons: level shift, 1kHz am, and Modified Manchester.

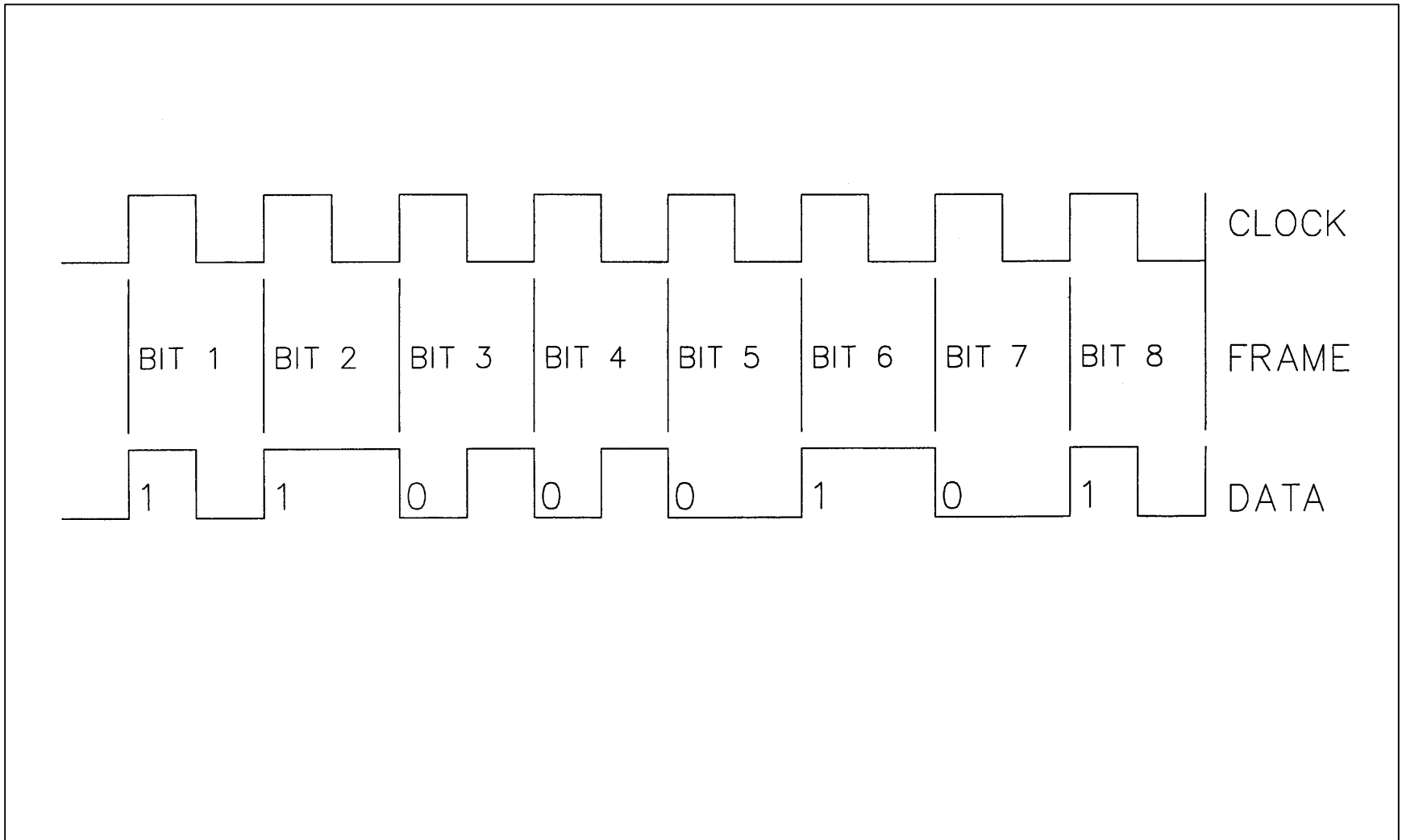

Figure 3. Modified Manchester Coding.

4.0 GENERAL DESCRIPTION OF TIME CODES

A general description of individual time code formats is described in the following subparagraphs.

4.1 Time Code Format A

4.1.1 The 78-bit time code contains 34 bits of binary coded decimal (BCD) time-of-year information in days, hours, minutes, seconds, and tenths of seconds; 17 bits of straight binary seconds-of-day (SBS) and 27 bits for control functions.

4.1.2 The BCD code (seconds subword) begins at index count 1 (LSB first) with binary coded bits occurring between position identifiers P_0 and P_5 : 7 for seconds, 7 for minutes, 6 for hours, 10 for days, and 4 for tenths of seconds to complete the BCD word. An index marker occurs between the decimal digits in each subword, except for the tenths of seconds, to provide separation for visual resolution. The BCD time code word recycles yearly.

4.1.3 The SBS word begins at index count 80 and is between position identifiers P_8 and P_0 with a position identifier bit (P_9) between the 9th and 10th binary SBS coded bits. The SBS time code recycles each 24-hour period.

4.1.4 The control bits occur between position identifiers P_5 and P_8 with a position identifier occurring every 10 bits.

4.1.5 The frame rate or repetition rate is 0.1 second with resolutions of 1 ms (dc level shift) and 0.1 ms (modulated 10 kHz carrier).

4.2 Time Code Format B

4.2.1 The 74-bit time code contains 30 bits of BCD time-of-year information in days, hours, minutes, and seconds; 17 bits of SB seconds-of-day; and 27 bits for control functions.

4.2.2 The BCD code (seconds subword) begins at index count 1 (LSB first) with binary coded bits occurring between position identifier bits P_0 and P_5 : 7 for seconds, 7 for minutes, 6 for hours, and 10 for days, to complete the BCD word. An index marker occurs between the decimal digits in each subword to provide separation for visual resolution. The BCD time code recycles yearly.

4.2.3 The SBS word begins at index count 80 and is between position identifiers P_8 and P_0 with a position identifier bit (P_9) between the 9th and 10th binary SBS coded bits. The SBS time code recycles each 24 hour period.

4.2.4 The control bits occur between position identifiers P_5 and P_8 , with a position identifier every 10 bits.

4.2.5 The frame rate is 1.0 second with resolutions of 10 ms (dc level shift) and 1 ms (modulated 1 kHz carrier).

4.3 Time Code Format D

4.3.1 The 25-bit time code contains 16 bits of BCD time-of-year information in days, hours, and minutes, and 9 bits for control functions.

4.3.2 The BCD code (hours subword) begins at index count 20 (LSB first) with binary coded bits occurring between position identifier bits P_2 and P_5 : 6 for hours and 10 for days to complete the BCD word. An index marker occurs between the decimal digits in each subword for visual resolution. The time code recycles yearly.

4.3.3 The control bits occur between position identifiers P_5 and P_0 .

4.3.4 The frame rate is one hour with resolutions of 1 minute (dc level shift), 10 ms (modulated 100 Hz carrier) and 1 ms (modulated 1 kHz carrier).

4.4 Time Code Format E

4.4.1 The 71-bit time code contains 26 bits of BCD time-of-year information in days, hours, minutes, and seconds, and 45 bits for control functions.

4.4.2 The BCD code (seconds subword) begins at index count 6 (LSB first). Binary coded bits occur between position identifier bits P_0 and P_5 : 3 for tens of seconds, 7 for minutes, 6 for hours, and 10 for days to complete the BCD word. An index marker occurs between the decimal digits in each subword to provide for visual resolution. The time code recycles yearly.

4.4.3 The control bits occur between position identifiers P_5 and P_0 .

4.4.4 The frame rate is 10 seconds with resolutions of 0.1 second (dc level), 10 ms (modulated 100 Hz carrier) and 1 ms (modulated 1 kHz carrier). The time code recycles yearly.

4.5 Time Code Format G

4.5.1 The 74-bit time code contains 38 bits of BCD time-of-year information in days, hours, minutes, seconds, and fractions of seconds, and 36 bits for control functions.

4.5.2 The BCD code (seconds subword) begins at index count 1 (LSB first). Binary coded bits occur between position identifier bits P_0 and P_6 : 7 for seconds, 7 for minutes, 6 for hours, 10 for days, 4 for tenths of seconds, and 4 for hundredths of seconds to complete the BCD word. An index marker occurs between the decimal digits in each subword (except fractional seconds) to provide for resolution. The time code recycles yearly.

4.5.3 The control bits occur between position identifiers P_6 and P_0 .

4.5.4 The frame rate is 10 ms with resolutions of 0.1 ms (dc level shift) and 10 μ s (modulated 100 kHz carrier). The time code recycles yearly.

4.6 Time Code Format H

4.6.1 The 32-bit time code word contains 23 bits of BCD time-of-year information in days, hours, and minutes and 9 bits for control functions.

4.6.2 The BCD code (minutes subword) begins at index count 10 (LSB first) with binary coded bits occurring between position identifier bits P_1 and P_5 : 7 for minutes, 6 for hours, and 10 for days to complete the BCD word. An index marker occurs between decimal digits in each subword to provide separation for visual resolution. The time code recycles yearly.

4.6.3 The control bits occur between position identifiers P_5 and P_0 .

4.6.4 The frame rate is 1 minute with resolutions of 1 second (dc level shift), 10 ms (modulated 100 Hz carrier) and 1 ms (modulated 1 kHz carrier).

5.0 DETAILED DESCRIPTION OF TIME CODES

A detailed description of individual time code formats is described in the following paragraphs.

5.1 Format A, Signal A000

5.1.1 The beginning of each 0.1 second time frame is identified by two consecutive 0.8 ms bits, P_0 and P_r . The leading edge of P_r is the on-time reference point for the succeeding time code words. Position identifiers, P_0 and P_1 through P_9 , (0.8 ms duration) occur every 10th bit and 1 ms before the leading edge of each succeeding 100 pps "on-time" bit (see figure 4).

5.1.2 The two time code words and the control functions presented during the time frame are pulse width coded. The binary zero and index markers have a duration of 0.2 ms, and the binary one has a duration of 0.5 ms. The 1 k pps leading edge is the on-time reference point for all bits.

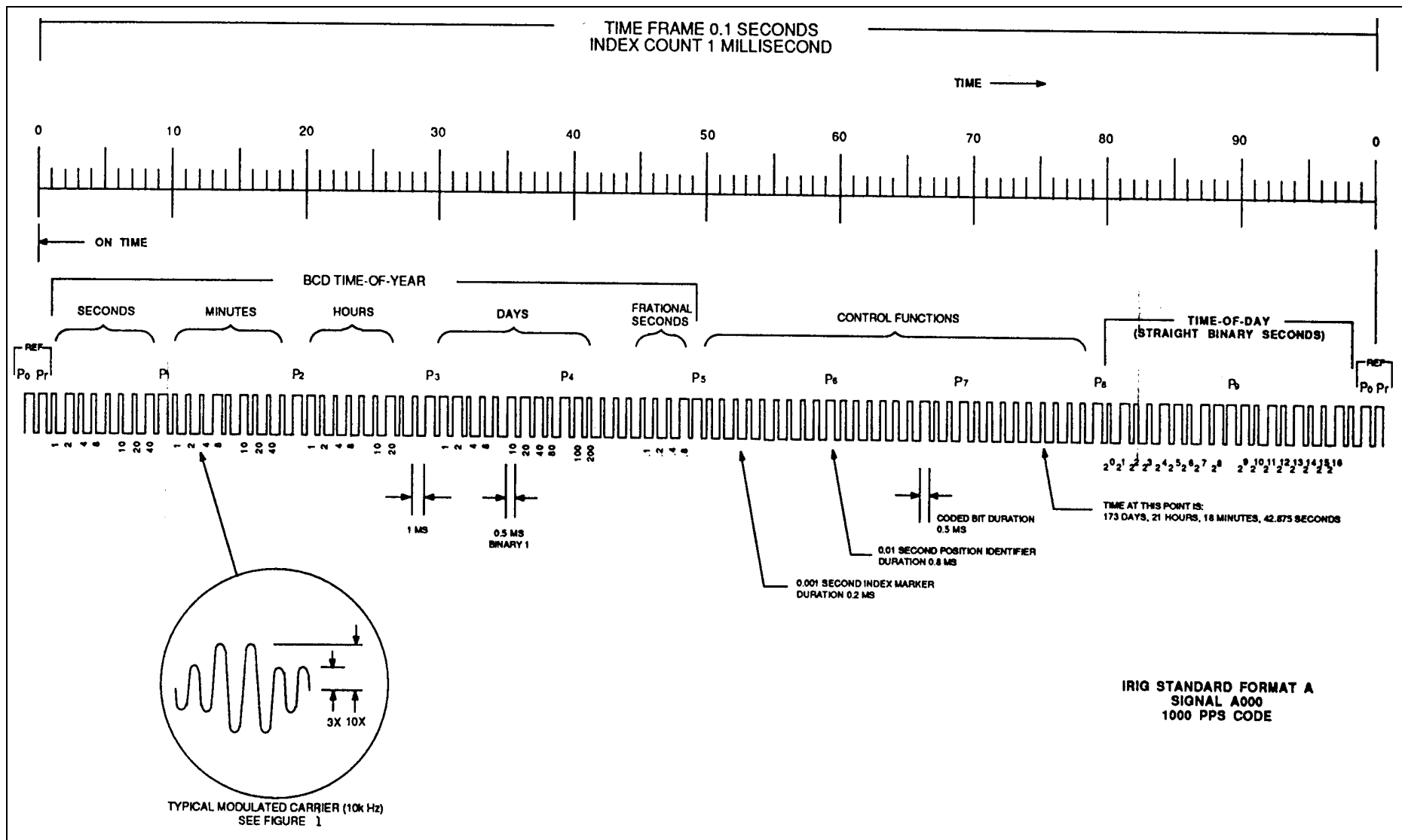

Figure 4. Format A: BCD time-of-year in days, hours, minutes, seconds, and fractions of seconds; straight binary seconds-of-day plus optional control bits.

5.1.3 The binary coded decimal (BCD) time-of-year code word consists of 34 bits beginning at index count one. The binary coded subword bits occur between position identifiers P_0 and P_5 : 7 for seconds, 7 for minutes, 6 for hours, 10 for days, and 4 for tenths of seconds to complete the time code word. An index marker occurs between the decimal digits in each subword, except tenths of seconds, to provide separation for visual resolution. The LSB occurs first except for the fractional seconds subword which follows the day-of-year subword. The BCD code recycles yearly. Each BCD bit position is identified on the time-of-year chart shown in table 2.

5.1.4 Twenty-seven control bits occur between position identifiers P_5 and P_8 . Any control function bit or combination of bits can be programmed to read a binary one or a binary zero during any specified number of time frames. Each control bit position is identified as shown in table 2.

5.1.5 The straight binary (SB) seconds-of-day code word occurs at index count 80 between position identifiers P_8 and P_0 . Seventeen bits give time-of-day in seconds with the LSB occurring first. A position identifier occurs between the 9th and 10th binary coded bits. The code recycles each 24-hour period. Each bit position is identified in table 2.

5.1.6

Pulse Rates	Pulse Duration
Bit rate: 1 k pps Position identifier rate: 100 pps Reference marker: 10 pps	Index marker: 0.2 ms Binary zero or uncoded bit: 0.2 ms Binary one or coded bit: 0.5 ms Position identifiers: 0.8 ms Reference bit: 0.8 ms

Resolution	Mark-To-Space Ratio
1 ms dc level 0.1 ms modulated 10 kHz carrier	Nominal value of 10:3 Range of 3:1 to 6:1

5.2 Format B, Signal B000

5.2.1 The beginning of each 1.0 second time frame is identified by two consecutive 8.0 ms bits, P_0 and P_r . The leading edge of P_r is the on-time reference point for the succeeding time code words. Position identifiers, P_0 and P_1 through P_9 , (8 ms duration) occur every 10th bit and 10 ms before the leading edge of each succeeding 10 pps "on-time" bit (see figure 5).

TABLE 2. FORMAT A,SIGNAL A000

BCD TIME-OF-YEAR CODE (34 DIGITS)

SECONDS SUBWORD			MINUTES SUBWORD			HOURS SUBWORD			DAYS AND FRACTIONAL SECOND SUBWORDS					
BCD Code Digit No.	Subword Digit Wt SECONDS	BIT Time (Note 1)	BCD Code Digit No.	Subword Digit Wt MINUTES	BIT Time	BCD Code Digit No.	Subword Digit Wt HOURS	BIT Time	BCD Code Digit No.	Subword Digit Wt DAYS	BIT Time	BCD Code Digit No.	Subword Digit Wt DAYS	BIT Time
Reference BIT		P _r	8	1	P _r + 10 ms	15	1	P _r + 20 ms	21	1	P _r + 30 ms	29	100	P _r + 40 ms
1	1	P _r + 1 ms	9	2	P _r + 11 ms	16	2	P _r + 21 ms	22	2	P _r + 31 ms	30	200	P _r + 41 ms
2	2	P _r + 2 ms	10	4	P _r + 12 ms	17	4	P _r + 22 ms	23	4	P _r + 32 ms	Index BIT		P _r + 42 ms
3	4	P _r + 3 ms	11	8	P _r + 13 ms	18	8	P _r + 23 ms	24	8	P _r + 33 ms	Index BIT		P _r + 43 ms
4	8	P _r + 4 ms	Index BIT		P _r + 14 ms	Index BIT		P _r + 24 ms	Index BIT		P _r + 34 ms	Index BIT		P _r + 44 ms
Index BIT		P _r + 5 ms	12	10	P _r + 15 ms	19	10	P _r + 25 ms	25	10	P _r + 35 ms	31	0.1	P _r + 45 ms
5	10	P _r + 6 ms	13	20	P _r + 16 ms	20	20	P _r + 26 ms	26	20	P _r + 36 ms	32	0.2	P _r + 46 ms
6	20	P _r + 7 ms	14	40	P _r + 17 ms	Index BIT		P _r + 27 ms	27	40	P _r + 37 ms	33	0.4	P _r + 47 ms
7	40	P _r + 8 ms	Index BIT		P _r + 18 ms	Index BIT		P _r + 28 ms	28	80	P _r + 38 ms	34	0.8	P _r + 48 ms
Position Ident. (P ₁)		P _r + 9 ms	Position Ident. (P ₂)		P _r + 19 ms	Position Ident. (P ₃)		P _r + 29 ms	Position Ident. (P ₄)		P _r + 39 ms	Position Ident. (P ₅)		P _r + 49 ms

CONTROL FUNCTIONS (27 BITS)

Control Function BIT	BIT Time	Control Function BIT	BIT Time	Control Function BIT	BIT Time
1	P _r + 50 ms	10	P _r + 60 ms	19	P _r + 70 ms
2	P _r + 51 ms	11	P _r + 61 ms	20	P _r + 71 ms
3	P _r + 52 ms	12	P _r + 62 ms	21	P _r + 72 ms
4	P _r + 53 ms	13	P _r + 63 ms	22	P _r + 73 ms
5	P _r + 54 ms	14	P _r + 64 ms	23	P _r + 74 ms
6	P _r + 55 ms	15	P _r + 65 ms	24	P _r + 75 ms
7	P _r + 56 ms	16	P _r + 66 ms	25	P _r + 76 ms
8	P _r + 57 ms	17	P _r + 67 ms	26	P _r + 77 ms
9	P _r + 58 ms	18	P _r + 68 ms	27	P _r + 78 ms
Position Ident. (P ₆)	P _r + 59 ms	Position Ident. (P ₇)	P _r + 69 ms	Position Ident. (P ₈)	P _r + 79 ms

STRAIGHT BINARY SECONDS TIME-OF-DAY CODE (17 DIGITS)

SB Code BIT	Subword Digit Weight	BIT Time	SB Code BIT	Subword Digit Weight	BIT Time
1	2 ⁰ = (1)	P _r + 80 ms	10	2 ⁹ = (512)	P _r + 90 ms
2	2 ¹ = (2)	P _r + 81 ms	11	2 ¹⁰ = (1024)	P _r + 91 ms
3	2 ² = (4)	P _r + 82 ms	12	2 ¹¹ = (2048)	P _r + 92 ms
4	2 ³ = (8)	P _r + 83 ms	13	2 ¹² = (4096)	P _r + 93 ms
5	2 ⁴ = (16)	P _r + 84 ms	14	2 ¹³ = (8192)	P _r + 94 ms
6	2 ⁵ = (32)	P _r + 85 ms	15	2 ¹⁴ = (16384)	P _r + 95 ms
7	2 ⁶ = (64)	P _r + 86 ms	16	2 ¹⁵ = (32768)	P _r + 96 ms
8	2 ⁷ = (128)	P _r + 87 ms	17	2 ¹⁶ = (65536)	P _r + 97 ms
9	2 ⁸ = (256)	P _r + 88 ms	Index BIT		P _r + 98 ms
Position Ident. (P ₉)		P _r + 89 ms	Position Ident. (P ₀)		P _r + 99 ms

Note 1: The BIT Time is the time of the BIT leading edge and refers to the leading edge of P_r.

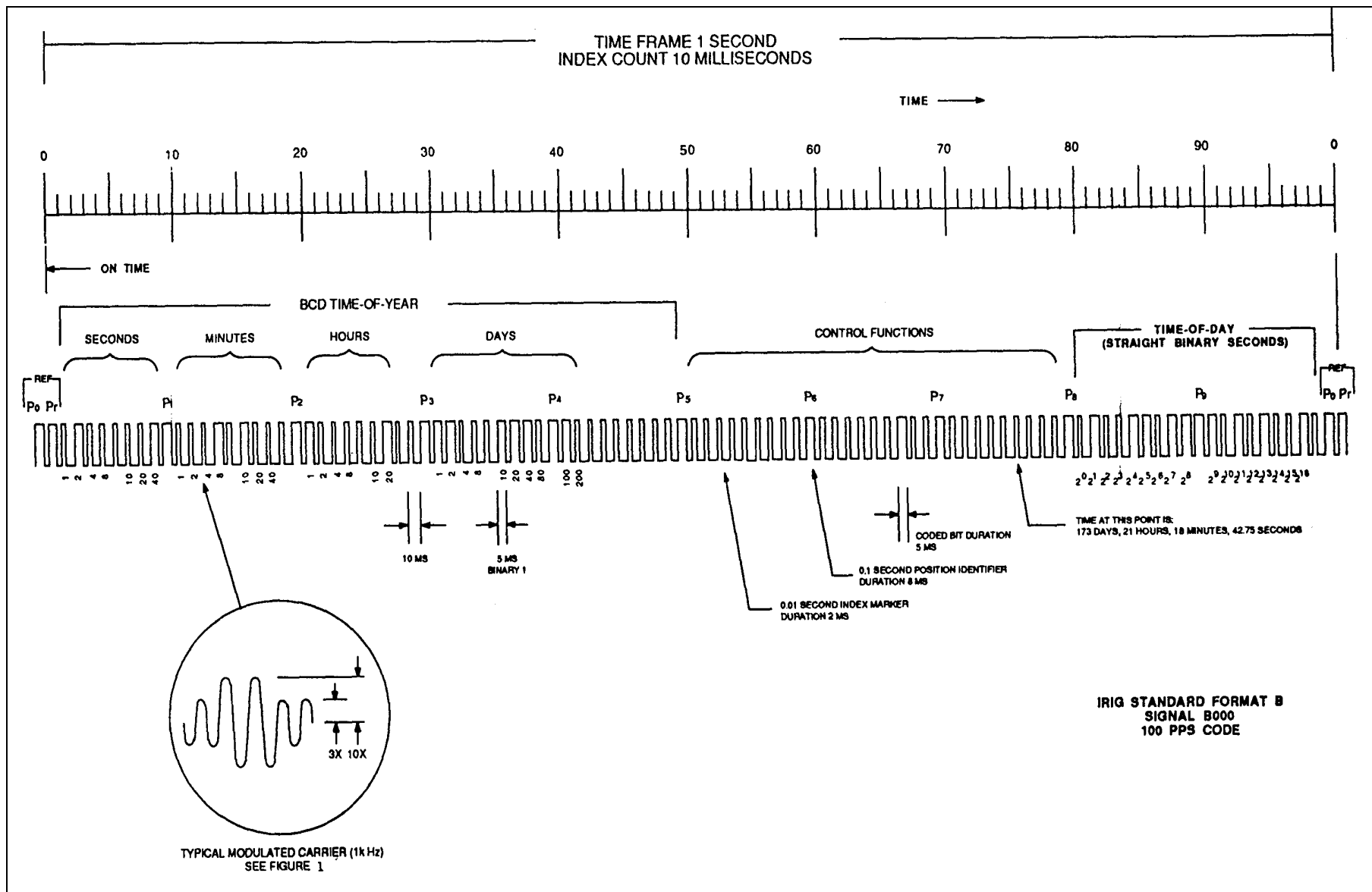

Figure 5. Format B: BCD time-of-year in days, hours, minutes and seconds; straight binary seconds-of-day plus optional control bits.

5.2.2 The two time code words and the control functions presented during the time frame are pulse width coded. The binary zero and the index markers have a duration of 2.0 ms, and a binary one has a duration of 5.0 ms. The 100 pps leading edge is the on-time reference point for all bits.

5.2.3 The BCD time-of-year code word consists of 30 bits beginning at index count one. The subword bits occur between position identifiers P_0 and P_5 : 7 for seconds, 7 for minutes, 6 for hours, and 10 for days to complete the BCD time code word. An index marker occurs between the decimal digits in each subword to provide separation for visual resolution. The LSB occurs first. The code recycles yearly. Each bit position is identified in table 3.

5.2.4 Twenty-seven control functions occur between position identifiers P_5 and P_8 . Any control function bit or combination of bits can be programmed to read a binary one or zero during any specified number of time frames. Each control bit position is identified in table 3.

5.2.5 The SB seconds-of-day code word occurs between position identifiers P_8 and P_0 . Seventeen bits give time-of-day in seconds with the LSB occurring first. A position identifier occurs between the 9th and 10th binary coded bit. The code recycles each 24-hour period. Each bit position is identified as shown in table 3.

5.2.6

Pulse Rates	Pulse Duration
Bit rate: 100 pps Position identifier: 10 pps Reference mark: 1 pps	Index marker: 2 ms Binary zero or uncoded bit: 2 ms Binary one or coded bit: 5 ms Position identifiers: 8 ms Reference bit: 8 ms

Resolution	Mark-To-Space Ratio
10 ms dc level 1 ms modulated 1 kHz carrier	Nominal value of 10:3 Range of 3:1 to 6:1

TABLE 3. FORMAT B, SIGNAL B000

BCD TIME-OF-YEAR CODE (30 DIGITS)

SECONDS SUBWORD			MINUTES SUBWORD			HOURS SUBWORD			DAYS SUBWORD					
BCD Code Digit No.	Subword Digit Wt SECONDS	BIT Time (Note 1)	BCD Code Digit No.	Subword Digit Wt MINUTES	BIT Time	BCD Code Digit No.	Subword Digit Wt HOURS	BIT Time	BCD Code Digit No.	Subword Digit Wt DAYS	BIT Time	BCD Code Digit No.	Subword Digit Wt DAYS	BIT Time
Reference BIT		P _r	8	1	P _r + 100 ms	15	1	P _r + 200 ms	21	1	P _r + 300 ms	29	100	P _r + 400 ms
1	1	P _r + 10 ms	9	2	P _r + 110 ms	16	2	P _r + 210 ms	22	2	P _r + 310 ms	30	200	P _r + 410 ms
2	2	P _r + 20 ms	10	4	P _r + 120 ms	17	4	P _r + 220 ms	23	4	P _r + 320 ms	Index BIT		P _r + 420 ms
3	4	P _r + 30 ms	11	8	P _r + 130 ms	18	8	P _r + 230 ms	24	8	P _r + 330 ms	Index BIT		P _r + 430 ms
4	8	P _r + 40 ms	Index BIT		P _r + 140 ms	Index BIT		P _r + 240 ms	Index BIT		P _r + 340 ms	Index BIT		P _r + 440 ms
Index BIT		P _r + 50 ms	12	10	P _r + 150 ms	19	10	P _r + 250 ms	25	10	P _r + 350 ms	Index BIT		P _r + 450 ms
5	10	P _r + 60 ms	13	20	P _r + 160 ms	20	20	P _r + 260 ms	26	20	P _r + 360 ms	Index BIT		P _r + 460 ms
6	20	P _r + 70 ms	14	40	P _r + 170 ms	Index BIT		P _r + 270 ms	27	40	P _r + 370 ms	Index BIT		P _r + 470 ms
7	40	P _r + 80 ms	Index BIT		P _r + 180 ms	Index BIT		P _r + 280 ms	28	80	P _r + 380 ms	Index BIT		P _r + 480 ms
Position Ident. (P ₁)		P _r + 90 ms	Position Ident. (P ₂)		P _r + 190 ms	Position Ident. (P ₃)		P _r + 290 ms	Position Ident. (P ₄)		P _r + 390 ms	Position Ident. (P ₅)		P _r + 490 ms

CONTROL FUNCTIONS (27 BITS)

Control Function BIT	BIT Time	Control Function BIT	BIT Time	Control Function BIT	BIT Time
1	P _r + 500 ms	10	P _r + 600 ms	19	P _r + 700 ms
2	P _r + 510 ms	11	P _r + 610 ms	20	P _r + 710 ms
3	P _r + 520 ms	12	P _r + 620 ms	21	P _r + 720 ms
4	P _r + 530 ms	13	P _r + 630 ms	22	P _r + 730 ms
5	P _r + 540 ms	14	P _r + 640 ms	23	P _r + 740 ms
6	P _r + 550 ms	15	P _r + 650 ms	24	P _r + 750 ms
7	P _r + 560 ms	16	P _r + 660 ms	25	P _r + 760 ms
8	P _r + 570 ms	17	P _r + 670 ms	26	P _r + 770 ms
9	P _r + 580 ms	18	P _r + 680 ms	27	P _r + 780 ms
Position Ident. (P ₆)	P _r + 590 ms	Position Ident. (P ₇)	P _r + 690 ms	Position Ident. (P ₈)	P _r + 790 ms

STRAIGHT BINARY SECONDS TIME-OF-DAY CODE (17 DIGITS)

SB Code BIT	Subword Digit Weight	BIT Time	SB Code BIT	Subword Digit Weight	BIT Time
1	2 ⁰ = (1)	P _r + 800 ms	10	2 ⁹ = (512)	P _r + 900 ms
2	2 ¹ = (2)	P _r + 810 ms	11	2 ¹⁰ = (1024)	P _r + 910 ms
3	2 ² = (4)	P _r + 820 ms	12	2 ¹¹ = (2048)	P _r + 920 ms
4	2 ³ = (8)	P _r + 830 ms	13	2 ¹² = (4096)	P _r + 930 ms
5	2 ⁴ = (16)	P _r + 840 ms	14	2 ¹³ = (8192)	P _r + 940 ms
6	2 ⁵ = (32)	P _r + 850 ms	15	2 ¹⁴ = (16384)	P _r + 950 ms
7	2 ⁶ = (64)	P _r + 860 ms	16	2 ¹⁵ = (32768)	P _r + 960 ms
8	2 ⁷ = (128)	P _r + 870 ms	17	2 ¹⁶ = (65536)	P _r + 970 ms
9	2 ⁸ = (256)	P _r + 880 ms	Index BIT		P _r + 980 ms
Position Ident. (P ₉)		P _r + 890 ms	Position Ident. (P ₀)		P _r + 990 ms

Note 1: The BIT Time is the time of the BIT leading edge and refers to the leading edge of P_r

5.3 Format D, Signal D001

5.3.1 The beginning of each 2-hour time frame is identified by two consecutive 48-second bits, P_0 and P_r . The leading edge of P_r is the on-time point for the succeeding time code word. Position identifiers, P_0 and P_1 through P_5 , occur every 10th bit and one minute before the leading edge of each succeeding 6 pph on-time bit (see figure 6).

5.3.2 The time code word and the control bits presented during the time frame are pulse width coded. The binary zero and the index markers have a duration of 12 seconds and the binary one has a duration of 30 seconds. The 1 ppm leading edge is the on-time reference point for all bits.

5.3.3 The BCD time-of-year code consists of 16 bits beginning at index count 20. The subword bits occur between position identifiers P_2 and P_5 : 6 for hours and 10 for days to complete the time code word. An index marker occurs between the decimal digits in each subword to provide separation for visual resolution. The LSB occurs first. The code recycles yearly. Each bit position is identified in table 4.

5.3.4 Nine control bits occur between position identifiers P_5 and P_0 . Any control function bit or combination of bits can be programmed to read a binary one or zero during any specified number of time frames. Each control bit position is identified in table 4.

5.3.5

Pulse Rate	Pulse Duration
Bit rate: 1 ppm Position identifiers: 6 pph Reference mark: 1 pph	Index marker: 12 s Binary zero or uncoded bit: 12 s Binary one or coded bit: 30 s Position identifiers: 48 s Reference bit: 48 s

Resolution	Mark-To-Space Ratio
1 m dc level 10 ms modulated 100 Hz carrier 1 ms modulated 1 kHz carrier	Nominal value of 10:1 Range of 3:1 to 6:1

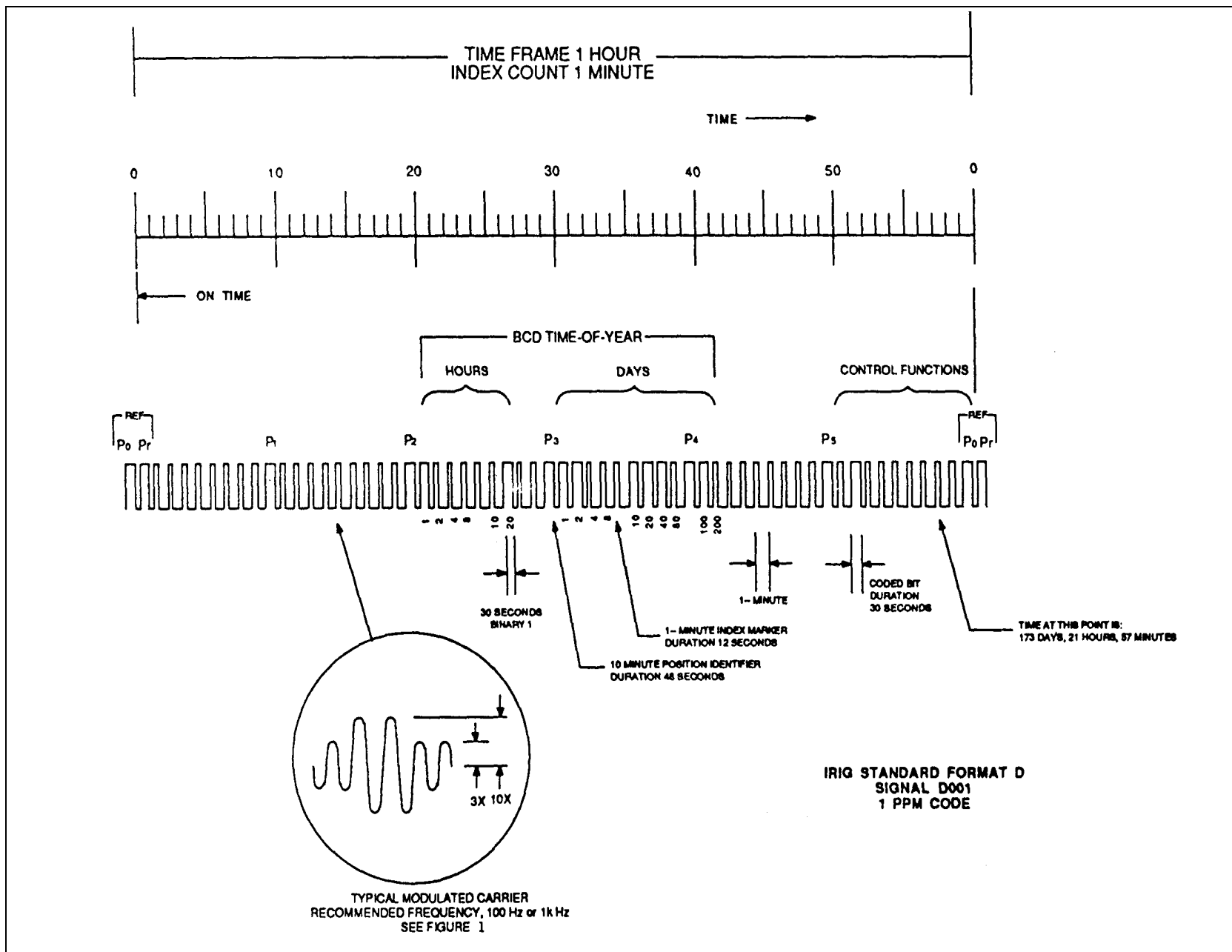

Figure 6. Format D: BCD time-of-year in days and hours plus optional control bits.

TABLE 4. FORMAT D, SIGNAL D001

BCD TIME-OF-YEAR CODE (16 DIGITS)

MINUTES SUBWORD			HOURS SUBWORD			DAYS SUBWORD								
BCD Code Digit No.	Subword Digit Wt MINUTES	BIT Time (Note 1)	BCD Code Digit No.	Subword Digit Wt MINUTES	BIT Time	BCD Code Digit No.	Subword Digit Wt HOURS	BIT Time	BCD Code Digit No.	Subword Digit Wt DAYS	BIT Time	BCD Code Digit No.	Subword Digit Wt DAYS	BIT Time
Reference BIT		P _r	Index Marker		P _r + 10 min	1	1	P _r + 20 min	7	1	P _r + 30 min	15	100	P _r + 40 min
Index Marker		P _r + 1 min	Index Marker		P _r + 11 min	2	2	P _r + 21 min	8	2	P _r + 31 min	16	200	P _r + 41 min
Index Marker		P _r + 2 min	Index Marker		P _r + 12 min	3	4	P _r + 22 min	9	4	P _r + 32 min	Index Marker		P _r + 42 min
Index Marker		P _r + 3 min	Index Marker		P _r + 13 min	4	8	P _r + 23 min	10	8	P _r + 33 min	Index Marker		P _r + 43 min
Index Marker		P _r + 4 min	Index Marker		P _r + 14 min	Index Marker		P _r + 24 min	Index BIT		P _r + 34 min	Index Marker		P _r + 44 min
Index Marker		P _r + 5 min	Index Marker		P _r + 15 min	5	10	P _r + 25 min	11	10	P _r + 35 min	Index Marker		P _r + 45 min
Index Marker		P _r + 6 min	Index Marker		P _r + 16 min	6	20	P _r + 26 min	12	20	P _r + 36 min	Index Marker		P _r + 46 min
Index Marker		P _r + 7 min	Index Marker		P _r + 17 min	Index Marker		P _r + 27 min	13	40	P _r + 37 min	Index Marker		P _r + 47 min
Index Marker		P _r + 8 min	Index Marker		P _r + 18 min	Index Marker		P _r + 28 min	14	80	P _r + 38 min	Index Marker		P _r + 48 min
Position Ident. (P ₁)		P _r + 9 min	Position Ident. (P ₂)		P _r + 19 min	Position Ident. (P ₃)		P _r + 29 min	Position Ident. (P ₄)		P _r + 39 min	Position Ident. (P ₅)		P _r + 49 min

CONTROL FUNCTIONS (9 BITS)	
Control Function BIT	BIT Time
1	P _r + 50 min
2	P _r + 51 min
3	P _r + 52 min
4	P _r + 53 min
5	P _r + 54 min
6	P _r + 55 min
7	P _r + 56 min
8	P _r + 57 min
9	P _r + 58 min
Position Ident. (P ₀)	P _r + 59 min

Note 1: The BIT Time is the time of the BIT leading edge and refers to the leading edge of P_r

5.4 Format E, Signal E001

5.4.1 The beginning of each 10 second time frame is identified by two consecutive 80 ms bits, P₀ and P_r. The leading edge of P_r is the on-time reference point for the succeeding time code.

Position identifiers, P₀ and P₁ through P₉, occur every 10th bit and 0.1 seconds before the leading edge of each succeeding 1 pps on-time bit (see figure 7).

5.4.2 The time code word and control functions presented during the timeframe are pulse width coded. The binary zero and index markers have a duration of 20 ms, and the binary one has a duration of 50 ms. The 10 pps leading edge is the on-time reference point for all bits.

5.4.3 The BCD time-of year code word consists of 26 bits beginning at index count 6. The code subword bits occur between position identifiers P₀ and P₅: 3 for seconds, 7 for minutes, 6 for hours, and 10 for days, to complete the time code word. An index marker occurs between the decimal digits in each subword to provide separation for visual resolution. The LSB occurs first. The code recycles yearly. Each bit position is identified in table 5.

5.4.4 Forty-five control functions occur between position identifiers P₅ and P₀. Any control function bit or combination of bits can be programmed to read a binary one or zero during any specified number of time frames. Each control bit position is identified in table 5.

5.4.5

Pulse Rate	Pulse Duration
Bit rate: 10 pps Position identifier: 1 pps Reference mark: 6 ppm	Index marker: 20 ms Binary zero or uncoded bit: 20 ms Binary one or coded bit: 50 ms Position identifier: 80 ms Reference bit: 80 ms

Resolution	Mark-To-Space Ratio
0.1 s dc level 10 ms modulated 100 kHz carrier 1 ms modulated 1 kHz carrier	Nominal value of 10:3 Range of 3:1 to 6:1

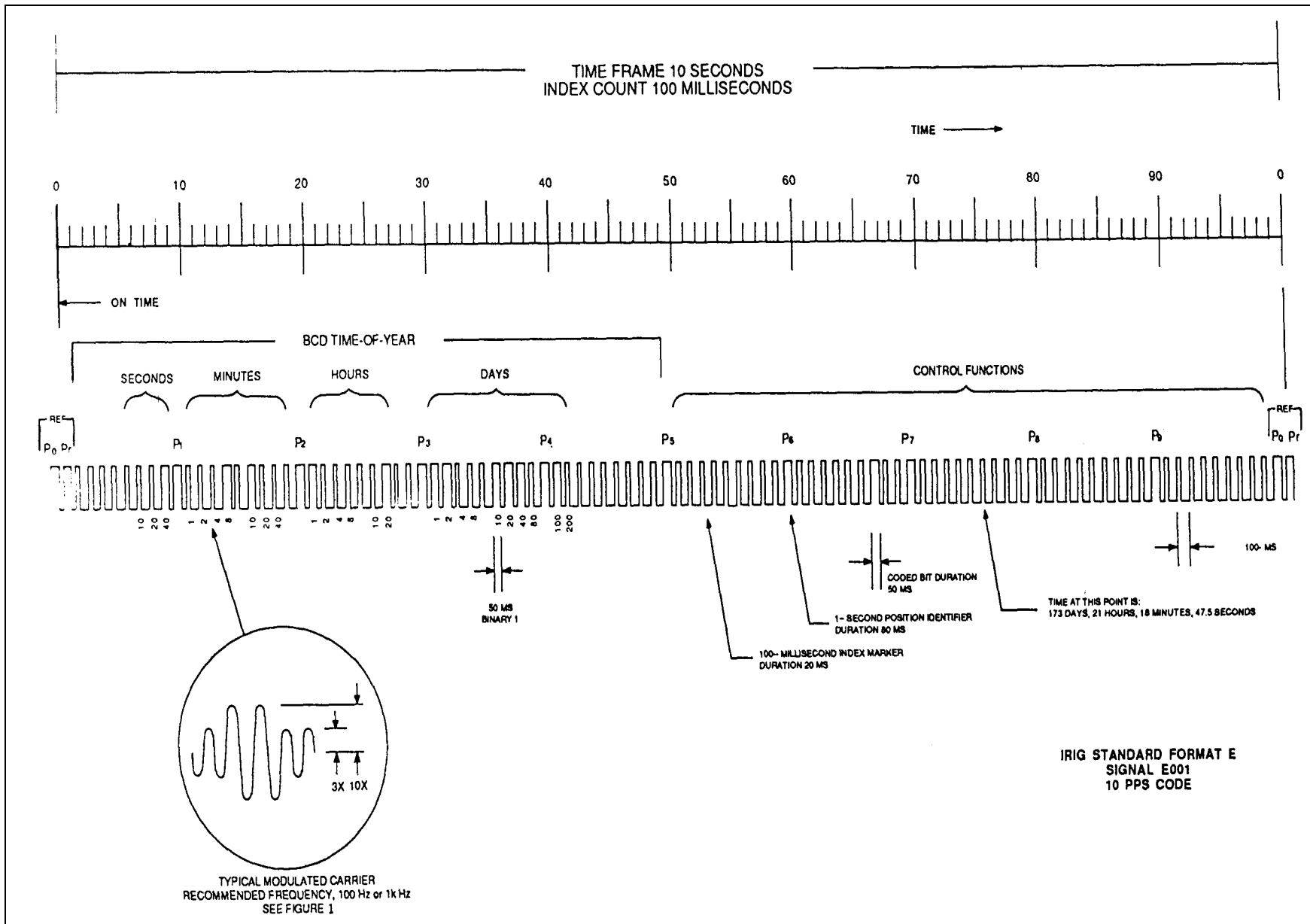

Figure 7. Format E: BCD time-of-year in days, hours, minutes and seconds plus optional control bits.

TABLE 5. FORMAT E, SIGNAL E001

BCD TIME-OF-YEAR CODE (26 DIGITS)														
SECONDS SUBWORD			MINUTES SUBWORD			HOURS SUBWORD			DAYS SUBWORD					
BCD Code Digit No.	Subword Digit Wt SECONDS	BIT Time (Note 1)	BCD Code Digit No.	Subword Digit Wt MINUTES	BIT Time	BCD Code Digit No.	Subword Digit Wt HOURS	BIT Time	BCD Code Digit No.	Subword Digit Wt DAYS	BIT Time	BCD Code Digit No.	Subword Digit Wt DAYS	BIT Time
Reference BIT		P _r	4	1	P _r + 1.0 sec	11	1	P _r + 2.0 sec	17	1	P _r + 3.0 sec	25	100	P _r + 4.0 sec
Index Marker		P _r + 0.1 sec	5	2	P _r + 1.1 sec	12	2	P _r + 2.1 sec	18	2	P _r + 3.1 sec	26	200	P _r + 4.1 sec
Index Marker		P _r + 0.2 sec	6	4	P _r + 1.2 sec	13	4	P _r + 2.2 sec	19	4	P _r + 3.2 sec	Index Marker		P _r + 4.2 sec
Index Marker		P _r + 0.3 sec	7	8	P _r + 1.3 sec	14	8	P _r + 2.3 sec	20	8	P _r + 3.3 sec	Index Marker		P _r + 4.3 sec
Index Marker		P _r + 0.4 sec	Index Marker		P _r + 1.4 sec	Index Marker		P _r + 2.4 sec	Index Marker		P _r + 3.4 sec	Index Marker		P _r + 4.4 sec
Index Marker		P _r + 0.5 sec	8	10	P _r + 1.5 sec	15	10	P _r + 2.5 sec	21	10	P _r + 3.5 sec	Index Marker		P _r + 4.5 sec
1	10	P _r + 0.6 sec	9	20	P _r + 1.6 sec	16	20	P _r + 2.6 sec	22	20	P _r + 3.6 sec	Index Marker		P _r + 4.6 sec
2	20	P _r + 0.7 sec	10	40	P _r + 1.7 sec	Index Marker		P _r + 2.7 sec	23	40	P _r + 3.7 sec	Index Marker		P _r + 4.7 sec
3	40	P _r + 0.8 sec	Index Marker		P _r + 1.8 sec	Index Marker		P _r + 2.8 sec	24	80	P _r + 3.8 sec	Index Marker		P _r + 4.8 sec
Position Ident. (P ₁)		P _r + 0.9 sec	Position Ident. (P ₂)		P _r + 1.9 sec	Position Ident. (P ₃)		P _r + 2.9 sec	Position Ident. (P ₄)		P _r + 3.9 sec	Position Ident. (P ₅)		P _r + 4.9 sec

CONTROL FUNCTIONS (45 BITS)									
Control Function BIT	BIT Time	Control Function BIT	BIT Time	Control Function BIT	BIT Time	Control Function BIT	BIT Time	Control Function BIT	BIT Time
1	P _r + 5.0 sec	10	P _r + 6.0 sec	19	P _r + 7.0 sec	28	P _r + 8.0 sec	37	P _r + 9.0 sec
2	P _r + 5.1 sec	11	P _r + 6.1 sec	20	P _r + 7.1 sec	29	P _r + 8.1 sec	38	P _r + 9.1 sec
4	P _r + 5.2 sec	12	P _r + 6.2 sec	21	P _r + 7.2 sec	30	P _r + 8.2 sec	39	P _r + 9.2 sec
3	P _r + 5.3 sec	13	P _r + 6.3 sec	22	P _r + 7.3 sec	31	P _r + 8.3 sec	40	P _r + 9.3 sec
5	P _r + 5.4 sec	14	P _r + 6.4 sec	23	P _r + 7.4 sec	32	P _r + 8.4 sec	41	P _r + 9.4 sec
6	P _r + 5.5 sec	15	P _r + 6.5 sec	24	P _r + 7.5 sec	33	P _r + 8.5 sec	42	P _r + 9.5 sec
7	P _r + 5.6 sec	16	P _r + 6.6 sec	25	P _r + 7.6 sec	34	P _r + 8.6 sec	43	P _r + 9.6 sec
8	P _r + 5.7 sec	17	P _r + 6.7 sec	26	P _r + 7.7 sec	35	P _r + 8.7 sec	44	P _r + 9.7 sec
9	P _r + 5.8 sec	18	P _r + 6.8 sec	27	P _r + 7.8 sec	36	P _r + 8.8 sec	45	P _r + 9.8 sec
Position Ident. (P ₆)	P _r + 5.9 sec	Position Ident. (P ₇)	P _r + 6.9 sec	Position Ident. (P ₈)	P _r + 7.9 sec	Position Ident. (P ₉)	P _r + 8.9 sec	Position Ident. (P ₀)	P _r + 9.9 sec

Note 1: The BIT Time is the time of the BIT leading edge and refers to the leading edge of P_r

5.5 Format G, Signal G001

5.5.1 The beginning of each 0.01 second time frame is identified by two consecutive 80 μ s bits, P_0 and P_r . The leading edge of P_r is the on-time reference point for the succeeding time code. Position identifiers, P_0 and P_1 through P_9 , occur every 10th bit, 0.1 ms before the leading edge of each succeeding 1 k pps on-time bit (see figure 8).

5.5.2 The time code word and the control functions presented during the time frame are pulse width coded. The binary zero and index markers have durations of 20 μ s, and the binary one has a duration of 50 μ s. The 10 k pps leading edge is the on-time reference point for all bits.

5.5.3 The BCD time-of-year code word consists of 38 bits beginning at index count one. The subword bits occur between position identifiers P_0 and P_6 : 7 for seconds, 7 for minutes, 6 for hours, 10 for days, 4 for tenths of seconds, and 4 for hundredths of seconds to complete the time code word. An index marker occurs between the decimal digits in each subword, except for fractional seconds, to provide visual separation. The LSB occurs first, except for the fractional second information which follows the day-of-year information. The code recycles yearly. Each bit position is identified in table 6.

5.5.4 Thirty-six control bits occur between position identifiers P_6 and P_0 . Any control function bit or combination of bits can be programmed to read a binary one or zero during any specified number of time frames. Each control bit position is identified in table 6.

5.5.5

Pulse Rate	Pulse Duration
Bit rate: 10 k pps Position identifier: 1 k pps Reference marker: 100 pps	Index marker: 20 μ s Binary zero or uncoded bit: 20 μ s Binary one or coded bit: 50 μ s Position identifiers: 80 μ s Reference bit: 80 μ s

Resolution	Mark-To-Space Ratio
0.1 ms dc level 10 μ s modulated 100 kHz	Nominal value of 10:3 Range of 3:1 to 6:1 carrier

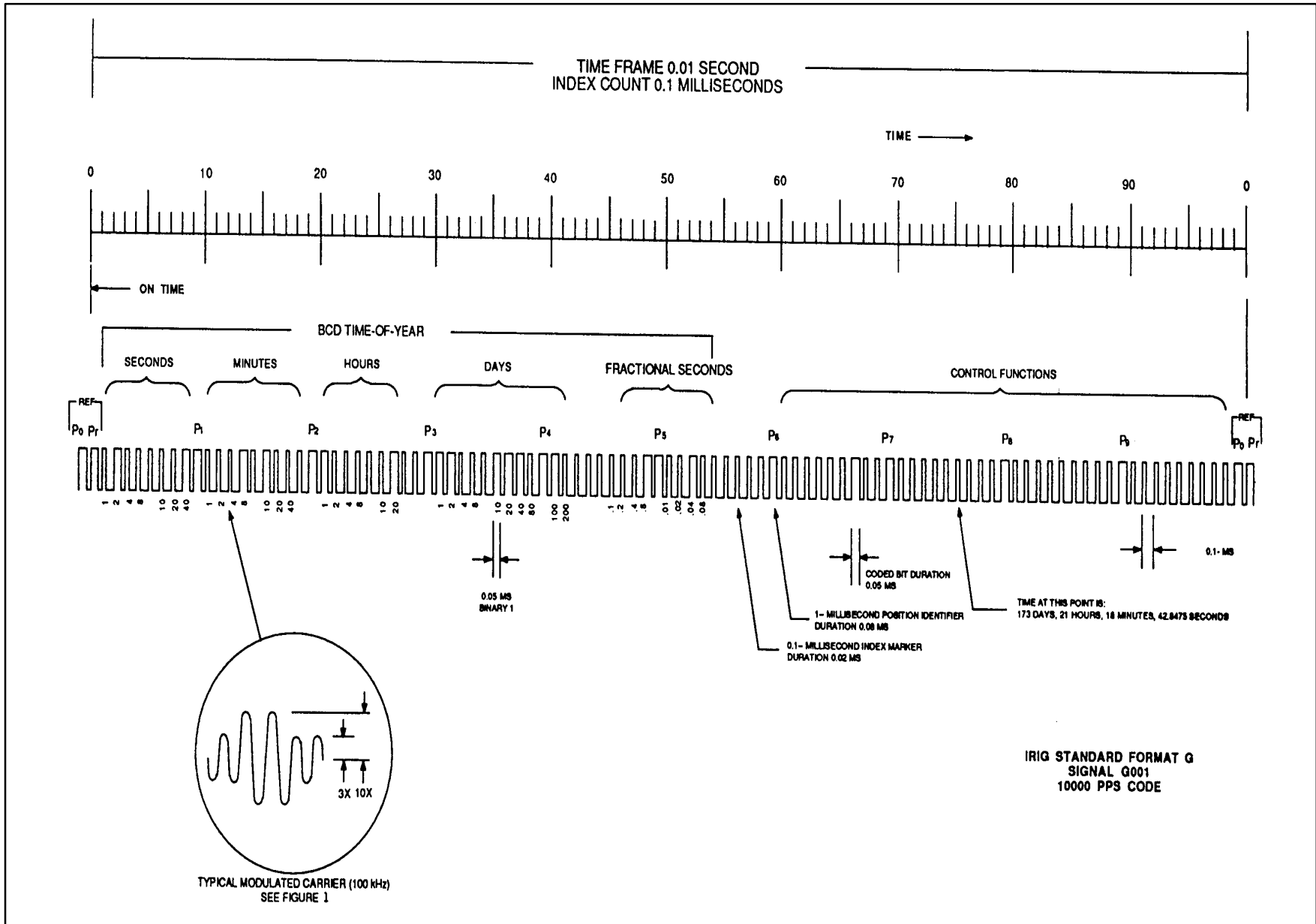

Figure 8. Format G: BCD time-of-year in days, hours, minutes, seconds, and fractions of seconds plus optional control bits.

TABLE 6. FORMAT G, SIGNAL G001

BCD TIME-OF-YEAR CODE (38 DIGITS)

SECONDS SUBWORD			MINUTES SUBWORD			HOURS SUBWORD			DAYS AND FRACTIONAL SECOND SUBWORD					
BCD Code Digit No.	Subword Digit Wt SECONDS	BIT Time (Note 1)	BCD Code Digit No.	Subword Digit Wt MINUTES	BIT Time	BCD Code Digit No.	Subword Digit Wt HOURS	BIT Time	BCD Code Digit No.	Subword Digit Wt DAYS	BIT Time	BCD Code Digit No.	Subword Digit Wt DAYS	BIT Time
Reference BIT		P _r	8	1	P _r + 1.0 ms	15	1	P _r + 2.0 ms	21	1	P _r + 3.0 ms	29	100	P _r + 4.0 ms
1	1	P _r + 0.1 ms	9	2	P _r + 1.1 ms	16	2	P _r + 2.1 ms	22	2	P _r + 3.1 ms	30	200	P _r + 4.1 ms
2	2	P _r + 0.2 ms	10	4	P _r + 1.2 ms	17	4	P _r + 2.2 ms	23	4	P _r + 3.2 ms	Index BIT		P _r + 4.2 ms
3	4	P _r + 0.3 ms	11	8	P _r + 1.3 ms	18	8	P _r + 2.3 ms	24	8	P _r + 3.3 ms	Index BIT		P _r + 4.3 ms
4	8	P _r + 0.4 ms	Index BIT		P _r + 1.4 ms	Index BIT		P _r + 2.4 ms	Index BIT		P _r + 3.4 ms	Index BIT		P _r + 4.4 ms
Index Bit		P _r + 0.5 ms	12	10	P _r + 1.5 ms	19	10	P _r + 2.5 ms	25	10	P _r + 3.5 ms	31	0.1	P _r + 4.5 ms
5	10	P _r + 0.6 ms	13	20	P _r + 1.6 ms	20	20	P _r + 2.6 ms	26	20	P _r + 3.6 ms	32	0.2	P _r + 4.6 ms
6	20	P _r + 0.7 ms	14	40	P _r + 1.7 ms	Index BIT		P _r + 2.7 ms	27	40	P _r + 3.7 ms	33	0.4	P _r + 4.7 ms
7	40	P _r + 0.8 ms	Index BIT		P _r + 1.8 ms	Index BIT		P _r + 2.8 ms	28	80	P _r + 3.8 ms	34	0.8	P _r + 4.8 ms
Position Ident. (P ₁)		P _r + 0.9 ms	Position Ident. (P ₂)		P _r + 1.9 ms	Position Ident. (P ₃)		P _r + 2.9 ms	Position Ident. (P ₄)		P _r + 3.9 ms	Position Ident. (P ₅)		P _r + 4.9 ms

BCD TIME-OF-YEAR CODE (Cont'd)

FRACTIONAL SECOND SUB-WORD

BCD Code Digit No.	Subword Digit Wt SECONDS	BIT Time
35	0.01	P _r + 5.0 ms
36	0.02	P _r + 5.1 ms
37	0.04	P _r + 5.2 ms
38	0.08	P _r + 5.3 ms
Index BIT		P _r + 5.4 ms
Index BIT		P _r + 5.5 ms
Index BIT		P _r + 5.6 ms
Index BIT		P _r + 5.7 ms
Index BIT		P _r + 5.8 ms
Position Ident. (P ₆)		P _r + 5.9 ms

CONTROL FUNCTIONS (36 BITS)

Control Function BIT	BIT Time	Control Function BIT	BIT Time	Control Function BIT	BIT Time	Control Function BIT	BIT Time
1	P _r + 6.0 ms	10	P _r + 7.0 ms	19	P _r + 8.0 ms	28	P _r + 9.0 ms
2	P _r + 6.1 ms	11	P _r + 7.1 ms	20	P _r + 8.1 ms	29	P _r + 9.1 ms
3	P _r + 6.2 ms	12	P _r + 7.2 ms	21	P _r + 8.2 ms	30	P _r + 9.2 ms
4	P _r + 6.3 ms	13	P _r + 7.3 ms	22	P _r + 8.3 ms	31	P _r + 9.3 ms
5	P _r + 6.4 ms	14	P _r + 7.4 ms	23	P _r + 8.4 ms	32	P _r + 9.4 ms
6	P _r + 6.5 ms	15	P _r + 7.5 ms	24	P _r + 8.5 ms	33	P _r + 9.5 ms
7	P _r + 6.6 ms	16	P _r + 7.6 ms	25	P _r + 8.6 ms	34	P _r + 9.6 ms
8	P _r + 6.7 ms	17	P _r + 7.7 ms	26	P _r + 8.7 ms	35	P _r + 9.7 ms
9	P _r + 6.8 ms	18	P _r + 7.8 ms	27	P _r + 8.8 ms	36	P _r + 9.8 ms
Position Ident. (P ₇)	P _r + 6.9 ms	Position Ident. (P ₈)	P _r + 7.9 ms	Position Ident. (P ₉)	P _r + 8.9 ms	Position Ident. (P ₀)	P _r + 9.9 ms

Note 1: The BIT Time is the time of the BIT leading edge and refers to the leading edge of P_r.

5.6 Format H, Signal H001

5.6.1 The beginning of each 1-minute time frame is identified by two consecutive 0.8 second bits, P_0 and P_r . The leading edge of P_r is the on-time reference point for the succeeding time code. Position identifiers P_0 and P_1 through P_5 , occur every 10th bit one second before the leading edge of each succeeding 6 ppm on-time bit (see figure 9).

5.6.2 The time code word and the control functions presented during the time frame are pulse width coded. The binary zero and the index markers have a duration of 0.2 seconds, and a binary one has a duration of 0.5 seconds. The leading edge is the 1 pps on-time reference point for all bits.

5.6.3 The BCD time-of-year consists of 23 bits beginning at index count 10. The subword bits occur between position identifiers P_0 and P_5 : 7 for minutes, 6 for hours, and 10 for days to complete the time code word. An index marker occurs between the decimal digits in each subword to provide separation for visual resolution. The LSB occurs first. The code recycles yearly. Each bit position is identified in table 7.

5.6.4 Nine control functions occur between position identifiers P_5 and P_0 . Any control function bit or combination of bits can be programmed to read a binary one or zero during any specified number of time frames. Each control function position is identified in table 7.

5.6.5

Pulse Rate	Pulse Duration
Bit rate: 1 pps Position identifier: 6 ppm Reference marker: 1 ppm	Index marker: 0.2 s Binary zero or uncoded bit: 0.2 s Binary one or coded bit: 0.5 s Position identifiers: 0.8 s Reference bit: 0.8 s

Resolution	Mark-To-Space Ratio
1 s dc level 10 ms modulated 100 Hz carrier 1 ms modulated 1 kHz carrier	Nominal value of 10:3 Range of 3:1 to 6:1

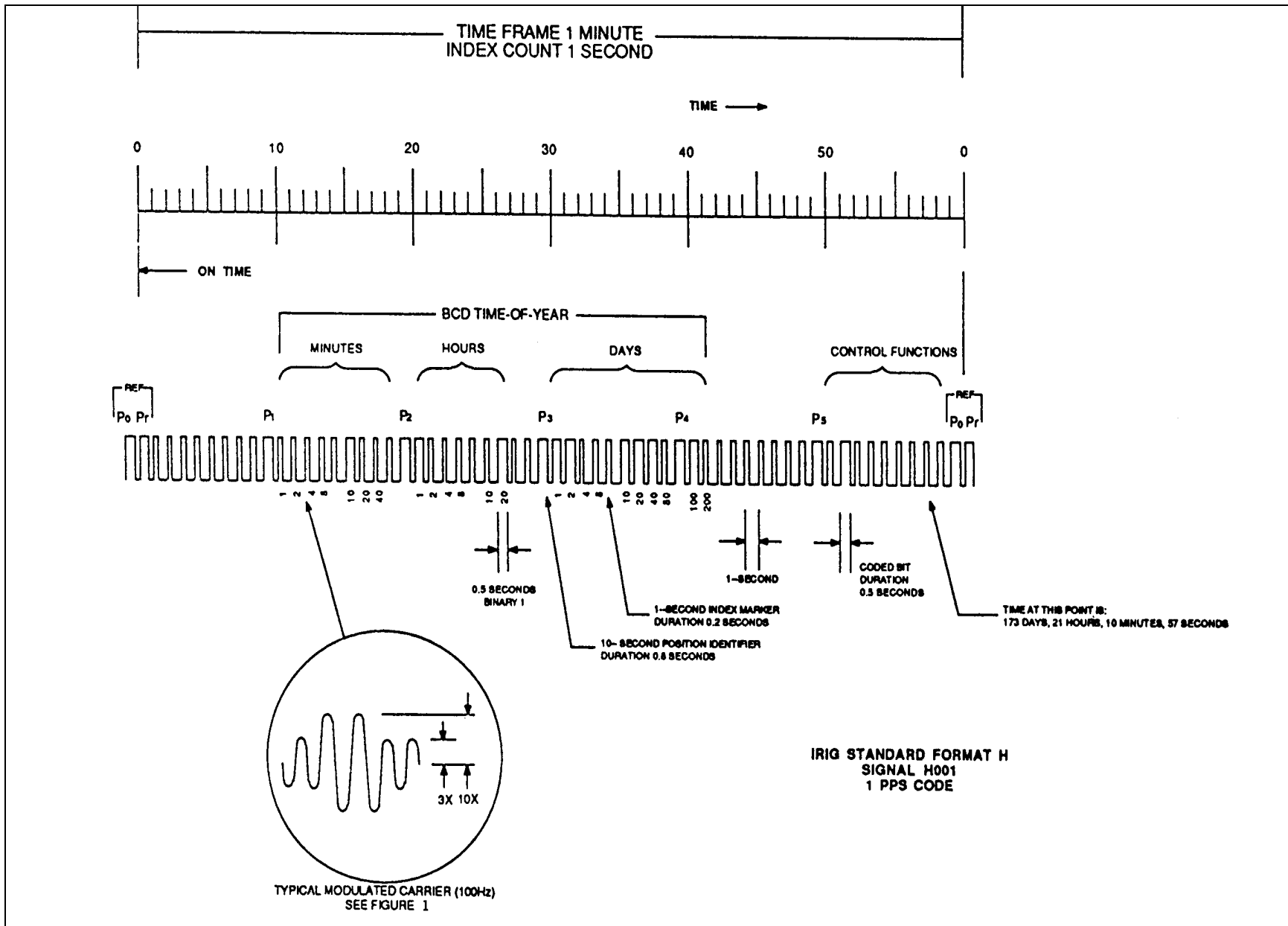

Figure 9. Format H: BCD time-of-year in days, hours and minutes plus optional control bits.

TABLE 7. FORMAT H, SIGNAL H001

BCD TIME-OF-YEAR CODE (23 DIGITS)

			MINUTES SUBWORD			HOURS SUBWORD			DAYS SUBWORD					
BCD Code Digit No.	Subword Digit Wt SECONDS	BIT Time (Note 1)	BCD Code Digit No.	Subword Digit Wt MINUTES	BIT Time	BCD Code Digit No.	Subword Digit Wt HOURS	BIT Time	BCD Code Digit No.	Subword Digit Wt DAYS	BIT Time	BCD Code Digit No.	Subword Digit Wt DAYS	BIT Time
Reference BIT		P_r	1	1	$P_r + 10$ sec	8	1	$P_r + 20$ sec	14	1	$P_r + 30$ sec	22	100	$P_r + 40$ sec
Index Marker		$P_r + 1$ sec	2	2	$P_r + 11$ sec	9	2	$P_r + 21$ sec	15	2	$P_r + 31$ sec	33	200	$P_r + 41$ sec
Index Marker		$P_r + 2$ sec	3	4	$P_r + 12$ sec	10	4	$P_r + 22$ sec	16	4	$P_r + 32$ sec	Index Marker		$P_r + 42$ sec
Index Marker		$P_r + 3$ sec	4	8	$P_r + 13$ sec	11	8	$P_r + 23$ sec	17	8	$P_r + 33$ sec	Index Marker		$P_r + 43$ sec
Index Marker		$P_r + 4$ sec	Index Marker		$P_r + 14$ sec	Index Marker		$P_r + 24$ sec	Index Marker		$P_r + 34$ sec	Index Marker		$P_r + 44$ sec
Index Marker		$P_r + 5$ sec	5	10	$P_r + 15$ sec	12	10	$P_r + 25$ sec	18	10	$P_r + 35$ sec	Index Marker		$P_r + 45$ sec
Index Marker		$P_r + 6$ sec	6	20	$P_r + 16$ sec	13	20	$P_r + 26$ sec	19	20	$P_r + 36$ sec	Index Marker		$P_r + 46$ sec
Index Marker		$P_r + 7$ sec	7	40	$P_r + 17$ sec	Index Marker		$P_r + 27$ sec	20	40	$P_r + 37$ sec	Index Marker		$P_r + 47$ sec
Index Marker		$P_r + 8$ sec	Index Marker		$P_r + 18$ sec	Index Marker		$P_r + 28$ sec	21	80	$P_r + 38$ sec	Index Marker		$P_r + 48$ sec
Position Ident. (P_1)		$P_r + 9$ sec	Position Ident. (P_2)		$P_r + 19$ sec	Position Ident. (P_3)		$P_r + 29$ sec	Position Ident. (P_4)		$P_r + 39$ sec	Position Ident. (P_5)		$P_r + 49$ sec

CONTROL FUNCTIONS (9 BITS)

Control Function BIT	BIT Time
1	$P_r + 50$ sec
2	$P_r + 51$ sec
3	$P_r + 52$ sec
4	$P_r + 53$ sec
5	$P_r + 54$ sec
6	$P_r + 55$ sec
7	$P_r + 56$ sec
8	$P_r + 57$ sec
9	$P_r + 58$ sec
Position Ident. (P_0)	$P_r + 59$ sec

Note 1: The BIT Time is the time of the BIT leading edge and refers to the leading edge of P_r .

APPENDIX A

LEAP YEAR/LEAP SECOND CONVENTION

LEAP YEAR/LEAP SECOND CONVENTION

LEAP YEAR:

The length of a year is not an even multiple of days. The year is about 365.25 days. Thus, every four years there is an extra day, February 29, provided the year is divisible by 4. Years divisible by 400 are leap years. If the year is divisible by 100, it is not a leap year. Consequently, the years 1988, 1992, 1996, and 2000 are leap years. The year 2100 will not be a leap year because it is not divisible by 400. With the addition of leap years, the calendar stays in step with the seasons.

ACCUMULATED LEAP SECOND:

Since 1 January 1972, the relationship between International Atomic Time (TAI) and Coordinated Universal Time (UTC) has been given by a simple accumulation of leap seconds occurring approximately once per year.

At any instant (i), $T_i =$ TAI time

$U_i =$ UTC time expressed in seconds

$T_i = U_i + L_i,$

where (L_i) is the accumulated leap second additions between the epoch and the instant (i). The following table contains a reference list of the accumulated leap second additions (L_i) between 1972.0 and 1988.0:

TIME PERIOD	L_i
1972 Jan 1 --- 1972 Jul 1	10.000 000 0 s
1972 Jul 1 --- 1973 Jan 1	11.000 000 0 s
1973 Jan 1 --- 1974 Jan 1	12.000 000 0 s
1974 Jan 1 --- 1975 Jan 1	13.000 000 0 s
1975 Jan 1 --- 1976 Jan 1	14.000 000 0 s
1976 Jan 1 --- 1977 Jan 1	15.000 000 0 s
1977 Jan 1 --- 1978 Jan 1	16.000 000 0 s
1978 Jan 1 --- 1979 Jan 1	17.000 000 0 s
1979 Jan 1 --- 1980 Jan 1	18.000 000 0 s
1980 Jan 1 --- 1981 Jul 1	19.000 000 0 s
1981 Jul 1 --- 1982 Jul 1	20.000 000 0 s
1982 Jul 1 --- 1983 Jul 1	21.000 000 0 s
1983 Jul 1 --- 1985 Jul 1	22.000 000 0 s
1985 Jul 1 --- 1986 Jan 1	23.000 000 0 s
1986 Jan 1 --- 1988 Jan 1	24.000 000 0 s

NOTE: Time changes are made on 31 December and 30 June at 2400 if required.

APPENDIX B

BCD COUNT/BINARY COUNT

BCD COUNT (8n 4n 2n 1n)		
<u>Decimal Number</u>	<u>n</u>	<u>BCD Bits</u>
1	1	1
5	1	3
10	10	5
15	10	5
150	100	9
1 500	1x10³	13
15 000	10x10³	17
150 000	100x 10³	21
1 500 000	1x10⁶	25
15 000 000	10x10⁶	29
150 000 000	100x10⁶	33
1 500 000 000	1x10⁹	37
15 000 000 000	10x10⁹	41
150 000 000 000	100x10⁹	45
1 500 000 000 000	1x10¹²	49
15 000 000 000 000	10x10¹²	53
150 000 000 000 000	100x10¹²	57

BINARY COUNT (2ⁿ)			
<u>Decimal Number</u>	<u>Binary Number</u>	<u>Decimal Number</u>	<u>Binary Number</u>
n	2 ⁿ	n	2 ⁿ
0	1		
1	2	26	671 08864
2	4	27	1342 17728
3	8	28	2684 35456
4	16	29	5368 70912
5	32	30	10737 41825
6	64	31	21474 83648
7	128	32	42949 67296
8	256	33	85899 34592
9	512	34	1 71798 69184
10	1024	35	3 43597 38368
11	2048	36	6 87194 76736
12	4096	37	13 74389 53472
13	8192	38	27 48779 06944
14	16384	39	54 97558 13888
15	32768	40	109 95116 27776
16	65536	41	219 90232 55552
17	1 31072	42	439 80465 11104
18	2 62144	43	879 60930 22208
19	5 24288	44	1759 21860 44416
20	10 48576	45	3518 43720 88832
21	20 97152	46	7036 87441 77664
22	41 94304	47	14073 74883 55328
23	83 88608	48	28147 49767 10656
24	167 77216	49	56294 99534 21312
25	335 54432	50	112589 99068 42624

APPENDIX C

TIME CODE GENERATOR HARDWARE DESIGN CONSIDERATION

TIME CODE GENERATOR HARDWARE DESIGN CONSIDERATIONS

Code	Level (dc) Pulse Rise Time Between the 10 and 90% Amplitude Points	Jitter Modulated at Carrier Frequency	Jitter Level (dc) Pulse-to-Pulse
Format A	≤ 200 ns	$\leq 1\%$	≤ 100 ns
Format B	≤ 1 μ s	$\leq 1\%$	≤ 200 ns
Format D	≤ 1 μ s	$\leq 1\%$	≤ 200 ns
Format E	≤ 1 μ s	$\leq 1\%$	≤ 200 ns
Format G	≤ 20 ns	$\leq 1\%$	≤ 20 ns
Format H	≤ 1 μ s	$\leq 1\%$	≤ 200 ns