

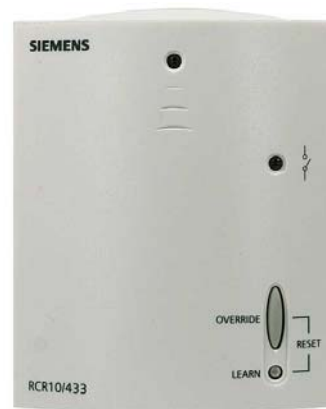

RDJ10RF



RCR10/433

Wireless room temperature controller with 24-hour time switch and LCD

RDJ10RF/SET

Programmable, for heating systems

- Operating modes: Automatic, Comfort, Energy Saving, and Frost Protection
- LCD-Display 50 x 45 (W x H)
- RDJ10RF transmitter, battery-powered
- RCR10/433 receiver, mains powered
- Communication of the set is bonded ex factory

Use

The RDJ10RF is used to control the room temperature in heating or cooling systems.

Typical applications include:

- Homes
- Residential buildings
- Schools
- Offices

The controller can be used together with the following equipment:

- Thermal valves or zone valves
- Combi boilers
- Gas or oil burners
- Fans
- Pumps

Functions

The controller acquires the room temperature using its integrated sensor.

Function diagram

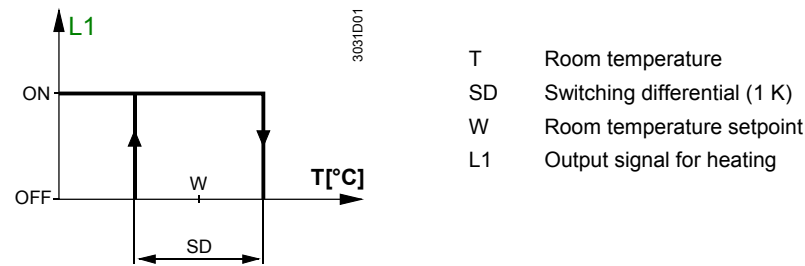

Temperature sensor

The RDJ10RF provides room temperature control only.

Operating modes

The RDJ10RF has the following modes: Automatic, Comfort, Energy Saving, and Frost Protection.

Move the operating mode slider to the respective position to changeover between the operating modes

Automatic mode

Automatic mode is active, when the symbol  appears on the display. The RDJ10RF operates per the selected 24-hour time program.

Comfort mode

Comfort mode is active, when the symbol  appears on the display. The RDJ10RF controls to the temperature setpoint adjusted at T_{gear} . This setpoint can be readjusted by setting the programming slider to T_{gear} .

Energy Saving mode

Energy Saving mode is active, when the symbol  appears on the display. The RDJ10RF controls to the temperature setpoint adjusted at T_{moon} . This setpoint can be readjusted by setting the programming slider to T_{moon} .

Frost Protection

Frost Protection is active, when the symbol  appears on the display. The RDJ10RF controls to the fixed temperature setpoint for frost protection.

Display

The digital display displays the actual room temperature and the comfort temperature setpoint. The triangle symbol appears when the heating output is active.



Backup

Setpoints and information required for operating mode changeover are retained when exchanging batteries. The values must be checked though. The time goes to 12:00 pm and must be reset

Ordering

Please provide the name and product number when ordering: Room temperature controller RDJ10RF/SET.
Valves and actuators are ordered separately

Equipment combinations

Type of unit	Product number	Data sheet
Electromotoric actuator	SFA21...	4863
Electrothermal actuator (for radiator valves)	STA21...	4877
Electrothermal actuator (for small valves 2.5 mm)	STP21...	4878
2- or 3-port zone valve	MXI/MVI421...	4867
Electromotoric actuator for zone valves V..146..	SUA21	4830
Electric actuator	SUA11/22	4832
Air damper actuator	GDB...	4624
Air damper actuator	GSD/GQD...	4606
Air damper actuator	GXD...	4622

Mechanical design







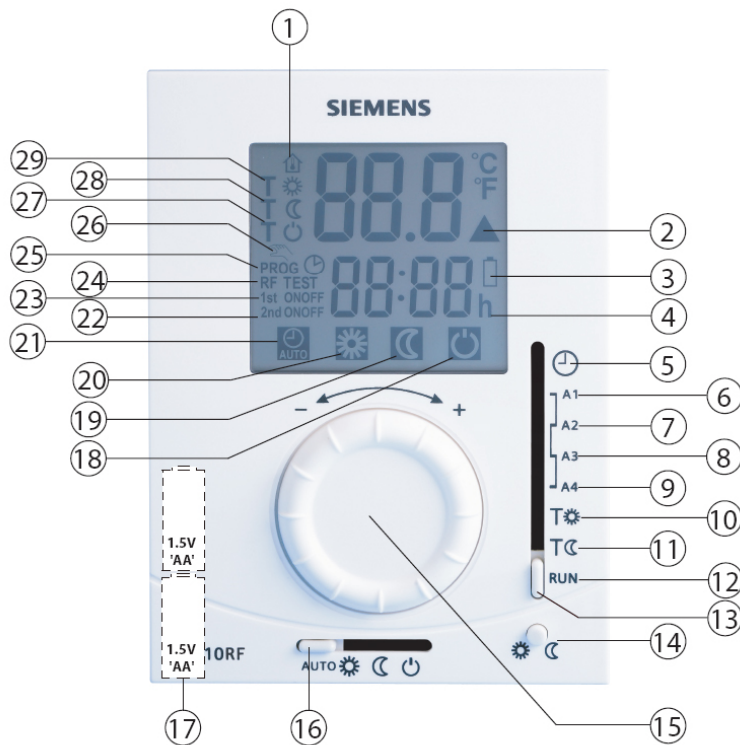





The unit consists of 4 parts:

- Plastic housing with digital display accommodating the electronics, operating elements and built-in room temperatures sensor
- Baseplate (mounting base)
- Removable battery compartment
- Fold-out stand

The housing engages in the baseplate and snaps on. There is a reset button on the rear of the unit.



Key

- 1  Room temperature display in °C
- 2  Indicates a heat request
- 3  Indicates low battery power; replace batteries
- 4 Time of day (00:00...23:59 format)
- 5 Time setting position
- 6 First switch ON time
- 7 First switch OFF time
- 8 Second switch ON time
- 9 Second switch OFF time
- 10  Comfort temperature setting
- 11  Energy saving temperature setting
- 12 RUN position
- 13 Programming slider
- 14 Advance button (override / presence button)
- 15 Temperature setting knob
- 16 Operating mode slider
- 17 Battery compartment
- 18  Frost Protection; the RDJ10RF controls to a fixed temperature setpoint of 5 °C for frost protection
- 19  Energy Saving mode; the RDJ10RF continuously controls to the energy saving temperature setpoint
- 20  Comfort mode; the RDJ10RF continuously controls to the comfort temperature setpoint
- 21  Automatic mode; the RDJ10RF operates per the selected time & temperature program
- 22 Indicates second switch ON / OFF time
- 23 Indicates first switch ON / OFF time
- 24 RF **TEST** Indicates RF signal test
- 25 Indicates that programming is taking place.
- 26  Setpoint is temporarily overridden until the next switching time
- 27  The RDJ10RF controls to the fixed frost protection temperature setpoint
- 28  The RDJ10RF controls to the adjusted energy saving temperature setpoint
- 29  The RDJ10RF controls to the adjusted comfort temperature setpoint

The RCR10/433 is in a plastic housing with LEDs and buttons.

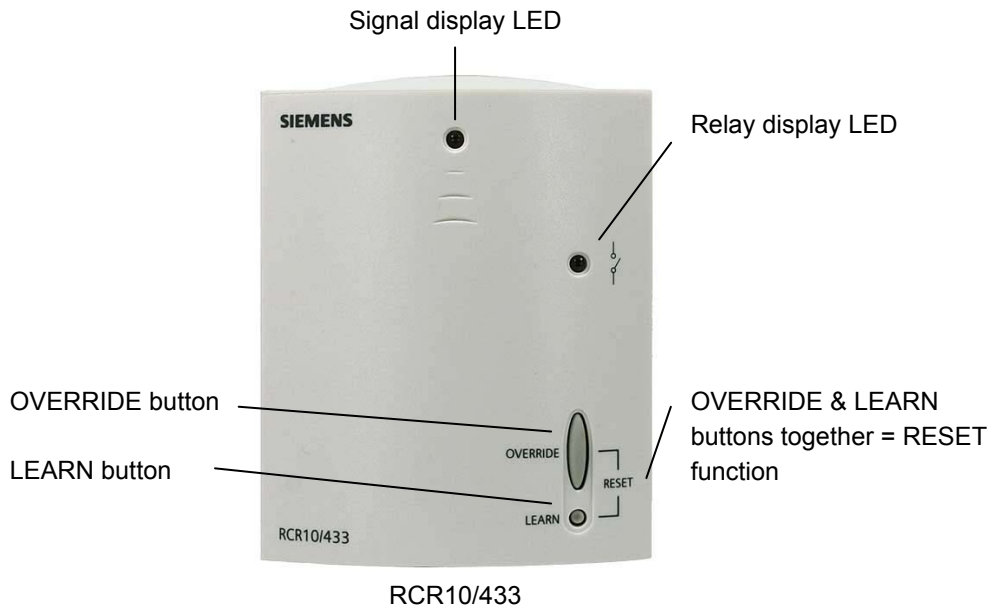

The RDJ10RF is located in a plastic housing. The buttons are visible on the rear when you remove the baseplate.

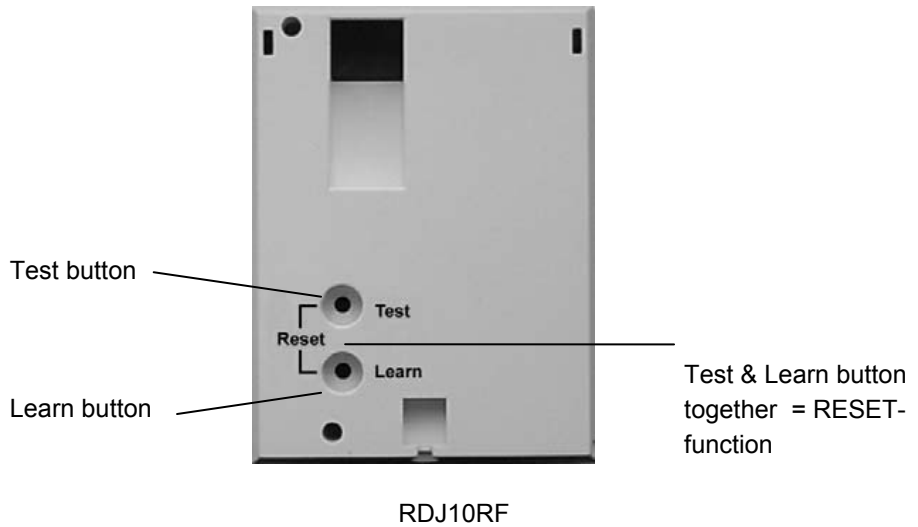

OVERRIDE

Override allows for temporarily overwriting the active value from the sender. Override responds differently depending on the radio connection (normal or fault).

Example A: Normal connection between sender and recipient

Press the OVERRIDE button to overwrite the value for ca. 14 minutes. The value then returns to the setpoint.

Example B: Faulty connection between sender and recipient

Press the OVERRIDE button to permanently overwrite the value. The value returns to the setpoint after the connection between sender and recipient works again.

RF LED

RF state	RF LED
Power up (First 5 seconds)	Flash RED + GREEN (Amber) (5 seconds)
Power up (After 5 seconds)	RED
Press OVERRIDE switch	Flash RED + GREEN (Amber) (5 seconds)
Learning period	No LED
Software reset	RED
RF receive	GREEN
No RF within last 25 minutes	RED
Manual override (RF receive)	Flash GREEN
Manual override (No RF receive)	Flash RED

Relay LED

Relay state	Relay LED
From OUT to ON (First 5 seconds)	Flash YELLOW
ON	YELLOW
From ON to OFF (After 5 seconds)	Flash YELLOW
OFF	OFF

Notes

Mount the room temperature controller in a location where the air temperature can be measured as accurately as possible without being adversely affected by direct solar radiation or other sources of heat or cooling.

The controller is delivered with a fold-out stand and may be used as a "mobile" device (Note: Pay attention to mounting location).

Mounting height is approximately 1.5 m above the floor.

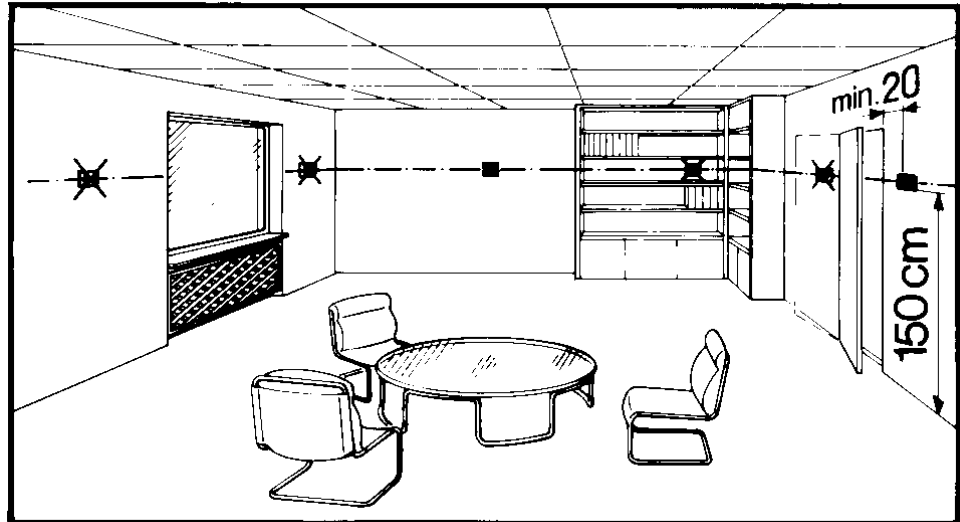

The unit can be fitted to a recessed conduit box.

Mounting, installation and commissioning

Fix the baseplate prior to mounting the controller. The receiver does not require any baseplate. Connect the electrical connections, fit and secure the receiver in compliance with local regulations (also refer to the separate mounting instructions).

Mount the controller on a flat wall.

If there are thermostatic radiator valves in the reference room, set them to their fully open position.

For commissioning please refer to the Operating Instruction CE1B3072xx

Maintenance

Controller and receiver are maintenance-free except for the controller battery.

Change of batteries

If the battery symbol  appears, the batteries are almost empty and must be replaced.

Reset

Simultaneously press the TEST and LEARN buttons on the rear side of the controller to reset it (reset function).

Simultaneously press the OVERRIDE and LEARN buttons to reset the receiver (reset function).

All individual settings are reset to the default values.

Technical data

Power supply	Operating voltage	DC 3 V (2 x 1.5 V AA alkaline batteries)
	Battery life	>1 year (AA alkaline batteries)



Operational data	Thermistor	10 k Ω \pm 1% at 25 °C
	Switching differential SD	1 K (fixed)
	Setpoint setting range	5...30 °C (Comfort mode)
		5...30 °C (Energy Saving mode)
		5 °C (Frost Protection, fixed value)
	Factory setting comfort setpoint	20 °C
	Factory setting for energy saving mode	10 °C
	Resolution of settings and displays	
Setpoints	0.5 °C	
Actual value displays	0.5 °C	
Display of time of day	1 min	

Environmental conditions	Operation	IEC 721-3-3
	Climatic conditions	Class 3K5
	Temperature	0...+40 °C
	Humidity	<90% r.h.
	Transport	IEC 721-3-2
	Climatic conditions	Class 2K3
	Temperature	-25...+60 °C
	Humidity	<95 % r. h.
	Mechanical conditions	Class 2M2
	Storage	IEC 721-3-1
	Climatic conditions	Class 1K3
	Temperature	-10...+60 °C
	Humidity	<90% r.h.

Standards	CE conformity to	
	EMC directive	2004/108/EC
	Low-voltage directive	2006/95/EC
	Radio equipment	1999/5/EC
	C-tick conformity to	
	Test standards and requirements	EN 61000-6-3, AS/NZS 4251.1: 1999
	Test standards for radio equipment	AS/NZS 4268: 2003

General	Product safety	
	Automatic electrical controls for household and similar use	EN 60 730-1 and EN 60 730-2-9
	Information technology equipment - Safety - General Requirements	EN 60950-1
	Generic standards - Compliance to lower power electronic apparatus	EN 50371-1
	Electromagnetic compatibility and radio spectrum matters—Short range devices	EN 300220-3 V1.1.1
	Electromagnetic compatibility and radio spectrum matters – EMC	EN 301489-3 V1.4.1
	Safety class	III as per EN 60950-1
	Pollution degree	2
	Degree of protection of housing	IP20
	Weight (including package)	
	RDJ10RF/SET	515 g
	Color of housing front	Signal-white RAL9003
	Housing material	ABS (LCD lens: PC)

Receiver RCR10/433

General unit data	Operating voltage	AC 230 V +10/-15%
	Power	<10 VA
	Frequency	50...60 Hz
	Switching capacity of relays	
	Voltage	AC 24...250 V
	Current	8 (3) A
Outputs	Relay contacts	
 Switching outputs (LX, L1, L2)	Switching voltage	Max. AC 250 V Min. AC 24 V
	Switching current At AC 250 V	Max. 8 A res., 3 A ind. Min. 200 mA
	Contact life at AC 250 V At 5 A res.	Guide value: 1 x 10 ⁵ cycles
	Insulating strength	
	Between relay contacts and coil	AC 5,000 V
	Between relay contacts (same pole)	AC 2,500 V
Electrical connections	Connection terminals	Screw terminals
	For solid wires	2 x 1.5 mm ²
	For stranded wires	1 x 2.5 mm ² (min. 0.5 mm ²)
Environmental conditions	Operation	IEC 60 721-3
	Climatic conditions	Class 3K3
	Temperature	0...+45 °C
	Humidity	<85% r.h.
	Storage and transport	IEC 60 721-3
	Climatic conditions	Class 2K3
	Temperature	-25...+70 °C
	Humidity	<93% r.h.
	Mechanical conditions	Class 2M2
Standards	 conformity	
	EMC directives	2004/108/EC
	Low-voltage directives	2006/95/EC
	Radio equipment	1999/5/EC
	Product safety	
	Automatic electrical controls for household and similar use	EN 60 730-1 and EN 60 730-2-9
	Information technology equipment - Safety - General Requirements	EN 60950-1
	Generic standards - Compliance to lower power electronic apparatus	EN 50371-1
	Electromagnetic compatibility and radio spectrum matters-Short range devices	EN 300220-3 V1.1.1
	Electromagnetic compatibility and radio spectrum matters - EMC	EN 301489-3 V1.4.1
 approval in the following countries	All ECC countries, Norway, Iceland and Switzerland	
Safety class	II as per EN 60 730	
Degree of pollution	2	
Color	Unit front	Signal-white RAL 9003
	Base	Gray RAL 7035
	Dimensions	83x104x32 mm

Connection diagram

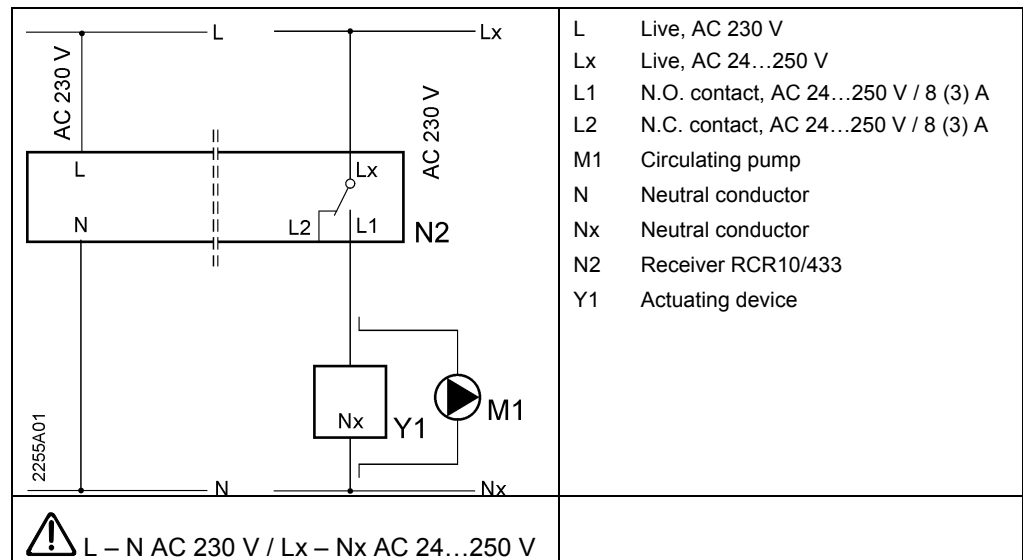

Application examples

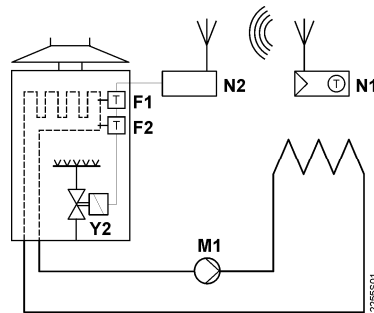

Wireless room temperature controller with receiver control of a gas-fired wall-hung boiler

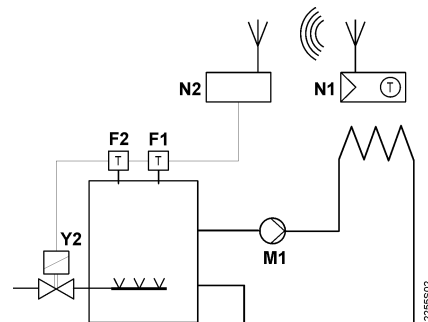

Wireless room temperature controller with receiver control of atmospheric gas burner

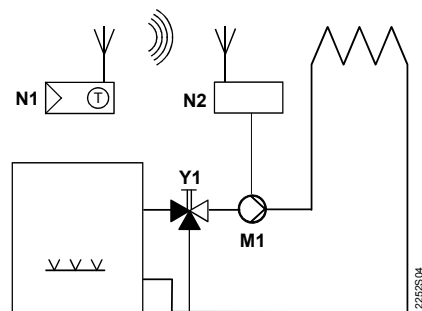

Wireless room temperature controller with receiver control of a heating circuit pump (precontrol by manual mixing valve)

F1 Thermal reset limit thermostat
 F2 Safety limit thermostat
 M1 Circulating pump

E1 Cooling equipment
 N1 Room temperature controller RDJ10RF
 N2 Receiver RCR10/433
 Y1 3-port valve with manual adjustment
 Y2 Magnetic valve

Dimensions

Room temperature controller

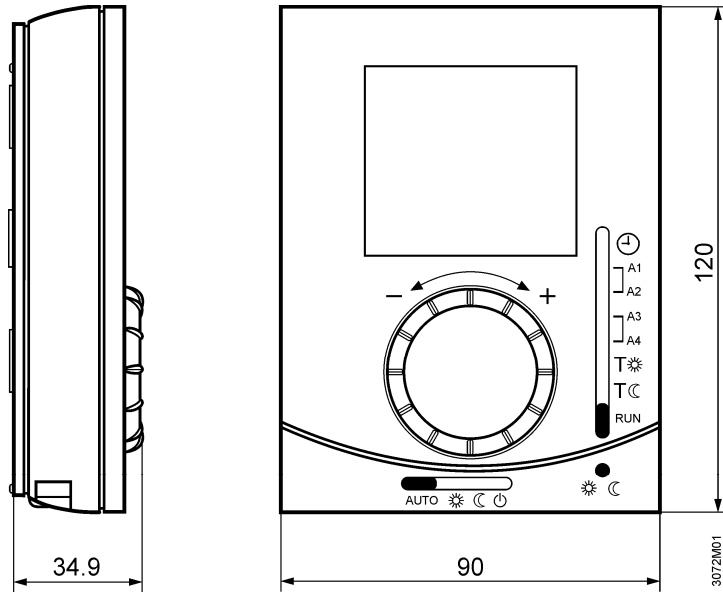

Room temperature controller mounting plate

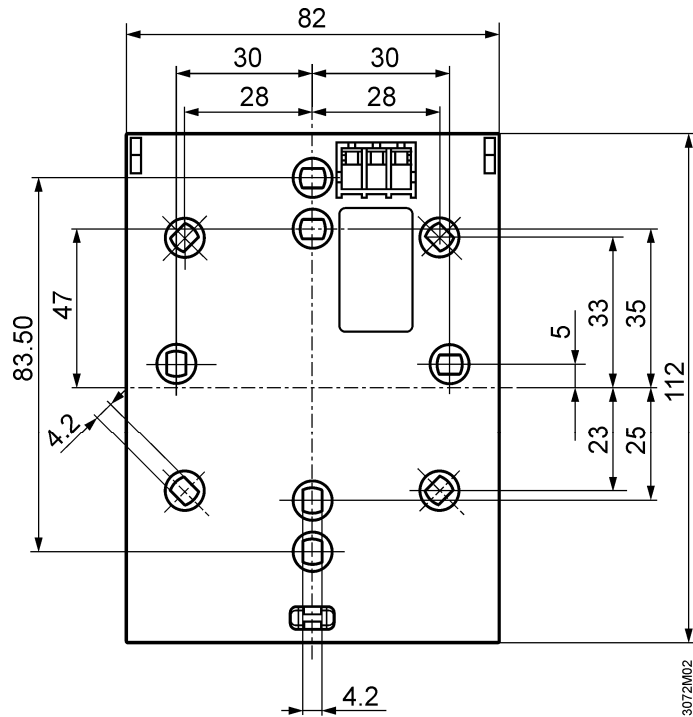

Room temperature controller with fold-out stand

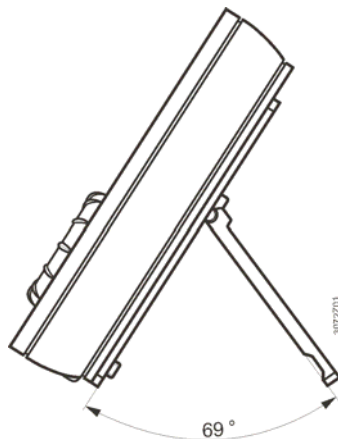

Room temperature receiver and receiver mounting plate

