

Operating Unit w/ Bowdencable Max-Flex Operator handle only
 Handle steel, epoxy coated NEMA 1/3R/12; black=OFF, black=ON



Model	
Product brand name	SENTRON
Product designation	Accessories
Design of the product	Bowden wire actuator
accessories	BOWDEN WIRE ACTUATOR

General technical data	
Degree of protection NEMA rating	NEMA 1, 3R, 12

Certificates			
General Product Approval	EMC	Declaration of Conformity	other



[Miscellaneous](#)

Further information

Information- and Downloadcenter (Catalogs, Brochures,...)
<http://www.siemens.com/lowvoltage/catalogs>

Industry Mall (Online ordering system)

<https://mall.industry.siemens.com/mall/en/en/Catalog/product?mlfb=3VA9978-0CH74>

Service&Support (Manuals, Certificates, Characteristics, FAQs,...)

<https://support.industry.siemens.com/cs/ww/en/ps/3VA9978-0CH74>

Image database (product images, 2D dimension drawings, 3D models, device circuit diagrams, ...)

http://www.automation.siemens.com/bilddb/cax_en.aspx?mlfb=3VA9978-0CH74

CAX-Online-Generator

<http://www.siemens.com/cax>

Tender specifications

<http://www.siemens.com/specifications>

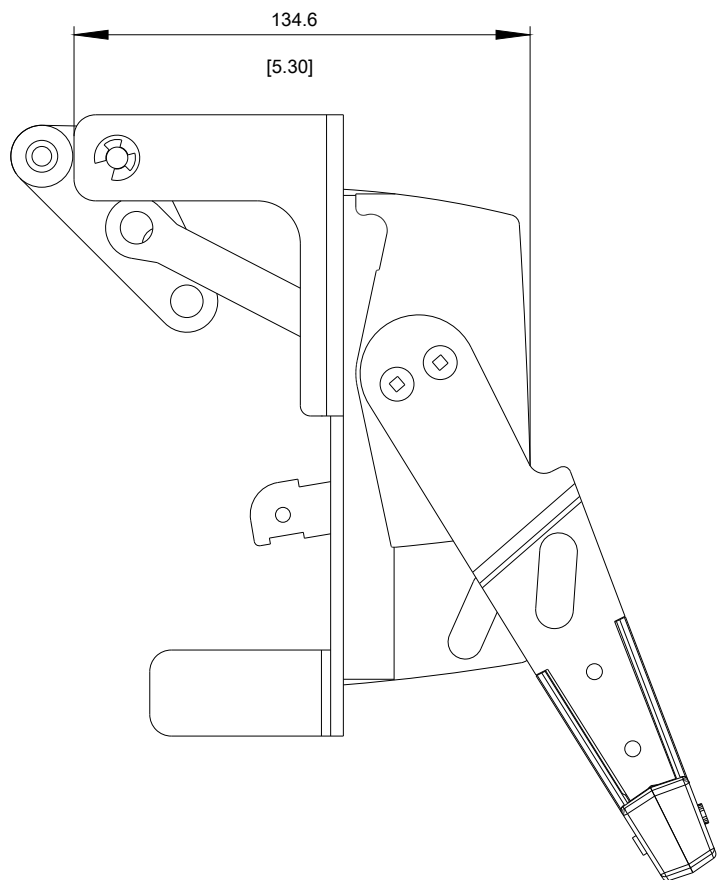
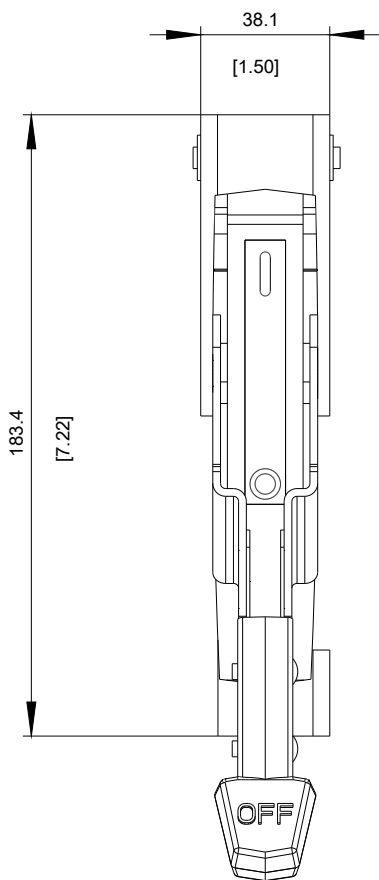

last modified:

11/17/2017