

AS-Interface

Introduction

Communication overview

Overview

AS-Interface is an open, international standard according to EN 50295 and IEC 62026-2 for process and field communication. Leading manufacturers of actuators and sensors all over the world support the AS-Interface. Interested companies are provided with the electrical and mechanical specifications by the AS-Interface Association.

AS-Interface is a single master system. For automation systems from Siemens, there are communications processors (CPs), communications modules (CMs) and routers (links) that control the process or field communication as masters, and actuators and sensors that are activated as AS-Interface slaves.

More information

Homepage, see www.siemens.com/as-interface

Industry Mall, see www.siemens.com/product?as-interface

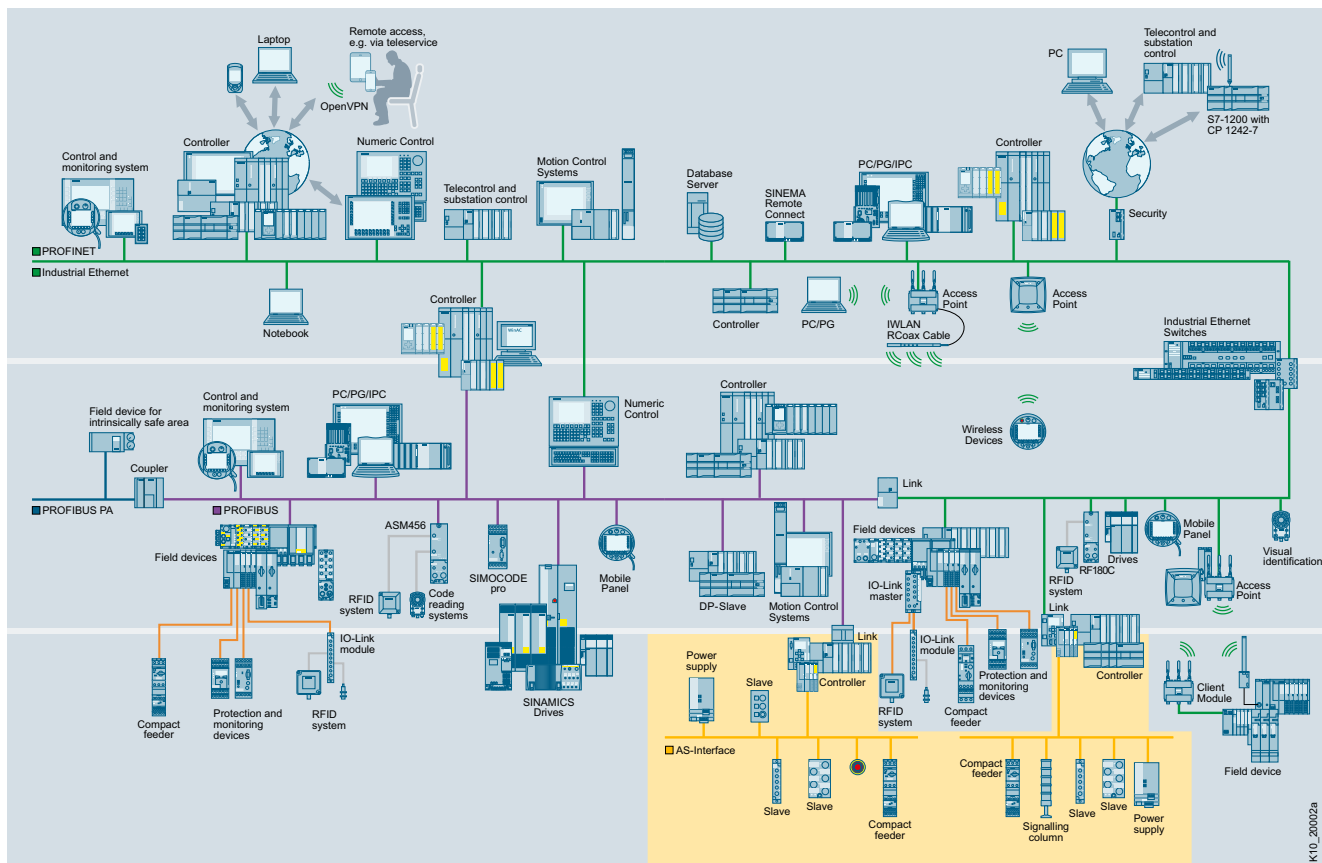

AS-Interface in the SIMATIC NET communications landscape

Benefits

An important characteristic of the AS-Interface technology is the use of a shared two-wire cable for data transmission and distribution of auxiliary power to the sensors and actuators. A power supply unit that meets the requirements of the AS-Interface transmission method and has an external data decoupling module if required is used for the distribution of auxiliary power. The AS-Interface cable used for the wiring is mechanically coded and hence protected against polarity reversal and can be easily contacted by the insulation piercing method.

Elaborately wired control cables in the control cabinet and marshaling racks can be replaced by AS-Interface.

The AS-Interface cable can be connected to any points thanks to a specially developed cable and connection by the insulation piercing method.

With this concept you become extremely flexible and achieve high savings.

Application

I/O data exchange

The AS-i master automatically transfers the inputs and outputs between the controller and the digital and analog AS-Interface slaves. Slave diagnostics information is forwarded to the control system when required.

The latest AS-Interface masters according to the AS-Interface Specification V3.0 support integrated analog value processing. This means that data exchange with analog AS-Interface slaves is just as easy as with digital slaves.

Command interface

In addition to I/O data exchange with binary and analog AS-Interface slaves, the AS-Interface masters can provide a number of other functions through the command interface.

Hence it is possible, for example, for slave addresses to be issued, parameter values transferred or configuration information read out from user programs.

For more information, see <https://support.industry.siemens.com/cs/ww/en/view/51678777>.



Overview

To implement communication, the following components of a system installation are available:

- AS-i modules for central control units such as SIMATIC S7, ET 200M/ET 200SP distributed peripherals, or network transitions from PROFIBUS or PROFINET to AS-Interface
- Power supply unit, if required in combination with a data decoupling module for the power supply to the slaves
- AS-Interface shaped cables

- Network components such as repeaters and extension plugs (cannot be used for AS-i Power24V)
- I/O modules (AS-i slaves) for connection of standard sensors/actuators
- Actuators and sensors with integrated AS-i slave
- Safe I/O modules (ASIsafe slaves) for transmitting safety-related data through AS-Interface
- Addressing device for setting slave addresses during commissioning

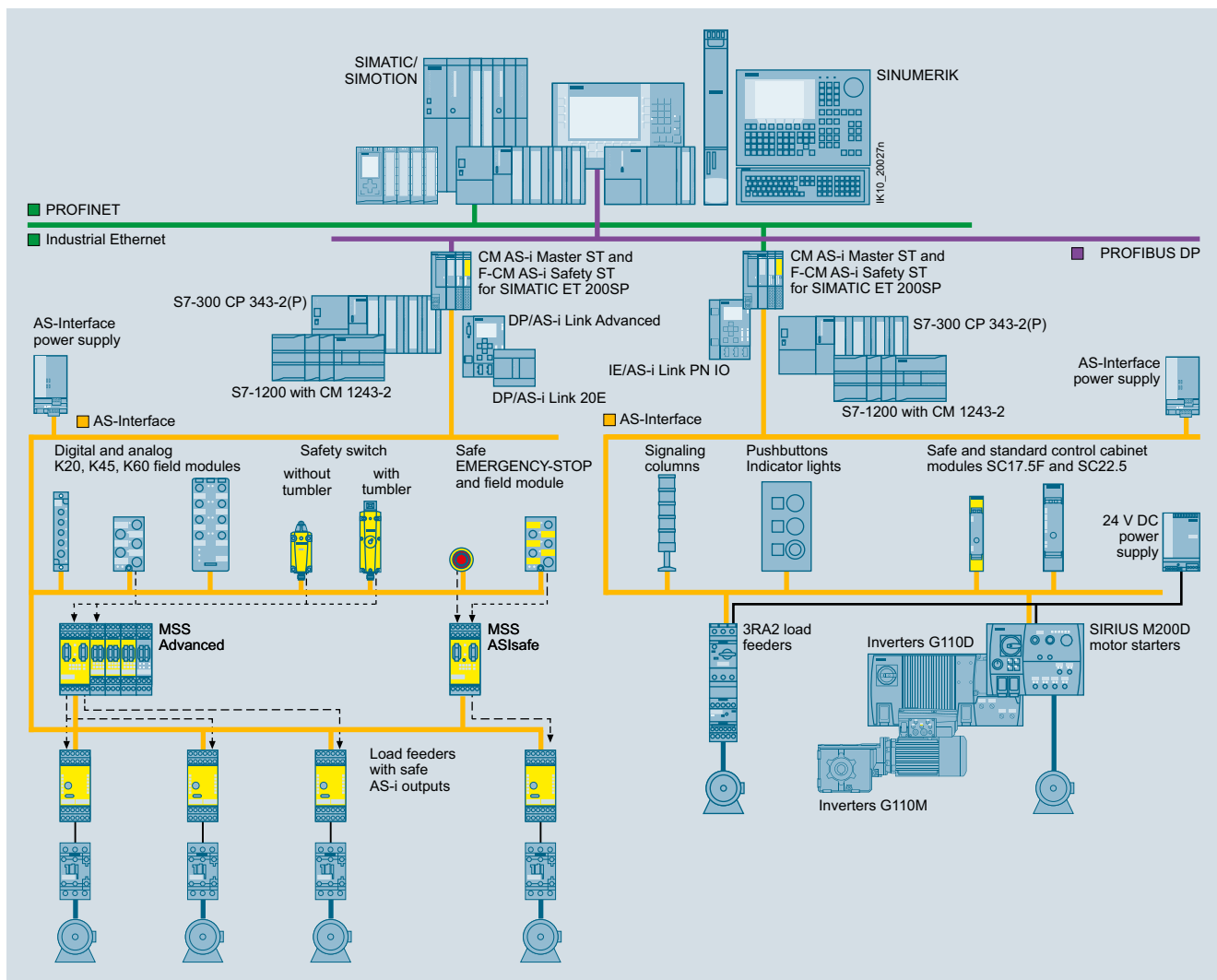

Example of a configuration with the system components

Features

Standard	EN 50295/IEC 62026-2
Topology	Line, star or tree structure (same as electrical wiring)
Transmission medium	Unshielded twisted pair (2 x 1.5 mm ²) for data and auxiliary power
Connection methods	Contacting of the AS-Interface cable by insulation piercing method
Maximum cable length	<ul style="list-style-type: none"> • 100 m without repeater • 200 m with extension plug • 300 m with two repeaters in series connection • 600 m with extension plugs and two repeaters parallel switched Longer cable lengths also possible through parallel switching of more repeaters.

Maximum cycle time	<ul style="list-style-type: none"> • 5 ms in maximum configuration with 31 standard addresses • 10 ms in maximum configuration with 62 A/B addresses • Profile-specific for slaves with extended data, e.g. analog slaves
Number of stations per AS-Interface line	<ul style="list-style-type: none"> • Up to 62 Slaves (A/B technology) • Integrated analog value transmission
Number of binary sensors and actuators	max. 496 DI/496 DQ
Access control	<ul style="list-style-type: none"> • Cyclic polling master/slave procedure • Cyclic data acceptance from host (PLC, PC)
Error safeguard	Identification and repetition of faulty message frames

AS-Interface

Introduction

AS-Interface Specification

Specification V3.0

Overview

Scope of AS-Interface Specification V3.0

Maximum number of slaves			Number of digital inputs	Number of digital outputs
Digital	Analog	ASIsafe	DI	DQ
62	62	31	62 × 8 = 496	62 × 8 = 496

Basic data

- AS-Interface Specification 3.0 describes a fieldbus system with an AS-i master and up to 62 AS-i slaves.
- The standard slaves continue to occupy one AS-i address (1...31).
- Slaves with extended addressing divide an address into an A address (1A...31A) and a B address (1B...31B). Up to 62 A/B slaves can be connected accordingly to one AS-Interface network.
- Mixed operation of standard slaves and A/B slaves is possible without difficulty. The AS-i master identifies automatically which type of slave is connected, so no special adjustments are required of the user.
- One digital AS-i slave typically has up to four digital inputs and four digital outputs.
- Transmission of the digital input/output data requires max. 5 ms cycle time for 31 slaves; for further values, see "Communication cycle".
- Integrated analog value transmission permits access to both analog values and digital values without the need for any special function blocks.

Communication cycle

Maximum cycle time (digital signals)
<ul style="list-style-type: none"> 5 ms with 31 slaves 10 ms with 62 slaves Up to 20 ms for A/B slaves with 4DI/4DQ Up to 40 ms for A/B slaves with 8DI/8DQ

Each address is queried in max. 5 ms cycle time. If two A/B slaves are operated on one basic address (e.g. 12A and 12B), a maximum of 10 ms will be required to update the data of both slaves.

All slave types can be mixed and used on a single AS-Interface network.

For more information, for example, to find out whether an AS-Interface slave is a standard or A/B slave, see "Selection and ordering data" of the relevant slave.

Available masters with the latest AS-Interface specification V3.0

- CM AS-i Master ST, F-CM AS-i Safety ST (ET 200SP)
- CM 1243-2 (S7-1200)
- CP 343-2, CP 343-2P (S7-300/ET 200M)
- IE/AS-i Link PN IO
- DP/AS-i Link Advanced
- DP/AS-Interface Link 20E

More information

More information

"AS-Interface" System Manual

- German
<https://support.industry.siemens.com/cs/de/de/view/26250840>
- English
<https://support.industry.siemens.com/cs/ww/en/view/26250840>

Overview



AS-Interface data decoupling modules for AS-i Power24V
 Left: S22.5 data decoupling module,
 Right: DCM 1271 data decoupling module for SIMATIC S7-1200

Parallel wiring frequently dominates, above all, in applications with very few I/Os. As the AS-Interface is also suitable for small applications, the additionally necessary 30 V AS-Interface power pack often also represents a cost barrier.

With the expansion of the AS-Interface to include AS-i Power24V and the associated option of using the existing standard 24 V DC power supply units in AS-i networks, the AS-Interface is now also opened for extremely tightly calculated applications.

Data and power in standard AS-Interface networks up to now

One of the great advantages of AS-Interface is the ability to convey not only data, but also the power needed for the connected slaves and sensors over the same unshielded two-conductor cable. This is owed to the service-proven AS-Interface power supply units which provide integrated data decoupling as well as overload and short-circuit protection and integrated ground-fault monitoring.

The new technology

Through the expansion of AS-Interface with AS-i Power24V it is now also possible to use 24 V standard power supply units in AS-i networks. The communication technology of AS-Interface works at the same high level of quality with an operating voltage of both 30 V DC and 24 V DC.

Key data of AS-i Power24V	
Number of slaves	Up to 62 standard slaves and up to 31 safe slaves
Topology	Any
Range	Up to 50 m
Components	<ul style="list-style-type: none"> • 24 V power supply unit with low residual ripple and limitation to max. 40 V • AS-i Power24V-capable data decoupling with integrated ground-fault detection • AS-i Power24V-capable masters, slaves and components

Requirements for operation of an AS-i Power24V network

- When 24 V power supply units are used, the maximum network range of 50 m must be observed to reach slaves and sensors with a sufficient level of voltage (at least 18 V).
- The power supply units must comply with the PELV (Protective Extra Low Voltage) or SELV (Safety Extra Low Voltage) standard, have a residual ripple of $< 250 \text{ mV}_{\text{pp}}$, and must limit the output voltage to a maximum of 40 V in the event of a fault. We recommend SITOP power supplies, see page 15/1 onwards.
- When used in conjunction with standard 24 V power supply units, each AS-Interface network requires AS-i Power24V-capable data decoupling with adapted ground-fault detection, see page 2/77.
- For reliable operation of an AS-i network with 24 V voltage, it is important that the masters, slaves and other components are approved for AS-i Power24V. AS-i Power24V-capable AS-i components can also be used without restriction in standard 30 V AS-i networks.
- Use of repeaters or extension plugs in AS-i Power24V networks is not permitted.

Benefits

AS-i Power24V networks incur no additional costs for an AS-Interface power supply unit because a pre-existing 24 V power supply unit can be used. This brings the user several benefits:

- The level of standardization of very small applications can be increased further.
- The additional advantages of a modern communication system in terms of commissioning, maintenance and diagnostics can be fully exploited.

Application

Configuration of an AS-i Power24V network

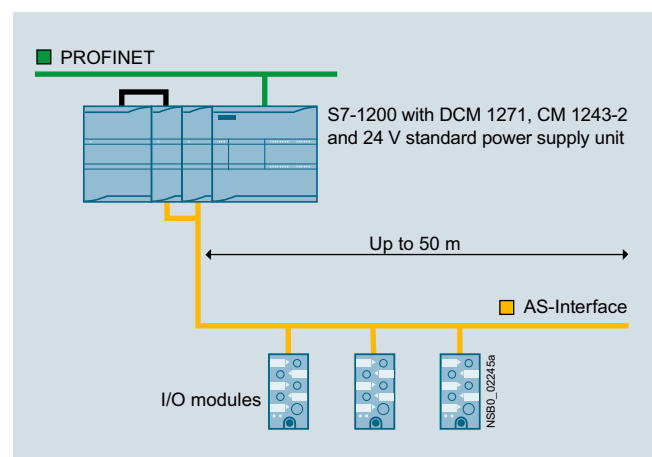

Configuration of an AS-i Power24V network with an AS-Interface DCM 1271 data decoupling module and S7-1200 (simple network)

More information

More information

For a complete overview of AS-i Power24V-capable devices currently available from Siemens, see

<https://support.industry.siemens.com/cs/ww/en/view/42806066>

For details of AS-i Power24V, see "AS-Interface" System Manual, <https://support.industry.siemens.com/cs/ww/en/view/26250840>

AS-Interface

ASIsafe

Introduction

Overview

ASIsafe – Safety is included

ASIsafe enables the integration of safety-related components, such as EMERGENCY-STOP pushbuttons, protective door switches or safety light arrays, in an AS-Interface network. These are fully compatible with the familiar AS-Interface components (masters, slaves, power supplies, repeaters, etc.) in accordance with IEC 62026-2 and are operated in conjunction with them on the yellow AS-Interface cable.

Tested safety

The transmission method for safety-related signals is released for applications up to PL e according to EN ISO 13849-1 and up to SIL 3 (IEC 61508/EN 62061).

Higher-level control

As usual, nodes on the AS-Interface bus are controlled in operation by the standard program of the higher-level SIMATIC (F) CPU or by a SINUMERIK control.

AS-i safety solution with F-CPU

Configuring safety functions

In order to implement safe functions, the information from the safe and standard nodes must be combined logically and further parameters set. The configuration of the safety functions depends on which safety solution is being used:

- AS-i safety solution with F-CPU:
In conjunction with the modular safety AS-i master, which is formed by combining the CM AS-i master ST and F-CM AS-i Safety ST modules in an ET 200SP station, all safety functions and combinations are configured via STEP 7 and processed in the controller (F-CPU) by the fail-safe program.
- In the case of the AS-i safety solution with local evaluation by MSS:
In conjunction with the Modular Safety System all safety functions and combinations are configured using the MSS ES software and processed in the MSS central unit.

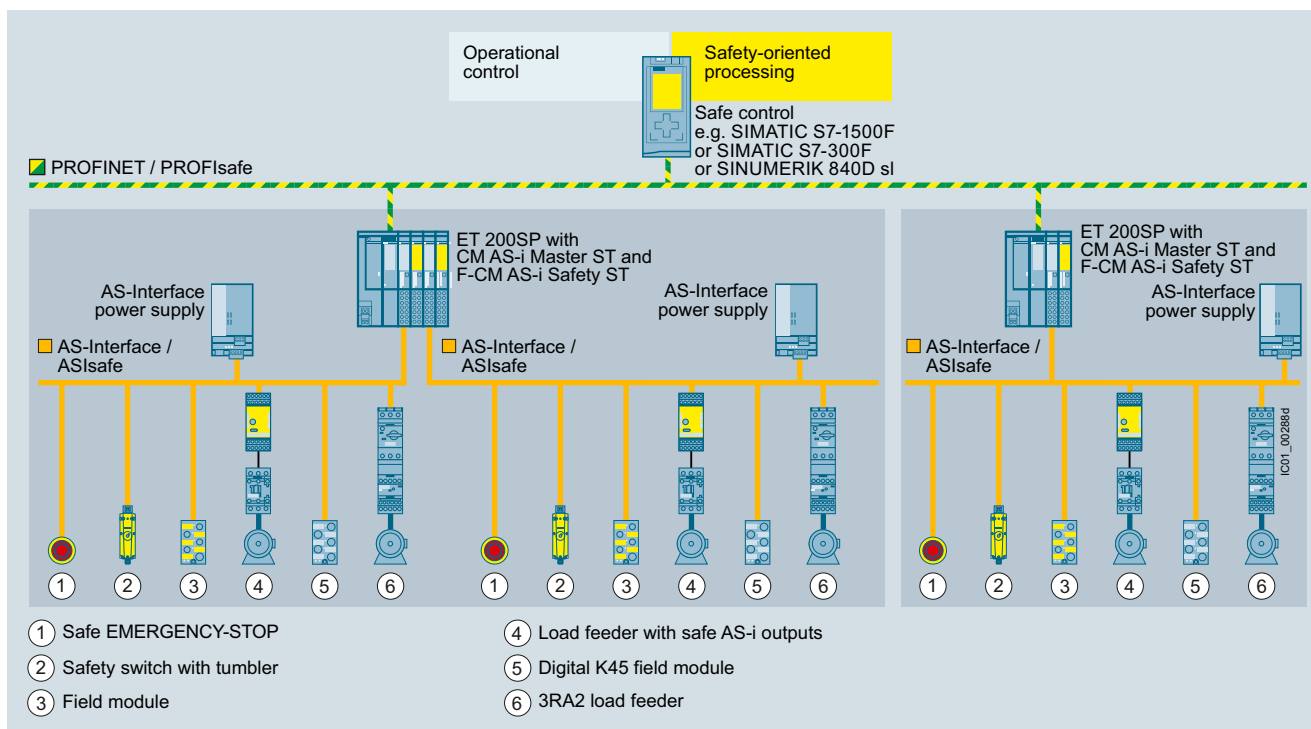

AS-Interface configuration with AS-i Master modules in the ET 200SP

The AS-i communication modules in the ET 200SP facilitate the use of AS-Interface under fail-safe SIMATIC or SINUMERIK controllers.

The allocation of tasks is as follows:

- Acquisition of safety-related signals via safe input slaves on the AS-Interface bus.
Further signals can be detected through other F-DI modules of the SIMATIC.
- Evaluation and processing of signals via the fail-safe SIMATIC or SINUMERIK control
- Reacting by means of safety output modules on the AS-Interface bus or other SIMATIC F-DQ modules

Simple combination of the CM AS-i Master ST and F-CM AS-i Safety ST modules in one ET 200SP station results in a powerful, safety-oriented network transition between PROFINET (or PROFIBUS) and AS-Interface, which can be expanded further in a modular fashion with further I/O modules of the ET 200SP.

Using these design methods, it is possible to create configurations for virtually any application. Besides the single AS-i master, double, triple or generally multiple masters can be realized with or without fail-safe functionality.

AS-i safety solution with local evaluation by MSS

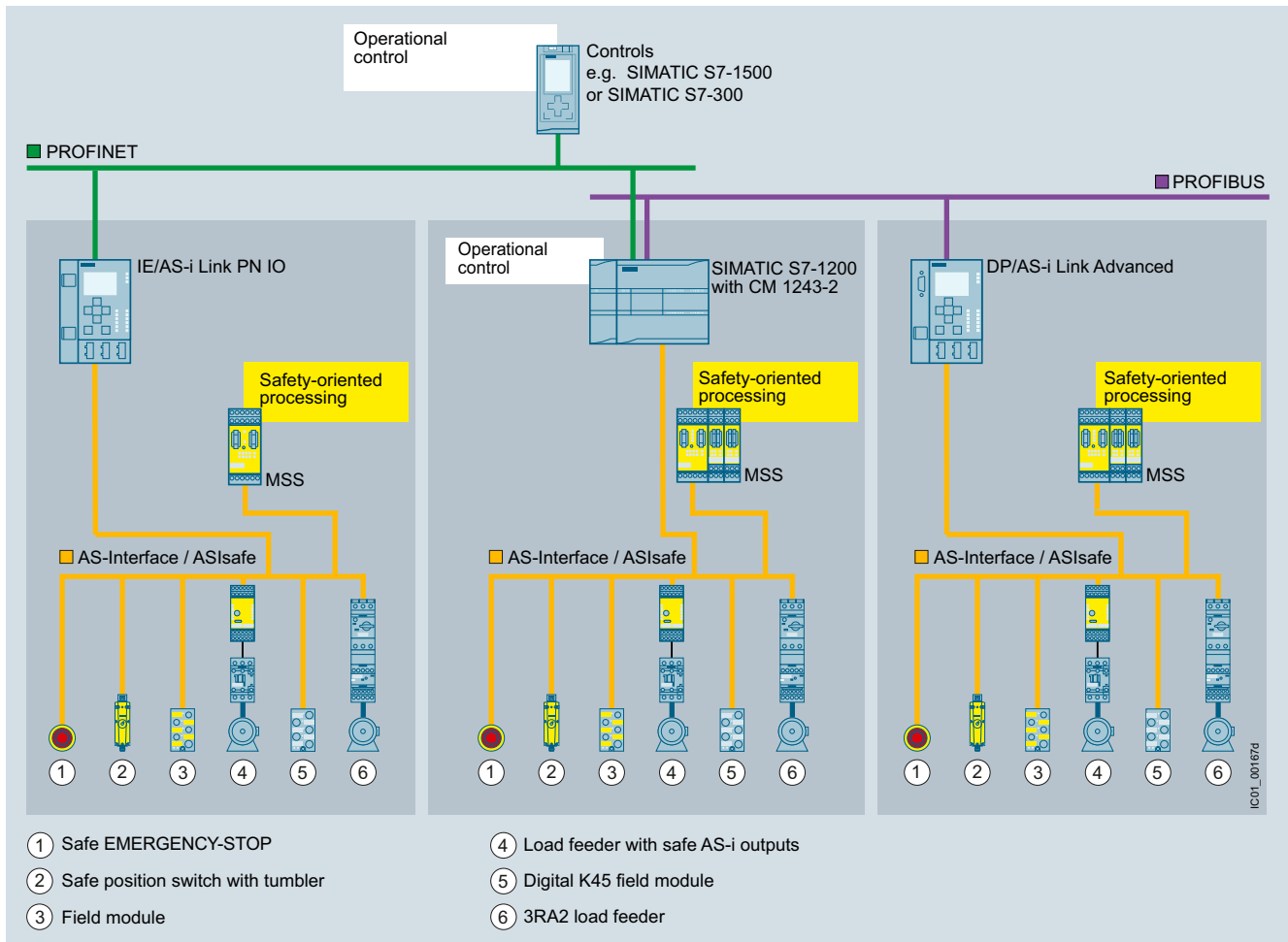

AS-Interface design with 3RK3 Modular Safety System (MSS)

The local AS-i safety solution uses the 3RK3 Modular Safety System (MSS) for safety-related processing. In this case, one standard controller (i.e. no F-CPU) and one standard AS-i master are sufficient.

The allocation of tasks is as follows:

- Acquisition of safety-related signals via safe input slaves on the AS-Interface bus.
Further signals can be acquired via F-DI inputs of the central unit or the expansion modules of the MSS.

- Acquisition and processing of signals via the central unit of the MSS
- Reaction via safe output modules on the AS-Interface bus or via F-DQ outputs of the central unit or expansion modules of the MSS

Benefits

- Simple system structure thanks to standardized AS-Interface technique
- Safety-related and standard data on the same bus
- Existing systems can be expanded quickly and easily
- Optimum integration in TIA (Safety Diagnostics) and Safety Integrated
- Inclusion of the safety signals in the plant diagnostics, also on existing HMI panels
- Approved to PL e according to EN ISO 13849-1 or SIL 3 according to IEC 61508
- ASIsafe is certified by TÜV (Germany), NRTL (USA) and INRS (France)

Application

Integrated safety technology in the AS-Interface system can be used wherever EMERGENCY-STOP buttons, safety gate

interlocks, safety switches, light grids and two-hand operation are installed.

More information

More information

For further information and typical circuit diagrams on safety engineering, see <https://support.industry.siemens.com/cs/ww/en/view/83150405>.

AS-Interface ASIsafe

SIRIUS 3RK3 Modular Safety System

Overview

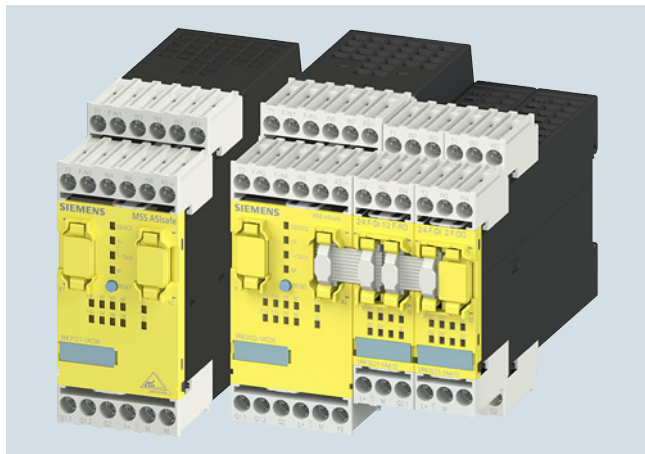

MSS ASIsafe basic (left) and
MSS ASIsafe extended with two expansion modules (right)

The Modular Safety System (MSS) is the centerpiece of ASIsafe Solution local. It allows a safety-related response to signals from the ASIsafe nodes connected in the AS-i network, such as safety input modules, EMERGENCY-STOP pushbuttons or safety switches.

The MSS thus supports safety-related applications up to Category 4 according to EN ISO 13849-1 or SIL 3 according to IEC 62061.

Safe disconnection takes place via the local safety outputs of the MSS or via the distributed safe AS-Interface outputs in the AS-Interface network.

The safety functions are configured within the MSS using the SIRIUS Safety ES software. The configuration can be transmitted directly in the MSS via the system interface with the aid of a PC cable or memory module. If the DP interface module is used, transmission via PROFIBUS DP is also possible.

The MSS supports a large number of different safety functions. These can be tailored to individual needs in the form of ready-made function blocks.

The safety functions supported include the following:

- EMERGENCY-STOP
- Safety shutdown mat
- Protective door monitoring
- Protective door tumbler mechanism
- Approval switches
- Two-hand operator controls
- ESPE monitoring
- Muting
- Mode selector switches

Application

All the MSS that can be used for the AS-Interface bus support the same safety functions. Differences exist in the number of inputs/outputs and expansion modules that can be connected, and hence in the number of independent enabling circuits.

Several MSS can be used on the same AS-Interface bus.

AS-Interface is available in the following versions:

MSS ASIsafe basic

- A total of up to ten independent (2-channel) enabling circuits
 - Two of these enabling circuits via safety outputs integrated into the central unit
 - And another eight enabling circuits via ASIsafe, e.g. with distributed AS-i safety outputs

MSS ASIsafe extended

- A total of up to 20 independent (2-channel) enabling circuits
 - Two of these enabling circuits via safety outputs integrated into the central unit
 - In addition, up to eight enabling circuits via a maximum of two expansion modules
 - And another ten enabling circuits via ASIsafe, e.g. with distributed AS-i safety outputs

MSS Advanced

- A total of up to 50 independent (2-channel) enabling circuits
 - Two of these enabling circuits via safety outputs integrated into the central unit
 - In addition, up to 36 enabling circuits via a maximum of nine expansion modules
 - and another 12 enabling circuits via ASIsafe, e.g. with distributed AS-i safety outputs

Expandability

All versions above can be expanded by adding a DP interface module and a diagnostics module. In addition, various safety and non-safety expansion modules can be selected for the MSS, and these can be used in any combination, [see page 11/39](#).

Comparison of the three MSS versions

MSS 3RK3	ASIsafe basic	ASIsafe extended	Advanced
Number of independent (2-channel) enabling circuits	2 ... 10	2 ... 20	2 ... 50
Inputs	2 F-DI and 6 DI	4 F-DI and 4 DI (expandable)	8 F-DI (expandable)
Outputs	1 F-DO and 1 F-RO	1 F-DO and 1 F-RO (expandable)	
Number of expansion modules	--	Up to 2	Up to 9
Connection to ASIsafe			
Number of safe AS-i outputs	Up to 8	Up to 10	Up to 12
Number of safe AS-i inputs	Up to 31		

-- Not available

Software for start-up, testing and diagnostics: SIRIUS Safety ES

SIRIUS Safety ES is the engineering software for configuration, startup and diagnostics of the 3RK3 Modular Safety System and the 3SK2 safety relays.

All function elements can be positioned using drag & drop. All functions – whether safety or logic functions – are available as blocks and can also be easily combined with one another.

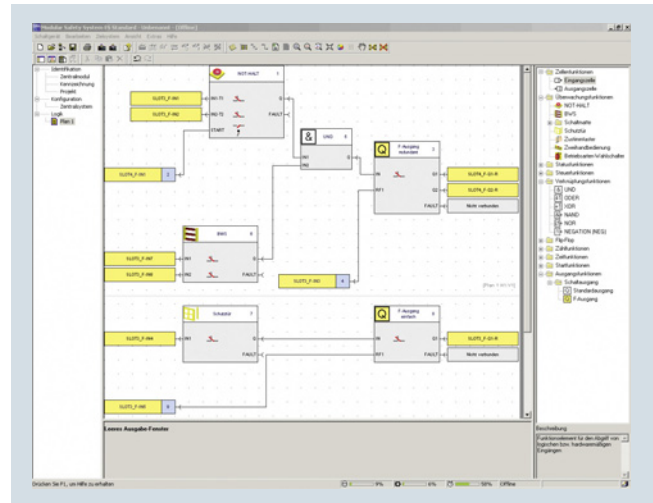

SIRIUS Safety ES makes it possible to test the safety application by forcing. Outputs can be individually set in order to test in advance the reaction of the downstream safety function. In addition, the parameterization can be downloaded to the MSS via PROFIBUS. The integrated macro function allows you to compile a library of your own function elements for reuse in other projects. In addition, the parameterization software is suitable for use as a reliable diagnostics tool: the status of each element as well as the configuration as a whole can be viewed online.



SIRIUS Safety ES user interface showing the ISO diagram display

Selection and ordering data

PU (UNIT, SET, M) = 1
PS* = 1 unit
PG = 42B

Version	SD	Screw terminals 	SD	Spring-type terminals 	
	d	Article No.	Price per PU d	Article No.	Price per PU

Central units

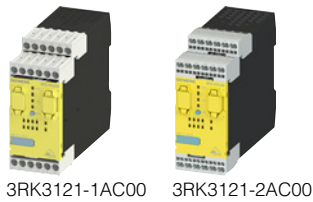

3RK3121-1AC00 3RK3121-2AC00

3RK3 ASIsafe basic
Central units for connecting to AS-Interface with safety-related inputs and outputs

- 2 safe inputs
- 6 standard inputs
- 1 two-channel relay output
- 1 two-channel electronic output
- Memory module 3RK3931-0AA00 is included in the scope of supply
- No expansion modules can be connected

2

3RK3121-1AC00

2

3RK3121-2AC00

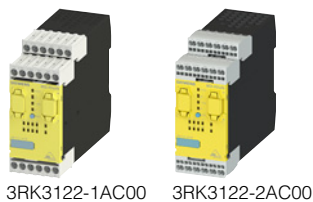

3RK3122-1AC00 3RK3122-2AC00

3RK3 ASIsafe extended
Central units for connecting to AS-Interface with safety-related inputs and outputs

- 4 safe inputs
- 4 standard inputs
- 1 two-channel relay output
- 1 two-channel electronic output
- Memory module 3RK3931-0AA00 is included in the scope of supply
- Max. 2 expansion modules can be connected

2

3RK3122-1AC00

2

3RK3122-2AC00



3RK3131-1AC10 3RK3131-2AC10

3RK3 Advanced
Central units for connecting to AS-Interface with safety-related inputs and outputs

- 8 safe inputs
- 1 two-channel relay output
- 1 two-channel electronic output
- Memory module 3RK3931-0AA00 is included in the scope of supply
- Max. 9 expansion modules can be connected

2

3RK3131-1AC10

2

3RK3131-2AC10

AS-Interface

ASIsafe

SIRIUS 3RK3 Modular Safety System

PU (UNIT, SET, M) = 1
 PS* = 1 unit
 PG = 42B

Version	SD	Screw terminals	SD	Spring-type terminals	
	d	Article No.	Price per PU	Article No.	Price per PU

Expansion modules

 3RK3211-1AA10	 3RK3211-2AA10	4/8 F-DI Safety-related input modules • 8 inputs	2	3RK3211-1AA10	2	3RK3211-2AA10
 3RK3221-1AA10	 3RK3221-2AA10	2/4 F-DI 1/2 F-RO Safety-related input/output modules • 4 inputs • 2 single-channel relay outputs	2	3RK3221-1AA10	2	3RK3221-2AA10
 3RK3231-1AA10	 3RK3231-2AA10	2/4 F-DI 2 F-DO Safety-related input/output modules • 4 inputs • 2 two-channel electronic outputs	2	3RK3231-1AA10	2	3RK3231-2AA10
 3RK3251-1AA10	 3RK3251-2AA10	4/8 F-RO Safety-related output modules • 8 single-channel relay outputs	2	3RK3251-1AA10	2	3RK3251-2AA10
 3RK3242-1AA10	 3RK3242-2AA10	4 F-DO Safety-related output modules • 4 two-channel electronic outputs	2	3RK3242-1AA10	2	3RK3242-2AA10
 3RK3321-1AA10	 3RK3321-2AA10	8 DI Standard input module • 8 inputs	2	3RK3321-1AA10	2	3RK3321-2AA10
 3RK3311-1AA10	 3RK3311-2AA10	8 DO Standard output module • 8 solid-state outputs	2	3RK3311-1AA10	2	3RK3311-2AA10
 3RK3511-1BA10	 3RK3511-2BA10	DP interface PROFIBUS DP interface, 12 Mbps, RS 485, cyclic and acyclic data exchange	2	3RK3511-1BA10	2	3RK3511-2BA10

Accessories

Version	SD	Article No.	Price per PU	PU (UNIT, SET, M)	PS*	PG	
	d						
Connection cables (essential accessory)							
 3UF7932-0AA00-0	For connection of						
	Central units with expansion modules or interface module	Diagnostics modules with central unit or interface module					
	✓	✓	• Length 0.025 m (flat) ▶	3UF7930-0AA00-0	1	1 unit	42J
	--	✓	• Length 0.1 m (flat) ▶	3UF7931-0AA00-0	1	1 unit	42J
	--	✓	• Length 0.3 m (flat) ▶	3UF7935-0AA00-0	1	1 unit	42J
	--	✓	• Length 0.5 m (flat) ▶	3UF7932-0AA00-0	1	1 unit	42J
	--	✓	• Length 0.5 m (round) ▶	3UF7932-0BA00-0	1	1 unit	42J
	--	✓	• Length 1.0 m (round) ▶	3UF7937-0BA00-0	1	1 unit	42J
--	✓	• Length 2.5 m (round) ▶	3UF7933-0BA00-0	1	1 unit	42J	

Operating and monitoring modules for 3RK3 **NEW**

 3SK2611-3AA00	Diagnostics module	2	3SK2611-3AA00	1	1 unit	41L
	For direct display of errors, e.g. of cross-circuits					

Additional accessories for MSS, [see page 11/40](#).

More information

More information



Modular safety system (MSS), [see from page 11/30 onwards](#)
SIRIUS Safety ES software, [see from page 14/26 onwards](#)

System Manual "SIRIUS 3RK3 Modular Safety System (MSS)", [see https://support.industry.siemens.com/cs/ww/en/view/26493228](https://support.industry.siemens.com/cs/ww/en/view/26493228)

AS-Interface ASIsafe

AS-Interface safety monitors

Selection and ordering data

Version	SD	Article No.	Price per PU	PU (UNIT, SET, M)	PS*	PG	
	d						
 3RK1105-1BE04-0CA0	Basic safety monitors						
	Version 3 With screw terminals, removable terminals, width 45 mm						
	• 1 enabling circuit (monitor type 1)	2	3RK1105-1AE04-0CA0		1	1 unit	42C
	• 2 enabling circuits (monitor type 2)	2	3RK1105-1BE04-0CA0		1	1 unit	42C
	Expanded safety monitors						
	Version 3 With screw terminals, removable terminals, width 45 mm						
	• 1 enabling circuit (monitor type 3)	2	3RK1105-1AE04-2CA0		1	1 unit	42C
	• 2 enabling circuits (monitor type 4)	2	3RK1105-1BE04-2CA0		1	1 unit	42C
	Expanded safety monitor with integrated safe slave						
	Version 3 With screw terminals, removable terminals, width 45 mm						
	• 2 enabling circuits including control of a safe AS-i output/ safe coupling (monitor type 6)	2	3RK1105-1BE04-4CA0		1	1 unit	42C
		Basic safety monitors					
Version 3 With spring-type terminals, removable terminals, width 45 mm							
• 1 enabling circuit (monitor type 1)		2	3RK1105-1AG04-0CA0		1	1 unit	42C
• 2 enabling circuits (monitor type 2)		2	3RK1105-1BG04-0CA0		1	1 unit	42C
Expanded safety monitors							
Version 3 With spring-type terminals, removable terminals, width 45 mm							
• 1 enabling circuit (monitor type 3)		2	3RK1105-1AG04-2CA0		1	1 unit	42C
• 2 enabling circuits (monitor type 4)		2	3RK1105-1BG04-2CA0		1	1 unit	42C
Expanded safety monitor with integrated safe slave							
Version 3 With spring-type terminals, removable terminals, width 45 mm							
• 2 enabling circuits including control of a safe AS-i output/ safe coupling (monitor type 6)		2	3RK1105-1BG04-4CA0		1	1 unit	42C

Accessories

Version	SD	Article No.	Price per PU	PU (UNIT, SET, M)	PS*	PG	
	d						
 3RK1901-5AA00	ASIsafe CD	2	3RK1802-2FB06-0GA1		1	1 unit	42C
	Included in the scope of supply:						
	• ASIMON V3 configuration software on CD ROM, for PC with the 32-bit operating systems Windows XP, Windows Vista Business/Ultimate, Windows 7						
	Cable sets	▶	3RK1901-5AA00		1	1 unit	42C
	Included in the scope of supply:						
• PC configuration cable for communication between PC (serial interface) and safety monitor, length approx. 1.50 m							
• Transfer cable between two safety monitors, length approx. 0.25 m							
	5	3RP1902		1	5 units	41H	
Sealable covers For securing against unauthorized configuration of the safety monitor							
	5	3RP1903		1	10 units	41H	
Push-in lugs For screw fixing							

Overview



AS-Interface safety modules: K45F (left), K20F (center) and SC17.5F (right)



S45F SlimLine module, safe AS-i output

Safety modules for AS-Interface (ASIsafe modules) are available for field use in degree of protection IP67 (K20F and K45F compact modules) and for the control cabinet (SC17.5F SlimLine Compact modules) in degree of protection IP20.

A very compact module with an optimum price/performance ratio is thus available for very application.

All modules for the connection of (mechanical) switches and safety sensors with contacts feature crossover monitoring of the connected sensor line. On versions for the connection of electronic switches and safety sensors (e.g. light arrays) the cross-circuit monitoring must be performed by the sensor.

AS-Interface safety modules

The following modules are available for selection:

K20F compact safety modules for operation in the field

Being only 20 mm wide, the K20F module is particularly well suited for applications where modules need to be arranged in the most confined of spaces. The K20F modules are connected to the AS-Interface with a round cable with M12 cable box instead of with the AS-Interface flat cable. This enables extremely compact installation. The flexibility of the round cable means that it can also be used on moving machine parts without any problems. The K20 modules are also ideal for such applications as their non-encapsulated design makes them particularly light in weight.

K45F compact safety modules for use in the field

The platform of the K45F modules covers the following variations:

- Connection of ("mechanical") switches/safety sensors with contacts:
 - K45F 2F-DI: Two safety-related inputs in operation up to Category 2 according to EN ISO 13849-1. If Category 4 is required, a two-channel input is available on the module.
 - K45F 2F-DI/2DQ: There are also two standard outputs in addition to the safe inputs. Supplied from the yellow AS-i cable
 - K45F 2F-DI/2DQ U_{aux} : same as K45F 2F-DI/2DQ, but supplied from the black 24 V DC cable
 - K45F 4F-DI: Four safety-related inputs in operation up to Category 2, two for Category 4. Extremely compact double slave (uses two full AS-i addresses).
 - Connection of solid-state switches/safety sensors (non-contact protective devices, BWS):
 - K45F LS (light sensor): Safe input module for the connection of electronic safety sensors with testing semiconductor outputs (OSSD)
- In particular non-contact protective devices such as active, optoelectronic light arrays and light curtains for Type 2 and Type 4 according to IEC 61496. Transmitters as well as receivers are supplied with power from the yellow AS-i cable. Matching sensor cables and optionally a separate transmitter supply module are available as accessories.

SC17.5F SlimLine Compact safety modules with a width of just 17.5 mm for use in control cabinets and local control boxes

With a width of only 17.5 mm, the safe SlimLine Compact modules SC17.5F are ideal for space-saving use in a control cabinet. The modules have more than two safety inputs for connecting signals to ASIsafe networks in the control cabinet. For operation up to Category 2, both inputs can be separately assigned; if Category 4 is required, a two-channel input is available on the module.

There are also two module variants which have two standard outputs in addition to the two safety inputs. The outputs are supplied either from the yellow AS-Interface cable alone, or via auxiliary voltage from the black 24 V DC cable. The supply voltage is set via a slide switch on the rear of the device.

When using several modules, they can be connected simply via the optional device connector. This simplifies the wiring. The yellow AS-i bus cable and the 24 V DC auxiliary voltage U_{aux} then only need to be connected to one module.

AS-Interface

ASIsafe

AS-Interface safety modules

S45F SlimLine safety modules with safety outputs for the safe distributed disconnection of actuators

With the S45F SlimLine safety module, the shutdown signal, for example from the Modular Safety System, can be used via ASIsafe for distributed safety-related disconnection.

To this end, the module has a two-channel relay output. As an additional possibility the module offers normal switching of the output using an AS-i standard output bit.

The module has three digital inputs and two digital outputs for the additional connection of sensors and actuators. These can be used, among other things, for the required monitoring of downstream contactors of the feedback circuit.

Selection and ordering data

Version	SD	Article No.	Price per PU	PU (UNIT, SET, M)	PS*	PG
K20F compact safety modules						
I/O type		U_{aux} 24 V				
2F-DI	--	2	3RK1205-0BQ30-0AA3	1	1 unit	42C
K45F compact safety modules						
Modules supplied without mounting plate						
I/O type		U_{aux} 24 V				
2F-DI	--	▶ 2	3RK1205-0BQ00-0AA3	1	1 unit	42C
4F-DI ¹⁾	--	2	3RK1205-0CQ00-0AA3	1	1 unit	42C
2F-DI/2DQ	--	5	3RK1405-0BQ20-0AA3	1	1 unit	42C
2F-DI/2DQ	✓	5	3RK1405-1BQ20-0AA3	1	1 unit	42C
2F-DI LS type 2 ²⁾	--	5	3RK1205-0BQ21-0AA3	1	1 unit	42C
2F-DI LS type 4 ³⁾	--	5	3RK1205-0BQ24-0AA3	1	1 unit	42C
SC17.5F SlimLine Compact safety modules						
(Slave type: Standard)						
Connection	I/O type	Outputs				
Screw	⊕ 2F-DI	--	2	3RK1205-0BE00-2AA2	1	1 unit 42C
Spring-type (push-in)	⊕		2	3RK1205-0BG00-2AA2	1	1 unit 42C
Screw	⊕ 2F-DI/2Q	U_{ASi}/U_{aux} supply selectable	2	3RK1405-2BE00-2AA2	1	1 unit 42C
Spring-type (push-in)	⊕		2	3RK1405-2BG00-2AA2	1	1 unit 42C
S45F SlimLine safety module						
(with safe AS-i output)						
Connection	I/O type	U_{aux} 24 V				
Screw	⊕ 1F-RQ/3DI/2DQ	✓	2	3RK1405-1SE15-0AA2	1	1 unit 42C
Spring-type	⊕		2	3RK1405-1SG15-0AA2	1	1 unit 42C

✓ Available or possible

-- Not available or not possible

¹⁾ Module occupies two AS-Interface addresses

²⁾ Connection of previous Siemens light curtain FS 400 3RG7843 (type 2) through socket 1/3.

³⁾ Connection of previous Siemens light curtain FS 400 3RG7846 (type 4) through socket 1/3, other makes through socket 2/3.

The existing SlimLine series of I/O modules for use in the control cabinet and local control boxes is being replaced by the new SlimLine Compact series. We recommend that these new devices are used in future.

For the conversion table, [see page 2/73](#).

Note:

The previous SlimLine devices are still available for use as replacements in existing systems. As a result of the innovation, the new SlimLine Compact devices are not fully compatible in terms of either mechanical dimensions or electrical properties.

Accessories

Version	SD	Article No.	Price per PU	PU (UNIT, SET, M)	PS*	PG	
Accessories for compact safety modules							
	▶	K45 mounting plates For mounting K45F					
		• For wall mounting	3RK1901-2EA00	1	1 unit	42C	
		• For standard rail mounting	3RK1901-2DA00	1	1 unit	42C	
3RK1901-2EA00	5	24 V supply modules for K45F LS (light sensor)	3RK1901-1NP00	1	1 unit	42C	
		• Optional, for transmitter power supply for large protective field widths • Max. current carrying capacity 200 mA • Modules supplied without mounting plate					
	2 30	Input bridges for K45F					
		• Black version	3RK1901-1AA00	1	1 unit	42C	
3RK1901-1AA00		• Red version	3RK1901-1AA01	1	1 unit	42C	
	▶	AS-Interface sealing caps M12 For free M12 sockets	3RK1901-1KA00	100	10 units	42C	
		3RK1901-1KA00					
	2	AS-Interface M12 sealing caps, tamper-proof For free M12 sockets	3RK1901-1KA01	100	10 units	42C	
		3RK1901-1KA01					
Accessories for SlimLine Compact safety modules							
	2 2	Device connectors For the electrical connection of SlimLine Compact modules (connects AS-i bus cable and 24 V DC auxiliary power supply U_{aux} when using several SlimLine Compact modules)					
		• Width 17.5 mm	3RK1901-1YA00	1	1 unit	42C	
		• Width 22.5 mm	3RK1901-1YA10	1	1 unit	42C	
3RK1901-1YA00		Device termination connectors Required for the last module in the network					
3RK1901-1YA01		• Width 17.5 mm	3RK1901-1YA01	1	1 unit	42C	
		• Width 22.5 mm	3RK1901-1YA11	1	1 unit	42C	
	2 2	Removable terminals	Screw terminals 				
		• Screw terminals up to 2 x 1.5 mm ² or 1 x 2.5 mm ² - 2-pole - 4-pole	3ZY1121-1BA00	1	6 units	41L	
			3ZY1141-1BA00	1	6 units	41L	
	2 2	• Push-In terminals up to 2 x 1.5 mm ² - 2-pole - 4-pole	Spring-type terminals (push-in) 				
			3ZY1121-2BA00	1	6 units	41L	
			3ZY1141-2BA00	1	6 units	41L	
	2	Push-in lugs for wall mounting Two lugs are required per device	3ZY1311-0AA00	1	10 units	41L	
	2	Coding pins for removable terminals For mechanical coding of the terminals	3ZY1440-1AA00	1	12 units	41L	
	20 20	Blank labels Unit labeling plates ¹⁾					
		• 10 mm x 7 mm, titanium gray	3RT2900-1SB10	100	816 units	41B	
		• 20 mm x 7 mm, titanium gray	3RT2900-1SB20	100	340 units	41B	
3RT2900-1SB20		Tools for opening spring-type terminals	Spring-type terminals (push-in) 				
	2	Screwdriver for SIRIUS devices with spring-type terminals 3.0 mm x 0.5 mm, length approx. 200 mm, titanium gray/black, partially insulated	3RA2908-1A	1	1 unit	41B	
		3RA2908-1A					

¹⁾ PC labeling system for individual inscription of unit labeling plates available from: murrplastik Systemtechnik GmbH (see page 16/15).

More information

More information

For the Manual "AS-Interface SlimLine Compact Modules", see <https://support.industry.siemens.com/cs/ww/en/view/109481489>

AS-Interface

Masters

Masters for SIMATIC S7

CM 1243-2

Overview



CM 1243-2 communication module for S7-1200

The CM 1243-2 communication module is the AS-Interface master for the SIMATIC S7-1200 and has the following features:

- Connection of up to 62 AS-Interface slaves
- Integrated analog value transmission
- Supports all AS-Interface master functions in accordance with the AS-Interface Specification V3.0
- Indication of the operating state on the front of the device displayed via LED
- Display of operating mode, AS-Interface voltage faults, configuration faults and peripheral faults via LED behind the front panel
- Compact enclosure in the design of the SIMATIC S7-1200
- Suitable for AS-i Power24V: A standard 24 V power supply unit can be used in combination with the optional DCM 1271 data decoupling module.
- Configuration and diagnostics via the TIA portal

Design

The CM 1243-2 communication module is positioned to the left of the S7-1200 CPU and linked to the S7-1200 via lateral contacts.

It has:

- Terminals for two AS-i cables (internally jumpered) via two screw terminals each respectively
- One terminal for connection to the functional ground
- LEDs for indication of the operating state and fault statuses of the connected slaves

The screw terminals (included in scope of supply) can be removed to facilitate installation.

Function

The CM 1243-2 supports all specified functions of the AS-Interface Specification V3.0.

The values of the digital AS-i slaves can be activated via the process image of the S7-1200. During configuration of the slaves in the TIA Portal, the values of the analog AS-i slaves can also be accessed directly in the process image.

It is also possible to exchange all data of the AS-i master and the connected AS-i slaves with the S7-1200 via the data record interface.

Changeover of the operating mode, automatic application of the slave configuration and the re-addressing of a connected AS-i slave can be implemented via the control panel of the CM 1243-2 in the TIA Portal.

The optional DCM 1271 data decoupling module ([see page 2/33](#)) has an integrated detection unit for detecting ground faults on the AS-Interface cable. The integrated overload protection also disconnects the AS-Interface cable if the drive current required exceeds 4 A. For more information on DCM 1271, [see page 2/84](#).

Notes on security

In order to protect plants, systems, machines and networks against cyber threats, it is necessary to implement – and continuously maintain – a holistic, state-of-the-art industrial security concept. Siemens products and solutions represent only one component of such a concept.

For more information about the subject of Industrial Security, [see www.siemens.com/industrialsecurity](http://www.siemens.com/industrialsecurity).

Configuration

To configure CM 1243-2, you require STEP 7 V11 + SP2 or higher.

For STEP 7 V11 + SP2 or higher, the additional Hardware Support Package for CM 1243-2 is required. This is available via the Industry Online Support Portal, [see https://support.industry.siemens.com/cs/ww/en/view/72341852](https://support.industry.siemens.com/cs/ww/en/view/72341852).

The software enables user-friendly configuration and diagnostics of the AS-Interface master and any connected slaves.

Alternatively, you can also apply the AS-Interface ACTUAL configuration at the "touch of a button" via the control panel integrated in the TIA Portal/STEP 7.

When operated on an S7-1200 CPU with firmware version V4.0 or higher, the firmware version V1.1 (or higher) is required for the CM 1243-2.

Benefits

- More flexibility and versatility in the use of SIMATIC S7-1200 as the result of a significant increase in the number of digital and analog inputs/outputs available
- Very easy configuration and diagnostics of the AS-Interface via the TIA Portal (STEP 7 V11+SP2 or higher)
- No need for the AS-i power supply unit with AS-i Power24V: the AS-Interface cable is supplied through an existing 24 V DC PELV power supply unit. For decoupling, the AS-i DCM 1271 data decoupling module is required, see "Accessories" and page 2/84.
- LEDs for indication of fault statuses for fast diagnostics
- Monitoring of AS-Interface voltage facilitates diagnostics

Application



The CM 1243-2 is the AS-Interface master connection for the 12xx CPUs of the SIMATIC S7-1200. Through connection to AS-Interface, the number of digital inputs and outputs available for the S7-1200 is greatly increased (max. 496 DI/496 DQ on the AS-Interface per CM).

The integrated analog value processing also makes the analog values available at the AS-Interface for the S7-1200 (per CM up to 31 standard analog slaves, each with up to four channels, or up to 62 A/B analog slaves, each with up to two channels).



Operating conditions

- The CM 1243-2 communication module exchanges data with the S7-1200 CPU with a cycle time of 10 ms.
- The AS-i cycle time depends on the AS-i bus capacity and is up to 5 ms in the case of 31 standard slaves; for more information, see Manual "AS-i Master CM 1243-2 and AS-i Data Decoupling Unit DCM 1271 for SIMATIC S7-1200", <https://support.industry.siemens.com/cs/ww/en/view/57358958>.
- For calculation of the maximum switching frequency at inputs/outputs of AS-i slaves, these cycle times and the runtime of the user program must be added up.

Selection and ordering data

Version	SD	Screw terminals 	PU (UNIT, SET, M)	PS*	PG
	d	Article No.	Price per PU		
 3RK7243-2AA30-0XB0	2	3RK7243-2AA30-0XB0	1	1 unit	42C
	CM 1243-2 communication module <ul style="list-style-type: none"> • AS-Interface masters for SIMATIC S7-1200 • Corresponds to AS-Interface Specification V3.0 • With screw terminals, removable terminals (included in the scope of supply) • Dimensions (W × H × D/mm): 30 × 100 × 75 				

Accessories

Version	SD	Screw terminals 	PU (UNIT, SET, M)	PS*	PG
	d	Article No.	Price per PU		
 3RK7271-1AA30-0AA0	2	3RK7271-1AA30-0AA0	1	1 unit	42C
	DCM 1271 data decoupling module <ul style="list-style-type: none"> • With screw terminals, removable terminals (included in the scope of supply) • Dimensions (W × H × D/mm): 30 × 100 × 75 				
	Screw terminals (replacement)				
	5	3RK1901-3MA00	1	1 unit	42C
	5	3RK1901-3MB00	1	1 unit	42C
<ul style="list-style-type: none"> • 5-pin For AS-i master CM 1243-2 and AS-i DCM 1271 data decoupling module • 3-pin For AS-i DCM 1271 data decoupling module for connecting the power supply unit 					

More information

More information

Manuals, see <https://support.industry.siemens.com/cs/ww/en/ps/15750/man>

For diagnostics during ongoing operation, diagnostics blocks with clearly arranged visualization on the SIMATIC HMI panel are available or can be downloaded free of charge via a web browser, see <https://support.industry.siemens.com/cs/ww/en/view/109479103>.

AS-Interface

Masters

Masters for SIMATIC S7

CP 343-2P / CP 343-2

Overview



CP 343-2P/CP 343-2

The CP 343-2P communications processor is the AS-Interface master for the SIMATIC S7-300 and the ET 200M distributed I/O station, with user-friendly parameterizing options.

The CP 343-2 is the basic version of the module.

The CP 343-2P/CP 343-2 has the following characteristics:

- Connection of up to 62 AS-Interface slaves
- Integrated analog value transmission
- Support of all AS-Interface master functions in accordance with the AS-Interface Specification V3.0
- Status displays of operating states and indication of the readiness for operation of connected slaves by means of LEDs in the front panel
- Fault indications (including AS-Interface voltage errors, configuration errors) by means of LEDs on the front plate.
- Compact enclosure in the design of the SIMATIC S7-300
- Suitable for AS-i Power24V (from product version 2/firmware version 3.1) and for standard AS-i with 30 V voltage
- Additionally for CP 343-2P: Supports the configuration of the AS-Interface network with STEP 7 V5.2 and higher

Design

The CP 343-2P/CP 343-2 is connected like an I/O module to the S7-300. It has:

- Two terminal connections for connecting the AS-Interface cable directly.
- LEDs in the front panel for indicating the operating state and the readiness for operation of all connected and activated slaves
- Pushbuttons for switching over the master operating state and for adopting the existing ACTUAL configuration of the AS-i slave as the TARGET configuration

Function

The CP 343-2P/CP 343-2 supports all specified functions of the AS-Interface Specification V3.0.

The CP 343-2P/CP 343-2 each occupy 16 bytes in the I/O address area of the SIMATIC S7-300. The digital I/O data of the standard slaves and A slaves is saved in this area. The digital I/O data of the B slaves and the analog I/O data can be accessed with the S7 system functions for read/write data records.

If required, master calls can be performed with the command interface, e.g. read/write parameters, read/write configuration.

For more information, see <https://support.industry.siemens.com/cs/ww/en/view/51678777>.

Notes on security

In order to protect plants, systems, machines and networks against cyber threats, it is necessary to implement – and continuously maintain – a holistic, state-of-the-art industrial security concept. Siemens products and solutions represent only one component of such a concept.

For more information about the subject of Industrial Security, see www.siemens.com/industrialsecurity.

Configuration

All connected AS-Interface slaves are configured at the press of a button. No further configuration of the CP is required.

Additionally for CP 343-2P

The CP 343-2P also supports configuring of the AS-Interface network with STEP 7 V5.2 and higher. Specifying the AS-i configuration in HW-Config facilitates the setting of slave parameters and documentation of the plant. Uploading the ACTUAL configuration of an already configured AS-Interface network is also supported. The saved configuration cannot be overwritten at the press of a button and is therefore tamper-proof.

Benefits

- Shorter start-up times through simple configuration at the press of a button
- Design of flexible machine-related structures using the ET 200M distributed I/O system
- Provides diagnostics of the AS-Interface network
- Well suited also for complex applications thanks to connection options for 62 slaves and integral analog value processing
- Reduction of standstill and servicing times in the event of a fault thanks to the LED indicators:
 - Status of the AS-Interface network
 - Slaves connected and their readiness for operation
 - Monitoring of the AS-Interface voltage
- Lower costs for stock keeping and spare parts inventory because the CP can be used for the SIMATIC S7-300 and also for the ET 200M
- Additionally for CP 343-2P: Improved plant documentation and support for service assignments thanks to a description of the AS-Interface configuration in the STEP 7 project
- No need for the AS-i power supply unit with AS-i Power24V: The AS-Interface cable is supplied through an existing 24 V DC PELV power supply unit. An S22.5 AS-i data decoupling module (e.g. 3RK 1901-1DE12-1AA0) is required for decoupling, see [page 2/85](#).
- Operation with IP20 AS-Interface power supply (see [page 2/79](#)) also possible without restrictions

Application



The CP 343-2P/CP 343-2 is the AS-Interface master connection for the SIMATIC S7-300 and the ET 200M.

Through connection to AS-Interface it is possible to access max. 248 DI/248 DQ per CP, using 62 A/B slaves with 4 DI/4 DQ each.

With the integrated analog value processing, it is easy to transmit analog signals (per CP up to 62 A/B analog slaves with a maximum of 2 channels each or up to 31 standard analog slaves with a maximum of 4 channels each).

The CP 343-2P is the further development of the CP 343-2 and contains its entire functionality. An existing STEP 7 user program for a CP 343-2 can thus be used without restrictions with a CP 343-2P. It is only in STEP 7 HW-Config that the two modules are configured differently, with the CP 343-2P offering additional options. This is why the CP 343-2P is recommended.

Selection and ordering data

Version	SD	Article No.	Price per PU	PU (UNIT, SET, M)	PS*	PG
	d					
		CP 343-2P communications processors				
		<ul style="list-style-type: none"> For connection of SIMATIC S7-300 and ET 200M to AS-Interface Configuration of the AS-i network using the SET key or STEP 7 (V5.2 and higher) Without front connector Corresponds to AS-Interface Specification V3.0 Dimensions (W x H x D/mm): 40 x 125 x 120 				
6GK7343-2AH11-0XA0		▶ 6GK7343-2AH11-0XA0		1	1 unit	42C
		CP 343-2 communications processors				
		<ul style="list-style-type: none"> Basic version for connection of SIMATIC S7-300 and ET 200M to AS-Interface Configuration of the AS-i network using the SET key Without front connector Corresponds to AS-Interface Specification V3.0 Dimensions (W x H x D/mm): 40 x 125 x 120 				
6GK7343-2AH01-0XA0		▶ 6GK7343-2AH01-0XA0		1	1 unit	42C

Accessories

Version	SD	Article No.	Price per PU	PU (UNIT, SET, M)	PS*	PG
	d					
		Front connector, 20-pole				
		<ul style="list-style-type: none"> With screw terminals 		1	1 unit	230
		<ul style="list-style-type: none"> With spring-type terminals 		1	1 unit	230

More information

More information	
<p>For manuals, see https://support.industry.siemens.com/cs/ww/en/ps/15754/man</p>	<p>For diagnostics during ongoing operation, diagnostics blocks with clearly arranged visualization on the SIMATIC HMI panel are available or can be downloaded free of charge via a web browser, see https://support.industry.siemens.com/cs/ww/en/view/61892138.</p> <p>AS-i block library for SIMATIC PCS 7 for easy connection of AS-Interface to PCS 7, see from page 14/23 onwards.</p>

AS-Interface

Masters

Masters for SIMATIC ET 200

CM AS-i Master ST for SIMATIC ET 200SP

Overview

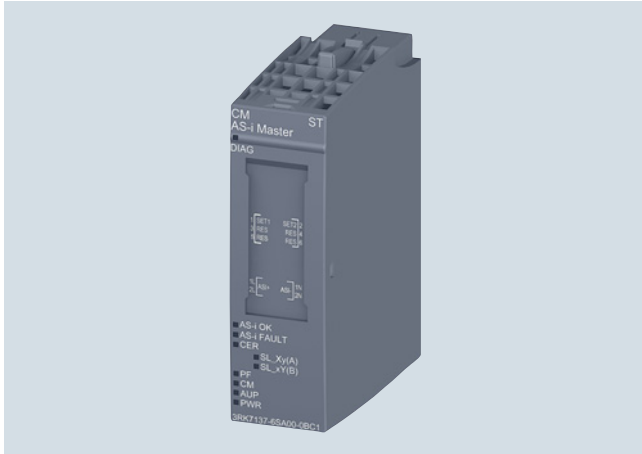

CM AS-i Master ST for SIMATIC ET 200SP

The CM AS-i Master ST communication module is designed for use in the SIMATIC ET 200SP distributed I/O system and has the following features:

- Connection of up to 62 AS-Interface slaves
- Supports all AS-Interface master functions according to the AS-Interface Specification V3.0
- User-friendly configuration with graphic display of the AS-i line in TIA Portal V12 or higher, or via GSD in other systems
- Supply via AS-Interface cable
- Suitable for AS-i Power24V and for AS-Interface with 30 V voltage
- Integrated ground-fault monitoring for the AS-Interface cable
- Through connection to AS-Interface, the number of digital inputs and outputs available for the control system is greatly increased (max. 496 DI/496 DQ on the AS-Interface per CM AS-i Master ST).
- Integrated analog value processing

ET 200SP distributed I/O system

The SIMATIC ET 200SP is a scalable and highly flexible distributed I/O system for connecting the process signals to a central control system via PROFIBUS or PROFINET.

Up to eight CM AS-i Master STs can be plugged into a SIMATIC ET 200SP with the IM 155-6 PN standard interface module.

For more information, see "SIMATIC ET 200SP Distributed I/O system", <https://support.industry.siemens.com/cs/ww/en/view/58649293>.

Design

The CM AS-i Master ST module has an ET 200SP module enclosure with a width of 20 mm. A C0 type BaseUnit (BU) is required for use in the ET 200SP.

The communication module has LED indicators for diagnostics, operation, AS-i voltage and AS-i slave status and offers informative front-side module inscription for

- Plain-text marking of the module type and function class
- 2D matrix code (Article No. and serial number)
- Circuit diagram
- Color coding of the CM module type: Light gray
- Hardware and firmware version
- Complete article number

Function

The CM AS-i Master ST communication module supports all specified functions of the AS-Interface Specification V3.0.

The input/output values of the digital AS-i slaves can be activated via the cyclic process image. The values of the analog AS-i slaves are accessible via the cyclic process image (firmware V1.1 or higher) or via data record transfer.

If required, master calls can be performed with the command interface, e.g. read/write parameters, read/write configuration.

Changeover of the operating mode, automatic application of the slave configuration and the re-addressing of a connected AS-i slave can be implemented via the control panel of the CM AS-i Master ST in STEP 7.

Expansions as from firmware version V1.1

For the implementation of modular machine concepts, the AS-i Slaves can be activated or deactivated via the PLC program (option handling). The configuration of AS-i slaves can be modified while being executed, thus enabling variable machine setups and tool changing with integrated input/output modules during ongoing operation. AS-i input/output modules can be added to the system without deactivating the controller.

An existing AS-i installation can be read into the STEP 7 hardware configuration and adapted and documented in the project. Analog values are transmitted via the cyclic process image, the length of which is adjustable and extendable up to 288 bytes (depending on the interface module (IM) used).

Diagnostic information is accessed via automatic alarm indications, via the process image or data record reading in the user program or in the STEP 7 engineering system in a graphical overview matrix. The transmission quality of the AS-i network can also be read out. To avoid configuration errors, duplicate addresses can be detected on the AS-i network.

The new functions are available with TIA Portal STEP 7 V13 SP1 or with STEP 7 V5.5 with HSP 2092 V3.0¹⁾. Configuration is possible with SIMATIC CPUs S7-300 up to S7-1500 and with a SINUMERIK 840D sl or other controller.

In the network view, the AS-i slaves' online diagnostics status can be displayed directly on the slaves (for S7-1500 CPUs with firmware version V2.0 or higher, with TIA Portal STEP 7 V14 or higher).

Notes on security

In order to protect plants, systems, machines and networks against cyber threats, it is necessary to implement – and continuously maintain – a holistic, state-of-the-art industrial security concept. Siemens products and solutions represent only one component of such a concept.

For more information about the subject of Industrial Security, see www.siemens.com/industrialsecurity.

¹⁾ For HSP 2092, see <https://support.industry.siemens.com/cs/ww/en/view/23183356>.

CM AS-i Master ST for SIMATIC ET 200SP

Configuration

The following software is required for configuration of the CM AS-i Master ST module:

- STEP 7 (classic) V5.5 SP3 HF4 or higher with HSP 2092 or HSP 2092 V3.0 (for firmware V1.1) or
- STEP 7 (TIA Portal) V12 or higher or V13 SP1 or higher (for firmware V1.1) or
- the GSD file of the ET 200SP with STEP 7 or another engineering tool

STEP 7 enables user-friendly configuration and diagnostics of the AS-i master and any connected slaves.

Alternatively, you can also apply the AS-Interface ACTUAL configuration as the DESIRED configuration at the "touch of a button" via the control panel integrated in the TIA Portal or an optional expansion button. Configuration with the GSD file is possible only with the button.

The CM AS-i Master ST module occupies up to 288 input bytes and up to 288 output bytes in the I/O data of the ET 200SP station. The I/O assignment depends on the configuration in STEP 7.

Together with an ET 200SP CPU 1510SP/1512SP (firmware V1.8 or higher) or 1515SP PC, preprocessing of safe AS-i signals directly in the ET 200SP station and setting up of an independent AS-i Safety station without a higher-level CPU are possible (TIA Portal V13 SP1 Update 4 and higher).

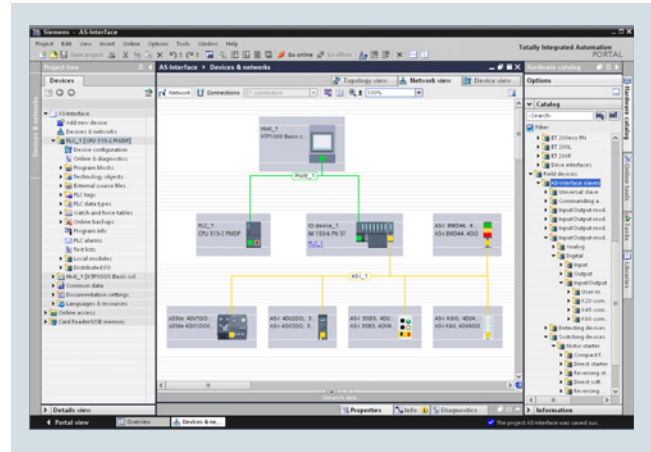

Configuration of an AS-Interface network with CM AS-i Master ST via the TIA Portal

Benefits

The CM AS-i Master ST for ET 200SP communication module enables modular, simple and high-performance expansion of AS-interface networks via engineering in the TIA Portal.

Up to eight CM AS-i Master ST units can be plugged into one ET 200SP station with IM 155-6 PN Standard. The maximum configuration depends on the interface module used.

Multiple masters as well as single masters can thus be implemented in the ET 200SP depending on the number of modules.

Together with the interface module, a scalable PROFINET/AS-i Link or PROFIBUS/AS-i Link can be assembled.

Using STEP 7, the AS-i network is consistently configured and programmed with only one configuration tool.

The PRONETA PC program (for ET 200SP with PROFINET interface module) is available for convenient input/output testing during the commissioning of an AS-i network without a CPU, see www.siemens.com/proneta.

For diagnostics during ongoing operation, diagnostics blocks with clearly arranged visualization on the SIMATIC HMI panel are available or can be downloaded free of charge via a web browser, see <https://support.industry.siemens.com/cs/ww/en/view/109479103>.

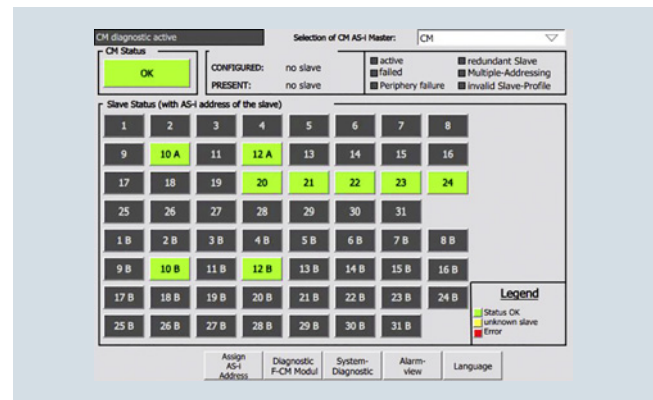

CM AS-i Master ST diagnostics block

AS-Interface

Masters

Masters for SIMATIC ET 200

CM AS-i Master ST for SIMATIC ET 200SP

Application

Configuration examples of AS-Interface networks with CM AS-i Master ST for SIMATIC ET 200SP

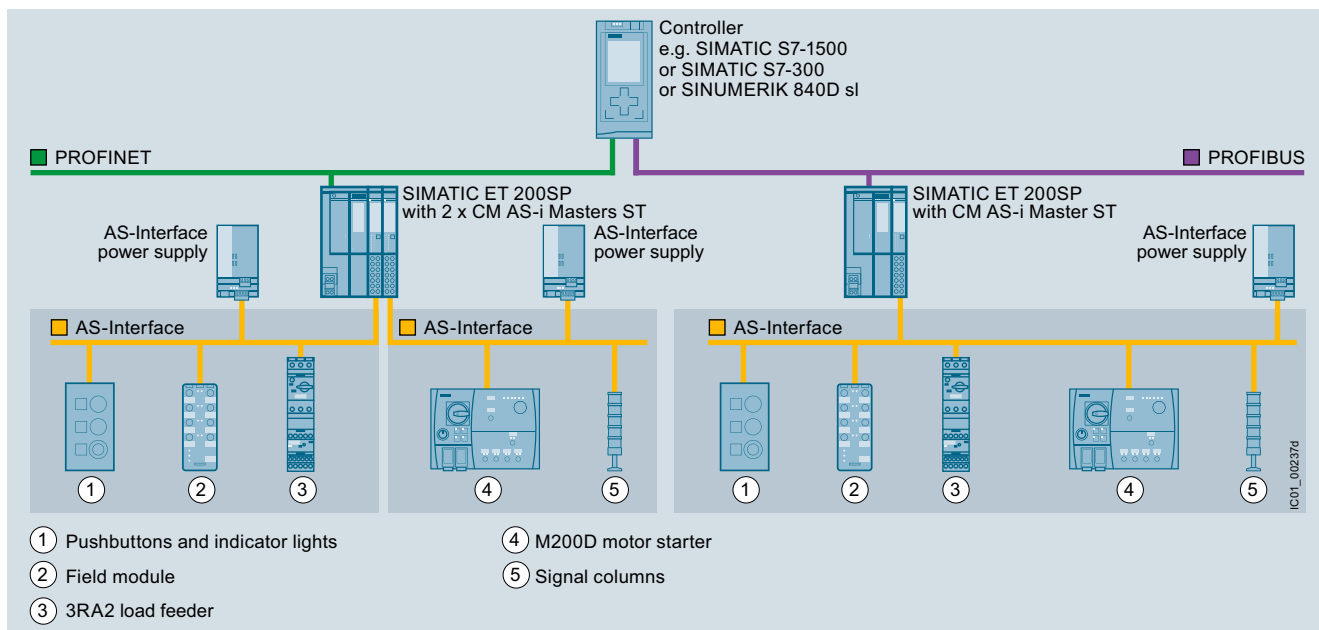

Configuration of AS-Interface networks under a SIMATIC ET 200SP

Selection and ordering data

Version	SD	Article No.	Price per PU	PU (UNIT, SET, M)	PS*	PG
	d					
 3RK7137-6SA00-0BC1	2	3RK7137-6SA00-0BC1		1	1 unit	42C
	• AS-Interface master for SIMATIC ET 200SP, can be plugged onto BaseUnit type C0 • Corresponds to AS-Interface Specification V3.0 • Dimensions (W × H × D/mm): 20 x 73 x 58					

Accessories

Version	SD	Spring-type terminals	PU (UNIT, SET, M)	PS*	PG
	d	Article No.	Price per PU		



6ES7193-6BP20-0DC0

BaseUnit BU20-P6+A2+4D	1	6ES7193-6BP20-0DC0		1	1 unit	255
<ul style="list-style-type: none"> • BaseUnit (light), BU type C0 • Suitable for the CM AS-i Master ST module • For connection of the AS-Interface cable to the CM AS-i Master ST • Start of an AS-i network, isolation of the AS-i voltage from the left-hand module 						

Version	SD	Article No.	Price per PU	PU (UNIT, SET, M)	PS*	PG
	d					



6ES7155-6AR00-0AN0

PROFINET Interface module IM 155-6 PN Basic Max. 12 I/O modules, max. 32 bytes of I/O data per station	15	6ES7155-6AR00-0AN0		1	1 unit	255
<ul style="list-style-type: none"> • Including server module and 2 x RJ45 ports (supplied without RJ45 plug) 						



6ES7155-6AA00-0BN0

PROFINET Interface module IM 155-6 PN Standard Max. 32 I/O modules, max. 256 bytes I/O data per station	15	6ES7155-6AA00-0BN0		1	1 unit	255
<ul style="list-style-type: none"> • Including server module and bus adapter 2 x RJ45 (supplied without RJ45 plug) 						
<ul style="list-style-type: none"> • Including server module (BusAdapter must be ordered separately, see below) 	15	6ES7155-6AU00-0BN0		1	1 unit	255

PROFINET Interface module IM 155-6 PN High Feature Max. 64 I/O modules, max. 1 440 bytes I/O data per station	15	6ES7155-6AU00-0CN0		1	1 unit	255
<ul style="list-style-type: none"> • Including server module (BusAdapter must be ordered separately, see below) 						

PROFIBUS interface module IM 155-6 DP High Feature Max. 32 I/O modules, max. 244 bytes I/O data per station	15	6ES7155-6BA00-0CN0		1	1 unit	255
<ul style="list-style-type: none"> • Including server module and PROFIBUS connector 						



6ES7193-6AR00-0AA0 6ES7193-6AF00-0AA0

Bus adapters for PROFINET For connection of the Ethernet cable to the PROFINET IM 155-6 PN interface module	1	6ES7193-6AR00-0AA0		1	1 unit	255
<ul style="list-style-type: none"> • Connection 2 x RJ45 (supplied without RJ45 connector) • Connection 2 x FC (FastConnect) 	15	6ES7193-6AF00-0AA0		1	1 unit	255

For more bus adapters with fiber optic cable connection, [see Catalog IK PI "Industrial Communication" or the Industry Mall.](#)

More information

More information

Manual "CM AS-i Master ST for SIMATIC ET 200SP", [see https://support.industry.siemens.com/cs/ww/en/view/71756485](https://support.industry.siemens.com/cs/ww/en/view/71756485)

Manual "SIMATIC ET 200SP BaseUnits", [see https://support.industry.siemens.com/cs/ww/en/view/59753521](https://support.industry.siemens.com/cs/ww/en/view/59753521)

Manual "SIMATIC ET 200SP Distributed I/O system", [see https://support.industry.siemens.com/cs/ww/en/view/58649293](https://support.industry.siemens.com/cs/ww/en/view/58649293)

AS-i block library for SIMATIC PCS 7 for easy connection of AS-Interface to PCS 7, [see from page 14/23 onwards](#)

Released combinations of the AS-i modules for ET 200SP, [see https://support.industry.siemens.com/cs/ww/en/view/103624653](https://support.industry.siemens.com/cs/ww/en/view/103624653)

AS-Interface

Masters

Masters for SIMATIC ET 200

F-CM AS-i Safety ST for SIMATIC ET 200SP

Overview



F-CM AS-i Safety ST for SIMATIC ET 200SP

The F-CM AS-i Safety ST fail-safe communication module supplements an AS-Interface network without additional wiring to produce a safety-related AS-i network.

Important features:

- Fail-safe communication module for the ET 200SP
 - 31 fail-safe input channels in the process image
 - 16 fail-safe output channels in the process image
 - Certified up to SIL 3 (IEC 61508/EN 62061), PL e (EN ISO 13849-1)
 - Parameterization conforms with other fail-safe I/O modules of the ET 200SP
- The communication module supports PROFIsafe in PROFINET and PROFIBUS configurations. Can be used with fail-safe SIMATIC S7-300F/S7-416F CPUs and S7-1500F CPUs and also the fail-safe versions of the ET 200SP station with ET 200SP F-CPU 1510SP F/1512SP F (firmware V1.8 or higher) or 1515SP PC F.
- For reading up to 31 fail-safe AS-i input slaves
 - Two sensor inputs/signals for each fail-safe AS-i input slave
 - Adjustable evaluation of sensor signals: 2-channel or 2 x 1-channel
 - Integrated discrepancy evaluation in the case of 2-channel signals
 - Integrated AND operation in the case of 2 x 1-channel signals
 - Input delay can be parameterized
 - Start-up test can be set
 - Sequence monitoring can be activated
- For control of up to 16 fail-safe AS-i output circuit groups
 - The output circuit groups are controlled independently of one another.
 - One output circuit group can act on one or more actuators (e.g. to switch drives simultaneously).
 - An actuator (e.g. a contactor) is interfaced via a fail-safe AS-i output module (e.g. safe SlimLine module S45F, Article No. 3RK1405-1SE15-0AA2, [see page 2/30](#)).
 - Simple fault acknowledgment via the process image
- Simple module replacement thanks to automatic importing of the safety parameters from the coding element
- Comprehensive diagnostic options
- Can be plugged onto type C1 or type C0 BaseUnits (BU)
- Informative automatic alarm indications (firmware V1.0.1 or higher)

- Supply via AS-Interface voltage
- Eight LED indicators for diagnostics, operating state, fault indication and supply voltage
- Informative front-side module inscription
 - Plain-text marking of the module type and function class
 - 2D matrix code (Article No. and serial number)
 - Circuit diagram
 - Color coding of the CM module type: Light gray
 - Hardware and firmware version
 - Complete article number
- Optional labeling accessories
 - Labeling strips
 - Reference identification label

Design

The fail-safe F-CM AS-i Safety ST module has an ET 200SP module enclosure with a width of 20 mm.

One AS-i master according to the AS-i Specification V3.0 and safe AS-i input slaves and/or safe AS-i output modules are needed for operation. The CM AS-i Master ST communication module (Article No. 3RK7137-6SA00-0BC1) is recommended as the AS-i master for the ET 200SP, [see from page 2/36 onwards](#).

Simple combination of the CM AS-i Master ST and F-CM AS-i Safety ST modules in one ET 200SP station results in a powerful, safety-oriented network transition between PROFINET (or PROFIBUS) and AS-Interface, which can be expanded further in a modular fashion.



Combination of an ET 200SP interface module, CM AS-i Master ST and F-CM AS-i Safety ST

With the digital and analog I/O modules of the ET 200SP, additional local inputs and outputs can be realized so as to ensure that the modular AS-i router complies precisely with customer requirements. Expansion variants for almost every application are possible thanks to the selection of standard and fail-safe I/O modules.

Besides the single AS-i master, double, triple or generally multiple masters can be realized with or without fail-safe functionality.

Supported BaseUnits

With the combination of the CM AS-i Master ST and F-CM AS-i Safety ST modules, the CM module is plugged onto a light type C0 BaseUnit and, immediately to the right of it, the F-CM module is plugged onto a dark type C1 BaseUnit. The AS-i cable is connected only on the light BaseUnit of the CM module.

Notes on security

In order to protect plants, systems, machines and networks against cyber threats, it is necessary to implement – and continuously maintain – a holistic, state-of-the-art industrial security concept. Siemens products and solutions represent only one component of such a concept.

For more information about the subject of Industrial Security, see www.siemens.com/industrialsecurity.

Configuration

The following software is required for configuration of the F-CM AS-i Safety ST module:

- STEP 7 (classic), V5.5 SP3 HF4 or higher with HSP 2093¹⁾ and Distributed Safety V5.4 SP5 or F-Configuration Pack SP11

or

- STEP 7 (TIA Portal) V13 and higher with HSP 0070²⁾ and Safety Advanced V13.
STEP 7 V13 SP1 is required for connection to the S7-1500F. When configuring with STEP 7 V13 SP1, the latest version of HSP 0070 V2.0 (or higher) is an essential prerequisite. STEP 7 Safety V13 SP1 Update 4 and the new version of HSP 0070 V3.0 (or higher) are needed for configuration of the F-CM AS-i Safety ST module in an ET 200SP station with ET 200SP F-CPU (firmware V1.8 or higher).

Configuration and programming are done entirely in the STEP 7 user interface. No additional configuration software is needed for commissioning.

Data management – together with all other configuration data of the SIMATIC – is realized completely in the S7 project.

The input and output channels are assigned to the process image automatically and manual linking via configuration function blocks is not necessary.

Application

Thanks to use of the fail-safe module in the ET 200SP, it is possible to fulfill the safety-related application requirements in a manner that is integrated in the overall automation solution.

The safety functions required for fail-safe operation are integrated in the modules. Communication with the fail-safe SIMATIC S7 CPUs is realized via PROFIsafe.

The safety application is programmed in the SIMATIC S7 F-CPU with Distributed Safety/Safety Advanced. The fail-safe input signals of the ASIsafe slave modules are read via the AS-i bus line and are combined with any chosen further signals in the fail-safe program.

If the F-CM AS-i Safety ST module is replaced, all necessary settings are automatically imported into the new module.

The F-CM AS-i Safety ST module occupies 16 input bytes and 8 output bytes in the I/O data of the ET 200SP station.

For diagnostics during ongoing operation, diagnostics blocks with clearly arranged visualization on the SIMATIC HMI panel are available or can be downloaded free of charge via a web browser, see <https://support.industry.siemens.com/cs/ww/en/view/109479103>.

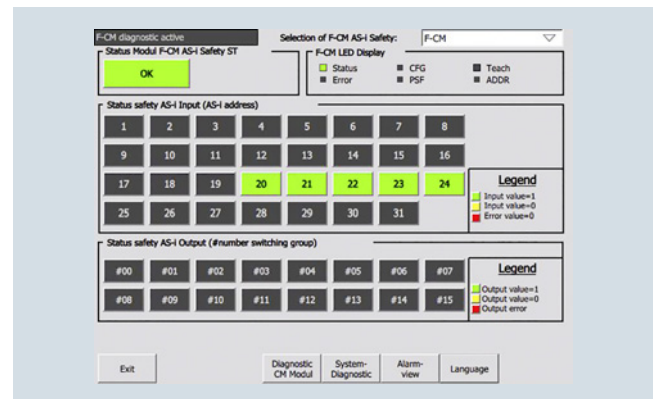

Diagnostics block for F-CM AS-i Safety ST

- ¹⁾ For HSP 2093, see <https://support.industry.siemens.com/cs/ww/en/view/23183356>.
- ²⁾ HSP 0070, see <https://support.industry.siemens.com/cs/ww/en/view/72341852>.

The fail-safe output signals can be output via safe SIMATIC output modules or also directly via AS-i – with the help of safe AS-i output modules, e.g. safe SlimLine S45F module, Article No. 3RK1405-1SE15-0AA2 (see page 2/30). No special functions are required for this in the program.

Operation with SINUMERIK 840D sl is possible with SINUMERIK software version V4.7 SP2 HF1 or higher.

Together with an ET 200SP station with ET 200SP F-CPU 1510SP F/1512SP F (firmware V1.8 and higher) or 1515SP PC F, pre-processing of safe AS-i signals directly in the ET 200SP station is possible, as well as the configuration of an autonomous AS-i Safety station without a higher-level CPU.

Selection and ordering data

Version	SD	Article No.	Price per PU	PU (UNIT, SET, M)	PS*	PG
	d					
	2	3RK7136-6SC00-0BC1		1	1 unit	42C
F-CM AS-i Safety ST communication module <ul style="list-style-type: none"> Fail-safe module for SIMATIC ET 200SP, can be plugged onto BaseUnit type C1 (alternatively type C0) Operation requires an AS-i master, e.g. CM AS-i Master ST (see page 2/38) Can be used up to SIL 3 (IEC 62061/IEC 61508), PL e (EN ISO 13849-1) Coding element type H (included in scope of supply) Dimensions (W × H × D/mm): 20 × 73 × 58 						

3RK7136-6SC00-0BC1

Accessories

Version	SD	Spring-type terminals	PU (UNIT, SET, M)	PS*	PG
	d				
	1	6ES7193-6BP20-0BC1	1	1 unit	255
BaseUnit BU20-P6+A2+4B <ul style="list-style-type: none"> BaseUnit (dark), BU type C1 Suitable for the F-CM AS-i Safety ST fail-safe communication module Continuation of an AS-i network, connection with the AS-i voltage of the left-hand module 					
	1	6ES7193-6EH00-1AA0	1	5 units	256
Coding element type H (spare part) <ul style="list-style-type: none"> For the ET 200SP modules F-CM AS-i Safety ST and CM 4xIO-Link Packing unit 5 items 					

6ES7193-6BP20-0BC1

More accessories, see page 2/39.

More information

More information

Manual "F-CM AS-i Safety ST Module for SIMATIC ET 200SP", see <https://support.industry.siemens.com/cs/ww/en/view/90265988>

Manual "SIMATIC ET 200SP BaseUnits", see <https://support.industry.siemens.com/cs/ww/en/view/59753521>

Manual "SIMATIC ET 200SP Distributed I/O system", see <https://support.industry.siemens.com/cs/ww/en/view/58649293>

Released combinations of the AS-i modules for ET 200SP, see <https://support.industry.siemens.com/cs/ww/en/view/103624653>

AS-Interface Routers

DP/AS-i Link Advanced

Overview



DP/AS-i Link Advanced

PN	DP-M	DP-S	AS-i M		
		●	●		

The DP/AS-i LINK Advanced is a compact router between PROFIBUS (DP slave) and AS-Interface, with the following features:

- Single and double AS-Interface master (according to AS-Interface Specification V3.0) for connection of 62 AS-Interface slaves or 124 AS-Interface slaves (with a double master)
- Integrated analog value transmission
- Integrated ground-fault monitoring for the AS-Interface cable
- User-friendly local diagnostics and startup by means of a full graphic display and control keys or through a web interface with a standard browser on the PC screen
- Vertical integration (standard web interface) through Industrial Ethernet
- Supply voltage from the AS-Interface shaped cable or alternatively with 24 V DC (optional)
- Suitable for AS-i Power24V (from product version 4/firmware version 2.2) and for standard AS-i with 30 V voltage
- Module exchange without entering the connection parameters (e.g. PROFIBUS address) using C-PLUG (optional)

Design

- Compact plastic enclosure in degree of protection IP20 for standard rail mounting
- COMBICON plug-in screw terminals
- Compact design:
 - Pixel graphics display in the front panel for detailed display of the operating state and readiness for operation of all connected AS-Interface slaves
 - 6 pushbuttons for starting up and testing the AS-Interface line directly on the DP/AS-i LINK Advanced
 - LED indication of the operating state of PROFIBUS DP and AS-Interface
 - Integrated Ethernet port (RJ45 socket) for user-friendly start-up, diagnostics and testing of DP/AS-i LINK Advanced through a web interface using a standard browser
- Small mounting depth thanks to recessed plug mounting
- Operation without fans and batteries

Functionality

Communications

The DP/AS-i LINK Advanced enables a PROFIBUS DP master to cyclically access the I/O data of all the slaves of a lower-level AS-Interface segment.

The DP/AS-i LINK Advanced occupies the following address space:

- As a single master: 32 bytes of input data and 32 bytes of output data in which the I/O data of the connected AS-Interface slaves (standard and A/B slaves) of an AS-i line is stored.
- As double master, double the number of bytes
- Optional additional I/O bytes for data from analog slaves

The size of the input/output image can be compressed so that only the actually required I/O address area is occupied in the system of the DP master. The integrated evaluation of analog signals is just as easy as access to digital values because the analog process data also lie directly in the I/O address area of the CPU.

PROFIBUS DP-V1 Masters also provide the option of triggering AS-Interface master calls over the acyclic PROFIBUS services (e.g. write parameters, amend addresses, read diagnostic values). Using an operating display in AS-i Link it is possible to fully commission the lower-level AS-Interface line even without a CPU.

DP/AS-i LINK Advanced is equipped with an additional Ethernet port, which enables use of the integrated web server. The web server can be called up with any standard web browser (e.g. Internet Explorer) without additional software. It allows all diagnostics information to be shown on the PC and the bus configuration and, if applicable, any adjustments, to be displayed. Firmware updates are also possible using this port.

The optional C-PLUG supports module exchange without entering the connection parameters (PROFIBUS address etc.), keeping downtimes to a minimum in the event of a fault.

Diagnostics

The following diagnostics is possible using LEDs, the display and control keys, web interface or STEP 7:

- Operating state of the DP/AS-i LINK Advanced
- Status of the link as a PROFIBUS DP slave
- Diagnostics of the AS-Interface network
- Message frame statistics
- Standard diagnostics pages in the web interface for fast diagnostics access through Ethernet using a standard browser
- For the use of the web interfaces no network settings are necessary on the PC (Zeroconf procedure)
- The reporting of diagnostic events is optionally possible via email or SNMP Trap. The integrated diagnostic buffer saves the events including time stamp.

Notes on security

In order to protect plants, systems, machines and networks against cyber threats, it is necessary to implement – and continuously maintain – a holistic, state-of-the-art industrial security concept. Siemens products and solutions represent only one component of such a concept.

For more information about the subject of Industrial Security, see www.siemens.com/industrialsecurity.

Configuration

The DP/AS-i LINK Advanced can be configured as follows:

- With STEP 7 (classic) V5.4 or higher, or STEP 7 (TIA Portal) V12 or higher: In the case of STEP 7 configuration, the AS-Interface configuration can be uploaded in STEP 7. Furthermore, AS-Interface slaves can also be conveniently configured in HW-Config (slave selection dialog)
- By adopting the ACTUAL configuration of the AS-Interface on the display
- Alternatively DP/AS-i Link Advanced can be integrated into the engineering tool using the PROFIBUS GSD file (e.g. STEP 7 versions earlier than V5.4 or engineering tools from third-party suppliers)

Benefits

- Short start-up times through simple configuration at the press of a button and testing of the AS-Interface line using the display or web interface
- Reduction of standstill and servicing times in the event of a slave failure thanks to user-friendly diagnostics using the display or web interface and through simple module exchange with the help of the C-PLUG exchange medium
- Reduced amount of engineering work thanks to user-friendly configuration of Siemens slaves using the slave catalog in HW-Config (STEP 7)
- Costs saved by the double AS-Interface master when large volumes of project data are involved
- No need for an AS-i power supply with AS-i Power24V: The AS-Interface cable is fed through an existing 24 V DC PELV power supply unit. For decoupling, an AS-i data decoupling module is required; see [page 2/85](#)
- Standard mode with AS-Interface power supply (see [page 2/79](#)) possible without restrictions, whereby no further operational voltage is required
- For diagnostics during ongoing operation, diagnostics blocks with clearly arranged visualization on the SIMATIC HMI panel are available or can be downloaded free of charge via a web browser; see <https://support.industry.siemens.com/cs/ww/en/view/61892138>

AS-Interface Routers

DP/AS-i Link Advanced

Application

The DP/AS-i LINK Advanced is a PROFIBUS DP-V1 slave (according to IEC 61158/IEC 61784) and an AS-Interface master (based on AS-Interface Specification V3.0 according to IEC 62026-2). It enables transparent data access to AS-Interface from PROFIBUS DP.

Exchanging data with the PROFIBUS DP master

PROFIBUS DP masters (DP-V0) can exchange I/O data cyclically with the AS-Interface. DP masters with acyclic services (DP-V1) are additionally able to initiate AS-Interface master calls (e.g. reading/writing the AS-i configuration during normal operation). As such, the DP/AS-i LINK Advanced is particularly well-suited for a distributed construction and for connection of a lower-level AS-Interface network.

Single master

For applications with typical volumes of project data, it is sufficient to use the DP/AS-i LINK Advanced in its version as an AS-Interface single master. The single master can operate up to 248 DI/248 DQ, using 62 A/B slaves with 4 DI/4 DQ each.

Double master

The AS-Interface double master version of DP/AS-i LINK Advanced is suitable for applications with large volumes of data. In this case, twice the volume of project data can be used on two AS-Interface lines running independently of each other. The double master can operate up to 496 DI/496 DQ, using two AS-i networks each with 62 A/B slaves with 4 DI/4 DQ each.

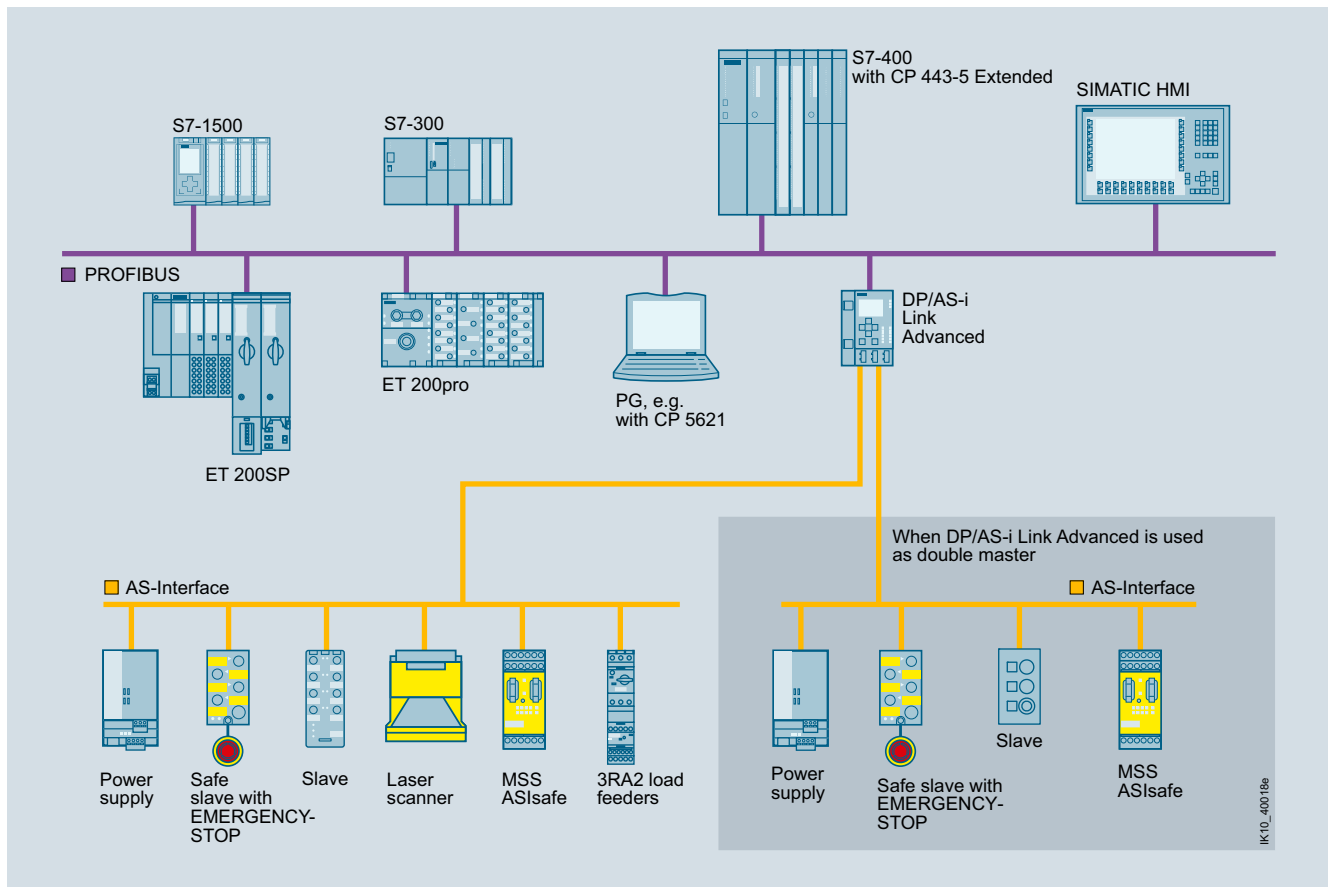

Integration of AS-Interface on PROFIBUS through DP/AS-i LINK Advanced as single/double master

Selection and ordering data

Version	SD	Article No.	Price per PU	PU (UNIT, SET, M)	PS*	PG
	d					

DP/AS-i Link Advanced



DP/AS-i Link Advanced

Router between PROFIBUS DP and AS-Interface; degree of protection IP20; including COMBICON plug-in screw terminals for connection of an AS-Interface cable (two AS-Interface cables for double masters) and the optional 24 V supply; corresponds to AS-Interface specification V3.0; dimensions (W x H x D/mm): 90 x 132 x 88.5

- Single master with display
- Double master with display

COMBICON connection



▶	6GK1415-2BA10	1	1 unit	42C
▶	6GK1415-2BA20	1	1 unit	42C

Accessories

Version	SD	Article No.	Price per PU	PU (UNIT, SET, M)	PS*	PG
	d					

C-PLUG

Exchange medium for the simple exchange of devices in the event of a fault; for accommodating configuration and application data; can be used in SIMATIC NET products with a C-PLUG slot

PROFIBUS FastConnect standard cable GP
FastConnect standard type with special design for fast installation, 2-core, shielded

PROFIBUS FastConnect RS 485 bus connector with diagonal cable outlet (35°)

With insulation displacement connection, the max. transmission rate is 12 Mbit/s, activatable terminating resistor is integrated

- Without PG connection socket
- With PG connection socket

PROFIBUS FastConnect stripping tool

Preset stripping tool for speedy stripping of PROFIBUS FastConnect bus cables

IE FC RJ45 Plug 90

RJ45 plug-in connector for Industrial Ethernet, with robust metal enclosure and integrated insulation displacement contacts for connection of Industrial Ethernet FC installation cables; with 90° cable feeder

- 1 pack = 1 unit
- 1 pack = 10 units
- 1 pack = 50 units

1		6GK1900-0AB00		1	1 unit	5N3
1		6XV1830-0EH10		1	1 M	5K1
1		6ES7972-0BA61-0XA0		1	1 unit	250
1		6ES7972-0BB61-0XA0		1	1 unit	250
1		6GK1905-6AA00		1	1 unit	5K2
1		6GK1901-1BB20-2AA0		1	1 unit	5K1
1		6GK1901-1BB20-2AB0		1	10 units	5K1
1		6GK1901-1BB20-2AE0		1	50 units	5K1

More information

More information

AS-i block library for SIMATIC PCS 7 for easy connection of AS-Interface to PCS 7, see from page 14/23 onwards

Manuals, see <https://support.industry.siemens.com/cs/ww/en/ps/24507/man>

AS-Interface Routers

DP/AS-Interface Link 20E

Overview



DP/AS-Interface Link 20E manual

PN	DP-M	DP-S	AS-i M		
		●	●		

DP/AS-Interface Link 20E connects PROFIBUS DP to AS-Interface and has the following features:

- PROFIBUS DP slave and AS-Interface master
- Up to 62 AS-Interface slaves, each with four digital inputs and four digital outputs as well as analog slaves can be connected
- Integrated analog value transmission
- Supports all AS-Interface master functions according to the AS-Interface Specification V3.0
- Supply from AS-Interface cable; hence no additional power supply required
- Suitable for AS-i Power24V (from product version 2/firmware version 3.1) and for standard AS-i with 30 V voltage
- Supports uploading of the AS-Interface configuration in STEP 7 V5.2 and higher

Design

- Compact plastic enclosure in degree of protection IP20 for standard rail mounting
- LEDs in the front panel for indicating the operating state and functional readiness of all connected slaves
- Setting of PROFIBUS DP address is possible by pressing a button
- LED indication of the PROFIBUS DP slave address, PROFIBUS DP bus faults and diagnostics
- Two pushbuttons for switching over the operating state and for adopting the existing ACTUAL configuration as the TARGET configuration

Functionality

Communications

The DP/AS-Interface Link 20E enables a DP master to access all the slaves of an AS-Interface network.

The DP/AS-Interface Link 20E occupies a standard 32 bytes of input data and 32 bytes of output data in which the digital I/O data of the connected AS-Interface slaves (standard and A/B slaves) of an AS-i line is stored.

The size of the input/output image can be compressed so that only the actually required I/O address area is occupied in the system of the PROFIBUS DP master.

The analog I/O data can be accessed with the S7 system functions for read/write data records.

Configuration

The DP/AS-Interface Link 20E is configured as follows:

- With STEP 7 (classic) V5.1 SP2 or higher or STEP 7 (TIA Portal) V12 or higher:
In the case of STEP 7 configuration, the AS-Interface configuration can be uploaded in STEP 7 V5.2 or higher. Furthermore, AS-Interface slaves from Siemens can also be conveniently configured in HW Config (slave selection dialog).
- By adopting the ACTUAL configuration of the AS-Interface by using the SET pushbutton on the front panel.
- Alternatively, DP/AS-Interface Link 20E can be integrated by means of the PROFIBUS GSD file in the engineering tool (e.g. for STEP 7 V5.1 and lower or for non-Siemens engineering tools).

Benefits

- Reduction of installation costs because the power is supplied entirely via the AS-Interface cable, which means that no additional power supply is required
- Short startup times thanks to easy configuration at the touch of a button
- The LED indicators help reduce downtime and service times if a slave fails
- Quick and easy commissioning by reading the AS-Interface configuration
- For diagnostics during ongoing operation, diagnostics blocks with clearly arranged visualization on the SIMATIC HMI panel are available or can be downloaded free of charge via a web browser, [see https://support.industry.siemens.com/cs/ww/en/view/61892138](https://support.industry.siemens.com/cs/ww/en/view/61892138).

Application

The DP/AS-Interface Link 20E is a PROFIBUS DP slave (according to IEC 61158/IEC 61784) and an AS-Interface master (according to IEC 62026-2). It enables the AS-Interface to be operated on PROFIBUS DP.

Up to 248 DI/248 DQ can be operated via the DP/AS-Interface Link 20E using 62 A/B slaves with 4 DI/4 DQ each.

PROFIBUS DP masters (DP-V0) can exchange digital I/O data cyclically with the AS-Interface.

PROFIBUS DP masters with acyclic services (DP-V1) are additionally able to exchange analog I/O data and initiate AS-Interface master calls (e.g. reading/writing the AS-i configuration during normal operation).

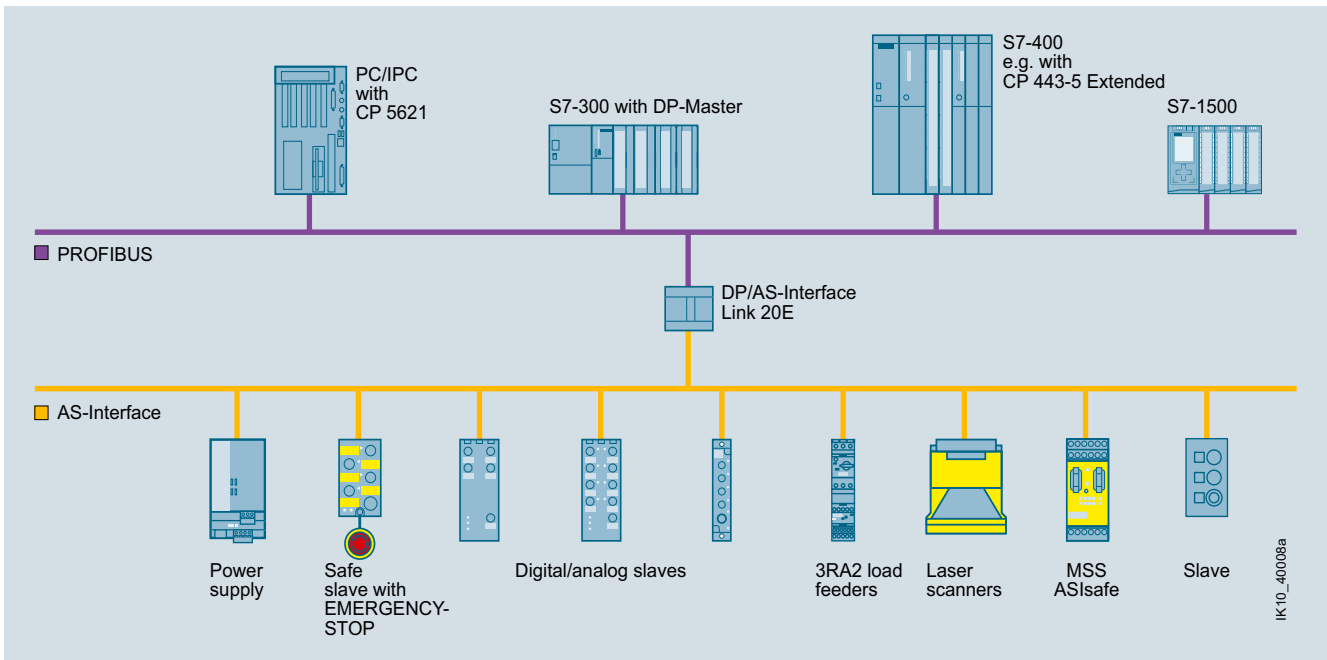

Transition from PROFIBUS DP to AS-Interface using DP/AS-Interface Link 20E

Selection and ordering data

Version	SD	Article No.	Price per PU	PU (UNIT, SET, M)	PS*	PG
	d					

DP/AS-Interface Link 20E



6GK1415-2AA10

Router between PROFIBUS DP and AS-Interface in degree of protection IP20; including screw terminals for connection of the AS-Interface cable; corresponds to AS-Interface Specification V3.0; dimensions (W x H x D/mm): 90 x 80 x 60 (dimensions without fixing lugs)

Screw terminals						
6GK1415-2AA10				1	1 unit	42C

AS-Interface Routers

DP/AS-Interface Link 20E

Accessories

Version	SD	Article No.	Price per PU	PU (UNIT, SET, M)	PS*	PG
	d					
PROFIBUS FC Standard Cable GP FastConnect standard type with special design for fast installation, 2-core, shielded	1	6XV1830-0EH10		1	1 M	5K1
PROFIBUS FastConnect bus connectors With insulation displacement connection, max. transmission rate 12 Mbit/s, activatable terminating resistor integrated						
• RS 485 bus connector with 90° cable feeder						
- Without PG connection socket	1	6ES7972-0BA52-0XA0		1	1 unit	250
- With PG connection socket	1	6ES7972-0BB52-0XA0		1	1 unit	250
• RS 485 bus connector with diagonal cable outlet (35°)						
- Without PG connection socket	1	6ES7972-0BA61-0XA0		1	1 unit	250
- With PG connection socket	1	6ES7972-0BB61-0XA0		1	1 unit	250
PROFIBUS FastConnect Stripping Tool Preset stripping tool for speedy stripping of PROFIBUS FastConnect bus cables	1	6GK1905-6AA00		1	1 unit	5K2

More information

More information

Manual "DP/AS-Interface Link 20E", see
<https://support.industry.siemens.com/cs/ww/en/view/5281638>

Overview



IE/AS-i Link PN IO
Single master (picture on left) and double master (picture on right)

PN	DP-M	DP-S	AS-i M		
●			●		

The IE/AS-i Link PN IO is a compact router between PROFINET and AS-Interface, with the following features:

- Single and double AS-Interface master (according to AS-Interface Specification V3.0) for connection of 62 or 124 AS-Interface slaves (with a double master)
- Integrated analog value transmission
- Integrated ground-fault monitoring for the AS-Interface cable
- User-friendly local diagnostics and startup by means of a full graphic display and control keys or through a web interface with a standard browser on the PC screen
- Vertical integration (standard web interface) through Industrial Ethernet
- Supply via AS-Interface cable or with 24 V DC
- Suitable for AS-i Power24V and for AS-Interface with 30 V voltage
- Module exchange without entering the connection parameters (IP address etc.) using C-PLUG (optional)
- Costs saved by the double AS-Interface master when large volumes of project data are involved

Note:

As an alternative to the IE/AS-i Link PN IO, a high-performance router can be set up between PROFINET and AS-Interface by combining the CM AS-i Master ST and F-CM AS-i Safety ST modules in an ET 200SP station (for safety-related applications), see pages 2/38 and 2/43.

Design

- Compact plastic enclosure in degree of protection IP20 for standard rail mounting
- COMBICON plug-in screw terminals
- Compact design
- Pixel graphics display in the front panel for detailed display of the operating state and readiness for operation of all connected AS-Interface slaves
- Six pushbuttons for starting up and testing the AS-Interface line directly on the IE/AS-i LINK PN IO
- LED display of the operating state of PROFINET IO and AS-Interface
- Integrated 2-port switch (RJ45 socket) for connection to Industrial Ethernet
- Small mounting depth thanks to recessed plug mounting
- Operation without fans and batteries

FunctionalityCommunications

The IE/AS-i LINK PN IO enables a PROFINET IO controller to cyclically access the I/O data of all the slaves of a lower-level AS-Interface segment. Also supported are the expanded slave types with higher I/O data volume according to AS-i Specification V3.0.

The IE/AS-i LINK PN IO occupies the following address space:

- As a single master with full expansion: 62 bytes of input data and 62 bytes of output data in which the I/O data of the connected AS-Interface slaves (standard and A/B slaves) of an AS-i line is stored.
- As double master, double the number of bytes
- Optional additional I/O bytes for data from analog slaves

The size of the input/output image can be compressed so that only the actually required I/O address area is occupied in the system of the IO controller.

The integrated evaluation of analog signals is just as easy as access to digital values because the analog process data also lie directly in the I/O address area of the CPU.

PROFINET IO controllers are additionally able to initiate AS-Interface master calls (e.g. to write parameters, change addresses, read diagnostic values) through the acyclic PROFINET services.

Using an operating display in AS-Interface Link it is possible to fully commission the lower-level AS-i line.

The IE/AS-i LINK PN IO is equipped with two Ethernet ports, which are connected by an internal switch. With the Ethernet it is possible in addition to use the integrated web server. The web server can be called up with any standard web browser (e.g. Internet Explorer) without additional software. It enables the PC to present all diagnostics information and to display the set bus configuration and parameters as well as their adaptation where applicable. Firmware updates are also possible using this port.

The optional C-PLUG supports module exchange without entering the connection parameters (e.g. IP address), keeping downtimes to a minimum in the event of a fault.

AS-Interface Routers

IE/AS-i Link PN IO

Diagnostics

The following diagnostics is possible using the display and control keys, web interface or STEP 7:

- Operating state of the IE/AS-i LINK PN IO
- State of the link as a PROFINET IO device
- Diagnostics of the AS-Interface network
- Message frame statistics
- Standard diagnostics pages in the web interface for fast diagnostics access through Ethernet using a standard browser
- Reporting of diagnostic events is optionally possible via e-mail or SNMP trap. The integrated diagnostic buffer saves the events including time stamp

Notes on security

In order to protect plants, systems, machines and networks against cyber threats, it is necessary to implement – and continuously maintain – a holistic, state-of-the-art industrial security concept. Siemens products and solutions represent only one component of such a concept.

For more information about the subject of Industrial Security, see www.siemens.com/industrialsecurity.

Configuration

The IE/AS-i LINK PN IO is configured as follows:

- With STEP 7 (classic) V5.4 or higher: When configuring in STEP 7, the AS-Interface configuration can be uploaded in STEP 7 V5.4 SP2 and higher. Furthermore, AS-Interface slaves from Siemens can also be conveniently configured in HW Config (slave selection dialog).
- Alternatively, IE/AS-i LINK PN IO can be integrated by means of the PROFINET GSD file in the engineering tool (e.g. for TIA Portal, for STEP 7 versions V5.4 SP2 and lower, or for non-Siemens engineering tools).

Please observe the configuration notes in the TIA Portal, see <https://support.industry.siemens.com/cs/ww/en/view/109483764>.

Benefits

- Short startup times through simple configuration at the press of a button and testing of the AS-Interface line using the display or web interface
- Reduction of standstill and servicing times in the event of a slave failure thanks to user-friendly diagnostics using the display or web interface
- Costs saved by the double AS-Interface master when large volumes of project data are involved
- No need for an AS-i power supply with AS-i Power24V: The AS-Interface cable is fed through an existing 24 V DC PELV power supply unit. For decoupling, an AS-i data decoupling module is required; see [page 2/85](#)
- Standard mode with AS-Interface power supply (see [page 2/79](#)) possible without restrictions, whereby no further operational voltage is required
- For diagnostics during ongoing operation, diagnostics blocks with clearly arranged visualization on the SIMATIC HMI panel are available or can be downloaded free of charge via a web browser, see <https://support.industry.siemens.com/cs/ww/en/view/61892138>

Application

The DP/AS-i Link PN IO is a PROFINET IO device (according to IEC 61158/IEC 61784) and an AS-Interface master (based on AS-Interface Specification V3.0 according to IEC 62026-2). It enables transparent data access to AS-Interface from PROFINET.

Exchanging data with PROFINET IO controllers

PROFINET IO controllers can exchange I/O data with AS-Interface in cyclic mode and can perform AS-i master calls in addition with acyclic services (e.g. reading/writing the AS-i configuration during normal operation). The IE/AS-i LINK PN IO is therefore suitable for distributed configurations and for integrating a lower-level AS-Interface network.

Single master

The AS-i single master version of IE/AS-i LINK PN IO is suitable for applications with typical volumes of data. The single master can operate up to 248 DI/248 DO, using 62 A/B slaves with 4 DI/4 DO each.

Double master

The AS-i double master version of IE/AS-i LINK PN IO is suitable for applications with large volumes of data. In this case, twice the volume of project data can be used on two AS-i lines running independently of each other. The double master can operate up to 496 DI/496 DQ, using two AS-i networks each with 62 A/B slaves with 4 DI/4 DQ each.

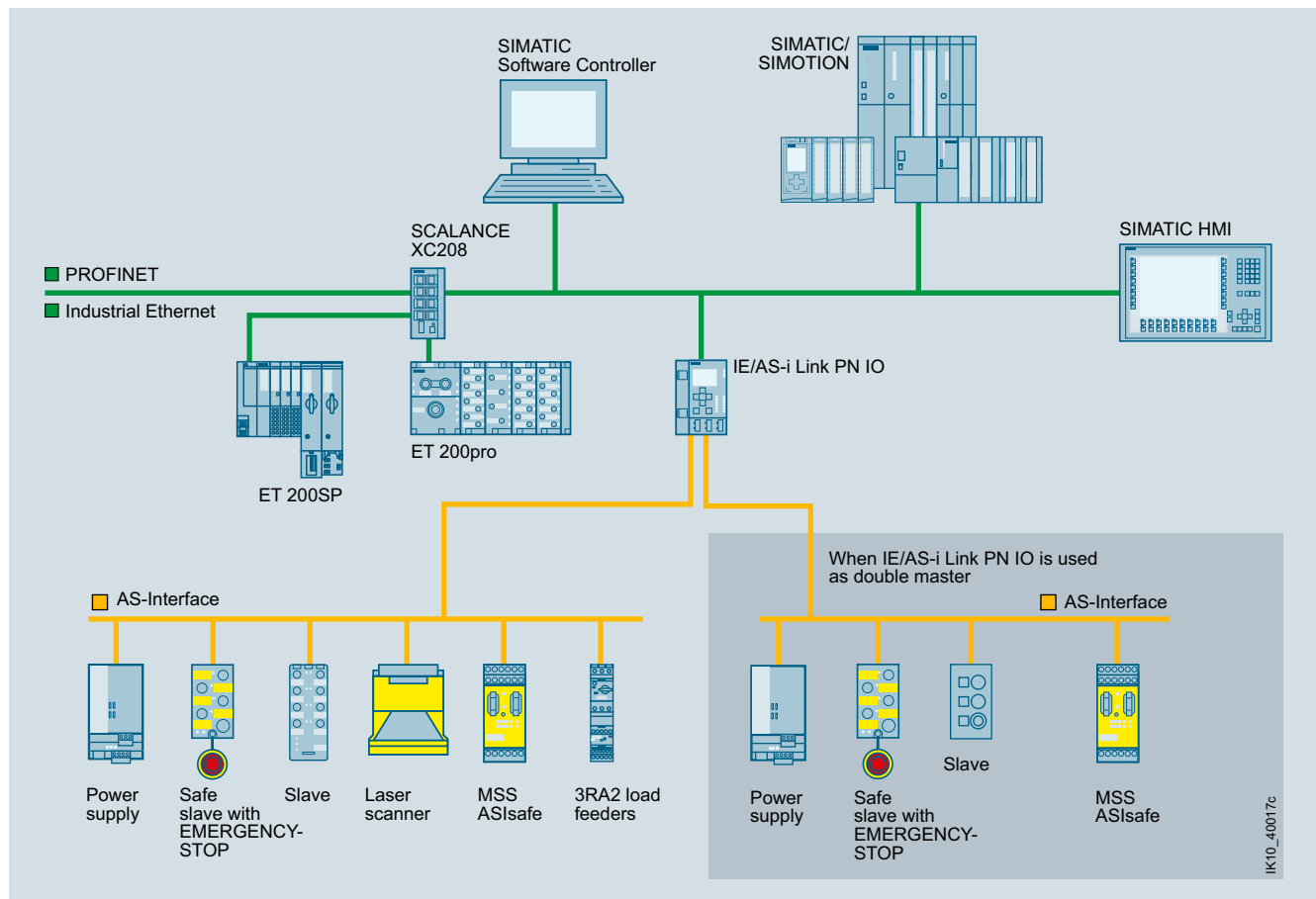

Integration of AS-Interface on PROFINET through IE/AS-i LINK PN IO as single/double master

AS-Interface Routers

IE/AS-i Link PN IO

Wireless communication

Using an upstream IWLAN client module, e.g. SCALANCE W748-1 RJ45, an AS-Interface line can be integrated in the PROFINET world by wireless means.

Sample uses are applications which up to now have been performed with fault-prone tow chain or collector wire technology. Maintenance costs are thus reduced.

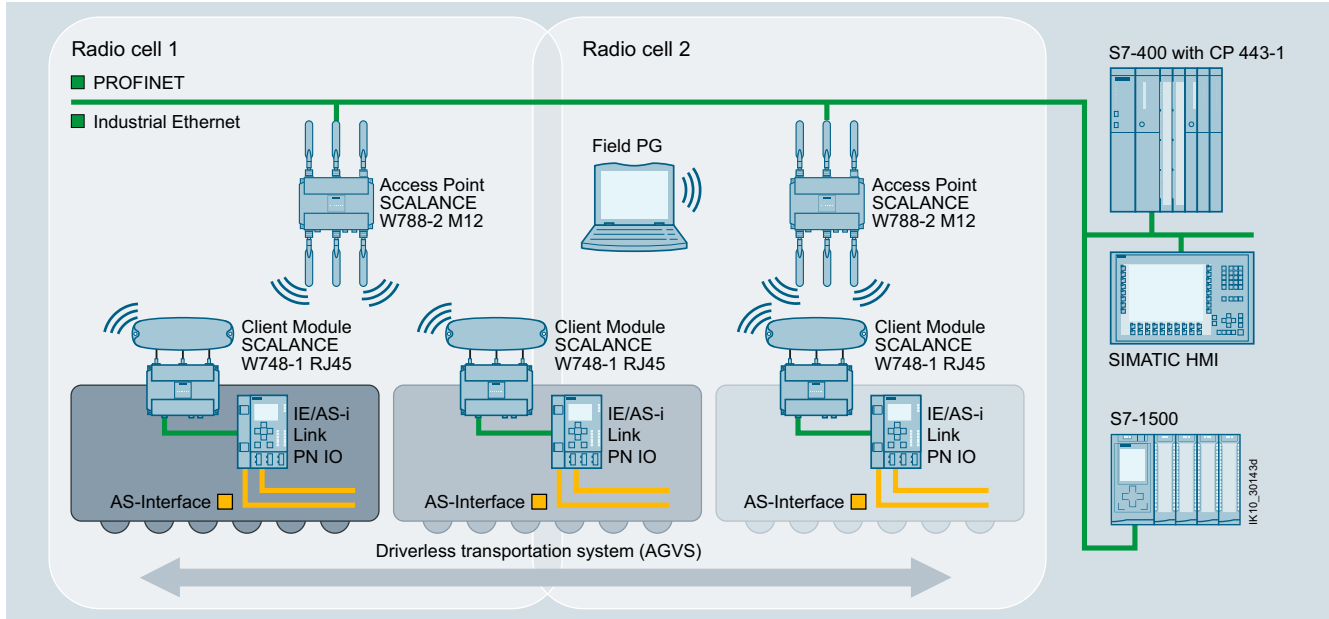

Wireless communication between Industrial Ethernet and AS-Interface components

Selection and ordering data

Version	SD	Article No.	Price per PU	PU (UNIT, SET, M)	PS*	PG
	d					
IE/AS-i Link PN IO						
 <p>Router between PROFINET and AS-Interface in degree of protection IP20; including COMBICON plug-in screw terminals for connecting an AS-Interface cable (two AS-Interface cables for a double master) and the optional 24 V supply; complies with AS-Interface Specification V3.0; dimensions (W x H x D/mm): 90 x 132 x 88.5</p> <ul style="list-style-type: none"> • Single master with display • Double master with display 		<p>COMBICON connection</p>				
		6GK1411-2AB10		1	1 unit	42C
		6GK1411-2AB20		1	1 unit	42C

Accessories

Version	SD	Article No.	Price per PU	PU (UNIT, SET, M)	PS*	PG
	d					
C-PLUG						
Exchange medium for simple exchange of devices in the event of a fault; for accommodating configuration and application data; can be used in SIMATIC NET products with a C-PLUG slot		1	6GK1900-0AB00		1	1 unit 5N3
IE FC RJ45 Plug 90						
RJ45 plug-in connector for Industrial Ethernet, with robust metal enclosure and integrated insulation displacement contacts for connection of Industrial Ethernet FC installation cables; with 90° cable feeder						
	1	6GK1901-1BB20-2AA0		1	1 unit	5K1
	1	6GK1901-1BB20-2AB0		1	10 units	5K1
	1	6GK1901-1BB20-2AE0		1	50 units	5K1

More information

More information	
Manuals, see https://support.industry.siemens.com/cs/ww/en/ps/15762/man	AS-i block library for SIMATIC PCS 7 for easy connection of AS-Interface to PCS 7, see from page 14/23 onwards

Overview

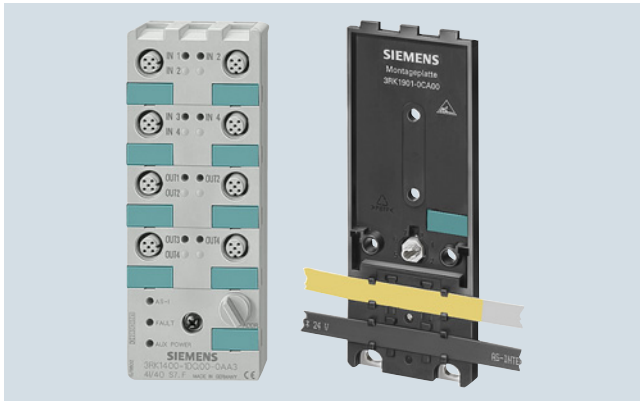

K60



K45



K20

Three coordinated series of AS-Interface compact modules with digital and analog compact modules and a high degree of protection are available for use in the field:

- Series K60 (digital and analog)
- Series K45 (digital)
- Series K20 (digital)

All compact modules are characterized by particularly simple handling. The K60 and K45 modules are mounted with a mounting plate. The mounting plate is used to mount the AS-Interface flat cables and enables mounting on a wall or standard mounting rail.

The particularly narrow K20 modules are directly mounted without a mounting plate and connected to the AS-Interface using a round cable.

Connection types

For flexible connection of different sensors and actuators, the following PIN assignments are available on the I/O modules with M12 sockets:

Standard assignment

With the standard assignment, one sensor/actuator is connected per M12 socket. In this case the signal for the outputs is acquired at PIN4 while the signal for the inputs is acquired at PIN4 and PIN2. As the result, sensors can be connected directly to PIN2 and PIN4.

Y assignment

With the Y assignment, two sensors or two actuators can be connected to one M12 socket. In this case, both PIN4 and PIN2 are provided for one sensor signal and one actuator signal on each M12 socket.

Y-II assignment

The Y-II assignment offers the following options:

- Individual connection of a sensor/actuator to one M12 socket
- Connection of two sensors/actuators to one M12 socket as follows:
 - The signal of the first sensor/actuator is connected to PIN4 of the first socket.
 - The signal of the second sensor/actuator is connected to PIN2 of the first socket and to PIN4 of the second socket. In this case, the second socket is not required and is closed with a sealing cap.

Overview of digital compact modules

The following table provides an overview of the important features of the digital compact modules.

Version	K60	K45	K20
8 inputs/2 outputs	✓	--	--
8 inputs	✓	✓	--
4 inputs/4 outputs	✓	✓	✓
4 inputs/3 outputs	✓	--	--
4 inputs/2 outputs	✓	--	--
4 inputs	✓	✓	✓
2 inputs/2 outputs	--	✓	✓
4 outputs	✓	✓	✓
3 outputs	--	✓	--
AS-Interface connection	Flat cable/ round cable	Flat cable	Round cable
I/O connection method	M12	M12/M8	M12/M8
Pin assignment	Standard/Y-II/Y	Standard/Y	Standard/Y
Degree of protection	IP65/IP67/IP68/IP69K	IP65/IP67	IP65/IP67
ATEX 3D (Zone 22)	✓	--	--
Extended address mode	✓	✓	✓

✓ Available

-- Not available

AS-Interface

Slaves

I/O Modules for Use in the Field, High Degree of Protection

Digital I/O modules, IP67 – K60

Overview



K60

The K60 digital AS-Interface compact modules are characterized by optimized handling characteristics and user-friendliness. They permit the mounting times and startup times of AS-Interface to be reduced by up to 40 %.

Mounting and connection of the AS-Interface shaped cables

Assembly of the K60 modules is performed with a mounting plate which accommodates the AS-Interface shaped cables. Two different mounting plates are offered for

- Wall mounting
- Standard rail mounting

The mounting plate and the compact module are joined together by means of a screw, with simultaneous contacting of the AS-Interface cable by the service-proven insulation piercing method.

Addressing and connection of the sensors/actuators

Addressing of the K60 modules is performed using an addressing socket integrated in the compact module. The addresses can also be assigned after installation.

K60 modules with a maximum of four digital inputs and outputs

These compact modules contain the M12 standard connections for inputs and outputs. Using M12 standard connectors, a maximum of four sensors and four actuators can be connected to the compact module.

K60 compact modules with a maximum of eight digital inputs

These modules have eight digital inputs for connection through M12 plugs.

The module requires two AS-Interface addresses for processing all eight inputs. The addressing can thus be performed through a double addressing socket integrated in the module.

K60 compact modules with four digital inputs and outputs according to AS-Interface Specification 3.0

The AS-Interface Specification V3.0 extended address mode (A/B addresses) enables connection of up to 62 slaves on one AS-Interface network. With the extended address mode, four outputs are now possible even with A/B slaves (instead of only three outputs possible up to now with Specification V2.1). Hence with full expansion of an AS-Interface network, there are now 248 inputs as well as 248 outputs available on one AS-i network.

Points to bear in mind:

- These modules can be used only with a master according to AS-i Specification V3.0.
- The cycle times for the outputs may be up to 20 ms.

K60 data couplers

An AS-Interface data coupler has been added to the K60 compact module range. Integrated in this module are two AS-i slaves which are connected to two different AS-i networks. Each of the two integrated slaves has four virtual inputs and four virtual outputs. The bidirectional data transmission of four data bits between two AS-i networks is thus possible in a simple and cost-effective manner. The data coupler needs its own address in each AS-i network.

Each AS-i network works with a different cycle time depending on the number of stations. Hence two AS-i networks are not necessarily synchronous. For this reason, the AS-i data coupler can be used to transmit only standard data and no safety data.

K60 compact modules for use in hazardous areas (ATEX)

Two versions of the K60 modules are available for operation in Zone 22 hazardous areas according to Classification II 3D (dusty atmosphere, non-conductive dust). The version with four inputs and four outputs has the designation (Ex) II 3D Ex tD A22 IP65X T75°C and the version with four inputs has the designation (Ex) II 3D Ex tD A22 IP65X T60°C.



Special conditions have to be observed for the safe operation of these devices. In particular the module must be protected by suitable measures from mechanical damage.

Selection and ordering data

Version	SD	Article No.	Price per PU	PU (UNIT, SET, M)	PS*	PG
	d					
Digital I/O modules, IP67 – K60						
<ul style="list-style-type: none"> • PNP transistor • Width 60 mm • Connection method: M12 • Modules supplied without mounting plate 						
	Type	Current carrying capacity of outputs	Slave type	Pin assignment	Sensor power supply via	
3RK1400-1DQ00-0AA3	8 inputs/ 2 outputs ¹⁾	2 A	A/B	Special	AS-i	2
	8 inputs ¹⁾	--	Standard	Y-II	AS-i	▶
			A/B	Y-II	AS-i	▶
			A/B	Y-II	U _{aux}	5
	4 inputs/ 4 outputs	2 A	Standard	Y-II	AS-i	▶
		2 A	Standard	Standard	AS-i	▶
		1 A	Standard	Y-II	AS-i	2
		1 A	Standard	Standard	AS-i	▶
		2 A	A/B (Spec. V3.0)	Y-II	AS-i	2
		2 A	A/B (Spec. V3.0)	Y-II	U _{aux}	2
	4 inputs/ 3 outputs	2 A	A/B	Y-II	AS-i	▶
	4 inputs/ 2 outputs	2 A	Standard	Y-II	AS-i	▶
	4 inputs	--	Standard	Y-II	AS-i	▶
		--	A/B	Y-II	AS-i	2
	2 x 2 inputs/ 2 x 2 outputs	1 A	Standard	Y	AS-i	15
	4 outputs	2 A	Standard	Y-II	--	▶
		2 A	A/B (Spec. V3.0)	Y-II	--	2
Digital I/O modules IP67 – K60, version ATEX (Ex) II 3D Ex tD A22 IP65X T70 °C/60 °C						
<ul style="list-style-type: none"> • PNP transistor • Width 60 mm • Current carrying capacity of the inputs: 200 mA • Connection method: M12 • Modules supplied without mounting plate 						
	Type	Current carrying capacity of outputs	Slave type	Pin assignment		
	4 inputs/ 4 outputs	2 A	Standard	Y-II	5	▶
	4 inputs	--	Standard	Y-II	10	▶
Digital I/O modules IP67 – K60 data couplers						
• Modules supplied without mounting plate						
	Type	Current carrying capacity of outputs	Slave type	Pin assignment		
	Data coupler 4 inputs/ 4 outputs (virtual)	--	Standard	--	10	▶

¹⁾ Module occupies two AS-Interface addresses

AS-Interface**Slaves****I/O Modules for Use in the Field, High Degree of Protection****Digital I/O modules, IP67 – K60****Accessories**

Version	SD	Article No.	Price per PU	PU (UNIT, SET, M)	PS*	PG
	d					
 3RK1901-0CA00		K60 mounting plates Suitable for all K60 compact modules				
		<ul style="list-style-type: none"> ▶ Wall mounting ▶ Standard rail mounting 				
		3RK1901-0CA00		1	1 unit	42C
		3RK1901-0CB01		1	1 unit	42C
 3RK1901-1KA00		AS-Interface sealing caps M12 For free M12 sockets				
		▶	3RK1901-1KA00	100	10 units	42C
 3RK1902-0AR00	2	Sealing sets <ul style="list-style-type: none"> • For K60 mounting plate and standard distributor • Cannot be used for K45 mounting plate • One set contains one straight and one shaped seal 				
		3RK1902-0AR00		100	5 units	42D

Overview

Operation in particularly harsh environments

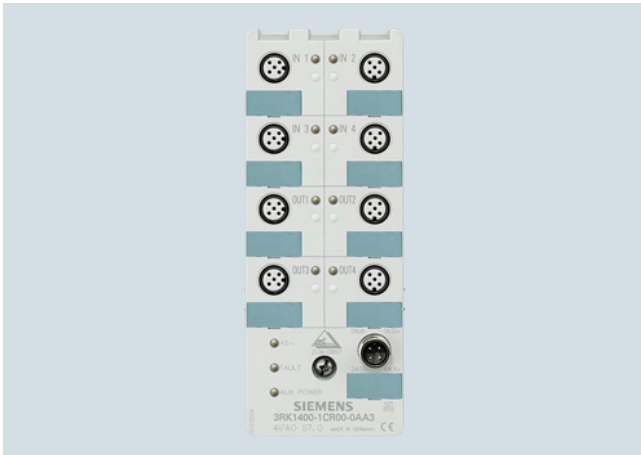

K60R module in degree of protection IP68/IP69K

Modules with degree of protection IP67 cannot be used in areas exposed to permanently high levels of humidity, in applications with drilling emulsions and cutting oils or when cleaning with high-pressure cleaners. The answer for these applications is provided by the expansion of the K60 compact modules with the K60R module with degree of protection IP68/IP69K.

The K60R modules are connected instead of the AS-Interface flat cable using a round cable with M12 cable box. The AS-Interface bus cable and the 24 V DC auxiliary power supply are routed in this case in a shared round cable.

Degree of protection IP68 permits many new applications that were impossible with the former field modules with degree of protection IP67. In applications such as filling plants or machine tools, the K60R with degree of protection IP68 enables the module to be used directly in zones exposed to permanent loading by humidity. It is thus possible to make even more rigorous savings in wiring with AS-Interface. For more information on IP68 test conditions, see "IP68/IP69K tests" on page 2/60.

Cleaning with high-pressure cleaners, such as is regularly performed in the food and drinks industry for instance, is possible without difficulty (IP69K).

In applications with tow chains, many users rely on placing the AS-Interface bus cable in a round cable. With the K60R module, a round cable connection is possible for direct connection to a round cable. No adapter is required.

Mounting

The same mounting plates are used as for the K60 modules. Instead of using flat cables, the K60R is connected using a 4-pole round cable with an M12 connection. With the K60R the mounting plate thus serves only as a fixture and ground terminal.

Addressing

Addressing is performed using the same socket as for the bus connection. Connecting the module to the addressing unit takes place over a 3-pole standard M12 cable.

When the mounting is finished, the module is connected with the addressing cable to the addressing unit and addressed. The addressing cable is then removed and the module connected to the bus cable.

Connection

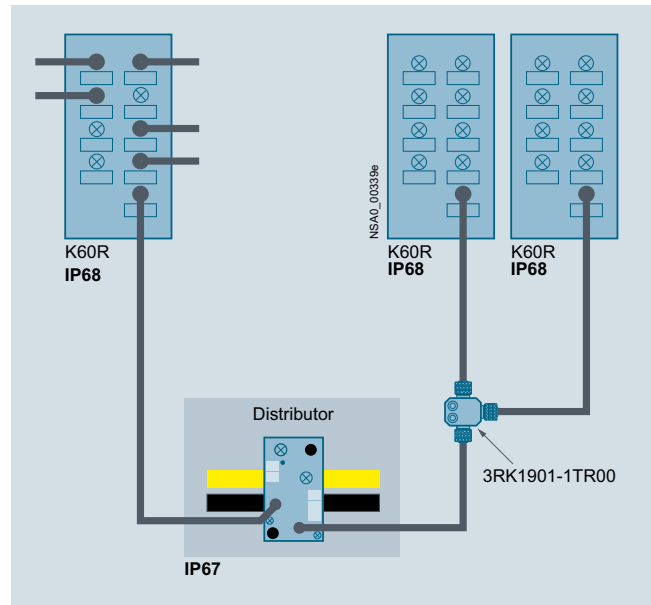

K60R connection options

In the IP67 environment, the service-proven standard components are connected using flat cables. Spur lines are laid into the IP68 environment by means of an AS-Interface M12 feeder (3RK1901-1NR..). The module is connected with a round cable to an M12 cable box. For this purpose, the module has an M12 bus connection instead of the former addressing socket. The AS-Interface bus cable and the 24 V DC auxiliary voltage are routed together in a 4-pole round cable. There must be no ground conductor in this round cable. Connection to ground is made through the mounting plate.

In the IP68 environment, only cables with extruded M12 plugs may be used.

To connect more than one K60R module to one spur line, the spur line can be split again using a T distributor (3RK1901-1TR00) with degree of protection IP68.

Please note the following conditions:

- The configuration guidelines for AS-Interface apply. For all M12 connecting cables, the maximum permissible current is limited to 4 A. The cross-section of these cables is just 0.34 mm². For connection of the K60R modules, the aforementioned M12 connecting cables can be used for the spur lines. The voltage drop caused by the ohmic resistance (approx. 0.11 Ω/m) must be taken into account.
- For round cable connections with shared AS-i and U_{aux} in a single cable, the following maximum lengths apply:
 - Per spur line from feeder to module: max. 5 m
 - Total of all round cable segments in an AS-Interface network: max. 20 m

AS-Interface**Slaves****I/O Modules for Use in the Field, High Degree of Protection****Digital I/O modules IP68/IP69K – K60R****IP68/IP69K tests**

K60R modules were tested with the following tests:

- Stricter test than IP67: 90 min at 1.8 m depth of water (IP67: 30 min at 1 m depth of water)
- Salt water test: Five months in salt water, 20 cm deep, at room temperature
- Test with particularly creepable oil: Five months completely under oil at room temperature
- Test with drilling emulsion: Five months at room temperature (components of the drilling emulsion: Anionic and non-ionic emulsifiers, paraffinic low-aromatic mineral oil, boric acid alkanolamines, corrosion inhibitors, oil content 40 %)
- Test in oil bath (Excellence 416 oil) with alternating oil bath temperature: 130 cycles of 15 to 55 °C, two months
- Cleaning with a high-pressure cleaner according to IP69K: 80 to 100 bar, 10 to 15 cm distance, time per side > 30 s, water temperature 80 °C

To simulate requirements as realistically as possible, the modules were artificially aged prior to the tests by 15 temperature cycles of -25/+85 °C. During the test, the modules were connected to 3RX1 connecting cables. Unassigned connections were closed with 3RK1901-1KA00 sealing caps.

Note:

Sealing caps and M12 connections must be tightened with the correct torque.

Selection and ordering data

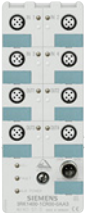
Version	SD	Article No.	Price per PU	PU (UNIT, SET, M)	PS*	PG
	d					
 <p>Digital I/O modules IP68/IP69K – K60R</p> <ul style="list-style-type: none"> • 4 inputs/4 outputs • Width 60 mm • IP68/IP69K • Standard assignment • Current carrying capacity <ul style="list-style-type: none"> - 200 mA (inputs) - 2 A (outputs) • Standard slave • Modules supplied without mounting plate <p>3RK1400-1CR00-0AA3</p>	2	3RK1400-1CR00-0AA3		1	1 unit	42C

AS-Interface

Slaves

I/O Modules for Use in the Field, High Degree of Protection

Digital I/O modules, IP67 – K45

Overview



Compact modules K45

The K45 series of compact modules supplements the large K60 compact modules which have a proven track record in industry. They are the logical consequence for rounding off the bottom end of the existing product range.

The acclaimed advantages of the existing K60 compact modules are fully emulated by the K45 modules. The K45 modules have a substantially smaller basic area and installation depth, however.

Yet in spite of these small dimensions all the modules have large labels and an integrated addressing socket.

Two mounting plates are offered for the K45 compact modules:

- Mounting plate for wall mounting
This has a hole pattern that is identical to that of the K60 compact modules. This means that K60 compact modules can be mounted together with K45 modules in an aligned arrangement. The shaped cables can be inserted in the recesses of the mounting plates where they cause no hindrance.
- Mounting plate for standard rail mounting

Connection of the AS-Interface shaped cables

The mounting plate and the compact module are joined together by means of a screw, with simultaneous contacting of the AS-Interface cable by the service-proven insulation piercing method.

Now, mounting the AS-Interface shaped cables is in fact easier than ever. The yellow and black AS-Interface shaped cable can be inserted into the mounting plates from the left or right regardless of the position of the coding lug. The correct polarity of the applied voltages is thus guaranteed.

Addressing and connection of the sensors/actuators

Addressing of the K45 compact modules is performed using an addressing socket integrated in the module. The addresses can be assigned even when mounted.

K45 modules with a maximum of four digital inputs and outputs

These compact modules contain up to four M12 standard connections or M8 standard connections for inputs and outputs. Using M12 or M8 standard connectors, a maximum of four sensors and four actuators can be connected to the compact module. Depending on the module, the sockets can be assigned in duplicate.

Pin assignment: Y – i.e. via a socket, two sensors or one sensor/one actuator are connected.

K45 modules with a maximum of eight digital inputs

These modules have eight digital inputs for connection through M12 plugs. The sockets have duplicate assignments. Pin assignment: Y – i.e. via a socket, two sensors or one sensor/one actuator are connected.

The module requires two AS-Interface addresses for processing all eight inputs. The addresses can be assigned through a double addressing socket integrated in the module.

K45 modules in compliance with AS-i Specification V3.0 with four digital inputs and outputs/four digital outputs

The extended address mode (A/B addresses) according to AS-Interface Specification V3.0 enables connection of up to 62 slaves on one AS-i network. With this extended address mode, four outputs are now possible even with A/B slaves (instead of only three outputs possible up to now with Specification V2.1). Hence with full expansion of an AS-Interface network, there are now 248 inputs as well as 248 outputs available on one AS-Interface system.

Points to bear in mind:

- These modules can be used only with a master according to AS-i Specification V3.0.
- The cycle times for the outputs may be up to 20 ms.

Depending on the module, the sockets can be assigned in duplicate.

Pin assignment: Y – i.e. via a socket, two sensors or one sensor/one actuator are connected.

AS-Interface Slaves

I/O Modules for Use in the Field, High Degree of Protection

Digital I/O modules, IP67 – K45

Selection and ordering data



3RK1400-0GQ20-0AA3

Version	SD	Article No.	Price per PU	PU (UNIT, SET, M)	PS*	PG
	d					
Digital I/O modules, IP67 – K45						
<ul style="list-style-type: none"> • PNP transistor • Width 45 mm • Current carrying capacity of the inputs: 200 mA • Modules supplied without mounting plate 						
Type	Current carrying capacity of outputs	Slave type	Pin assignment	U_{aux} 24 V	Connection methods	
8 inputs ¹⁾	--	A/B	Y	--	M12 2	3RK2200-0DQ20-0AA3
4 inputs	--	Standard	Standard	--	M12 ▶	3RK1200-0CQ20-0AA3
		Standard	Standard	--	M8 2	3RK1200-0CT20-0AA3
		A/B	Standard	--	M12 ▶	3RK2200-0CQ20-0AA3
		A/B	Standard	--	M8 5	3RK2200-0CT20-0AA3
2 x 2 inputs	--	A/B	Y	--	M12 2	3RK2200-0CQ22-0AA3
2 inputs/ 2 outputs	2 A ²⁾	Standard	Standard	✓	M12 ▶	3RK1400-1BQ20-0AA3
2 x (1 input/ 1 output)	0.2 A	Standard	Y	--	M12 2	3RK1400-0GQ20-0AA3
4 x (1 input/ 1 output)	0.2 A	A/B (Spec. V3.0)	Y	--	M12 5	3RK2400-0GQ20-0AA3
	0.5 A	A/B (Spec. V3.0)	Y	✓	M12 5	3RK2400-1GQ20-1AA3
4 outputs	1 A	A/B (Spec. V3.0)	Standard	✓	M12 2	3RK2100-1CQ20-0AA3
3 outputs	1 A	A/B	Standard	✓	M12 ▶	3RK2100-1EQ20-0AA3
4 outputs	1 A	Standard	Standard	✓	M12 ▶	3RK1100-1CQ20-0AA3
2 outputs/ 2 inputs	2 A	A/B	Standard	✓	M12 2	3RK2400-1BQ20-0AA3

✓ Available

-- Not available

¹⁾ Module occupies two AS-Interface addresses²⁾ The typical current carrying capacity per output increases with version "E12" from 1.5 to 2 A (available since approx. 07/2003).

Accessories



3RK1901-2EA00

K45 mounting plates

- For wall mounting ▶
- For standard rail mounting ▶

▶	3RK1901-2EA00	1	1 unit	42C
▶	3RK1901-2DA00	1	1 unit	42C



3RK1901-1MN00

Cable termination pieces

For sealing of open cable ends (shaped AS-Interface cable) in IP67

▶	3RK1901-1MN00	1	10 units	42C
---	----------------------	---	----------	-----



3RK1901-1KA00

AS-Interface sealing caps

- For free M12 sockets ▶
- For free M8 sockets 2

▶	3RK1901-1KA00	100	10 units	42C
2	3RK1901-1PN00	100	10 units	42C



3RK1901-1PN00

AS-Interface

Slaves

I/O Modules for Use in the Field, High Degree of Protection

Digital I/O modules, IP67 – K20

Overview



Digital I/O modules, IP67 - K20

The K20 compact module series rounds off the AS-Interface compact modules with a particularly slim design and only 20-mm width. Thanks to its extremely compact dimensions, these modules are particularly suited for handling machine applications in the field of production engineering where modules need to be arranged in the smallest of spaces.

Robotics is yet another application area. The K20 modules are connected to the AS-Interface with a round cable with M12 cable box instead of with the AS-Interface flat cable. The AS-Interface bus cable and the 24 V DC auxiliary energy are routed in this case in a shared round cable. This enables extremely compact installation.

The flexibility of the round cable means that it can also be used on moving machine parts without any problems. The K20 modules are also ideal for such applications as their non-encapsulated design makes them particularly light in weight.

In applications with tow chains, many users rely on placing the AS-Interface bus cable in a round cable. In this case, the K20 modules support direct connection to the round cable. No flat to round cable adapter is required.

The K20 compact module range includes standard AS-Interface modules, as well as an ASIsafe version for the connection of safety-related sensors, such as EMERGENCY-STOP pushbuttons or protective door monitoring. All standard AS-Interface K20 modules support, as far as technically possible, the expanded address mode (A/B addresses) according to AS-Interface Specification V2.1, which enables connection of 62 stations to an AS-Interface network. The K20 module with four inputs and four outputs works in expanded address mode according to AS-Interface Specification V3.0 which, for the first time, supports four outputs with an A/B slave, thus enabling 248 inputs and 248 outputs in a fully expanded AS-Interface network.

For particularly space-saving dimensions, the sensors and actuators are connected over M8 plug-in connectors. Alternatively, M12 connectors with Y-assignment can be used.

Selection and ordering data

Version	SD	Article No.	Price per PU	PU (UNIT, SET, M)	PS*	PG			
	d								
Digital I/O modules, IP67 – K20									
Width 20 mm									
Type	Current carrying capacity of outputs	Slave type	Pin assignment	Connection methods					
4 inputs	--	A/B	Standard	M8	2	3RK2200-OCT30-0AA3	1	1 unit	42C
	--	A/B	Y	M12	5	3RK2200-OCQ30-0AA3	1	1 unit	42C
2 inputs/ 2 outputs	1	A/B	Standard	M8	2	3RK2400-1BT30-0AA3	1	1 unit	42C
	1	A/B	Y	M12	2	3RK2400-1BQ30-0AA3	1	1 unit	42C
4 outputs	1	A/B (Spec. V3.0)	Standard	M8	2	3RK2100-1CT30-0AA3	1	1 unit	42C
4 inputs/ 4 outputs	1	Standard	Standard	M8	10	3RK1400-1CT30-0AA3	1	1 unit	42C
	1	A/B (Spec. V3.0)	Standard	M8	2	3RK2400-1CT30-0AA3	1	1 unit	42C
2 safe inputs	--	Standard	Y-II	M12	2	3RK1205-0BQ30-0AA3	1	1 unit	42C











3RK2200-OCT30-0AA3

AS-Interface Slaves

I/O Modules for Use in the Field, High Degree of Protection

Digital I/O modules, IP67 – K20

Accessories

Version	SD	Article No.	Price per PU	PU (UNIT, SET, M)	PS*	PG
	d					
		AS-Interface sealing caps				
		• For free M12 sockets		100	10 units	42C
		• For free M8 sockets		100	10 units	42C
3RK1901-1KA00						
						
3RK1901-1PN00						
		AS-Interface compact distributors, for AS-Interface flat cable				
		Current carrying capacity up to 8 A		1	1 unit	42C
3RK1901-1NN10						
		AS-Interface M12 feeders				
		• Degree of protection IP67				
		• Current carrying capacity up to 2 A				
3RX9801-0AA00						
		For flat cable	For	Cable length	Cable end in feeder	
		AS-i	M12 socket	--	Available	
						▶ 3RX9801-0AA00
						1 1 unit 42C
		AS-Interface M12 feeders				
		• Degree of protection IP67/IP68/IP69K				
		• Current carrying capacity up to 4 A				
3RK1901-1NR10						
		For flat cable	For	Cable length	Cable end in feeder	
		AS-i	M12 socket	--	Not available	
		AS-i	M12 cable box	1 m	Not available	
		AS-i	M12 cable box	2 m	Not available	
		AS-i/U _{aux}	M12 socket	--	Not available	
		AS-i/U _{aux}	M12 cable box	1 m	Not available	
		AS-i/U _{aux}	M12 cable box	2 m	Not available	
						▶ 3RK1901-1NR10
						▶ 3RK1901-1NR11
						▶ 3RK1901-1NR12
						▶ 3RK1901-1NR20
						▶ 3RK1901-1NR21
						▶ 3RK1901-1NR22
						1 1 unit 42C
						1 1 unit 42C
						1 1 unit 42C
						1 1 unit 42C
						1 1 unit 42C
						1 1 unit 42C
						1 1 unit 42C
3RK1901-1NR11						
		AS-Interface M12 feeders, 4-fold				
		Current carrying capacity up to 4 A				
		For flat cable	For	Cable length	Cable end in feeder	
		AS-i/U _{aux}	4-fold M12 socket, delivery includes mounting plate (for wall and standard rail mounting)	--	Not available	
						▶ 3RK1901-1NR04
						1 1 unit 42C
3RK1901-1NR04						
		M12 T distributors				
		• IP68				
		• 1 x M12 plug				
		• 2 x M12 box				
3RK1901-1TR00						
		M12 Y-shaped coupler plugs				
		For connection of two sensors to one M12 socket with Y-assignment				
6ES7194-1KA01-0XA0						
		M12 connecting cables				
		• 3-pole				
		• For addressing AS-i slaves with M12 bus connection				
		• Cable length 1.5 m				
3RK1902-4PB15-3AA0						
						▶ 6ES7194-1KA01-0XA0
						1 1 unit 250
						▶ 3RK1902-4PB15-3AA0
						1 1 unit 42D

AS-Interface

Slaves

I/O Modules for Use in the Field, High Degree of Protection

Analog I/O modules, IP67 – K60

Overview



K60 analog compact module

AS-Interface analog modules from the K60 compact series detect or issue analog signals locally. These modules are linked to the higher-level controller through an AS-Interface master according to Specification V2.1 or Specification V3.0.

The analog modules are divided into the following groups:

- Input modules for
 - Sensors with current sensor
 - Sensors with voltage signal
 - Sensors with thermal resistor
- Output modules for
 - Current actuators
 - Voltage actuators

The input modules according to profile 7.3/7.4 are available with two or four input channels. It is possible in addition to convert the two-channel module to using only one input channel, thus enabling very short times before the analog value is available. The conversion is effected by means of a jumper plug at socket 3. The transmission times achieved with analog modules according to Profile 7.A.9 are shorter by half than those achieved with Profile 7.3/7.4. Operation is adjustable in this case, e.g. it is possible to choose with the ID1 code whether the module is operated with one or two channels.

The output modules are configured as two-channel modules as standard.

The input and output channels are electrically separated from the AS-Interface network. If sensors with a higher power requirement are to be connected, more power can be supplied through the auxiliary voltage as an alternative to the internal supply.

In the manual "AS-Interface Analog Modules Profile 7.3/Profile 7.A.9", the modules are presented in great detail along with their technical specifications and in-depth notes on operation.

Sample function blocks round off the manual, [see "More information" on page 2/68.](#)

Benefits

- Analog modules are just as easy to integrate in AS-Interface as digital modules
- Analog values can be easily detected and issued locally
- Preprocessing of the analog value transfer in the master enables rapid evaluation of the analog values
- Up to four values can be detected using one analog module
- Faster transmission and conversion of analog values thanks to the new option for switching to single-channel operation

In addition, Specification V3.0 now also offers:

- A/B technology, now also with analog modules
- On average, double fast transmission times (only 3 or 4 cycles, depending on the resolution selected)
- Variable adjustable mode: 12-bit or 14-bit resolution, single-channel or two-channel, selectable via the ID1 code
- Additionally simplified handling of analog value processing with Specification V3.0 masters, the DP/AS-i LINK Advanced

Selection and ordering data

Version	SD	Article No.	Price per PU	PU (UNIT, SET, M)	PS*	PG
	d					



3RK1207-1BQ44-0AA3

**Analog I/O modules IP67 – K60,
analog profile 7.3**

- Slave type: Standard
- Width 60 mm
- Modules supplied without mounting plate

Inputs	Type	Measuring range				
1 or 2 inputs (selectable using jumper plug at socket 3)	Current	4 ... 20 mA or ± 20 mA (selectable) ¹⁾	2	3RK1207-1BQ40-0AA3	1	1 unit 42C
	Voltage	± 10 V or 1 ... 5 V (selectable)	2	3RK1207-2BQ40-0AA3	1	1 unit 42C
	Thermal resistance	Pt100 or Ni100 or 0 ... 600 Ω (selectable) ¹⁾	2	3RK1207-3BQ40-0AA3	1	1 unit 42C
4 inputs	Current	4 ... 20 mA or ± 20 mA (selectable)	2	3RK1207-1BQ44-0AA3	1	1 unit 42C
	Voltage	± 10 V or 1 ... 5 V (selectable)	10	3RK1207-2BQ44-0AA3	1	1 unit 42C
	Thermal resistance	Pt100 or Ni100 or 0 ... 600 Ω (selectable)	2	3RK1207-3BQ44-0AA3	1	1 unit 42C
Outputs	Type	Output range				
2 outputs	Current for 2-wire actuators	4 ... 20 mA or ± 20 mA or 0 ... 20 mA (selectable) ¹⁾	2	3RK1107-1BQ40-0AA3	1	1 unit 42C
	Voltage for 2-wire actuators	± 10 V or 0 ... 10 V or 1 ... 5 V (selectable)	2	3RK1107-2BQ40-0AA3	1	1 unit 42C



3RK2207-2BQ50-0AA3

**Analog I/O modules IP67 – K60,
analog profile 7.A.9**

- Slave type: A/B (Spec. V3.0)
- Width 60 mm
- Modules supplied without mounting plate





Inputs	Type	Measuring range				
1 or 2 inputs (variably adjustable)	Current	4 ... 20 mA or ± 20 mA (selectable)	2	3RK2207-1BQ50-0AA3	1	1 unit 42C
	Voltage	± 10 V or 1 ... 5 V (selectable)	2	3RK2207-2BQ50-0AA3	1	1 unit 42C

¹⁾ Some modules are available in the extended temperature range (from -25 to 70 °C) and for use in difficult environmental conditions (coated according to environment standard IEC 60721).

Description	SIPLUS article number	Corresponds to module
SIPLUS AS-Interface 2AA, IP67	6AG1107-1BQ40-7AA3	3RK1107-1BQ40-0AA3
SIPLUS AS-Interface 2AI, IP67	6AG1207-1BQ40-7AA3	3RK1207-1BQ40-0AA3
SIPLUS AS-Interface 2AI, IP67	6AG1207-3BQ40-7AA3	3RK1207-3BQ40-0AA3

For more information, see www.siemens.com/siplus-extreme.

AS-Interface**Slaves****I/O Modules for Use in the Field, High Degree of Protection****Analog I/O modules, IP67 – K60****Accessories**

Version	SD	Article No.	Price per PU	PU (UNIT, SET, M)	PS*	PG
	d					
 3RK1901-0CA00		K60 mounting plates				
		<ul style="list-style-type: none"> Wall mounting ▶ 3RK1901-0CA00 Standard rail mounting ▶ 3RK1901-0CB01 		1	1 unit	42C
				1	1 unit	42C
 3RK1901-1KA00		M12 sealing caps				
		▶ 3RK1901-1KA00		100	10 units	42C
 3RK1902-0AR00	2	Sealing sets				
		<ul style="list-style-type: none"> For K60 mounting plate and distributor Cannot be used for K45 mounting plate One set contains one straight and one shaped seal 		100	5 units	42D
 3RK1901-1AA00	2	Jumper plugs				
		For changing over the 2-channel input modules		1	1 unit	42C

More information**More information**

For the Manual "AS-Interface Analog Modules Profile 7.3/Profile 7.A.9", see <https://support.industry.siemens.com/cs/ww/en/view/7643815>

Overview



SC17.5F, SC17.5 and SC22.5 SlimLine Compact modules

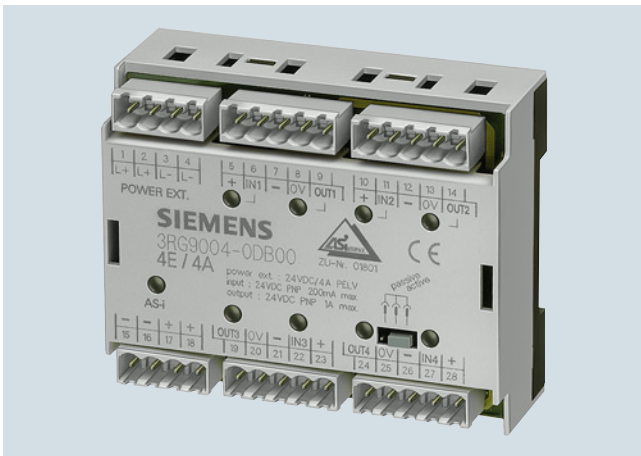

F90 module



Flat module

For AS-Interface applications inside control cabinets, there are various module series for the most diverse requirements:

- SlimLine Compact – particularly slim design ideal for space-saving use in the control cabinet
- F90 module – particularly flat design for flat control boxes
- Flat module – special design for integration into customer-specific solutions

The existing SlimLine series of modules S22.5 and S45 are being replaced by the innovative new devices in the SlimLine Compact SC17.5, SC17.5F and SC22.5 series. The previous SlimLine modules are still available as replacements for existing systems.

Available versions

The following table provides an overview of the key features of the different series of control cabinet modules.

Feature	SlimLine Compact	F90 module	Flat module
Digital I/O	✓	✓	✓
Analog I/O	✓	--	--
Safe inputs	✓	--	--
Relay outputs	✓	--	--
A/B slave	✓	--	--
Mounting onto TH 35 standard mounting rail according to IEC 60715	✓	✓	--
Wall mounting using push-in lugs	✓	--	--
Integrated lugs for screw fixing	--	--	✓
Width in mm	17.5 or 22.5	90	80

✓ Available

-- Not available

AS-Interface

Slaves

I/O Modules for Use in the Control Cabinet

SlimLine Compact

Overview

SlimLine Compact modules



SC17.5 and SC22.5 SlimLine Compact modules with screw terminals

The AS-Interface module series for the control cabinet SlimLine Compact with degree of protection IP20 creates space in the cabinet and in distributed local control boxes. A width of just 17.5 mm or 22.5 mm ensures considerable space savings in the control cabinet.

The SlimLine Compact module series comprises not only digital and analog I/O modules but also ASIsafe modules with safe inputs. Digital outputs are available as solid-state and relay outputs.

Sensors and actuators, as well as the AS-Interface bus cable, are connected by means of removable screw or push-in spring-type terminals. Device connectors available as accessories offer the possibility of looping through the AS-Interface bus cable and the 24 V DC power supply U_{aux} from one module to additional modules. This significantly simplifies the wiring, as the AS-Interface bus cable and U_{aux} only have to be connected to one device.

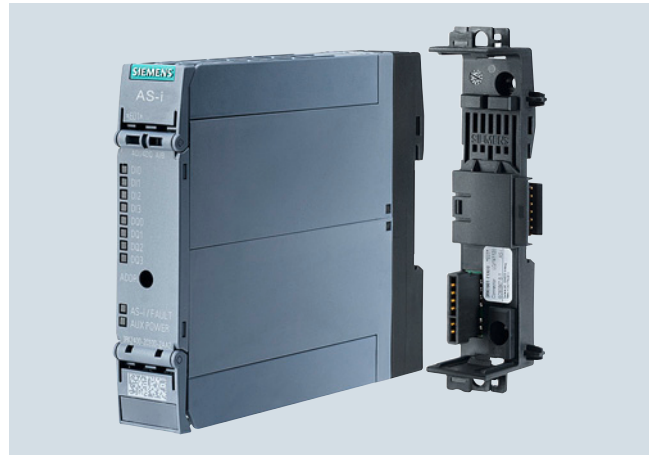

SlimLine Compact module SC22.5 with connector with screw terminals

All devices for the connection of 3-wire sensors offer the option of supplying the sensors either from the AS-Interface bus cable or alternatively from the 24 V DC voltage supply U_{aux} depending on the requirements of the particular application. A slide switch is used to make the selection. If supply via U_{aux} is selected, the wiring of the sensor terminals remains unchanged. This means that no external supply is required for the sensors.





All modules have LEDs on the front that provide diagnostic information and indicate the status of the module inputs and outputs. An addressing socket integrated at the front enables the module to be addressed also when it is installed. Integrated adapters permit mounting onto a standard mounting rail – either directly for the module or for the device connector. Alternatively, the modules can also be screw-mounted using push-in lugs (accessories). These lugs for screw fastening must be ordered separately.

Selection and ordering data

PU (UNIT, SET, M) = 1
 PS* = 1 unit
 PG = 42C

More information

For the Manual "AS-Interface SlimLine Compact Modules", see <https://support.industry.siemens.com/cs/ww/en/view/109481489>

Version I/O type	Width mm	Inputs	Outputs	SD d	Screw terminals		Spring-type terminals (push-in)		
					Article No.	Price per PU	Article No.	Price per PU	
SC17.5 and SC22.5 digital SlimLine Compact modules									
Slave type: A/B slave									
	4 inputs	17.5	2-wire	--	2	3RK2200-0CE00-2AA2	2	3RK2200-0CG00-2AA2	
		22.5	3-wire	--	2	3RK2200-2CE00-2AA2	2	3RK2200-2CG00-2AA2	
	4 outputs	22.5	--	2A solid-state	2	3RK2100-1CE00-2AA2	2	3RK2100-1CG00-2AA2	
	4 inputs/ 2 outputs, relays	22.5	3-wire	Relay (change-over contact)	2	3RK2402-2ME00-2AA2	2	3RK2402-2MG00-2AA2	
	4 inputs/ 4 outputs, relays	22.5	3-wire	Relay (NO contacts)	2	3RK2402-2CE00-2AA2	2	3RK2402-2CG00-2AA2	
	4 inputs/ 4 outputs	22.5	3-wire	2A solid-state	2	3RK2400-2CE00-2AA2	2	3RK2400-2CG00-2AA2	
Slave type: standard slave									
	4 inputs/ 4 outputs	22.5	3-wire	2A solid-state	2	3RK1400-2CE00-2AA2	2	3RK1400-2CG00-2AA2	
SC22.5 analog SlimLine Compact modules									
Slave type: standard slave									
	4 inputs	22.5	Voltage/ current selectable	--	2	3RK1207-0CE00-2AA2	2	3RK1207-0CG00-2AA2	
			Thermal resistance	--	2	3RK1207-3CE00-2AA2	2	3RK1207-3CG00-2AA2	
	2 outputs	22.5	--	Voltage/ current selectable	2	3RK1107-0BE00-2AA2	2	3RK1107-0BG00-2AA2	
SC17.5F ASIsafe SlimLine Compact modules									
	2 safe inputs	17.5	For mechanical contacts	--	2	3RK1205-0BE00-2AA2	2	3RK1205-0BG00-2AA2	
	2 safe inputs/ 2 standard outputs	17.5	For mechanical contacts	Solid-state, U_{AS} / U_{aux} supply selectable	2	3RK1405-2BE00-2AA2	2	3RK1405-2BG00-2AA2	

AS-Interface

Slaves

I/O Modules for Use in the Control Cabinet

SlimLine Compact

Accessories

Version	SD	Article No.	Price per PU	PU (UNIT, SET, M)	PS*	PG
Device connectors						
For electrical connection of SlimLine Compact modules (connects AS-i bus cable and 24 V DC auxiliary power supply U_{aux} when using several SlimLine Compact modules)						
	2	3RK1901-1YA00		1	1 unit	42C
	2	3RK1901-1YA10		1	1 unit	42C
Device termination connectors						
Required for the last module in the network						
	2	3RK1901-1YA01		1	1 unit	42C
	2	3RK1901-1YA11		1	1 unit	42C
Removable terminals						
Screw terminals 						
	2	3ZY1121-1BA00		1	6 units	41L
	2	3ZY1141-1BA00		1	6 units	41L
Spring-type terminals (push-in) 						
	2	3ZY1121-2BA00		1	6 units	41L
	2	3ZY1141-2BA00		1	6 units	41L
Push-in lugs for wall mounting						
	2	3ZY1311-0AA00		1	10 units	41L
Coding pins for removable terminals						
	2	3ZY1440-1AA00		1	12 units	41L
Blank labels						
Unit labeling plates ¹⁾						
	20	3RT2900-1SB10		100	816 units	41B
	20	3RT2900-1SB20		100	340 units	41B
Tools for opening spring-type terminals						
	2	3RA2908-1A		1	1 unit	41B

¹⁾ PC labeling system for individual inscription of unit labeling plates available from: murrplastik Systemtechnik GmbH (see page 16/15).

More information

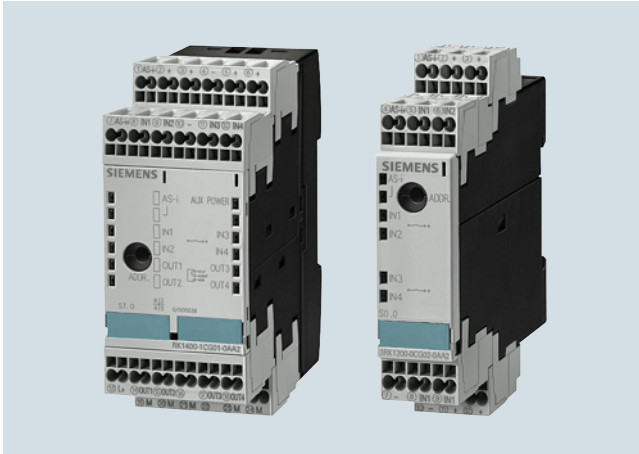

SlimLine modules S45 (picture on left) and S22.5 module (picture on right) with spring-type terminals

The existing SlimLine series of I/O modules for use in the control cabinet is being replaced by the new, innovative SlimLine Compact series. We recommend that these new devices are used in future.

The code conversion table indicates the best options for replacing the existing SlimLine devices with SlimLine Compact devices.

Note:

The previous SlimLine devices are still available for use as replacements in existing systems. As a result of the innovation, the new SlimLine Compact devices are not fully compatible in terms of either mechanical dimensions or electrical properties.

The code conversion table below links the existing SlimLine S22.5, S22.5F and S45 modules with the new SlimLine Compact SC17.5, SC17.5F and SC22.5 devices.

Code conversion table

S22.5, S22.5F and S45 SlimLine			Comparison type: SC17.5, SC17.5F and SC22.5 SlimLine Compact		
Screw terminals	Spring-type terminals	Version	Screw terminals	Spring-type terminals	Version
3RK1200-0CE00-0AA2	3RK1200-0CG00-0AA2	4DI, 2-wire, standard slave	3RK2200-0CE00-2AA2	3RK2200-0CG00-2AA2	4DI, 2-wire, A/B slave
3RK2200-0CE02-0AA2	3RK2200-0CG02-0AA2	4DI, A/B slave	3RK2200-2CE00-2AA2	3RK2200-2CG00-2AA2	4DI, A/B slave
3RK1200-0CE02-0AA2	3RK1200-0CG02-0AA2	4DI, standard slave			
3RK1400-0BE00-0AA2	3RK1400-0BG00-0AA2	2DI/2DQ, standard slave	3RK1400-2CE00-2AA2	3RK1400-2CG00-2AA2	4DI/4DQ, standard slave
3RK1402-0BE00-0AA2	3RK1402-0BG00-0AA2	2DI/2DQ relay, standard slave	3RK2402-2ME00-2AA2	3RK2402-2MG00-2AA2	4DI/2DQ relay, A/B slave
3RK1100-1CE00-0AA2	3RK1100-1CG00-0AA2	4DQ, standard slave	3RK2100-1CE00-2AA2	3RK2100-1CG00-2AA2	4DQ, A/B slave
3RK2400-1CE01-0AA2	3RK2400-1CG01-0AA2	4DI/4DQ A/B slave	3RK2400-2CE00-2AA2	3RK2400-2CG00-2AA2	4DI/4DQ, A/B slave
3RK2400-1FE00-0AA2	3RK2400-1FG00-0AA2	4DI/3DQ, A/B slave			
3RK1400-1CE00-0AA2	3RK1400-1CG00-0AA2	4DI/4DQ, 1 A solid-state, standard slave	3RK1400-2CE00-2AA2	3RK1400-2CG00-2AA2	4DI/4DQ, 2 A solid-state, standard slave
3RK1400-1CE01-0AA2	3RK1400-1CG01-0AA2	4DI/4DQ, 2 A solid-state, standard slave			
3RK1402-3CE01-0AA2	3RK1402-3CG01-0AA2	4DI/4DQ (sensor supply from U_{aux}), standard slave			
3RK1402-3CE00-0AA2	3RK1402-3CG00-0AA2	4DI/4DQ, relay, standard slave	3RK2402-2CE00-2AA2	3RK2402-2CG00-2AA2	4DI/4DQ, relay, A/B slave
3RK1205-0BE00-0AA2	3RK1205-0BG00-0AA2	2F-DI	3RK1205-0BE00-2AA2	3RK1205-0BG00-2AA2	2F-DI
3RK1405-0BE00-0AA2	3RK1405-0BG00-0AA2	2F-DI/2DQ (outputs supplied from U_{ASI})	3RK1405-2BE00-2AA2	3RK1405-2BG00-2AA2	2F-DI/2DQ (supply U_{ASI}/U_{aux} selectable)
3RK1405-1BE00-0AA2	3RK1405-1BG00-0AA2	2F-DI/2DQ (outputs supplied from U_{aux})			

AS-Interface

Slaves

I/O Modules for Use in the Control Cabinet

F90 module

Selection and ordering data

Version	SD	Article No.	Price per PU	PU (UNIT, SET, M)	PS*	PG																																								
	d																																													
 <p>F90 module</p> <ul style="list-style-type: none"> • Standard slave • Width 90 mm • With COMBICON version: Delivery without COMBICON connector 																																														
<table border="1"> <thead> <tr> <th>Type</th> <th>Connection</th> <th>Inputs</th> <th>Outputs</th> <th></th> <th></th> <th></th> </tr> </thead> <tbody> <tr> <td rowspan="6">4 inputs/ 4 outputs</td> <td rowspan="3">Screw</td> <td>2- and 3-wire PNP transistor</td> <td>PNP transistor 1 A</td> <td>5</td> <td>3RG9002-0DB00</td> <td>1 1 unit 42C</td> </tr> <tr> <td>2- and 3-wire PNP transistor</td> <td>PNP transistor 2 A</td> <td>5</td> <td>3RG9002-0DA00</td> <td>1 1 unit 42C</td> </tr> <tr> <td>2- and 3-wire PNP transistor floating</td> <td>PNP transistor 2 A</td> <td>5</td> <td>3RG9002-0DC00</td> <td>1 1 unit 42C</td> </tr> <tr> <td rowspan="3">COMBICON¹⁾</td> <td>2- and 3-wire PNP transistor</td> <td>PNP transistor 1 A</td> <td>5</td> <td>3RG9004-0DB00</td> <td>1 1 unit 42C</td> </tr> <tr> <td>2- and 3-wire PNP transistor</td> <td>PNP transistor 2 A</td> <td>5</td> <td>3RG9004-0DA00</td> <td>1 1 unit 42C</td> </tr> <tr> <td>2- and 3-wire PNP transistor floating</td> <td>PNP transistor 2 A</td> <td>5</td> <td>3RG9004-0DC00</td> <td>1 1 unit 42C</td> </tr> </tbody> </table>							Type	Connection	Inputs	Outputs				4 inputs/ 4 outputs	Screw	2- and 3-wire PNP transistor	PNP transistor 1 A	5	3RG9002-0DB00	1 1 unit 42C	2- and 3-wire PNP transistor	PNP transistor 2 A	5	3RG9002-0DA00	1 1 unit 42C	2- and 3-wire PNP transistor floating	PNP transistor 2 A	5	3RG9002-0DC00	1 1 unit 42C	COMBICON ¹⁾	2- and 3-wire PNP transistor	PNP transistor 1 A	5	3RG9004-0DB00	1 1 unit 42C	2- and 3-wire PNP transistor	PNP transistor 2 A	5	3RG9004-0DA00	1 1 unit 42C	2- and 3-wire PNP transistor floating	PNP transistor 2 A	5	3RG9004-0DC00	1 1 unit 42C
Type	Connection	Inputs	Outputs																																											
4 inputs/ 4 outputs	Screw	2- and 3-wire PNP transistor	PNP transistor 1 A	5	3RG9002-0DB00	1 1 unit 42C																																								
		2- and 3-wire PNP transistor	PNP transistor 2 A	5	3RG9002-0DA00	1 1 unit 42C																																								
		2- and 3-wire PNP transistor floating	PNP transistor 2 A	5	3RG9002-0DC00	1 1 unit 42C																																								
	COMBICON ¹⁾	2- and 3-wire PNP transistor	PNP transistor 1 A	5	3RG9004-0DB00	1 1 unit 42C																																								
		2- and 3-wire PNP transistor	PNP transistor 2 A	5	3RG9004-0DA00	1 1 unit 42C																																								
		2- and 3-wire PNP transistor floating	PNP transistor 2 A	5	3RG9004-0DC00	1 1 unit 42C																																								

¹⁾ Scope of supply does not include COMBICON connector set 3RX9810-0AA00, this must be ordered separately, see "Accessories".

Accessories

Version	SD	Article No.	Price per PU	PU (UNIT, SET, M)	PS*	PG
	d					
<p>COMBICON connector sets</p> <p>For 4I/4O modules with COMBICON connection; one set comprises:</p> <ul style="list-style-type: none"> • 4 x 5-pole plug for connection • Standard sensors/actuators • 2 x 4-pole plug for AS-Interface and external auxiliary voltage 						
	5	3RX9810-0AA00		1 1 unit 42C		

Overview



Flat module 4I/4O

The flat module for the control cabinet in degree of protection IP20 has four inputs and four outputs.



The module is fitted at the front with an LED which indicates the module's status.

With the integrated lugs, the modules can be screwed on.

An integrated addressing socket enables the module to be addressed when it is installed.

Standard sensors/actuators and the AS-Interface cable can be connected using screw terminals.

Selection and ordering data

Version	SD	Screw terminals 	PU (UNIT, SET, M)	PS*	PG
		Article No.	Price per PU		
 <p>Flat module 4I/4O</p> <ul style="list-style-type: none"> • 4 inputs/4 outputs • 200 mA for all I/Os 	d				
	2	3RK1400-0CE00-0AA3	1	1 unit	42C

3RK1400-0CE00-0AA3

AS-Interface Slaves Modules with Special Functions

Counter modules

Overview



Counter module with spring-type terminals

The counter module is used to send hexadecimally coded count values (LSB=D0, MSB=D3) to a higher-level controller. The count value is increased by 1 for each valid count pulse at terminal 8. Beginning at 0, the module counts up to 15 and then begins again at 0. The controller adopts the current value and determines the number of pulses between two host invocations through subtraction from the previous value. The total number of count pulses is determined by adding these differences.

For the values sent to be unambiguous, no more than 15 count values are allowed between two host invocations or AS-Interface master invocations at terminal 8. The maximum permissible transmission frequency is calculated from these times:

$$f_{Tmax} = 15 / T_{max}$$

T_{max} : max. possible transmission time from the slave to the host

A further condition for the maximum frequency is the required pulse shape. For the counter to accept a pulse as valid, a Low must have been applied at the input for at least 300 μ s and a High for at least 1 ms.

This results in a maximum frequency of $f_{Zmax} = 1 / 1.3 \text{ ms} = 769 \text{ Hz}$ independently of the control system (see figure below).

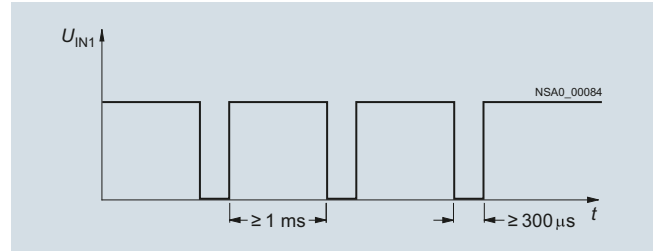

Maximum frequency for the counter module

If the time criterion stipulated in the figure is violated, the count value is rejected.

The counter is active only for the reset parameter P2 (default). The counter is deleted when P2 is set, and the incoming count pulses are not registered until after P2 is reset again.

Note:

A customized function block is necessary or must be programmed.

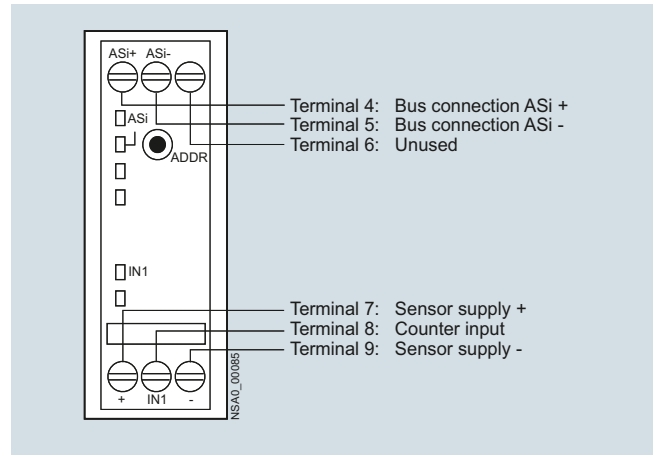

Counter module connection options

Selection and ordering data

Version	SD	Article No.	Price per PU	PU (UNIT, SET, M)	PS*	PG
Counter modules						
Width 22.5 mm						
• With screw terminals	10	3RK1200-0CE03-0AA2		1	1 unit	42C
• With spring-type terminals	10	3RK1200-0CG03-0AA2		1	1 unit	42C



3RK1200-0CE03-0AA2



3RK1200-0CG03-0AA2

Overview



Ground-fault detection module

"Ground faults in any control circuit must not lead to unintentional starting or potentially hazardous movements or prevent the machine from stopping." (IEC 60204-1/VDE 0113-1).

The AS-Interface ground-fault detection module is used to meet these requirements. Using this module from the SlimLine series, ground faults in AS-Interface systems can be reliably detected and reported.

The following ground faults are detected:

- Ground fault from AS-i "+"
- Ground fault from AS-i "-"
- Ground fault from sensors and actuators that are supplied from the AS-Interface voltage.

Note:

Not suitable for AS-i Power24V.

Selection and ordering data

Version	SD	Article No.	Price per PU	PU (UNIT, SET, M)	PS*	PG
	d					

Ground-fault detection modules

Width 22.5 mm

- With screw terminals



5

- With spring-type terminals



5

3RK1408-8KE00-0AA2

1

1 unit

42C

3RK1408-8KG00-0AA2

1

1 unit

42C



3RK1408-8KE00-0AA2

AS-Interface

Slaves

Modules with Special Functions

Overvoltage protection module

Overview



AS-Interface overvoltage protection module

The AS-Interface overvoltage protection module (protection module) protects downstream AS-Interface devices or individual sections in AS-i networks from conducted overvoltages which can be caused by switching operations and remote lightning strikes. The location of the protection module forms the transition from zone 1 to 2/3 within the lightning protection zone concept. Direct lightning strikes must be coped with using additional protective measures at the transitions from lightning protection zone 0A to 1.

With the AS-Interface overvoltage protection module, it is now also possible to integrate AS-Interface in the overall overvoltage protection concept of a plant or machine.

The module has the same design and degree of protection (IP67) as the AS-Interface K45 compact modules. It is a passive module and as such does not need its own address on the AS-Interface network. The module can be used to protect the AS-Interface cable and the cable for the auxiliary voltage from overvoltage. Overvoltages are discharged through a ground cable with a green/yellow oil-proof outer sheath. This cable is fixed in the module and must be connected with low resistance to the system's ground.

Rated discharge current I_{sn}

The rated discharge current is the peak value of a surge current of the form 8/20 μ s (microseconds), for which the protection module is designed in accordance with a specified test program. With an 8/20 waveform, 100 % of the value is achieved after 8 μ s and 50 % after 20 μ s.

Protection level U_p

The protection level of a protection module is the highest momentary value of the voltage at the terminals, established in individual tests and characterizes the capability of a protection module to limit overvoltages to a residual level.

Configuration guidelines

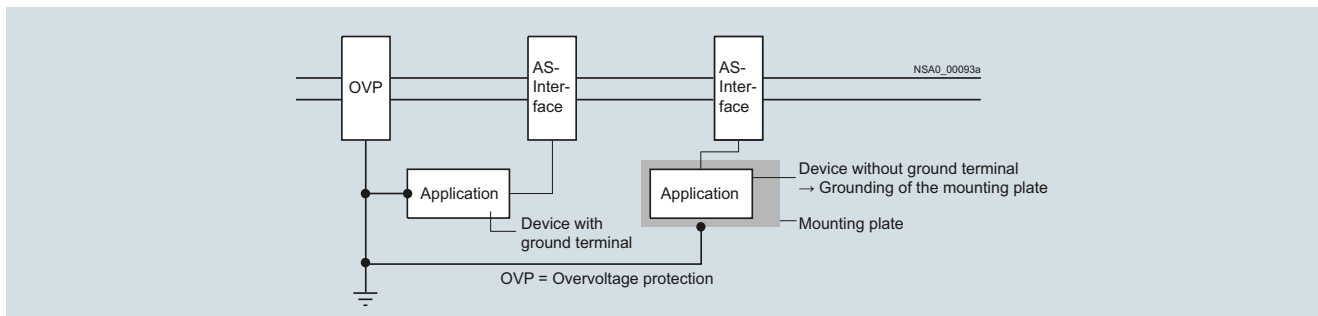

The grounding of protection modules and the units to be protected must be effected through a shared grounding point.

If insulated devices are protected, their mounts must be included in the grounding points.

Sample application

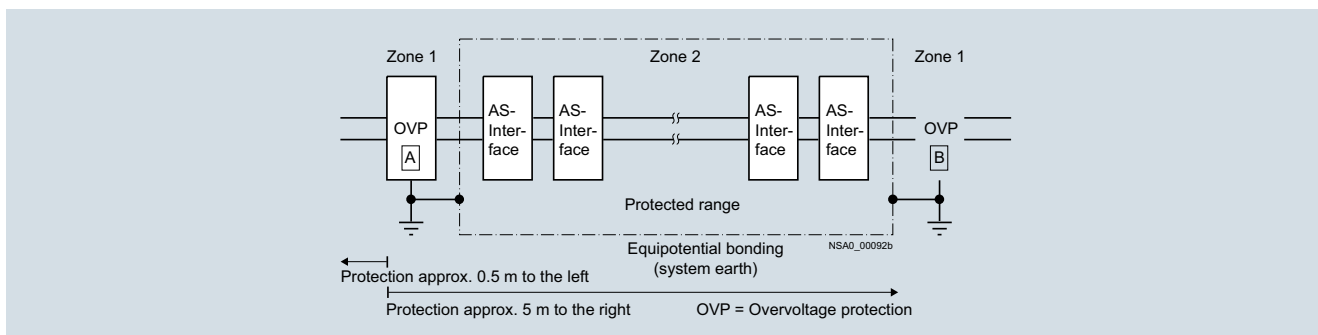

Selection and ordering data

Version	SD	Article No.	Price per PU	PU (UNIT, SET, M)	PS*	PG
d	5	3RK1901-1GA01		1	1 unit	42C
AS-Interface overvoltage protection module Delivery includes mounting plate (for wall and standard rail mounting)						



Overview



AS-Interface power supply unit for 3 A

AS-Interface power supply units feed 30 V DC into the AS-Interface cable and supply the AS-Interface components. They include power-optimized data decoupling for the separation of communication signals and control supply voltage. As the result, AS-Interface is able to convey both data and power along a single line. The power supply units are resistant to overload and short circuits.

Dimensions

AS-Interface power supply units have compact dimensions in widths of 50/70/120 mm. No distances from other devices need to be observed when mounting the power supply units.

Features

- Higher rating: The power supply units deliver currents of 2.6 to 8 A.
- Integrated data decoupling: As the result, AS-Interface is able to convey both data and power along a single line.
- Integrated ground-fault detection: The power supply units perform the reliable detection and signaling of ground faults according to IEC 60204-1. The AS-Interface voltage can be disconnected automatically in the event of a ground fault.
- Integrated overload detection: An output overload is detected and reported over a diagnostics LED.
- Diagnostics memory: Any ground faults or overloads on the output side are stored in a diagnostics memory until the device is RESET.
- Remote RESET and remote signaling: Using relay contacts, a ground fault can be signaled and evaluated by a central controller and/or indicator light.
- Diagnostics LEDs: Three different LEDs indicate the status of the AS-Interface power supply locally at the power supply unit.
- Ultra-wide input range/two-phase connection: The ultra-wide input range of 120 to 500 V of the 8 A version means that the supply units can be used in virtually any network worldwide. In addition, this version dispenses with the need for an N conductor as the device can be connected directly between 2 phases of a network.
- Operation with 24 V DC: The 3 A power supply unit is also available as a version with a 24 V DC input. This power supply unit is suitable for use in battery-powered systems or in systems with UPS (uninterruptible power supply).
- Removable terminal blocks with spring-type connections: For easy exchanging of devices, each power supply unit has three removable terminal blocks: for the input side, for the output side and for Signal/RESET connections.

Benefits

- Complete solution for supplying AS-Interface networks while making full use of the maximum possible cable length per AS-i segment
- Only AS-i masters and AS-i slaves need to be connected to the AS-Interface cable in order to operate AS-Interface
- Compact, space-saving dimensions
- Reliable power supply even for large numbers of AS-Interface modules with a high power requirement
- Integrated ground-fault and overload detection saves the need for additional components and enhances safety
- Fast fault detection and reduced downtimes thanks to diagnostics memory, remote signaling and remote RESET
- Reduced downtimes as the result of removable terminal blocks which enable the fast exchanging of devices
- Ultra-wide input range of the 8 A version permits single-phase and two-phase operation and removes the need for an N conductor
- Can be used world-wide thanks to, for example, UL/CSA approval (UL 508)
- With the 2.6 A version, the output power is restricted to max. 100 W for use in Class 2 circuits in accordance with NEC (National Electrical Code)

Selection and ordering data

Version	SD	Spring-type terminals	PU (UNIT, SET, M)	PS*	PG
	d	Article No.	Price per PU		



3RX9501-0BA00



3RX9503-0BA00

AS-Interface power supply units, IP20

- AS-i single output 30 V DC
- With integrated ground-fault detection
- 2.6 A version with output power restricted to max. 100 W (for Class 2 circuits in accordance with NEC)
- Dimensions:
Width: 50 mm (2.6 A/3 A), 70 mm (5 A), 120 mm (8 A);
Height: 125 mm;
Depth: 125 mm

Output current	Input voltage	Article No.	Price per PU	PU (UNIT, SET, M)	PS*	PG
2.6 A/max. 100 W	120/230 V AC (selectable)	▶ 3RX9501-2BA00		1	1 unit	42C
3 A	120/230 V AC (selectable)	▶ 3RX9501-0BA00		1	1 unit	42C
3 A	24 V DC	▶ 3RX9501-1BA00		1	1 unit	42C
5 A	120/230 V AC (selectable)	▶ 3RX9502-0BA00		1	1 unit	42C
8 A	120/230 ... 500 V AC (selectable)	▶ 3RX9503-0BA00		1	1 unit	42C

AS-Interface

Power Supply Units and Data Decoupling Modules

30 V power supply units

Overview



PSN130S 30 V power supply units for 3 A, 4 A and 8 A

The PSN130S 30 V power supplies feed 30 V DC into the AS-Interface cable and supply the AS-Interface components, but do not include data decoupling. Data decoupling modules are needed in addition therefore to separate communication signals and control supply voltage, [see page 2/82 or 2/84](#).

The power supply units are resistant to overload and short circuits.

Dimensions

The 30 V power supply units have compact dimensions with widths of 50 and 70 mm. No distances from other devices need to be observed when mounting the power supply units.

Features

- Primary clocked power supply units for connection to a single-phase AC network
- Power for currents of 3 A, 4 A and 8 A
- The output voltage is floating, and resistant to short-circuits and no-load operation. If there is an overload, the output voltage is reduced or cut-off. After a short-circuit or overload, the devices start up again automatically.
- In the event of a device fault, the output voltage will be limited to max. 37 V.
- Modular installation devices in degree of protection IP20 and safety class I
- Diagnostics: With an output voltage > 26.5 V DC, the green LED (30V O.K.) is lit and the signaling contact 13-14 is closed.

Benefits

- Low-cost alternative solution for supplying AS-Interface networks while making full use of the maximum possible cable length per AS-i segment
- Cost advantage particularly for multiple networks
- Compact, space-saving dimensions
- Reliable power supply even for large numbers of AS-Interface modules with a high power requirement
- Can be used world-wide thanks to, for example, UL/CSA approval (UL 508)

Application

Configuration examples of AS-Interface networks with a 30 V power supply unit

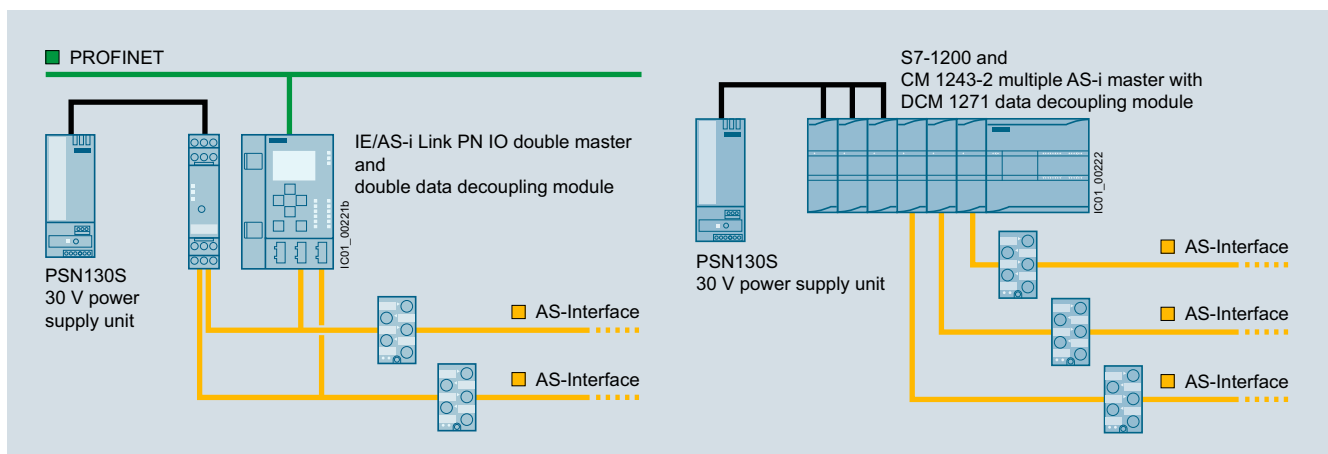

Configuration of AS-Interface multiple networks with one PSN130S 30 V power supply unit (examples with schematic representation):

Left: Double network based on the S22.5 double data decoupling module and IE/AS-i Link PN IO double master

Right: Triple network based on the SIMATIC S7-1200 with DCM 1271 data decoupling modules and CM 1243-2 communication processors

Technical specifications

Version		3 A	4 A	8 A
Input data				
• Input voltage, rated value U_e	V AC	120/230 V, single-phase, automatic selection		
• Range of input voltage	V AC	85 ... 132/174 ... 264		
• Mains frequency	Hz	50/60		
• Power consumption at full load, typ.	W	103	139	270
Output data				
• Output voltage, rated value U_a	V DC	30		
• Residual ripple	mV _{pp}	< 150		
• Output current, rated value at -20 ... +60 °C	A	3	4	8
• Max. output current at +60 ... +70 °C	A	3	3	4
Degree of efficiency in rated conditions				
• Degree of efficiency	%	87	88	90
• Power loss, typ.	W	12	17	25
Protection and monitoring				
• Output overvoltage protection	V	< 37		
• Current limit, typ.	A	4	5.5	11
Safety				
• Primary/secondary electrical isolation		Output voltage PELV/SELV according to IEC 60950 and EN 50178		
• Protection class		I		
• Degree of protection		IP20		

Version		3 A	4 A	8 A
Approvals				
• UL		UL 508/CSA 22.2		
• Pollution degree		IEC 60950		
• Overvoltage category and electrical separation		EN 50178 and IEC 61558		
EMC				
• Emitted interference (class B)		IEC 61000-6-3		
• Line harmonics limit		IEC 61000-3-2		
• Interference immunity		IEC 61000-6-2		
Operating data				
Ambient temperature				
• Operation	°C	-20 ... +70		
• Transport/storage	°C	-40 ... +85		
Pollution degree		2		
Humidity class		Climate class according to DIN 50010, relative air humidity max. 100%, without condensation		
Dimensions and weight				
• Width	mm	50	50	70
• Height x depth	mm	125 x 126.5		
• Weight	kg	0.4	0.4	0.7

Selection and ordering data

Version	SD	Screw terminals	PU (UNIT, SET, M)	PS*	PG
	d	Article No.	Price per PU		
<p>PSN130S 30 V DC power supply unit (without AS-i data decoupling)</p> <ul style="list-style-type: none"> • Output voltage 30 V DC • Dimensions: Width: 50 mm (3 A/4 A); 70 mm (8 A); Height: 125 mm; Depth: 126.5 mm 					
3RX9511-0AA00		3 A	120/230 V AC (automatic selection)	▶ 3RX9511-0AA00	1 1 unit 42C
3RX9512-0AA00		4 A	120/230 V AC (automatic selection)	▶ 3RX9512-0AA00	1 1 unit 42C
3RX9513-0AA00		8 A	120/230 V AC (automatic selection)	▶ 3RX9513-0AA00	1 1 unit 42C

More information

More information

For operating instructions and other technical information, see <https://support.industry.siemens.com/cs/ww/en/view/64364000>

AS-Interface

Power Supply Units and Data Decoupling Modules

S22.5 data decoupling modules

Overview



AS-Interface S22.5 double data decoupling module:
Screw terminal version (picture left),
Spring-type terminal version (picture right)

With the aid of the S22.5 data decoupling module, the AS-Interface network can also be supplied with 24 V DC or 30 V DC from a standard power supply unit and the transmission of data and power can be realized along one cable.

The combination of data decoupling modules and standard power supply units is therefore a cost-efficient alternative to the service-proven AS-Interface power supply units.

The quality of the data signals and the reliable operation of the AS-i network are not negatively affected as the result.

Features of the S22.5 data decoupling unit

- Degree of protection IP20
- Narrow design: 22.5 mm wide
- Version with screw or spring-type terminals
- Versions for single and double data decoupling
- Supply of several AS-i networks with a single power supply unit
- Operation with 24 V DC or 30 V DC, grounded or non-grounded
- Adjustable current limiting up to 2 x 4 A
- Integrated ground-fault detection with fault storage
- Diagnostics LEDs and signaling contacts
- RESET by button or remote RESET

Ground-fault detection

The integrated ground-fault detection works with a grounded and non-grounded supply: The connection of negative pole and ground (upstream from the data decoupling module) customary with 24 V DC power supplies is permitted. A ground fault to the negative or positive pole on the AS-Interface network (downstream from the data decoupling module) is detected and stored as a fault and will be signaled using LEDs and a relay contact.

Benefits

- Compatible expansion of the AS-Interface system
- An existing standard power supply unit with 24 V DC or 30 V DC can be used for supplying AS-i networks
- The AS-Interface system can also be used in tightly budgeted applications because no AS-Interface power supply unit needs to be purchased
- Applications benefit in addition from the advantages of a modern bus system:
 - High level of standardization
 - Additional diagnostics and maintenance information
 - Faster commissioning
- Easy and cost-efficient design of single and multiple networks is possible

Application

The AS-Interface data decoupling module is designed for AS-Interface networks with 30 V or 24 V supply (AS-i Power24V).

Operation of an AS-i network with the data decoupling module and a 30 V standard power supply unit is technically equivalent to the use of an AS-Interface power supply unit and offers the service-proven features of AS-Interface for all applications.

AS-Interface Power24V uses a 24 V power supply unit in conjunction with a data decoupling module and is particularly suitable for:

- Compact machines using AS-Interface input/output modules
- Applications in the control cabinet for AS-Interface integration of SIRIUS 3RT2 contactors using 3RA27 function modules

When using the double data decoupling module or other data decoupling units, several AS-Interface networks can be operated with a single power supply unit. This results in an additional cost advantage.

Note:

The power supply units must comply with the PELV (Protective Extra Low Voltage) or SELV (Safety Extra Low Voltage) standards, have a residual ripple of < 250 mV_{pp}, and in the event of a fault must limit the output voltage to a maximum of 40 V. We recommend SITOP power supplies (see page 15/1 onwards) or PSN130S 30 V power supplies (see page 2/80).

Note on AS-i Power24V:

The length of an AS-i Power24V network is restricted to 50 m in order to limit the voltage drop along the cable.

AS-i masters, AS-i slaves and the sensors and actuators supplied through the AS-i cable must be designed for the reduced voltage. Sensors and actuators for the standard voltage range of 10 to 30 V can be supplied with sufficient voltage.

Please also observe the requirements specified in "Extension of AS-i Power24V" for implementation of AS-i Power24V, see page 2/21.



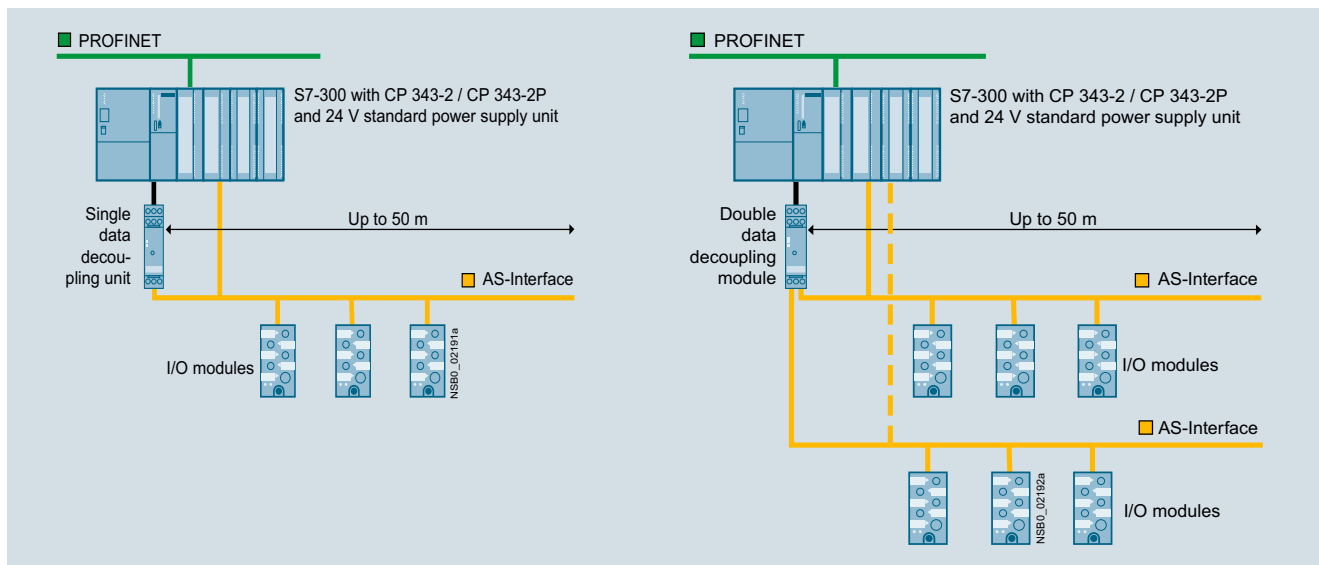

For more information on AS-i Power24V, see System Manual "AS-Interface", <https://support.industry.siemens.com/cs/ww/en/view/26250840>.

Construction of an AS-i Power24V network with an AS-Interface S22.5 data decoupling module



Left: single network, right: Multiple network

Selection and ordering data

Version	SD	Article No.	Price per PU	PU (UNIT, SET, M)	PS*	PG
S22.5 data decoupling modules						
With screw terminals, removable terminals, width 22.5 mm, height 101 mm, depth 115 mm		Screw terminals 				
 3RK1901-1DE12-1AA0	▶	3RK1901-1DE12-1AA0		1	1 unit	42C
	▶	3RK1901-1DE22-1AA0		1	1 unit	42C
S22.5 data decoupling modules						
With spring-type terminals, removable terminals, width 22.5 mm, height 105 mm, depth 115 mm		Spring-type terminals 				
 3RK1901-1DG12-1AA0	▶	3RK1901-1DG12-1AA0		1	1 unit	42C
	▶	3RK1901-1DG22-1AA0		1	1 unit	42C

AS-Interface

Power Supply Units and Data Decoupling Modules Data Decoupling Modules for S7-1200

DCM 1271 data decoupling module

Overview



DCM 1271 data decoupling module for SIMATIC S7-1200

With the aid of the DCM 1271 data decoupling module, the AS-Interface network can also be supplied with 24 V DC or 30 V DC from a standard power supply unit and the transmission of data and power can be realized along one cable.

The DCM 1271 data decoupling module has the same enclosure design as the S7-1200 module and is therefore ideal for combining with the CM 1243-2 AS-i master.

The DCM 1271 data decoupling module has no connection to the backplane bus of the SIMATIC S7-1200 and is not counted as a communication module when calculating the maximum configuration.

Features of the DCM 1271 data decoupling module

- Design: S7-1200, 30 mm wide, degree of protection IP20
- Detachable terminals (scope of supply)
- Single data decoupling
- Supply of several AS-i networks with a single power supply unit
- Operation with 24 V DC or 30 V DC, grounded or non-grounded
- Current limiting at 4 A
- Integrated ground-fault detection
- Diagnostics LEDs for ground faults and overloads
- Signaling contacts for ground-fault detection

Ground-fault detection

The integrated ground-fault detection works with a grounded and non-grounded supply: The connection of negative pole and ground (upstream from the data decoupling module) customary with 24 V DC power supplies is permitted. A ground fault to the negative or positive pole on the AS-Interface network (behind the data decoupling module) is identified and signaled via LED and a transistor output.

Benefits

- An existing standard power supply unit with 24 V DC or 30 V DC can be used for supplying AS-i networks
- The AS-Interface system can also be used in tightly budgeted applications because no AS-Interface power supply unit needs to be purchased
- Applications in addition from the advantages of a modern bus system:
 - High level of standardization
 - Additional diagnostics and maintenance information
 - Faster commissioning

Application

The AS-Interface data decoupling module is designed for AS-Interface networks with 30 V or 24 V supply (AS-i Power24V).

Operation of an AS-i network with the data decoupling module and a 30 V standard power supply unit is technically equivalent to the use of an AS-Interface power supply unit and offers the service-proven features of AS-Interface for all applications.

AS-i Power24V uses a 24 V power supply unit in conjunction with a data decoupling module and is particularly suitable for

- Compact machines using AS-Interface input/output modules
- Applications in the control cabinet for AS-Interface integration of SIRIUS 3RT2 contactors using 3RA27 function modules

Note:

The power supply units must comply with the PELV (Protective Extra Low Voltage) or SELV (Safety Extra Low Voltage) standards, have a residual ripple of $< 250 \text{ mV}_{\text{pp}}$, and in the event of a fault must limit the output voltage to a maximum of 40 V. We recommend SITOP power supplies (see page 15/1 onwards) or PSN130S 30 V power supplies (see page 2/80).

Note on AS-i Power24V:

The length of an AS-i Power24V network is restricted to 50 m in order to limit the voltage drop along the cable.

AS-i masters, AS-i slaves and the sensors and actuators supplied through the AS-i cable must be designed for the reduced voltage. Sensors and actuators for the standard voltage range of 10 to 30 V can be supplied with sufficient voltage.

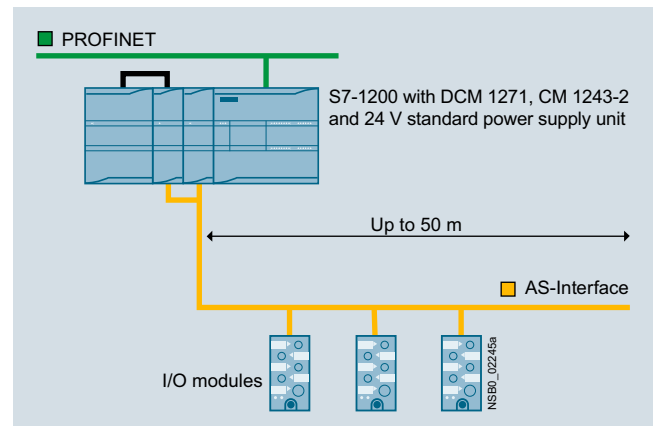

Please also observe the requirements specified in "Extension of AS-i Power24V" for implementation of AS-i Power24V, see page 2/21.

For more information on AS-i Power24V, see System Manual "AS-Interface", <https://support.industry.siemens.com/cs/ww/en/view/26250840>.





Configuration of an AS-i Power24V network with DCM 1271 AS-Interface data decoupling unit

Selection and ordering data

Version	SD	Screw terminals 	PU (UNIT, SET, M)	PS*	PG
	d	Article No.	Price per PU		
 3RK7271-1AA30-0AA0		DCM 1271 data decoupling module			
	2	3RK7271-1AA30-0AA0	1	1 unit	42C
<ul style="list-style-type: none"> • With screw terminals, removable terminals (included in the scope of supply) • Dimensions (W × H × D/mm): 30 × 100 × 75 					

Accessories

Version	SD	Screw terminals 	PU (UNIT, SET, M)	PS*	PG
	d	Article No.	Price per PU		
 3RK7243-2AA30-0XB0		Screw terminals (replacement)			
	5	3RK1901-3MA00	1	1 unit	42C
	5	3RK1901-3MB00	1	1 unit	42C
	2	CM 1243-2 communication module	1	1 unit	42C
<ul style="list-style-type: none"> • AS-Interface masters for SIMATIC S7-1200 • Corresponds to AS-Interface Specification V3.0 • With screw terminals, removable terminals (included in the scope of supply) • Dimensions (W × H × D/mm): 30 × 100 × 75 <p>see also from page 2/32 onwards</p>					

More information

More information

More information on AS-i Power24V, see System Manual "AS-Interface", <https://support.industry.siemens.com/cs/ww/en/view/26250840>

Manual "AS-i Master CM 1234-2 and AS-i Data Decoupling Unit DCM 1271 for SIMATIC S7-1200", see <https://support.industry.siemens.com/cs/ww/en/view/57358958>

AS-Interface

Transmission Media

AS-Interface shaped cable

Overview

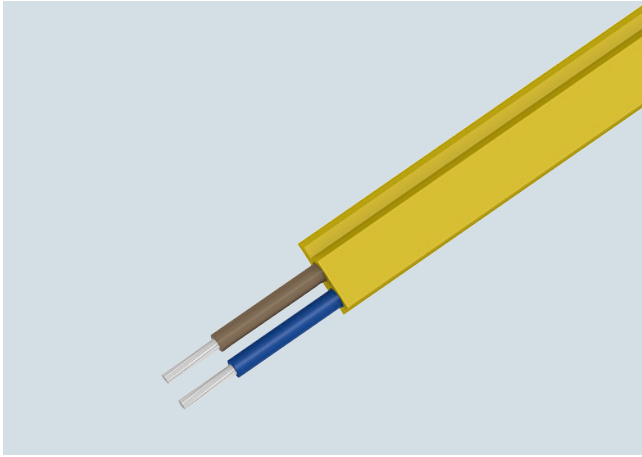

AS-Interface shaped cable

The actuator-sensor interface – the networking system used for the lowest field area – is characterized by very easy mounting and installation. A new connection method was developed specially for AS-Interface.

The stations are connected using the AS-Interface cable. This two-wire AS-Interface shaped cable has a trapezoidal shape, thus ruling out polarity reversal.

Connection is effected by the insulation piercing method. In other words, male contacts pierce the shaped AS-Interface cable and make reliable contact with the two wires. Cutting to length and stripping are superfluous. Consequently, AS-Interface stations (e.g. I/O modules, intelligent devices) can be connected in the shortest possible time and exchanging devices is quick.

To enable use in the most varied ambient conditions (e.g. in an oily environment), the AS-Interface cable is available in different materials (rubber, TPE, PUR).

For special applications it is also possible to use an unshielded standard round cable H05VV-F 2 x 1.5 mm² according to AS-i Specification. With AS-Interface, data and energy for the sensors (e.g. proximity switches) and actuators (e.g. indicator lights) are transmitted over the yellow AS-Interface cable.

The black AS-Interface cable must be used for actuators with a 24 V DC supply (e.g. solenoid valves) and a high power requirement.

Suitable for operation in tow chains

The use of the AS-Interface shaped cables with TPE and PUR outer sheath was checked in a tow chain test with the following conditions:

Chain length	m	6
Travel	m	10
Bending radius	mm	75
Travel speed	m/s	4
Acceleration	m/s ²	4
Number of cycles		10 million
Duration of test		approx. 3 years (11 000 cycles per day)

After termination of the 10 million cycles only slight wear was visible due to the lugs of the tow chain. No damage to the cores and core insulation could be detected.

Note:

When using a tow chain, the cables must be installed in such a way that they are not subject to tensile forces. On no account may the cables be twisted, but they must be routed flat through the tow chain.

Selection and ordering data

Version	SD	Article No.	Price per PU	PU (UNIT, SET, M)	PS*	PG
	d					

AS-Interface shaped cables

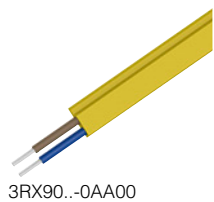

3RX90...-0AA00

Material	Color	Quantity	SD	Article No.	Price per PU	PU (UNIT, SET, M)	PS*	PG
Rubber	Yellow (AS-Interface)	100 m roll	2	3RX9010-0AA00		1	1 unit	42C
	Yellow (AS-Interface)	1 km drum	5	3RX9012-0AA00		1	1 unit	42C
	Black (24 V DC)	100 m roll	2	3RX9020-0AA00		1	1 unit	42C
	Black (24 V DC)	1 km drum	5	3RX9022-0AA00		1	1 unit	42C
TPE	Yellow (AS-Interface)	100 m roll	2	3RX9013-0AA00		1	1 unit	42C
	Yellow (AS-Interface)	1 km drum	5	3RX9014-0AA00		1	1 unit	42C
	Black (24 V DC)	100 m roll	2	3RX9023-0AA00		1	1 unit	42C
	Black (24 V DC)	1 km drum	5	3RX9024-0AA00		1	1 unit	42C
TPE special version according to UL Class 2	Yellow (AS-Interface)	100 m roll	5	3RX9017-0AA00		1	1 unit	42C
	Black (24 V DC)	100 m roll	5	3RX9027-0AA00		1	1 unit	42C
PUR	Yellow (AS-Interface)	100 m roll	2	3RX9015-0AA00		1	1 unit	42C
	Yellow (AS-Interface)	1 km drum	5	3RX9016-0AA00		1	1 unit	42C
	Black (24 V DC)	100 m roll	2	3RX9025-0AA00		1	1 unit	42C
	Black (24 V DC)	1 km drum	5	3RX9026-0AA00		1	1 unit	42C

Overview



AS-Interface repeater

The AS-Interface repeater is used to extend the AS-Interface cable.

- In its basic version, an AS-i network comprises one segment with a maximum cable length of 100 m. An extension plug (see page 2/88) can be used to increase the cable length for a segment to a maximum of 200 m
- If this is insufficient, however, you can use one or more repeaters
- A repeater adds an extra segment to an existing segment. The extra segment can have a cable length of up to 100 m (without extension plug) or up to 200 m (with an extension plug in the extra segment)
- Each segment requires a separate AS-i power supply unit
- Electrical separation of the two AS-Interface shaped cable lines
- Slaves can be used on both sides of the repeater
- The additional power supply can increase the current infeed for slaves/sensors and lower the voltage drop on the AS-i cable
- Separate display of the correct AS-Interface voltage for each segment
- Installed in K45 module enclosure IP67 with mounting plate
- Easy mounting

Benefits

- More possibilities of use and greater freedom for plant planning through extension of the AS-Interface network
- Reduced downtime and servicing times in the event of a fault thanks to separate display of the correct AS-Interface voltage for each side

Design of an AS-Interface network with repeaters

- Parallel switching of several repeaters possible (star configuration)
- Combination of series and parallel switching possible

The following conditions apply:

- When used without an extension plug no more than two repeaters are permitted between AS-i master and slave (repeaters connected in series)
- When used with an extension plug no more than one repeater is permitted between AS-i master and slave

In safety-related applications the following also applies:

- When used without an extension plug, no more than two repeaters are permitted between evaluation unit (e.g. MSS ASIsafe Modular Safety System, F-CM AS-i Safety ST for ET 200SP) and ASIsafe input slave or safe output module.
- When used with an extension plug, no more than one repeater is permitted between the evaluation unit (e.g. MSS ASIsafe Modular Safety System, F-CM AS-i Safety ST for ET 200SP) and ASIsafe input slave or safe output module.

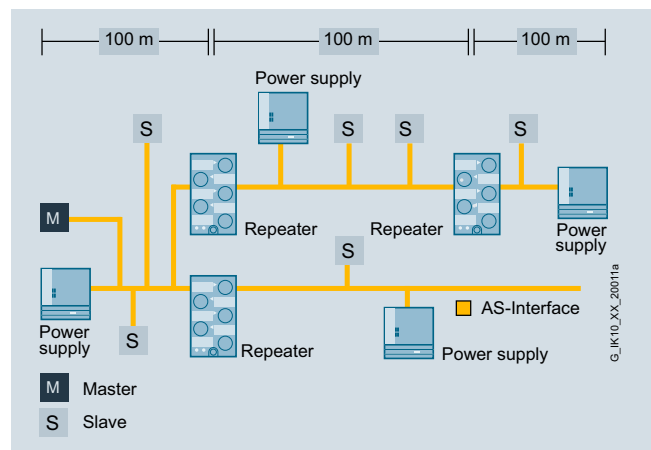

Design of an example AS-Interface network with repeaters (without extension plug)

Note:

The AS-Interface repeater is not suitable for AS-i Power24V networks. It is recommended for use in AS-Interface networks with AS-Interface power supply units (e.g. 3RX9501-0BA00).

Application

The repeater is used to extend the AS-Interface network. In this case there are AS-Interface slave and one AS-Interface power supply unit on each side of the repeater.

In the case of a line topology with two repeaters and three extension plugs, the maximum possible size of the AS-Interface network is 600 m, see example configuration with extension plug on page 2/88.

Selection and ordering data

Version	SD	Article No.	Price per PU	PU (UNIT, SET, M)	PS*	PG
	d					
	Repeaters for AS-Interface	6GK1210-0SA01		1	1 unit	42C
6GK1210-0SA01	For cable extension, scope of supply includes mounting plate (for wall and standard rail mounting)					

AS-Interface System Components and Accessories

Extension plugs

Overview



AS-Interface extension plugs compact

With the extension plug it is possible to double the cable length possible in an AS-Interface segment from 100 to 200 m.

Only one power supply unit is needed to supply power to the slaves on the up to 200 m long segment.

The extension plug compact can be installed directly onto an AS-i shaped cable. A separate M12 feeder, as was required for earlier extension plug versions, is no longer required with extension plug compact.

Design of an AS-Interface segment with an extension plug

To construct an AS-Interface segment with a cable length of more than 100 m and up to a maximum of 200 m, the extension plug is installed in a radius of around ± 10 m at the point of the network that is furthest from the power supply unit. The extension plug is not allowed to be used in AS-Interface networks smaller than 100 m. As with all AS-Interface networks, any network structure (line, tree, star) is possible when using the extension plug. Only one extension plug is required per 200 m segment even with a tree or star structure.

Note:

The AS-i bus cable must not terminate in the extension plug compact. The AS-Interface shaped cable can be terminated by means of a cable terminating piece to provide degree of protection IP67 where required, see "Miscellaneous accessories" on page 2/96.

The AS-Interface extension plug is not suitable for AS-i Power24V networks.

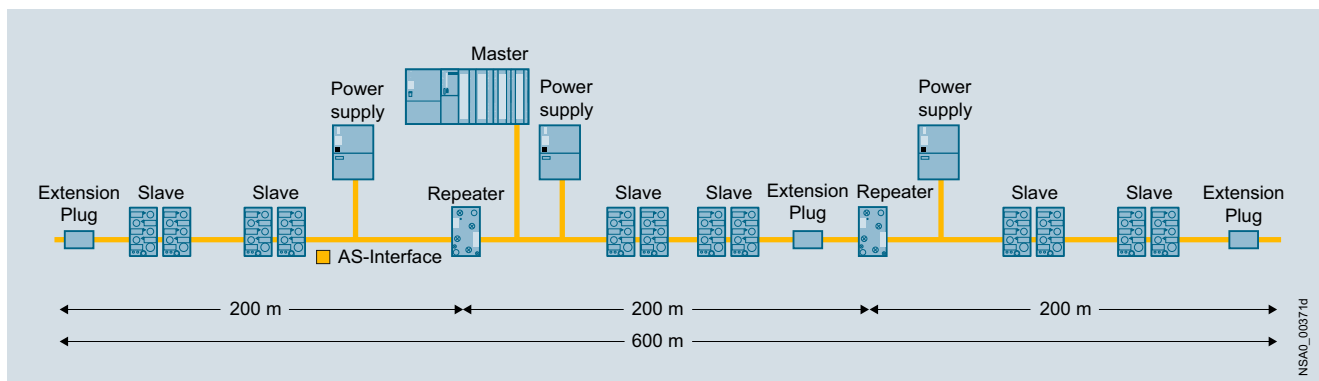

Maximum network size with repeaters and extension plug (master at center of network)

Selection and ordering data

Version	SD	Article No.	Price per PU	PU (UNIT, SET, M)	PS*	PG
d						
	2	3RK1901-1MX02		1	1 unit	42C
AS-Interface Extension Plug Compact <ul style="list-style-type: none"> • Doubling of the cable length to 200 m per AS-Interface segment • With direct connection to AS-Interface shaped cable 						

3RK1901-1MX02

Accessories

Version	SD	Article No.	Price per PU	PU (UNIT, SET, M)	PS*	PG
d						
	▶	3RK1901-1MN00		1	10 units	42C
Cable terminating piece For sealing of open cable ends (shaped AS-Interface cable) in IP67						

3RK1901-1MN00

Overview



The innovated addressing unit for AS-Interface of the AS-i Specification V3.0

The addressing unit is used to assign an address during commissioning to each AS-Interface slave. The device detects a connected slave module or a complete AS-i network and displays the found module in the LCD display. Each address can be individually set using the Up/Down keys. By turning the rotary switch, further commissioning functions are selected intuitively. The innovative device has been adapted to the current AS-i Specification V3.0 and can now also handle the I/O data of the latest slaves.

Functionality

- Reading out and adjusting the slave address 0 to 31 or 1A to 31A, 1B to 31B, with automatic addressing aid and prevention of double addresses
- Reading out the slave profile (IO, ID, ID2)
- Reading out and adjusting the ID1 code
- Input/output test when commissioning the slaves: Read input signals and write outputs with all digital and analog slaves according to AS-Interface Specification V3.0, including safe input slaves and complex CTT2 slaves
- Measuring the voltage on the AS-Interface cable (measuring range from 2 to 35 V)
- Display of the operational current in case of direct connection of an AS-i slave (measuring range from 0 to 150 mA)
- Storage of complete network configurations (profiles of all slaves) to simplify the addressing
- Adjusting the slave parameters for commissioning
- Reading out the identification and diagnostics of CTT2 slaves
- Reading out the code table of safe input slaves (ASISafe)

Note:

For operation of the addressing unit on an AS-Interface cable with connected power supply unit, the following applies: The AS-Interface addressing unit is suitable for standard AS-i networks and AS-i Power24V networks (min. operational voltage on the AS-Interface cable 19 V).

Benefits

- Increased power supply to the slaves to 150 mA
- Better utilization of the battery capacity thanks to improved circuitry
- Support for the current AS-i Specification V3.0
- Expanded display for simultaneously displaying input and output states
- Clearly recognizable display of status of digital inputs/outputs in binary format (0/1), optionally also available as hexadecimal values
- Intuitive display of analog data either as decimal, hexadecimal or as a percentage (e.g. 100% corresponds to input/output value 20 mA)
- I/O data of complex slaves (CTT2 profile) can be displayed
- Decoded display of the input data of safe input slaves, including code table
- Simplification of the operating steps when setting the slave address with automatic read back of the set address
- Addressing cable, ready for operation even without screwing in tight into the M12 socket, thus faster availability of the addressing unit
- Proven compact housing with smooth keys and rotary switch
- Connection of standard AS-i networks possible with 30 V as well as Power24V networks
- Complex slaves with high operating currents can be addressed without external supply
- Longer operating time by automatic shutdown after approx. 5 minutes (or approx. 1 minute when data exchange is active) after last operation
- Can be used with all types of digital and analog slaves
- Comprehensive and fast input/output test of plants, even for A/B modules with 4DI/4DQ and current analog modules with an A/B address
- Faster and more reliable commissioning of the AS-Interface modules
- One-hand operation possible, with unique selection of the functions
- Connection via M12 socket (pin 1: ASI+; Pin 3: ASI-; pins 2, 4, 5: not used)
- Universal applicability for all AS-i networks

Selection and ordering data





Version	SD	Article No.	Price per PU	PU (UNIT, SET, M)	PS*	PG
d						
 <p>AS-Interface addressing unit V3.0</p> <ul style="list-style-type: none"> • For AS-Interface modules and sensors and actuators with integrated AS-Interface according to AS-i Specification V3.0 • For setting the AS-i address of standard slaves, and slaves with extended addressing mode (A/B slaves) • With input/output test function and many other commissioning functions • Battery operation with four type AA batteries (IEC LR6, NEDA 15) • Degree of protection IP40 • Dimensions (W x H x D) mm: 84 x 195 x 35 • Scope of supply: <ul style="list-style-type: none"> - Addressing unit with 4 batteries - Addressing cable, with M12 plug to addressing plug (hollow plug), length 1.5 m 	2	3RK1904-2AB02		1	1 unit	42C

AS-Interface

System Components and Accessories

Addressing units

Accessories

Version	SD	Article No.	Price per PU	PU (UNIT, SET, M)	PS*	PG
 3RK1902-4PB15-3AA0	d	3RK1902-4PB15-3AA0		1	1 unit	42D
Addressing cable, with M12 plug to M12 socket¹⁾ <ul style="list-style-type: none"> For addressing slaves with M12 connection, e.g. K20 or K60R modules or light curtains Length 1.5 m, 3-pole, 3 x 0.34 mm² 						
 3RX9801-0AA00	▶	3RX9801-0AA00		1	1 unit	42C
AS-Interface M12 3RX feeder <ul style="list-style-type: none"> Transition of AS-Interface cable to a standard round cable Insulation piercing method for connection of AS-Interface cable M12 socket for connection of standard round cable Current carrying capacity up to 2 A 						
 3RK1901-1NR10	2	3RK1901-1NR10		1	1 unit	42C
AS-Interface M12 3RK feeder <ul style="list-style-type: none"> AS-Interface cable transition without U_{aux}, with M12 socket Insulation piercing method for connection of AS-Interface cable M12 socket for connection of standard round cable 						
 3RK1902-4HB50-5AA0	10	3RK1902-4HB50-5AA0		1	1 unit	42D
M12 cable plug²⁾ <ul style="list-style-type: none"> Extruded M12 plug (angled cable feeder 90°), other cable end open Length: 5 m, 5-pole, color: Black 						
 3RK1902-4BA00-5AA0	10	3RK1902-4BA00-5AA0		1	1 unit	42D
M12 plug straight²⁾ <ul style="list-style-type: none"> For screw fixing, 5-pole screw terminal, max. 0.75 mm² A-coded, max. 4 A 						
		Z236A				
Addressing cable, with M12 plug to addressing plug (hollow plug)³⁾ <ul style="list-style-type: none"> Included in the scope of supply of the addressing unit Length 1.5 m 						

¹⁾ Not included in scope of supply of the 3RK1904-2AB02 addressing unit.

²⁾ For connecting the addressing unit to an AS-i network via AS-Interface M12 feeder, a connecting cable (M12 plug to M12 connector) must be produced and requires the following wiring:
 - M12 cable plug: Pin 1/core brown ↔ M12 plug: Pin 1
 - M12 cable plug: Pin 3/core blue ↔ M12 plug: Pin 3
 - Pin 2, 4, 5 not connected.

³⁾ Can only be ordered from GMC-I Messtechnik GmbH, see "External partners", page 16/15.

Overview



AS-Interface analyzer

The AS-Interface analyzer is used to test AS-Interface networks. Installation errors, e.g. loose contacts or EMC interference under extreme loads, can be revealed by this device.

Thanks to the easy-to-use software the user can assess the quality of complete networks even if he lacks detailed specialist knowledge of AS-Interface. In addition it is an easy matter with the AS-Interface analyzer to create test logs from the records produced, thus providing documentation for start-ups and service assignments.

For advanced AS-Interface users there are trigger functions for detailed diagnostics.

Connection

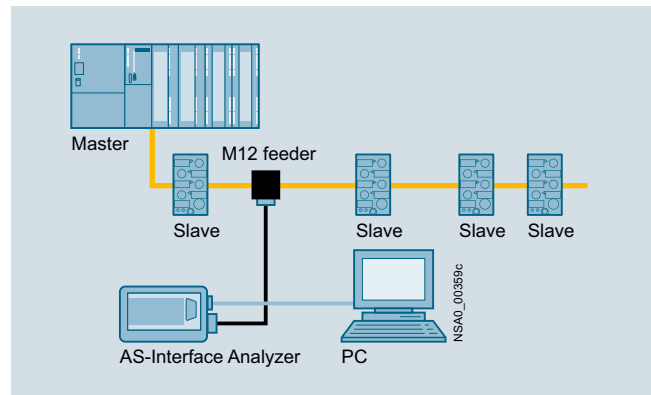

Connection of AS-Interface analyzer to PC and AS-Interface network

The AS-Interface analyzer follows the communication on the AS-Interface network as a passive station. The unit is supplied simultaneously from the AS-Interface cable.

This analyzer interprets the physical signals on the AS-Interface network and records the communication.

The data thus obtained is transferred through an RS 232 interface to a PC such as a notebook, for evaluation with the supplied diagnostics software.

Benefits

- Simple and user-friendly operation enables diagnostics of AS-Interface networks without help from specialists
- Speedy troubleshooting thanks to intuitive display in statistics mode
- Test logs provide verification of the state and quality of the installation for service and approval
- Recorded logs facilitate remote diagnostics by technical assistance
- Comprehensive trigger functions enable exact analysis
- Process data can be monitored online

AS-Interface

System Components and Accessories

Analyzer

Application

Online statistics

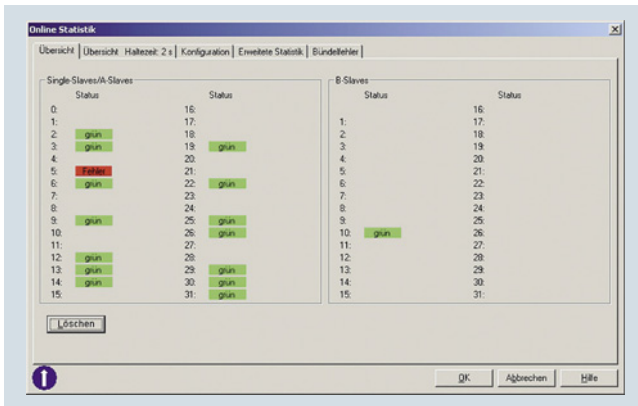

Online statistics, overview

Data mode

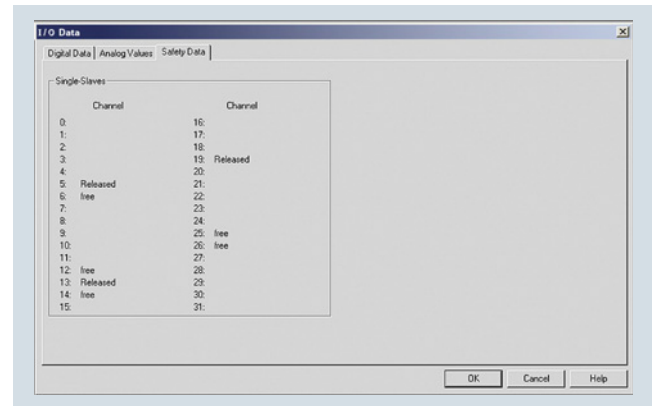

Presentation of the I/O data: Safety data

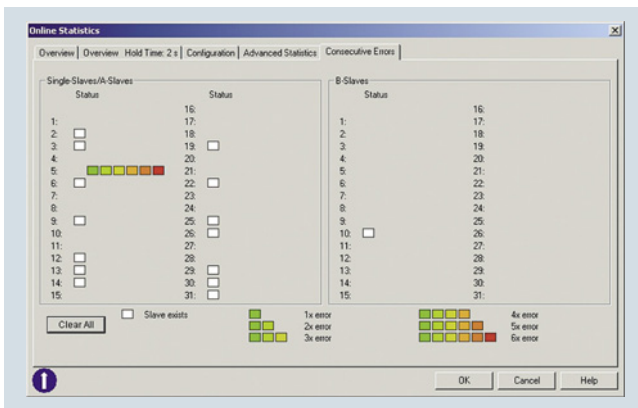

Online statistics, details, e.g. here a fault on slave 5

This mode provides a quick overview of the existing AS-Interface system. The error rates are displayed per slave in a traffic-light function (green, yellow, red).

The bus configuration and the currently transmitted data of the slaves are shown in a well arranged presentation.

With the expanded statistics function, it is possible to determine the error rates as the number of transmitted or faulty bus message frames.

The bundle error overview shows in steps how many multiple repetitions of message frames occurred in order to enable a selective and look-ahead assessment of the transmission quality.

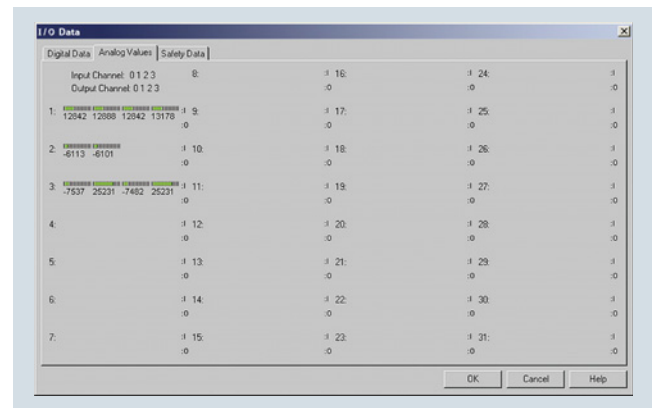

Presentation of the I/O data: Analog values

In this mode, the analyzer shows not only the digital input/output values but also the current analog values and the input status of the safety slaves.

Trace mode

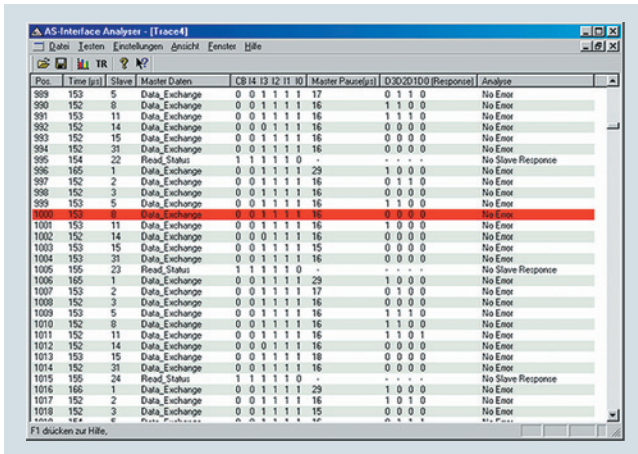

Presentation of message frames in trace mode

The presentation of message frames in the style of a classic fieldbus analyzer is indispensable for complex troubleshooting. Extensive trigger functions and recording and viewing filters are available for this purpose. An external trigger input and trigger output round off the scope of functions in order to find even the most difficult errors.

For troubleshooting in connection with ASIsafe applications, changes of status in the code tables of safety slaves are identified and assessed.

The AS-i analyzer can be used with an AS-i master in accordance with AS-Interface specification V3.0 or a predecessor version.

The analyzer does not automatically decode the process values for type CTT2 - CTT5 AS-i slaves. As for other slave types, the message frames are recorded and evaluated in the statistics. If required, decoding can also be performed by the user manually.

Further information, see <https://support.industry.siemens.com/cs/ww/en/view/109746763>.

Test log



Example of a test log

The recorded data of the online statistics are easy to output and document using a test log. Verification of the state of the plant can thus be provided for approvals or service assignments.

The integrated measurement assistant records the bus signals for a variable duration, thereby triggering creation of an automatic test log. A standardized quality test of AS-i plants is thus possible.

Note:

The AS-Interface analyzer is suitable for standard AS-i networks and AS-i Power24V networks (min. operating voltage 20 V).

Selection and ordering data

Version	SD	Article No.	Price per PU	PU (UNIT, SET, M)	PS*	PG
d						



3RK1904-3AB01

AS-Interface analyzer



- For testing AS-Interface systems
- For troubleshooting and service assignments in installations and networks with AS-Interface systems
- Dimensions (W x H x D): 145 x 30 x 92 mm
- Scope of supply:
 - AS-Interface analyzer
 - RS 232 cable for connecting to a PC
 - USB-to-serial/RS 232 adapter
 - Screwdriver
 - Magnetic adhesive tape for fastening the analyzer to metal surfaces
 - Service case with foam insert, dimensions (W x H x D/mm): approx. 260 x 70 x 200
 - Diagnostic software (CD-ROM) for PC: Windows 7 Professional/Ultimate, Windows 8/8.1, Windows 10 (from software V1.3.7.0 onwards)

2 3RK1904-3AB01 1 1 unit 42C

AS-Interface System Components and Accessories









Analyzer







Accessories

Version	SD	Article No.	Price per PU	PU (UNIT, SET, M)	PS*	PG
 3RX9801-0AA00	d	3RX9801-0AA00		1	1 unit	42C
AS-Interface M12 3RX feeder <ul style="list-style-type: none"> • Transition of shaped AS-Interface cable to a standard round cable • Insulation piercing method for connection of AS-Interface cable • M12 socket for connection of standard round cable • Current carrying capacity up to 2 A • Degree of protection IP67 						
 3RK1901-1NR10	2	3RK1901-1NR10		1	1 unit	42C
AS-Interface M12 3RK feeder <ul style="list-style-type: none"> • AS-Interface cable transition without U_{aux}, with M12 socket • Insulation piercing method for connection of AS-Interface cable • M12 socket for connection of standard round cable • Max. 4 A • Degree of protection IP67/IP68/IP69K 						
 3RK1902-4HB50-5AA0	10	3RK1902-4HB50-5AA0		1	1 unit	42D
M12 cable plugs <ul style="list-style-type: none"> • PUR cable, 5-pole • Length 5 m • Color black • Extruded M12 plug (angled cable feeder 90°), other cable end open 						

AS-Interface System Components and Accessories

Miscellaneous accessories

Version	SD	Article No.	Price per PU	PU (UNIT, SET, M)	PS*	PG
AS-Interface sealing caps						
For free M12 sockets						
						
3RK1901-1KA00						
						
3RK1901-1KA01						
						
3RK1901-1PN00						
						
3RK1901-1MD00						
AS-Interface M20 seals						
	2	3RK1901-1MD00		100	10 units	42C
• For AS-Interface cable, shaped						
• For insertion in M20 glands						
Cable adapters for flat cables						
Connection of AS-Interface cable to metric gland with insulation piercing method						
• Continuation using standard cable						
	5	3RK1901-3QM00		1	1 unit	42C
3RK1901-3QM00						
	5	3RK1901-3QM10		1	1 unit	42C
• Continuation using pins						
	10	3RK1901-3QM01		1	1 unit	42C
	5	3RK1901-3QM11		1	1 unit	42C
Cable clips for cable adapters						
	5	3RK1901-3QA00		100	10 units	42C
3RK1901-3QA00						
Cable terminating piece						
						
3RK1901-1MN00						
		3RK1901-1MN00		1	10 units	42C
For sealing of open cable ends (shaped AS-Interface cable) in IP67						
Mounting plates						
• K45						
		3RK1901-2EA00		1	1 unit	42C
						
3RK1901-2EA00						
		3RK1901-2DA00		1	1 unit	42C
• K60, suitable for all K60 compact modules						
		3RK1901-0CA00		1	1 unit	42C
						
3RK1901-0CA00						
		3RK1901-0CB01		1	1 unit	42C

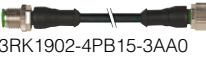
Version	SD	Article No.	Price per PU	PU (UNIT, SET, M)	PS*	PG
 3RK1902-0AR00	2	3RK1902-0AR00		100	5 units	42D
Sealing sets						
<ul style="list-style-type: none"> For K60 mounting plate and standard distributor Cannot be used for K45 mounting plate One set contains one straight and one shaped seal 						
	15	3RT1900-1SB50		100	380 units	41B
Inscription labels						
<ul style="list-style-type: none"> For K45 and K60 compact modules 20 x 9 mm, pastel turquoise 19 frames with 20 labels each 						
 3RK1902-4GB50-4AA0	10	3RK1902-4GB50-4AA0		1	1 unit	42D
Control cable, assembled at one end						
Angular M12 socket for screw fixing, 4-pole, 4 x 0.34 mm ² , A-coded, black PUR sheath, max. 4 A						
<ul style="list-style-type: none"> Cable length 5 m 						
 3RK1902-4CA00-4AA0	10	3RK1902-4CA00-4AA0		1	1 unit	42D
M12 socket, angled						
For screw mounting, 4-pole screw terminals, max. 0.75 mm ² , A-coded, max. 4 A						
 3RK1902-4BA00-5AA0	10	3RK1902-4BA00-5AA0		1	1 unit	42D
M12 connector						
For screw mounting, 5-pin screw terminals, max. 0.75 mm ² , A-coded, max. 4 A						
<ul style="list-style-type: none"> Straight 						
 3RK1902-4DA00-5AA0	10	3RK1902-4DA00-5AA0		1	1 unit	42D
<ul style="list-style-type: none"> Angled 						
 3RK1902-4H...-5AA0	10	3RK1902-4HB15-5AA0		1	1 unit	42D
Control cable, assembled at one end						
Angular M12 socket for screw fixing, 5-pole, 5 x 0.34 mm ² , A-coded, black PUR sheath, max. 4 A						
<ul style="list-style-type: none"> Cable length 1.5 m 						
<ul style="list-style-type: none"> Cable length 5 m 						
<ul style="list-style-type: none"> Cable length 10 m 						
 3RK1902-4PB15-3AA0	10	3RK1902-4PB15-3AA0		1	1 unit	42D
Control cable, assembled at both ends						
Straight M12 plug, straight M12 socket, for screw fixing, 3-pole, 3 x 0.34 mm ² , A-coded, black PUR sheath, max. 4 A						
<ul style="list-style-type: none"> Cable length 1.5 m 						
<ul style="list-style-type: none"> Also for addressing AS-i slaves with M12 bus connection (e.g. K20, K60R compact modules, M200D motor starters) 						

More information

More information

System Manual "AS-Interface"

- German
<https://support.industry.siemens.com/cs/de/de/view/26250840>
- English
<https://support.industry.siemens.com/cs/ww/en/view/26250840>