

Automatic Star-Delta Starter Extended Range (75kw-132kw)

Order No.: A5E45312503A

Operating Instructions

Please read and understand these instructions before installing, operating, or maintaining the equipment.



Rating	MLFB
75kW	3TE7594-2AR0
90kW	3TE7595-2AR0
110kW	3TE7596-2AR0
132kW	3TE7597-2AR0

	Danger Hazardous voltage can cause death or serious injury. Disconnect power before working on equipment.
	Warning Automatic Motor Restart. Can cause death, serious injury or property damage. Do not use automatic reset mode when unexpected automatic restart of the motor can cause injury to persons or damage to equipment. Reliable functioning of the equipment is only ensured with certified components. Commissioning and maintenance by qualified personnel only.

NOTICE

This product has been designed for environment A. Use of this product in environment B may cause unwanted electromagnetic disturbances in which case the user may be required to take adequate mitigation measures.

Technical Data

Enclosed Automatic Star delta Starter which is the combination of 3TS Contactors, 3US relay and 3RP Timer with no derating upto +55°C, provides overload, single phasing protection for three phase motors and IP54 for Enclosure.

1. Operating Voltage
415V ac

2. Rated Insulation Voltage
Main circuit : 690V
Auxiliary circuit : 690V

3. Rated Impulse Voltage
Main circuit : 8kV
Auxiliary circuit : 6kV

4. Coil Voltage
415V ac

5. Permissible ambient temperature
Operation : -5 to 40 °C
Temperature compensation : Upto 40 °C

6. Frequency
50 Hz

7. IP Protection
IP 54

8. Cable incoming from Supply
Top & Bottom both provisions

9. Cable outgoing to Motor
Bottom

10. Locking
Middle lock with key

Installation

- 1 Enclosed Starter 3TE75 are Wall mounting type. Care should be taken to avoid shocks and prolonged vibrations.
- 2 Refer figure 8 for the mounting dimensions and figure 4 for permissible mounted angle.
- 3 Mount on a plane surface by 4 x M10 bolts/studs, secured by nuts with plain and spring washers.
- 4 Depending upon location of incoming and outgoing cables remove corresponding rubber Grommets. Ensure dust-proofing by using proper cable glands.
- 5 Select Correct Size of Cables as specified in selection Table 1. Remove required length of insulation and using the hardware specified (refer table 2) at the connection terminals, fix the incoming and outgoing cables. Tighten the screws firmly.
- 6 Check that line and motor connections are done as per wiring diagram (Figure 7) which is also pasted inside the door.
- 7 Remove any wire cutting fallen into the Starter.
- 8 Connect Earthing conductor to terminals marked

Commissioning

- 1 Open the door by unlocking the locks
- 2 Before switching ON, re-check external connections.
- 3 Set Overload relay to 0.58 times the rated motor current.
- 4 Set the dial of the Timer to an approx. value of starting time of Motor (preferably more than 6 secs)

A. Star-delta Timer setting

- 1 First Start the motor by pressing Green push button, marked "I"
- 2 Measure time taken for it to reach nearly rated speed or steady state current (indicated when motor hum reaches a steady pitch)
- 3 Stop the Motor, set Timer to this measured value, by rotating the Timer dial.

B. Relay Settings

- 1 For Closer protection set the Overload Relay to the phase current as measured by an ammeter.
- 2 In absence of Ammeter, use procedure as given below:
 - a Start the motor and let it run for half an hour. Then gradually reduce relay setting till it trips. Set Relay at a slightly higher value of this setting.
 - b Allow reset time of approx. 4 min. Press the blue knob on the relay completely to reset the relay.
 - c Re-start motor after some time. If the relay does not trip, consider it to be properly set. If it trips follow step b with setting at little higher value and recheck.
 - d Overload relay characteristics given below can be used to estimate the average tripping time at different multiples of set current.

Caution:

- 1 Switch OFF the Starter, and disconnect the main supply by switching OFF the main switch before doing any maintenance.
- 2 Under No Circumstances should the Relay be set higher than phase current ie. 0.58 times the rated current on the motor nameplate.
- 3 If the Relay trip even when set at the rated Motor current, the suitability of the starter or relay for the particular application should be checked with the nearest Siemens office.
- 3 Refer Table 1 for the Motor current corresponding to the Motor rating.



Unrestricted

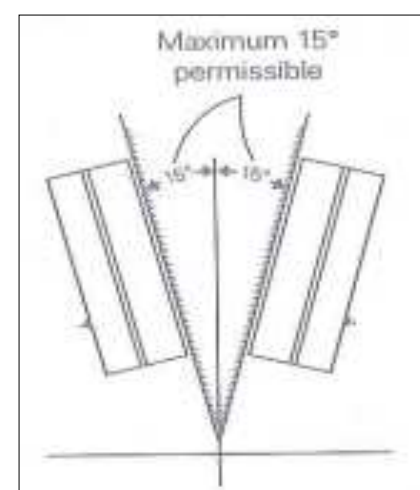
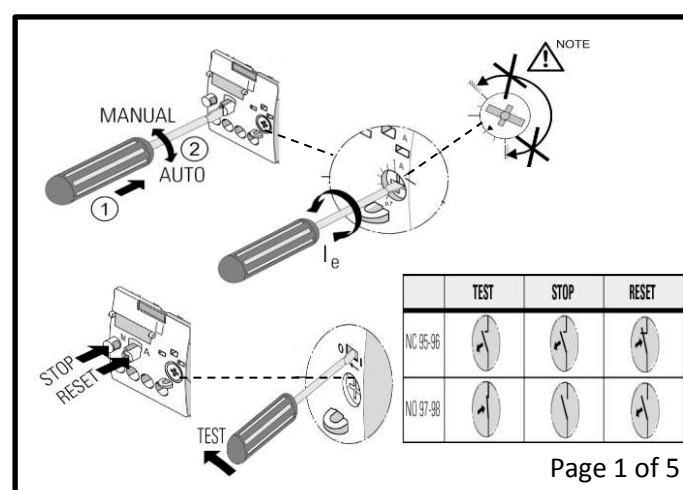

Table 1: Technical details

Motor Rating at 415V, 3ph ,50Hz (Kw/HP)		Motor Current		Type (ASD)	Contactor	Contactor	Birelay (Inbuilt)		Recommended Max. Back-up HRC Fuse rating SIEMENS make type 3NA	Recommended Cu Cable with lugs in sq. mm	
		Line current	Phase current	MLFB	Delta/Main	Star	Relay Range	Type		Incoming	outgoing
HP	KW	I _L (A)	I _{ph} (A)		3TS	3TS			rating SIEMENS make type 3NA	From Supply	To Motor
100	75	131	75,6	3TE7594-2AR0	3TS5002-0A..	3TS4802-0A..	70-95A	3US58 00-8Y8K	160	50	25
125	90	156	90	3TE7595-2AR0	3TS5102-0A..	3TS4802-0A..	70-95A	3US58 00-8Y8K	160	70	35
150	110	189	109	3TE7596-2AR0	3TS5102-0A..	3TS5102-0A..	95-120A	3US58 00-5D8K	200	95	35
180	132	227	132	3TE7597-2AR0	3TS5202-0A..	3TS5202-0A..	115-180A	3US62 20-5B8K	250	120	50

* For Type-2 co-ordination chart, refer latest Price list of " LV switchgear - Motor control products"

Trip Curve

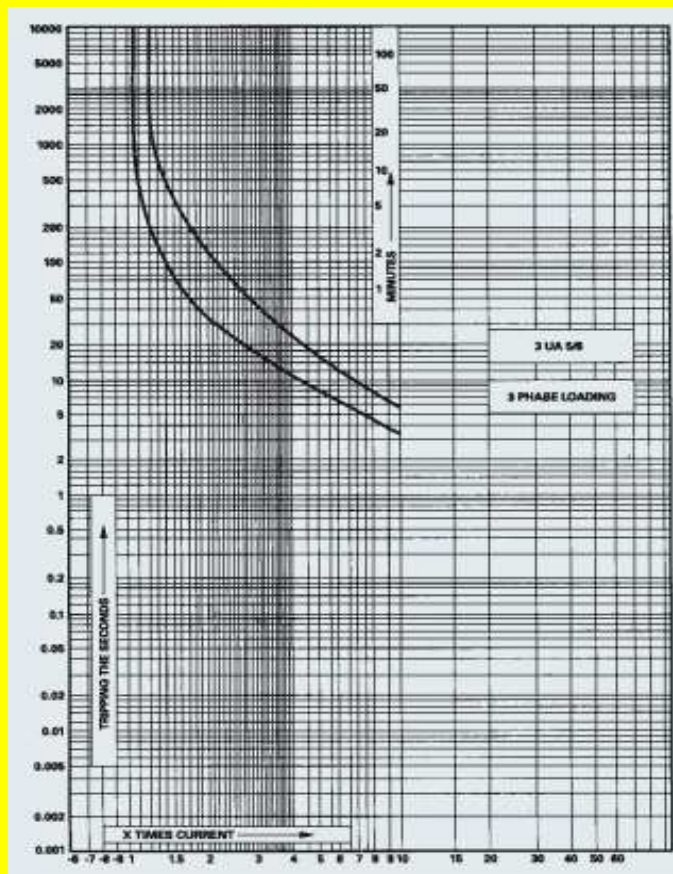
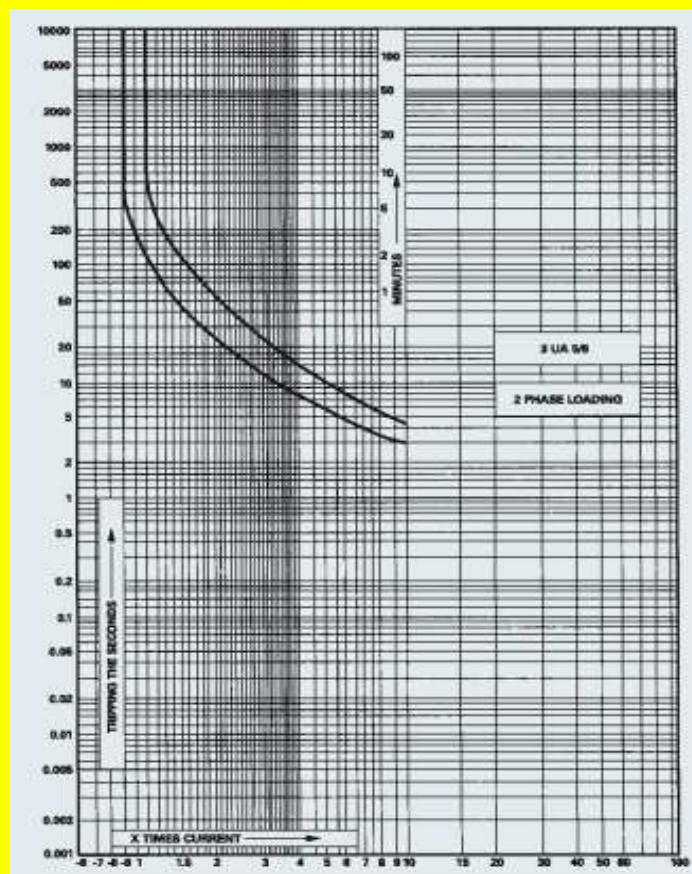

Figure 5: Operating Charateristics of 3US5/6 Relays



Operation

- 1 For Starting the Motor, press Green push button, marked "I"
- 2 For Stopping the Motor, press Red push button, marked "O"
- 3 For Relay Reset: First switch off the Starter, open the door and then press blue push button, marked "Reset", for resetting, after the relay has tripped due to overload.
- 4 In case if you want the Starter in "Self Reset" mode, the blue knob on Relay is to be pressed and rotated in anticlockwise direction, so that it comes in position "A" and its edge flush with the relay surface. In this mode if the relay trips on overload, it will be automatically reset in maximum 4 minutes. The Motor can be restarted only after the relay is reset.

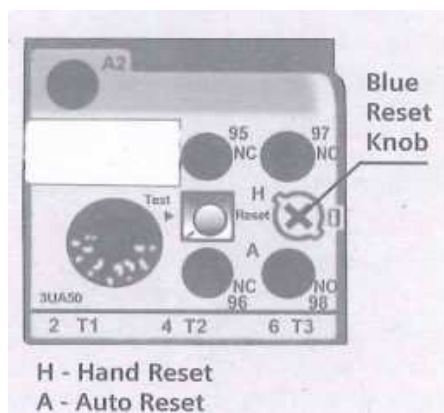

Figure 6: Relay Front View

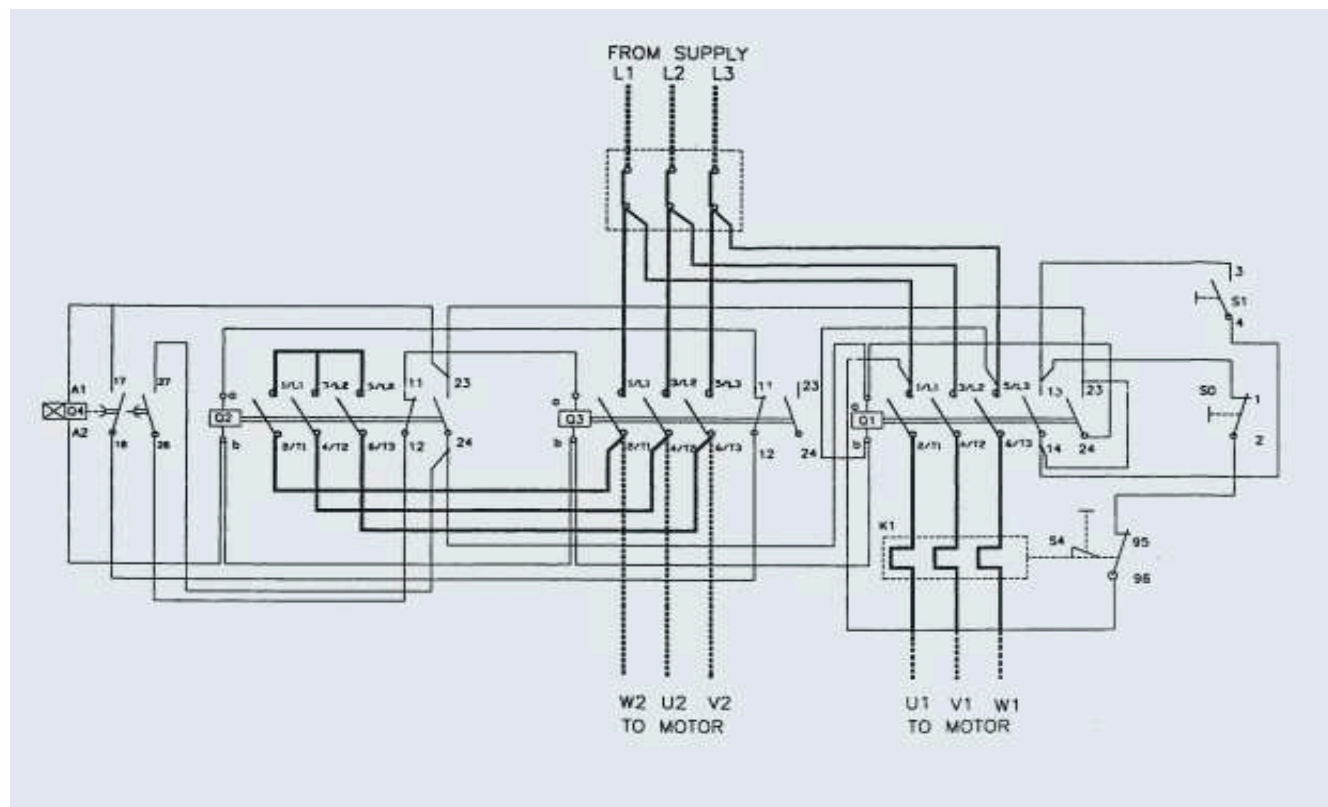

Figure 7: wiring Diagram

- | | | |
|----------------------|--------------------------------|-----------------------|
| Q1 : Line Contactor | S1 : 'ON' Push Button | K1 : Bimetal Relay |
| Q2 : Star Contactor | S0 : 'OFF' Push Button | Q4 : Star Delta Timer |
| Q3 : Delta Contactor | S4 : 'Reset' Button (of Relay) | |

Maintenance

- 1 keep the interior dust free.
- 2 Check the tightening of terminal screws time to time.
- 3 No Maintenance is needed for overload relay and Timer. Do not open them.
- 4 If the Contactor hums, clean the magnet pole faces with soft cloth.
- 5 Replace contacts of the contactor if they are severely pitted or when only 40% original contact tip remains.

Dimensional Drawings (all dimensions in mm)

3TE759.-2AR0

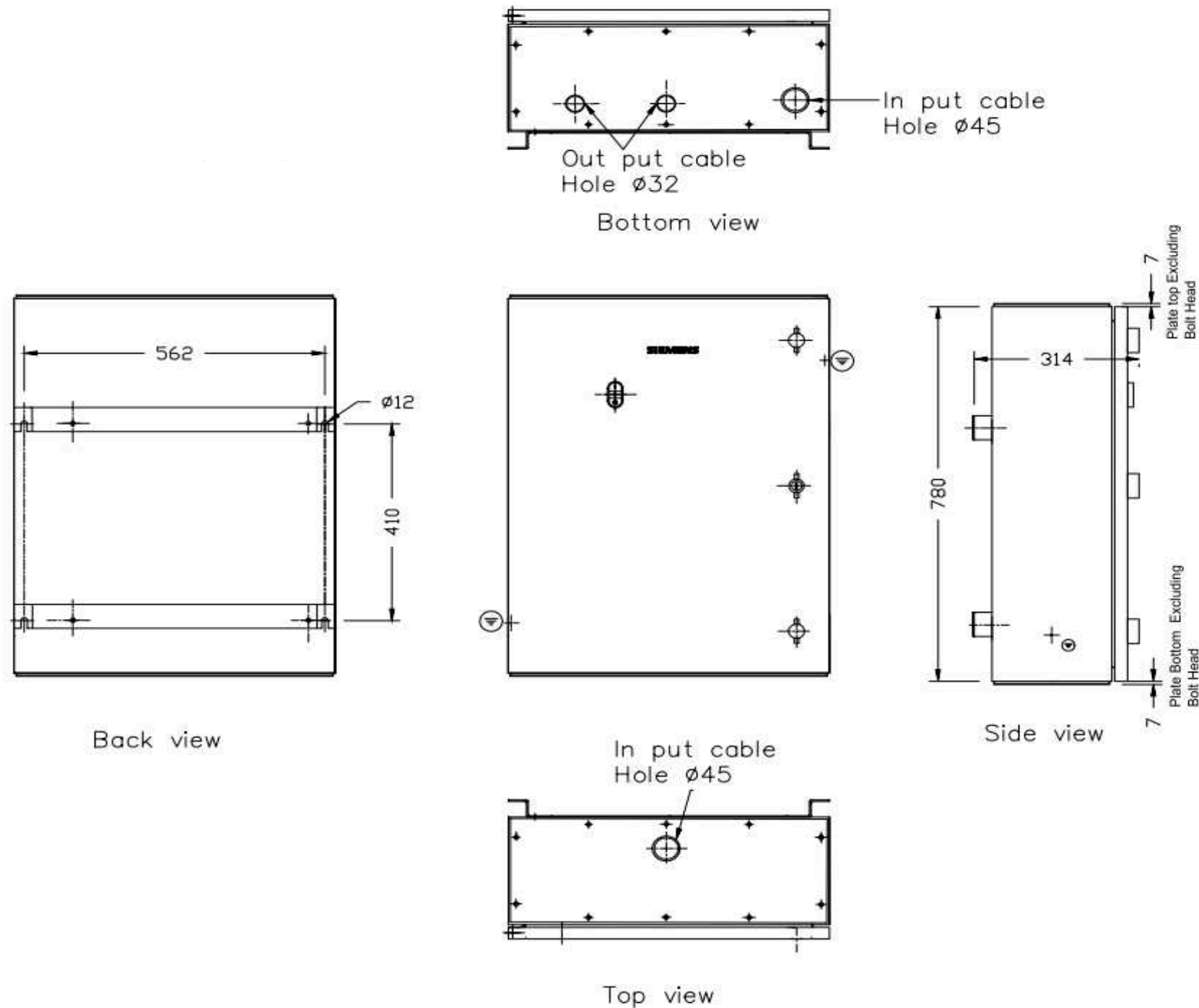

Figure 8: External and Mounting Dimensions

Table 2 : Hardware information

KW	Incoming Terminals	Outgoing Terminals	Tightening Torque
75	M6	M6	8-10 Nm
90	M6	M6	8-10 Nm
110	M6	M6	8-10 Nm
132	M8	M8	12-16 Nm

Spares List

Spares:			
Type of Spares	MLFB/Catalogue Number-Make	Make	
ON/OFF Actuator	3SB5201-7EC01	Siemens	
Electronic Timer	3RP15 76 -1NM20 8K	Siemens	
Relay	As per Table 1	Siemens	
Lock with key	MS 748-3 with Cam 12mm	Arihant Panel fittings	
Lock without key	MS 714-2 with Cam 12mm	Arihant Panel fittings	

Disposal

Siemens product are environment friendly, which predominantly consist of recyclable materials.

For disposals we recommend disassembling and separation into following materials:

METALS: Segregate into Ferrous & Non Ferrous types for recycling through authorised dealer.

PLASTICS: Segregate as per material type for recycling through authorised dealer. Because of the long lifetime of Siemens products the disposal

The local customer care service is available at any time to answer disposal-related questions

Customer Care Toll free no. 1800 209 0987 / 1800 220 987

Email: ics.india@siemens.com

Product upgradation is a continuous process. Hence, data in this leaflet is subject to change without prior notice. For the latest information, please contact our sales Offices.

Siemens Ltd.
SGR-xx-xxx-xxx

Order no: ASE45842956A / AA
Expert

Spares List

Spares:	
Type of spares	MLFB
ON/OFF Actuator	3SX15521YA
RESET cord for ASD3	3UX1015
ACCESSORY for 3UA58 INDEPENDENT MTG.	3UX1421
ON/OFF Switch (DOL-2 & ASD-2)	3SX15511YA
Contact Block(1NO)	3SB54200B
Contact Block(1NC)	3SB54200C
Contactors Spare Contacts kit	Refer Siemens Price-List.
Electronic Star-Delta Timer	Refer Table 5
Relay	Refer Table 3

Spares:	
Type of Spares	MLFB
ON/OFF Actuator	
Reset cord for ASD	3UX1015
Accessory for 3UA58 Independent mounting	3UX1421-0XA
Electronic Timer	3RP15 76 - 1NM20 8K
Relay	As per Table 1