



SIEMENS

Ingenuity for life

SINAVY DC-Prop and SINAVY PERMASYN®

Integrated Propulsion Solutions
for Submarines

[siemens.com/marine](https://www.siemens.com/marine)

Contents

| | |
|---|----|
| History | 3 |
| General information | 6 |
| General requirements and integration | 6 |
| SINAVY SUB Siemens Propulsion Systems for submarines | 8 |
| SINAVY DC-Prop | 9 |
| SINAVY DC-Prop Type 209 | 11 |
| SINAVY DC-Prop Type Dolphin | 12 |
| SINAVY PERMASYN | 13 |
| SINAVY PERMASYN Type 212A | 20 |
| SINAVY PERMASYN Type 214 | 22 |
| SINAVY SUB, references and outlook | 23 |



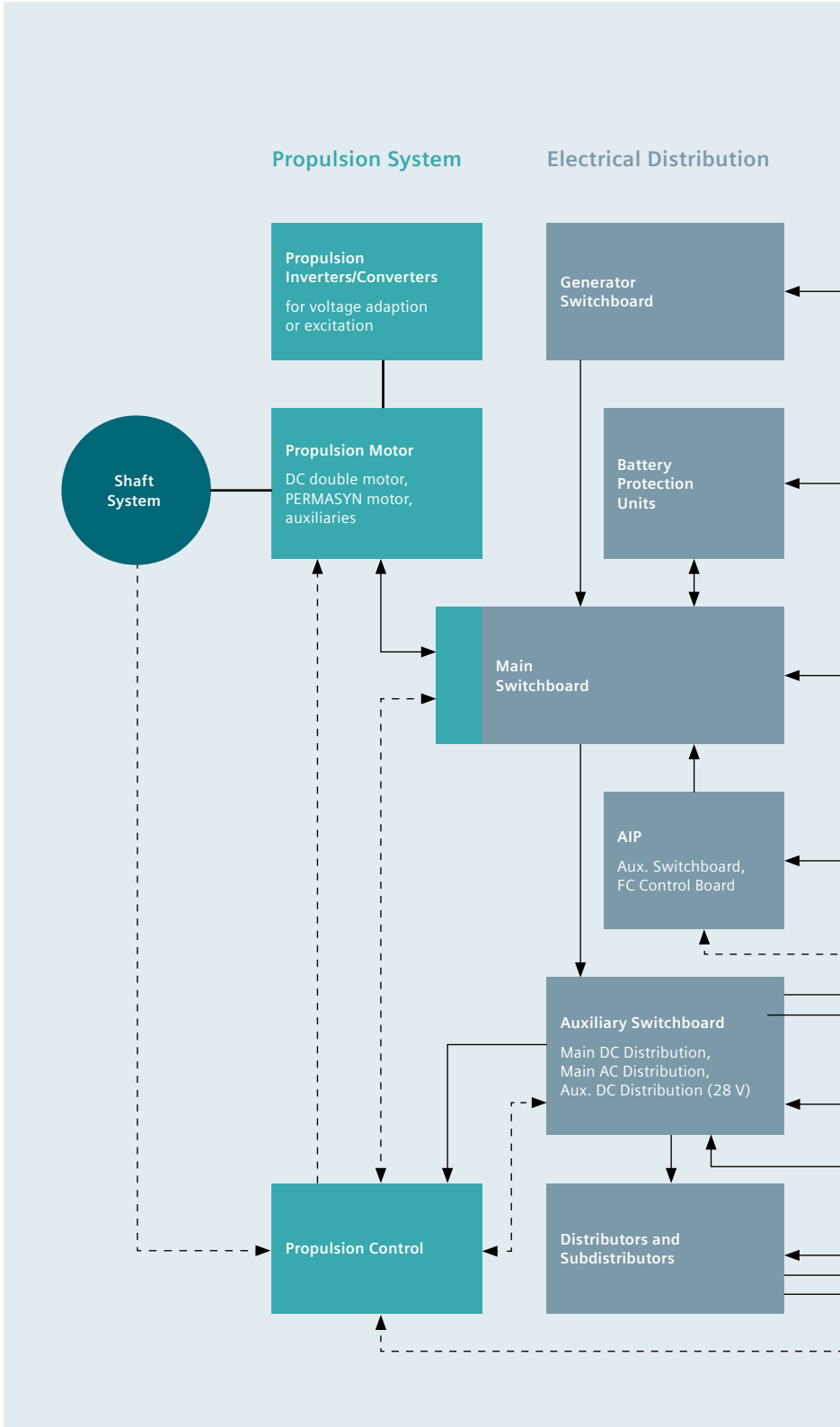

Structure of electrical platform technology for conventional submarines SSK

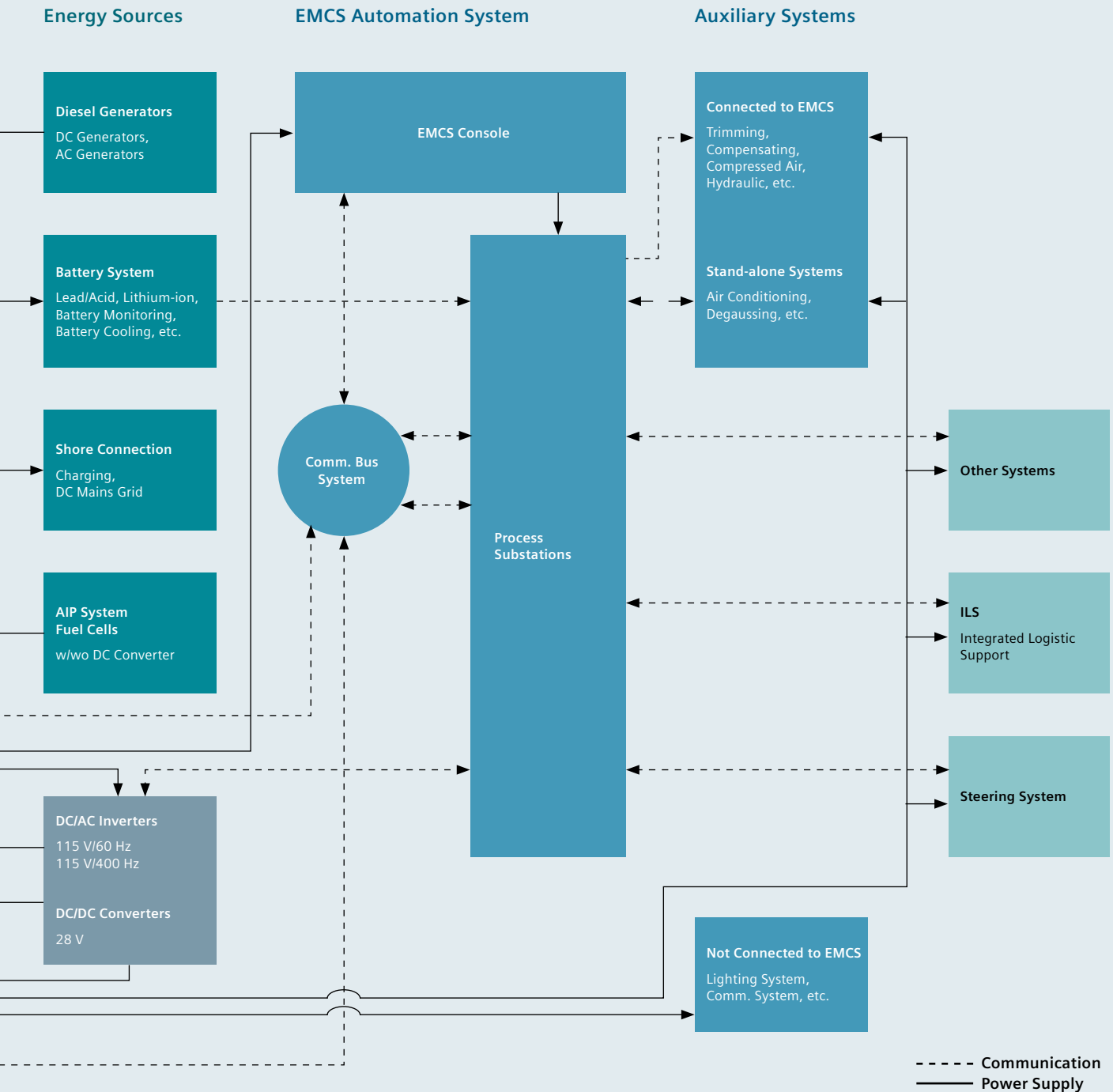

History



A long tradition of success

In 1877 the Siemens cable-laying ship *Faraday* was the first ship in the world to be equipped with an electrical lighting system. In 1879 Siemens sold the first electrical installations for ship lighting to be used for three German ships *Hannover*, *Theben* and *Holsatia*. These contracts 135 years ago are regarded as the official start of the Marine activities.

In 1886 the Siemens-built *Elektra* was the world's first ship with an electrically powered propeller (4.5 kW electric propulsion motor). In 1904 Siemens supplied all the electrical machines for three submarines of the Russian navy and in 1906 for the first German submarine. Since then, for approximately 110 years, Siemens has played a leading role in the design and construction of electric Propulsion Systems for submarines.

For decades DC double motors together with armature and exciter current choppers dominated submarine propulsion. In 2000 Siemens delivered the first permanent-magnet synchronous motor with integrated power converters and PERMASYN-type propulsion motor/ drive for a submarine to a yard. The impressive reference list of Propulsion Systems for the last approximately 50 years can be found on page 24.

Propulsion Systems for conventional submarines consist of:

- A propulsion motor for direct drive of the submarine (directly coupled, without reduction gear)
- Inverters/converters for adapting/converting voltages (e.g. choppers or power inverters/converters)
- Switchboards for switching and protection of the Propulsion System and ship mains
- Propulsion control with open- and closed-loop control functions for monitoring and operation of the Propulsion System components



General information

Propulsion Solutions for conventional submarines allow the use of stored or generated electrical power supplied directly or indirectly (via batteries) from DC sources such as Air Independent Propulsion (AIP) systems for propulsion purposes. In terms of technology, Siemens PEM Fuel Cell or Stirling-based systems are most common today, followed by diesel generator sets, shore connection/charging connection, and battery systems. (The state of the art is still lead-acid submarine battery systems with gel batteries shortly expected to be introduced and Li-ion battery systems under development.)

Integrated Propulsion Solutions harmonize interfaces between the dedicated propulsion components for optimized efficiency under the special environmental conditions of submarines. They form the basis for a highly valuable submarine platform with desired features such as long submerged endurance, long cruising range, extremely silent and to the extent possible undetectable mode of operation, high sprint potency, etc. For details, please refer to the graphic "Structure of electrical platform technology" on page 4/5.



General requirements and integration

Cutting-edge technologies required

Propulsion Systems for submarines are highly specialized drive and switching plants in the DC low-voltage range (up to 1,000 V DC) for high power and heavy short-circuit loads.

They are designed to fulfill requirements related to the application, such as

- environment (temperature, humidity, static/transient air pressure)
- shock
- EMC
- inclinations/heeling (static and transient)
- signatures, mainly
 - noise emission (structure and airborne noise)
 - magnetic and electric field (nonmagnetic design, low strayfield)
- heat dissipation
- efficiency

- reliability and availability through redundancy and degradation (this involves RMA prediction/calculation/data collection)
- volume and weight restrictions
- corrosion and coating demands (resistance to seawater, etc.)
- ergonomics, illumination
- health and safety aspects (avoidance of pollution of the closed atmosphere in the boat; fire detection and extinguishing, etc.)
- material and cabling restrictions (e.g., no aggressive-flame products, no PVC)
- degree of protection

For the design of Propulsions Systems for submarines standards and general specifications apply.

Among others, these include:

- BV ("Bau-Vorschrift" for navy ships issued by German authorities)
- VG ("Verteidigungs-Geräte"-standard for material and tests/procedures)
- AQAP (Allied Quality Assurance Publications)
- IMO (International Maritime Organization)
- IEC (International Electrotechnical Commission)
- DIN ISO ("Deutsches Institut für Normung," International Organization for Standardization)
- STANAG (Standardization Agreement)
- MIL-STD (Military Standard)
- DEF-STAN (Ministry of Defense, Defense Standard)
- V-model (Development standard for IT systems)



Propulsion Systems for submarines are always designed and specifically adapted to the submarine boat design, which means that the propulsion system and boat type usually form one totally integrated unit. In general, the integration encompasses:

- Conceptual integration of the entire drive train incl. propeller (speed, torque, output power, dynamic behavior, etc.)
- Mechanical integration (flexible mounting, coupling, dampers, positioning, etc.)
- Electrical integration (cabling, cable connections, earthing and grounding, short circuit protection, overvoltage protection, etc.)
- Functional integration (monitoring and control, signaling, etc.)
- EH&S integration into the overall submarine environment, health, and safety concepts)

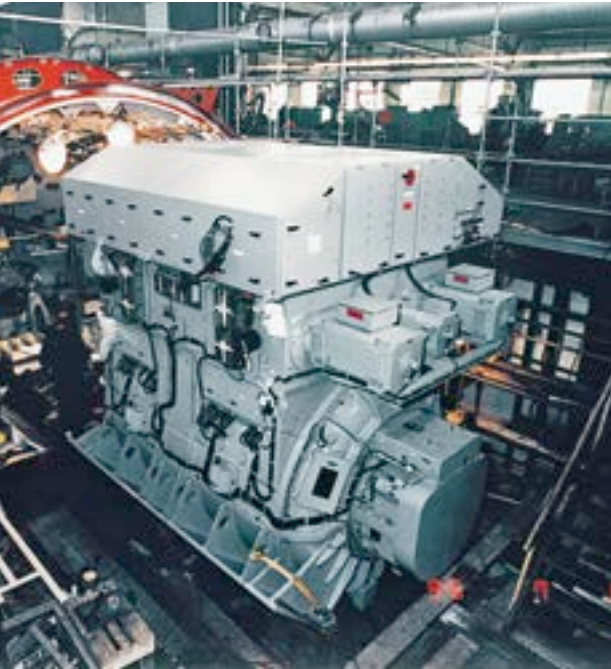

DC-Prop drive



PERMASYN drive

SINAVY SUB

Siemens Propulsion Systems
for submarines

High reliability and availability

For more than half a century Siemens Marine & Shipbuilding has been supplying electrical platform equipment, systems, and solutions for conventional submarines. Today, all Siemens submarine technology products are marketed under the SINAVY SUB brand name. This includes DC drives like the SINAVY DC-Prop as well as permanent-magnet-excited synchronous SINAVY PERMASYN propulsion drives. In total, more than 170 submarines have been ordered with SINAVY DC-Prop or SINAVY PERMASYN Propulsion Systems.

SINAVY DC-Prop

The principal propulsion system structure of DC motors built today doesn't differ much from those of earlier motor/drive designs. Starting on page 9, the two most modern SINAVY DC-Prop examples are presented.

SINAVY PERMASYN

For more than a decade, SINAVY PERMASYN propulsion drives have been part of the SINAVY SUB portfolio. Their ongoing enhancements make them the most cutting-edge propulsion technology in the market for nonnuclear submarines. Thirty-three of these drives will power the boats of seven navies. Currently there are two basic designs in operation, with an intended expansion to a third design having a higher output power for use in submarines Type 216.

Read more about the presently available designs starting on page 13.

SINAVY DC-Prop



Design and Function

Designed for the harshest submarine operating conditions, DC-Prop propulsion motors provide excellent reliability and robustness. Resistant to impact and shock, while emitting noise well under all threshold levels, they are in operation in more than 130 submarines. Their fail-safe design consists of two separate low-noise double-armature engine sections, each operating completely independently and with a minimum of two power sources.

The motors run at optimum efficiency across the entire speed range from silent mode through cruising speed. Ventilator and cooling units only come online at higher speeds, with their rotation speed and output precisely aligned to the boat's cooling requirements.

With stepped switching of the armature and its dedicated batteries, and with up to five speed ranges, each armature is assigned the correct voltage to keep energy losses to a minimum. High requirements are placed on submarine Propulsion Systems, not only for reasons of crew safety, but also because of operational demands. A high level of reliability is imperative, particularly during long periods of operation and under extreme conditions. Redundant components must ensure that system availability is upheld at all times.

Equipment belonging to (or with a functional connection to) the propulsion system:

- Partial batteries 1 up to 4
- Switching equipment partial batteries 1 up to 4
- Charging generators 1 up to 4
- Propulsion switchboard
- Propulsion motor
- Propulsion control console
- Automatic speed control
- Exciter control
- Propulsion exciter current chopper
- Propulsion armature current chopper
- Static exciter converter (class 209 only)
- Fan control
- Speed Indicator CIC

These pieces of equipment supply and distribute the energy necessary for propulsion of the submarine, or they are used for control, regulation, and monitoring purposes. The graphic on page 10 shows the schematic diagram of the propulsion system circuitry, with the partial batteries, the charging generators, the propulsion motor, and the corresponding power circuit breakers in the propulsion switchboard.

During Propulsion Operation, the partial batteries are connected according to the speed steps:

| | |
|-----------------------------------|--------------------------------------|
| Parallel connection | Speed steps I and II AHEAD/ASTERN |
| | Speed step III AHEAD |
| Series connection | Speed steps IV and V AHEAD |
| Series/parallel connection | Speed step III ASTERN |

The Propulsion Motor is a DC double motor with separate excitation. The housing includes two motors of identical design and power. The motor armatures are arranged on a common shaft, being connected either in parallel or in series, depending on the speed step. Consequently, combined with the switching possibilities of the four batteries, four basic motor speeds are produced which can be varied by regulating the field.

When operating with parallel-connected armatures, auxiliary series windings are switched into the armature circuit in order to achieve load distribution. These auxiliary series windings are not effective during series connection of the armatures.

The propulsion motor is air cooled by means of four fans arranged on top of the housing. The four fans circulate air from the engine room through the propulsion motor and two coolers. The coolers are attached to the intermediate section of the motor housing on the port side and on the starboard side. The fans are controlled either from the Propulsion Control Console (PCC), according to the speed step, or from the automatic speed control (auxiliary switch-board) as a result of speed step and armature current.

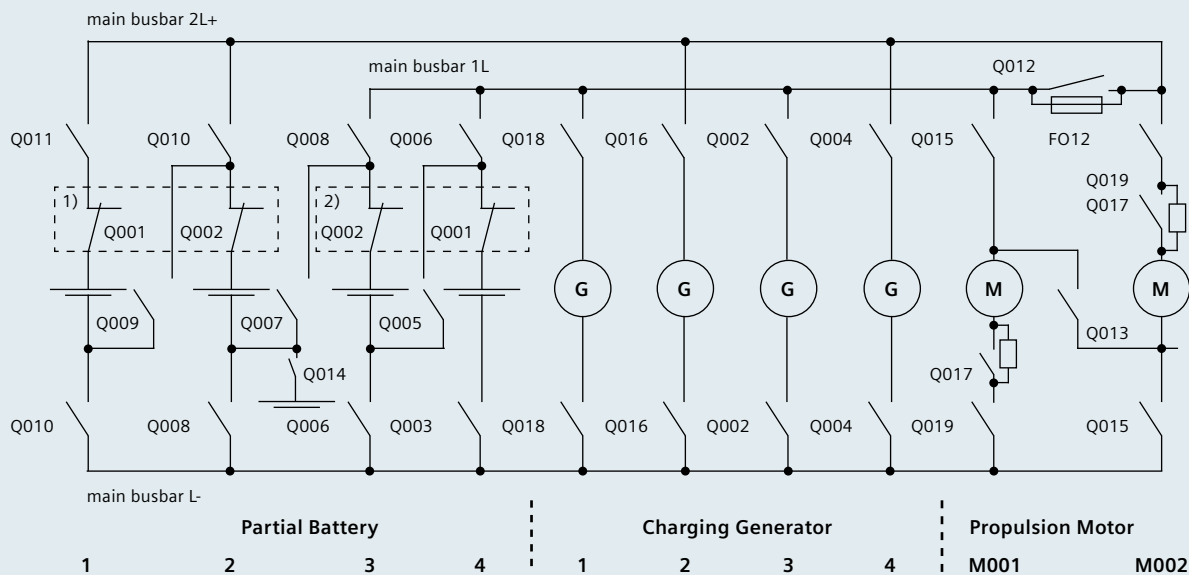

1) Switching Equipment Partial Battery 1/2 2) Switching Equipment Partial Battery 3/4

Typical basic single line diagram

SINAVY DC-Prop Type 209



Design and Function

SINAVY DC-Prop, propulsion drive Type 209 features:

- DC double motor with separate excitation with auxiliary series winding 2x12 main poles; 2x12 interpoles with compensation winding
- Approx. 4 MW output power
- Choppers for armature and exciter current
- Open air cooling system through four axial flow fans, each driven by an independent DC motor and two seawater heat exchangers for air recooling
- Sleeve bearings, oil lubrication by means of fixed rings
- Two stator yokes, each provided with a yoke turning gear.
- One shaft turning device (either pneumatic or hydraulic)
- Standstill heating
- Two speed/rpm measurements and shaft-angle encoder
- Several temperature and other sensors/measurements
- A disconnecter in the main terminal box of each partial motor for service purposes

Specifications and technical data

Environmental conditions

The motors are suitable for operation in a salt-laden atmosphere. The following applies to unrestricted operation:

- Ambient temperature in engine room: 0°C to +45°C
- Cooling seawater temperature: max. +30°C
- Continuous air humidity in engine room:
 - 80% at +35°C
 - 90% at +35°C, max. 60 min without condensation
- Atmospheric pressure in engine room: continuous 800 to 1,400 mbar; 600 to 800 mbar, max. 3 min.

Inclined positions

| | |
|------------------|----------------------------------|
| Max. heel | < ±15° continuously |
| | < ±45° temporarily (max. 10 min) |
| Max. trim | < ±10° continuously |
| | ≤ ±30° temporarily (max. 10 min) |

Motor not in operation

| | |
|-------|-------|
| Heel | < 60° |
| Trims | < 45° |

The following applies to transport and storage of the motors (without cooling water)

- Ambient temperature: –30°C to +70°C
- Air humidity max. 80% at 35°C no condensation



SINAVY DC-Prop Type Dolphin

Design and Function

SINAVY DC-Prop propulsion drive Type Dolphin features

- DC double motor with separate excitation with auxiliary series winding 2x12 main poles; 2x12 interpoles with compensation winding
- Approx. 3 MW output power
- Choppers for armature and exciter current arranged on top of the motor
- Closed air cooling system through four axial flow fans, each driven by independent DC motors and two seawater heat exchangers for air recooling
- Sleeve bearings, oil lubrication by means of fixed rings
- Two stator yokes, each provided with a yoke turning gear
- One shaft turning device (hydraulic or pneumatic)
- Standstill heating
- Two speed/rpm measurements and shaft-angle encoder
- Several temperature and other sensors/measurements

Specifications and technical data

Environmental conditions

The motors are suitable for operation in a salt-laden atmosphere. The following applies to unrestricted operation:

- Ambient temperature in engine room: 0°C to +45°C
- Cooling seawater temperature: max. +32°C
- Continuous air humidity in engine room: max. 90% at +35°C without condensation
- Atmospheric pressure in engine room: continuous 800 to 1,400 mbar; min. 600 mbar max. 3 min.

Inclined positions

| | |
|-------------------------------|----------------------------------|
| Max. heel | < ±15° continuously |
| | < ±45° temporarily (max. 10 min) |
| Max. trim | < ±10° continuously |
| | ≤ ±30° temporarily (max. 10 min) |
| Motor not in operation | |
| Heel | < 60° max. 1 min |
| Trims | < 45° max. 1 min |

The following applies to transport and storage of the motors (without cooling water)

- Ambient temperature: 0°C to +70°C
- Air humidity max. 90% at 35°C no condensation



SINAVY PERMASYN

Design and Function

The PERMASYN motor is a freshwater-cooled synchronous motor with permanent-magnet field excitation and multi-phase stator winding. The phase windings are fed from the DC power system via a system of pulse-controlled inverters. This inverter system is part of the motor.

The winding of each partial is divided into two identical, electrically separated partial phases. Each partial phase is supplied by an individual pulse-controlled inverter module. The complete set of inverter modules is supplied by two independent electrical feeders. Each set of windings, inverter modules, and feeders form an independent part of the motor power circuit.

By changing the inverter control setting, the phase currents and thus the torque of the motor can be varied infinitely over the entire operating range. The current is controlled according to magnitude and curve shape, the associated electronics being accommodated within the inverter system.

Speed and Monitoring Computers (SMC) and an Automatic Propulsion Controller (APC) are responsible for the computerization of the motor set points.

The SMC has several tasks:

- Coordination of functional interaction between all motor components
- Monitoring motor faults
- Enabling protection against overload
- Shutting down in case of failure
- Transferring of motor status to downstream-located controls (submarine APS or Engineering Monitoring and Control System (EMCS))

At present and in the future the functions of SMC and APC are integrated into one device called the APC, situated on top of the motor.

Stator and housing

The stator-cooling ring with the stator core forms the yoke, and is arranged in such a way that it may be rotated by means of a manually driven device after dismantling several fixing elements. The stator core carries the multi-phase winding. The drive and non-drive-bearing end shields are split horizontally into two halves, with the top halves being split again into two or three parts.

The top bearing end shield parts can easily be removed separately for inspection and repair. The rotatable mounting of the stator core provides good access to all end windings, cooling water reversal chambers, and phase fuses.

Rotor and inverter system

The rotor consists of a hollow shaft to which a bell-shaped part is flanged. The poles are mounted on the outside of the bell. The permanent magnets are bonded to the poles.

Inside the bell, the modular inverter system is accommodated where the modules are concentrically arranged in the form of cylindrical segments around the shaft on a support frame. The latter is rigidly connected to the rotatable yoke so that each inverter module can be positioned as required. Removing non-drive-bearing end shield parts permit the complete inverter module to be removed for repair, or to replace defective power supply and control modules as well as fuses. Moreover, the openings permit access to the signal distributor (signals between the inverter and the SMC and other motor components).

The power supply is transmitted to the inverter modules via two semicircular busbar pairs arranged around the shaft. They run close to the front of the module faces at the non-drive end and are bolted to the module connections. The individual phase windings are connected by cable to the associated inverters. The connections are also located at the non-drive end.

Each inverter module contains two pulse-controlled inverters in single-phase bridge connection. The electronic switching elements are of the IGBT type (integrated gate bipolar transistor). The modules are water cooled. Each inverter has an input filter and a series transistor module, the latter being required for reverse current blocking in the event of system short circuits. The inverter modules also contain the open and closed-loop control electronics directly associated with the inverter module, the coupling electronics for data communication with the SMC/APC, and an integrated DC/DC power supply.

Bearings

The rotor runs in disk-lubricated air-cooled sleeve bearings at the drive and non-drive ends. The drive end bearing is a locating bearing, the non-drive end bearing a floating one. The propeller thrust must be taken by a thrust bearing installed in the shaft system of the boat (outside of the PERMASYN drive). A reliable oil supply to the bearings is ensured even under severe inclination by disk-and-wiper lubrication. Shaft seals prevent lubricating oil from leaving the bearings. The bearings are cooled by appropriate finning of the bearing housings. The lowest continuous speed is approx. 11 rpm. For turning operation the bearings are fitted with an oil-lift device. Both bearings are split horizontally. Their bottom halves are flanged to the associated bottom half of the end shields at the drive and non-drive ends. In order to avoid bearing currents, both bearings are insulated electrically, while the shaft is connected to the housing via earthing brushes at the non-drive end.

Speed and monitoring computer (SMC)

The SMC system of the PERMASYN motor consists of two SIMATIC computers, which monitor each other, and are accommodated in a common housing on the motor.

It performs the following tasks:

- Processing of the incoming signals from the APC, such as speed set point values, operating modes, limitations, etc.
- Speed control of motor
- Functional coordination of motor components
- Monitoring of motor components for failure, temperature, and malfunctioning
- Automatic activation of degradations and/or redundancies in the event of faults
- Check-back indication of status and fault signals to the control system.

These functions are performed by one computer selected as master. A second computer, operating in hot standby, takes over automatically in case of failure.



Transmitter system

In addition to the sensors required for fault monitoring (temperature rise, leakage, etc.), the motor is fitted with a redundant transmitter system for rotor position and speed. This transmitter system is required for the phase current and speed control of the motor and consists of rotary position encoders.

In addition, a tachogenerator requiring no separate voltage source is provided. It is not a functional part of the motor, but serves for remote indication of the shaft speed in the control center and at other locations in the boat. The tachogenerator and the rotary position encoder are mounted on a common equipment carrier.

Cooling system

The stator and the inverter modules are cooled with freshwater, which is circulated by pumps and re-cooled by seawater in heat exchangers. For reasons of redundancy, there are two independent cooling circuits. The heat exchangers and pumps are located on top of the PERMASYN motor. The heat exchangers are designed as tubular coolers. They are made of a titanium alloy.

Anti-condensation heaters

The motor is equipped with electrical anti-condensation heaters. They consist of coiled heating rods installed at the drive and non-drive end in the lower part of the bottom end shield halves. The power supply is provided by two separate feeders.

Power supply

The phases of the stator winding are connected with the associated inverters so that two independent system halves are formed, which are supplied via two mutually independent feeders from the propulsion bus of the main switchboard (main feeders).

For PERMASYN motor operation, moreover, separately fused and switched feeders are required for the inverters of cooling pumps, the speed and monitoring computer, the inverter electronics, and the precharging and discharging of the inverter modules. For reasons of redundancy, a separate propulsion system feeder for each component is provided in the main switchboard (auxiliary feeders).

The motor is supplied by two sets of cables containing the cables for both main and auxiliary feeders. Each set of cables is connected to a separate terminal box.

Redundancy/degradation concept

The high availability of the motor is attained by redundancy and degradation.

- The redundancy principle is adopted, for example, with the SMC and the inverters for cooling pumps; this means no restrictions for the operation.
- The degradation principle is used, for example, in the inverter system. By virtue of modular design and appropriate circuitry of its modules, it is possible to continue to run the motor with reduced output even if several modules have failed. The failure of all but two inverters still permits propulsion, even though with proportionally reduced power.
- Another example for the degradation concept is the power supply to and within the PERMASYN motor. If one of the auxiliary feeders fails, the motor remains available to at least 50% by way of the other feeder. If one of the two main feeders is tripped due to a fault, the motor can still continue to be operated with half the current, corresponding to 50% of its rated torque.

Operating modes

In consequence, with regard to operation, a distinction is made between three modes: normal operation, manual operation, and turning.

a) Normal operation:

In this mode (automatic mode), the motor is controlled exclusively by the APC. This is subject to the proper functioning of the EMCS of the submarine, the SMC, and the associated serial data transmission system. If this is not the case, it is possible to switch over to manual operation at the manual control panel and thus disable the SMC.

For normal operation, moreover, this means that the motor is designed to run in the slow-speed range with minimum noise and with maximum possible efficiency.

This will be achieved by switching over to half the number of phases. Only 50% of the IGBTs are then active. This leads to a reduction of the losses in the inverter and thus to a corresponding efficiency improvement.

In the upper speed range, it is necessary to switch back to the full number of phases. The changeover point is determined by the SMC; the changeover is done automatically. These changeover devices are a part of the inverter modules.

b) Manual operation:

The motor is operated from the manual control panel. The front of the panel is equipped with all necessary transmitters, indicating instruments, signal lamps, and control switches. Manual operation takes place by bypassing the SMC/APC and, due to the resulting restricted self-monitoring of the motor, restricts the output to approx. 50% of nominal power. According to the propeller characteristic, this means that approx. 80% of the rated speed can be attained.

c) Turning:

This operating mode permits slow turning of the propeller shaft for inspection purposes.

Standards and specifications

The PERMASYN motors are designed and manufactured according to EN 60034-1. Full account is taken of the German Navy Specification BV 3100 for electrical machines, converters, and transformers of surface vessels and submarines; motors according to other standards and specifications on request.

Efficiency

The efficiency curves are shown below and are based on the following:

- Propeller characteristic $P \sim n^3$
(P = output power. n = motor speed)
- Battery voltage at mean discharge
- The figure shows the bandwidth between the efficiency characteristics of the smallest and the largest motor.
- The discontinuity of the characteristics at approx. 35–40% of n_N is due to the phase changeover and cooling pump switchover.

Electromagnetic compatibility (EMC)

Based on MIL-STD 461C, the PERMASYN motor has been subjected to detailed modeling and simulation, considering the experience from a wide field of IGBT applications in inverter technologies. The resulting measures (e.g., integrated filters, good suppression of radiated emission, reduction of structure currents, etc.) have been adopted for the PERMASYN motors.

The PERMASYN concept has been designed to rules and design principles of NAVSEA 0981-LP-052-8140 (Manual for Design of Electrical Equipment with Small Stray Magnetic Field). The limit values of the DC stray field have been proven by test.

Noise signature

The PERMASYN concept has fulfilled the special requirements for low noise emission of different navies for submarine Type 212A and Type 214, the most modern nonnuclear submarine types at the beginning of the third millennium. Those very-low-noise-limit values have been reached mainly by optimizing

- design and control of inverters
- curve shape of currents
- control of pulse frequency, and
- control of pulse sequences.

Construction details

Paintwork

The motors are supplied with a paint system approved by the German BWB (Federal Office for Defense Technology and Procurement). This standard paintwork is applied in the color RAL 7001 (silver-gray). Paint systems deviating from this standard, with a structure and color according to other specifications, can also be supplied.

Cable entries

The cables normally enter the two terminal boxes by way of cable glands to VG 88773, with earthing inserts according to VG 88812.

Maintenance

Because of the functional principle of their components, maintenance work on PERMASYN motors is practically confined to regular changes of the lubricating oil of the two motor bearings, as well as occasional cleaning of the heat exchangers.

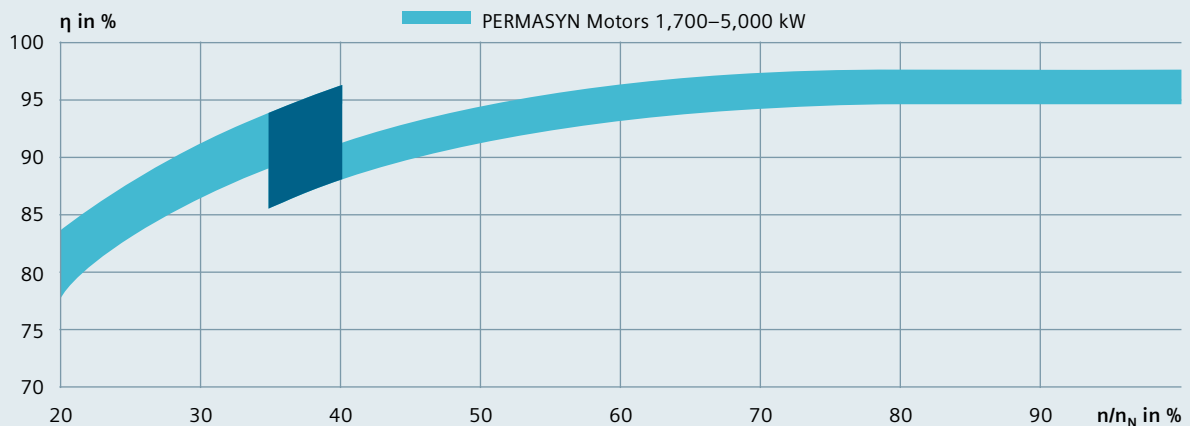

Range of efficiency curve

PERMASYN motor, system overview – On principle design

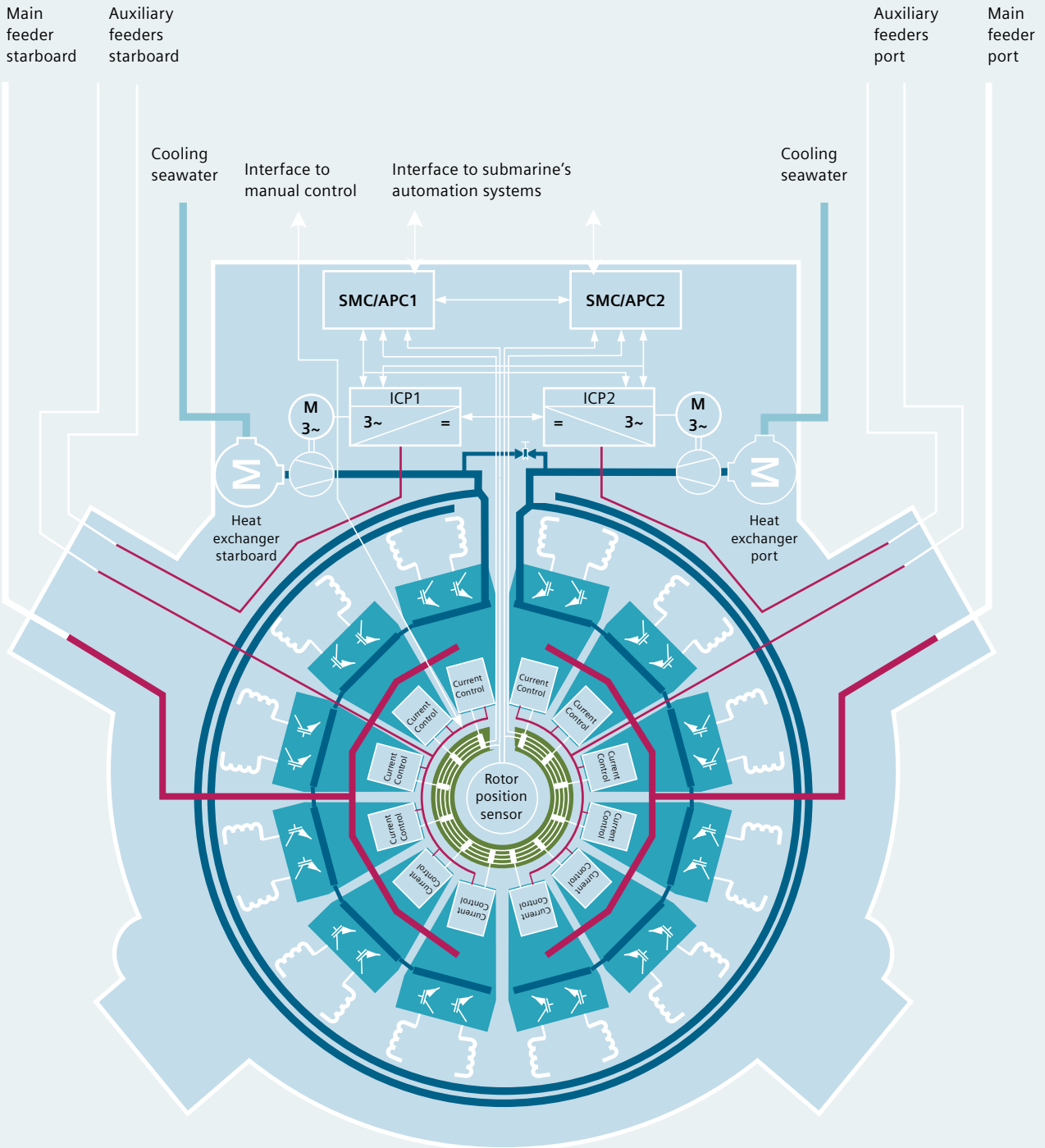

PERMASYN motor and inverter module configuration – On principle design

- | | | | |
|---|---|----|--|
| 1 | Cooling pump supply (ICP) | 7 | Bell-shaped rotor with permanent magnets |
| 2 | Speed and Monitoring Computer (SMC/APC) | 8 | Water cooling ring |
| 3 | Heat exchangers | 9 | Stator core |
| 4 | Rotor position sensors | 10 | Stator winding |
| 5 | Bottom bearing end shield half | 11 | Bearing |
| 6 | Integrated inverter module | | |

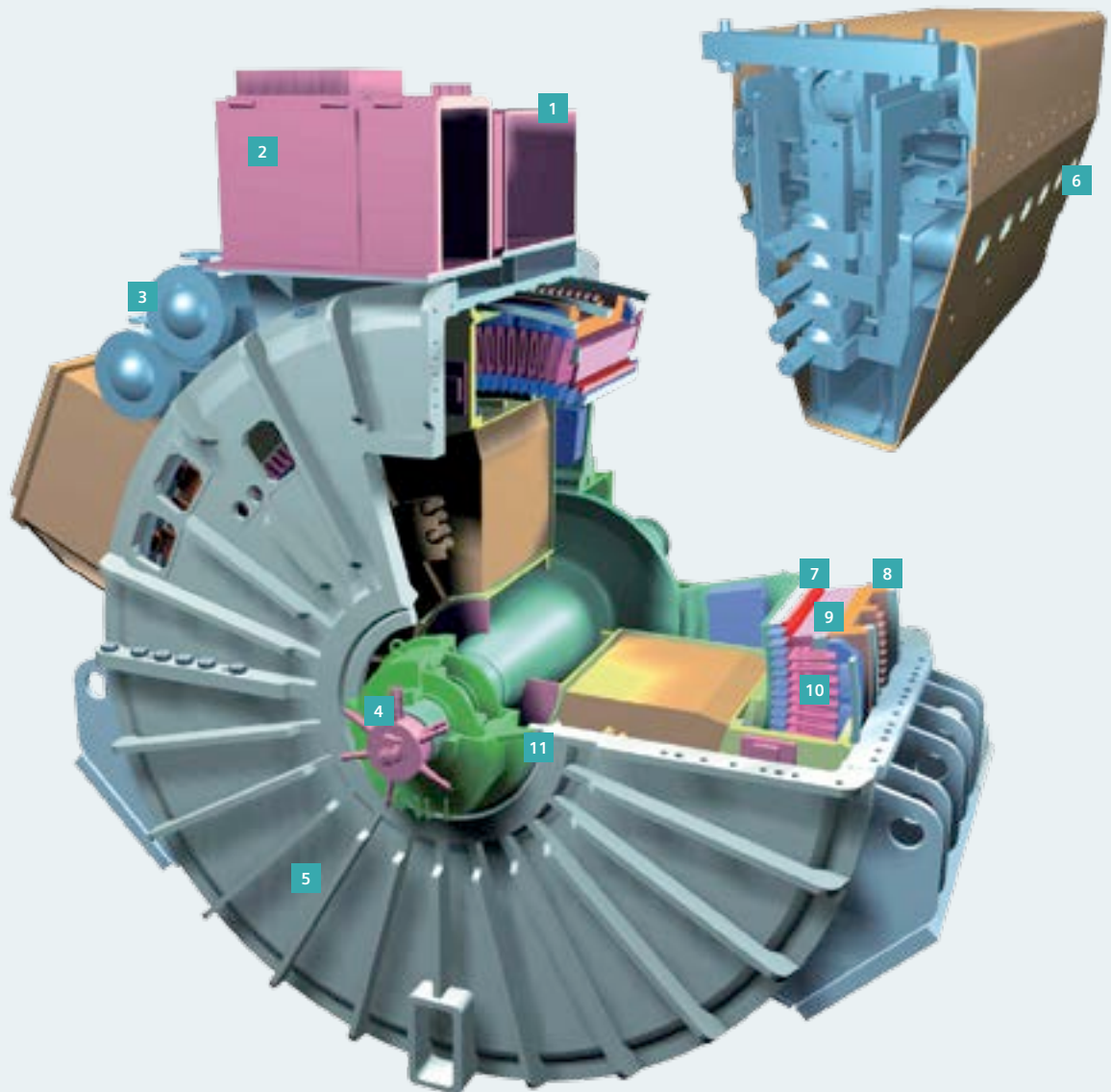

SINAVY PERMASYN Type 212A

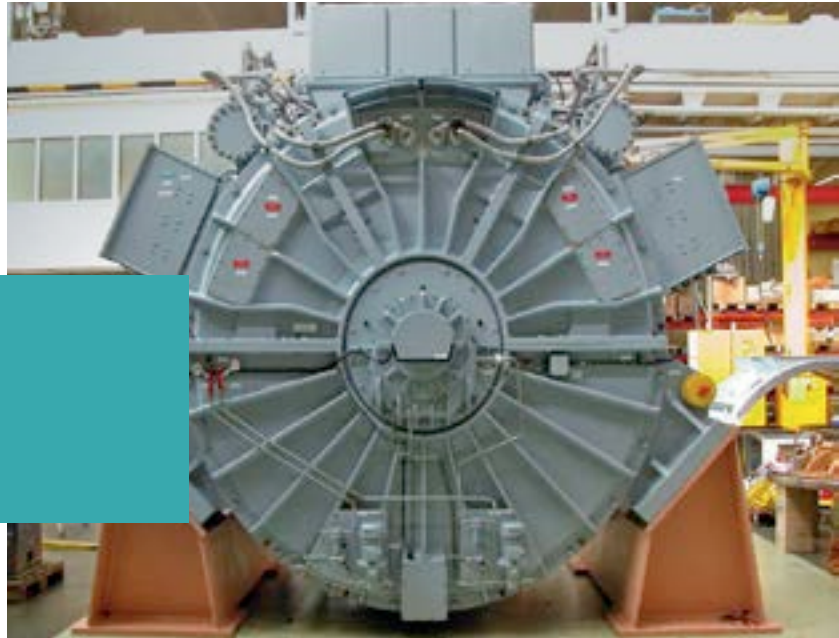

Specifications and technical data

Environmental conditions

The motors are suitable for operation in a salt-laden atmosphere. The following applies to unrestricted operation:

- Ambient temperature in engine room: 0°C to +45°C
- Cooling seawater temperature: max. +32°C
- Continuous air humidity in engine room: max. 80% at 0 to +45°C
- Atmospheric pressure in engine room: continuous 800 to 1,400 mbar, intermittently down to 600 mbar

Inclined positions

| | |
|------------------|----------------------------------|
| Max. heel | ≤ ±15° continuously |
| | ≤ ±45° temporarily (max. 10 min) |

| | |
|------------------|----------------------------------|
| Max. trim | ≤ ±10° continuously |
| | ≤ ±30° temporarily (max. 10 min) |

Motor not in operation

| | |
|-------|-----------|
| Heel | max. ±60° |
| Trims | max. ±60° |

The following applies to transport and storage of the motors (filled with cooling water)

- Ambient temperature: 0°C to +70°C
- Air humidity continuously max. 80%; temporarily almost 100% (max. 1 h, without condensation)

Electrical data

Operating voltage

The motor operates within the voltage range of minimum 300 to max. 560 V DC.

Output power

The motor has an output power of approx. 2 MW.

Overload capacity

The motors can be operated at a torque of 110% of the rated value for a maximum period of 2 min.

Rated speed and direction of rotation, speed changing capability

Rated speed: classified, in the range of usual submarine propeller rotation. The motor speed is infinitely variable and can be varied without barred speed ranges from 0 to 100% of its rated value in both directions of rotation. With respect to the bearing lubrication, a minimum speed of approx. 9 rpm is required for continuous operation. Clockwise rotation is the preferred direction of rotation.

Stator winding and inverter system

The stator winding is constructed with 12 phases. They are insulated according to temperature class F of EN 60034. The inverter system is equipped with IGBT modules.

Behavior upon system short circuit

The series transistor module at the input of all inverters is provided with a control unit which responds to a system short circuit in a few microseconds and blocks the transistor. This prevents the generation of significant reverse currents and suppresses any contribution of the motor to the total system short circuit current.

Control

The motor is provided with control interfaces to the SMC/APC with EMCS, as well as to a manual control panel.

Commissioning

The motor can initially be commissioned by commissioning personnel without the EMCS. The interfaces permit the connection of special test equipment for testing and parameterization purposes, as well as for simulating the control system functions.

SINAVY PERMASYN Type 214

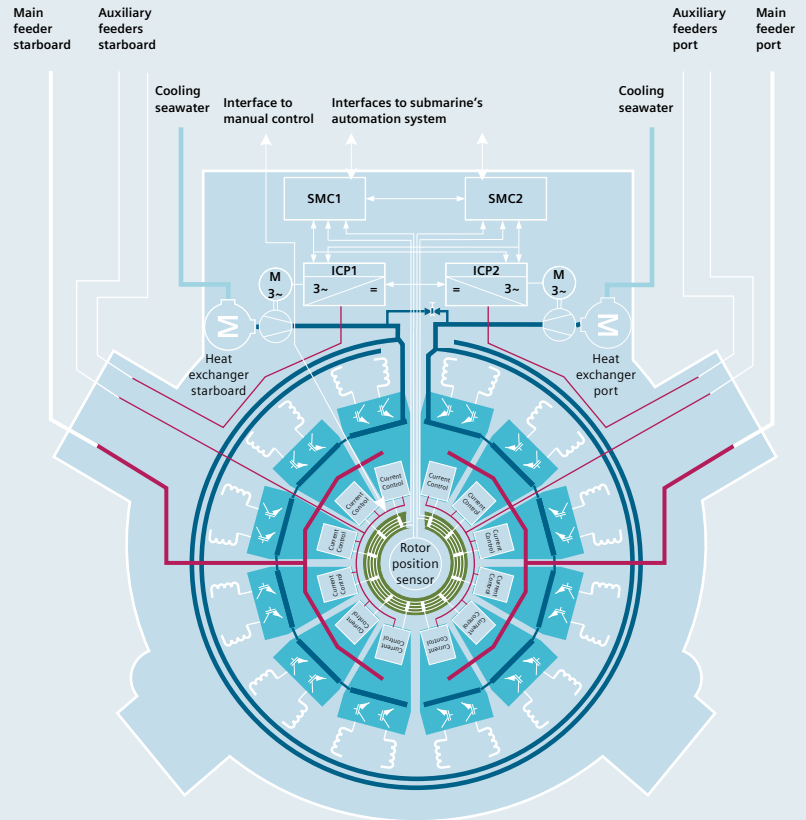

Shock resistance

The motors are designed for the following quasi-static residual shock values:

| | |
|---------------------------|------|
| Vertical and abeam | 10 g |
| Fore and aft | 5 g |

The shock resistance of the motors is calculated to BV 0430 for shock resistance class A/submarines; execution to other shock specifications on request.

Degree of protection to IEC 34, Part 5

The motors including all attachments and top-mounted casings meet at least the degree of protection IP 44, while the terminal boxes and bottom halves of the journal bearings correspond to degree of protection IP 54. The motor is watertight up to a level at the lower bearing housing according to the degree of protection IP 56.

Seawater cooling supply

The exact quantities are specified in the case of an order.

Anti-condensation heating

| | |
|-----------------------|-----------------------|
| Supply voltage | 2 AC 115 V |
| Power | depends on motor type |

Turning

The turning function for inspection and maintenance of the shafting and propeller is performed by the motor itself. For this purpose, the motor must be energized.

Components and materials

Components

Most of the electrical/electronic parts, assemblies, and equipment used in the PERMASYN motor are "Components Of The Shelf" (COTS).

Materials

The normal design of the motor is ferromagnetic. On request, however, the motors can also be supplied in nonmagnetic design. With this special design, only the magnetically active parts, such as the stator core and the rotor pole bodies, are made of ferromagnetic material; the permanent magnets are made of rare earth materials.

SINAVY SUB, references and outlook

Electrical Network and Distribution

Fuel Cell Power Plant System

Propulsion Motor
PERMASYN (PM)

Engineering Monitoring
and Control System (EMCS)

Additional scope of supply
and services

- Training systems LBTS/OBTS
- Various options
- Documentation
- Training

The Siemens Marine & Shipbuilding product portfolio for submarines SINAVY SUB includes

- SINAVY DC-Prop
- SINAVY PERMASYN
- SINAVY SG DC
- SINAVY PEM Fuel Cell
- SINAVY EMCS
- SINAVY OBTS/LBTS
- SINAVY LCM

Depending on the submarine type, several a.m. products are part of the standard scope of supply.

References

Orders have been received for more than 170 SINAVY SUB solutions during the last 55 years, or more than 3 sets of equipment per year. Included in this number are approx. 140 SINAVY DC-Prop drives propelling the boats of 19 navies and more than 30 SINAVY PERMASYN drives propelling the boats of 7 navies, with further contracts to be expected in the near future.

A typical scope of supply and services is shown above related to submarine Type 214.

Innovation/Outlook

Innovation work is continually done on the two existing types of SINAVY PERMASYN. Further studies are being done and development work will start on demand for a third type of SINAVY PERMASYN with an increased output power of approx. 5–6 MW.

SINAVY SUB reference submarines

| | Country | Type | Number of boats |
|--|--------------|--------------------------------------|-----------------|
| Submarines Type 205, 206, 207, and others | Argentina | Submarines 1700 t "Santa Cruz" class | 6 |
| | Denmark | Submarines "Narhvalen" class | 2 |
| | Germany | Submarine "Wilhelm Bauer" | 1 |
| | Germany | Submarines Type 205 | 12 |
| | Germany | Submarines Type 206 | 18 |
| | Israel | Submarines "Gal" class | 3 |
| | Israel | Submarines "Dolphin" class | 3 |
| | Israel | Submarines "DolphinAIP" class | 3 |
| | Italy | Submarines "Toti" class | 4 |
| | Norway | Submarines "Ula" class (Type P6071) | 6 |
| | Norway | Submarines "Kobben" class (Type 207) | 15 |
| | | Total | |
| Submarines Type 209 | Argentina | Submarines "Salta" class | 2 |
| | Brazil | Submarines "Tupi" class | 5 |
| | Chile | Submarines "Thomson" class | 2 |
| | Colombia | Submarines "Pijao" class | 2 |
| | Ecuador | Submarines "Shyri" class | 2 |
| | Egypt | Submarines "class" | 2 |
| | Greece | Submarines "Glafkos" class | 4 |
| | Greece | Submarines "Poseidon" class | 4 |
| | India | Submarines "Shishumar" class | 4 |
| | Indonesia | Submarines "Nanggala" class | 5 |
| | Peru | Submarines "Islay" class | 2 |
| | Peru | Submarines "Casma" class | 4 |
| | South Africa | Submarines "Manthatisi" class | 3 |
| | South Korea | Submarines "Chang Bogo" class | 9 |
| | Turkey | Submarines "Atilay" class | 6 |
| | Turkey | Submarines "Preveze" class | 8 |
| | Venezuela | Submarines "Sabalo" class | 2 |
| | Total | | 66 |
| Submarines equipped/ ordered with PERMASYN drives | Germany | Submarines (Type 212A) | 6 |
| | Italy | Submarines (Type 212A) | 4 |
| | Greece | Submarines (Type 214) | 4 |
| | South Korea | Submarines (Type 214) | 9 |
| | Portugal | Submarines (Type 209PN) | 2 |
| | Turkey | Submarines (Type 214) | 6 |
| | Others | | 2 |
| | | Total | |



Published by
Siemens AG 2016

Process Industries and Drives Division
Marine
Lindenplatz 2
20099 Hamburg, Germany

E-mail: marine@siemens.com
siemens.com/marine

Article No. VRMS-B10017-00-7600

Printed in Germany

Dispo 16600

TH 464-160494 BR 08160.25

Subject to changes and errors.

The information given in this document only contains general descriptions and/or performance features which may not always specifically reflect those described, or which may undergo modification in the course of further development of the products. The requested performance features are binding only when they are expressly agreed upon in the concluded contract.

Photo source: (©) thyssenkrupp Marine Systems