

SIEMENS



Energy Automation

SICAM Q80 Power Quality Recorder

Answers for infrastructure and cities.

Contents – SICAM Q80

	Page
Description, function overview	4/3
Power quality	4/4
Standards	4/10
Measurement points	4/11
Device functions	4/12
System communication and configuration	4/16
SICAM Q80 Manager	4/17
Connection	4/23
Technical data	4/24
Connection diagrams, dimension drawings	4/28
Selection and ordering data	4/29
CE conformity and disclaimer of liability	4/30

Description

Power quality is a complex issue. The voltage quality is affected by all parties connected in the power system: Power utilities of transmission and distribution, power producers and consumers. Inadequate power quality has an adverse effect on the dependability of loads in the power supply system, and can have serious consequences. SICAM Q80 is a compact and powerful recorder designed for utilities and industries to continuously monitor the power quality for regulatory purposes (e.g. evaluation against the standards) as well as event-based recordings for explanatory purposes (e.g. wave shape recording), from the generation plant to the last customer in the electrical supply chain. With SICAM Q80, the quality of the power supply system can be continuously monitored. This can be based on the quality criteria defined in the European electricity supply system quality standard EN 50160 or other assessment criteria. Moreover, data that are above or below the defined threshold values are stored and can thus be used for a meaningful overall analysis. It provides information that allows to see the whole electrical healthy of the power system!

Field of application of SICAM Q80

- Regulatory power quality application: Measurement, comparison, and profiling of power quality parameters at the individual electrical system interfaces: E.g. generation, transmission, subtransmission and distribution systems.
- Explanatory power quality application: Disturbance recording (e.g. waveform capture) support to understand the causes and consequences of power quality problems.

Benefits

- Customer satisfaction: Companies with a suitable power quality monitoring system are proven to be more reliable suppliers and users of energy.
- Asset protection: Early identification of disturbances and active response to them. Comprehensive information for enhancing the visibility and control of assets at the edge of the grid.
- In case of negotiations or disputes, power quality monitoring provides evidences to align interests and to support agreements between parts.
- Quality of supply is in the interests of power utilities, regulators, consumers, and the environment.

Function overview

Measurement of continuous phenomena and disturbances according to the necessary accuracy requirements, as stipulated in IEC 61000-4-15, IEC 61000-4-7 and IEC 61000-4-30 (Class A).



Fig. 4/1 SICAM Q80 Power Quality Recorder

Recording and evaluation

- Voltage frequency: Frequency deviation
- Slow voltage variation: Detection and monitoring of supply interruption
- Rapid voltage variations: Voltage dips, voltage swells, rapid voltage changes and voltage fluctuations (flicker)
- Power line signaling superimposed on the supply voltage
- Voltage waveshape: Harmonics (up to the 50th harmonic) and up to 10 interharmonics
- Flexible value limit violation parameterisation and event definition for voltage, current, power etc.
- Fault recording triggered by waveform and binary values
- Comparison and reporting of power quality profile according to EN 50160 newest Version or local standards
- Transients recording till 17 microseconds for 60 Hz and 20 microseconds in 50 Hz networks.

Products – SICAM Q80

Description, function overview, power quality

Features

- Suitable for monitoring single-phase, 3- and 4-wire power systems (up to 1000 V_{rms})
- 4 voltage, 4 current, or 8 voltage measuring channels
- Standard: 4 binary inputs, 4 binary outputs
- Sampling rate 10 kHz for network analysis (50kHz for transient function)
- Measurement accuracy 0.1 % of the range
- High local storage capability: Removable compact flash (standard delivery 2 GB)
- Enhanced data compression process (power quality data)
- Automatic data transfer
- Automatic comparison and reporting of the power quality profile according to EN 50160 or local standards
- Automatic notification in case of a fault or violations by e-mail, SMS, and fax
- Export functions
- Ethernet and modem communication interfaces for parameterization, remote monitoring, and polling
- GPS / DCF-77 / IIRIG-B and NTP for synchronization
- Network trigger system
- Simple operation, compact and robust design
- Password protection
- MODBUS TCP with till 3 clients access
- Enhanced monitoring function for binary alarming, individual harmonics recognition and voltage events, as voltage dips
- Complete voltage quality view and recording of in 4 wire connections in phase-neutral and phase-phase values for a flexible analyses of impact of events on primary and secondary systems sides.

Supply quality

Quality is generally recognized as an important aspect of any electricity supply service. Customers care about high quality just as much as low prices. Price and quality are complementary. Together, they define the value that customers derive from the electrical supply service. The quality of the electricity supply provided to final customers results from a range of quality factors, for which different sectors of the electricity industry are responsible. Quality of service in the electrical supply has a number of different dimensions, which can be grouped under three general headings: Commercial relationships between a supplier and a user, continuity of supply, and voltage quality. To avoid the high cost of equipment failures, all customers must make sure that they obtain an electricity supply of satisfactory quality, and that their electrical equipment is capable of functioning as required even when small disturbances occur. In practice, the voltage can never be perfect. Electrical supply is one of the most essential basic services supporting an industrial society. Electricity consumers require this basic service:

- To be available all the time (i.e. a high level of reliability)
- To enable all consumers' electrical equipment to work safely and satisfactorily (i.e. a high level of power quality).

4

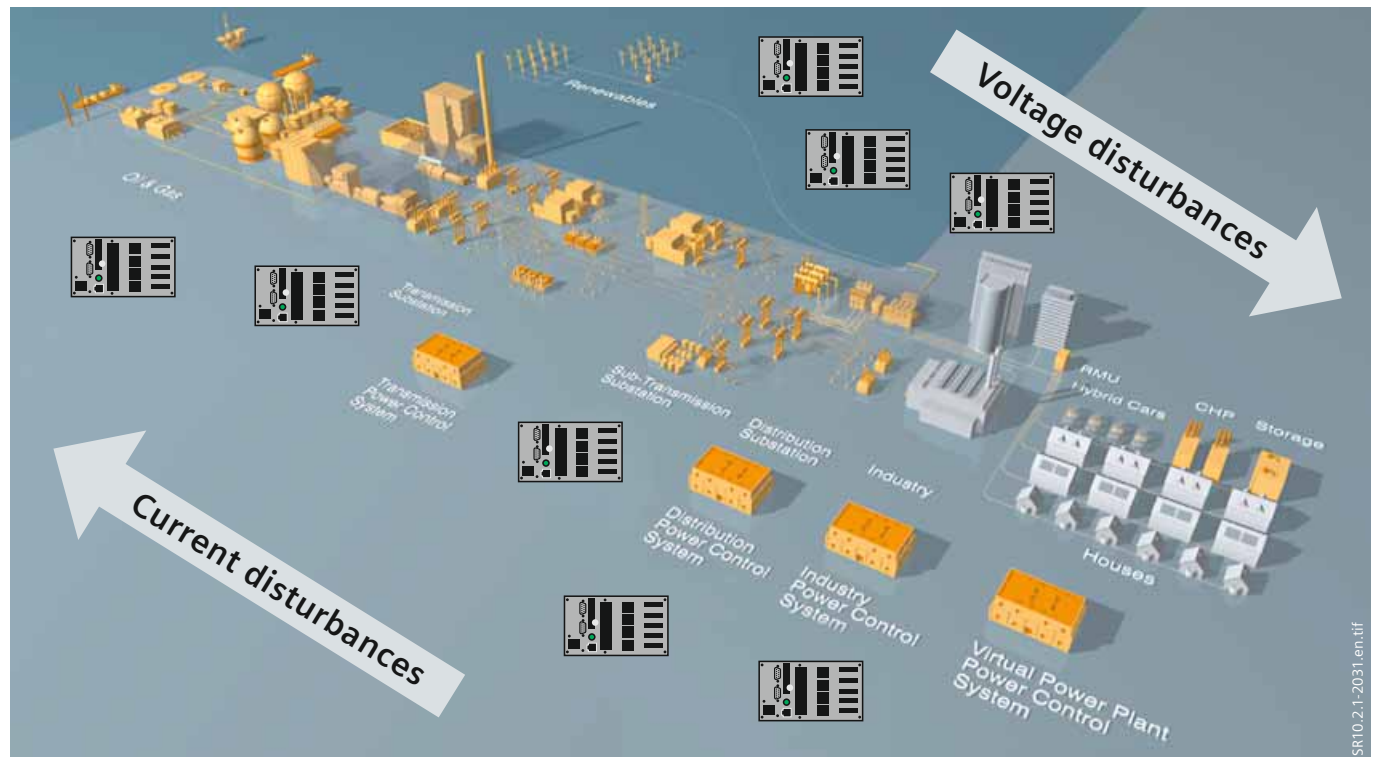


Fig. 4/2 Power quality monitoring provides value to everyone – to the local utility, to the consumer, to the local economy and to the environment

Voltage quality

Voltage quality, also termed power quality (PQ), covers a variety of characteristics in a power system. Chief among these is the quality of the voltage waveform. There are several technical standards defining voltage quality criteria, but ultimately quality is determined by the ability of customers' equipment to perform properly. The relevant technical phenomena are: Variations in frequency, fluctuations in voltage magnitude, short-duration voltage variations (dips, swells, and short interruptions), long-duration voltage variations (overvoltages or undervoltages), transients (temporarily transient overvoltages), waveform distortion, etc. In many countries, voltage quality is regulated to some extent, often using industry-wide accepted standards or practices to provide indicative levels of performance. Everybody is now aware of the effects of poor power quality, but few really have it under control. The levels of power quality disturbances need to be monitored weekly, sometimes even daily, in order to trigger appropriate remedial measures before severe consequences occur. The power utility therefore has an interest in monitoring the power quality, showing that it is acting correctly and improving its know-how about the system. This ensures customer satisfaction by providing electricity with quality and reliability.

The availability and quality of power is of even greater concern to distribution companies. The liberalization of the electricity market has put them in the uncomfortable position of being affected by other players' actions. This situation has been stabilizing and power quality is becoming a top priority issue in the restructuring process. With increasing customer awareness of energy efficiency, it is clear that the quality of supply will be receiving much attention. Most power quality problems directly concern the end user, or are experienced at this level. End users have to measure the power quality and invest in local mitigation facilities. However, consumers often turn to the utility company, instead, and exert pressure to obtain the required supply quality.

The EN 50160 power quality standard describes the main characteristics of the voltage at the customer's supply terminals in public low, medium, and high-voltage systems, under normal operating conditions.

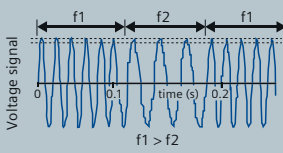
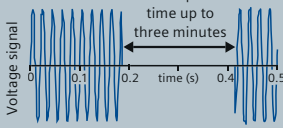
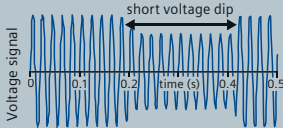
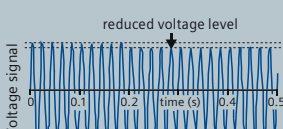
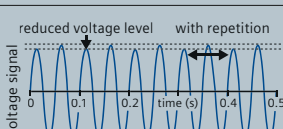
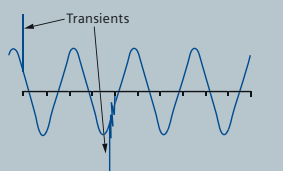
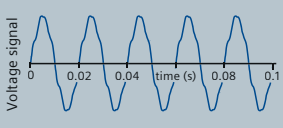
Problem	Description	Cause	Effect
 <p>SR10.2.1-2032.en.ai</p>	<p>Frequency distortions: A frequency variation involves variation in frequency above or below the normally stable utility frequency of 50 or 60 Hz</p>	<ul style="list-style-type: none"> Start-up or shutdown of very large item of consumer equipment, e.g. motor Loading and unloading of generator or small co-generation sites Unstable frequency power sources 	<ul style="list-style-type: none"> Misoperation, data loss, system crashes and damage to equipment and motor For certain kinds of motor load, such as in textile mills, tight control of frequency is essential
 <p>SR10.2.1-2033.en.ai</p>	<p>Supply interruption: Planned or accidental total loss of power in a specific area, short interruptions lasting from a half second to 3 minutes and long interruptions lasting longer than 3 minutes</p>	<ul style="list-style-type: none"> Switching operations attempting to isolate an electrical problem and maintain power to the area concerned Accidents, acts of nature, etc. Fuses, actions by a protection function, e.g. automatic recloser cycle 	<ul style="list-style-type: none"> Sensible processes and system shutdown or damages Loss of computer/controller memory Production losses or damage
 <p>SR10.2.1-2034.en.ai</p>	<p>Voltage dip/sag or swell: Any short-term (half cycle to 60 seconds) decrease (sag) or increase (swell) in voltage</p>	<ul style="list-style-type: none"> Start-up or shutdown of very large item of consumer equipment, e.g. motor Short circuits (faults) Underdimensioned electrical circuit Utility equipment failure or utility switching 	<ul style="list-style-type: none"> Memory loss, data errors, dim or bright lights, shrinking display screens, equipment shutdown Motors stalling or stopping and decreased motor life
 <p>SR10.2.1-2035.en.ai</p>	<p>Supply voltage variations: Variation in the voltage level above or below the nominal voltage under normal operating conditions</p>	<ul style="list-style-type: none"> The line voltage amplitude may change due to normal changing load situations 	<ul style="list-style-type: none"> Equipment shutdown by tripping due to undervoltage or even overheating and/or damage to equipment due to overvoltage Reduced efficiency or life of electrical equipment
 <p>SR10.2.1-2036.en.ai</p>	<p>Rapid voltage variations/ flicker: Impression of unsteadiness of visual sensation induced by a light stimulus, the luminance or spectral distribution of which fluctuates with time</p>	<ul style="list-style-type: none"> Intermittent loads Motor starting Arc furnaces Welding plants 	<ul style="list-style-type: none"> Changes in the luminance of lamps can result in the visual phenomenon called flicker on people, disturbing concentration, causing headaches, etc.
 <p>SR10.2.1-2037.en.ai</p>	<p>Transient: A transient is a sudden change in voltage up to several thousand volts. It may be of the impulsive or oscillatory type (also termed impulse, surge, or spike)</p> <p>Notch: This is a disturbance of opposite polarity from the waveform</p>	<ul style="list-style-type: none"> Utility switching operations, starting and stopping heavy equipment, elevators, welding equipment static discharges, and lightning 	<ul style="list-style-type: none"> Processing errors Data loss Lock-up of sensitive equipment Burned circuit boards
 <p>SR10.2.1-2038.en.ai</p>	<p>Noise: This is an unwanted electrical signal of high frequency from other equipment</p> <p>Harmonic: Distortion is alteration of the pure sine wave due to non-linear loads on the power supply</p>	<ul style="list-style-type: none"> Noise is caused by electromagnetic interference from appliances, e.g. microwave, radio and TV broadcasts, arc welding, loose wiring, or improper grounding Harmonic distortion is caused by non-linear loads 	<ul style="list-style-type: none"> Noise interferes with sensitive electronic equipment It can cause processing errors and data loss Harmonic distortion causes motors, transformers, and wiring to overheat Improper operation of breakers, relays, or fuses

Table 4/1 Main problems with power quality

Who is responsible?

An interesting problem arises when the market fails to offer products that meet the customer's power quality needs. If a customer cannot find equipment that is designed to tolerate momentary power interruptions, the customer may, for example, pressure the power supplier and the regulator to increase the power quality of the overall distribution system. It may be in the supplier's interest to help the customer address the power quality and reliability problem locally. The electrical supply system can be considered a sort of open-access resource: In practice, almost everybody is connected to it and can "freely" feed into it. This freedom is now limited by standards, and/or agreements.

In European countries, the EN 50160 European standard is generally used as a basis for the voltage quality. There is currently no standard for the current quality at the point of common coupling (PCC), but only for equipment. The interaction between the voltage and current makes it hard to draw a line between the customer as "receiving" and the network company as "supplying" a certain level of power quality. The voltage quality (for which the network is often considered responsible) and the current quality (for which the customer is often considered responsible) affect each other in mutual interaction.

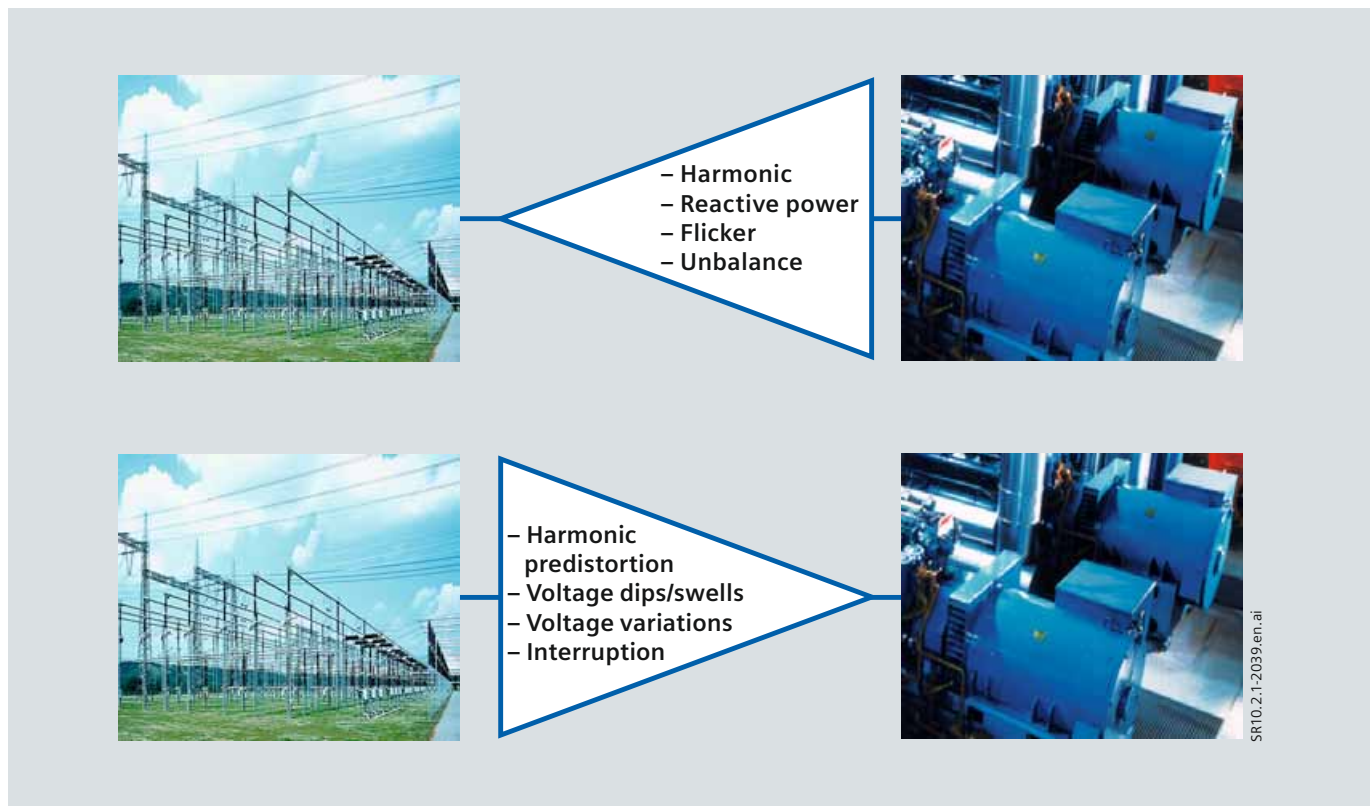


Fig. 4/3 Utility and industries, both are responsible for voltage quality

Products – SICAM Q80

Power quality

Power quality monitoring applications

One of the keys to the success of profiling and defining the power quality system is understanding the applications. The following table suggests two applications based on gathering power quality data.

Regulatory application for continuous analysis and explanatory application for detailed data for event evaluation proposals.

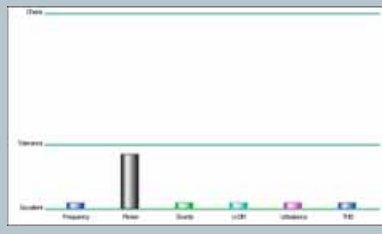
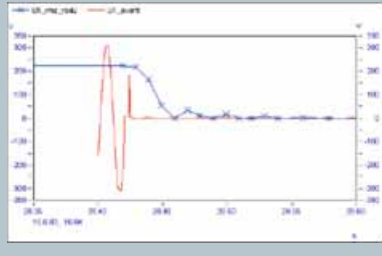
PQ application	Description	Hardware	Measurements	
Regulatory power quality:	Regulative PQ analysis approaches the comparison of the quality of voltage or power with recognized standards (e.g. EN 50160) or with the quality defined in power supply contracts. Periodically produces compliance reports.	Power Quality Recorders (Class A or S)	Voltage quality parameters (at least) at selected system interfaces and customer supply points (e.g. EN 50160) for: Power system performance, planning levels (i.e. internal objectives), specific customer contracts	 <small>SR10.z.1-2040.de.tif</small>
Explanatory power quality:	Explanatory PQ analysis to provide an understanding of what is going on in particular cases, such as fault analysis, to support the wider aspects of system stability. It is a process that aims to document selected, observed power quality and maximize the level of understanding, possibly including knowledge of the cause and consequences and possible mitigation of power quality problems.	Power Quality Recorders Class Class A or S and fault recorder/ PMU	$V+I_{rms}$, waveforms, status of binaries, power swing, MV transformers, busbars and loads	 <small>SR10.z.1-2040.de.tif</small>

Table 4/2 Power quality applications

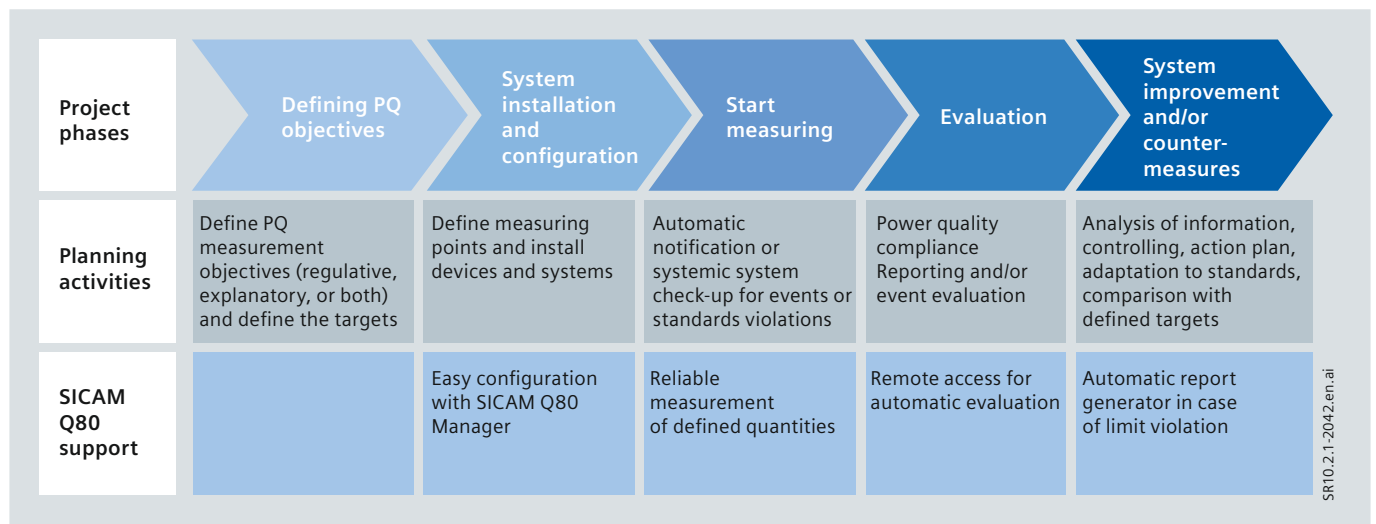


Fig. 4/4 Power quality recording in five steps

Standards and specifications

The purpose of power quality indexes and measurement objectives is to characterize power system disturbance levels. Such indexes may be defined as “voltage characteristics” and may be stipulated in a grid code that applies to electrical system interfaces. Power quality grid codes make use of existing standards or guidelines defining voltage and current indexes to be applied to interfaces in low, medium, or high-voltage systems, for example, EN 50160. This standard defines and describes the main characteristics of the voltage at the customer’s supply terminals in public LV and MV electricity distribution systems. Indexes for HV-EHV will also be described in the new edition of EN 50160, planned to be released in 2011.

Since electrical systems among regions and countries are different, there are also many other regional or national recommendations, defining specific or adapted limit values. These local standards are normally the result of practical voltage quality measurement campaigns or the system experience, which are mostly acquired through a permanent and deep electrical system behavior know-how.

Measuring according to EN 50160 is, however, only part of the power quality measurement process. Another important standard for power quality measurement is IEC 61000-4-30, that defines the measurement methodology. From IEC 61000-4-30, also accuracy classes, Class A “higher accuracy” and Class S “lower accuracy”, are derived. In other words, in a simple way, if EN 50160 defines “what” to measure, IEC 61000-430 defines “how” to measure it. The end result of a measurement process is expected to be a fully automated, standard compliant documentation of all measurements.

Calculation of r.m.s. values after every half period is the touchstone of an IEC 61000-4-30 Class A measurement device. To define the range of normal voltage states, a hysteresis range is specified for event detection. SICAM Q80 meets the precision requirements for a Class A measurement device according to the IEC 61000-4-30 standard.

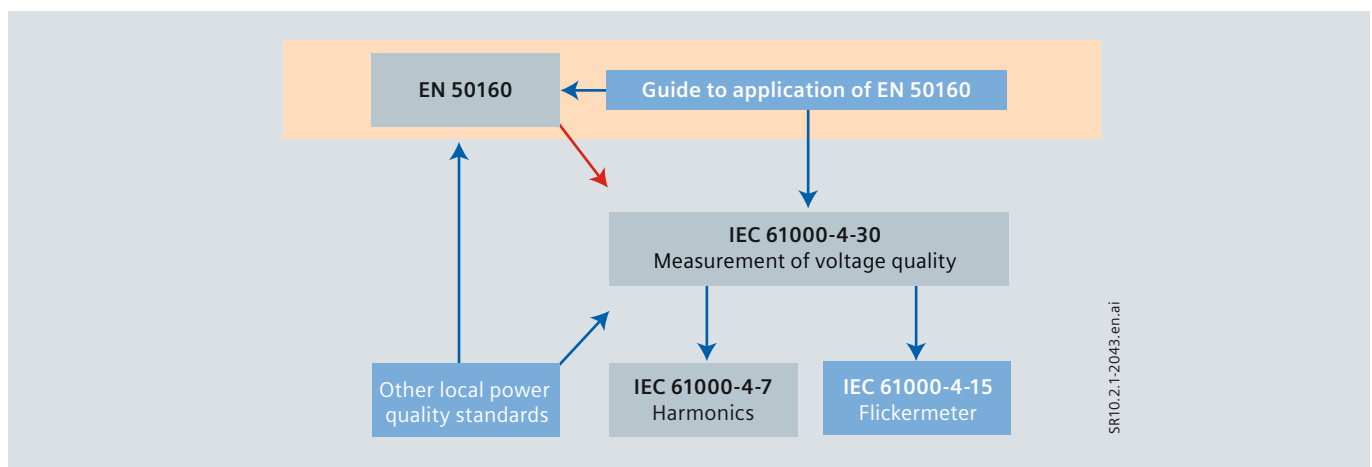


Fig. 4/5 Overview of international and national standards for power quality

Parameter	Supply voltage characteristics
Power frequency	LV, MV: Mean value of fundamental measured over 10 s $\pm 1\%$ (49.5 – 50.5 Hz) for 99.5 % of week – 6 % / + 4 % (47 – 52 Hz) for 100 % of week
Voltage magnitude variations	LV, MV: $\pm 10\%$ for 95 % of week, mean 10 minutes r.m.s. values (Fig. 6)
Rapid voltage changes	LV: 5 % normal 10 % infrequently $Plt \leq 1$ for 95 % of week MV: 4 % normal 6 % infrequently $Plt \leq 1$ for 95 % of week
Supply voltage dips	Majority: Duration < 1 s, depth < 60 %. Locally limited dips caused by load switching on: LV: 10 – 50 %, MV: 10 – 15 %
Short interruptions of supply voltage	LV, MV: (up to 3 minutes) few tens – few hundreds/year, duration 70 % of them < 1 s
Long interruption of supply voltage	LV, MV: (longer than 3 minutes) < 10 – 50/year
Temporary power frequency overvoltages	LV: < 1.5 kV r.m.s. MV: 1.7 V_C (solid or impedance earth), 2.0 V_C (unearthed or resonant earth)
Transient overvoltages	LV: Generally < 6 kV, occasionally higher; rise time: μ s to ms, MV: Not defined
Supply voltage unbalance	LV, MV: Up to 2 % for 95 % of week, mean 10 minutes r.m.s. values, up to 3 % in some locations
Harmonic voltage/THD	Harmonics LV, MV; THD
Interharmonic voltage	LV, MV: Under consideration

Table 4/3 Overview of EN 50160 parameters as well as some supply voltage characteristics and indicative values

Products – SICAM Q80

Standards

Standards

IEC 61000-4-30, Ed. 2, 2008-10

Power Quality Measurement Methods: This standard defines the methods for measurement and interpretation of results for power quality parameters in AC supply systems.

IEC 61000-4-15:1997 + A1:2003

Flickermeter, Functional and Design Specifications: This section of IEC 61000 provides a functional and design specification for flicker measuring apparatus intended to indicate the correct flicker perception level for all practical voltage fluctuation waveforms.

IEC 61000-4-7, Ed. 2, 2002-08

General Guide on Harmonics and Interharmonics: This is a general guide on harmonics and interharmonics measurements and instrumentation, for power supply systems and equipment connected thereto.

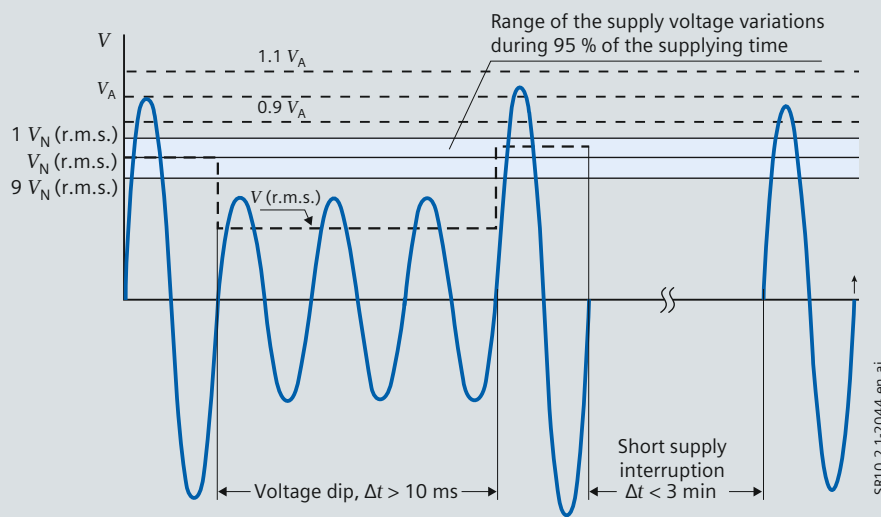


Fig. 4/6 Illustration of a voltage dip and a short supply interruption, classified according to EN 50160; V_N – nominal voltage of the supply system (r.m.s.), V_A – amplitude of the supply voltage, V (r.m.s.) – the actual r.m.s. value of the supply voltage

Odd harmonics				Even harmonics	
Not multiples of 3		Multiples of 3		Order h	Relative voltage (%)
Order h	Relative voltage (%)	Order h	Relative voltage (%)		
5	6	3	5	2	2
7	5	9	1.5	4	1
11	3.5	15	0.5	6 ... 24	0.5
13	3	21	0.5		
17	2				
19	1.5				
23	1.5				
25	1.5				

Table 4/4 Values of individual harmonic voltages at the supply terminals for orders up to 25, given in percent of V_N

Definition of a measurement point and power quality measurement objectives

Power quality measurements address the aspect of power performance by describing the quality of every individual interface in an electrical system and in the networks of its various customers. Identifying, defining, profiling the power quality measurement points are essential tasks in defining a power quality project. However, the electrical system is dynamic by nature, so optimizing the measurement points is a routine that is developed by day-to-day learning. This may not help predict changes, but will permit a more effective response to them.

Identification of measurement points

Measurement points may be located and defined as shown in table 4/5.

Measuring power quality requires not only an effective choice of measurement points, but also defined objectives for the PQ analysis at the measurement points.

We generally classify “power quality” monitoring as a mixture of data gathering technologies classified by their purpose or application.

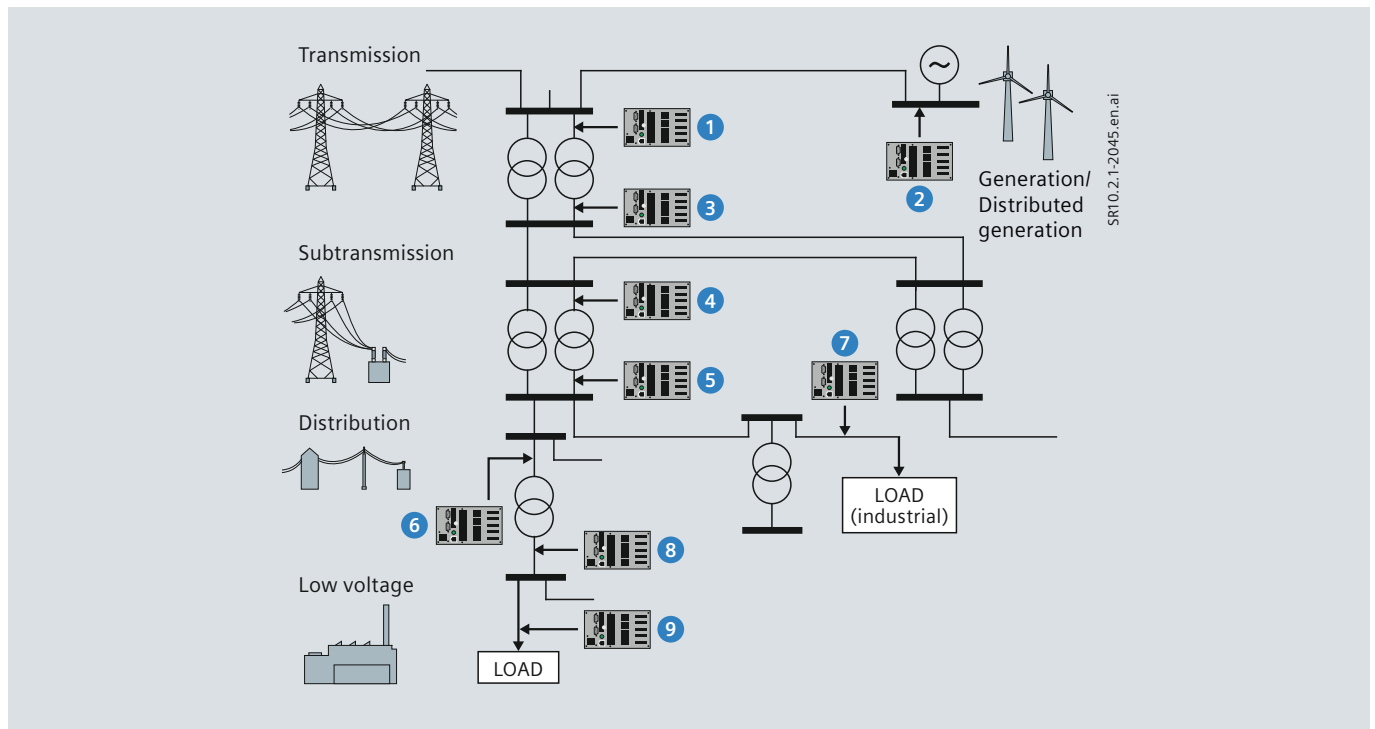


Fig. 4/7 General system online diagram

No.	Measurement points	Location
1	Transmission feeder (line or transformer)	Possibly busbar
2	Generation station/distributed generation	Busbar, transformer or generator connection
3	Subtransmission, line supply	Busbar (e.g. where the busbar is owned and operated by the transmission company)
4	Subtransmission feeder (line or transformer)	Remote line terminals (e.g. where the lines are owned and operated by the transmission company)
5	Distribution, line supply	Transformer secondary side or cable to neighbor's substation
6	Distribution feeder (line or transformer)	Step-down transformers
7	Distribution load	Step-down transformers (e.g. where the transformers are owned by the distribution company)
8	LV supply	Transformer of the distribution company
9	LV load	Load or transformer at the customer

Table 4/5 Measurement points and system location

Products – SICAM Q80

Device functions

Functions

SICAM Q80 implements the “complete recording” measurement philosophy. This means that all measured quantities are available for subsequent analysis even after the comparison with standards. This ensures that events that do not reach the defined thresholds but may still contain useful data can still be analyzed.

The “complete recording” principle provides the option of performing more extensive data processing than the completed EN-based measurement, meaning that SICAM Q80 has a far wider functional scope than that defined in the EN 50160 standards.

Continuous monitoring

The r.m.s. values for current and voltage are calculated every half cycle (10 ms/50 Hz or 8.33 ms at 60 Hz) and using algorithms, as described in the IEC 61000-4-30 standard.

Fast changes in the r.m.s. value of voltage and the current are recorded as plot curves (see Fig. 4/9). This is done using a patented data reduction method. Within the tolerance range of a $\pm 5\%$ deviation from the measuring range, data reduction works with 1.5% accuracy by default, while outside the tolerance range, twice the precision, namely 0.75%, is used. These values can be parameterized in the software. The method is defined and parameterized to achieve a reduction factor of down to 1:20,000 without loss of relevant information, such as voltage dips, despite the fact that recording is continuous.

The advantage is that no thresholds have to be adjusted and there is no loss of information.



Fig. 4/8 SICAM Q80 Power Quality Recorder

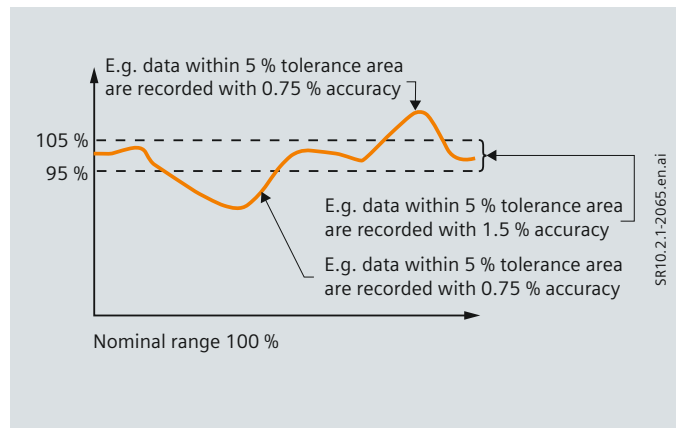


Fig. 4/9 Example of the the compression algorithm for continuous recording, e.g. for 5% of the measurement range

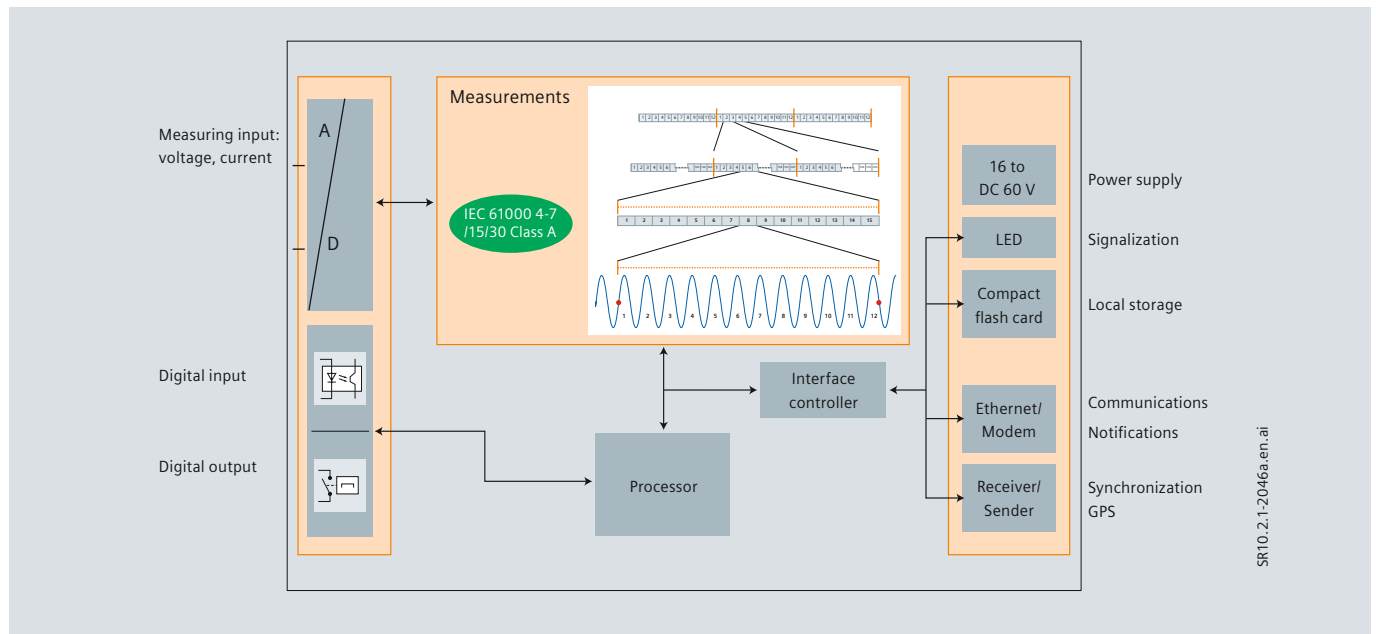


Fig. 4/10 Block diagram for data recording and online processing of SICAM Q80

Recording of events

The plots of the r.m.s. value curves are the basis for capturing events. A deviation of the r.m.s. in one direction results in a new data point in the reduced curves; an event is characterized and bounded by two transitions: One from the normal to the faulty voltage level and one from the faulty level back to the normal level. The normal-to-fault and back-to-normal transitions are defined as a standard \pm difference from a definable hysteresis voltage. The duration of the event is measured between the two transitions. The depth of the result is determined from the minimum or maximum of the amplitude in the region affected by the fault. This assumes that the amplitude remains almost constant during the fault. According to the currently valid standard, every deviation $> 10\%$ of the nominal voltage counts as an event. Depending on the duration and amplitude, further distinctions are made into dips and short/long interruptions.

Harmonics and interharmonics

The frequencies in the voltage, current, and therefore also in the power, are calculated by means of Fast Fourier Transform (FFT). The FFT is calculated seamlessly with a square window over each group of 10 periods. This corresponds to the specifications for measuring harmonics and interharmonics in power supply networks defined in EN 61000-4-7.

Flicker

Low-frequency amplitude fluctuations in the network, in turn, cause the luminous density in lamps to fluctuate. This is perceptible as flickering. Above a certain threshold of perceptibility, this is considered a nuisance. Such fluctuations can be measured using a flickermeter. The flicker is calculated with a sampling rate of 100 Hz according to the description of a flickermeter in the EN 61000-4-15 standard.

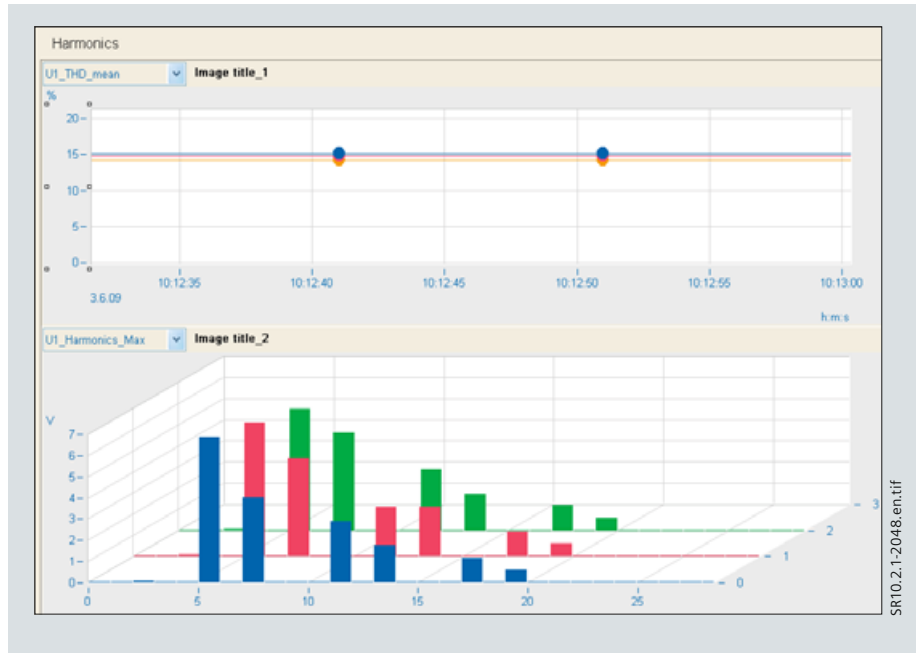


Fig. 4/11 Harmonics overview

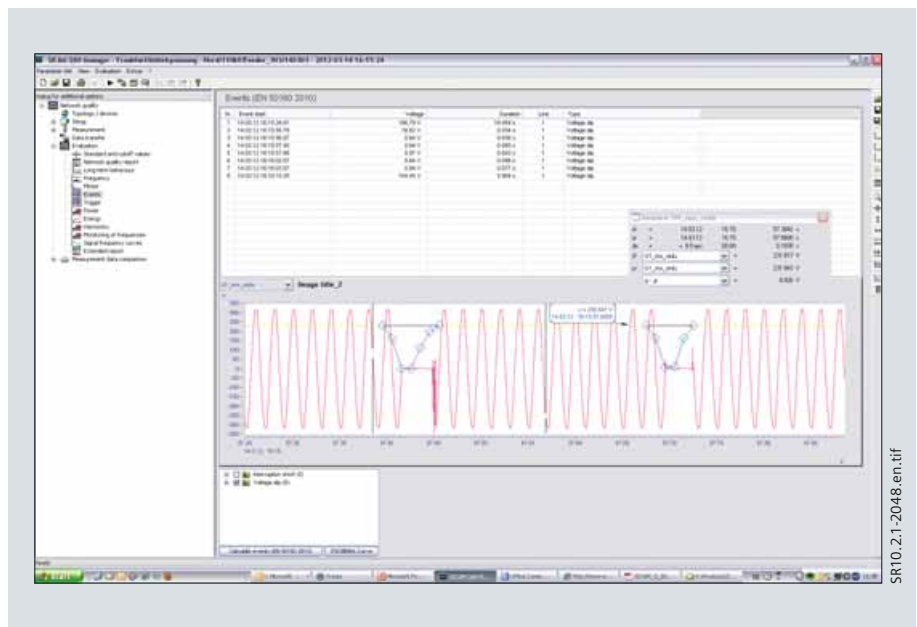


Fig. 4/12 Event Recording – Voltage Dip

Products – SICAM Q80

Device functions

Triggers

Along with the conventional trigger mechanisms, responding to signals exceeding settable cutoff values, it is also possible to set triggering conditions depending on the signal deviating significantly from the expected waveform. For example, any sudden signal deviations occurring during long-term monitoring due to harmonics or brief voltage fluctuations (spikes) can be captured even if the magnitude of the deviation is much smaller than the nominal value itself.

The recording duration after and before an occurrence of a trigger event is configurable. The recording time is from 10 ms to 60 s and pre-trigger 100 ms to 30 s. Unlike in normal recording, triggered raw data recording uses a time resolution of 100 μ s. There is also a trigger for signal frequencies. In this case, the input signal is band-pass-filtered before triggering. This enables visualization of the signal, whose amplitude is modulated over a signal frequency. The classic application for this are ripple control telegrams. Triggers responding to external binaries are also possible.

Ethernet trigger

SICAM Q80 can also send triggers over the Ethernet to other SICAM Q80 devices. These are termed network triggers. The other SICAM Q80 devices in the network receive this message and respond accordingly, so that an event or a disturbance at one network node results in instantaneous measured values at all other network nodes. This enables simultaneous analysis of the effect of this disturbance on the complete network.

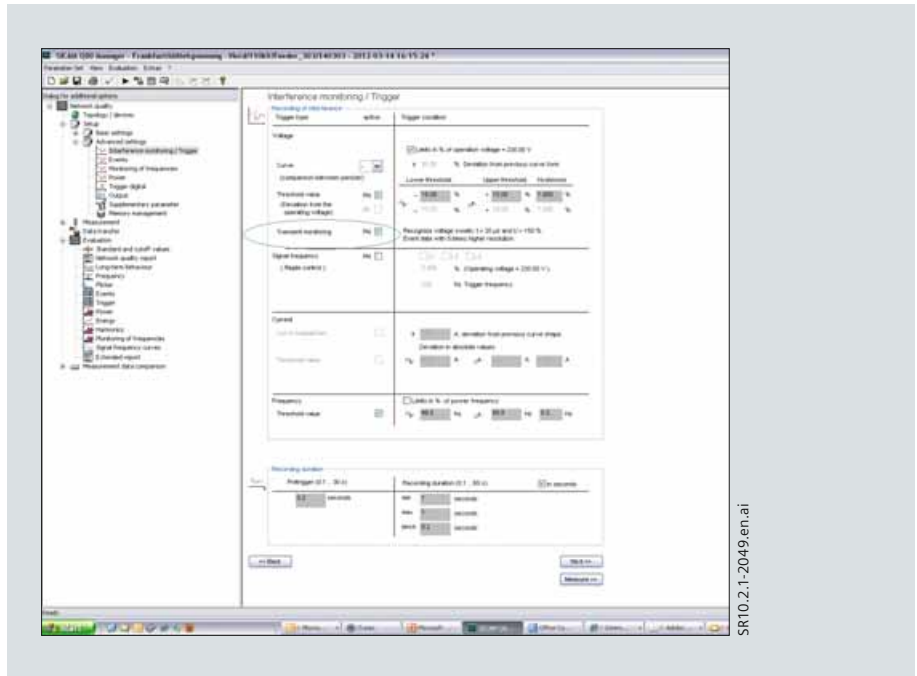


Fig. 4/13 Trigger and transient parameterization

Trigger type	Condition parameterization
Voltage and current	Curve comparison, threshold
Main signaling frequency (ripple control)	% of voltage, frequency, recording duration
Frequency (threshold value)	Limits in % of power frequency
Digital trigger	Transitions \rightarrow 0 to 1 or 1 to 0

Table 4/6 Trigger type and parameterization conditions

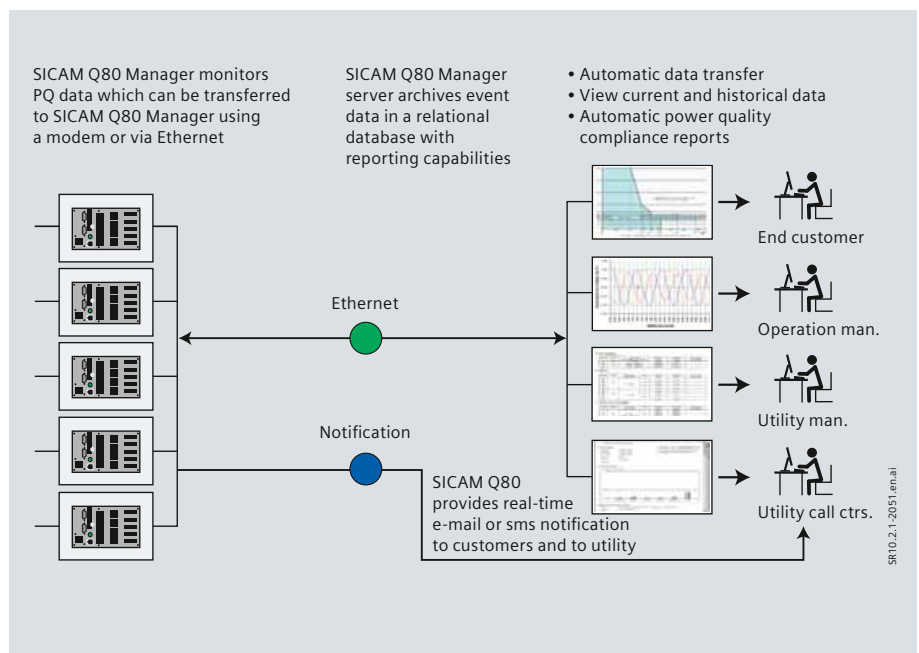


Fig. 4/14 SICAM Q80 – system overview

Notifications

SICAM Q80 supports the automatic transmission of notifications and messages in response to specific events. Such events may include voltage disturbances, lack of available storage space, or cyclic notification. One recipient can be defined for each message. The message types that can be chosen are e-mail, SMS, fax, or any combinations of these.

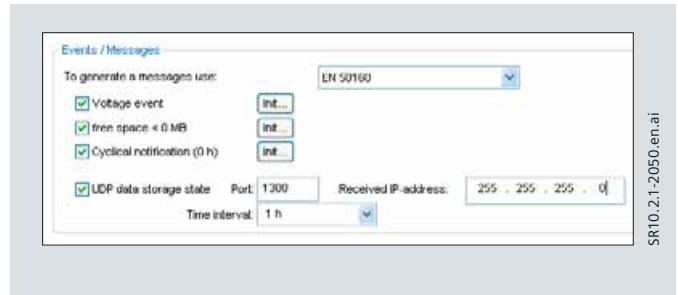


Fig. 4/15 Notification configuration

Internal memory capacity

The available storage medium is a compact flash card hard drive with a standard capacity of 2 GB. Optionally, compact flash cards can be used with capacities up to 16 GB. Intelligent memory management and effective data reduction enable storage of up to 130 weeks' (2.5 years) worth of data, in compliance with EN 50160.



Fig. 4/16 Standard supply: 2 GB CF card
(can be upgraded to 16 GB)

Products – SICAM Q80

System communication and configuration

System communication and configuration

SICAM Q80 units are installed at various points to record electrical quantities in order to analyze power quality or event recording. Different connection methods or system configurations are possible, depending on the application and existing infrastructure.

TCP/IP communications for flexible network configurations

The networking of single devices enables central parameter setting and administration as well as a complete, accurately timed recording of events and disturbances of all systems defined in the network.

Time synchronization

SICAM Q80 can be synchronized by Network Time Protocol (NTP), IRIG-B, DCF-77 and GPS real-time clock for absolute time synchronization. It is also possible to synchronize multiple SICAM Q80 devices even without a GPS real-time clock, and to plot their respective data jointly in the correct chronological relationship.

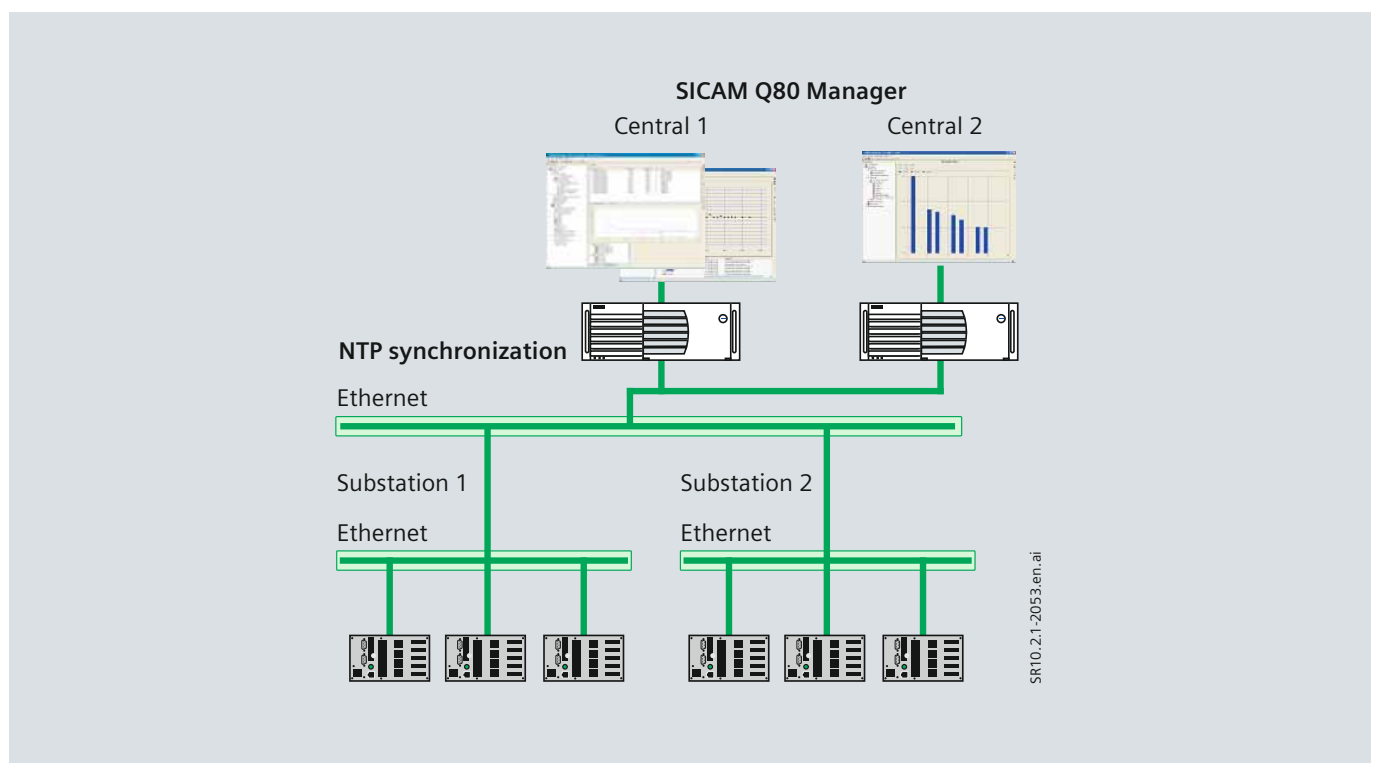


Fig. 4/17 Flexible networks with TCP/IP protocol for communications and synchronization

SICAM Q80 Manager

The SICAM Q80 Manager is a complete software tool for parameterization, system overview, evaluations and automatic analyses; it allows the analysis of more than 500 data sets from the SICAM Q80 Power Quality Recorder. It covers the whole chain of power quality analysis from measurement to the provision of important information, enabling remedial measures to be taken to improve power quality.

The SICAM Q80 Manager PC software enables user-friendly operation. Setting and other operations are performed in an intuitive manner. Despite the large number of functions available, the user interface is clearly organized, in a tree structure similar to the familiar Microsoft Explorer® tree structure. SICAM Q80 Manager runs under Microsoft Windows 2000, XP, Vista or Windows 7.

For operation and analysis by the user, the SICAM Q80 Manager software enables central parameter setting of all devices without any special PC knowledge. The SICAM Q80 Manager software is designed to guarantee easy handling of the applications. Conducting measurement according to industry standards requires no special instrumentation or computer skills. Its function and appearance resembles the familiar Windows-Explorer. The standard software module includes all functions necessary for operation, display, analysis and documentation.

Measurement system overview

A topology structure can be created in SICAM Q80 Manager, so that the user can have a clear measurement system structure, with regions, station, voltage level, measurement location and device name information. For each device, the measurement status is reported, so that the last measurement time information is available.

Defining your own grid code with user-friendly advanced settings

The process of setting up measurements, data analysis and documentation is streamlined. In SICAM Q80, the EN 50160 measurements are predefined and require only very few additional settings, so SICAM Q80 is easy to use even for operators without any special know-how or training. However, the user can freely define and save special measurements, value limits, analyses and documentation to be reused later if needed.

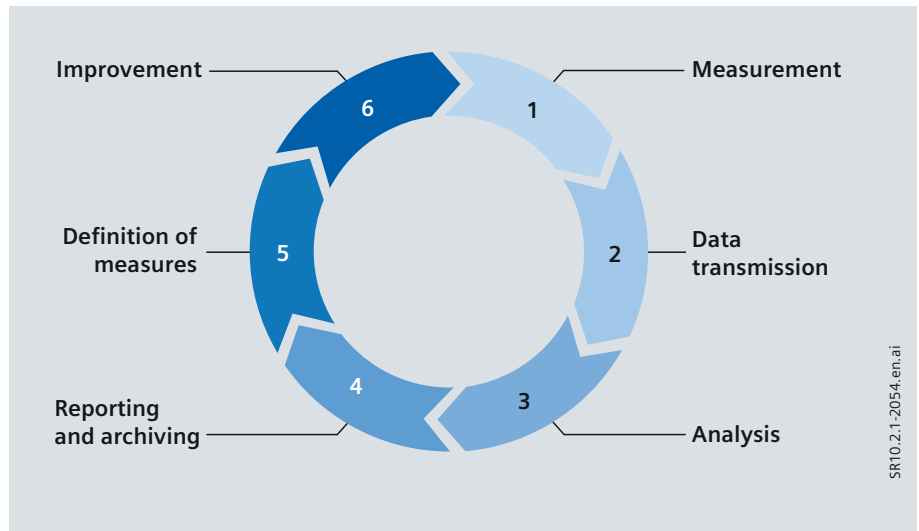


Fig. 4/18 Power quality cycle

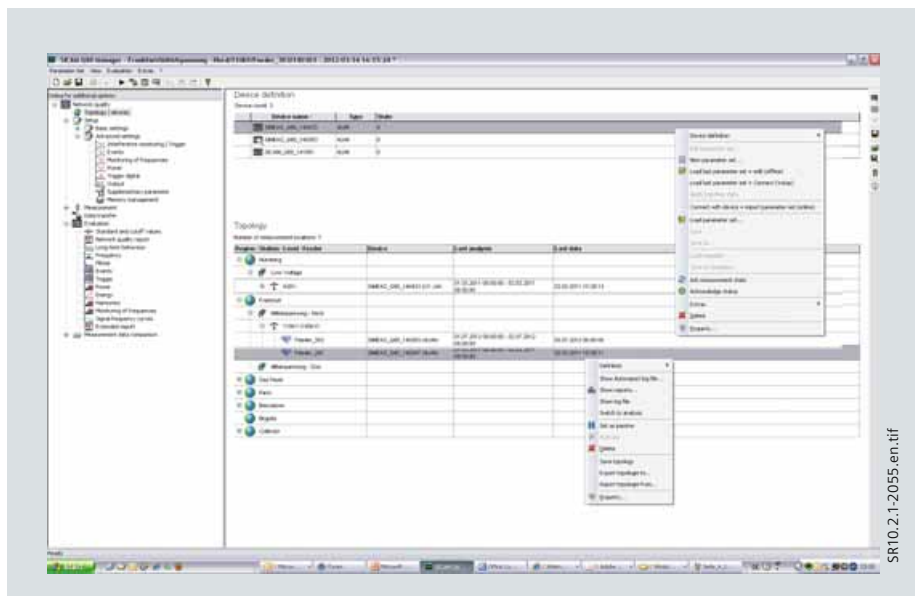


Fig. 4/19 Measurement overview

Products – SICAM Q80

Software

Online measurement

SICAM Q80 Manager enables connection with a device for the purpose of visualizing and monitoring online measurements over the network from a central PC at any time.

Further possibilities for online display are: Representation of currents and voltage in a vector diagram, online voltage and current harmonics, power direction of each phase and, in total, progression of r.m.s. value, recorded events.

Data evaluation

With the help of the database module, the user can search for any events, measurement channels, or deviations from standards. The data found or chosen can be displayed or compared at the touch of a button.

Limit configuration

The value limits stipulated in the EN 50160 standard serve as the basis for the power quality report. A single form displays all values in relation to the user-selected value limits. Depending on the particular quality demands, they can be changed and saved with names chosen by the user. Either the analysis can be based on user-defined data, or default value limits can be selected.

Analysis is followed by fully automated compilation of documentation of the overall measurement, in accordance with industry standards.

Data polling – Auto Transfer

With the automatic data transfer program – Auto Transfer – part of delivery of the SICAM Q80 Manager, it is possible to get data automatically from the remote devices.

The Auto Transfer software can be installed and parameterized independently of the SICAM Q80 Manager, in distinct places in the network or PCs. It is very helpful for reaching the flexibility of installing client server architectures.

The Auto Transfer can work with time cyclical data polling, or data are sent from the device as soon as they are available. E.g., the data availability depends on the voltage quality measurement interval or events. The data transfer intervals can be parameterized for power quality data, e.g. from 2 hours until 4 weeks duration. So, when they are completed, the automatic data collection can begin, e.g. from the

device to the server or evaluation station. In case of events, e.g. voltage triggers are matched, this data can be automatically transferred to the evaluation station independently of the measurement interval.

Data and information organization

For analysis purposes, over 500 waveforms per measurement are available. To make them manageable, e.g. evaluations to be applied to other management reporting tasks, the data can be exported to Excel or CSV files.

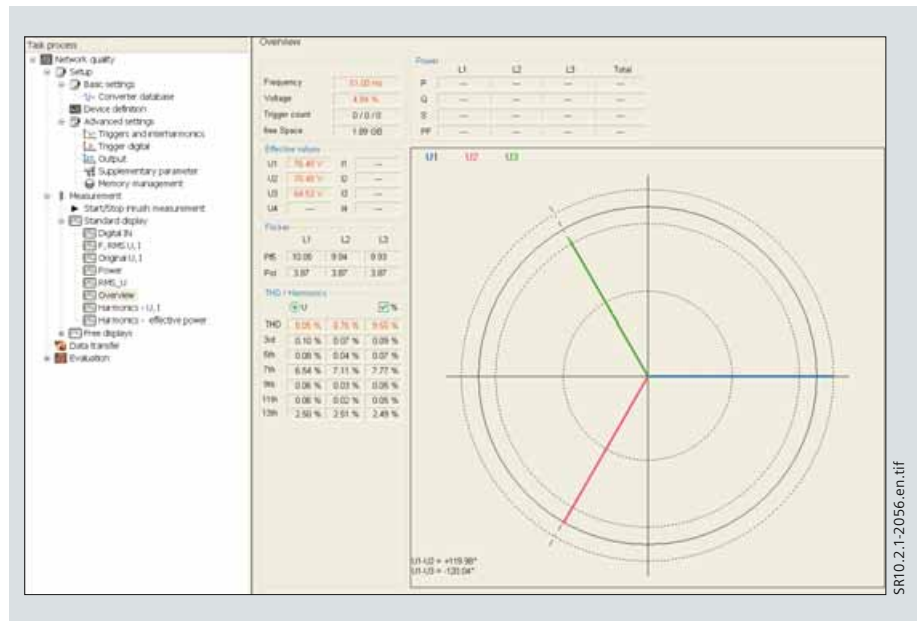


Fig. 4/20 Online visualization – phaser diagram

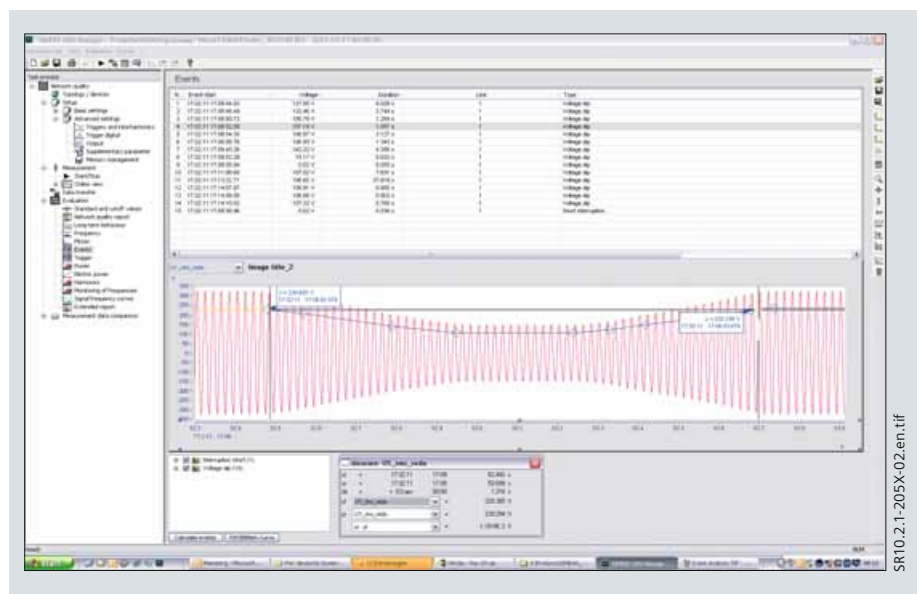


Fig. 4/21 Trigger analysis

Report generator

The report generator is used to create graphical reports to document the measurement and analysis results. Unlike the print function of the curve window, which prints out the current curve plot, the report can be made up of a layout comprising curve plots, text, tables and other graphical objects.

The report generator has a multi-document user interface on which multiple reports can be edited at one time. The usual editing operations, such as multiple selection, copy, paste, move, orientation, etc. are all provided.

The properties of the objects, such as colors, fonts, etc. can be changed in various ways, even in groups. An undo function, seamless zooming, a freely definable grid with a snap-function, and context sensitive online help round off the support tools available to the user for rapid compilation of complex reports. The report generator can be used to give every report and log its own layout:

- Automation of documentation
- The quick way to get measurement results as a hard copy
- Creation of document templates
- Insertion of measurement plots of any length
- Insertion of measurement value tables
- Insertion of elements via the MS Windows Clipboard
- Text, pixel graphics, vector graphics, OLE objects
- Texts in any font, color or format
- Structural elements
- Lines, frames, fields, arrows
- Grid functions for millimeter-precise layouts (e.g. 1 V corresponds to 10 mm/0.39 in.).



Fig. 4/22 Network quality report

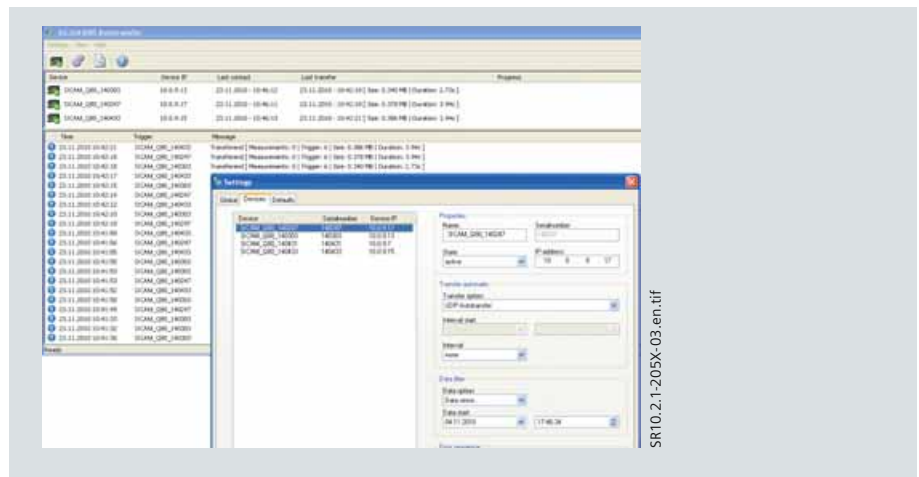


Fig. 4/23 Automatic data transfer program

Automatic power quality reporting – Auto Report

Jointly with Windows Scheduler Program, the Auto Report performs automatically scheduled power quality reports. The users just need to define the task and its interval, and where the reports have to be available.

Through the measurement overview option in the SICAM Q80 Manager, the user can access the reports, e.g. in PDF files, over the reports status windows, which already contain the brief status information, pass or fail.

Products – SICAM Q80

Software

Measurements overview

All values relevant to power quality are monitored, recorded and evaluated according to international and national standards for power quality (e.g. the European standard EN 50160).

Measurement standards	IEC 61000-4-30; IEC 61000-4-15; IEC 61000-4-7
Standards for voltage quality analysis	Voltage quality in accordance with EN 50160 or according to individually defined criteria
Voltage, current	Curve plots of r.m.s. values after every half period (reduced half-period r.m.s. values)
Flicker	Short-term (Pst), long-term (Plt) and momentary values (Pf5)
Frequency	40 to 70 Hz
Harmonics	Voltage, current up to 50 th harmonic, THD
Interharmonics	Up to 10 frequencies (5 to 3,000 Hz, resolution 5 Hz)
Symmetry	Zero/positive/negative phase-sequence system/asymmetry
Power calculation as per DIN 40110-1 and CE2	1-, 2-, 3-phase, total (active, apparent, reactive power)
Phase angle	< 1° up to 2.5 kHz
Trigger functionality	For voltage and current: R.m.s. trigger, curve form trigger, signal frequency trigger
Transients	Recording of instantaneous release of trigger values at 10 kHz

Table 4/7 Measurement specification

4

Time resolution

Many network quality attributes (e.g. voltage dips) require very detailed display while for others (e.g. slow changes), averages over 10 minutes are adequate. There may be five different resolution levels in total, depending on the calculation technique used.

Resolution	Significance	Examples
10 min	Values over the selected averaging interval (default 10 min)	Mean values, flicker
10 to 12 cycles	Values over the selected averaging interval f (default = 10 s)	Frequency
Half cycle	Sample of the demodulated impulse sequence (filter result of the amplitude modulated signal frequency)	Main voltage signaling
10 ms	r.m.s. value every half cycle	r.m.s. values
100 μ s	Input samples and derived quantities without data reduction	Recording of instantaneous value (curve shape)

Table 4/8 Time resolution of data

Measurement	Measurement intervals and comments	3-phase current 4-wire	3-phase current 3-wire	Single-line
Voltage	3 s, 10 s, 1 min, 5 min, 10 min , 15 min, 30 min, 1 h, 2 h	■	■	■
$V_{x_rms_mean}$	Mean of the voltage r.m.s. value	■	■	■
$V_{x_rms_min}$	Minimum in the averaging interval	○	○	○
$V_{x_rms_max}$	Maximum in the averaging interval	○	○	○
$V_{x_rms_redu}$	Reduced time plot (maximum resolution: 10 ms)	■	■	■
$V_{x_THD_mean}$	THD (Voltage total harmonic distortion)	■	■	■
$V_{x_harmn_mean}$ with $x = 1...8$; $n = 1...50$	Voltage harmonics	■	■	■
$V_{x_frz_mean}$ with $z = 1...10$	Monitoring of any fixed frequencies (e.g. interharmonics)	○	○	○
Current	3 s, 10 s, 1 min, 5 min, 10 min, 15 min, 30 min, 1 h, 2 h	○	○	○
$I_{x_rms_mean}$	Mean value of the current r.m.s. value	●	●	●
$I_{x_rms_min}$	Minimum in the averaging interval	○	○	○
$I_{x_rms_max}$	Maximum in the averaging interval	○	○	○
$I_{x_rms_redu}$	Reduced time plot	●	●	●
$I_{x_THD_mean}$	THD (Current total harmonic distortion)	●	–	●
$I_{x_harmn_mean}$ with $x = 1...4$; $n = 1...50$	Upper harmonic for current	●	–	●
$I_{x_frz_mean}$ with $z = 1...10$	Monitoring of any fixed frequencies	○	○	○
Frequency	3 s, 10 s , 30 s, 1 min, 5 min, 10 min	■	■	■
Frequency	System frequency	■	■	■
Frequency_histogram	Frequency histogram	■	■	■
Frequency_redu		■	■	■
Symmetry	3 s, 10 s, 1 min, 5 min, 10 min, 15 min, 30 min, 1 h, 2 h	■	■	–
Unbalance_rms		■	■	–
SymmetryZero_rms	Zero sequence system	■	–	–
SymmetryPositive_rms	Positive sequence system	■	■	–
SymmetryNegative_rms	Negative sequence system	■	■	–
Flicker	3 s, 10 s, 1 min, 5 min, 10 min, 15 min, 30 min, 1 h, 2 h			
$V_{x_rms_pst}$	Plt computed from 12 Pst values	●	■	■
$V_{x_rms_plt}$ with $x = 1...3$		●	■	■
Power	3 s, 10 s, 1 min, 5 min, 10 min, 15 min, 30 min, 1 h, 2 h	○	○	○
P_p_mean	Active power for the overall system	●	●	–
P_q_mean	Reactive power for the overall system	●	●	–
P_s_mean	Apparent power for the overall system	●	●	–
P_lambda_mean	Power factor	●	●	–
$P_x_p_mean$	Active power for one channel	●	–	●
$P_x_q_mean$	Reactive power for one channel	●	–	●
$P_x_s_mean$	Apparent power for one channel	●	–	●
$P_x_lambda_mean$	Power coefficient for one channel	●	–	●
$P_x_p_harmn_mean$	Active power of the harmonics	●	–	●
$P_x_q_harmn_mean$	Reactive power of the harmonics	●	–	●
$P_x_s_harmn_mean$	Apparent power of the harmonics	●	–	●
$P_x_Phase_harmn_mean$ with: $x = 1...4$; $n = 1...50$	Phase power of harmonic	●	–	●
$P_x_p_frz_mean$	Active power of the monitored frequencies	●	–	●
$P_x_q_frz_mean$	Reactive power of the monitored frequencies	○	–	○

■ = always present ● = present if current is measured ○ = can be switched on/off (optional) – = not present

Note: Measurement intervals: The interval written in bold print is to be used for compliance with the EN 50160 standard, e.g. 10 min. Specifications refer to a 50 Hz and a 60 Hz system. For all channels, subsequent calculation of a histogram and the cumulative frequency is possible.

Table 4/9 Selection of measurement and metering values (contin. on p. 4/22)

Products – SICAM Q80

Measurement overview

Measurement	Measurement intervals and comments	3-phase current 4-wire	3-phase current 3-wire	Single-line
$P_{x_Q_frz_mean}$	Reactive power of the monitored frequencies	○	–	○
$P_{x_S_frz_mean}$	Apparent power of the monitored frequencies	○	–	○
$P_{x_Phase_frz_mean}$ with: x = 1...4; z = 1...10	Phase power of monitored frequencies	○	–	○
Trigger	Measurement duration 200 ms. Resolution 100 μs	○	○	○
V_{x_event}	R.m.s. trigger, curve shape trigger	▲	▲	▲
I_{x_event} with: x = 1...4	R.m.s. trigger, curve shape trigger	▲	▲	▲
Signal frequency trigger	Mean values: 3 s, 10 s, 1 min, 5 min, 10 min, 15 min, 30 min, 1 h, 2 h	▲	▲	▲
$V_{x_signal_mean}$	Mean of the voltage	○	○	○
$V_{x_signal_redu}$	Reduced time plot	▲	▲	▲
$V_{x_signal_event}$	High resolution signal voltage trigger (10 ms)	▲	▲	▲
$P_{x_P_signal_mean}$	Active power	▲	▲	▲
$P_{x_Q_signal_mean}$	Reactive power	▲ ●	▲ ●	▲ ●
$P_{x_S_signal_mean}$	Apparent power	▲ ●	▲ ●	▲ ●
$P_{x_Phase_signal_mean}$ with: x = 1...3	Phase power	▲ ●	▲ ●	▲ ●

Channels during measurement (online monitoring)

Measurement	Measurement intervals and comments	3-phase current 4-wire	3-phase current 3-wire	Single-line
Voltage		■	■	■
V_x	100 μs (no averaging, original signal)	■	■	■
V_{x_rms}	R.m.s. every 10 ms	■	■	■
V_{x_FFT}	Voltage harmonics (1 st –50 th)	■	■	■
Phase				
V_1-V_2		■	■	■
V_1-V_3		■	■	■
V_x-I_x with: x = 1...3		●	●	●
Current	100 μs	○	○	○
I_x	100 μs (no averaging, original signal)	●	●	●
I_{x_rms}	R.m.s. every 10 ms	●	●	●
I_{x_FFT} with: x = 1...3	Upper harmonics (1 st –50 th)	●	●	●
$P_{x_P_harmonics}$ with: x = 1...3	Harmonic real power (1 st –50 th)	●	●	●

Overview display during measurement

Measurement	Measurement intervals and comments	3-phase current 4-wire	3-phase current 3-wire	Single-line
V_x	R.m.s. over one period	■	■	■
THD	of every 10 periods	■	■	■
V-harmonics (in % of fundamental frequency or V) with: x = 1...3	FFT over 10 periods	■	■	■
I_x	R.m.s. over one period	●	●	●
THD	of every 10 periods	●	●	●
I-harmonics (in % of fundamental frequency or A) with: x = 1...3	FFT over 10 periods			
Unsymmetry	of every 10 periods	■	■	■
Instantaneous flicker of V_x with: x = 1...3	of every 10 periods	■	■	■
Power				
P_x, Q_x, S_x , power factor		●	–	●
For the overall system with: x = 1...3		●	●	–
Additional information	Free storage space in the measurement device	■	■	■
	Number of recorded trigger events	■	■	■

■ = always present ● = present if current is measured ▲ = present if the associated trigger was activated ○ = can be switched on/off (optional) – = not present

Note: Measurement intervals: the interval written in bold print is to be used for compliance with the EN 50160 standard, e.g. 10 min. Specifications refer to a 50 Hz and a 60 Hz system. For all channels, subsequent calculation of a histogram and the cumulative frequency is possible.

Table 4/9 Selection of measurement and metering values (contin. from p. 4/21)

Connection examples

Four-wire connection (star circuit)

- $V_1, V_2, V_3 \rightarrow$ Lines 1, 2, 3, V_4 , PE (protection ground)
- N \rightarrow Neutral
- $I_1, I_2, I_3, I_4 \rightarrow$ connected or unconnected (V_4, I_4 can be measured optionally)

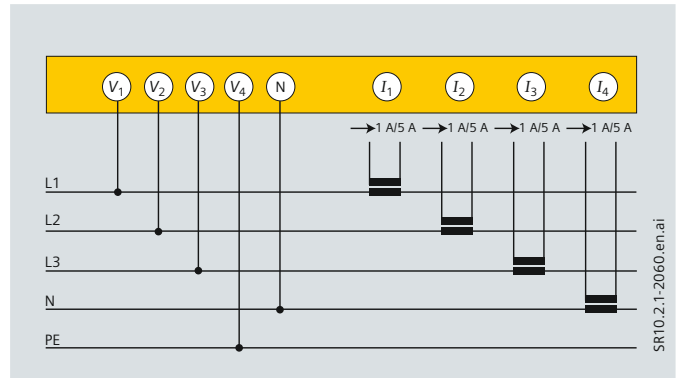


Fig. 4/24 Four-wire connection

Eight-voltage connection

System 1:

- $V_1, V_2, V_3 \rightarrow$ Lines 1, 2, 3, V_4 , PE (protection ground)
- N \rightarrow Neutral

System 2:

- $V_5, V_6, V_7 \rightarrow$ Lines 5, 6, 7, V_8 , PE (protection ground)
- N \rightarrow Neutral

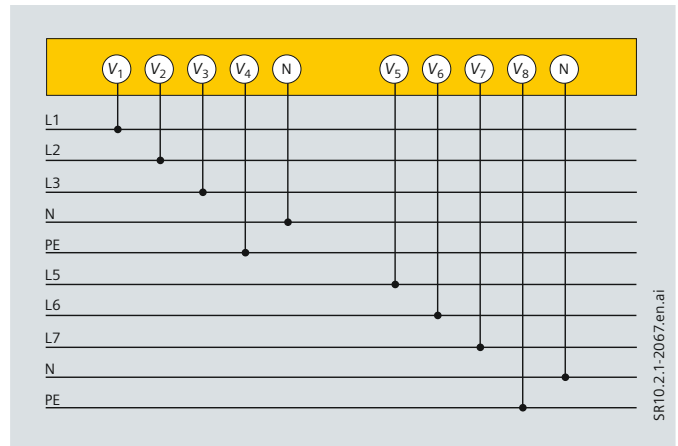


Fig. 4/25 Eight-voltage connection

Three-wire connection $3 \times V/3 \times I$ or $2 \times I$ (delta connection)

- $V_1, V_3 \rightarrow$ Lines 1 and 3
- N \rightarrow Line 2
- $I_1, I_3 \rightarrow$ Lines 1 and 3
- $I_2 \rightarrow$ Line 2 optionally possible

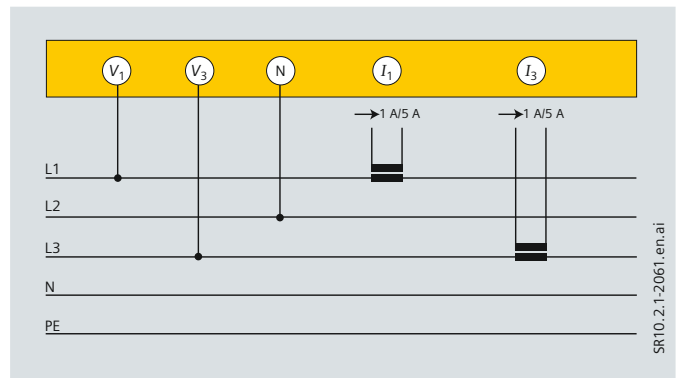


Fig. 4/26 Three-wire connection (delta connection)

Single-phase connection

- $V_1 \rightarrow$ Line 1
- N \rightarrow Neutral

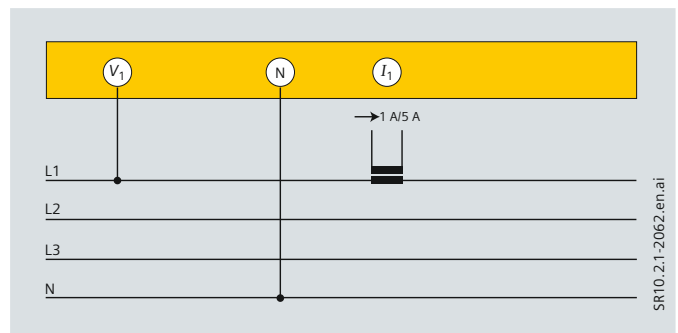


Fig. 4/27 Single-phase connection

Products – SICAM Q80

Technical data

General data

Parameter	Typical value	Min./max.	Test conditions/remarks
Ambient conditions	The normal ambient conditions according to EN 61010-1 apply		
Signal inputs	4 × current [I] 4 × voltage [V] and 8 × voltage [V]		
Digital input/output	4 binary inputs 4 relay outputs		
Power consumption		< 10 W < 12 W	Permanent operation After power-on (to recharge the UPS)
Power supply		DC 10 to 60 V or AC 100 V to 240 V / DC 110 V to 320 V	
UPS capacitor	Back-up time: ≤ 1 second		Factory settings
EMC Interference immunity/ Transient emissions	Class A		According to IEC/EN 61326-1
Degree of protection	IP 20		According to EN 60529
Weight	Approx. 1.9 kg		
Dimensions	166 mm × 105 mm × 126 mm 6.53 in. × 4.13 in. × 4.96 in.		(W × H × D) without mounting rail
Ambient temperature range	–10°C to 55°C/50°F to 131°F		Without condensation
Storage temperature	–40°C to 90°C/–40°F to 194°F		Within temperatures ≤ 15°C or > 55°C/≤ 59°F or > 131°F only for short time
Communication interfaces	Ethernet, Modem		TCP/IP DSUB
Memory capacity	CF card	Min. 2 GB, Max. 16 GB	Standard accessory: 2 GB CF card up to 16 GB possible
Internal clock and external synchronization	± 1 s/day GPS DCF 77 or via other SICAM Q80		Battery backed GPS input Sync input

Table 4/10 Technical data

Voltage inputs

Parameter	Typical value	Min./max.	Test conditions/remarks
Input	4 or 8 channels for voltage measurement		Single end, isolation for each group
Sampling rate per channel		10 kHz	Network analysis
Bandwidth		0 to 4.1 kHz	– 3 dB, network analysis
Terminal connections	Screw terminal 0.5 to 6 mm ² /0.008 to 0.009 sqin. 10 to 20 AWG (American Wire Gauge)		Screw terminal for rigid or flexible line with 0.5 to 6 mm ² /0.008 to 0.009 sqin. cross-section
Electrical safety Rating		300 V/CAT IV	In accordance with EN 61010-1
Measurement category Degree of pollution		600 V/CAT III 2	Voltage inputs V ₁ to V ₄ or V ₁ to V ₈ in accordance with IEC 60664
Insulation test voltage		5.4 kV _{rms}	50 Hz, 1 min
Measurement ranges	up to 1000 V _{rms}		Automatic range setting
Overload resistance		1.5 kV _{rms}	DC and 50 Hz, permanent
Input impedance	2.5 MΩ	± 1 %	Differential
Measurement uncertainty Drift	0.04 % ± 8 ppm/K × ΔT _a	≤ 0.1 % ± 40 ppm/K × ΔT _a	of ranges ΔT _a = T _a – 25°C / ΔT _a = T _a – 13°F ambient temperature T _a
Isolation suppression		> 110 dB > 71 dB > 47 dB	Isolation voltage 1000 V _{rms} DC 50 Hz 1 kHz
Channel crosstalk		≤ 110 dB ≤ 85 dB ≤ 60 dB	Test voltage: 1000 V _{rms} DC 50 Hz 1 kHz
Strain voltage (RTI)	20 mV _{rms}		± 100 V, bandwidth: 0.1 Hz to 10 kHz

Current inputs

Parameter	Typical value	Min./max.	Test conditions/remarks
Input	4 channels for current measurement with current probes		Differential, isolated
Terminal connections	Screw terminal 0.25 to 2.5 mm ² / 0.0004 to 0.004 sqin. 14 to 24 AWG (American Wire Gauge)		Screw terminal for rigid or flexible line with 0.25 to 2.5 mm ² /0.0004 to 0.004 sqin. cross-section
Electrical safety Rating		300 V/CAT IV	In accordance with EN 61010-1
Measurement category Degree of pollution		600 V/CAT III 2	Current inputs I ₁ to I ₄ in accordance with IEC 60664
Insulation test voltage		5.4 kV _{rms}	50 Hz, 1 min
Measurement ranges	> 1 A ≤ 1 A		5 A connection 1 A connection
Bandwidth		0 to 4.1 kHz	–3 dB, network analysis
Sampling rate per channel		10 kHz	Network analysis
Overmodulation limit		145 % of range	
Overload strength 5 A terminal 1 A terminal		≤ 20 A ≤ 100 A ≤ 10 A ≤ 100 A	Continuous 1 s Continuous 1 s
Input impedance 5 A terminal 1 A terminal		≤ 10 mΩ ≤ 20 mΩ	Differential
Measurement tolerance	0.06 % ± 8 ppm/K × ΔT _a	≤ 0.1 % ± 60 ppm/K × ΔT _a	of input range ΔT _a = T _a – 25°C / ΔT _a = T _a – 13°F ambient temperature T _a
Phase uncertainty		0 to 2.5 kHz	< ± 1°

Table 4/10 Technical data

Products – SICAM Q80

Technical data

Digital inputs

Parameter	Typical value	Min./max.	Test conditions/remarks
Channels/bits	4 digital inputs		Each isolated
Terminal connections	Screw terminal 0.25 to 2.5 mm ² / 0.0004 to 0.004 sqin. 14 to 24 AWG (American Wire Gauge)		Screw terminal for rigid or flexible line with 0.25 to 2.5 mm ² /0.0004 to 0.004 sqin. cross-section
Electrical safety Rating	250 V/CAT III		In accordance with EN 61010-1
Measurement category Degree of pollution	2		In accordance with IEC 60664
Insulation test voltage	3.6 kV _{rms}		50 Hz, 10 sec Between channels and chassis
Max. input level V _e		≤ 600 V	Peak-to-peak or DC voltage
Nom. input level V _e	DC 230 V _{rms} /350 V		
Switching level V _S Unipolar low Unipolar high	< 16 V > 16.8 V	> 14 V > 18 V	Schmitt-Trigger-characteristics Hysteresis 0.04 V typ.
Current input	280 μA	< 500 μA	V _e = - 600 V to + 600 V
Circuit time Low → high High → low	70 μs 23 μs	< 180 μs < 40 μs	

Digital outputs

Parameter	Typical value	Min./max.	Test conditions/remarks
Channel/bits	4 relay outputs		Mechanical closer
Terminal connection	Screw terminal 0.25 to 2.5 mm ² / 0.0004 to 0.004 sqin. 14 to 24 AWG (American Wire Gauge)		Screw terminal for rigid or flexible line with 0.25 to 2.5 mm ² /0.0004 to 0.004 sqin. cross-section
Electrical safety Rating	250 V/CAT III		In accordance with EN 61010-1
Measurement category Degree of pollution	2		In accordance with IEC 60664
Insulation test voltage	3.6 kV _{rms}		Between channels and chassis
Switching time	5 ms	< 8 ms	
Max. switching power		< 1000 VA	
Switching voltage	> 1 V DC	< 250 V _{rms}	Min. switching voltage at 1 mA
Max. switching current		< 1 A < 4 A	AC 250 V cos φ = 1.0 to 0.4 AC 250 V cos φ = 1.0
Contact impedance		< 50 mΩ	
Fuse protection Nominal current (I _N)	5 A	I _N 2 I _N	t _{fuse} ≥ 4 h 30 s > t _{fuse} > 1 s

Table 4/10 Technical data

Calibration conditions

Parameter	Typical value	Test conditions/remarks
Temperature	25 °C/77 °F	± 5 °C/± 41 °F
Humidity	40 %	± 30 %
Power supply	24 V	60 W power adapter
Input signal	± 1,000 V _{rms} /sine 50 Hz ± 1 A _{rms} /sine 50 Hz	Voltage inputs Current inputs
Evaluations according to standards		
Standard specification	Voltage quality per EN 50160	IEC 61000-4-30, IEC 61000-4-15, IEC 61000-4-7 Power calculation per DIN 40110-1 and -2
	Data search and data comparison across multiple measurements	Optional software module

Synchronization and time base

Parameter	Typical value	Min./max.	Remarks	
Time base per device without external synchronization				
Balanced (default)		± 10 ppm	at 25 °C/77 °F (accuracy of internal time base)	
Drift	± 20 ppm	± 50 ppm	– 40 °C/–40 °F to + 85 °C/185 °F operating temperature	
Ageing		± 10 ppm	at 25 °C/77 °F, 10 years	
Parameter	GPS	DCF77	IRIG-B	NTP
Time base per device without external synchronization				
Supported format			B002 B000, B001, B003*	Version 4 (downwards compatible)
Precision	± 1 µs		→	< 5 ms after ca. 12 h
Jitter (max.)	± 8 µs		→	
Voltage level	TTL	24 V TTL level LOW active	24 V TTL level	–
Input resistance	1 kΩ (pull up)	20 kΩ (pull up)		–
Input connector	DSUB-9	24 V electrical copper wire	→	Ethernet
Shield potential input		System ground	→	–

Table 4/10 Technical data

* Using BCD information only

Products – SICAM Q80

Connection diagrams, dimension drawings

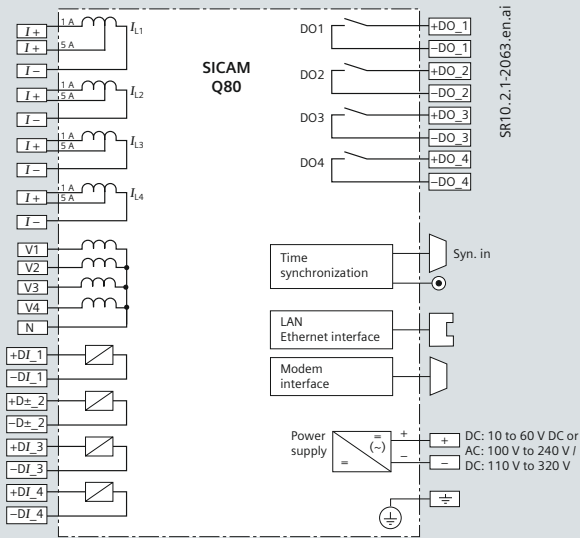


Fig. 4/28 7KG8080 – four-wire connection

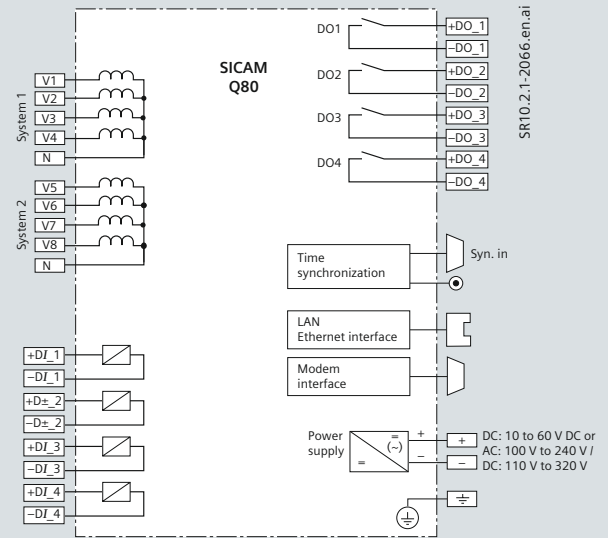


Fig. 4/31 7KG8080 – eight-voltage connection

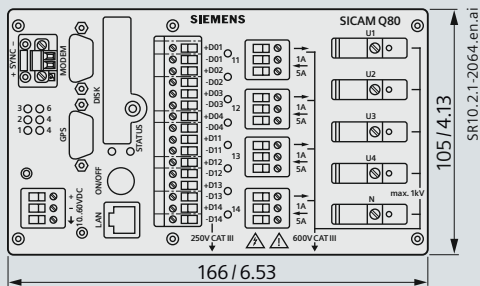


Fig. 4/29 Four-voltage / four-current connection: front view

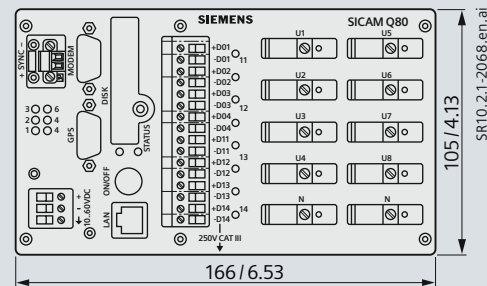


Fig. 4/32 7KG8080 – eight-voltage connection: front view

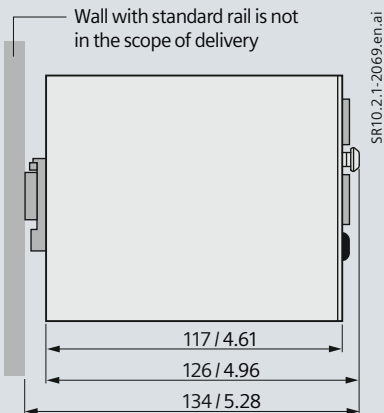


Fig. 4/30 7KG8080: side view

Description	Order No.
SICAM Q80 Power Quality Recorder – IEC 61000-4-30/Class A – 2 GB compact flash – 4 binary inputs and 4 binary outputs – Synchronization: DCF77/GPS/IRIG-B/NTP Sync. – Ethernet interface – SICAM Q80 Manager – Operating instructions: English and German – Modbus TCP Protocol We suggest the following GPS accessories: – Meinberg GPS180AHSx, or – Garmin (18 LVC-5Hz) – Hopf Receiver 6875-FW7.0: 7XV5664-OCA00 (see SIPROTEC price list) Inputs: 4 currents / 4 voltages _____ 0 8 voltages _____ 1 Power supply: DC 24/60 V _____ A V _{aux} AC: 100 V to 240 V / V _{aux} DC: 110 V to 320 V _____ B	7KG8080-□□A00-0AA0 ↑↑
SICAM Q80 – Manager Software for – Device parameterization – System topology – Online measurement – Power quality reports (e.g. according to EN 50160) – Automatic power quality reporting (Windows schedule) – Excel/ASC II export – Software language: English / German – Operating instructions and system manual: English / German as PDF	7KG8081-1AA00-0AA0
Extra printed system manual German _____ E50417-H1000-C420-A1 English _____ E50417-H1076-C420-A1	
Ethernet patch cable With double shield (SFTP), cross-over connection, with LAN connector on both ends, SICAM Q80 <CE> PC	7KE6000-8GE00-3AA0

Table 4/11 Selection and ordering data

Products – SICAM Q80

CE conformity and disclaimer of liability

CE conformity

This product conforms to the directives of the Council of the European Communities on the approximation of the laws of the Member States relating to electromagnetic compatibility (EMC Council Directive 89/336/EEC) and concerning electrical equipment for use within specified voltage limits (Low-Voltage Directive 73/23/EEC).

This product conforms to the international standard IEC 61000-4 and the European standard EN 50160 for voltage characteristics.

The product is designed for use in an industrial environment according to the EMC standard specification as per IEC 61326-1.

Conformity is proved by tests performed by Siemens AG in line with article 10 of the Council Directives in accordance with the generic standard EN 50160 and IEC 61000-4-30 for Class A measurement.

Disclaimer of liability

This document has been subjected to rigorous technical review before being published. It is revised at regular intervals, and any modifications and amendments are included in the subsequent issues. The content of this document has been compiled for information purposes only. Although Siemens AG has made best efforts to keep the document as precise and up-to-date as possible, Siemens AG shall not assume any liability for defects and damage which result through use of the information contained herein. This content does not form part of a contract or of business relations; nor does it change these. All obligations of Siemens AG are stated in the relevant contractual agreements. Siemens AG reserves the right to revise this document from time to time.

Document version: 02

Release status: 02.2011

Version of the product described: V2.0

4

Certificate of Conformity IEC 61000-4-30 Class A

Siemens SIMEAS Q80
equipped with Garmin GPS18x LVC
(or other GPS receiver with equivalent accuracy and functionality)

IEC 61000-4-30 Ed. 2
230V, 50/60 Hz, L-N U_{din}

61000-4-30 Section	Power Quality Parameter	Class A Compliance	Class S Compliance	Class B Compliance	Remarks
5.1	Power frequency	Yes	Yes	Yes	
5.2	Magnitude of the supply voltage	Yes	Yes	Yes	
5.3	Flicker	Yes	Yes	(N/A)	See Note 1 below
5.4	Supply voltage dips and swells	Yes	Yes	Yes	
5.5	Voltage interruptions	Yes	Yes	Yes	
5.7	Supply voltage unbalance	Yes	Yes	Yes	
5.8	Voltage harmonics	Yes	Yes	Yes	
5.9	Voltage interharmonics	Yes	Yes	Yes	
5.10	Mains signaling voltage	Yes	Yes	Yes	
5.12	Underdeviation and overdeviation	-	-	-	See Note 2 below
4.4	Measurement aggregation intervals	Yes	No	Yes	Class A and Class S are mutually exclusive
4.6	Time-clock uncertainty	Yes	Yes	Yes	
4.7	Flagging	Yes	Yes	(N/A)	
6.1	Transient influence quantities	Yes	(N/A)	(N/A)	See Note 3 below

(N/A) – Not Applicable. There is no requirement in the Standard.

Note 1: Flicker is only defined at 230V, 50Hz and 120V, 60Hz. EUT meets Class A requirements at 230V, 50Hz.

Note 2: Overdeviation and underdeviation parameters are not measured by the Siemens SIMEAS Q80.

Note 3: Transients applied to EUT measuring terminals and power terminals.

This certificate summarizes the results of the PSL IEC 61000-4-30 Power Quality Measurement Methods Compliance Report, document # PSL SIEMENS-009-30, dated 27 August 2009. PSL tested two samples, S/N 140148 and 140149 at 230VAC, 50/60 Hz. Manufacturer states that these samples are representative of the SIMEAS Q80 series.



Siemens SIMEAS Q80

Alex McEachern 27 August 2009

Alex@PowerStandards.com

Statement of IEC 61000-4-30 Compliance