

SIPROTEC 4 PROFIBUS DP Communication Modules with Fiber-optical Interface

Validity

This Service Information is valid for:

- PROFIBUS DP communication modules from HW revision 4 with fiber-optical interface
- Installations with fiber-optical ring topology where only PROFIBUS DP modules from HW revision 4 are interconnected

The hardware revision of the PROFIBUS DP communication modules is recognizable in build-in condition at the rear of the SIPROTEC device at the labeling of the communication module mounting bracket:

- up to HW revision 3: identification "P-Slave"
- from HW revision 4: identification "Profibus"

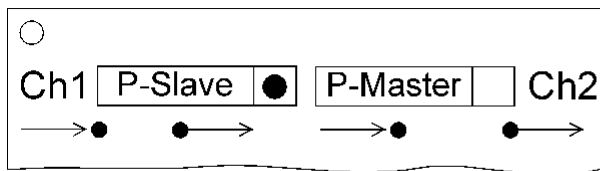

up to HW revision 3

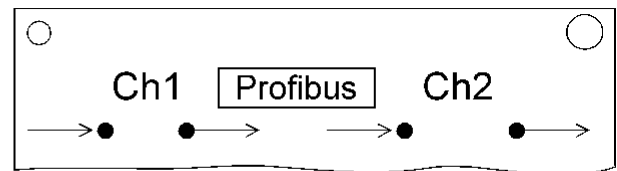

from HW revision 4

Preface

For all SIPROTEC4 fiber-optical PROFIBUS DP modules (independent of the HW revision), the default settings of the build-in Optical Link Module are:

- OLM V2 (SINEC L2) device compatible
- Redundancy function = enabled.

This ensures that modules of both HW revisions can be interconnected.

Fiber-optical communication modules from HW revision 4 offer in addition the OLM V3 settings of the SIMATIC NET devices OLM/G12 (6GK1502-3CB10 / 6GK1503-3CB00).



Note:

If only fiber-optical PROFIBUS DP modules from HW revision 4 are used then we recommend operating all OLM/G12 devices and PROFIBUS DP communication modules of the SIPROTEC devices in the fiber-optical ring in OLM V3 mode.

This Service information gives associated configuration hints.

Additional information of the properties and parameters of the PROFIBUS DP communication modules are described in the "SIPROTEC 4 - PROFIBUS-DP Communication profile" /1/.

				Date	2007-08-20	Service Information SIPROTEC 4 Communication Modules PROFIBUS DP / Fiber-optical Ring
				Name	Förster	
				Revised	Dr. Wache	
				Norm.		
				SIEMENS AG		Page 1 / 7
				PTD EA		
				Power Transmission and Distribution		
1	Initial	2007-08-20	Fö			
Rev.	Note	Date	Name			

Bus Topology

The following figure shows a typical fiber-optical PROFIBUS DP installation. In this example three SIPROTEC4 devices are interconnected in a fiber-optical ring and connected via an OLM/G12 to a PROFIBUS DP master.

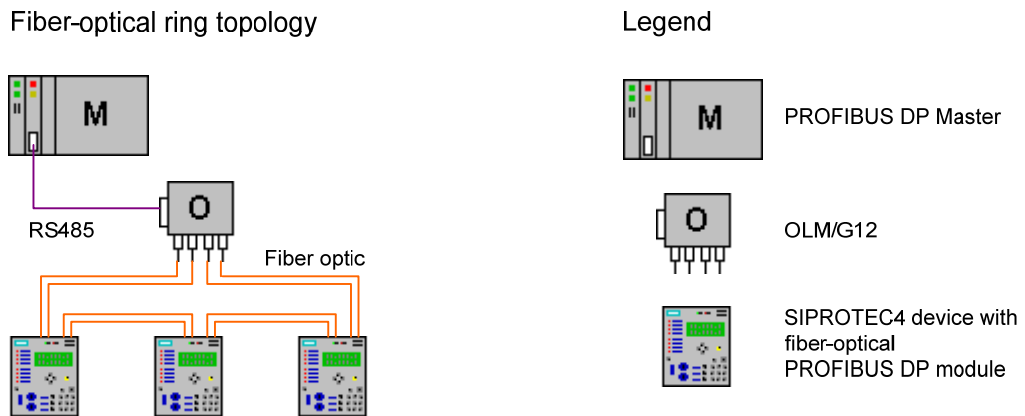

Figure 1: Fiber-optical ring topology

Configuration of the PROFIBUS DP Interface of the SIPROTEC Devices

1. Mapping File Selection and Basic Bus Settings

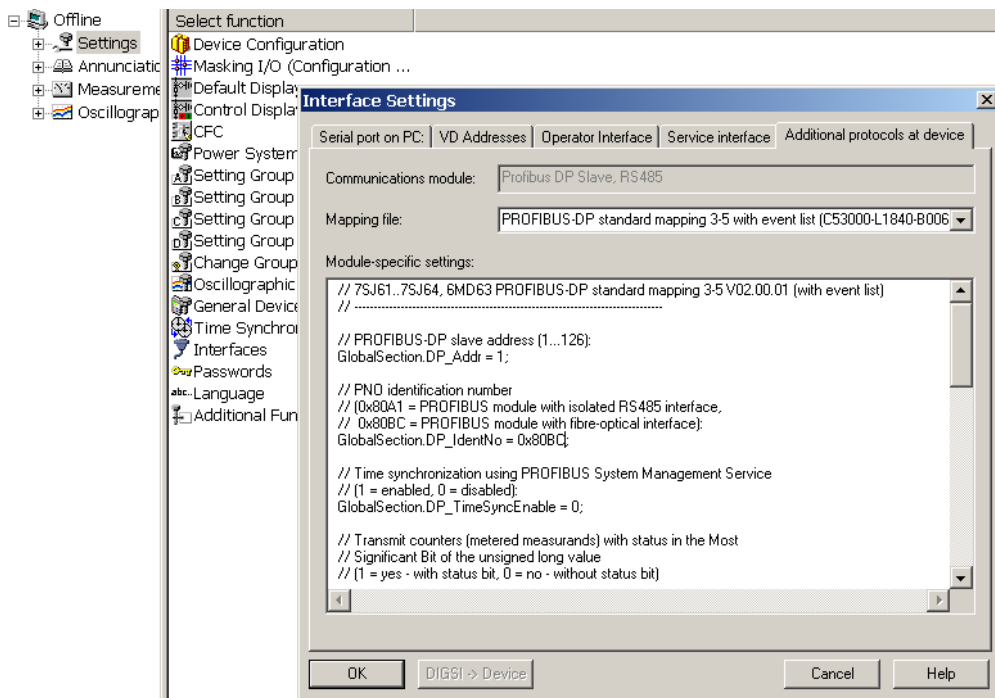

Figure 2: SIPROTEC4 - Mapping file selection in DIGSI

				Date	2007-08-20	Service Information SIPROTEC 4 Communication Modules PROFIBUS DP / Fiber-optical Ring
				Name	Förster	
				Revised	Dr. Wache	
				Norm.		
				SIEMENS AG		Page 2 / 7
				PTD EA		
1	Initial	2007-08-20	Fö	Power Transmission and Distribution		
Rev.	Note	Date	Name			

Open the SIPROTEC device in DIGSI, select *Settings – Interfaces and Additional protocols at device* (see Figure 2). Then select a Mapping file.



Note:

- Please only use mapping files which numbering starts with a “3-“, e.g. standard mapping 3-5 as shown in Figure 2. All other mapping files which do not start with “3-“ are only offered for compatibility to existing installations that used these mappings and shall not be used for new configurations.
- Further information to the data size of the mapping files you find in the device-specific “Bus mapping” documentation /2/, /3/ in the Internet.

In the edit box *Module-specific settings* adapt the PROFIBUS DP slave address and set the PNO identification number to 0x80BC (which is the identification number of the fiber-optical module).

For 6MD66 devices with redundancy option only: Set the PNO identification number to 0x8138

```
// PNO identification number
// [0x80A1 = PROFIBUS module with isolated RS485 interface,
// 0x80BC = PROFIBUS module with fibre-optical interface,
// 0x8138 = Redundant PROFIBUS DP interface]:
GlobalSection.DP_IdentNo = 0x8138;
```

2. Fiber-optical Interface

Scroll down in the edit box *Module-specific settings* up to the settings for the fiber-optical interface as shown in the following figure:

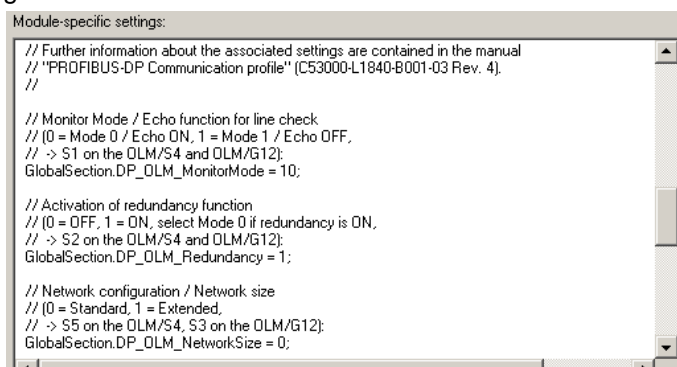

Figure 3: SIPROTEC4 – Fiber-optical settings

Change the value of “Monitor Mode” to GlobalSection.DP_OLM_MonitorMode = 10. This enables the OLM/V3 mode.



Note:

The help texts shown in the mapping file during parameterization can be different and the parameter 10 for “Monitor Mode” partly is not explained there. Detailed information to all parameters you find in the “PROFIBUS DP Communication profile” documentation /1/.

				Date	2007-08-20	Service Information SIPROTEC 4 Communication Modules PROFIBUS DP / Fiber-optical Ring
				Name	Förster	
				Revised	Dr. Wache	
				Norm.		
				SIEMENS AG		Page 3 / 7
				PTD EA		
1	Initial	2007-08-20	Fö	Power Transmission and Distribution		
Rev.	Note	Date	Name			

Leave the both other parameter for the fiber-optical interface to their default setting (Redundancy = 1, Network Size = 0).

3. Checking Correct Settings at the Device

After downloading the parameter set, the correct settings of the PROFIBUS DP module can be checked using the *Modulinfo* menu at the device.



Note:

Only SIPROTEC devices with firmware V4.50 or higher support the function of displaying module-specific information at the device display.

The display of module-specific information is accessible with the following menu items or buttons:

- MENU
- Test/Diagnosis → 5
- Modulinfo → 5
- Port B → 1

Please refer to the “PROFIBUS DP Communication profile” documentation /1/ for a detailed explanation of the menu entries. As an example, the following entries show the correct fiber-optical settings for OLM V3 mode:

OLMCmp: V3, OLM/G12
 OLMod: Redundancy
 OLMNWS: -

4. OLM Status Indications

In a redundant fiber-optical ring topology, a (single) fiber-optical line-break does not lead to a communication interruption between the PROFIBUS DP master and the PROFIBUS-DP slave. This line-break however must be recognized and repaired because with this line-break the redundancy is not present any more.

OLM status indications are available which can be routed to SIPROTEC objects and then evaluated in the SIPROTEC device or transmitted to the PROFIBUS DP master.

- "Li ne-break Channel A"
 Byte offset = 65535, Bit mask = 01(hex)
- "Li ne-break Channel B"
 Byte offset = 65535, Bit mask = 02(hex)

For 6MD66 devices with redundancy option only:

- "Li ne-break Channel A", second modul e
 Byte offset = 65535, Bit mask = 03(hex)
- "Li ne-break Channel B", second module
 Byte offset = 65535, Bit mask = 04(hex)

Please refer to the “PROFIBUS DP Communication profile” documentation /1/ for a detailed explanation and a routing example for these OLM status indications.

				Date	2007-08-20	Service Information SIPROTEC 4 Communication Modules PROFIBUS DP / Fiber-optical Ring
				Name	Förster	
				Revised	Dr. Wache	
				Norm.		
				SIEMENS AG P T D E A Power Transmission and Distribution		Page
1	Initial	2007-08-20	Fö			4 / 7
Rev.	Note	Date	Name			

DIL Switch Settings of the OLM/G12

Set the DIL switches of the OLM/G12 for OLM V3 mode as follows:

S7 = 0
 S6 = 1
 S5 = 1
 S4 = 1
 S3 = 1
 S2 = 1
 S1 = 1
 S0 = 0

For further information about the OLM/G12 devices please refer to the Operating Instruction /4/.



Note:

OLM/G12 devices need a power supply voltage of 24 VDC.

We recommend using the wide-range power supply unit 7XV5810-0BA00 when 24 VDC is not available for the OLM/G12 device at the mounting location.

Configuration Notes for the PROFIBUS DP Master

1. GSD Files

Use the following GSD file for PROFIBUS DP modules with fiber-optical interface

File name: "SI1_80BC.GSD"

Model name: SIPROTEC4 DP-Fibre_HWRev4

For 6MD66 devices with redundancy option only

File name: "SIEM8138.GSD"

Model name: SIPROTEC4 DP Redundant

The GSD files are available at the same Internet location than the "PROFIBUS DP Communication profile" documentation /1/.

2. Retry Limit and Slot Time

Every fiber-optical SIPROTEC communication module contains an Optical Link Module.

An OLM (the build-in OLM on the SIPROTEC communication module or the OLM/G12 device) causes a message transmission delay on the bus. Therefore, the parameter "Slot time (t_{slot})" has to be set to correct values in order to adapt supervision times in the PROFIBUS DP master.

For a SIMATIC S7 used as PROFIBUS DP master you get the correct value for "Slot time" when you enter the "Number of OLM" in the *Network settings* dialog of the parameterization system STEP7.

				Date	2007-08-20	Service Information SIPROTEC 4 Communication Modules PROFIBUS DP / Fiber-optical Ring
				Name	Förster	
				Revised	Dr. Wache	
				Norm.		
				SIEMENS AG		Page 5 / 7
				PTD EA		
				Power Transmission and Distribution		
1	Initial	2007-08-20	Fö			
Rev.	Note	Date	Name			

The "Number of OLM" results from the number of OLM/G12 devices plus the number of connected fiber-optical communication modules of the SIPROTEC devices (e.g. for one OLM/G12 and nine SIPROTEC devices as shown in Figure 4).

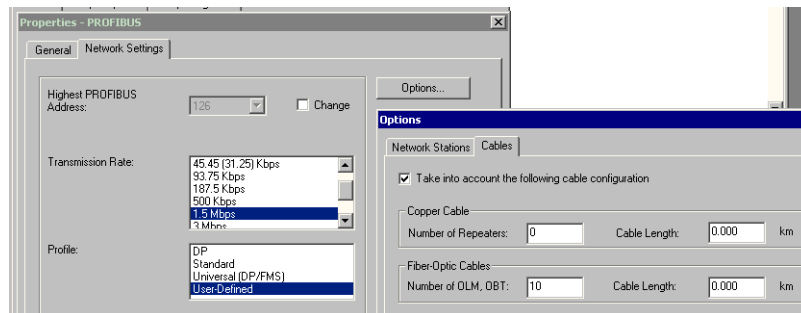

Figure 4: Number of OLM

Set the "Retry limit" at least equal to 3.
For this, the profile "User-defined" has to be selected.

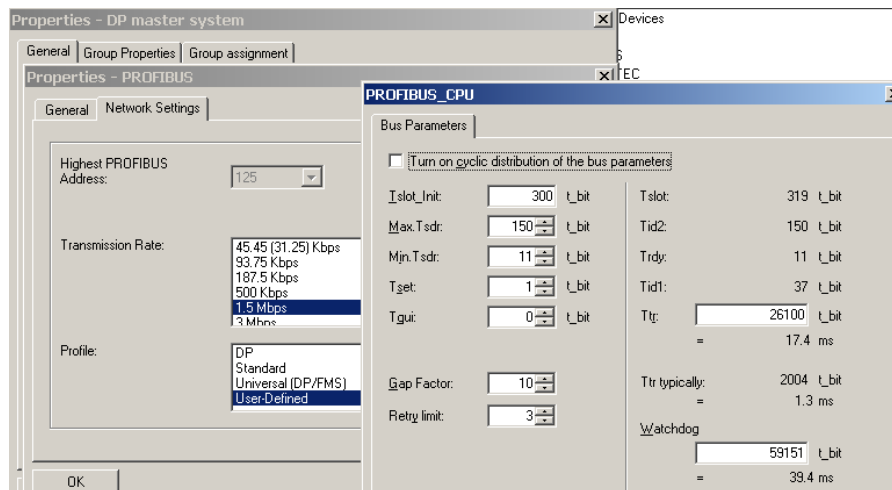

Figure 5: Retry limit

				Date	2007-08-20	Service Information SIPROTEC 4 Communication Modules PROFIBUS DP / Fiber-optical Ring
				Name	Förster	
				Revised	Dr. Wache	
				Norm.		
				SIEMENS AG		Page 6 / 7
				PTD EA		
				Power Transmission and Distribution		
1	Initial	2007-08-20	Fö			
Rev.	Note	Date	Name			

Related Documents

- /1/ Siemens AG, PTD EA
 Manual
 SIPROTEC4 Communication module – PROFIBUS-DP Communication profile
 C53000-L1840-B001-03
 Revision from V4.0
www.siprotec.com
 → Prot.Devices → General information → Communication → Communication protocol descriptions
- /2/ Siemens AG, PTD EA
 Manual
 SIPROTEC4 Communication module
 Device specific PROFIBUS DP Bus mapping documentations
 (one manual per device type, e.g. for 7SJ61/62/63/64, 7UM61, 7UM62, 7SA522/7SA6 etc.)
www.siprotec.com
 → Prot.Devices → General information → Communication → Communication protocol descriptions
- /3/ Siemens AG, PTD EA
 Manual
 SIPROTEC4 Communication modules
 PROFIBUS DP Bus mapping (with redundancy option)
 Bay control unit 6MD663/6MD664
 C53000-L1840-B011-03
 Revision form V2.00
www.siprotec.com
 → Prot.Devices → General information → Communication → Communication protocol descriptions
- /4/ Siemens AG, A&D
 Description and Operating Instruction
 SIMATIC NET PROFIBUS
 Optical Link Modules
 (including OLM/G12)
www.support.automation.siemens.com
- /5/ Siemens AG, PTD EA
 Wide-range Power Supply Unit
 7XV5810-0BA00
www.siprotec.com → Accessories

				Date	2007-08-20	Service Information SIPROTEC 4 Communication Modules PROFIBUS DP / Fiber-optical Ring
				Name	Förster	
				Revised	Dr. Wache	
				Norm.		
				SIEMENS AG		Page 7 / 7
				PTD EA		
				Power Transmission and Distribution		
1	Initial	2007-08-20	Fö			
Rev.	Note	Date	Name			