





Front rotary operating mechanism emergency stop IEC IP30/40  
 Accessory for: 3VA6 150/250 3VA5 250



Model	
Product brand name	SENTRON
Product designation	Accessories
Design of the product	Front rotary operating mechanism
accessories	FRONT ROTARY OPERATING MECHANISM
General technical data	
Degree of protection NEMA rating	NEMA 1
Mechanical Design	
Height	82 mm
Width	105 mm
Depth	102 mm
Certificates	

General Product Approval	EMC	Declaration of Conformity	other
 CSA	 UL		 RCM  EG-Konf. <a href="#">Miscellaneous</a>

#### Further information

**Information- and Downloadcenter (Catalogs, Brochures,...)**

<http://www.siemens.com/lowvoltage/catalogs>

**Industry Mall (Online ordering system)**

<https://mall.industry.siemens.com/mall/en/en/Catalog/product?mlfb=3VA9277-0EK15>

**Service&Support (Manuals, Certificates, Characteristics, FAQs,...)**

<https://support.industry.siemens.com/cs/ww/en/ps/3VA9277-0EK15>

**Image database (product images, 2D dimension drawings, 3D models, device circuit diagrams, ...)**

[http://www.automation.siemens.com/bilddb/cax\\_en.aspx?mlfb=3VA9277-0EK15](http://www.automation.siemens.com/bilddb/cax_en.aspx?mlfb=3VA9277-0EK15)

**CAX-Online-Generator**

<http://www.siemens.com/cax>

**Tender specifications**

<http://www.siemens.com/specifications>

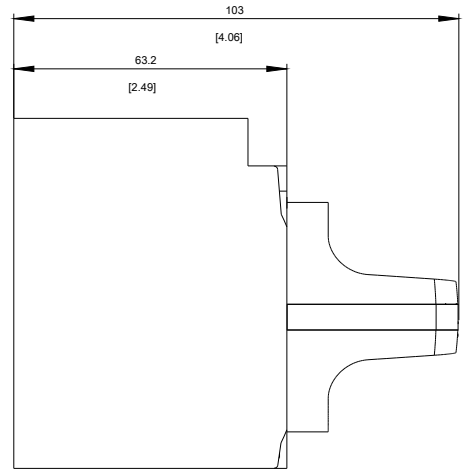
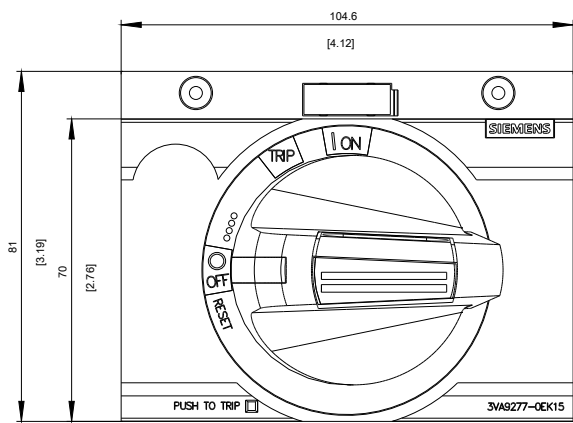

**last modified:**

12/05/2017