

The background of the page features a close-up, high-angle view of two large, cylindrical transformer components. The components are painted a vibrant red and have a metallic, circular top edge. The lighting is dramatic, with strong highlights and deep shadows, emphasizing the industrial and technical nature of the subject. In the top left corner, the Siemens logo is displayed in a white box.

SIEMENS

GEAFOL-Cast-Resin Transformers

Planning Guidelines

[siemens.com/geafol](https://www.siemens.com/geafol)

Contents

GEAFOL – for the highest requirements on location	4
Basic data for planning	5
Technical preconditions	5
Standards and specifications	5
Dimensions and weight	5
Installation requirements	6
Measures for fire protection according to DIN EN 61936-1	6
Classification according to the Ecodesign Directive 2009/125/EC	7
Temperature of the cooling air	8
Special installation conditions	8
Minimum clearances	8
Protection against accidental contact	8
Connection system	9
Connection of the high-voltage side	9
Connection of the HV side using plug-type connectors	9
High-voltage tapplings	9
Connection of the low-voltage side	9
Connection of earthing and short-circuiting devices	9



Temperature Monitoring	10	Noise Level	18
Temperature monitoring with PTC thermistor	10	The sound sensitivity of the ear	
		Approximation of the ear characteristics using instrumentation	18
Transformer: Additional air cooling for improved performance	11	Propagation of noise	19
Fan characteristics	11	Sound power level	19
Efficiency of additional forced-air cooling	11	Dependency of the sound pressure on the distance	19
		Measures for noise reduction: Air-borne noise	20
Ventilation of the Transformer Room	12	Structure-borne noise	21
Assumptions	12	Insulation against structure-borne noise: Dimensioning	21
Calculation the heat losses in the room	12	Insulation against structure-borne noise: Worked example	21
Calculation the heat dissipation	12	Noise level in the room next to the transformer room: Worked example	22
Q_{v1} : Heat dissipation by natural air circulation	12		
Q_{v2} : Heat dissipation through the walls and ceiling	13		
Q_{v3} : Heat dissipation by forced-air circulation	14		
Air ducting	14		
Room ventilation fans	14	EMC of distribution transformers	23
Criteria for choice of room ventilation fans	14		
Rating of the room ventilation fan	14	CE label	23
p_R : Pressure difference due to flow	15		
p_B : Pressure difference due to acceleration	15		
Worked examples	16		
1. Pressure loss due to pipe friction	16		
2. Pressure loss due to single components	16		
Total pressure difference caused by air flow	17		
Result: Total pressure difference of the fan	17		



GEAFOL – for the Most Stringent Local Conditions

Easy to Integrate Anywhere

GEAFOL® cast-resin dry-type transformers are the ideal solution wherever high load densities necessitate provision of power sources close to the load. They give designers the necessary freedom of action, since they facilitate the economic implementation of network concepts, because they are environmentally friendly and safe, and because they allow installation of power sources close to the load without the need for special rooms and precautions. These are aspects which predestinate these distribution transformers for use in buildings.

Your benefit: GEAFOL cast-resin dry-type transformers can be easily integrated anywhere – directly at the site, regardless of whether a commercial or residential building is involved, or an industrial plant, or public transport services.

Requirements stipulated in regulations such as those for fire protection or water conservation can be easily satisfied using GEAFOL cast-resin dry-type transformers. The design employed is not only flame-retardant and self-extinguishing, humidity- and tropic-proof, but is also low-noise. And because a whole range of possibilities are available, matching to the plant is facilitated and planning is more flexible.

These planning guidelines give important tips on how to get the best results using GEAFOL transformers in your plant.

Basic Data for Planning

The basic data for planning your GEA FOL installation are given below

Technical preconditions

All the technical data apply to GEA FOL cast-resin dry-type transformers with the following features:

- Installation in enclosed electrical operating area in accordance with IEC61936-1 (DIN EN 61936)
- Power rating 100 – 3,150 kVA
- Voltages of up to $U_m = 36$ kV

The data also generally apply to

- transformers of over 3,150 kVA
- liquid-immersed transformers in terms of “water conservation and fire protection measures and measures for preservation of functional integrity” in addition to those for “Ventilation” and “Noise”

Standards and specifications

Our GEA FOL transformers meet the requirements of all relevant national, European and international standards (order-related).

Standards

- IEC 60076-11
- DIN VDE 0532
- EN 50541-1 dry-type transformers
50 Hz, 100 – 3,150 kVA, $U_m \leq 36$ kV
- EN 50588-1 medium voltage transformers
50 Hz, $U_m \leq 36$ kV
- Installation within the EU:
Ecodesign Directive 2009/125/EC has to be considered.
- Installation within the USA:
DOE rule 10 CFR Part 431 has to be considered.
- GOST

The following requirements must be taken into account for installation and operation of plants:

- DIN VDE 0100 – for the erection of power installations with rated voltages up to 1 kV
- IEC61936-1 (DIN EN 61936) – for the erection of power installations with rated voltages above 1 kV
- DIN VDE 0105 – for the operation of electrical power installations
- DIN VDE 0141 – for the earthing of power installations with rated voltages above 1 kV

Additional planning and design notes are contained in:

- VDI 2078 – for the calculation of the cooling load in air-conditioned rooms
- AGI J 12 – structural design: Rooms for indoor switchgear up to 36 kV; Worksheet of the Project Group for Industrial Buildings (AGI)

Dimensions and weights

All data regarding dimensions and weights relevant to planning are to be found in the latest edition of our catalog “GEA FOL cast-resin dry-type transformers” (Order No. E50001-G640-K230-X-4A00) and in the catalogue “GEA FOL Basic cast-resin dry-type transformers” (Order No. EMTR-B10005-00-4A00).

The quotation and/or the contractual documents are binding as regards the actual design of the transformers.

Installation Requirements

GEAFOL transformers present the lowest requirements for the point of installation. These are determined by the regulations concerning fire protection and protection from leakage losses according to IEC 61936-1 (DIN EN 61936-1). The requirements of these regulations (from 2011) are compared below for transformers of different design.



Measures for fire protection according to DIN EN 61936-1 (VDE 0101-1), simplified overview

Type of transformer	Class	Safety measures in indoor installations on closed electrical operating sites		Outdoor installations
Liquid-filled transformers (O)	Liquid volume			
	≤ 1,000 l		Walls EI60 resp. REI60	Sufficient distances and/or fire-resistant partition walls
	> 1,000 l		Walls EI90 resp. REI90 or EI60 resp. REI60 plus automatic fire-extinguishing appliance	
Rated power/ maximum operating voltage				
Fire-resistant liquid-filled transformers (K)				Sufficient distances and/or fire-resistant partition walls
Without increased protection	Without limitation		Walls EI60 resp. REI60 or automatic fire-extinguishing appliance	
With increased protection	≤ 10 MVA and $U_m \leq 38$ kV		Walls EI60 resp. REI60 or horizontal distance 1.5 m and 3 m vertical distance	
Dry transformers (A)	Fire class			
	F0		Walls EI60 resp. REI60 or horizontal distance 0.9 m and 1.5 m vertical distance	Sufficient distances or fire-resistant partition walls
	F1		Non-flammable walls	No additional fire protection measures required



Classification according to IEC 60076-11

This standard defines environment, climate and fire classes and in consequence thereof takes into account varying operating conditions existing at the point of installation.

The climate class takes the lowest ambient temperature into account.

Class C1: Indoor installation not under -5 °C
Verification by texting

Class C2: Outdoor installation down to -25 °C
Verification by testing

The climate class is thus also a measure for the fracture toughness of the cast-resin compound.

The environment class takes air humidity, condensation and pollution into account.

Class E0: No condensation, negligible pollution

Class E1: Occasional condensation, pollution to a limited extent only
Verification by testing

Class E2: Frequent condensation or pollution or both simultaneously
Verification by testing

The fire class takes account of the possible consequences of a fire.

Class F0: No provision is made for limitation of the fire hazard

Class F1: Fire hazard is limited as a result of the transformer characteristics
Verification by testing

Important!

In conformity with EN 50541-1 the necessary classes must be defined by the user.

GEAFOL transformers meet the requirements of the highest classes. Defined in IEC 60076-11:

Environment class	C2
Climate class	E2
Fire class	F1

Consequently GEAFOL transformers are:

- reliable – even with condensation and pollution
- are suitable for outdoor installation in an IP 23 protective housing with special paint finish at temperatures down to -25 °C (lower temperatures and special environmental conditions on request)
- offer considerable advantages as regards fire protection

Ecodesign Directive

Transformers that are to be installed within the European Union have to meet the requirements of the Ecodesign Directive 2009/125/EC. The Ecodesign Directive constitutes a framework defining the requirements for the environmentally friendly design of energy-using and energy-related products.

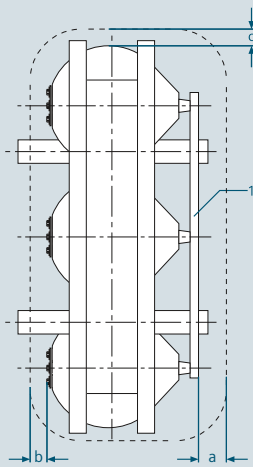

Fig. 1: Minimum clearances around GEA-FOL transformers with safety edge (1)

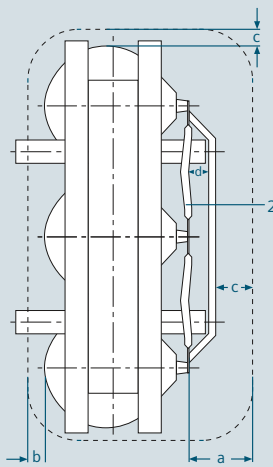

Fig. 2: Minimum clearances around GEAFOL transformers with connection rods (2)



Temperature of the cooling air

Transformers are designed in accordance with the applicable standards for the following cooling air values:

- 40 °C maximum
- 30 °C monthly average of the hottest month
- 20 °C annual average

If operated normally, the transformer should attain its expected lifetime consumption. In particular, the average annual temperature and the load significantly affect the lifetime consumption. Environment temperatures differing from the annual average have an effect on the system's load capacity. (Table 1).

Table 1

Ambient temperature (Average annual temperature)	Load rating
-20 °C	124 %
-10 °C	118 %
0 °C	112 %
+10 °C	106 %
+20 °C	100 %
+30 °C	93 %

Special installation conditions

Extreme local conditions must be taken into account when planning the installation:

- The air humidity and the prevailing temperatures are relevant to use in extreme climatic conditions
- When used at altitudes of more than 1,000 m a special design is needed with regard to heating and insulation (see IEC 60076-11)
- If there are extra severe mechanical stresses at the place of installation (e.g. on ships, excavators and in earthquake areas), it will be necessary to incorporate additional structural features such as bracing of the top yoke.

Minimum clearances

In the case of particularly cramped space conditions, e.g. in protective housings, minimum clearances (Table 2) must be maintained. Voltage flashovers are avoided as a consequence thereof.

Protection against accidental contact

The cast-resin of the transformer winding is not safe to touch when the transformer is energized. For this reason protection against accidental contact must be provided.

Table 2

Maximum voltage of the equipment $U_m^{1)}$ (Effective value)	Rated lightning impulse with stand voltage $U_i^{1)}$		Minimum clearance			
	List 1	List 2	a	b	c	d
[kV]	[kV]	[kV]	[mm]	[mm]	[mm]	[mm]
12	–	75	120	*	50	40
24	95	–	160	*	80	50
24	–	125	220	*	100	70
36	145	–	270	*	120	90
36	–	170	320	*	160	110

¹⁾ see IEC 60071

* If HV tappings are employed on this side, clearance b is equal to clearance a, otherwise clearance b is equal to clearance c.

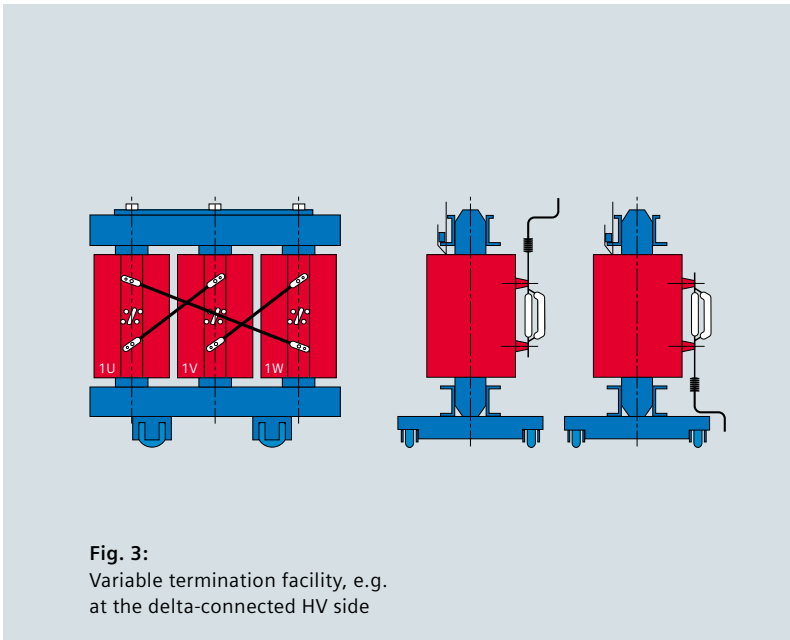

Fig. 3:
Variable termination facility, e.g.
at the delta-connected HV side



Connection System

Practice-oriented options for connection of the high-voltage and the low-voltage side are a distinguishing feature of the flexible connection philosophy of GEA FOL transformers.

Connection of the high-voltage side

In the standard design the HV connection of the transformer is at the top coil connection, connection at the bottom is available as an option (Fig. 3). Screwed circuit connections are used for the delta connection. The transformer connection is made at the end of the connection rods, alternatively at a straight or angled terminal face.

Connection of the HV side using plug-type connectors

Connection of the HV side using external conical plug-type penetrations is possible (Fig. 4).

High-voltage tapplings

The HV tapplings allow matching to local network conditions. The desired tapping can be selected by means of connection straps and screwed connections.

Connection of the low-voltage side

In the standard design the LV connection of the transformer is also at the top coil connection, connection at the bottom is available as an option (Fig. 5). If intermediate expansion links are employed, the LV side connection is protected against mechanical stress and transmission of structure-borne noise.

Connection of earthing and short-circuiting devices

Either straight or angled conical fixed points, of diameter 20 mm or 25 mm, can be mounted at the conductor connections, at the HV side at the connection rods and at the LV side at the conductor terminal face.

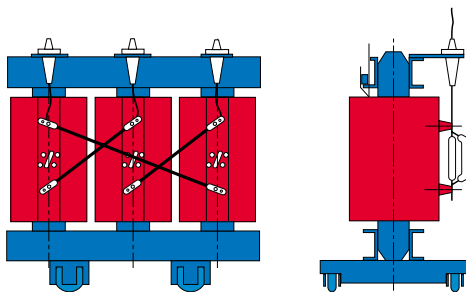

Fig. 4:
Plug-type HV connections

Fig. 5:
LV connection systems on GEA FOL transformers

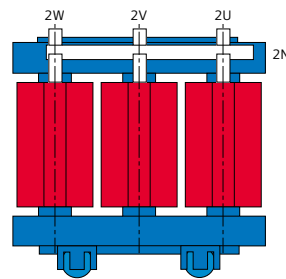

Fig. 5a:
Conductor and neutral
terminal, top

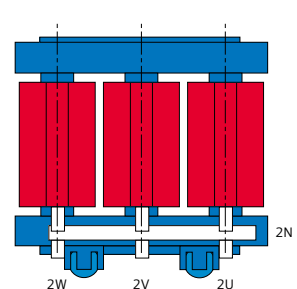

Fig. 5b:
Conductor and neutral
terminal, bottom



Temperature Monitoring

Either PTC thermistor temperature sensors, PT 100 resistance temperature detectors (RTD) or a capillary tube thermometer can be employed for temperature supervision of GEAFFOL transformers.

The temperature of the LV windings are monitored and in addition the core temperature in the case of converter transformers. The most economical solution is monitoring by means of PTC thermistor sensors without indication of the temperature. All GEAFFOL transformers are provided with at least one PTC thermistor sensor circuit for tripping purposes (Fig. 6).

Temperature monitoring by means of PTC thermistor sensors

In the case of three-phase transformers a monitoring system consists of at least one PTC thermistor in the centre or of 3 PTC thermistor sensors connected in series – one sensor per phase – and a tripping device.

The PTC thermistor sensors function as resistances.

When the response temperature is reached, a step-change in resistance occurs and the changeover contact in the tripping device is operated. As soon as the temperature falls below the response temperature by approx. 3 K, the relay coil in the tripping device is once more fully energized and the changeover contact returns to its original position.

When two systems are employed for temperature supervision, one is connected to provide alarm signalling and the other tripping. The rated response temperatures of both systems differ by 20 K. A third system can, for example, be used for fan control. The ambient temperature for the tripping device is limited, e. g. to 55 °C. For this reason installation of the tripping device in the mediumvoltage or low-voltage distribution cubicles is to be recommended.

Typical circuit diagram for temperature monitoring with PTC thermistor sensor

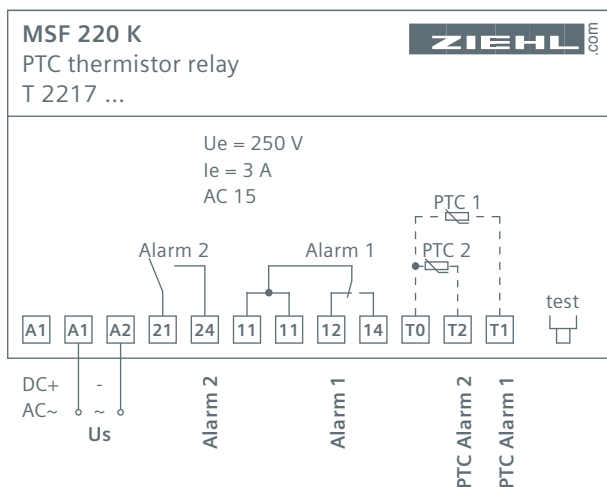

Fig. 6: Connecting diagram of a power supply for the tripping unit for PTC sensors

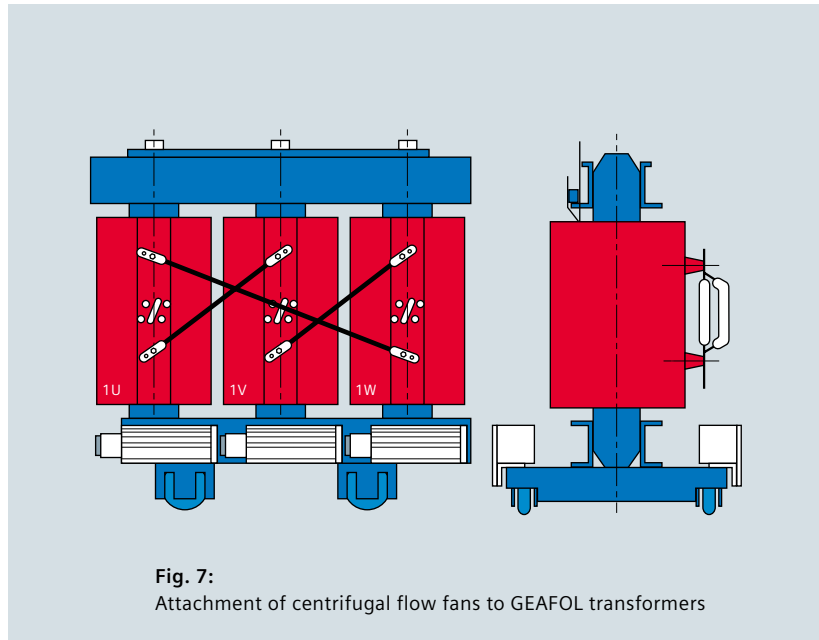

Fig. 7:
Attachment of centrifugal flow fans to GEA FOL transformers

Additional Forced-Air Cooling to Increase the Transformer Power Rating

The output rating of GEA FOL transformers up to 3,150 kVA with degree of protection IP 00 can be increased up to 50 % as a result of mounting centrifugal-flow fans. For example, the continuous power rating of a 1,000 kVA transformer can be increased to 1,500 kVA using this efficient method of forced cooling without exceeding the permissible winding temperatures (Fig. 7).

The rating is then given on the rating plate as rated output:

- 1,000 kVA with type of cooling AN and
- 1,500 kVA with type of cooling AF

Capacity can thus be held in reserve and load peaks of longer duration can be covered. For forced-air cooling 2 or 3 fans are mounted on each of the two longitudinal sides.

Fan characteristics

- Single-phase AC induction motor (external rotor IP 00)
- Sound pressure level as a rule 71– 74 dB (A), and therefore the main factor governing the noise level

A control device is needed for starting the fans as a function of the temperature. The fans are switched off by means of an adjustable time relay incorporated in the control device.

On operation with fans – i.e. cooling type AF with forced-air circulation – the following points must be taken into account:

- Extra space requirement for the fans, e.g. for a 1,000 kVA transformer: Length + approx. 200 mm, width + approx. 250 mm
- The LV connections must be designed so that the air flow at the coils is not interfered with
- The higher power losses of the transformer: The load losses increase as a function of the square of the load. This is of relevance for design of the room ventilation and for the operating costs

Economic efficiency of additional forced-air cooling

The cost of the fans and of fan controls remain practically constant within the output range up to 3,150 kVA.

In the case of power ratings up to 400 kVA, it is generally more economical to select a transformer with a higher output rating than to install forced-air cooling.

Continuous operation at 150 % rated power output is permissible with type of cooling AF; however, in this case the load losses are 2.25 times those at 100 % rated output, for example, in the case of a 1,000 kVA transformer 22.5 kW instead of 10 kW. If a transformer of higher rated power output is used, the load-dependent losses would be lower; however, the no-load losses would be higher.

It can thus be seen that forced-air cooling is not an economical solution for continuous operation but is on the other hand a favorable alternative for making available reserve capacities and for coping with load peaks.

The maintenance costs may also be increased by the use of ventilator fans.



Ventilation of the Transformer Room

Heat losses inevitably occur during operation of transformers. These losses must be dissipated from the transformer room. The first priority is thus investigation of whether natural ventilation is feasible. In cases where this is insufficient, installation of mechanical ventilation (forced-air ventilation) must be considered.

Hints for the following are given below:

- Calculations for simple systems for natural and forced ventilation
- Diagrams and worked examples for dimensioning of ventilation systems
- Efficient specimen ventilation systems

Assumptions

The ambient temperature of the transformers dimensioned in conformity with VDE may not exceed +40 °C (see page 8 – average monthly and annual temperatures). The temperature sensors embedded in the low-voltage windings are matched to this maximum value of coolant temperature plus the winding temperature rise permitted by IEC 60076-11/VDE 0532 and the appropriate hot-spot allowance. It is immaterial whether the transformers are naturally cooled (type of cooling AN) or equipped with fans for raising the output (type of cooling AF). Whatever the circumstances, the ventilation system must always be designed to deal with the maximum heat loss which can occur. Effective cooling can be achieved by admitting cold air at the bottom of the room and exhausting it to the atmosphere from the opposite side just beneath the ceiling. If the air supply is heavily polluted it must be filtered.

Calculating the heat losses in the room

The heat losses are caused by the power losses of the transformer. The power losses of a transformer are:

$$P_v = P_0 + 1.1 \times P_{K120} \times \left(\frac{S_{AF}}{S_{AN}}\right)^2 \text{ (kW)}$$

where:

P_0 : No-load losses (kW)

$1.1 \times P_{K120}$ (kW): Load losses at 120 °C (from the catalog or, if available, from the test certificate) multiplied by the factor 1.1 to obtain the working temperature of class F/F insulation for the HV/LV windings of GEAFOL transformers.

S_{AF} : Rated power with type of cooling AF (kVA)

S_{AN} : Rated power with type of cooling AN (kVA)

The total heat losses in the room (Q_v) is the sum of the heat losses of all the transformers in the room:

$$Q_v = \sum P_v$$

Calculating the heat dissipation

The following methods are available for dissipation of the total heat losses in the room (Q_v):

- Q_{v1} : Heat dissipation by natural air circulation
- Q_{v2} : Heat dissipation through the walls and ceiling
- Q_{v3} : Heat dissipation by forced-air circulation

$$Q_v = P_v = Q_{v1} + Q_{v2} + Q_{v3}$$

Q_{v1} : Heat dissipation by natural air circulation

The following applies to that portion of the heat losses which is dissipated by natural convection:

$$Q_{v1} = 0,1 \times A_{1,2} \times \sqrt{H \times \Delta\theta_l^3} \text{ (kW)}$$

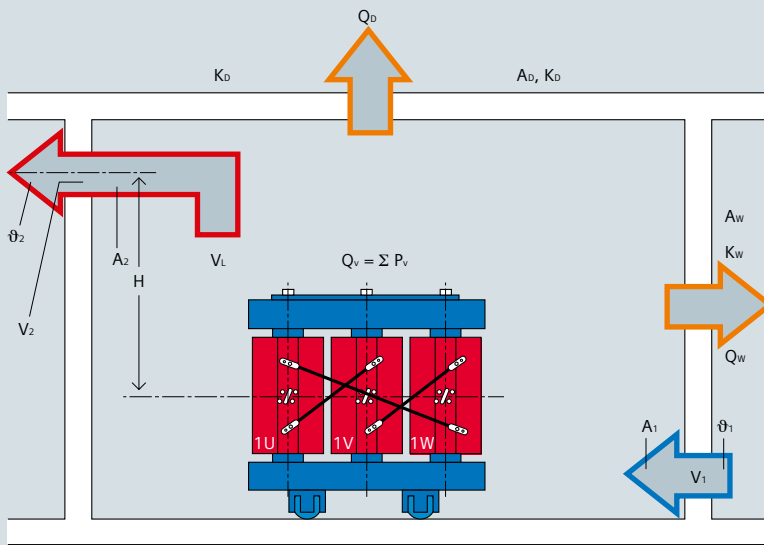

- Q_v : Total dissipated losses (kW)
- P_v : Transformer losses (kW)
- v : Air velocity (m/s)
- $A_{1,2}$: Air inlet/outlet cross section (m²)
- $\Delta\theta_L$: Air temperature rise (K), $\Delta\theta_L = \theta_2 - \theta_1$
- H : Height for thermal purposes (m)
- $Q_{w,D}$: Losses dissipated through the walls and ceiling (kW)
- $A_{w,D}$: Surface area of the walls and ceiling
- $K_{w,D}$: Heat transfer coefficient ($\frac{W}{m^2 \cdot K}$)
- Subscripts: W – wall, D – ceiling
- V_L : Air flow rate (m³/s)
- Fresh air supply
- Warm exhaust air
- Exhaust heat dissipation

Fig. 8:
Data for ventilation calculation

For symbols refer to text of Fig. 8:
The nomogram in Fig. 9 can be used for solving by graphical means.

Worked example for cooling by means of natural convection.

Given:

- $Q_{v1} = \sum P_v = 10 \text{ kW}$
- $H = 5 \text{ m}$; $\Delta\theta_L = \theta_2 - \theta_1 = 15 \text{ K}$ (empirical value)

To be calculated:

- Inlet and outlet air flow rate V_L
- Inlet and outlet cross section $A_{1,2}$
(Q_{v2} is neglected here)

Using the nomogram in (Fig. 9):

The first straight line is to be drawn from $Q_{v1} = 10 \text{ kW}$ to $\Delta\theta_L = 15 \text{ K}$. It intersects the scale V_L at $0.58 \text{ m}^3/\text{s}$ – the sought value of the air flow rate.

This implies:

Approx. 200 m³/h air per kW heat losses are required at $\Delta\theta_L = 15 \text{ K}$ (approximate value).

A second straight line should be drawn from the intersection point of the first straight line with the borderline (to the right of the V_L scale) to $H = 5$. This line intersects the $A_{1,2}$ scale at 0.78 m^2 – this is the sought value for the free cross section of the air inlet and outlet. The flow resistances for the inlet opening with a wire grid of mesh size 10 – 20 mm and for the outlet opening with fixed louvers have been taken into account in the nomogram. Use of a wire mesh instead of fixed louvers at the outlet opening reduces the required cross section by 10 %. Where applicable, all parts causing constriction of the cross section must be taken into account by corresponding increase of the cross section.

Q_{v2} : Heat dissipation through the walls and ceiling

The following applies to that portion of the heat losses which is dissipated by natural convection:

$$Q_{v2} = (0.7 \times A_w \times K_w \times \Delta\theta_w + A_D \times K_D \times \Delta\theta_D) \times 10^{-3} \text{ (kW)}$$

where:

- $K_{w,D}$ = Coefficient of heat transmission (table 3)
- $A_{w,D}$ = Surface area of the walls and ceiling
- $\Delta\theta_{w,D}$ = Temperature difference, indoors/outdoors (see also Fig. 8)

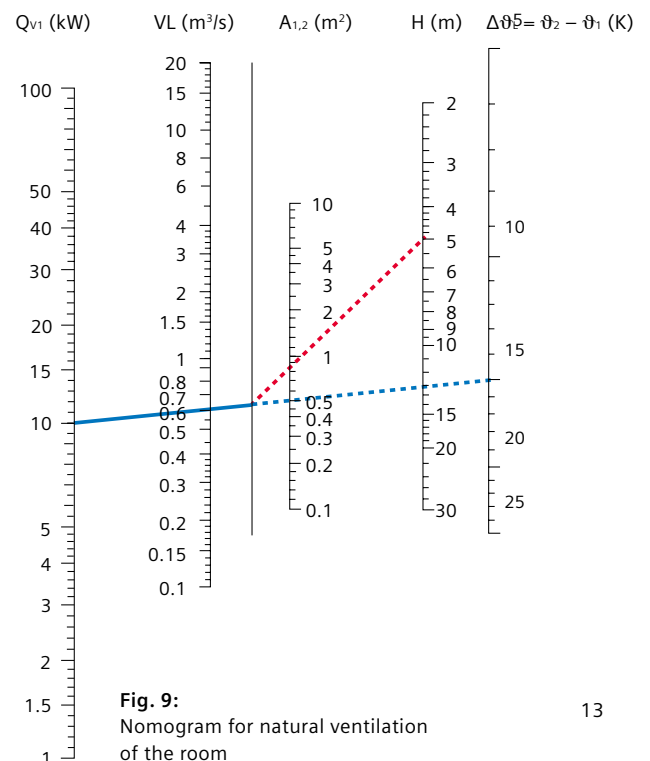

Fig. 9:
Nomogram for natural ventilation of the room



Q_{v3} : Heat dissipation by forced-air circulation

That part of the heat loss Q_{v3} , dissipated by forced-air circulation, usually proves to be much larger than the components Q_{v1} and Q_{v2} . In practice for calculation of Q_{v1} forced-air cooling the following applies: Assume that $Q_{v3} = \sum P_v$. Consequently all ventilation is attributed to forced-air circulation and Q_{v1} and Q_{v2} provide a safety margin. The heat dissipation by forced-air circulation is:

$$Q_{v3} = V_L \times C_{PL} \times \rho_L \times \Delta\vartheta_L \text{ (kW)}$$

where:

- V_L = Air flow rate in (m³/s)
- C_{PL} = Thermal capacity of air:
= 1.015 $\frac{\text{kWs}}{\text{kg} \times \text{K}}$
- ρ_L = Air density at 20 °C
= 1.18 kg/m³
- $\Delta\vartheta_L$ = Air temperature rise (K)
= $\vartheta_2 - \vartheta_1$

The nomogram in Fig. 10 makes use of this equation. It is thus possible, for example, to determine the following parameters for an air velocity of 10 m/s in the air ducting and for different temperature differences $\Delta\vartheta_L$:

- Air flow rate of the air to be exhausted
- Cross section of the air ducting
- Cross section for air inlet/outlet (approx. 4 x duct cross section).

The following relationship exists for the ratio of the air flow rate V_L , air velocity v and the average cross section A :

$$V_L = v \times A$$

An air velocity of 0.6 to 0.7 m/s can be tolerated in transformer rooms. If the room is not accessible, higher values of air velocity can be selected.

Air ducting

The air ducting should be made of galvanized sheet steel or plastic (not PVC). It can be of either rectangular or circular cross section. Installation of a fire damper in the air duct is mandatory, where the air duct penetrates a fire wall. The inlet and outlet grids should prevent the ingress of foreign objects and vermin. The following points should be taken into account:

The calculated inlet/outlet cross section of the air grids should be multiplied by a factor of 1.7 because the effective open cross section of the grids is only approx. 60 %. Adjustable louvers permit more accurate setting of the inlet air flow rate.

Room ventilation fans

Box-type, centrifugal or axial-flow fans can be used for room ventilation. These are available from various suppliers. The required total pressure difference (N/m²) is of particular importance for selection of the room ventilation fan. For calculation of this value reference should be made to the Section "Power rating of the room ventilation fan" on page 15. It may be necessary to employ sound dampening to reduce the operational noise of the room ventilation fan. The silencers are installed in the air ducts.

The following points should be taken into account: The normal noise level can be amplified as a result of special local conditions. And: If a number of air ventilation fans are in operation, the noise levels are summated; (refer to page 18 "Noise").

Criteria for selection of the room ventilation fan

The following criteria should be checked for selection of the room ventilation fan:

- Air delivery rate (m³/h) as a function of the pressure (N/m²)
- Speed in operation (to keep the noise level as low as possible: max. 600 – 800 min⁻¹)
- Operating voltage V
- Power rating kW
- Frequency Hz
- Sound pressure level dB(A)



Heat transfer coefficient, some examples

Material	Thickness cm	Heat transfer coefficient K ^{*)} W/m ² K
Light	10	1.7
	20	1.0
	30	0.7
Burnt brick	10	1.7
	20	1.0
	30	0.7
Concrete	10	1.7
	20	1.0
	30	0.7
Metal	–	6.5
Glass	–	1.4

*) The heat transfer coefficient K includes the conduction and transfer of heat at the surfaces

Table 3

Power rating of the room ventilation fan

The drive rating P of the room ventilation fans is given by the following equation:

$$P = \frac{p \times V_L}{3.6 \times 10^6 \times \eta} \text{ (kW)}$$

where:

- p = Total pressure difference due to air flow (N/m²):
p = p_R + p_B
- V_L = Air flow rate (m³/h)
- η = Efficiency of the fan (0.7... 0.9)

p_R: Pressure difference due to flow

The pressure p_R difference occurs as a result of:

- the frictional resistance p_R in the straight duct = duct length L x specific duct frictional resistance p_{RO}
- individual resistances due to bends, branches, grids and changes in cross section

Average values should be used in the case of "free extraction" and "free delivery".

p_B: Pressure difference due to acceleration

The following equation is valid for the pressure difference p_B (N/m²) due to acceleration:

$$p_B = 0.61 \times v_K^2 \text{ (N/m}^2\text{)}$$

where:

- v_K = Air velocity (m/s) in the duct
- V_L = Air flow rate (m³/h)
- A_K = Duct cross section (m²)

$$\text{where: } v_K = \frac{V_L}{3,600 \times A_K}$$

Approximate values for the pressure loss caused by p_R are:

Wall mounting, including louvers	approx. 40 – 70 N/m ²
Louvers	approx. 10 – 50 N/m ²
Grids	approx. 10 – 20 N/m ²
Silencers	approx. 50 – 100 N/m ²

Table 4

Nomogram for forced ventilation of the room

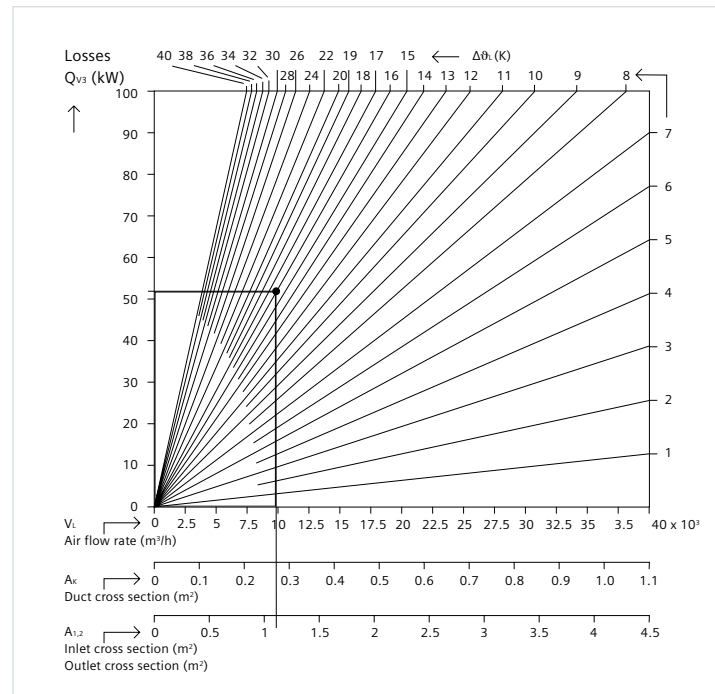

Fig. 10:
Nomogram for forced ventilation of the room with V_{duct} = 10 m/s

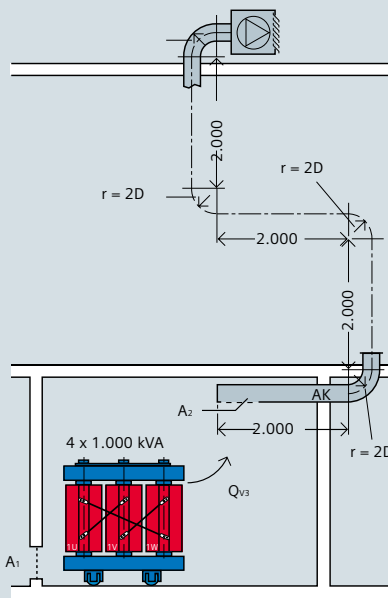

Fig. 11:
Diagram of the forced ventilation system for the worked example



Worked example for forced-air circulation – refer to (Figs 10 and 11). Given:

- 4 GEAFOL transformers, each rated at 1,000 kVA
- Total heat losses

$$Q_{v3} = \sum P_v = 4 \times 12.9 \text{ kW} = 51.6 \text{ kW}$$

(Q_{v1} and Q_{v2} are neglected and represent a safety margin)

- 40 °C max. cooling air temperature to IEC 60076-11/VDE 0532 ((special measures are necessary in tropical environments with $\vartheta_1 > 40$ °C: precooling of the air, reduction of the transformer output rating, or installation of transformers designed for the relevant higher ambient temperature)
- Temperature difference $z \Delta\vartheta_L = 16 \text{ K}$

Using the nomogram (Fig. 10, page 15) the following are found:

- Flow rate of the cooling air: 10,000 m³/h
- Cross section of the air duct: 0.28 m²
- Air inlet cross section 1.12 m²

Fig. 11 depicts a ventilation system with the following components:

- 1 extraction ventilator (room ventilation fan)
- 1 louver damper
- 4 90° bends, $r = 2D$
- 8 m galvanized sheet-steel, straight cross section 0.7 x 0.4 m
- 1 outlet grid, free area: approx. 1.12 m²
- 1 inlet grid, free area: approx. 1.12 m²

The total pressure difference of the fan is obtained as follows:

- Pressure loss due to flow
- Pressure loss due to acceleration:

$$p = p_R + p_B$$

Determining of the components:

p_R: Pressure difference due to flow

The pressure loss due to flow is the sum of the following losses:

1. Frictional resistance in the duct
2. The resistances of individual components

1. Pressure loss due to frictional resistance in the ducting

The pressure loss per metre duct can be read off the scale in the nomogram (Fig. 12): as the intersection of the straight lines connecting the already determined values for V_L and A_K or D , as the case may be. A_K applies to ducts of rectangular cross section and D to ducts of circular cross section.

In our example – connecting straight line Fig. 12 – the specific frictional resistance per metre duct is found to be

$$p_{RO} = 1.5 \frac{\text{N}}{\text{m}^2 \times \text{m}}$$

For a total duct length L of 8 m:

$$p_R = p_{RO} \times L = 1.5 \times 8 = 12 \text{ Pa}$$

2. Pressure loss due to individual components

The values for the pressure loss due to individual components are found from Fig. 12 and Table 4 (page 15).

In the example:

4 90° bends, $r = 2D$, $v_K = 10 \text{ m/s}$	
each 12,0 Pa	48 Pa
1 inlet grid	20 Pa
1 outlet grid	20 Pa
1 louver (exhaust)	50 Pa

$$\sum p_R = 138 \text{ Pa}$$



Total pressure difference due to flow
 The total pressure difference due to flow is thus

$$p_R = \text{Sum of the frictional losses} \\ = 12 + 138 = 150 \text{ Pa}$$

p_B : Pressure difference due to acceleration
 p_B (Pa) is found from the equation:
 $p_B = 0.61 \times v_K^2$ (v_K in m/s)

In the example: $v_K = 10$ m/s
 The pressure difference due to acceleration is found to be:

$$p_B = 0.61 \times 10^2 = 61 \text{ Pa}$$

Result: Total pressure difference of the fan

The total pressure difference of the ventilation fan is thus for the example given:

$$p = p_R + p_B = 150 + 61 = 211 \text{ Pa}$$

It is therefore necessary to use a ventilation fan with an air delivery rate of 10,000 m³/h and a total pressure difference of 211 Pa. It is usually not necessary to calculate the drive power, if the manufacturer is given the delivery rate and the total pressure difference of the fan.

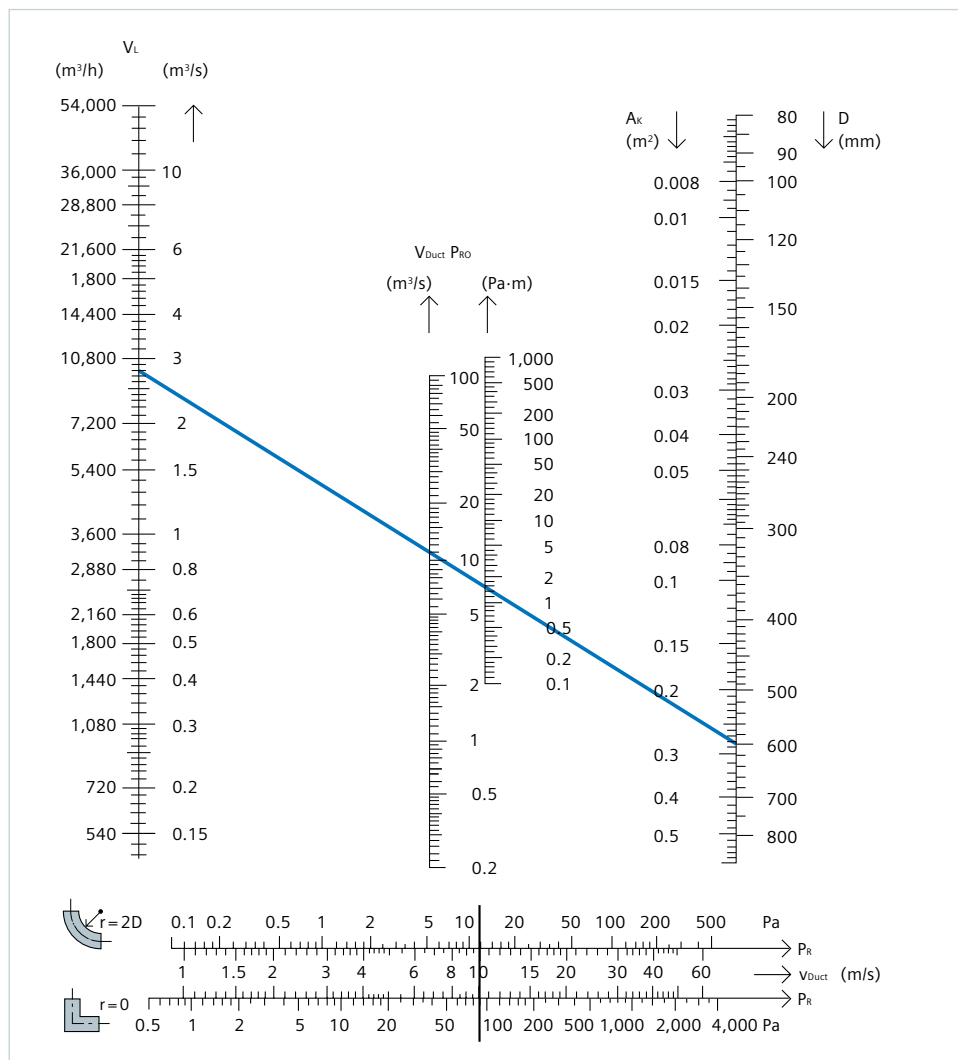

Fig. 12:
 Nomogram for determining of the pressure difference of air ducting – here for air density 1.18 kg/m³ and 20 °C. For the scale designations refer to Fig. 10, (page 15).

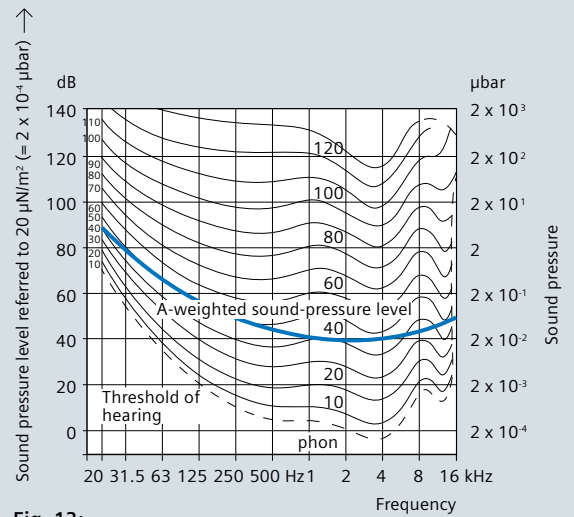

Fig. 13: Threshold of hearing and curves of equal loudness for sinewaves for binaural listeners in an open sound field

Noise Level

Special design measures have reduced the noise level of GEAFOL cast-resin dry-type transformers to that of oil-immersed transformers. The noise level values are to be found in the catalog "GEAFOL cast-resin transformers 100 kVA to 16,000 kVA", order-no. E50001-G640-K230-X-4A00.

These values meet the requirements of the standard. Noise is caused as a result of magnetostriction of the core laminations. In the case of distribution transformers noise is dependent on the induction and not on the load. The noise level can be increased by voltage harmonics, e.g. caused by converter operation.

The sound sensitivity of the ear

Sound in the present context is defined as compressive oscillations of the elastic medium air within the audible frequency range. The ear interprets the frequency of such compressive oscillations as pitch and the pressure amplitude as loudness.

While the amplitude of the alternating sound pressure p and the frequency can be measured precisely as physical parameters, the subjective sensitivity of the ear to noise cannot be measured directly.

Oscillations with frequencies below 16 Hz and above 16 kHz are not interpreted as sound by the ear. The receptivity of the ear for sound pressure extends from $2 \times 10^{-4} \mu\text{bar}$ at the hearing threshold to $2 \times 10^3 \mu\text{bar}$ at the pain threshold.

This extensive pressure range is subdivided on a logarithmic basis. Ten-fold increase of the sound power P with respect to the reference value is defined as 1 Bel = 10 Dezibel (dB). (The sound power level P is proportional to the square of the sound pressure p).

The following relationships are thus obtained for the "sound level" L :

$$L = 10 \lg \frac{P}{P_0} = 10 \lg \frac{p^2}{p_0^2} \text{ (dB)}$$

The sound pressure of approx. $2 \times 10^{-4} \text{ bar}$ at the threshold of hearing is the reference value p_0 .

$$(1) L = 20 \lg \frac{p}{p_0} \text{ (dB)}$$

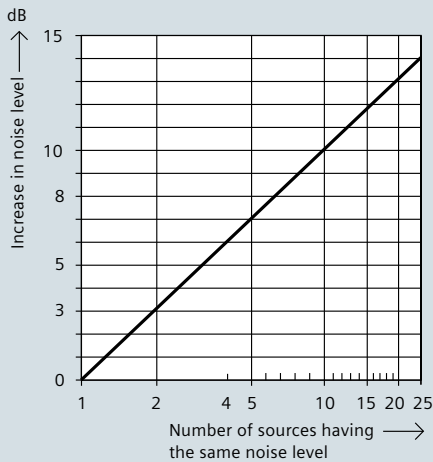

Fig. 14: Increase in noise level for a number of sound sources having identical sound level



Bild 15: L_{SR} value as a function of distance R

In the sound sensitive range of the ear defined by frequency and sound pressure, viz. the auditory sensation area (see Fig. 13), sound sensations with identical sound pressure p but of different frequency are not experienced as being identically loud. For this reason the auditory sensation area is divided into curves of identical "loudness".

Approximation of the ear characteristics using instrumentation

Evaluation of noise by measurement of the sound level must take frequency-dependent ear sensitivity into account. Low and high frequencies measured within the noise spectrum must be evaluated to a greater extent than medium frequencies (filtered out) in a manner corresponding to the curves of equal loudness.

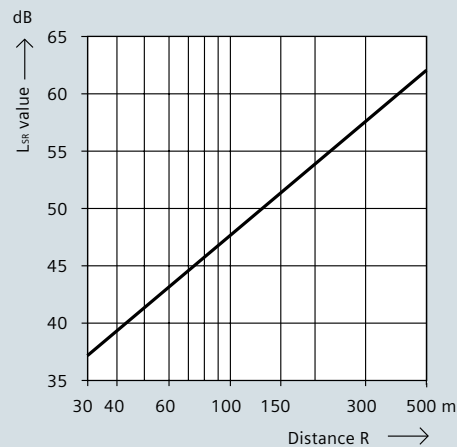
The evaluation curve A (see Fig. 13) represents an approximation of the curve of equal loudness within the frequency range up to 500 Hz.

Propagation of noise

Operational noise of transformers is propagated locally in the form of airborne noise and structure-borne noise. Different noise reduction measures must be used for each type of noise. Main objective of noise reduction: Compliance with the specified values at the site boundaries or at the boundary of an adjacent site.

Sound power level

The sound power level provides a measure of the noise produced by a sound source. It characterizes the noise of the source and – in contrast to the sound pressure level – is independent of the point of measurement and of the acoustical properties of the environment. The method for determining the sound power level L_{WA} is given in IEC/EN 60076-10 (VDE 0532 T76-10). Noise power levels are maximum values without tolerance.

The noise power level is to be determined as follows: Determining the sound pressure level L_{pA} on a defined enveloping surface around the transformer plus logarithm of the enveloping surface S .

As an equation:

$$L_{WA} = L_{pA} + L_S$$

where:

the value for the enveloping surface $L_S = 10 \times \lg \frac{S}{S_0}$ (refer to Table 5) $S_0 = 1 \text{ m}^2$

Dependency of the sound pressure on the distance

L_{pA} = audible and measurable sound pressure level at a distance $R \geq 30 \text{ m}$ using the equation given above it follows that:

$$L_{pA} = L_{WA} - L_{SR}$$

where $L_{SR} = 10 \lg \frac{S}{S_0}$

The diagram in (Fig. 15) depicts the value L_{SR} as a function of the distance R . It is thus easily possible to determine the magnitude of the sound pressure level L_{pA} of a transformer at a specific distance (refer also to DIN EN 60551).

An example:

$$L_{WA} = 70 \text{ dB and } R = 35 \text{ m}$$

Using these values in the diagram:

$$L_{SR} = 39 \text{ dB}$$

Consequently the free-field sound pressure level is:

$$L_{pA} = 70 \text{ dB} - 39 \text{ dB} = 31 \text{ dB}$$

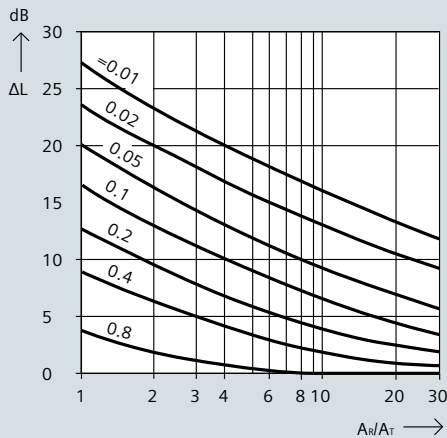

Fig. 16:
Increase in operational noise in the transformer room due to reflection

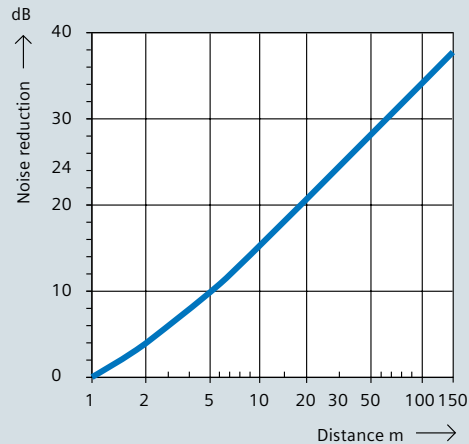

Fig. 17:
Reduction of the noise pressure level as a function of the distance



Measures for noise reduction – air-borne noise

Air-borne noise is amplified by reflections at the walls and ceiling of the transformer room. The following parameters are of relevance for sound reflection:

- A_R = total surface area of the room
- A_T = transformer surface area
- α = acoustical absorption coefficient of the walls and ceiling

Fig. 16 shows how these factors determine noise generation.

Some examples of the acoustical absorption coefficient α for different building materials are given below, here for 125 Hz.

S_T (kVA)	A_T (m ²)	L_s 0,3 (dB)
100	3.8	6.0
160	4.4	6.5
250	4.7	7.0
400	5.5	7.5
630	6.4	8.0
1,000	8.4	9.0
1,600	10.0	10.0
2,500	14.0	11.5

Table 5
Transformer surface area A_T (approx. figure) with the corresponding value for the enveloping surface L_s

It is thus possible to reduce the operational noise due to reflections by lining the transformer room, e.g. to a very significant extent by means of mineral wool.

This effect is evident in Fig. 16. The sound pressure level in the room is attenuated on propagation through the walls.

Examples for the insulating effect:

- Brick wall, 12 cm thick = 35 dB (A) insulation
- Brick wall, 24 cm thick = 39 dB (A) insulation

The insulating effect of doors and air ducting must be taken into account; as a general rule they reduce the room insulating effect. The sound pressure level outside the transformer room is continuously reduced depending on the distance (see Fig. 17).

Building materials for transformer room	Acoustical absorption coefficient α
Brick wall, unplastered	0.024
Brick wall, plastered	0.024
Concrete	0.01
3 cm glass-fibre panel on hard backing	0.22
4 cm mineral wool with smooth board covering	0.74

Table 6

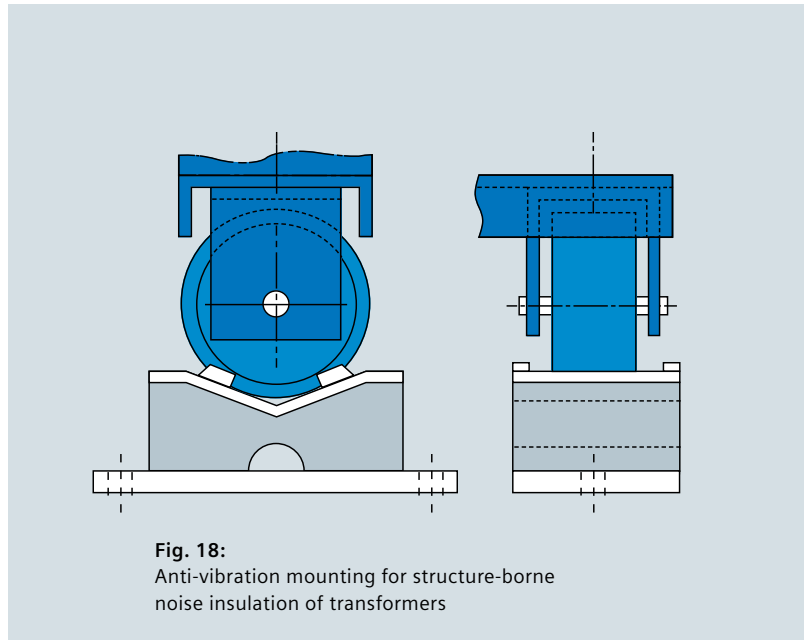

Fig. 18:
Anti-vibration mounting for structure-borne noise insulation of transformers

Structure-borne noise

Transformer noise is propagated via the contact surfaces between the transformer and the floor to the walls and other parts of the transformer room. Structure-borne noise insulation of the transformer reduces or completely interrupts sound propagation via this path.

The magnitude of the primary operation noise cannot be reduced by this method.

However: The room insulation is optimized as a result of provision of structure-borne noise insulation. In many cases it is thus possible to completely dispense with cladding of the walls using acoustical absorption material, e.g. with mineral wool. Resilient walls and special anti-vibration mountings (see Fig. 18) are employed for structure-borne noise insulation of GEA FOL transformers.

And: Elastic adapters are available for the bus-bar connection of low-voltage switchgear, thus ensuring optimum structure-borne noise insulation in the entire transformer room.

Insulation against structure-borne noise: Dimensioning

In order to achieve adequate insulation of structure-borne noise, the natural frequency of the vibration system comprising the transformer and insulating device must be low in relation to the exciting frequency. Proven in practice: Insulating devices, whose elastic compression s is at least 2.5 mm under the weight F of the transformer.

The maximum permissible load of the insulating devices must be taken into account: the spring constant C_D (N/cm).

It is calculated as follows:

$$C_D = \frac{F}{s}$$

Structure-borne noise insulation: worked example

An example for calculation of structure-borne noise insulation is given below:

- 1 GEA FOL cast-resin dry-type transformer rated at 1,000 kVA
- Transformer mass: 2,630 kg
- 4 mountings for insulation
- Location: Basement – e.g. on a solid foundation, resulting elastic compression $s = 0.25$ cm
- $g =$ gravitational acceleration $= 9.81 \frac{m}{s^2}$

Solution:

The force (F) per supporting point is:

$$F = \frac{\text{Transformer mass} \times g}{\text{Number of mounting points}}$$

In this case

$$F = \frac{2,630 \times 10}{4} = \text{approx. } 6,575 \text{ N}$$

The required spring constant is thus:

$$C_D = \frac{F}{s} = \frac{6,575}{0.25} = 26,300 \text{ N/cm}$$

For ordering purposes the following is recommended: Selection of 4 mounting devices with spring constant $\leq 23,400$ N/cm and $\geq 8,500$ N permissible steady-state continuous load.

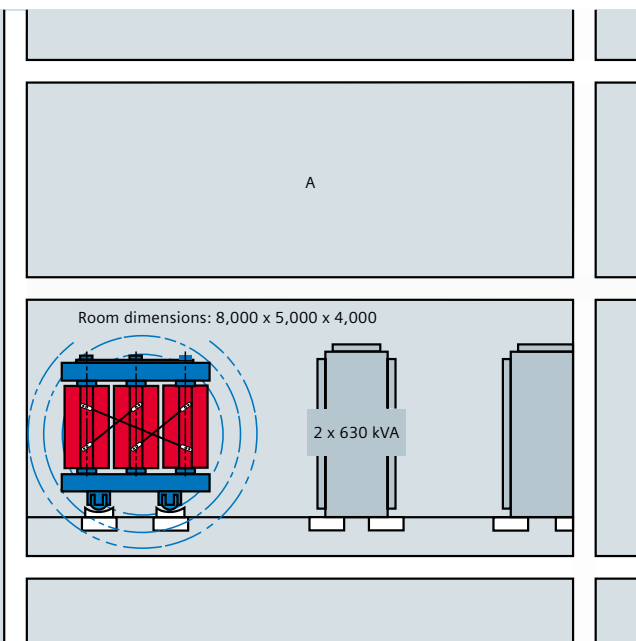

Fig. 19:
Diagram of the worked example



Special features:

Increased oscillation of the foundation is to be expected, if the transformer is installed on an upper floor of a building. In this case an elastic compression s of up to 0.5 cm is recommended.

Noise level in the room next to the transformer room: worked example

In this example, the approximate noise level in the room A adjacent to the transformer room is to be calculated (see Fig. 19).

The following parameters are known:

- 2 GEAFOL cast-resin dry-type transformers each rated at 630 kVA
- Structure-borne noise insulation has been provided
- Air-borne noise propagation to room A through the floor only
- Transformer room inner surface $A_R = 184 \text{ m}^2$; adjacent room A has the same dimensions
- Surface area of a transformer $A_T = 6.4 \text{ m}^2$
- Floor area of the room $A_F = 40 \text{ m}^2$;
- Walls of concrete, 24 cm thick

Solution:

Sound power level of the transformer from catalog or diagram, (Fig. 13, page 18):

$$L_{WA} = 70 \text{ dB}$$

The following equation gives the sound pressure near the transformer ($\approx 1 \text{ m}$):

$$L_{pA} = L_{WA} - L_s 0.3 \text{ m} - 5 \text{ dB};$$

5 dB is the attenuation of the noise level on increase of the distance

$L_s = 0,3 \text{ m}$ auf 1 m; where:

$$L_s = 0,3 \text{ m} \approx 10 \lg \frac{A_T}{1 \text{ m}^2} = 10 \lg 6.4 = 8 \text{ dB}$$

Thus the sound pressure is:

$$L_{pA} = 70 - 8 - 5 = 57 \text{ dB (A)}$$

The following relationship applies for noise amplification due to reflection:

$$\frac{A_R}{A_F} = \frac{184 \text{ m}^2}{6.4 \text{ m}^2} = 29$$

For an acoustical absorption coefficient $\alpha = 0,01$ (concrete walls), from the diagram

$$\Delta L = + 12 \text{ dB (A)}$$

plus

as per diagramm, (Fig. 14, page 19)

Increment for 2 transformers (2 sound sources) + 3 dB (A)

This results in

$$57 \text{ dB (A)} + 12 \text{ dB (A)} + 3 \text{ dB (A)} = 72 \text{ dB (A)}$$

minus

insulation by concrete ceiling (24 cm) = 39 dB

Thus the sound pressure level propagated to room A = 33 dB (A).

To this must be added: Amplification of the sound pressure level in the adjacent room (of identical size) due to reflection:

$$\frac{A_R}{A_F} = \frac{184 \text{ m}^2}{40 \text{ m}^2} = 4.6$$

For an acoustical absorption coefficient $\alpha = 0.6$ in the adjacent room (estimated with carpets, curtains, etc.) we find from the diagram, (Fig. 16, page 20), that:

$$\Delta L = + 3 \text{ dB (A)}$$

Result:

The total sound pressure level in room A is:

$$33 + 3 = 36 \text{ dB (A)}$$



EMC of Distribution Transformers

Electrical and magnetic fields occur on operation of transformers. The electric field of oil-immersed and GEAFOLE transformers and of their connections has practically no effect outside the transformer cell or the enclosure of the transformer. The tank and the covers of oil-immersed transformers and the protective housing of GEAFOLE transformers act as Faraday cages. This also applies to a considerable extent to the ceiling and walls of the transformer cells, provided these are not constructed of insulating material.

Interference can be caused by the magnetic fields. The stray field of a GEAFOLE transformer of rated output 630 kVA and a short-circuit voltage of 6 % is approx. 5 µT at rated load at a distance of 3 m from the transformer; the equivalent value for an oil-immersed transformer with identical data is approx. 3 µT.

The approximate value for the magnetic field in the range from a = 1 to 10 m for GEAFOLE transformers of varying ratings and short-circuit voltages can be found using the following equation:

$$B = 5 \mu\text{T} \frac{u_z}{6\%} \sqrt{\frac{S_n}{630 \text{ kVA}}} \left(\frac{3\text{m}}{a}\right)^{2.8}$$

In the case of oil-immersed transformers the initial value is approx. 3 µT.

The 26th implementation order for the Federal Environmental Protection Law (Regulations for electromagnetic fields – 26. BimSchV) dated December 16, 1996, allows a maximum electric field strength of 5 kV/m and a maximum magnetic flux density of 100 µT at the exposure point for 50 Hz fields.

The point of exposure is the point with the most marked effect, to which persons can have access over appreciable periods of time.

The electric fields outside the transformer cell or the enclosure and the magnetic field at distances in excess of 3 m do not come anywhere near the permitted limit values in the case of distribution transformers.

Interference can be caused to computer monitors from approx. 1 µT. Detailed information is to be found in the leaflet „Distribution transformers and EMC“ (order no. E50001-G640-A132-V2-4A00).

CE marking

1. Transformers are to be considered as passive elements in accordance with IEC 60076-11. CE marking is not permissible in accordance with the COTREL statement.

This applies to transformers which do not fall under the Ecodesign Directive 2009/125/EC although they will be installed within the European Union.

2. From July 2015, transformers put into circulation within the European Economic Area (EEA) must comply with the ecodesign requirements in the new directive if they fall within its scope of applicability. Since the directive is a measure for implementing the Ecodesign Guideline 2009/215/EG, the CE marking is used as proof of compliance and a corresponding EU conformity certificate is issued. The aforementioned guideline does not apply for to products manufactured for export to other countries outside the EEA. Products already in circulation and in operation may continue to be operated.

Published by Siemens AG 2015

Energy Management Division
Freyeslebenstrasse 1
91058 Erlangen, Germany

Transformatorenwerk Kirchheim
Energy Management Division
Transformers
Hegelstrasse 20
73230 Kirchheim/Teck, Germany
Phone: +49 (0) 7021 508-0
Fax: +49 (0) 7021 508-495
www.siemens.com/energy-support

Siemens Transzformátor Kft.
1214 Budapest
II. Rákóczi Ferenc u.189., Hungary
Phone: +36 (1) 278 53 00
Fax: +36 (1) 278 53 35

For more information, please contact
our Customer Support Center.
Phone: +49 180 524 70 00
Fax: +49 180 524 24 71
(Charges depending on provider)
E-Mail: support.energy@siemens.com

Article-No. EMTR-B10008-00-4A00
Printed in Germany
Dispo 19201, SIMC-0000-46274
L 214058 WS 12151.

Subject to changes and errors.

The information given in this document only contains general descriptions and/or performance features which may not always specifically reflect those described, or which may undergo modification in the course of further development of the products. The requested performance features are binding only when they are expressly agreed upon in the concluded contract.