

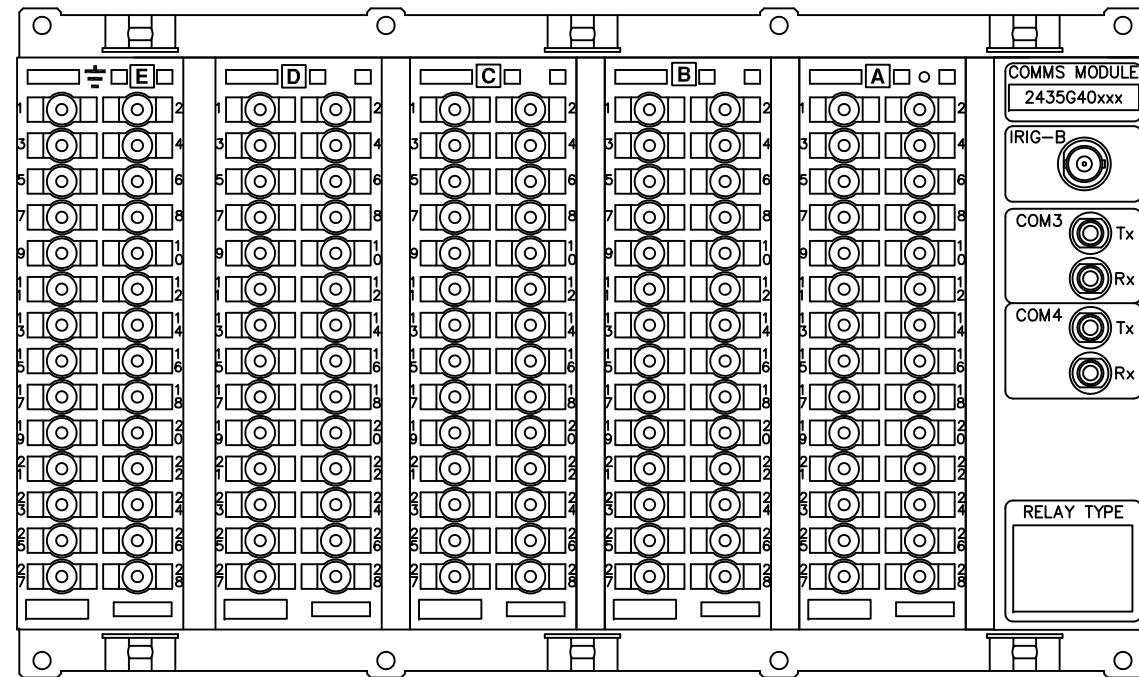

IF IN DOUBT ASK
DO NOT SCALE

ABBREVIATIONS	
I-	CURRENT INPUTS
V-	VOLTAGE INPUTS
BI-	BINARY INPUTS
BO-	BINARY OUTPUTS
CO-	CHANGE OVER BINARY OUTPUT CONTACTS
NO-	NORMALLY OPEN BINARY OUTPUT CONTACTS
NC-	NORMALLY CLOSED BINARY OUTPUT CONTACTS

COMMUNICATIONS IDENTIFICATION	
COM1	RS485 (ON BLOCK 'B' TERMINALS 14,16,18 & 20)
COM2	USB TYPE 'B' PORT (ON RELAY FRONT LABEL)
COM3	FIBRE OPTIC (ON REAR COMMS MODULE)
COM4	FIBRE OPTIC (ON REAR COMMS MODULE)



RELAY VIEWED FROM REAR

NOTES

- TERMINALS RECOMMENDED ARE PRE-INSULATED & MUST BE CRIMPED USING APPROVED TOOLING. AMP PIDG OR PLASTI GRIP FUNNEL ENTRY (RING TONGUE) FOR M4 FIXING STUD.
- FOR OUTLINE & PANEL DRILLING, SEE 2995X10010 (A4).
- CONNECTIONS TO THIS COMMUNICATIONS FACILITY IS BY SCREENED, TWISTED PAIR CABLE, ON SITE. WHEN WIRING OTHER FACILITIES ENSURE THAT THESE TERMINALS ARE NOT OBSCURED BY OTHER WIRE RUNS.
- CONTACTS SHOWN THUS ARE INTERNAL RELAY CASE ASSEMBLY AND CLOSE WHEN THE RELAY CHASSIS IS WITHDRAWN FROM THE CASE.

**NOT SUBJECT TO UPDATE
ONCE COPIED / PRINTED
OR DOWNLOADED**

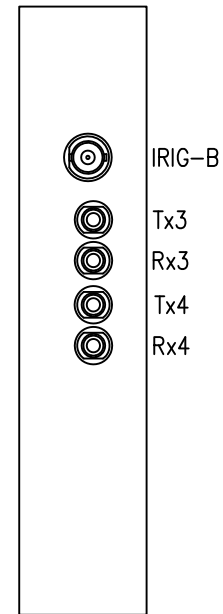
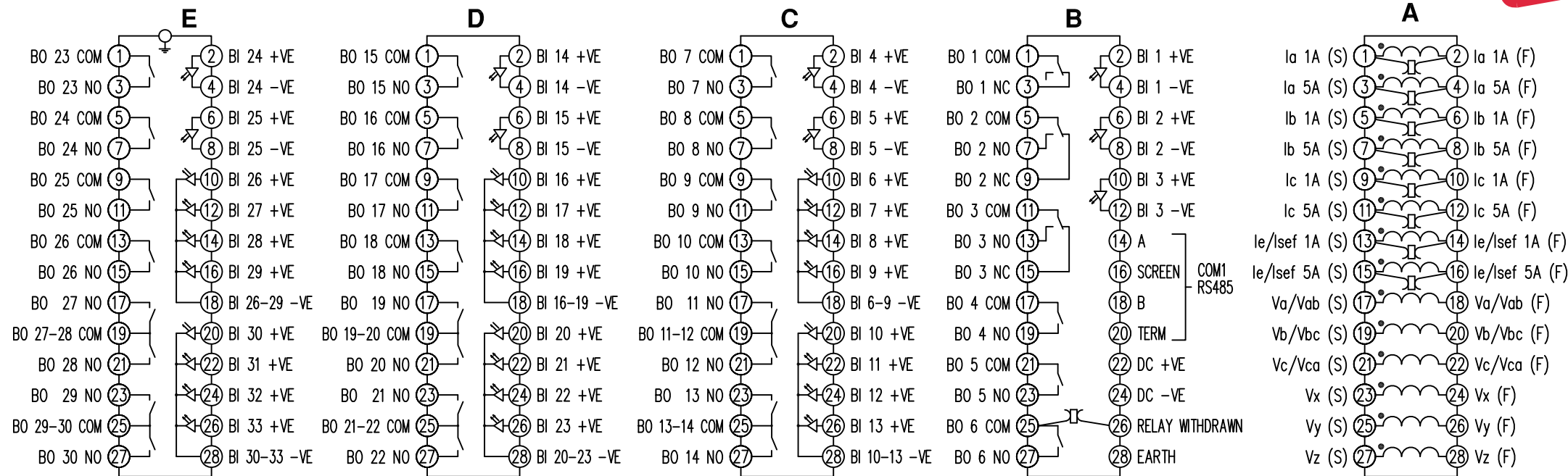

MATERIAL:

Dimensions in millimetres : Surface texture in micrometres.
Machine where marked ✓
For explanation of dimensions, tolerances, notes etc. see B.S.308.
Limit on untoleranced unmachined dimensions ± _____
Limits on untoleranced machined dimensions to B.S.4500;
i.e. up to 6±0.1; over 30 to 120±0.3; over 315±0.8;
over 6 to 30±0.2; over 120 to 315±0.5;
General unmachined angular tolerance ± _____

Finish:

Treatment:

Title:
7SR224, E12, TERMINAL ID & WIRING DIAGRAM
4I, 6V, 33BI, 2CO,27NO,1NC, IRIG-B, 2FO, RS485

SIEMENS PROTECTION DEVICES LTD.

Original Scale.

NTS

First used on:

Similar Articles:

Supersedes:

Drq. No.

2435W40087

Copyright © 2011 Siemens Protection Devices Ltd. Hebburn

1	02/08/11	CHANGE
ISSUE	DATE	NOTED