

Installation Instructions for Replacement Mechanism Kit

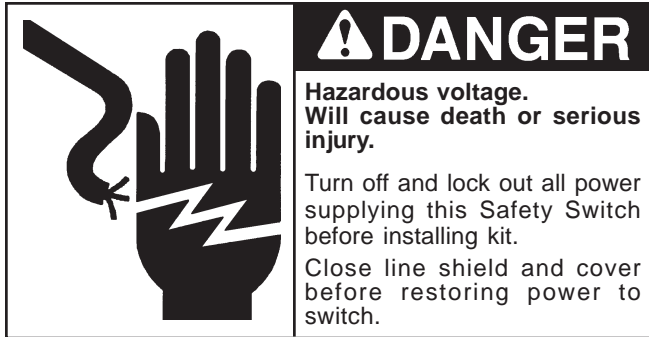

SAFETY INSTRUCTIONS

NOTE: This instruction outlines the recommended installation procedure.

NOTE: All replacement mechanisms are Heavy Duty.

1. Turn OFF and lock out all power supplying the Safety Switch.
2. Turn the Safety Switch OFF.
3. Verify moveable contacts are in the OFF position. (See Figure 1 & 2)
4. Verify that NO voltage is present at the wire grips.
5. Remove fuses if installed.
6. Open line shield.
7. Remove all conductors from the line base and neutral if installed. Remove neutral bonding screw if installed, see Figures 1 & 2 for location.

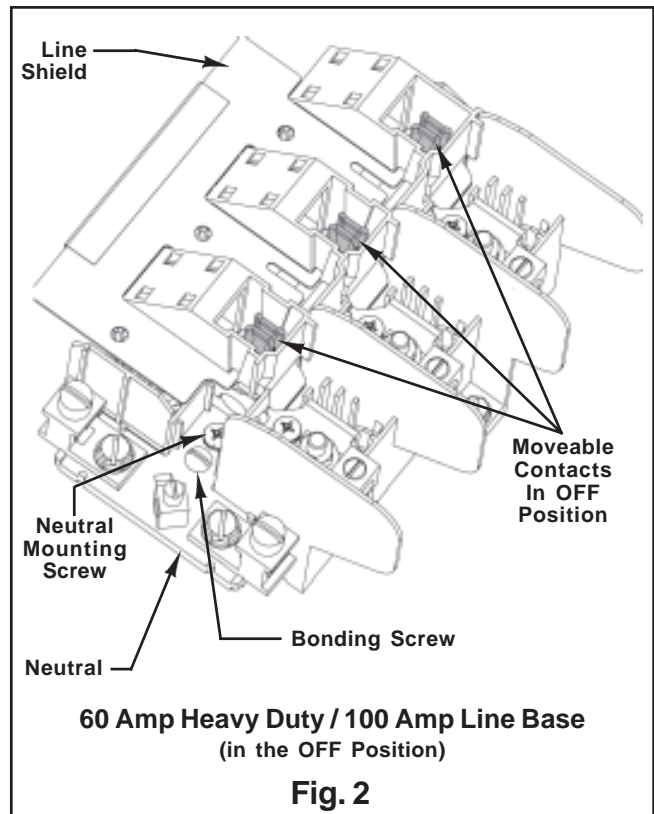
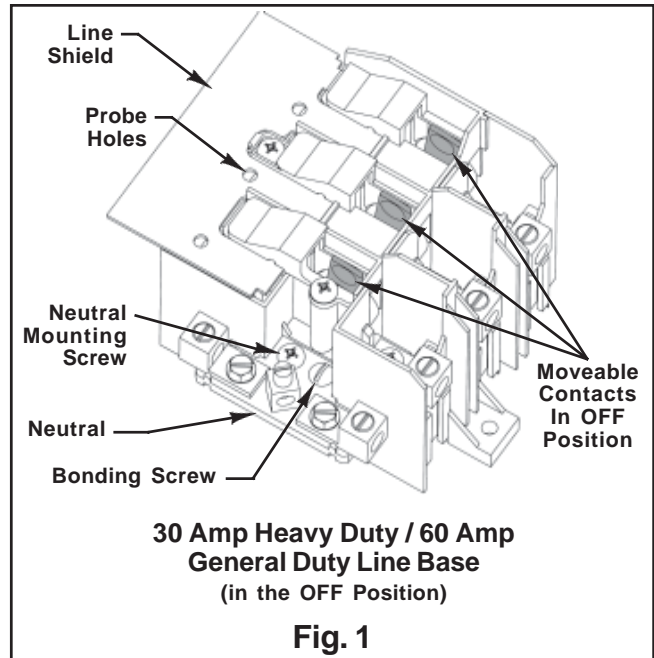

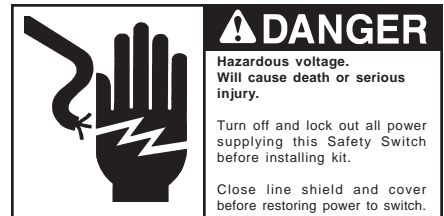

Installation Instructions for Replacement Mechanism Kit

8. Remove and retain Handle and Handle Guard and all mounting hardware, see **Figure 3** for the location of mounting hardware.

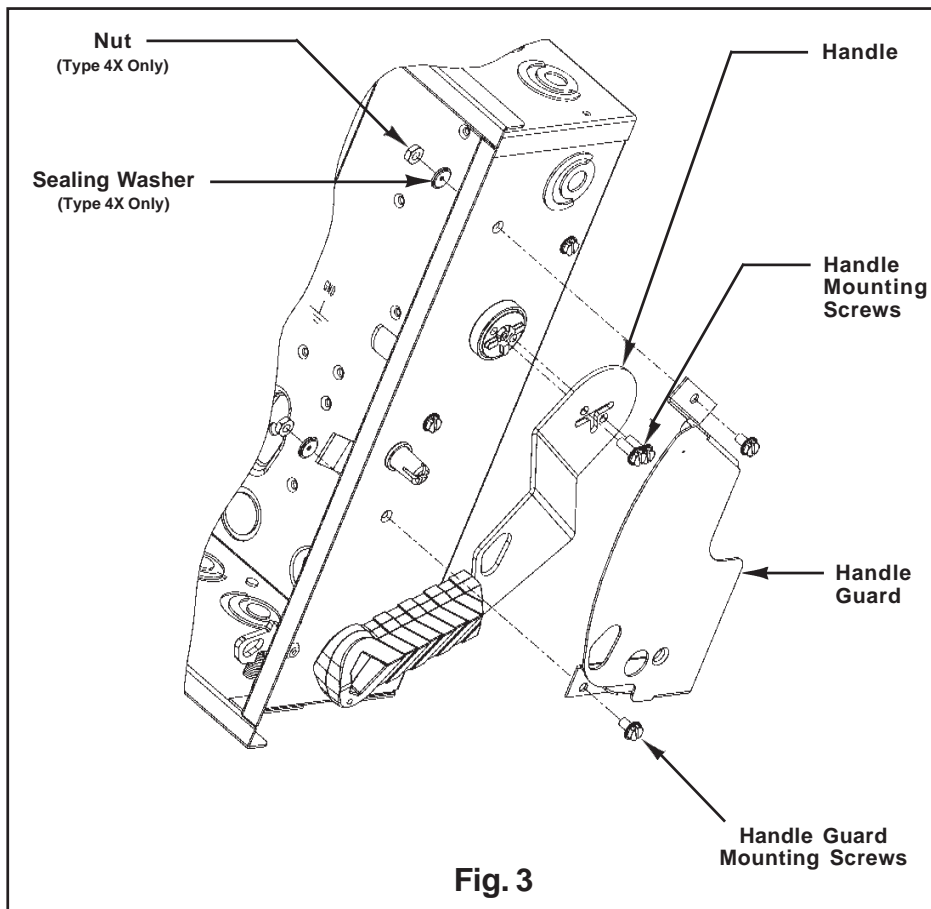

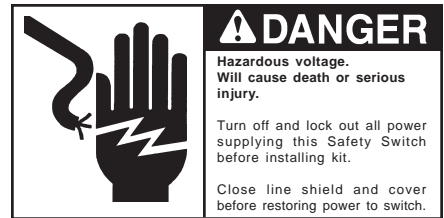

Installation Instructions for Replacement Mechanism Kit

- Remove and retain line base mounting screws. (See Figures 4 & 5).
- Slide line base to the left to disengage the rotor from the switch mechanism and remove line base.

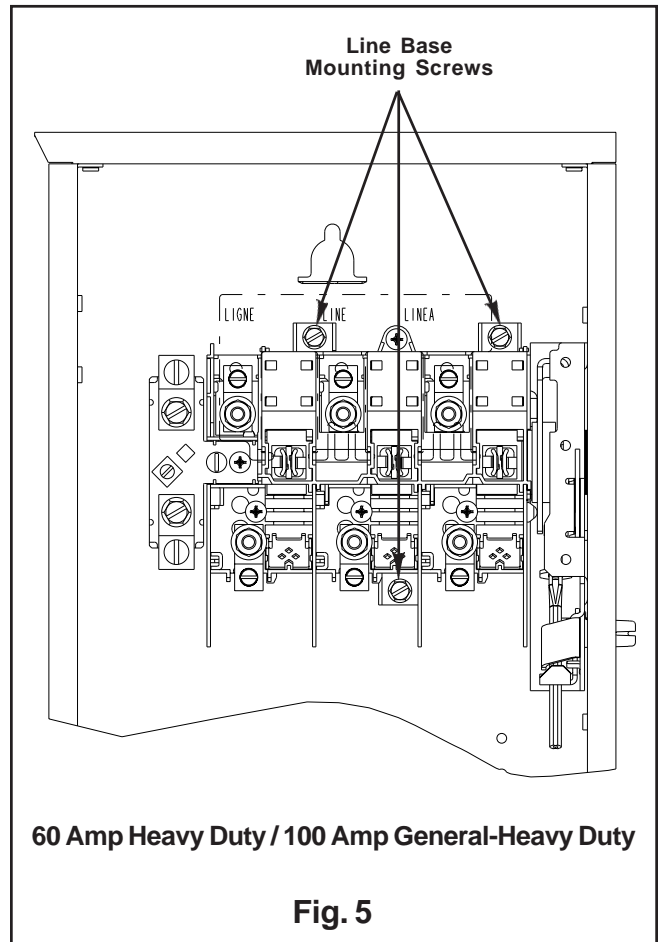
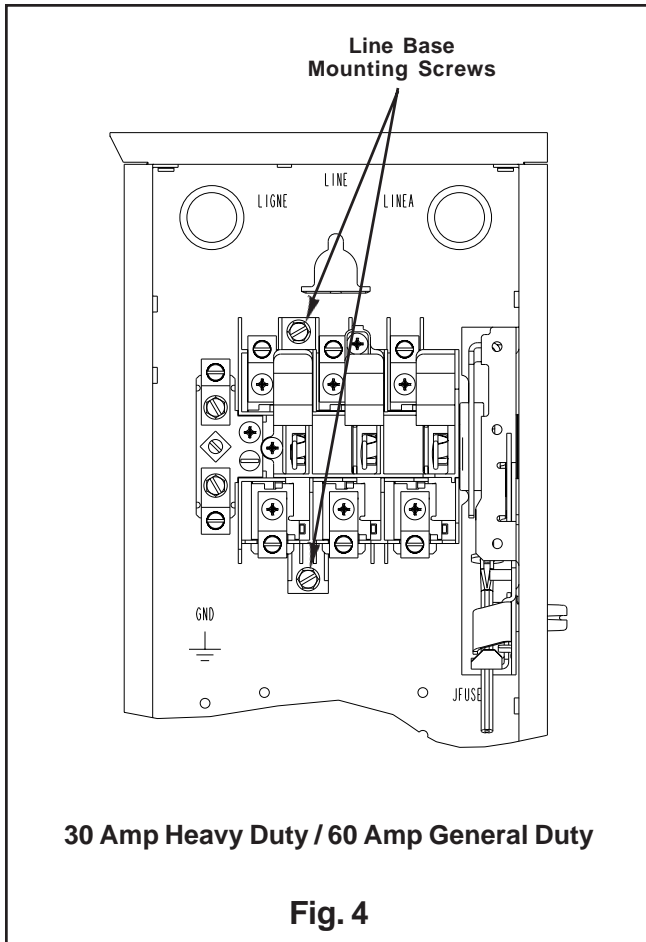

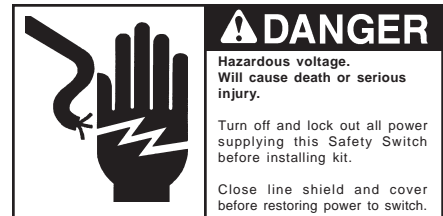

Installation Instructions for Replacement Mechanism Kit

11. Remove mechanism mounting screws.
 (See Figures 6 & 7).
12. Slide mechanism to the left and remove.
13. Position replacement mechanism in enclosure and secure with mounting screws provided in this kit as shown in Figures 6 & 7. Torque screws to 26-30 lb-ins.

NOTE: For Type 4X enclosures, secure with 10-32 x 1/2" coated machine screws along with the sealing washers as shown in Figure 7.
14. Reinstall Handle.
 - a. Align handle hole pattern with tabs on mechanism and secure with 10-32 X 1/2" thread forming screws.
 (See Figure 3).
 - b. Torque mounting screws to 30 lb-ins.
15. Reinstall Handle Guard.
 - a. Align handle guard mounting holes with enclosure and secure with 10-32 X 5/16" thread forming screws.
 (See Figure 3).

NOTE: For Type 4X enclosures, use the **coated** 10-32 X 1/2" machine screws along with the nuts and sealing washers as shown in Figure 3.

- b. Torque mounting screws to 30 lb-ins.
- c. If the switch handle is in the ON position, move it to the OFF position before proceeding.

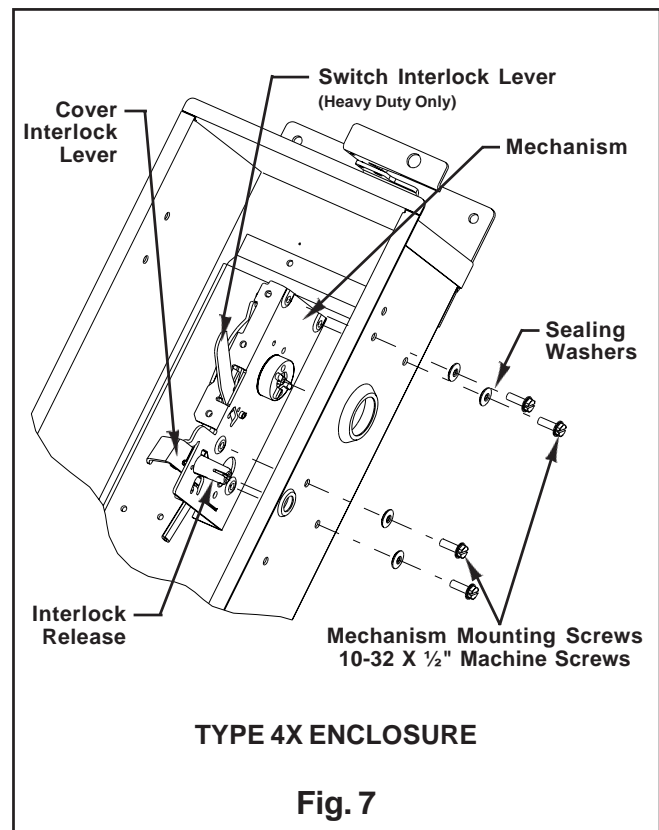
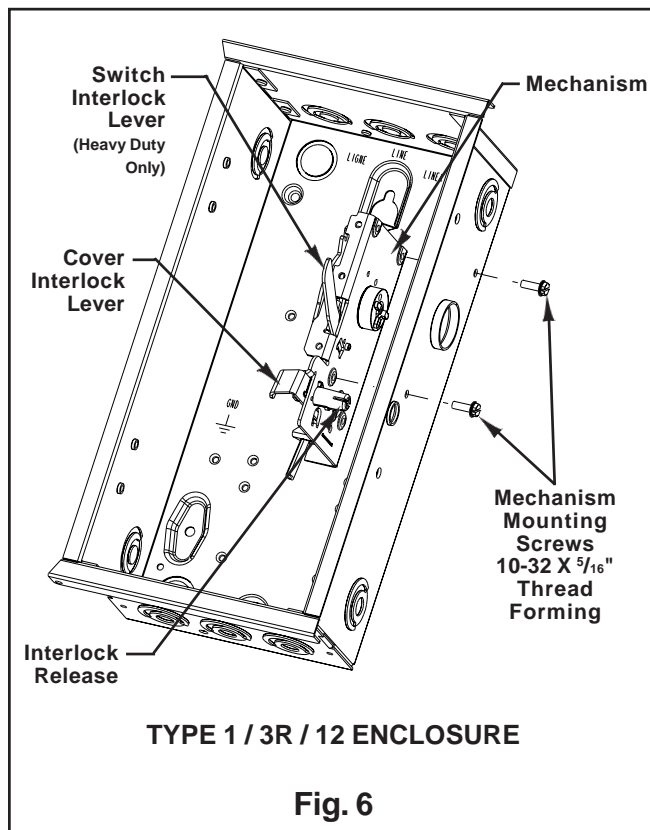

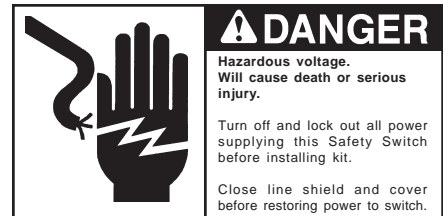

Installation Instructions for Replacement Mechanism Kit

16. Reinstall line base assembly.
 - a. Making sure that the moveable contacts are visible (switch in OFF position), slide line base to the right, inserting line base rotor into mechanism cam. (See Figures 8 & 9).
 - b. Install mounting screws and torque to 30 lb-ins. (See Figures 4 & 5)
17. Reinstall conductors. Torque lugs to the wire tightening torque values listed in the Terminal & Wire Information Table on the interior label.
18. Reinstall neutral bonding screw if removed in step 7.
19. If auxiliary switch kit was installed, remove from original mechanism and reinstall per instruction sheet included in this kit.
19. Install fuses if removed in step 5.
20. Close line shield.
21. **While power supplying switch is still OFF**, check switch operation. Cycle mechanism while checking for smooth switch operation and moveable contact movement. (Hold switch interlock lever below the front of the enclosure to operate switch with the door open on Heavy Duty Switches.) (See Figures 6 & 7) If switch does not operate in a smooth manner, or there are any questions about replacement kit installation, contact Customer Service 1-800-241-4453.
22. Check interlock operation.
 - a. Close cover.
 - b. **While the power supplying switch is still OFF**, move handle to ON position.
 - c. Attempt to open the cover. The cover interlock lever should prevent the cover from opening.
 - d. Move handle to the OFF position.
23. Close cover before applying power to the safety switch.

