

Predictive Maintenance

Condition Monitoring

Jørn Lykke Sørensen



Condition Monitoring i praksis

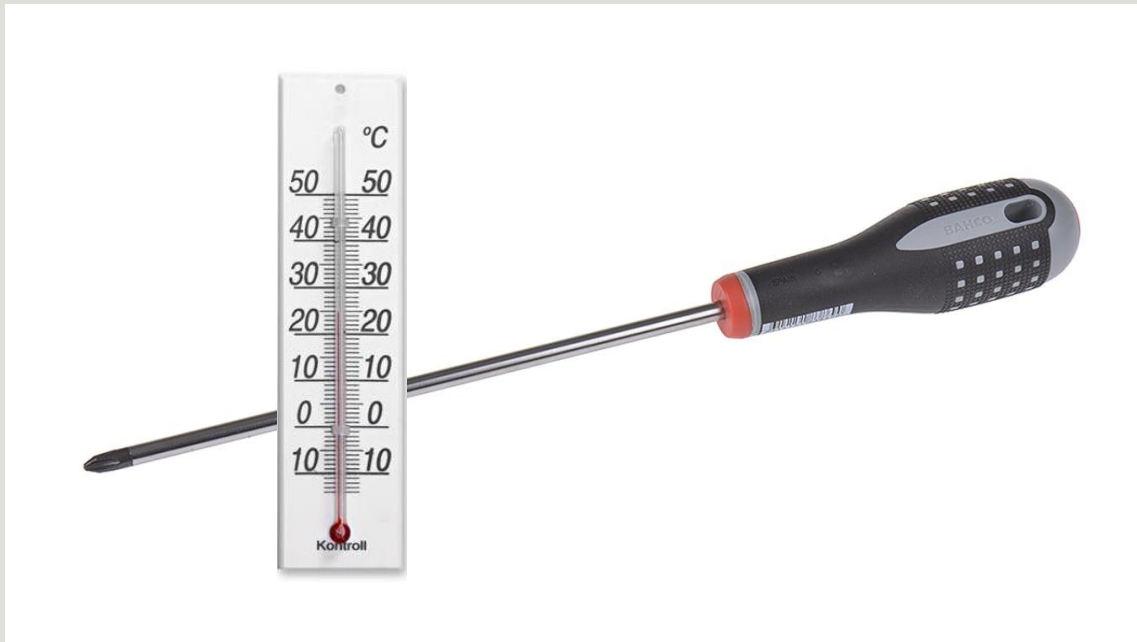

Vibrationsmåling

Klassisk analyse:

- Der er noget, der runger
- Er der en motor med et dårligt leje?
- Lyt med skruetrækkeren og mærk om den er lidt varm...



SIEMENS

Condition Monitoring gjort digitalt

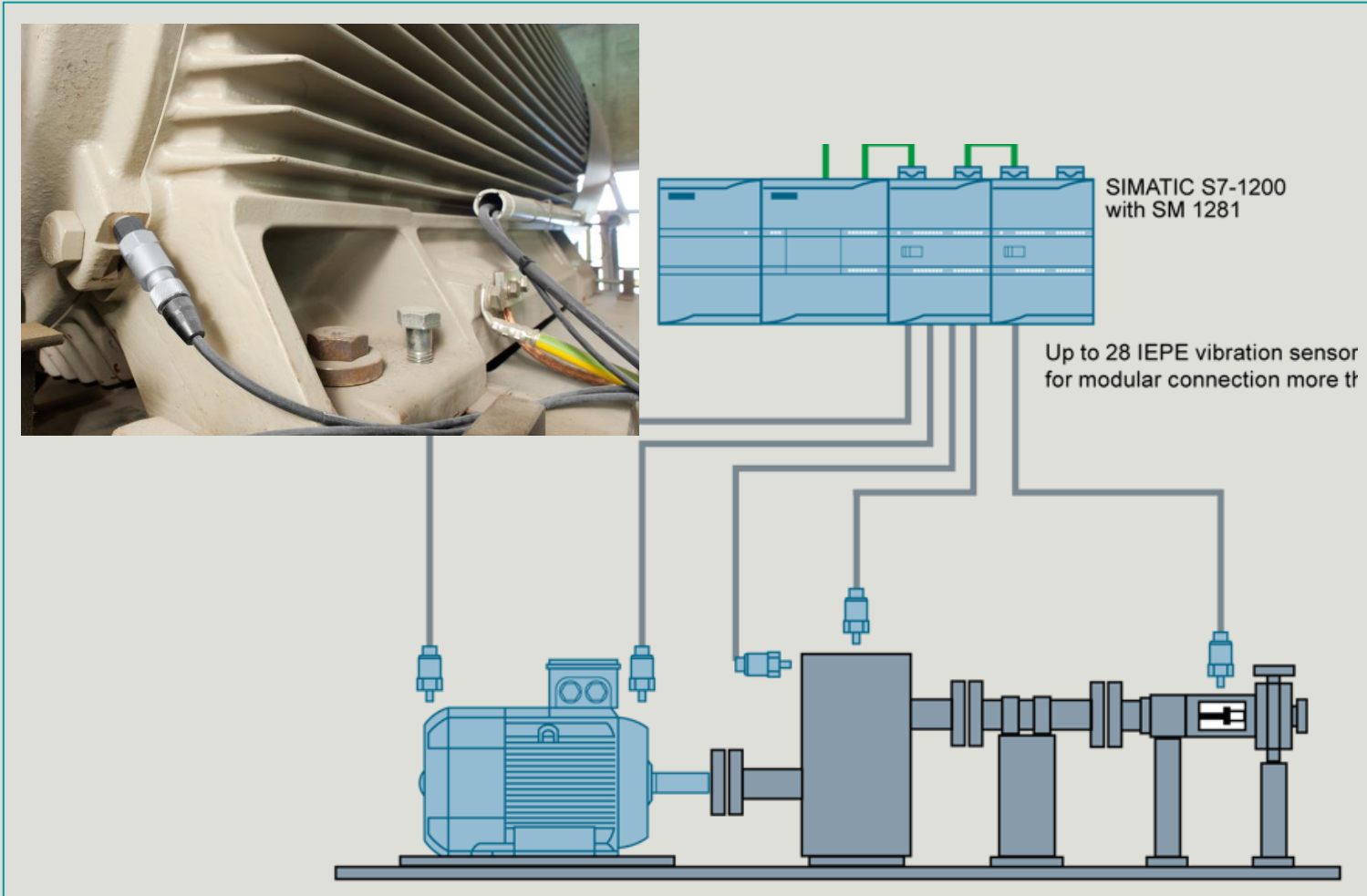

Måling og analyse af vibrationer

- Ubalance
- Kuglelejer



Analyse af vibrationer

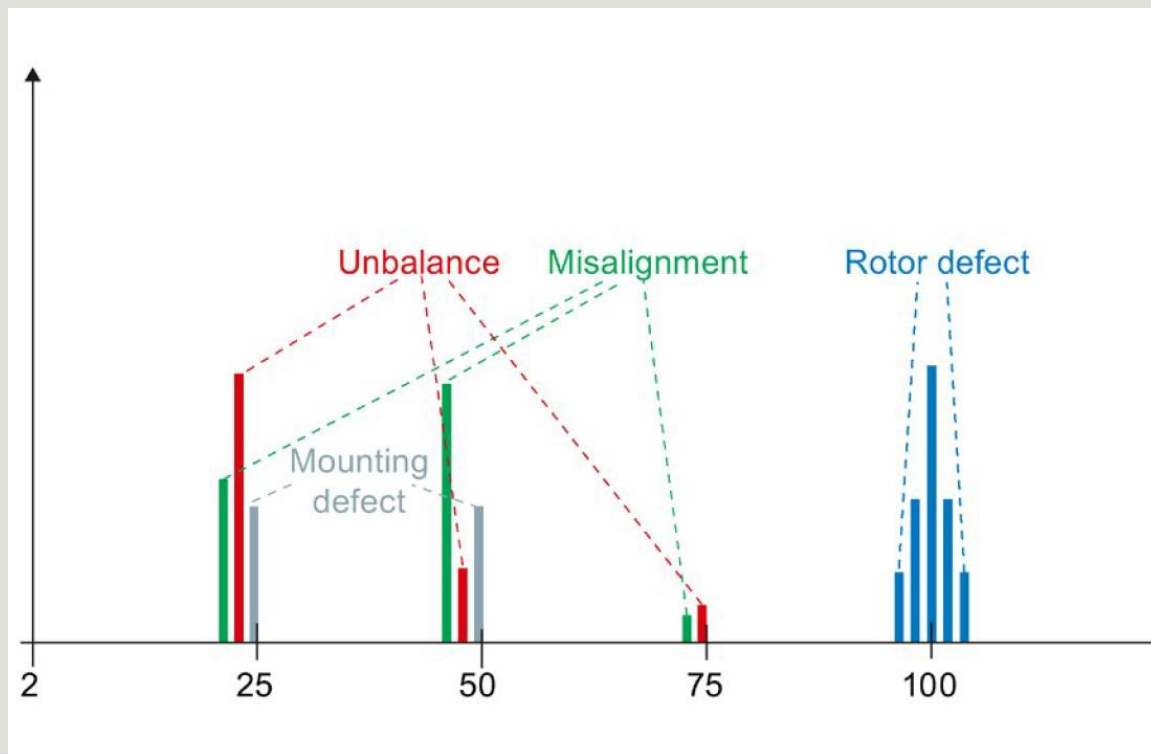

Ubalance:

- Lave frekvenser med stor energi
- Simple analyse uden ekspertviden



Analyse af vibrationer

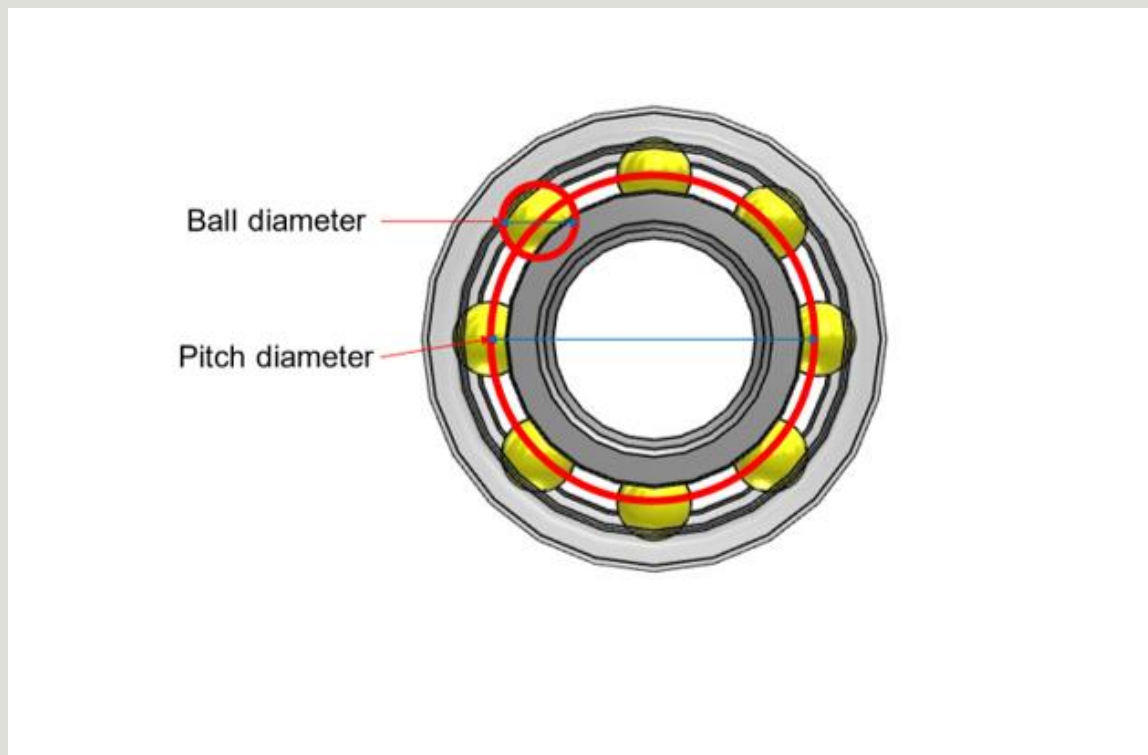

Kuglelejer:

- Højere frekvenser med begrænset energi
- Overvåg relevante frekvenser
- Planlæg vedligehold måneder i forvejen



SIEMENS

CMS1200 Bundle

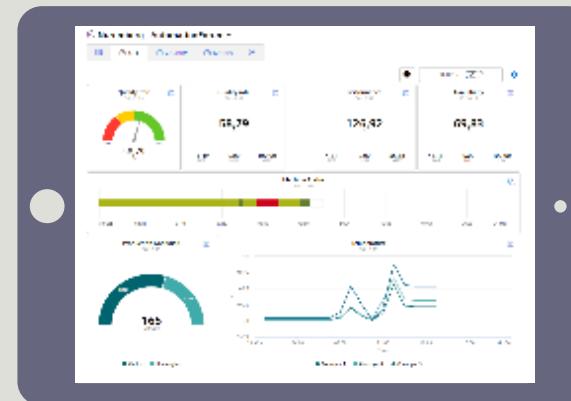
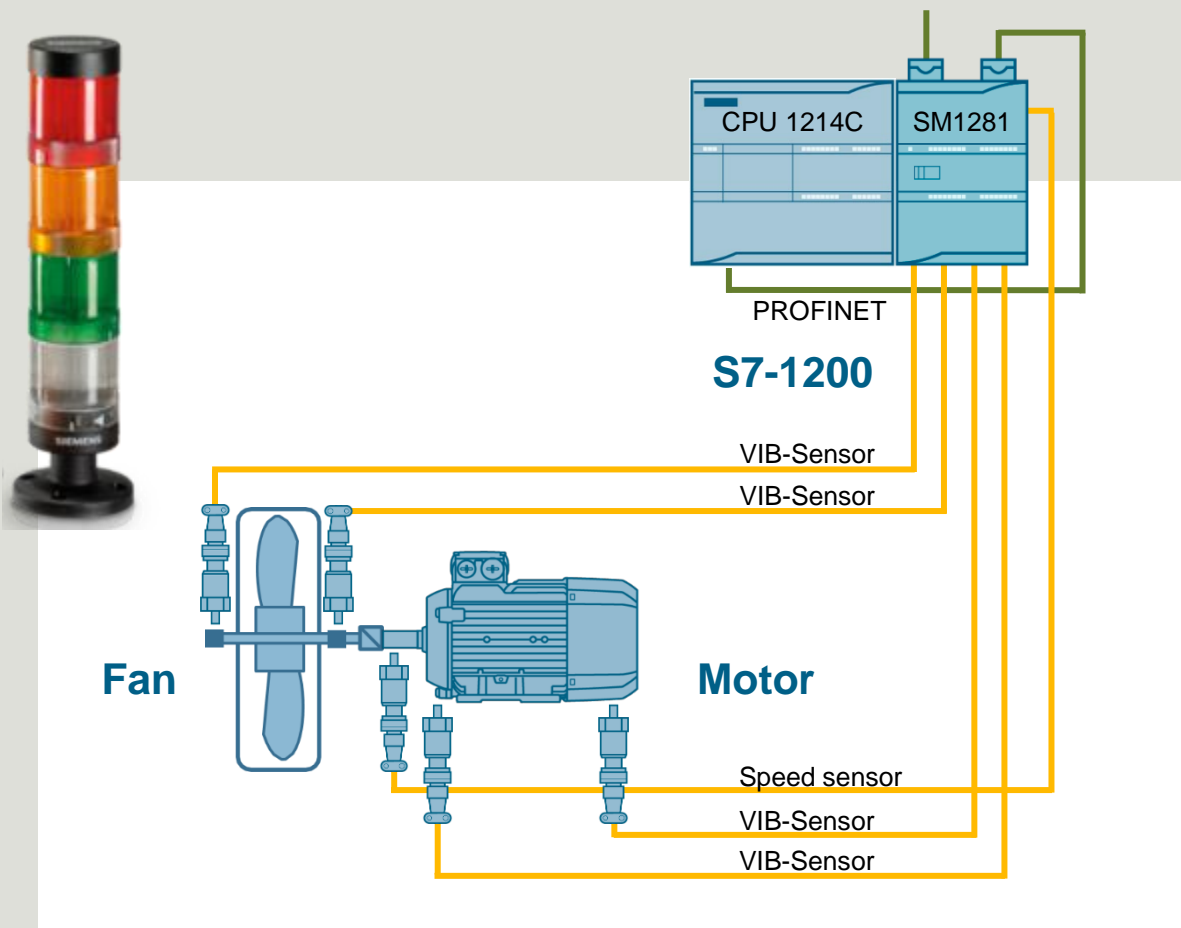

Kom i gang bundle:

- Bundle indeholder PLC som host, SM1281, skærmerklemmer og et CF-kort med færdig applikations-eksempel, klar til konfiguration på Web-interface
- Tilkøb sensorer, kabler og lystårn efter behov



SIEMENS

CMS1200 betjening



Analyser på dit niveau:

- På web-interfacet kan du se, hvilke grænser der er overskredet
- Data bliver gemt i forskellig opløsning i 10 år
- Ekspert analyse i X-Tools



SIEMENS

Condition Monitoring gjort digitalt

Factory/field level



EDGE

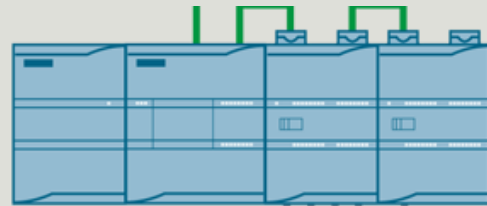
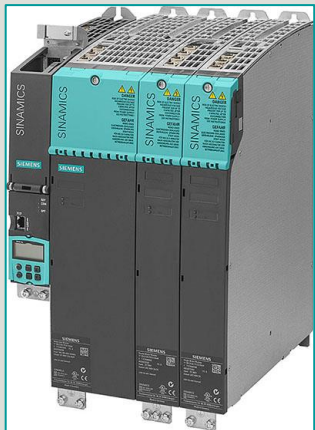

SIMATIC S7-1200
with SM 1281

Up to 28 IEPE vibration sensor
for modular connection more th

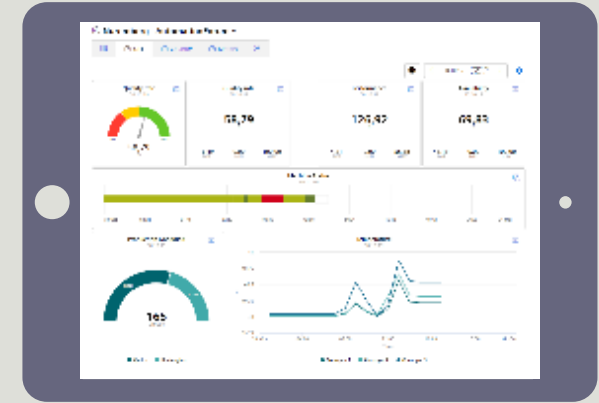
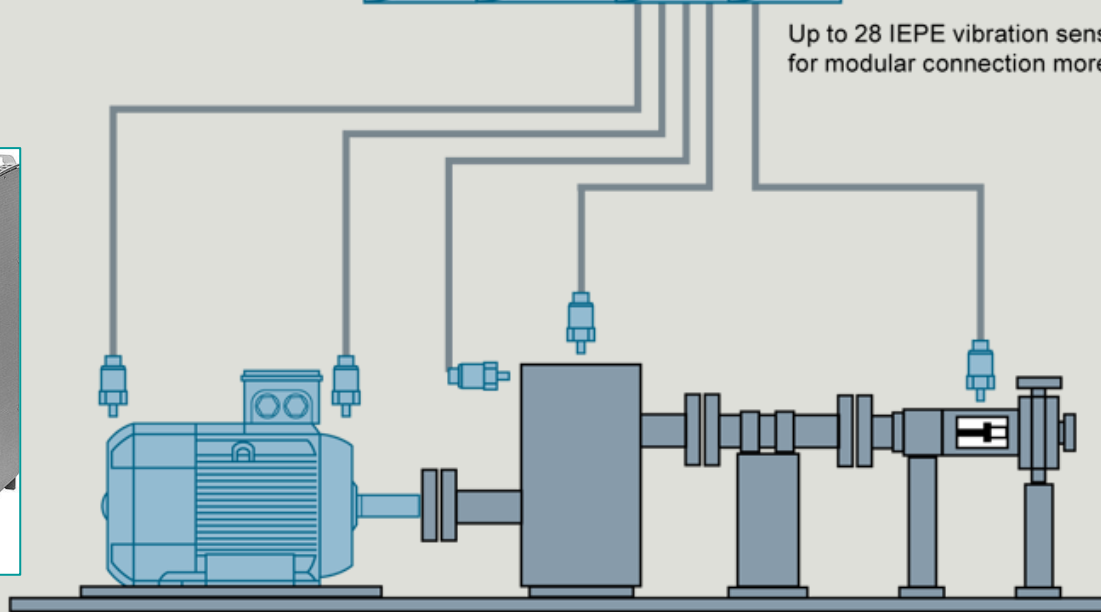

Edge for lokal databehandling

- Analyze MyDrive
- Kombiner med drev-data op til 8kHz log
- Kunstig intelligens



SIEMENS

Condition Monitoring gjort digitalt

