

Tripping Matrix

7UW50

Instruction Manual

Order No. C53000-G1176-C88-3



Figure 1 Illustration of the tripping matrix 7UW50 (in flush mounting case)

SIEMENS



Conformity

This product is in conformity with the directive of the Council of the European Communities on the approximation of the laws of the Member States relating to electromagnetic compatibility (EMC Council Directive 89/336/EEC) and concerning electrical equipment for application within specified voltage limits (Low-voltage directive 73/23 EEC).

Conformity is proved by tests that had been performed according to article 10 of the Council Directive in accordance with the generic standards EN 50081-2 and EN 50082-2 (for EMC directive) and the standards EN 60255-6 (for low-voltage directive) by Siemens AG.

The device is designed and manufactured for application in industrial environment.

The device is designed in accordance with the international standards of IEC 255 and the German standards DIN 57 435 part 303 (corresponding to VDE 0435 part 303).

Contents

1	Introduction	5
1.1	Application	5
1.2	Features	5
2	Design	6
2.1	Arrangements	6
2.2	Dimensions	8
2.3	Ordering data	10
3	Technical Data	11
3.1	Device data	11
3.1.1	Inputs/outputs, function	11
3.1.2	Electrical tests	12
3.1.3	Mechanical stress tests	13
3.1.4	Climatic stress tests	14
3.1.5	Service conditions	15
3.1.6	Design	15
4	Method of operation	16
5	Installation instructions	18
5.1	Unpacking and repacking	18
5.2	Preparations	18
5.2.1	Mounting and connections	18
5.2.1.1	Model 7UW5000-★B★★ for panel surface mounting	18
5.2.1.2	Model 7UW5000-★C★★ for panel flush mounting or cubicle installation	19
5.2.2	Checking the rated data	19
5.2.3	Connections	19
5.2.4	Checking the connections	19
6	Operating instructions	20
6.1	Safety precautions	20
6.2	Operation of the device	20
6.2.1	Marshalling of the trip commands	20
6.2.2	Representation of the unit (front view)	21
6.3	Testing and commissioning	22
6.3.1	General	22
6.3.2	Trip tests	22
6.4	Making ready for service	23

7	Maintenance and fault tracing	24
7.1	Routine checks	24
7.2	Fault tracing	24
7.2.1	Replacing the mini-fuse	25
8	Repairs	26
9	Storage	26
 Appendix		 27
A	General diagrams	28

NOTE:

This instruction manual does not purport to cover all details in equipment, nor to provide for every possible contingency to be met in connection with installation, operation or maintenance.

Should further information be desired or should particular problems arise which are not covered sufficiently for the purchaser's purpose, the matter should be referred to the local Siemens sales office.

The contents of this instruction manual shall not become part nor modify any prior or existing agreement, commitment or relationship. The sales contract contains the entire obligations of Siemens. The warranty contained in the contract between the parties is the sole warranty of Siemens. Any statements contained herein do not create new warranties nor modify the existing warranty.

1 Introduction

1.1 Application

The tripping matrix is a cross bar distributor and is used to connect the trip signals arriving at the matrix columns from numerical protection systems to the matrix output rows to the tripping relays (refer to Figure 1.1). The association between the input columns and the output rows is freely programmable.

The inputs (columns) are thus assigned to the protection systems and the outputs (rows) are assigned to the tripping elements.

1.2 Features

- 28 inputs (columns 1 to 28);
- 10 outputs (rows A to K);
- optical indication for each input and output;
- common interruption plug for each column;
- common alarm with contact outputs;
- local and remote reset of the indications.

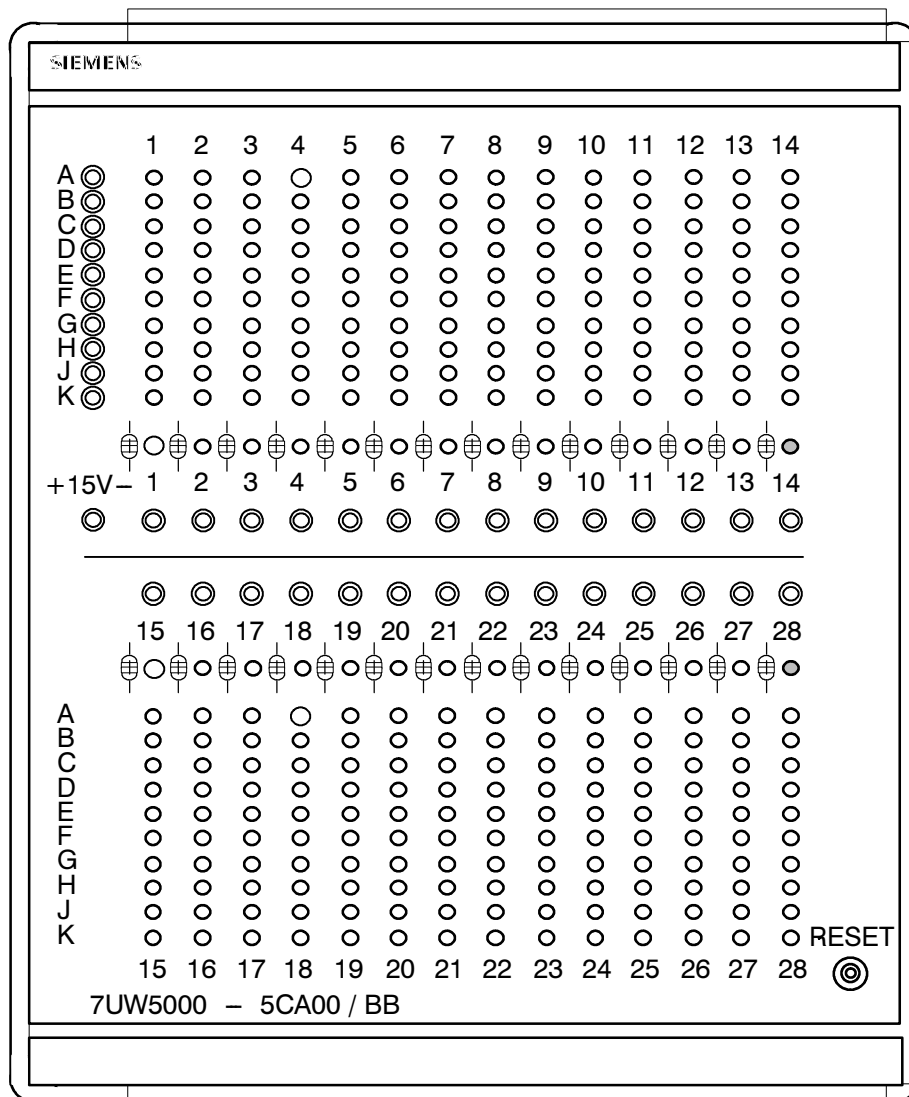

Figure 1.1 Tripping matrix

2 Design

2.1 Arrangements

The complete matrix functions (cross bar distributor including storage elements and dc/dc converter for the LEDs) are accommodated on one plug-in module of Double Europa Format. This module is installed in a housing 7XP20. Two different types of housings can be delivered:

– **7UW5000–★B★★★**– in housing 7XP2040–1 for **panel surface mounting**

The housing has full sheet-metal covers, as well as a removable front cover with transparent plastic window.

All external signals are connected to 100 screwed terminals which are arranged over cut-outs on the top and bottom covers. The terminals are numbered consecutively from left to right at the bottom and top.

Earthing screws have been provided on the left hand side of the housing. Additionally, terminal 26 is connected to the case.

The degree of protection for the housing is IP51, for the terminals IP21. For dimensions please refer to Figure 2.2.

The front cover can be sealed in order to protect against unauthorized alteration.

– **7UW5500–★C★★★**– in housing 7XP2040–2 for **panel flush mounting or cubicle installation**

The housing has full sheet-metal covers, as well as a removable front cover with transparent plastic window.

All external signals are connected to connector modules which are mounted on the rear cover over cut-outs. For each electrical connection, one screwed terminal and one parallel snap-in terminal are provided. For field wiring, the use of the screwed terminals is recommended; snap-in connection requires special tools.

Earthing screws have been provided on the rear wall of the housing.

The plug modules are labelled according to their mounting position by means of a grid system (e.g. **1A2**). The individual connections within a module are numbered consecutively from left to right (when viewed from the rear), (e.g. **1A2**); refer to Figure 2.1.

Degree of protection for the housing is IP51, for the terminals IP21. For dimensions please refer to Figure 2.3.

The front cover can be sealed in order to protect against unauthorized alteration.

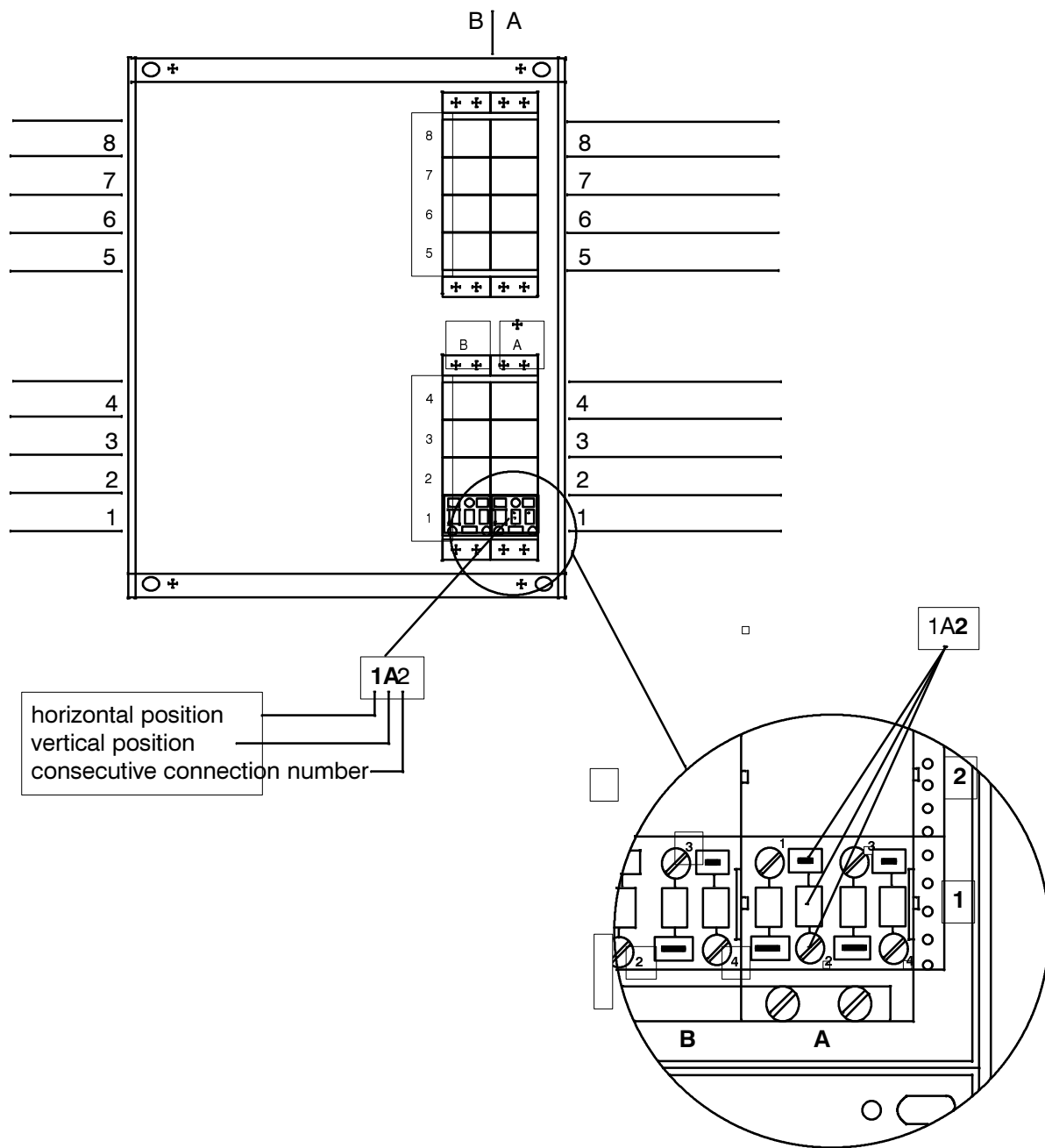
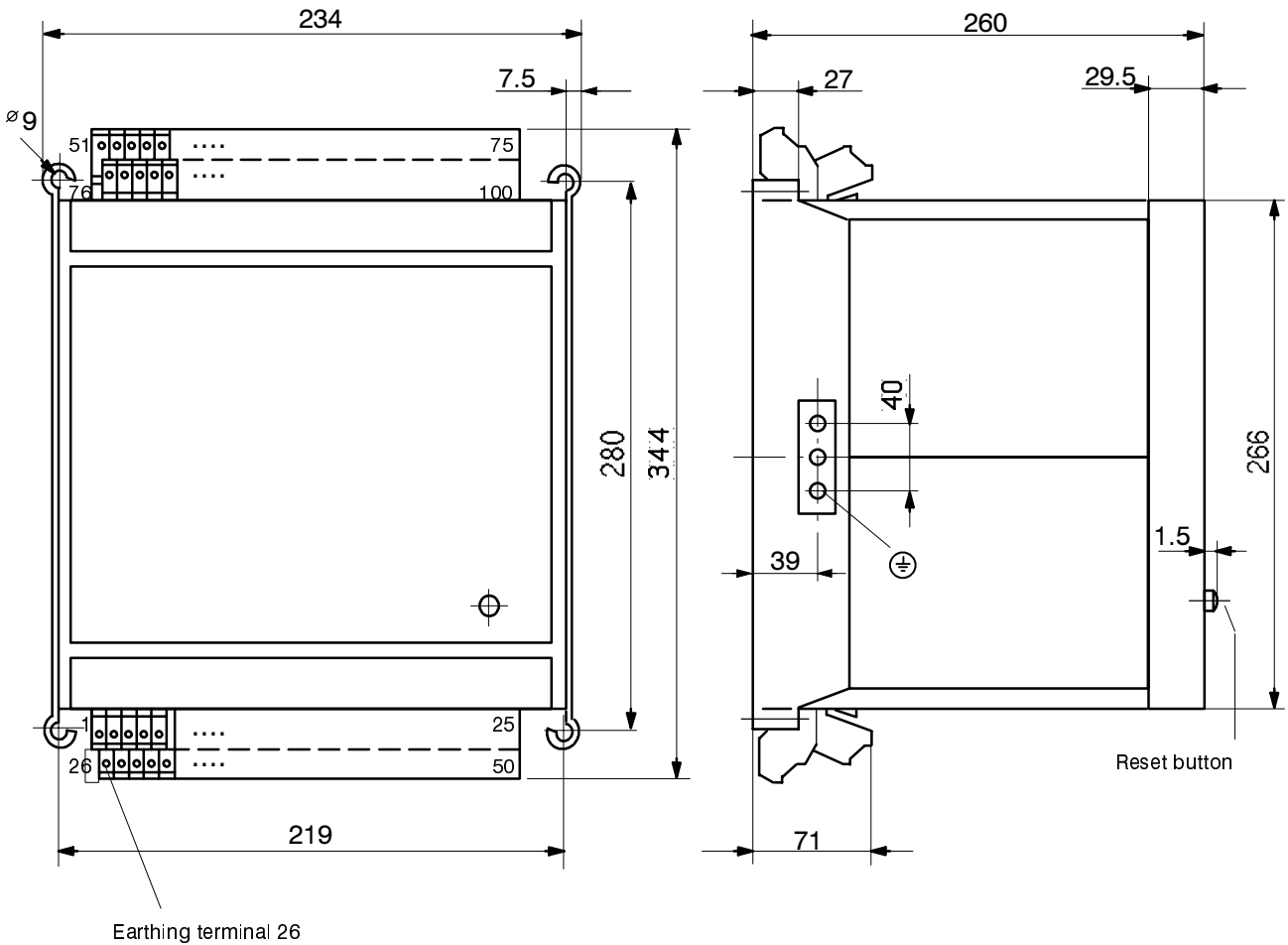

Figure 2.1 Connection plugs (rear view) – housing for flush mounting – example

2.2 Dimensions

Figures 2.2 and 2.3 show the dimensions of the various types of housings available.

7UW500*--*B*** Housing for **panel surface mounting** 7XP2040-1



Max. 100 terminals for cross-section max. 7 mm²

Dimensions in mm

Figure 2.2 Dimensions for housing 7XP2040-1 for panel surface mounting

7UW500*--*C*** Housing for **panel flush mounting** or **cubicle installation** 7XP2040-2

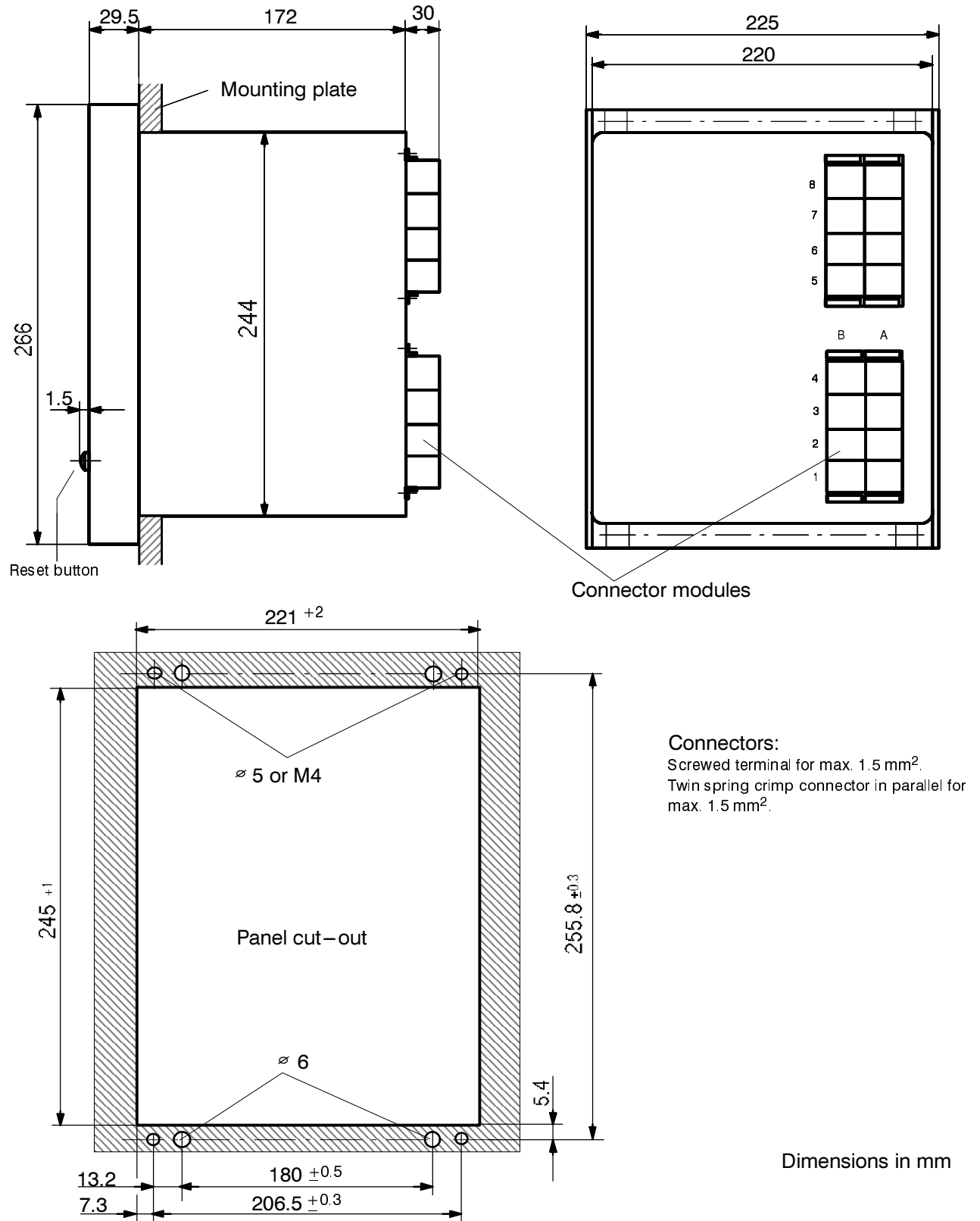

Figure 2.3 Dimensions for housing 7XP2040-2 for panel flush mounting or cubicle installation

2.3 Ordering data

Tripping Matrix	7.	8.	9.	10.	11.	12.
	7 U W 5 0 0 0 -			A	0	0
<hr/>						
Auxiliary voltage (= Control voltage of the actuated switching elements)		↑	↑			
60/110/125 V dc	4					
220/250 V dc	5					
<hr/>						
Construction						
in housing 7XP2040-1 for panel surface mounting	B					
in housing 7XP2040-2 for panel flush mounting or cubicle installation	C					
<hr/>						

3 Technical data

3.1 General data

3.1.1 Inputs/outputs, function

Auxiliary voltage

Control voltage of the actuated switching elements and the integrated dc/dc converter

Rated auxiliary voltage U_H	60/110/125 Vdc	220/250 Vdc
Permissible variations	48 to 144 Vdc	176 to 288 Vdc
Superimposed ac voltage, peak-to-peak	$\leq 12\%$ at rated voltage $\leq 6\%$ at limits of admissible voltage	
Power consumption of the dc/dc converter		
quiescent	approx 2.5 W	
maximum	approx 10.0 W	
Bridging time during failure/short-circuit of auxiliary voltage	≥ 50 ms at $U_{dc} \geq 110$ Vdc	

Cross-bar distributor

Number of columns (trip signal inputs from protection relays)	28
Number of rows (tripping element outputs)	10
Diode plugs	
reverse voltage, peak value	1000 V
rated value	250 V
max. current	1 A
direction of current flow	from column (+) to row (-)

Indication memories

– Number	39
– Pick-up time (depending on operating voltage)	approx. 1.5 ms to 2 ms

Signal contacts

Signal/alarm relays	2
Contact per relays	2 NO or 1 NC
Switching capacityMAKE/BREAK	20 W/VA
Switching voltage	250 V
Permissible current	1 A

Binary input for resetting

Number	1
Operating voltage (reconnectable)	24 to 60 Vdc 110 to 250 Vdc
Current consumption (dep. on operating voltage)	approx. 2 to 10 mA

3.1.2 Electrical tests**Insulation tests**

Standards:	IEC 255–5
– High voltage test (routine test) except d.c. voltage supply input	2 kV (rms); 50 Hz
– High voltage test (routine test) only d.c. voltage supply input	2.8 kV dc
– Impulse voltage test (type test) all circuits, class III	5 kV (peak); 1.2/50 μ s; 0.5 J; 3 positive and 3 negative shots at intervals of 5 s

EMC tests; immunity (type tests)

Standards:	IEC 255–6, IEC 255–22 (product standards) EN 50082–2 (generic standard) VDE 0435 /part 303
– High frequency IEC 255–22–1, class III	2.5 kV (peak); 1 MHz; $\tau = 15 \mu$ s; 400 shots/s; duration 2 s
– Electrostatic discharge IEC 255–22–2 class III and IEC 1000–4–2, class III	4 kV/6 kV contact discharge; 8 kV air discharge; both polarities; 150 pF; $R_i = 330 \Omega$
– Radio–frequency electromagnetic field, non–modulated; IEC 255–22–3 (report), class III	10 V/m; 27 MHz to 500 MHz
– Radio–frequency electromagnetic field, amplitude modulated; IEC 1000–4–3, class III	10 V/m; 80 MHz to 1000 MHz; 80 % AM; 1 kHz
– Radio–frequency electromagnetic field, pulse modulated; IEC 1000–4–3/ENV 50204, class III	10 V/m; 900 MHz; repetition frequency 200 Hz; duty cycle 50 %

– Fast transients IEC 255–22–4 and IEC 1000–4–4, class III	2 kV; 5/50 ns; 5 kHz; burst length 15 ms; repetition rate 300 ms; both polarities; $R_i = 50 \Omega$; duration 1 min
– Conducted disturbances induced by radio–frequency fields, amplitude modulated IEC 1000–4–6, class III	10 V; 150 kHz to 80 MHz; 80 % AM; 1 kHz
– Power frequency magnetic field IEC 1000–4–8, class IV IEC 255–6	30 A/m continuous; 300 A/m for 3 s; 50 Hz 0.5 mT; 50 Hz

EMC tests; emission (type tests)

Standard:	EN 50081–★ (generic standard)
– Conducted interference voltage, aux. voltage CISPR 22, EN 55022, class B	150 kHz to 30 MHz
– Interference field strength CISPR 11, EN 55011, class A	30 MHz to 1000 MHz

3.1.3 Mechanical stress tests

Vibration and shock during operation

Standards:	IEC 255–21 and IEC 68–2
– Vibration IEC 255–21–1, class 1 IEC 68–2–6	sinusoidal 10 Hz to 60 Hz: ± 0.035 mm amplitude; 60 Hz to 150 Hz: 0.5 g acceleration sweep rate 1 octave/min 20 cycles in 3 orthogonal axes
– Shock IEC 255–21–2, class 1	half sine acceleration 5 g, duration 11 ms, 3 shocks in each direction of 3 orthogonal axes
– Seismic vibration IEC 255–21–3, class 1 IEC 68–3–3	sinusoidal 1 Hz to 8 Hz: ± 3.5 mm amplitude (hor. axis) 1 Hz to 8 Hz: ± 1.5 mm amplitude (vert. axis) 8 Hz to 35 Hz: 1 g acceleration (hor. axis) 8 Hz to 35 Hz: 0.5 g acceleration (vert. axis) sweep rate 1 octave/min 1 cycle in 3 orthogonal axes

Vibration and shock during transport

Standards:	IEC 255–21 and IEC 68–2
– Vibration IEC 255–21–1, class 2 IEC 68–2–6	sinusoidal 5 Hz to 8 Hz: ± 7.5 mm amplitude; 8 Hz to 150 Hz: 2 g acceleration sweep rate 1 octave/min 20 cycles in 3 orthogonal axes
– Shock IEC 255–21–2, class 1 IEC 68–2–27	half sine acceleration 15 g, duration 11 ms, 3 shocks in each direction of 3 orthogonal axes
– Continuous shock IEC 255–21–2, class 1 IEC 68–2–29	half sine acceleration 10 g, duration 16 ms, 1000 shocks each direction of 3 orthogonal axes

3.1.4 Climatic stress tests

– Permissible ambient temperature

during service	–5 °C to +55 °C
during storage	–25 °C to +55 °C
during transport	–25 °C to +70 °C

Storage and transport with standard works packaging!

– Permissible humidity	mean value per year ≤ 75 % relative humidity; on 30 days per year 95 % relative humidity; Condensation not permissible!
------------------------	--

We recommend that all units are installed such that they are not subjected to direct sunlight, nor to large temperature fluctuations which may give rise to condensation.

3.1.5 Service conditions

The relay is designed for use in industrial environment, for installation in standard relay rooms and compartments so that with proper installation **electro-magnetic compatibility (EMC)** is ensured. The following should also be heeded:

- All contactors and relays which operate in the same cubicle or on the same relay panel as the digital protection equipment should, as a rule, be fitted with suitable spike quenching elements.
- All external connection leads in sub-stations from 100 kV upwards should be screened with a screen capable of carrying power currents and earthed at both sides. No special measures are

normally necessary for sub-stations of lower voltages.

- It is not permissible to withdraw or insert individual modules under voltage. In the withdrawn condition, some components are electrostatically endangered; during handling the standards for electrostatically endangered components must be observed. The modules are not endangered when plugged in.

WARNING! The relay is not designed for use in residential, commercial or light-industrial environment as defined in EN 50081.

3.1.6 Design

Housing	7XP20; refer to Section 2.1
Dimensions	refer to Section 2.2
Weight (mass)	
– in housing for surface mounting	approx 7.5 kg
– in housing for flush mounting	approx 6.0 kg
Degree of protection acc. to EN 60529	
– Housing	IP 51
– Terminals	IP 21

4 Method of operation

The tripping matrix 7UW50 contains 28 matrix columns (for 28 commands from protection or supervision relays) and 10 matrix rows (for 10 trip signal channels to switching elements).

Programming of the matrix is performed by setting diode plugs (with black handle). Current flow direction is defined from column (+) to row (-). Each vertical column, which is controlled by a protection or supervision command, can be connected to any of the horizontal rows in order to pass the command to the selected switching elements of the switch gear, e.g. a master relays for tripping of a circuit breaker, by means of these diode plugs. The diode plugs are arranged on the front of the device.

All output trip channels controlled from a particular column can be deactivated by withdrawing the associated red master plug of the column. Thus, all of the output channels (rows) which are associated to the command of a particular protection function (column) can be interrupted with this master plug.

A LED (light emitting diode) is assigned to each of the columns to indicate a protection command. Each output trip signal is signalled by a LED, too, in order to indicate the issue of the trip. These indications are stored. They are also effective as long as the protection commands are interrupted because the red master plug is withdrawn.

A common memory circuit is provided for the 10 rows of the matrix. This memory is triggered when one of the 10 protection commands appears. A common signal relay is energized at the same time. This can be used to operate e.g. a local cubicle alarm lamp and to give remote alarm signal to the station control room.

The indications and the common alarm can be reset

either by the reset push-button on the front or by a remote reset signal. The reset push-button also serves as LED test push-button.

The necessary power for the LED indicators is derived from the station battery supply by means of an integrated d. c./d.c. converter. Short supply voltage interruptions of less than 50 ms as they can occur during a short-circuit anywhere in the station battery circuit are bridged by a storage capacitor (see Section 3.1) and do not affect the internal power supply. In case the supply voltage fails for a longer time, an alarm signal is given via a signal relay; the green ready indication (LED " +15 V - " on the front) goes out. Nevertheless, the operation of the tripping matrix is not affected, only the indications are unavailable during voltage failure. The memories are also operative so that no annunciation is lost. The indications reappear as soon as the supply voltage is available again.

The supply voltage required for the d.c/d.c converter must be identical with the control voltage of the switching elements (breaker coil or master trip relay) connected to the matrix outputs (rows). These circuits must be protected by the same protective device (mineature circuit breaker).

If the circuit breakers of the power station are to be controlled by different battery circuits, master trip relays must be provided downstream of the matrix outputs to ensure galvanic isolation.

The required touch protection during setting of the diode plugs is performed by a transparent plastic plate with long narrow holes.

The cover can be sealed in order to prevent from unauthorized operation or alteration of the diode-plug settings.

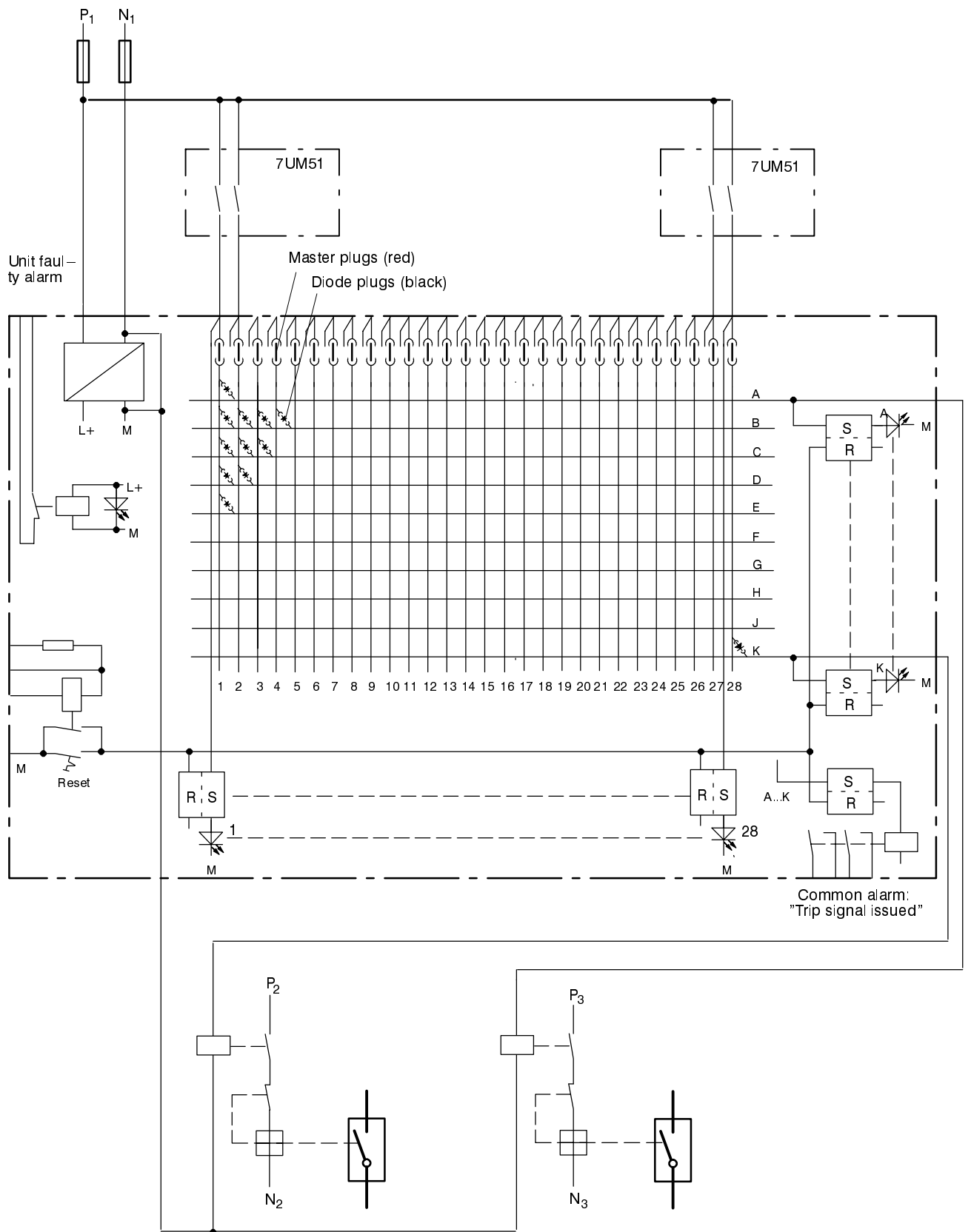

Figure 4.1 Block diagram of the tripping matrix 7UW50

5 Installation instructions



Warning

The successful and safe operation of this device is dependent on proper handling and installation by qualified personnel under observance of all warnings and hints contained in this manual.

In particular the general erection and safety regulations (e.g. IEC, DIN, VDE, or national standards) regarding the correct use of hoisting gear must be observed. Non-observance can result in death, personal injury or substantial property damage.

5.1 Unpacking and repacking

When dispatched from the factory, the equipment is packed in accordance with the guidelines laid down in IEC 255–21, which specifies the impact resistance of packaging.

This packing shall be removed with care, without force and without the use of inappropriate tools. The equipment should be visually checked to ensure that there are no external traces of damage.

The transport packing can be re-used for further transport when applied in the same way. The storage packing of the individual relays is not suited to transport. If alternative packing is used, this must also provide the same degree of protection against mechanical shock, as laid down in IEC 255–21–1 class 2 and IEC 255–21–2 class 1.

Before initial energization with supply voltage, the relay shall be situated in the operating area for at least two hours in order to ensure temperature equalization and to avoid humidity influences and condensation.

5.2 Preparations

The operating conditions must accord with VDE 0100/5.73 and VDE 0105 part 1/7.83, or corresponding national standards for electrical power installations.



Caution!

The modules of the relays contain CMOS circuits. These shall not be withdrawn or inserted under live conditions! The modules must be so handled that any possibility of damage due to static electrical charges is excluded. During any necessary handling of individual modules the recommendations relating to the handling of electrostatically endangered components (EEC) must be observed. In installed conditions, the modules are in no danger.

5.2.1 Mounting and connections

5.2.1.1 Model 7UW500*--*B*** for panel surface mounting

- Secure the unit with four screws to the panel. For dimensions refer to Figure 2.2.
- Connect earthing terminal (Terminal 26) of the unit to the protective earth of the panel.
- Make a solid low-ohmic and low-inductive operational earth connection between the earthing surface at the side of the unit using at least one standard screw M4, and the earthing continuity system of the panel; recommended grounding strap DIN 72333 form A, e.g. Order-No. 15284 of Messrs Druseidt, Remscheid, Germany.
- Make connections via screwed terminals.

5.2.1.2 Model 7UW500*–*C*** for panel flush mounting or cubicle installation

- Lift up both labelling strips on the lid of the unit and remove cover to gain access to four holes for the fixing screws.
- Insert the unit into the panel cut–out and secure it with the fixing screws. For dimensions refer to Figure 2.3.
- Connect the earthing screw on the rear of the unit as well as the terminal 4B4 to the protective earth of the panel or cubicle.
- Make a solid low–ohmic and low–inductive operational earth connection between the earthing surface at the rear of the unit using at least one standard screw M4, and the earthing continuity system of the panel or cubicle; recommended grounding strap DIN 72333 form A, e.g. Order–No. 15284 of Messrs Druseidt, Remscheid, Germany.
- Make connections via the screwed or snap–in terminals of the sockets of the housing. Observe labelling of the individual connector modules to ensure correct location; observe the max. permissible conductor cross–sections. The use of the screwed terminals is recommended; snap–in connection requires special tools and must not be used for field wiring unless proper strain relief and the permissible bending radius are observed.

5.2.2 Checking the rated data

The rated data of the unit must be checked against the plant data. This applies in particular to the auxiliary voltage.

5.2.3 Connections

A General diagram is shown in Appendix A.



Caution!

The d.c. voltage for the supply of the device, the d.c. voltage from the trip relays of the protection and supervision relays, and the d.c. voltage for all switching elements (breaker coil or master trip relays) must have the same origin and belong to the same d.c. circuit (common protective device)!

If the circuit breakers of a power station are to be energized by different voltage circuits or batteries, then multi–contact auxiliary relays must be used in order to isolate these circuits from each other and from the auxiliary voltage circuit of the matrix device.

5.2.4 Checking the connections



Warning

Some of the following test steps are carried out in presence of hazardous voltages. They shall be performed by qualified personnel only which is thoroughly familiar with all safety regulations and precautionary measures and pay due attention to them.

Non–observance can result in severe personal injury.

Before initial energization with supply voltage, the relay shall be situated in the operating area for at least two hours in order to ensure temperature equalization and to avoid humidity influences and condensation.

- Check that the d.c. voltage for the supply of the device, the d.c. voltage from the trip relays of the protection and supervision relays connected to the matrix columns, and the d.c. voltage for all switching elements (breaker coil or master trip relays) connected to the matrix outputs (rows) have the same origin and belong to the same d.c. circuit.
- Switch off the circuit breakers for the d.c. supply!
- Switch off the circuit breakers for the d.c. supply!
- Fit a d.c. ammeter in the auxiliary power circuit; range approx. 1.5 A to 3 A.
- Close the battery supply circuit breaker; check polarity and magnitude of voltage at the terminals of the unit or at the connector module.
- The green LED on the front must come on after at most 0.5 s. The unit faulty alarm contact of the auxiliary supply circuit must disappear after at most 1 s. The current consumption must comply with the power consumption data given in the Technical data.
- Open the circuit breaker for the d.c. power supply.
- Remove d.c. ammeter; reconnect the auxiliary voltage leads.
- Check through the control wiring from the protection devices.
- Check through the tripping circuits to the circuit breakers or to the external trip relays.
- Check the signal circuits.
- Close the battery supply circuit breaker.

6 Operating instructions

6.1 Safety precautions



Warning

All safety precautions which apply for work in electrical installations are to be observed during tests and commissioning.



Caution!

Connection of the device to a battery charger without connected battery may cause impermissibly high voltages which damage the device. See also Section 3.1.1 under Technical data for limits.

6.2 Operation of the device

The diode plugs are accessible after removal of the front cap of the unit which can be sealed. The diode plugs can be re-plugged under current-free conditions, in accordance with the required tripping scheme.

6.2.1 Marshalling of the trip commands

The matrix device comprises 28 inputs (columns) and 10 outputs (rows). Programming is carried out by putting a black diode plug into the cross point of a column and row according to the tripping scheme (refer to Figure 6.1).



Caution!

Do not draw – out or insert a plug under load!

Each column can be made effective by inserting the assigned red master plug.

The matrix can be secured against unauthorized alterations by closing, fixing, and sealing the transparent front cover, after the settings have been completed.

6.3 Testing and commissioning

6.3.1 General

Prerequisite for commissioning is the completion of the preparation procedures detailed in Chapter 5.



Warning

Hazardous voltages are present in this electrical equipment during operation. Non-observance of the safety rules can result in severe personal injury or property damage.

Only qualified personnel shall work on and around this equipment after becoming thoroughly familiar with all warnings and safety notices of this manual as well as with the applicable safety regulations.

Particular attention must be drawn to the following:

- ▶ The earthing screw of the device must be connected solidly to the protective earth conductor before any other connection is made.
- ▶ Hazardous voltages may be present on all circuits and components connected to the supply voltage or to the control signals.
- ▶ Hazardous voltages may be present in the device even after disconnection of the supply voltage (storage capacitors!).
- ▶ The limit values given in the Technical data (Section 3.1) must not be exceeded at all, not even during testing and commissioning.

6.3.2 Tripping test



Warning

Primary tests shall be performed only by qualified personnel which is trained in commissioning of protection systems and familiar with the operation of the protected object as well as the rules and regulations (switching, earthing, etc.)

In order to test the tripping circuits, a control command must be given from a protection or supervision relay which energizes the related matrix input (column). The corresponding switching elements (master relays, circuit breaker coils) will be energized by the outputs (rows) of the matrix device, in accordance with the settings of the diode plugs of the cross-bar distributor. The LEDs assigned to the columns and rows under test must be illuminated and remain illuminated (latched). In addition, the common trip indication must appear. All stored indication disappear after pushing the "RESET" button on the front of the device.



Warning

After output of the trip command the switching device will be operated. Ensure before each test, that switching is permissible under the actual switchgear condition.

E.g. isolate circuit breakers by opening the disconnectors at both sides.



Caution!

The thermal limit of 1 A of the control inputs must be observed. When more than one control input is subjected to the max. permissible continuous current, overload and damage can result. Therefore, these test must be short-term tests. Observe a cooling-down period after each test.

6.4 Making ready for service

Marshalling of the trip commands should be checked again, in case they were altered during the tests.

Stored indications on the front plate should be reset by pressing the push-button "RESET LED" on the front so that from then on only real faults are indicated. During pushing the RESET button, the LEDs on the front will light-up; thus, a LED test is performed at the same time.

The green LED "+ 15 V-" on the front must be on.

Close housing cover, seal it if desired.

All terminal screws – even those not in use – must be tightened.

The tripping matrix is now ready for operation.

7 Maintenance and fault tracing

Siemens solid state protective relays are designed to require no special maintenance. All signal processing circuits are fully solid state and therefore maintenance free. Input and output relays are hermetically sealed or provided with protective covers.



Warning

Ensure that the connection modules are not damaged when removing or inserting the device modules!

7.1 Routine checks

The tripping matrix function is tested at each protection system test. This serves mainly for checking the interfaces of the unit, i.e. the coupling with the protection relays and the plant.



Warning

Hazardous voltages can be present on all circuits and components connected with the supply voltage or with the input and output quantities!

- Circuit–breaker trip circuits are tested by actual live tripping. Respective notes are given in Section 6.3.2.

7.2 Fault tracing

If the device indicates a defect, the following procedure is suggested:

If none of the LEDs on the front plate of the module is on, then check:

- Has the module been properly pushed–in and locked?
- Is the auxiliary voltage available with the correct polarity and of adequate magnitude, connected to the correct terminals (general diagram in Appendix A)?
- Has the mini–fuse in the power supply section blown (see Figure 7.1)? If appropriate, replace the fuse according to Section 7.2.1.

7.2.1 Replacing the mini-fuse

- Select a replacement fuse 5×20 mm. Ensure that the rated value, time lag (medium slow) and code letters are correct. (Figure 7.1).
- Prepare area of work: provide conductive surface for the module.
- Open housing cover.
- Unscrew the four fixing screws in the rear wall of the housing.
- Pull out the module and place it onto the conductive surface.
- Remove blown fuse from the holder (Figure 7.1).
- Fit new fuse into the holder (Figure 7.1).
- Insert module into the housing and fix it with the four fixing screws.
- Close housing cover.

Warning

Hazardous voltages can be present in the device even after disconnection of the supply voltage or after removal of the module from the housing (storage capacitors)!

Caution!

Electrostatic discharges via the component connections, the PCB tracks or the connecting pins of the modules must be avoided under all circumstances by previously touching an earthed metal surface.

Switch on the device again. If a power supply failure is still signalled, a fault or short-circuit is present in the internal power supply. The device should be returned to the factory (see Chapter 8).

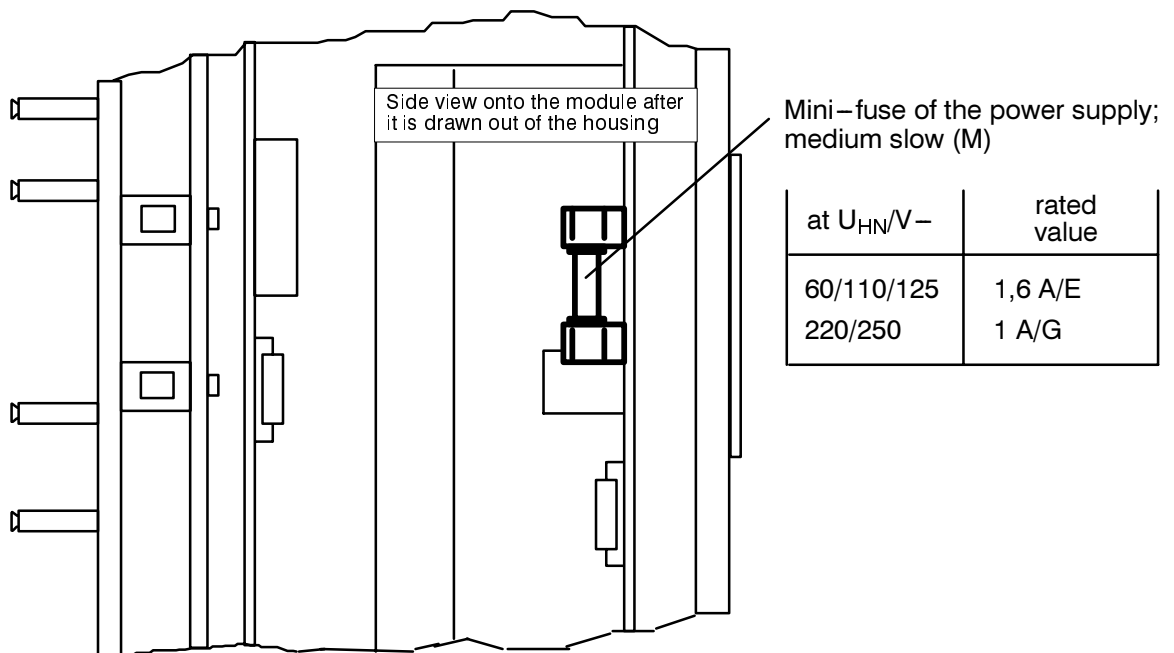

Figure 7.1 Mini-fuse of the power supply

8 Repairs

Repair of defective modules is not recommended at all because specially selected electronic components are used which must be handled in accordance with the procedures required for **Electrostatically Endangered Components (EEC)**. Furthermore, special manufacturing techniques are necessary for any work on the printed circuit boards in order to do not damage the bath-soldered multilayer boards, the sensitive components and the protective finish.

Therefore, if a defect cannot be corrected by operator procedures such as described in Chapter 7, it is recommended that the complete relay should be returned to the manufacturer. Use the original transport packaging for return. If alternative packing is used, this must provide the degree of protection against mechanical shock, as laid down in IEC 255-21-1 class 2 and IEC 255-21-2 class 1.

If it is unavoidable to replace individual modules, it is imperative that the standards related to the handling of **Electrostatically Endangered Components** are observed.



Warning

Hazardous voltages can be present in the device even after disconnection of the supply voltage or after removal of the module from the housing (storage capacitors)!



Caution!

Electrostatic discharges via the component connections, the PCB tracks or the connecting pins of the modules must be avoided under all circumstances by previously touching an earthed metal surface. This applies equally for the replacement of removable components, such as EPROM or EEPROM chips. For transport and returning of individual modules electrostatic protective packing material must be used.

Components and modules are not endangered as long as they are installed within the relay.

Should it become necessary to exchange any device or module, the complete parameter assignment should be repeated. Respective notes are contained in Chapter 5 and 6.

9 Storage

Solid state protective relays shall be stored in dry and clean rooms. The limit temperature range for storage of the relays or associated spare parts is $-25\text{ }^{\circ}\text{C}$ to $+55\text{ }^{\circ}\text{C}$ (refer Section 3.1.4 under the Technical data), corresponding to $-12\text{ }^{\circ}\text{F}$ to $130\text{ }^{\circ}\text{F}$.

The relative humidity must be within limits such that neither condensation nor ice forms.

It is recommended to reduce the storage temperature to the range $+10\text{ }^{\circ}\text{C}$ to $+35\text{ }^{\circ}\text{C}$ ($50\text{ }^{\circ}\text{F}$ to $95\text{ }^{\circ}\text{F}$); this prevents from early ageing of the electrolytic capacitors which are contained in the power supply.

For very long storage periods, it is recommended that the relay should be connected to the auxiliary voltage source for one or two days every other year, in order to regenerate the electrolytic capacitors. The same is valid before the relay is finally installed. In extreme climatic conditions (tropics) pre-warming would thus be achieved and condensation avoided.

Before initial energization with supply voltage, the relay shall be situated in the operating area for at least two hours in order to ensure temperature equalization and to avoid humidity influences and condensation.

Appendix

A General diagrams

A General diagrams

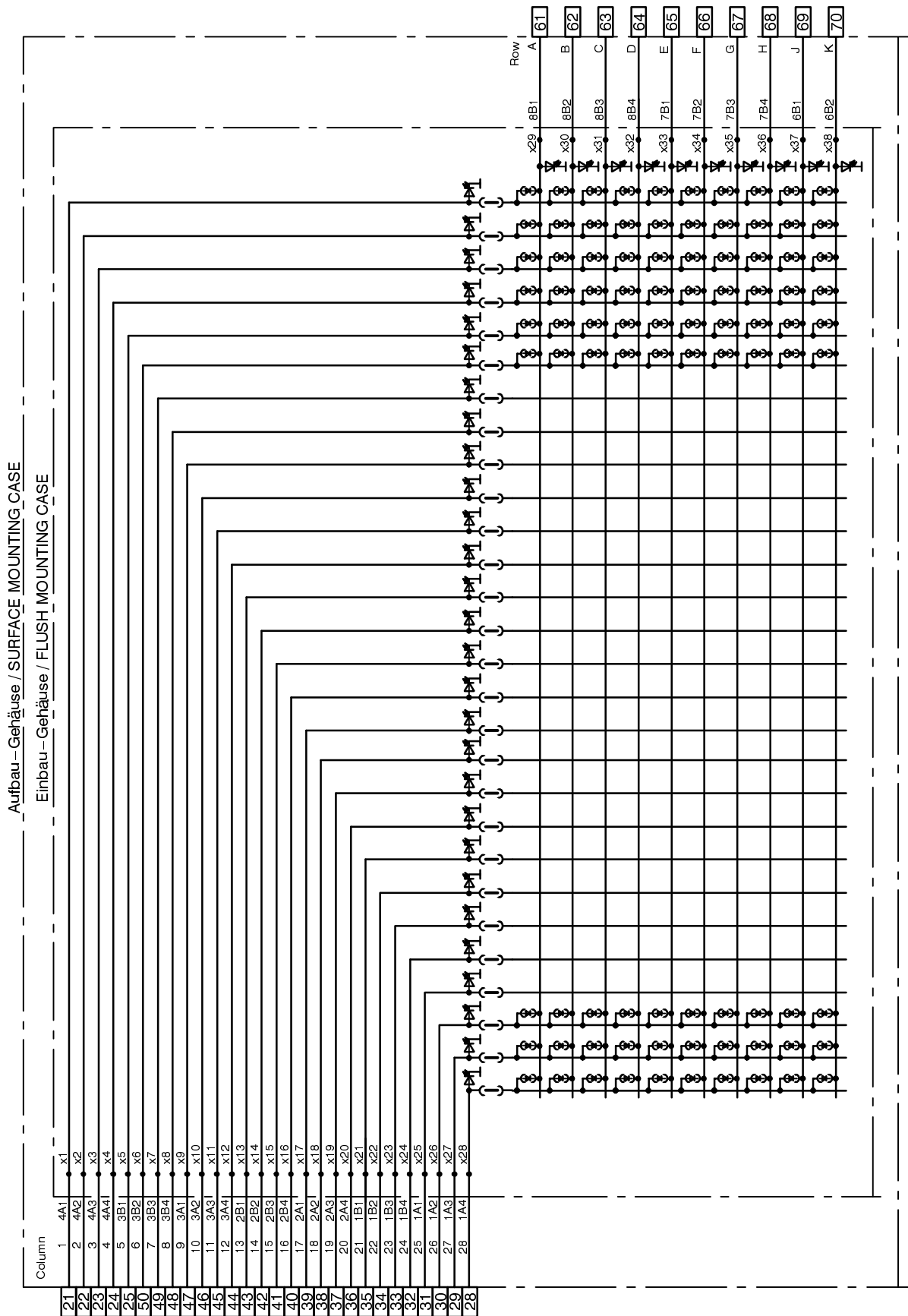

Figure A.1 General diagram 7UW5000 (sheet 1 of 2)

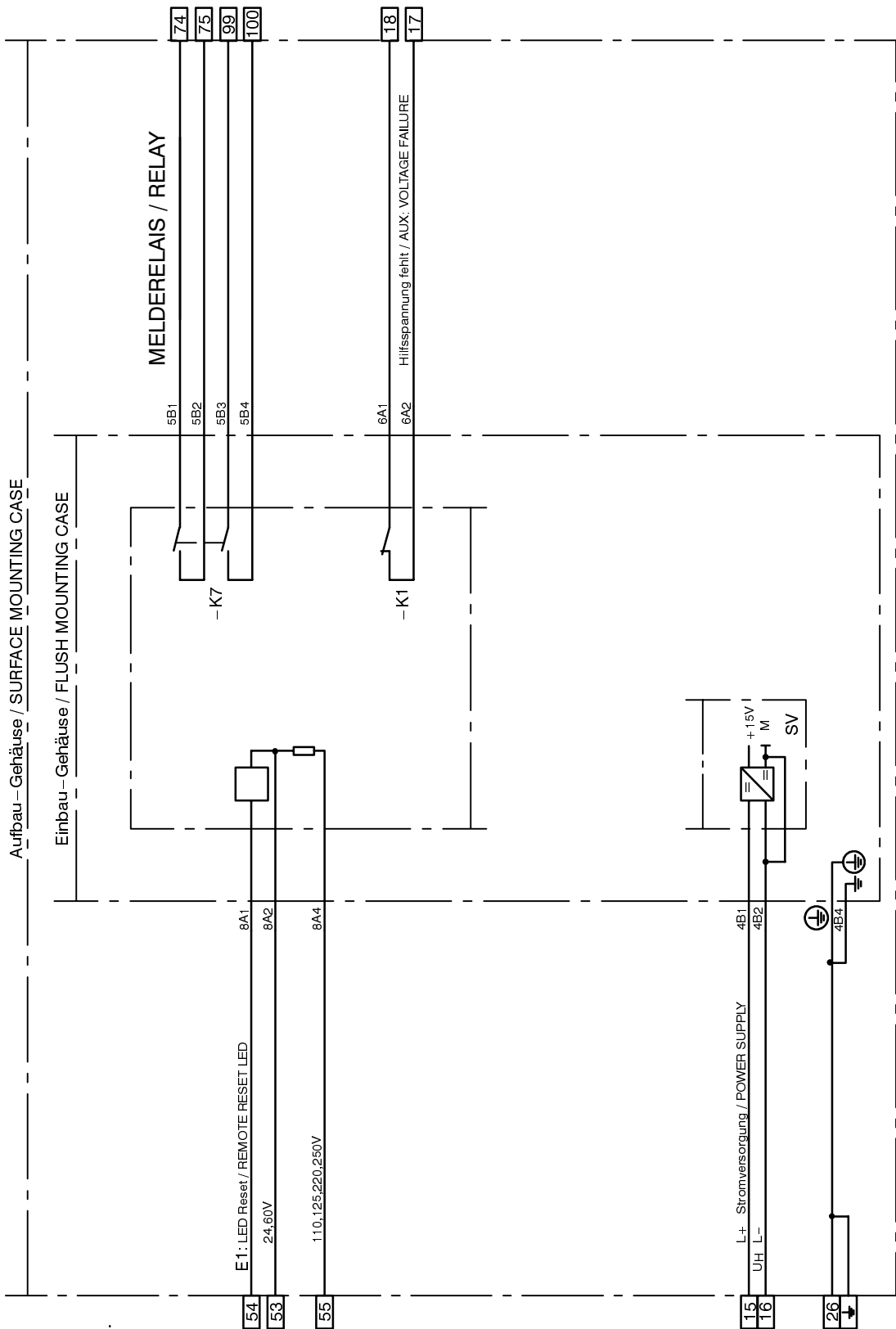

Figure A.2 General diagram 7UW5000 (sheet 2 of 2)

To

SIEMENS AKTIENGESELLSCHAFT

Dept. EV S SUP 2

D-13623 BERLIN

Germany

Dear reader,

printing errors can never be entirely eliminated:
therefore, should you come across any when
reading this manual, kindly enter them in this
form together with any comments or sug-
gestions for improvement that you may have.

From

Name

Company/Dept.

Address

Telephone no.

Corrections/Suggestions

Substantial alterations against previous issue:

Additions in sections 3.1.1 and 6.3.2

Subject to technical alteration

Copying of this document and giving it to others and the use or communication of the contents thereof, are forbidden without express authority. Offenders are liable to the payment of damages. All rights are reserved in the event of the grant of a patent or the registration of a utility model or design.

Siemens Aktiengesellschaft

Order No. C53000–G1176–C88–3
Available from: LZF Fürth – Bislohe
Printed in the Federal Republic of Germany
AG 0999 0.1 FO 32 En