

**SIEMENS**



**LOW-VOLTAGE POWER DISTRIBUTION**

**ALPHA BSIII 160 MCCB**

**Panel Boards**

[siemens.com](https://www.siemens.com)

# Safe and Intelligent power distribution

ALPHA BSIII 160. Totally Integrated Power Distribution.

## Features

- Fully Type tested to IEC / BS EN 61439-2
- Manufactured in the UK
- Compact with a flexible modular design
- Degree of Protection IP3X
- Busbar systems from 250A to 800A
- $I_{cn}$  from 25kA for 1s up to 65kA for 1s
- Form 3bT2 or 4bT6 GM
- Utilises Siemens 3VA MCCBs
- Quick and easy installation
- Full UK based technical support available
- 1P, 3P and 4P Devices
- 160A Outgoing Devices as standard
- 250A Outgoing Device Add-on Options available

Please click the product images to find out more



# Specification Highlights

Outgoing meter options. Standard or MID

Modular construction

3VA Moulded Case Circuit Breaker technology

1.2mm thick mild steel powder coated construction

Outgoing Earth Leakage Protection options

Slim, compact design with ample room for cable dressing

Keyhole fixings for easy power tool access

Fully type tested to IEC / BS EN 61439-2

Integral surge protection kits. Type 1, Type 2 or combined

Integral Incoming meter options. Standard or MID

Hinged/removeable Cableway doors

## Suitable Applications

- Offices
- Tall Buildings
- Hotels and residential
- Campuses
- Industrial
- Process and Production
- Entertainment and Leisure
- Healthcare

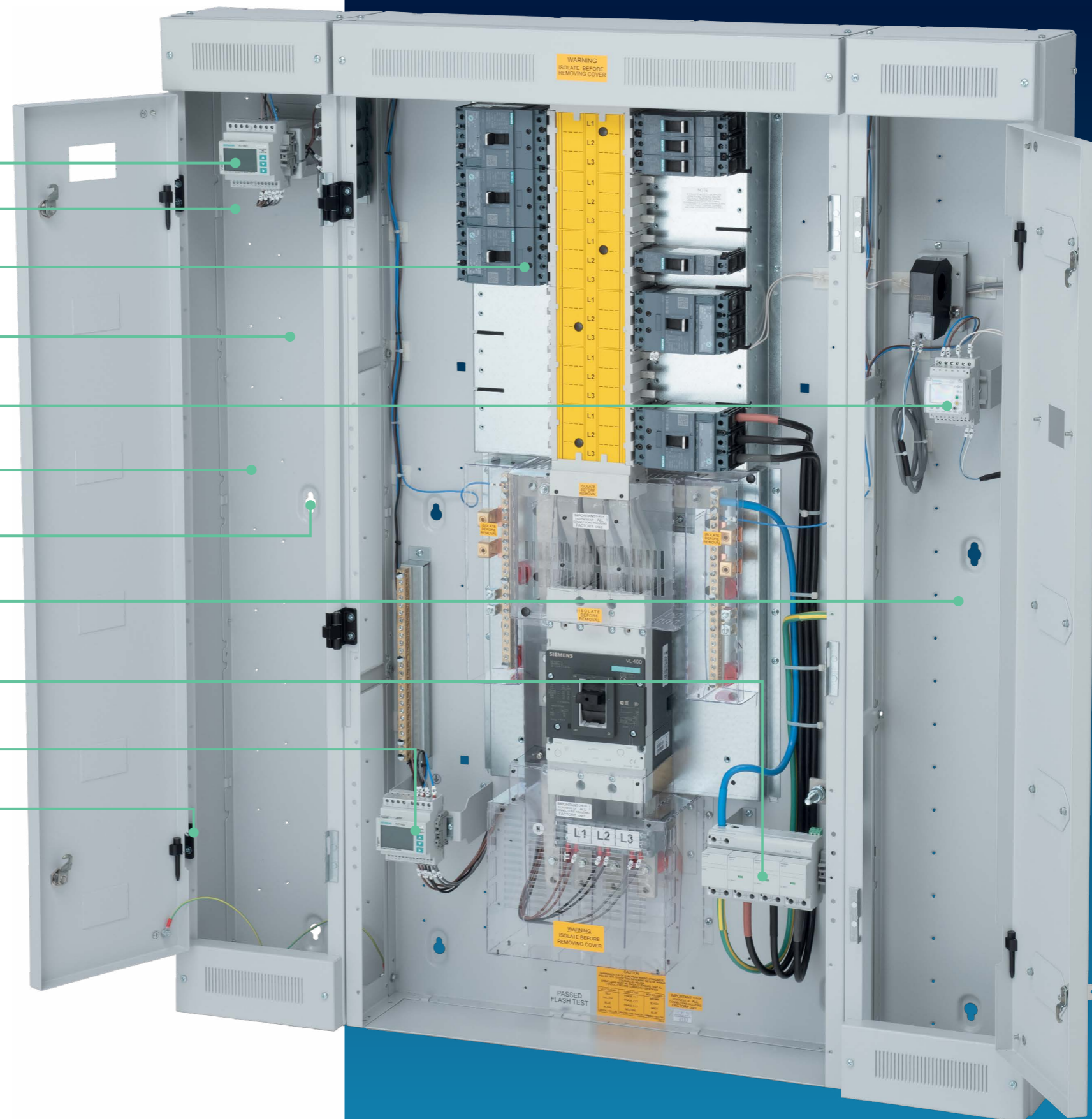

# MCCB Panel Boards

## ALPHA BSIII 160



8GP1306-4DA54

### 250A Panel Board

Outgoing ways	H (mm)	W (mm)	D (mm)	List No
6 Way	902	700	198	8GP1306-4DA54
12 Way	1132	700	198	8GP1312-4DA54
18 Way	1361	700	198	8GP1318-4DA54

#### Features

- 250A rated Busbar
- Type tested & ASTA certified to IEC 61439-2; Ed 2 2011-08
- 25kA for 1s Short Circuit Withstand Strength
- Form 3b Type 2 Form of Separation
- IP3X (door closed)



3VA1225-1AA32-0AA0

### 250A Panel Board Incomers

Description	List No
250A 3P Switch Disconnecter	3VA1225-1AA32-0AA0
250A 4P Switch Disconnecter	3VA1225-1AA42-0AA0
250A Direct Connection Coppers	8GP1921-0DA71
Incoming Device Interconnections 3P*	8GP1921-0DA88
Incoming Device Interconnections 4P*	8GP1921-0DA70

#### Switch Disconnectors

- Fixed Short Circuit Release (SD100)
- Max cable lug connection 25mm wide
- Max busbar/lug 8mm thick

\* Interconnections are necessary when selecting a Switch Disconnecter or MCCB incoming device



3VA9253-0JA12

### Incomer Accessories

3P		List No
Box Terminals	50...185mm <sup>2</sup>	3VA9253-0JA12
Circular Conductor Terminals	50...185mm <sup>2</sup>	3VA9213-0JJ13
Extended Terminal Bars	M10 fixing 25mm palm	3VA9253-0QB00
Extended Terminal Bars (Offset)	M10 fixing 30mm palm	3VA9253-0QC00
Terminal Shroud		3VA9211-0WF30
Terminal Shroud (Offset)		3VA9211-0WG30

4P		List No
Box Terminals	50...185mm <sup>2</sup>	3VA9254-0JA12
Circular Conductor Terminals	50...185mm <sup>2</sup>	3VA9214-0JJ13
Extended Terminal Bars	M10 fixing 25mm palm	3VA9254-0QB00
Extended Terminal Bars (Offset)	M10 fixing 30mm palm	3VA9254-0QC00
Terminal Shroud		3VA9211-0WF40
Terminal Shroud (Offset)		3VA9211-0WG40

If Extended Terminal Bars are selected, we recommend the use of cable spreader box. See Page 16

# MCCB Panel Boards

## ALPHA BSIII 160



8GP1312-5DA54

### 400A Panel Board

Outgoing ways	H (mm)	W (mm)	D (mm)	List No
6 way	1132	700	198	8GP1306-5DA54
12 way	1361	700	198	8GP1312-5DA54
18 way	1591	700	198	8GP1318-5DA54

#### Features

- 400A rated Busbar
- Type tested & ASTA certified to IEC 61439-2; Ed 2 2011-08
- 35kA for 1s Short Circuit Withstand Strength
- Form 3b Type 2 Form of Separation
- IP3X (door closed)



3VA2340-5HN42-0AA0

### 400A Panel Board Incomers

Description	List No
400A 3P Switch Disconnector	3VA1340-1AA32-0AA0
400A 4P Switch Disconnector	3VA1340-1AA42-0AA0
400A 3P MCCB	3VA2340-5HN32-0AA0
400A 4P MCCB	3VA2340-5HN42-0AA0
400A Direct Connection Coppers	8GP1921-0DA74
Incoming Device Interconnections 3P*	8GP1921-0DA72
Incoming Device Interconnections 4P*	8GP1921-0DA73

\* Interconnections are necessary when selecting a Switch Disconnector or MCCB incoming device

#### MCCBs:

- Electronic Trip Unit (ETU350) LSI Protection
- 630A Frame
- $I_n = 400A$
- $I_{cu} = 55kA @ 415V$
- $I_t = 160A...400A$
- $I_{sd} = 1.5...10 \times I_t$
- $I_i = 10 \times I_n$
- N conductor protection adjustable: OFF, 50%, 100% (4P only)
- Max cable lug connection 35mm wide
- Max busbar/lug 10mm thick

#### Switch Disconnector

- Fixed Short Circuit Release (SD100)
- Max cable lug connection 35mm wide
- Max busbar/lug 10mm thick



3VA9404-0JJ23

### Incomer Accessories

3P		List No
Box Terminals	50...300mm <sup>2</sup>	3VA9483-OJA13
Twin Circular Conductor Terminals	2x70...300mm <sup>2</sup>	3VA9403-OJJ23
Extended Terminal Bars	M10 fixing 35mm palm	3VA9483-OQB00
Extended Terminal Bars (Offset)	M12 fixing 45mm palm	3VA9483-OQC00
Terminal Shroud		3VA9481-OWF30
Terminal Shroud (Offset)		3VA9401-OWG30
4P		List No
Box Terminals	50...300mm <sup>2</sup>	3VA9484-OJA13
Twin Circular Conductor Terminals	2x70...300mm <sup>2</sup>	3VA9404-OJJ23
Extended Terminal Bars	M10 fixing 35mm palm	3VA9484-OQB00
Extended Terminal Bars (Offset)	M12 fixing 45mm palm	3VA9484-OQC00
Terminal Shroud		3VA9481-OWF40
Terminal Shroud (Offset)		3VA9401-OWG40

- If Extended Terminal Bars are selected, we recommend the use of cable spreader box. See Page 16

# MCCB Panel Boards

## ALPHA BSIII 160



8GP1801-ODA11

### 800A Panel Board

Outgoing ways	H (mm)	W (mm)	D (mm)	List No
4 way	1361	700	226	8GP1801-ODA11
8 way	1591	700	226	8GP1801-ODA12
12 way	1820	700	226	8GP1801-ODA13

### Features

- 800A rated
- 4P Panel Board (Form 4b Type 6 GM)
- Type tested & ASTA certified to IEC 61439-2; Ed 2 2011-08
- 65kA for 1s Short Circuit Withstand Strength
- Form 4b Type 6 Form of Separation
- IP3X (door closed)



3VW9011-0AL72

### Incomer Accessories

4P		List No
Extended Terminal Bars		3VW9011-0AL78
Quad Circular Conductor Terminals	4 x 240mm <sup>2</sup>	3VW9011-0AL72
Terminal Shroud		3VW9724-0WF40



3VA2780-2AC13-0AA0

### 800A Panel Board Incomers

Description	List No
800A 4P Switch Disconnecter	3VA2780-1AA13-0AA0
800A 4P Push Button Operated MCCB	3VA2780-2AC13-0AA0
800A Direct Connection Coppers	8GP1921-0DA81
Incoming Device Interconnections 4P*	8GP1921-0DA80

\* Interconnections are necessary when selecting a Switch Disconnecter or MCCB incoming device

### Push Button Operated MCCB

- Electronic Trip Unit (ETU350) LSI Protection
- 1600A Frame
- $I_n = 800A$
- $I_{cu} = 85kA @ 415V$
- $I_r = 320A...800A$
- $I_{sd} = 1...10 \times I_n$
- $I_i = 1.5...15 \times I_n$
- N conductor protection adjustable: OFF, 50%, 100%, 200%
- See data sheet for connection spacing

### Switch Disconnecter

- Fixed Short Circuit Release (SD100)
- $I_n = 800A$
- $I_{cu} = 55kA @ 415V$
- Max cable lug connection/busbar 50mm wide
- See data sheet for connection spacing

# Integral Incoming Metering



## 250A Panel Board Metering

	List No
Standard 250A Meter Kit	8GP1921-0DA82
MID 250A Meter Kit	8GP1921-0DA83

- Contains PAC1600 Meter offering Amps, Volts & kWh readout along with appropriate Current Transformers, Mounting Plates & Cable Looms. The latter supplied loose for connection by Installer
- Only one of the above options is possible per Panel Board
- Voltage supply loom kit required for ANY metering option. Please see page 14



## 400A Panel Board Metering

	List No
Standard 400A Meter Kit	8GP1921-0DA84
MID 400A Meter Kit	8GP1921-0DA85

- Contains PAC1600 Meter offering Amps, Volts & kWh readout along with appropriate Current Transformers, Mounting Plates & Cable Looms. The latter supplied loose for connection by Installer
- Only one of the above options is possible per Panel Board
- Voltage supply loom kit required for ANY metering option. Please see page 14



## 800A Panel Board Metering

	List No
Standard 800A Meter Kit	8GP1921-0DA86
MID 800A Meter Kit	8GP1921-0DA87

- Contains PAC1600 Meter offering Amps, Volts & kWh readout along with appropriate Current Transformers, Mounting Plates & Cable Looms. The latter supplied loose for connection by Installer
- Only one of the above options is possible per Panel Board
- Voltage supply loom kit required for ANY metering option. Please see page 14

# Integral Surge Protection Kits



8GP1802-0DA08

## 250A & 400A Panel Boards

	List No
Lighting Arrester Kit (Type 1)	8GP1802-0DA08
Surge Arrester Kit (Type 2)	8GP1802-0DA07
Combo Lighting & Surge Arrester Kit (Type 1/2)	8GP1802-0DA10

- Each kit contains: Arrester, 3P MCCB, mounting base & cables
- Kits will utilise the bottom right hand outgoing way for MCCB connection
- Only one of the above options is possible per Panel Board



## 800A Panel Boards

	List No
Lighting Arrester Kit (Type 1)	8GP1802-0DA28
Surge Arrester Kit (Type 2)	8GP1802-0DA27
Combo Lighting & Surge Arrester Kit (Type 1/2)	8GP1802-0DA30

- Each kit contains: Arrester, 4P MCCB, mounting base & cables
- Kits will utilise the bottom right hand outgoing way for MCCB connection
- Only one of the above options is possible per Panel Board

# Outgoing Metering



8GP1917-ODA01

## Standard Metering

Available outputs: Pulsed Output & ModBus (RTU)

	List No
160A 3P Meter Kit	8GP1917-ODA01
250A 3P Meter Kit	8GP1802-ODA21

- 250A kit for use with 2W 250A add-on unit only
- Contains PAC1600 Meter offering Amps, Volts & kWh readout along with appropriate Current Transformers, Mounting Plates & Cable Looms. The latter supplied loose for connection by Installer
- Available data outputs can be used simultaneously

## MID Metering

Available outputs: Pulsed Output & ModBus (RTU)

	List No
160A 3P 4w Meter Kit	8GP1917-ODA02
250A 3P 4w Meter Kit	8GP1802-ODA22

- 250A kit for use with 2W 250A add-on unit only
- Contains PAC1600 Meter offering Amps, Volts & kWh readout along with appropriate Current Transformers, Mounting Plates & Cable Looms. The latter supplied loose for connection by Installer
- For multiple 1P MID meter kits contact our custom built panel team (FBA)
- Available data outputs can be used simultaneously



8GP1802-ODA23

## Meter Pack Voltage Supply Loom

Description	List No
250A, 400A & 800A Panel Boards	8GP1802-ODA23

- Voltage supply loom kit required for any metering option
- One voltage supply loom required per cableway

# Outgoing Earth Leakage Protection



8GP1921-ODA13

## Outgoing Earth Leakage Kit

Consisting of:

Modular Residual Current Device (MRCDD) with adjustable earth leakage sensitivity from 30mA to 3A (0.03A, 0.1A, 0.3A, 0.5A, 1A, 2A, 3A)  
Adjustable time delay from 0 to 10s (INS, SEL, 0.06s, 0.1s, 0.3s, 0.4s, 0.5s, 1s, 3s, 5s, 10s) and Summation Current Transformer

	List No
35mm Internal Diameter	8GP1921-ODA13
70mm Internal Diameter	8GP1921-ODA14
Holder for DIN rail mounting	Available on request

- Outgoing Earth leakage kits for use with 3P or 4P MCCB's only



8GP1802-ODA24

## Earth Leakage Voltage Supply Loom

Description	List No
250A, 400A & 800A Panel Boards	8GP1802-ODA24

- Voltage supply loom kit required for any earth leakage option
- One voltage supply loom required per cableway



# Cableways



8GP1921-0DA18

## Meter Cableways

Description	Meter Knockouts	250	400	800	List No
Size 1	4	6W	-	-	8GP1921-0DA16
Size 2	6	12W	6W	-	8GP1921-0DA17
Size 3	7	18W	12W	4W	8GP1921-0DA18
Size 4	9	-	18W	8W	8GP1921-0DA20
Size 5	10	-	-	12W	8GP1921-0DA40

- If metered cableway & earth leakage cableway options are required simultaneously, please contact our custom built panel team (FBA). Please see contact details on the back page of this document.



8GP1921-0DA43

## Earth Leakage Cableways

Description	MRCB Knockouts	250	400	800	List No
Size 1	3	6W	-	-	8GP1921-0DA41
Size 2	4	12W	6W	-	8GP1921-0DA42
Size 3	5	18W	12W	4W	8GP1921-0DA43
Size 4	6	-	18W	8W	8GP1921-0DA44
Size 5	7	-	-	12W	8GP1921-0DA45

- If metered cableway & earth leakage cableway options are required simultaneously, please contact our custom built panel team (FBA). Please see contact details on the back page of this document.

# Add-on Options



8GP1921-0DA23

## Add-on Enclosure for 400A Panel Board

Description	List No
2 way 250A 3P Outgoing MCCB Housing	8GP1921-0DA25

- Includes all interconnections
- Accepts 3VA12 range of MCCB's up to 250A
- Busbar 25kA for 1s Short Circuit Withstand Strength
- Includes L/H & R/H cableways to suit 2W add-on unit.
- Dims: 380mm high x 1200mm wide x 198mm deep

## Add-on Enclosure for 800A Panel Board

Description	List No
2 way 250A 4P Outgoing MCCB Housing	Available on request

- Includes all interconnections
- Accepts 3VA12 range of MCCB's up to 250A
- Busbar 25kA for 1s Short Circuit Withstand Strength

## Add-on Control Module Enclosure

Description	List No
Add-on Control Module Enclosure	8GP1921-0DA21

- 24 module (each 18mm wide), DIN rail
- Dims: 230mm high x 700mm x 198mm deep

## Add-on Distribution Board

Description	List No
Add-on 100A 1P+N Distribution Board - 20 way 1P+N	8GP1921-0DA22

- Supplied with 100A 2P Switch Disconnecter and comb busbar
- Accepts Siemens MCBs up to 63A.
- Dims: 230mm high x 700mm wide x 198mm deep

# I Add-on Options



8GP1921-0DA23

## Add-on Distribution Board

Description	List No
Add-on 80A 3P+N Distribution Board - 6 way 3P+N	8GP1921-0DA23

- Supplied with 80A 3P+N Switch Disconnecter and comb busbar
- Accepts Siemens MCBs up to 63A.
- Dims: 230mm high x 700mm wide x 198mm deep

## Add-on Cable Spreader Box

Description	List No
Add-on Cable Spreader Box	8GP1921-0DA24

- Empty Enclosure
- Dims: 230mm high x 700mm wide x 198mm deep

## Corner Unit

Description	List No
Corner Unit	8GP1921-0DA15

- Two corner units needed per add on option - Excludes 2 Way add on options
- Dims: 230mm high x 249mm wide x 198mm deep

# I Panel Board Accessories



8GP1921-0DA56

## Spares / Replacement Parts

Description	List No
Replacement Gland Plates - Panel Board	8GP1921-0DA27
Replacement Gland Plates - Cableway	8GP1921-0DA28
Door Hinge (set of 2)	8GP1921-0DA53
Door Lock Latch	8GP1921-0DA55
Lock & Key	8GP1921-0DA54
Oversized Cable Clamps for Terminal Bar (35mm <sup>2</sup> ) pack of 3	8GP1921-0DA50
Oversized Cable Clamps for Terminal Bar (70mm <sup>2</sup> ) pack of 3	8GP1921-0DA51
Incoming Earth Connection	8GP1921-0DA52
Replacement Fixing Kit	8GP1921-0DA56
Terminal Bar (11 Connections)	8GP1921-0DA57
Terminal Bar (21 Connections)	8GP1921-0DA58
Terminal Bar (31 Connections)	8GP1921-0DA67

Way Labels	List No
6-Way	8GP1921-0DA60
12-Way	8GP1921-0DA61
18-Way	8GP1921-0DA62
4-Way(4P)	8GP1921-0DA63
8-Way(4P)	8GP1921-0DA64
12-Way(4P)	8GP1921-0DA65

## Gland Plates

	List No
Aluminium Gland Plate, 3mm - Panel Board	8GP1921-0DA30
Aluminium Gland Plate, 3mm - Cableway	8GP1921-0DA31
Brass Gland Plate, 3mm- Panel Board	8GP1921-0DA32

## Blanking Kits

	List No
Busbar & Shield blanking kit – 1P	8GP1921-0DA10
Busbar & Shield blanking kit – 3P	8GP1921-0DA11

# TM210 - FTFM Fixed Thermal & Fixed Magnetic Protection



### Breaking Capacity @ 240V AC

Rated Current 1P	25kA	36kA	55kA	70kA
16A	3VA1196-3ED16-0AA0	3VA1196-4ED16-0AA0	3VA1196-5ED16-0AA0	-
20A	3VA1120-3ED16-0AA0	3VA1120-4ED16-0AA0	3VA1120-5ED16-0AA0	-
25A	3VA1125-3ED16-0AA0	3VA1125-4ED16-0AA0	3VA1125-5ED16-0AA0	-
32A	3VA1132-3ED16-0AA0	3VA1132-4ED16-0AA0	3VA1132-5ED16-0AA0	-
40A	3VA1140-3ED16-0AA0	3VA1140-4ED16-0AA0	3VA1140-5ED16-0AA0	-
50A	3VA1150-3ED16-0AA0	3VA1150-4ED16-0AA0	3VA1150-5ED16-0AA0	-
63A	3VA1163-3ED16-0AA0	3VA1163-4ED16-0AA0	3VA1163-5ED16-0AA0	-
80A	3VA1180-3ED16-0AA0	3VA1180-4ED16-0AA0	3VA1180-5ED16-0AA0	-
100A	3VA1110-3ED16-0AA0	3VA1110-4ED16-0AA0	3VA1110-5ED16-0AA0	-
125A	3VA1112-3ED16-0AA0	3VA1112-4ED16-0AA0	3VA1112-5ED16-0AA0	-
160A	3VA1116-3ED16-0AA0	3VA1116-4ED16-0AA0	3VA1116-5ED16-0AA0	-



### Breaking Capacity @ 415V AC

Rated Current 4P	25kA	36kA	55kA	70kA
16A	3VA1196-3GD46-0AA0	3VA1196-4GD46-0AA0	3VA1196-5GD46-0AA0	3VA1196-6GD46-0AA0
20A	3VA1120-3GD46-0AA0	3VA1120-4GD46-0AA0	3VA1120-5GD46-0AA0	3VA1120-6GD46-0AA0
25A	3VA1125-3GD46-0AA0	3VA1125-4GD46-0AA0	3VA1125-5GD46-0AA0	3VA1125-6GD46-0AA0
32A	3VA1132-3GD46-0AA0	3VA1132-4GD46-0AA0	3VA1132-5GD46-0AA0	3VA1132-6GD46-0AA0
40A	3VA1140-3GD46-0AA0	3VA1140-4GD46-0AA0	3VA1140-5GD46-0AA0	3VA1140-6GD46-0AA0
50A	3VA1150-3GD46-0AA0	3VA1150-4GD46-0AA0	3VA1150-5GD46-0AA0	3VA1150-6GD46-0AA0
63A	3VA1163-3GD46-0AA0	3VA1163-4GD46-0AA0	3VA1163-5GD46-0AA0	3VA1163-6GD46-0AA0
80A	3VA1180-3GD46-0AA0	3VA1180-4GD46-0AA0	3VA1180-5GD46-0AA0	3VA1180-6GD46-0AA0
100A	3VA1110-3GD46-0AA0	3VA1110-4GD46-0AA0	3VA1110-5GD46-0AA0	3VA1110-6GD46-0AA0
125A	3VA1112-3GD46-0AA0	3VA1112-4GD46-0AA0	3VA1112-5GD46-0AA0	3VA1112-6GD46-0AA0
160A	3VA1116-3GD46-0AA0	3VA1116-4GD46-0AA0	3VA1116-5GD46-0AA0	3VA1116-6GD46-0AA0



### Breaking Capacity @ 415V AC

Rated Current 3P	25kA	36kA	55kA	70kA
16A	3VA1196-3ED36-0AA0	3VA1196-4ED36-0AA0	3VA1196-5ED36-0AA0	3VA1196-6ED36-0AA0
20A	3VA1120-3ED36-0AA0	3VA1120-4ED36-0AA0	3VA1120-5ED36-0AA0	3VA1120-6ED36-0AA0
25A	3VA1125-3ED36-0AA0	3VA1125-4ED36-0AA0	3VA1125-5ED36-0AA0	3VA1125-6ED36-0AA0
32A	3VA1132-3ED36-0AA0	3VA1132-4ED36-0AA0	3VA1132-5ED36-0AA0	3VA1132-6ED36-0AA0
40A	3VA1140-3ED36-0AA0	3VA1140-4ED36-0AA0	3VA1140-5ED36-0AA0	3VA1140-6ED36-0AA0
50A	3VA1150-3ED36-0AA0	3VA1150-4ED36-0AA0	3VA1150-5ED36-0AA0	3VA1150-6ED36-0AA0
63A	3VA1163-3ED36-0AA0	3VA1163-4ED36-0AA0	3VA1163-5ED36-0AA0	3VA1163-6ED36-0AA0
80A	3VA1180-3ED36-0AA0	3VA1180-4ED36-0AA0	3VA1180-5ED36-0AA0	3VA1180-6ED36-0AA0
100A	3VA1110-3ED36-0AA0	3VA1110-4ED36-0AA0	3VA1110-5ED36-0AA0	3VA1110-6ED36-0AA0
125A	3VA1112-3ED36-0AA0	3VA1112-4ED36-0AA0	3VA1112-5ED36-0AA0	3VA1112-6ED36-0AA0
160A	3VA1116-3ED36-0AA0	3VA1116-4ED36-0AA0	3VA1116-5ED36-0AA0	3VA1116-6ED36-0AA0

- If selecting 1P or 3P devices for use in the 4P Panel Board (800A), please ensure a Neutral Link is selected to allow termination of the Neutral Connection. Please see page 24

# TM220 - ATFM Adjustable Thermal & Fixed Magnetic Protection



**Thermal adjustment = 70% ... 100% of I<sub>n</sub>  
Breaking Capacity @ 415V AC**

Rated Current 3P	25kA	36kA	55kA	70kA
16A	3VA1196-3EE36-0AA0	3VA1196-4EE36-0AA0	3VA1196-5EE36-0AA0	3VA1196-6EE36-0AA0
20A	3VA1120-3EE36-0AA0	3VA1120-4EE36-0AA0	3VA1120-5EE36-0AA0	3VA1120-6EE36-0AA0
25A	3VA1125-3EE36-0AA0	3VA1125-4EE36-0AA0	3VA1125-5EE36-0AA0	3VA1125-6EE36-0AA0
32A	3VA1132-3EE36-0AA0	3VA1132-4EE36-0AA0	3VA1132-5EE36-0AA0	3VA1132-6EE36-0AA0
40A	3VA1140-3EE36-0AA0	3VA1140-4EE36-0AA0	3VA1140-5EE36-0AA0	3VA1140-6EE36-0AA0
50A	3VA1150-3EE36-0AA0	3VA1150-4EE36-0AA0	3VA1150-5EE36-0AA0	3VA1150-6EE36-0AA0
63A	3VA1163-3EE36-0AA0	3VA1163-4EE36-0AA0	3VA1163-5EE36-0AA0	3VA1163-6EE36-0AA0
80A	3VA1180-3EE36-0AA0	3VA1180-4EE36-0AA0	3VA1180-5EE36-0AA0	3VA1180-6EE36-0AA0
100A	3VA1110-3EE36-0AA0	3VA1110-4EE36-0AA0	3VA1110-5EE36-0AA0	3VA1110-6EE36-0AA0
125A	3VA1112-3EE36-0AA0	3VA1112-4EE36-0AA0	3VA1112-5EE36-0AA0	3VA1112-6EE36-0AA0
160A	3VA1116-3EE36-0AA0	3VA1116-4EE36-0AA0	3VA1116-5EE36-0AA0	3VA1116-6EE36-0AA0



**Thermal adjustment = 70% ... 100% of I<sub>n</sub>  
Breaking Capacity @ 415V AC**

Rated Current 4P	25kA	36kA	55kA	70kA
16A	3VA1196-3GE46-0AA0	3VA1196-4GE46-0AA0	3VA1196-5GE46-0AA0	3VA1196-6GE46-0AA0
20A	3VA1120-3GE46-0AA0	3VA1120-4GE46-0AA0	3VA1120-5GE46-0AA0	3VA1120-6GE46-0AA0
25A	3VA1125-3GE46-0AA0	3VA1125-4GE46-0AA0	3VA1125-5GE46-0AA0	3VA1125-6GE46-0AA0
32A	3VA1132-3GE46-0AA0	3VA1132-4GE46-0AA0	3VA1132-5GE46-0AA0	3VA1132-6GE46-0AA0
40A	3VA1140-3GE46-0AA0	3VA1140-4GE46-0AA0	3VA1140-5GE46-0AA0	3VA1140-6GE46-0AA0
50A	3VA1150-3GE46-0AA0	3VA1150-4GE46-0AA0	3VA1150-5GE46-0AA0	3VA1150-6GE46-0AA0
63A	3VA1163-3GE46-0AA0	3VA1163-4GE46-0AA0	3VA1163-5GE46-0AA0	3VA1163-6GE46-0AA0
80A	3VA1180-3GE46-0AA0	3VA1180-4GE46-0AA0	3VA1180-5GE46-0AA0	3VA1180-6GE46-0AA0
100A	3VA1110-3GE46-0AA0	3VA1110-4GE46-0AA0	3VA1110-5GE46-0AA0	3VA1110-6GE46-0AA0
125A	3VA1112-3GE46-0AA0	3VA1112-4GE46-0AA0	3VA1112-5GE46-0AA0	3VA1112-6GE46-0AA0
160A	3VA1116-3GE46-0AA0	3VA1116-4GE46-0AA0	3VA1116-5GE46-0AA0	3VA1116-6GE46-0AA0

# TM240 - ATAM Adjustable Thermal & Adjustable Magnetic Protection



**Thermal adjustment = 70% ... 100% of I<sub>n</sub>  
Magnetic adjustment = 5x ... 10x I<sub>n</sub>  
Breaking Capacity @ 415V AC**

Rated Current 3P	25kA	36kA	55kA	70kA
16A	3VA1196-3EF36-0AA0	3VA1196-4EF36-0AA0	3VA1196-5EF36-0AA0	3VA1196-6EF36-0AA0
20A	3VA1120-3EF36-0AA0	3VA1120-4EF36-0AA0	3VA1120-5EF36-0AA0	3VA1120-6EF36-0AA0
25A	3VA1125-3EF36-0AA0	3VA1125-4EF36-0AA0	3VA1125-5EF36-0AA0	3VA1125-6EF36-0AA0
32A	3VA1132-3EF36-0AA0	3VA1132-4EF36-0AA0	3VA1132-5EF36-0AA0	3VA1132-6EF36-0AA0
40A	3VA1140-3EF36-0AA0	3VA1140-4EF36-0AA0	3VA1140-5EF36-0AA0	3VA1140-6EF36-0AA0
50A	3VA1150-3EF36-0AA0	3VA1150-4EF36-0AA0	3VA1150-5EF36-0AA0	3VA1150-6EF36-0AA0
63A	3VA1163-3EF36-0AA0	3VA1163-4EF36-0AA0	3VA1163-5EF36-0AA0	3VA1163-6EF36-0AA0
80A	3VA1180-3EF36-0AA0	3VA1180-4EF36-0AA0	3VA1180-5EF36-0AA0	3VA1180-6EF36-0AA0
100A	3VA1110-3EF36-0AA0	3VA1110-4EF36-0AA0	3VA1110-5EF36-0AA0	3VA1110-6EF36-0AA0
125A	3VA1112-3EF36-0AA0	3VA1112-4EF36-0AA0	3VA1112-5EF36-0AA0	3VA1112-6EF36-0AA0
160A	3VA1116-3EF36-0AA0	3VA1116-4EF36-0AA0	3VA1116-5EF36-0AA0	3VA1116-6EF36-0AA0
250A*	-	3VA1225-4GF32-0AA0	3VA1225-5GF32-0AA0	3VA1225-6GF32-0AA0



**Thermal adjustment = 70% ... 100% of I<sub>n</sub>  
Magnetic adjustment = 5x ... 10x I<sub>n</sub>  
Breaking Capacity @ 415V AC**

Rated Current 4P	25kA	36kA	55kA	70kA
16A	3VA1196-3GF46-0AA0	3VA1196-4GF46-0AA0	3VA1196-5GF46-0AA0	3VA1196-6GF46-0AA0
20A	3VA1120-3GF46-0AA0	3VA1120-4GF46-0AA0	3VA1120-5GF46-0AA0	3VA1120-6GF46-0AA0
25A	3VA1125-3GF46-0AA0	3VA1125-4GF46-0AA0	3VA1125-5GF46-0AA0	3VA1125-6GF46-0AA0
32A	3VA1132-3GF46-0AA0	3VA1132-4GF46-0AA0	3VA1132-5GF46-0AA0	3VA1132-6GF46-0AA0
40A	3VA1140-3GF46-0AA0	3VA1140-4GF46-0AA0	3VA1140-5GF46-0AA0	3VA1140-6GF46-0AA0
50A	3VA1150-3GF46-0AA0	3VA1150-4GF46-0AA0	3VA1150-5GF46-0AA0	3VA1150-6GF46-0AA0
63A	3VA1163-3GF46-0AA0	3VA1163-4GF46-0AA0	3VA1163-5GF46-0AA0	3VA1163-6GF46-0AA0
80A	3VA1180-3GF46-0AA0	3VA1180-4GF46-0AA0	3VA1180-5GF46-0AA0	3VA1180-6GF46-0AA0
100A	3VA1110-3GF46-0AA0	3VA1110-4GF46-0AA0	3VA1110-5GF46-0AA0	3VA1110-6GF46-0AA0
125A	3VA1112-3GF46-0AA0	3VA1112-4GF46-0AA0	3VA1112-5GF46-0AA0	3VA1112-6GF46-0AA0
160A	3VA1116-3GF46-0AA0	3VA1116-4GF46-0AA0	3VA1116-5GF46-0AA0	3VA1116-6GF46-0AA0

\* 250A circuit breakers require additional box terminal kit to be ordered  
250A circuit breakers only for use with 250A 2 Way Add-on unit

# MCCB Accessories

For the full range of available accessories see Catalogue LV10



8GP1921-0DA66

## Neutral Links

	List No
160A Neutral Link Outgoing	8GP1921-0DA66
250A Neutral Link Outgoing	8GP1921-0DA34

- Neutral links required for terminating the Neutral connection in 4P Panel Boards & Add-on units



## MCCB Dolly Locking Device

	List No
For use with 3VA11/12	3VA9088-0LB10
For use with 3VA13/14 & 3VA22/23/24	3VA9388-0LB10



## Aux Switch - SP C/O

	List No
	3VA9988-0AA12



## Trip Alarm Switch - SP C/O

	List No
	3VA9988-0AB12



## Undervoltage Release

	List No
110V AC 50/60Hz	3VA9908-0BB23
208...230V AC 50/60Hz	3VA9908-0BB25
24VDC	3VA9908-0BB11



## Shunt Trip

	List No
24V AC/24...30V DC	3VA9988-0BL30
208...277V AC 50/60Hz 220...250V DC	3VA9988-0BL33

## Blanking kits

	List No
Busbar & Shield blanking kit – 1P	8GP1921-0DA10
Busbar & Shield blanking kit – 3P	8GP1921-0DA11
Busbar & Shield blanking kit – 4P	8GP1921-0DA12

# MCCB Accessories 800A

For the full range of available accessories see Catalogue LV10



## Shunt Trip

	List No
Trip contact S24	3VW9011-0AH14
UVR 24V DC Undervoltage release	3VW9011-0AE01
UVR 110V AC/DC Undervoltage release	3VW9011-0AE05
UVR 230V AC/DC Undervoltage release	3VW9011-0AE08
Shunt 24V DC Shunt trip	3VW9011-0AD01
Shunt 110V AC/DC Shunt trip	3VW9011-0AD05
Shunt 230V AC/DC Shunt trip	3VW9011-0AD07

# MCCB Accessories for outgoing circuits

For the full range of available accessories see Catalogue LV10



## Terminals

Terminal type	No. Pcs	Cable size	To fit frame	List No
Box Terminal Kit*	3	6...120mm <sup>2</sup>	250A 3VA12	3VA9253-OJA11
Box Terminal Kit*	4	6...120mm <sup>2</sup>	250A 3VA12	3VA9254-OJA11
Box Terminal Kit	3	50...185mm <sup>2</sup>	250A 3VA12	3VA9253-OJA12
Box Terminal Kit	4	50...185mm <sup>2</sup>	250A 3VA12	3VA9254-OJA12

\*Required for connecting 250A MCCB's within 8GP1921-0DA25

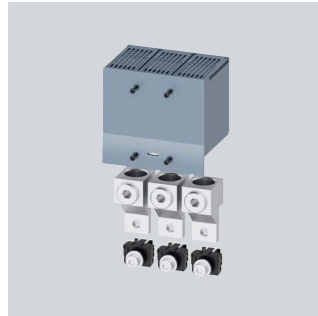

## Terminals

Terminal type	No. Pcs	Cable size	To fit frame	List No
External Cu/Al Cable kit inc. extended shroud	3	25...150mm <sup>2</sup>	160A 3VA11	3VA9113-OJJ12
External Cu/Al Cable kit inc. extended shroud	4	25...150mm <sup>2</sup>	160A 3VA11	3VA9114-OJJ12
External Cu/Al Cable kit inc. extended shroud	3	50...240mm <sup>2</sup>	250A 3VA12	3VA9213-OJJ13
External Cu/Al Cable kit inc. extended shroud	4	50...240mm <sup>2</sup>	250A 3VA12	3VA9214-OJJ13



## Terminals

Terminal type	No. Pcs	To fit frame	List No
Extended bar connections kit inc phase barriers	3	160A 3VA11	3VA9153-OQB00
Extended bar connections kit inc phase barriers	4	160A 3VA11	3VA9154-OQB00
Extended bar connections kit inc phase barriers	3	250A 3VA12	3VA9253-OQB00
Extended bar connections kit inc phase barriers	4	250A 3VA12	3VA9254-OQB00

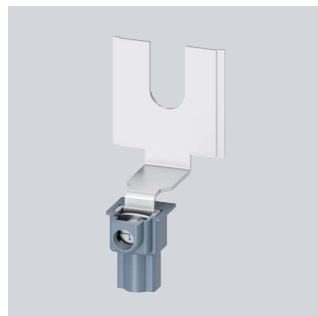

## Control Wire Taps

Terminal type	No. Pcs	To fit frame	List No
Box terminals	1	160A 3VA11	3VA9110-0WB00
		250A 3VA12	3VA9200-0WB00
Busbar	1	160A 3VA11	3VA9110-0WC00
		250A 3VA12	3VA9200-0WC00



## Terminal Shrouds

Shroud type	No. Pcs	To fit frame	List No
1P 3VA Short	1	160A 3VA11	3VA9111-0WD10
3P 3VA Short Terminal Shroud	1	160A 3VA11	3VA9111-0WD30
		250A 3VA12	3VA9211-0WD30
4P 3VA Short Terminal Shroud	1	160A 3VA11	3VA9111-0WD40
		250A 3VA12	3VA9211-0WD40
3P 3VA Extended Terminal Shroud	1	160A 3VA11	3VA9111-0WF30
		250A 3VA12	3VA9211-0WF30
4P 3VA Extended Terminal Shroud	1	160A 3VA11	3VA9111-0WF40
		250A 3VA12	3VA9211-0WF40

- If using extended shrouds a cableway is required on Alpha BS III 160 Panel Boards.
- Terminal shrouds are required on the 800A Panel Board to ensure Form 4b Type 6 GM form of separation.

# Technical Data

## Alpha BSIII 160 Panel Boards

### Panel Boards

Description		Dimensions (mm)			Distance from Gland Plate to Incoming Terminals (mm)	
		(H)	(W)	(D)	Without Meter Kit	With Integral Meter Kit (Spreading Room)
<b>250A</b>	6 Way	902	700	198	257	109
	12 Way	1132	700	198	257	109
	18 Way	1361	700	198	257	109
<b>400A</b>	6 Way	1132	700	198	342	204
	12 Way	1361	700	198	342	204
	18 Way	1591	700	198	342	204
<b>800A</b>	4 Way	1361	700	226	278	95
	8 Way	1591	700	226	278	95
	12 Way	1820	700	226	278	95

### Cableways

Description	Dimensions (mm)			Distance from Gland Plate to Incoming Terminals (mm)	
	(H)	(W)	(D)	Without Meter Kit	With Integral Meter Kit (Spreading Room)
Corner Unit	230	249	198	-	-
Size 1	902	249	198	-	-
Size 2	1132	249	198	-	-
Size 3	1361	249	198	-	-
Size 4	1591	249	198	-	-
Size 5		249	198	-	-

### Add-on Units

Description	Dimensions (mm)			Distance from Gland Plate to Incoming Terminals (mm)	
	(H)	(W)	(D)	Without Meter Kit	With Integral Meter Kit (Spreading Room)
2 x 250A 3P Outgoer	380	700	198	-	-
2 x 250A 4P Outgoer	TBC	TBC	TBC	-	-
Control Module	230	700	198	-	-
1P+N Dist. Board	230	700	198	-	-
3P+N Dist. Board	230	700	198	-	-
Spreader Box	230	700	198	-	-

• For full Technical Support Information on Devices, please refer to the Siemens Industry Online Support Tool (SIOS) found here: <https://support.industry.siemens.com/cs/start?lc=en-GB>

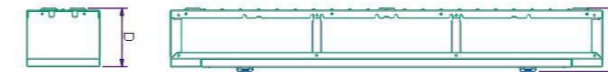
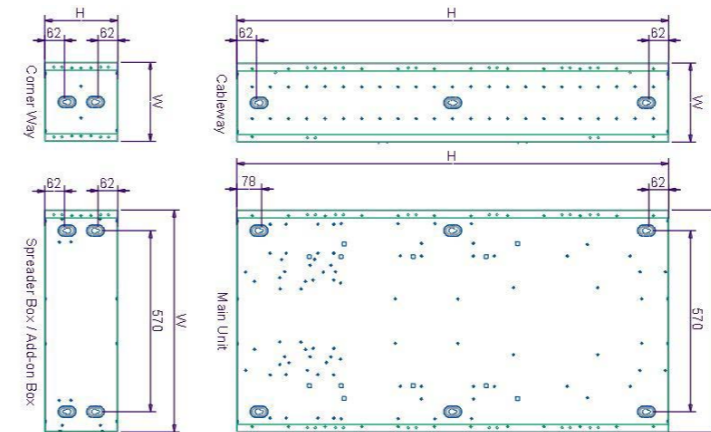

Panel Board Dimensions

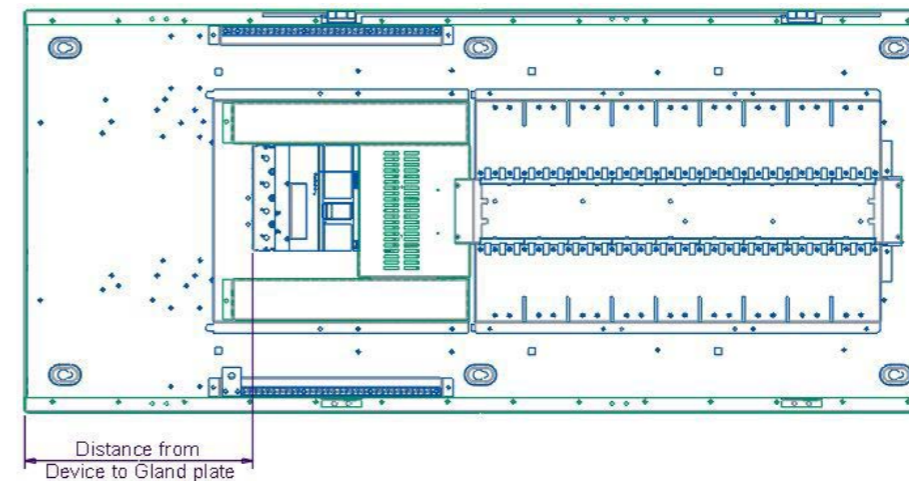

Distance from Gland Plate to Incoming Terminal – Without Meter Kit

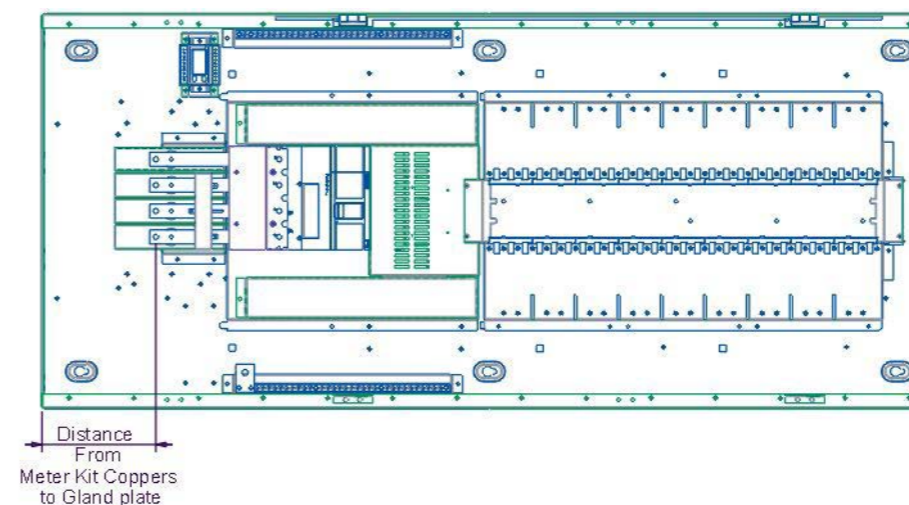

Distance from Gland Plate to Incoming Terminal – With Integral Meter Kit

# Technical Data

## Alpha BSIII 160 Panel Boards

	250A Panel	400A Panel	800A Panel
Compliance with:	IEC / BS EN 61439-2	IEC / BS EN 61439-2	IEC / BS EN 61439-2
Short Circuit Withstand Rating:	25kA for 1s	35kA for 1s	65kA for 1s
Rated Voltage:	230 / 400V 3PH 50Hz	230 / 400V 3PH 50Hz	230 / 400V 3PH 50Hz
Mounting:	Wall or Floor	Wall or Floor	Wall or Floor
Incoming Cable Entry:	Bottom	Bottom	Bottom
Access Panels:	All Fascias	All Fascias	All Fascias
Form of Separation:	3b Type 2	3b Type 2	4b Type 6 GM
Ingress Protection:	IP3X as Standard (Door Closed)	IP3X as Standard (Door Closed)	IP3X as Standard (Door Closed)
Finish:	Powder Coated RAL7035 Light Grey	Powder Coated RAL7035 Light Grey	Powder Coated RAL7035 Light Grey

### Cable Capacity & Terminal Connections - Maximum Stranded C<sub>u</sub> Cable

	Incoming Options				Outgoing Options (Box Terminals)			
	Sw Disc or MCCB	Direct Connect	Neutral	Earth	Up to 160A MCCB	200A & 250A MCCB	Neutral	Earth
250A	25... 185mm <sup>2</sup>	M8	M10	M10	70mm <sup>2</sup>	120mm <sup>2</sup>	35mm <sup>2</sup>	35mm <sup>2</sup>
400A	50... 300mm <sup>2</sup>	M10	M10	M10	70mm <sup>2</sup>	120mm <sup>2</sup>	35mm <sup>2</sup>	35mm <sup>2</sup>
800A	Lug... 40mm	M12	M10	M10	70mm <sup>2</sup>	120mm <sup>2</sup>	35mm <sup>2</sup>	35mm <sup>2</sup>

- For full Technical Support Information on Devices, please refer to the Siemens Industry Online Support Tool (SIOS) found here: <https://support.industry.siemens.com/cs/start?lc=en-GB>



**Alpha BSIII 160 is manufactured in the UK**

**Siemens Electrical Products (EP)**

Sharston Road  
Wythenshawe  
Manchester  
M22 4RA

**UK Sales:**

eMail: [sales.gbi.industry@siemens.com](mailto:sales.gbi.industry@siemens.com)  
[estimating.uk@siemens.com](mailto:estimating.uk@siemens.com)

Tel: 08458 507600

Although every effort has been made to ensure accuracy in the compilation of this publication, specifications and performance data are constantly changing. Latest details can be obtained by contacting us.

© Siemens plc 2022

Alpha BSIII catalogue 03/2022