

## Installation Instructions



⚠ DANGER

**Hazardous voltage. Will cause death or serious injury.**

Turn off and lock out all power supplying this device before removing cover or device and while cover is removed.

Replace the cover before power supplying this device is turned on.



### SAFETY INSTRUCTIONS

Accessory installation should be completed **before** the breaker is mounted and connected. If the breaker is installed, **be sure to turn off power supplying breaker** before installing accessory. It is highly recommended that the breaker be disconnected and removed from the panel or enclosure to install accessories.

**NOTE:** This instruction outlines the recommended installation procedure. Accessory units can be mounted in either left or right poles of the circuit breaker.

### Circuit Breaker Preparation

1. Depress trip button (**See Fig. 1**) to trip circuit breaker prior to removing cover. Before installing accessory unit, the breaker **must** be in tripped position.
2. Remove five load end cover screws (**A, Fig. 1**) and, if breaker is mounted, also remove two mounting screws (**B, Fig. 1**). Remove load end cover only, and remove handle and handle barrier. (**Fig. 1**)
3. **Ref. Fig. 2:** If present, remove the access hole plug (**T**) from the  $\frac{5}{16} \times \frac{5}{32}$  accessory lead access hole (**C**) by pushing the plug into the interior of the circuit breaker. (**NOTE:** The moveable contacts must be pushed downward slightly for removal of the plug from the circuit breaker.) Remove the plug only from the side in which the accessory is to be installed. Break plug in half and reinstall half of the plug.

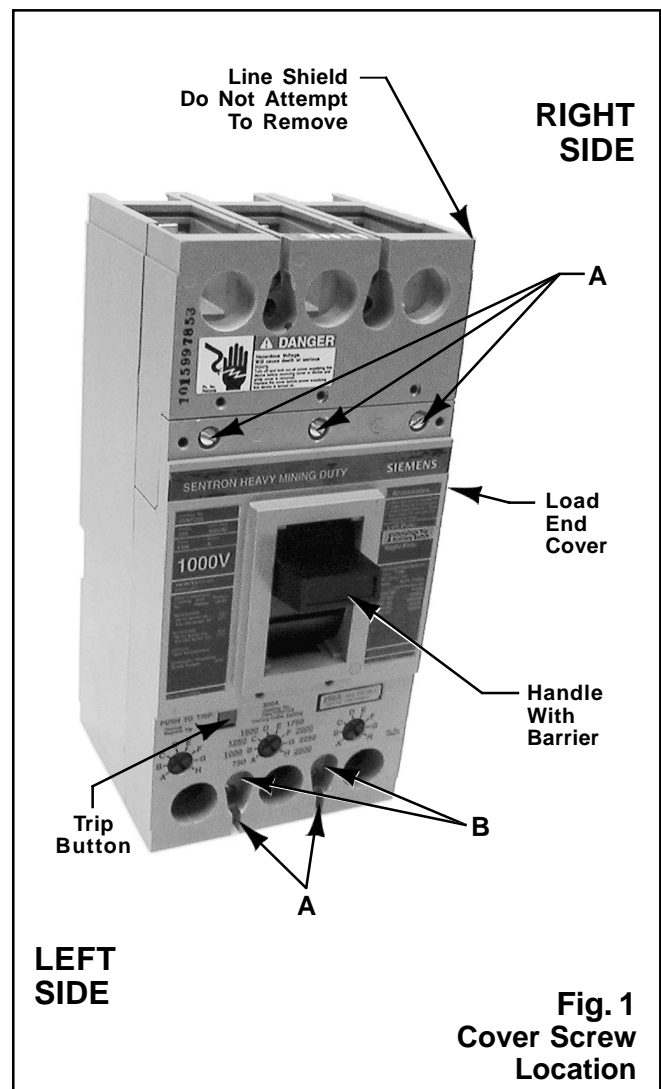

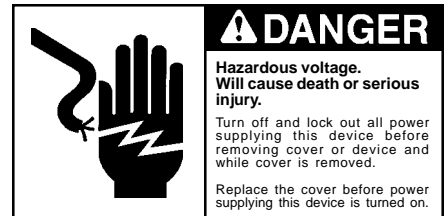

# Installation Instructions

## Accessory Mounting Instructions

4. The accessory comes pre-assembled for right pocket installation. The accessory may be reconfigured to fit left pocket by pulling out the lever as shown in **Fig. 3A** and reinserting the lever into the opposite side of the UVR.
5. **Ref. Fig. 3A:** Insert the lever (**G**) into the hub (**H**) by aligning and seating the notches of the lever (**G**) with the slots in the hub (**H**) of the UVR.
6. The lever will snap into place when pressed by hand fully into the slot on the hub (**H**). You should feel a positive detent action when fully inserted. Ensure the lever is fully engaged into the slots in the hub (**H**) and actuates freely.
7. **Ref. Fig. 2:** Feed accessory leads through the access hole (**C**) to bring the leads out the bottom of circuit breaker. (*NOTE: Leads must be routed in the same order as they exit wire retainer of the accessory case.*) Pull gently and evenly on accessory wire leads (2 to 5 wires) while lowering the accessory into the breaker base and holding the lever (**G**) down to clear the breaker cradle arm (**F**) as shown in **Fig. 2**.

The accessory is located in the circuit breaker by two ribs, (**E, Fig. 3A**), one on each side of the accessory. While sliding the accessory down into the two slots (**D, Fig. 3**) in the breaker base, you must align the transfer link (**L**) to engage opening (**J**) in the trip unit shown in **Fig 2 & 3**. Make sure all slack is removed from the leads inside the breaker. When accessory is correctly installed, tops of the ribs (**E**) on the side of the accessory will be at the same level as the top outside edge of the breaker base.

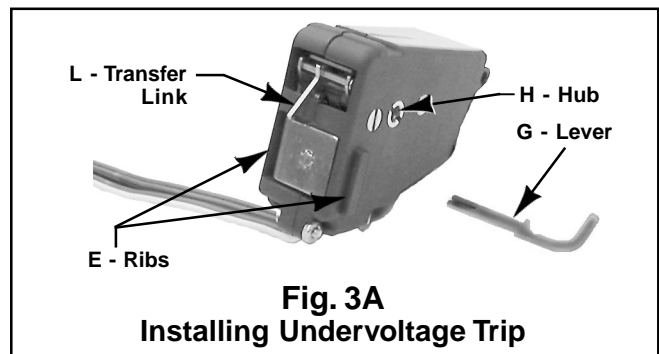
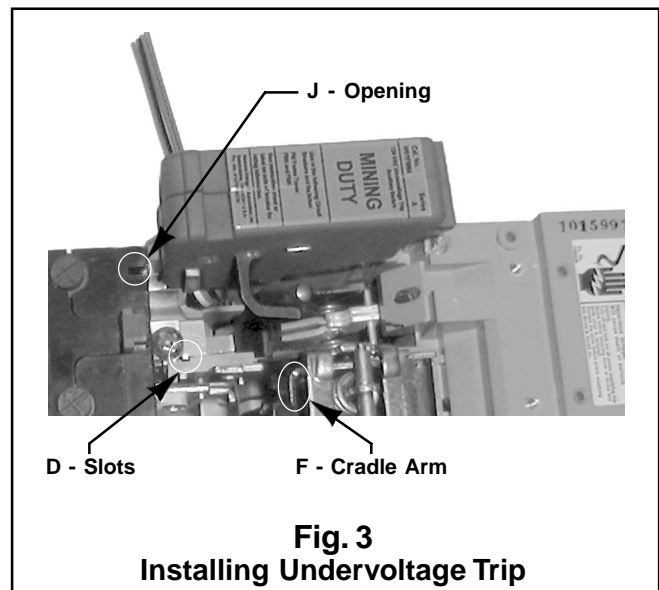
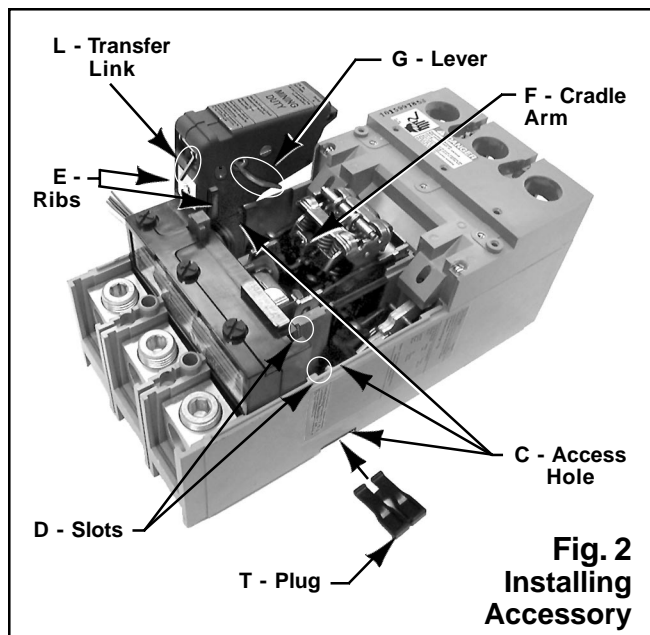



# Installation Instructions

8. Replace handle and handle barrier (orient tabs and handle "ON" marking nearest trip unit), load end cover and cover screws (quantity 5), and two mounting screws if removed (See A & B, Fig. 1).
9. Add two labels provided to circuit breaker. Attach accessory identification label (N, Fig. 4) to appropriate space in label on top of right side of circuit breaker cover. Attach accessory information label (P, Fig. 4) on the side of the circuit breaker as shown.

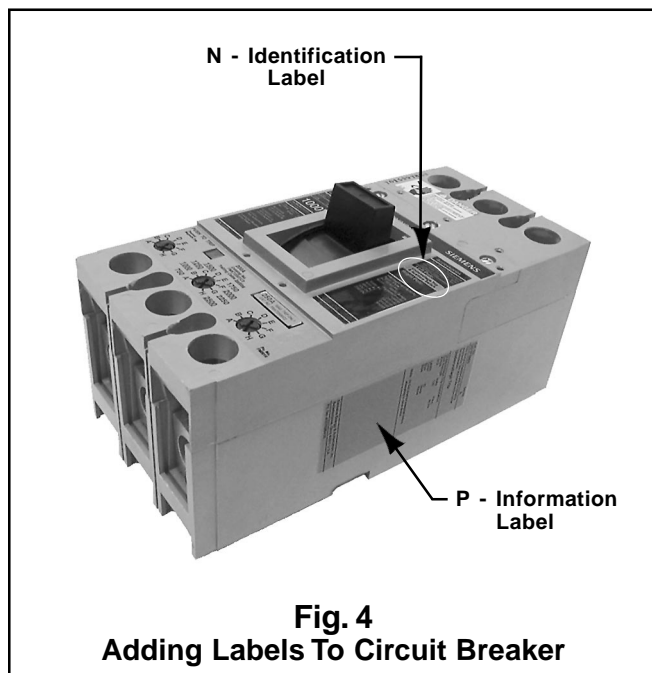

### Auxiliary Switch Mechanical / Electrical Check

1. Use a buzzer or light indicator attached to switch leads A1 and C1. With breaker in "ON" position, indicator light or buzzer should operate.
2. Turn breaker to "OFF" position, indicator light or buzzer should turn off.
3. With leads B1 and C1 attached to indicator, it should operate with breaker in the "OFF" position and not operate with breaker "ON".

**Should the indicator not function properly during check procedure, check for incorrect installation or wiring.**

### UVR & Auxiliary Switch

Cat. No.	Ampere Rating Of Switch for Non Inductive Load		
	A.C. Voltage		D.C. Voltage
	120V	240V	125V
W01FM64	10A	10A	0.1
W10FM64	10A	10A	0.1

### Electrical Check:

#### Undervoltage Trip Accessory

1. With breaker in TRIPPED position, connect test circuit to accessory leads. Energize undervoltage trip device. Reset and turn breaker handle ON. Breaker must reset and turn on.
2. De-energize coil voltage. Circuit breaker must trip.

### Auxiliary Switch Information

All switches have three leads which are identified as follows:

Wire Markings	Wire Color	Switch Terminals or Contacts
C1	White	C - Common Terminal
A1	Black	open when breaker is open, closed when breaker is closed.
B1	Red	closed when breaker is open, open when breaker is closed.

### Electrical Data For Undervoltage Trip

Coil Voltage	Inrush Current At Rated Voltage (Amperes)	Cat. No.
60 Cycles AC		
120	0.012	W01FM64 U01FM60
D.C.		
125	0.012	W10FM64 U10FM64



# Installation Instructions

## Internal Accessory Installation Schematics

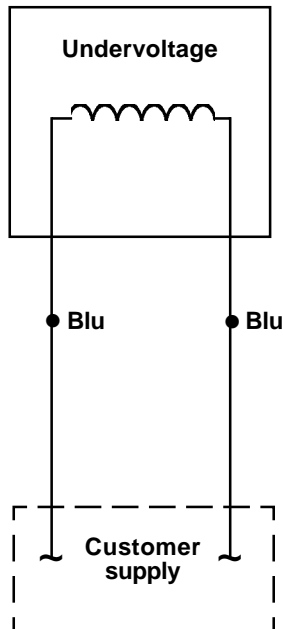

Accessory units employing an auxiliary switch in combination with an undervoltage trip utilize the wire colors and designations for each device as shown below.

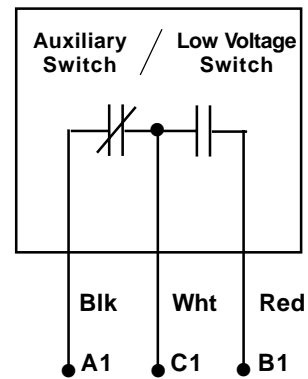

- A1-C1      Closed when circuit breaker is closed.
- B1-C1      Open when circuit breaker is closed.