

SIEMENS



Manual

SIMATIC

S7-1500R/H

CPU 1513R-1 PN (6ES7513-1RL00-0AB0)

Edition

10/2018

support.industry.siemens.com

SIEMENS

SIMATIC

S7-1500R/H
CPU 1513R-1 PN
(6ES7513-1RL00-0AB0)

Manual

Preface

Documentation guide

1

Product overview

2

Connecting

3

Interrupts, diagnostics, error
messages and system
events

4

Technical specifications

5



Dimension drawing

A

Legal information

Warning notice system

This manual contains notices you have to observe in order to ensure your personal safety, as well as to prevent damage to property. The notices referring to your personal safety are highlighted in the manual by a safety alert symbol, notices referring only to property damage have no safety alert symbol. These notices shown below are graded according to the degree of danger.

 DANGER
indicates that death or severe personal injury will result if proper precautions are not taken.
 WARNING
indicates that death or severe personal injury may result if proper precautions are not taken.
 CAUTION
indicates that minor personal injury can result if proper precautions are not taken.
NOTICE
indicates that property damage can result if proper precautions are not taken.

If more than one degree of danger is present, the warning notice representing the highest degree of danger will be used. A notice warning of injury to persons with a safety alert symbol may also include a warning relating to property damage.

Qualified Personnel

The product/system described in this documentation may be operated only by **personnel qualified** for the specific task in accordance with the relevant documentation, in particular its warning notices and safety instructions. Qualified personnel are those who, based on their training and experience, are capable of identifying risks and avoiding potential hazards when working with these products/systems.

Proper use of Siemens products

Note the following:

 WARNING
Siemens products may only be used for the applications described in the catalog and in the relevant technical documentation. If products and components from other manufacturers are used, these must be recommended or approved by Siemens. Proper transport, storage, installation, assembly, commissioning, operation and maintenance are required to ensure that the products operate safely and without any problems. The permissible ambient conditions must be complied with. The information in the relevant documentation must be observed.

Trademarks

All names identified by ® are registered trademarks of Siemens AG. The remaining trademarks in this publication may be trademarks whose use by third parties for their own purposes could violate the rights of the owner.

Disclaimer of Liability

We have reviewed the contents of this publication to ensure consistency with the hardware and software described. Since variance cannot be precluded entirely, we cannot guarantee full consistency. However, the information in this publication is reviewed regularly and any necessary corrections are included in subsequent editions.

Preface

Purpose of the documentation

This manual supplements the system manual of the S7-1500R/H redundant system and the function manuals. This manual contains a description of the module-specific information. The system-related functions are described in the system manual. All system-spanning functions are described in the function manuals.

The information provided in this manual and the system manual enables you to commission the CPU 1513R-1 PN.

Conventions

STEP 7: In this documentation, "STEP 7" is used as a synonym for all versions of the configuration and programming software "STEP 7 (TIA Portal)".

Please also observe notes marked as follows:

Note

A note contains important information on the product described in the documentation, on the handling of the product or on the section of the documentation to which particular attention should be paid.

Recycling and disposal

For environmentally friendly recycling and disposal of your old equipment, contact a certified electronic waste disposal company and dispose of the equipment according to the applicable regulations in your country.

Security information

Siemens provides products and solutions with industrial security functions that support the secure operation of plants, systems, machines and networks.

In order to protect plants, systems, machines and networks against cyber threats, it is necessary to implement – and continuously maintain – a holistic, state-of-the-art industrial security concept. Siemens' products and solutions constitute one element of such a concept.

Customers are responsible for preventing unauthorized access to their plants, systems, machines and networks. Such systems, machines and components should only be connected to an enterprise network or the internet if and to the extent such a connection is necessary and only when appropriate security measures (e.g. firewalls and/or network segmentation) are in place.

For additional information on industrial security measures that may be implemented, please visit (<https://www.siemens.com/industrialsecurity>).

Siemens' products and solutions undergo continuous development to make them more secure. Siemens strongly recommends that product updates are applied as soon as they are available and that the latest product versions are used. Use of product versions that are no longer supported, and failure to apply the latest updates may increase customers' exposure to cyber threats.

To stay informed about product updates, subscribe to the Siemens Industrial Security RSS Feed under (<https://www.siemens.com/industrialsecurity>).

Siemens Industry Online Support

You can find current information on the following topics quickly and easily here:

- **Product support**

All the information and extensive know-how on your product, technical specifications, FAQs, certificates, downloads, and manuals.

- **Application examples**

Tools and examples to solve your automation tasks – as well as function blocks, performance information and videos.

- **Services**

Information about Industry Services, Field Services, Technical Support, spare parts and training offers.

- **Forums**

For answers and solutions concerning automation technology.

- **mySupport**

Your personal working area in Industry Online Support for messages, support queries, and configurable documents.

This information is provided by the Siemens Industry Online Support in the Internet (<https://support.industry.siemens.com>).

Industry Mall

The Industry Mall is the catalog and order system of Siemens AG for automation and drive solutions on the basis of Totally Integrated Automation (TIA) and Totally Integrated Power (TIP).

You can find catalogs for all automation and drive products on the Internet (<https://mall.industry.siemens.com>).

Table of contents

	Preface	3
1	Documentation guide	7
2	Product overview	10
2.1	Configuration and operating principle	10
2.2	Hardware properties	12
2.3	Firmware functions.....	15
2.4	Operator controls and display elements	17
2.4.1	Front view of the module with front panel	17
2.4.2	Front view of the module without front panel	19
2.4.3	Rear view of the module	20
2.5	Mode selector.....	21
3	Connecting	22
3.1	Terminal assignment.....	22
4	Interrupts, diagnostics, error messages and system events	25
4.1	Status and error display of the CPU	25
5	Technical specifications	30
A	Dimension drawing	38
A.1	Dimension drawing	38

The documentation for the redundant S7-1500R/H system is divided into three areas. This division enables you to access the specific content you require.

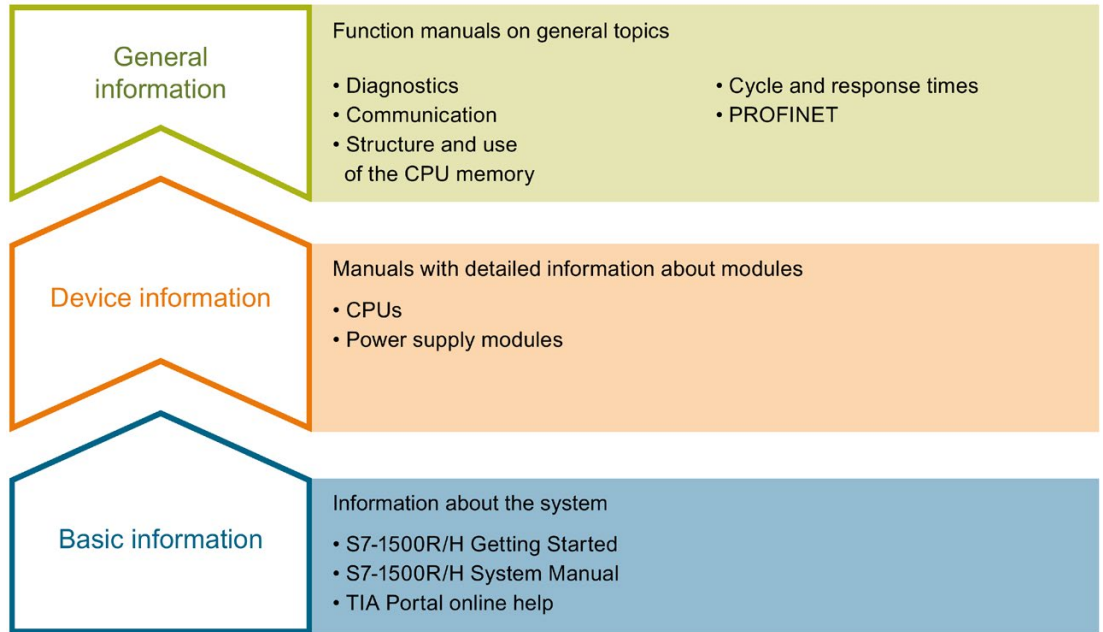

Figure 1-1 S7-1500R/H guide

Basic information

The System Manual and Getting Started describe in detail the configuration, installation, wiring and commissioning of the redundant S7-1500R/H system. The STEP 7 online help supports you in the configuration and programming.

Device information

Product manuals contain a compact description of the module-specific information, such as properties, wiring diagrams, characteristics and technical specifications.

General information

The function manuals contain detailed descriptions on general topics regarding the redundant S7-1500R/H system, e.g. diagnostics, communication.

You can download the documentation free of charge from the Internet (<https://support.industry.siemens.com/cs/ww/en/view/109742691>).

Changes and supplements to the manuals are documented in a Product Information.

You can download the product information free of charge from the Internet (<https://support.industry.siemens.com/cs/ww/en/view/109742691>).

S7-1500/ET 200MP Manual Collection

The S7-1500/ET 200MP Manual Collection contains the complete documentation on the redundant S7-1500R/H system gathered together in one file.

You can find the Manual Collection on the Internet (<https://support.industry.siemens.com/cs/ww/en/view/86140384>).

SIMATIC S7-1500 comparison list for programming languages

The comparison list contains an overview of which instructions and functions you can use for which controller families.

You can find the comparison list on the Internet (<https://support.industry.siemens.com/cs/ww/en/view/86630375>).

"mySupport"

With "mySupport", your personal workspace, you make the best out of your Industry Online Support.

In "mySupport", you can save filters, favorites and tags, request CAx data and compile your personal library in the Documentation area. In addition, your data is already filled out in support requests and you can get an overview of your current requests at any time.

You must register once to use the full functionality of "mySupport".

You can find "mySupport" on the Internet (<https://support.industry.siemens.com/My/ww/en/>).

"mySupport" - Documentation

In the Documentation area in "mySupport" you can combine entire manuals or only parts of these to your own manual.

You can export the manual as PDF file or in a format that can be edited later.

You can find "mySupport" - Documentation on the Internet (<https://support.industry.siemens.com/My/ww/en/documentation>).

"mySupport" - CAx data

In the CAx data area in "mySupport", you can access the current product data for your CAx or CAe system.

You configure your own download package with a few clicks.

In doing so you can select:

- Product images, 2D dimension drawings, 3D models, internal circuit diagrams, EPLAN macro files
- Manuals, characteristics, operating manuals, certificates
- Product master data

You can find "mySupport" - CAx data on the Internet (<https://support.industry.siemens.com/my/ww/en/CAxOnline>).

Application examples

The application examples support you with various tools and examples for solving your automation tasks. Solutions are shown in interplay with multiple components in the system - separated from the focus on individual products.

You will find the application examples on the Internet (<https://support.industry.siemens.com/sc/ww/en/sc/2054>).

PRONETA

With SIEMENS PRONETA (PROFINET network analysis), you analyze the PROFINET network during commissioning. PRONETA features two core functions:

- The topology overview independently scans PROFINET network and all connected components.
- The IO check is a fast test of the wiring and the module configuration of a system.

You can find SIEMENS PRONETA on the Internet (<https://support.industry.siemens.com/cs/ww/en/view/67460624>).

SINETPLAN

SINETPLAN, the Siemens Network Planner, supports you in planning automation systems and networks based on PROFINET. The tool facilitates professional and predictive dimensioning of your PROFINET installation as early as in the planning stage. In addition, SINETPLAN supports you during network optimization and helps you to exploit network resources optimally and to plan reserves. This helps to prevent problems in commissioning or failures during productive operation even in advance of a planned operation. This increases the availability of the production plant and helps improve operational safety.

The advantages at a glance

- Network optimization thanks to port-specific calculation of the network load
- Increased production availability thanks to online scan and verification of existing systems
- Transparency before commissioning through importing and simulation of existing STEP 7 projects
- Efficiency through securing existing investments in the long term and optimal exploitation of resources

You can find SINETPLAN on the Internet (<https://www.siemens.com/sinetplan>).

Product overview

2.1 Configuration and operating principle

Structure

The S7-1500R redundant system consists of the following components:

- Two CPUs of the type CPU 1513R-1 PN
- Two SIMATIC memory cards
- PROFINET cable (PROFINET ring)
- IO devices
- Load power supply (optional)
- System power supply (optional)

You mount the CPUs on a common mounting rail or spatially separated on two separate mounting rails. You connect the two CPUs and the IO devices in a PROFINET ring via the PROFINET cable.

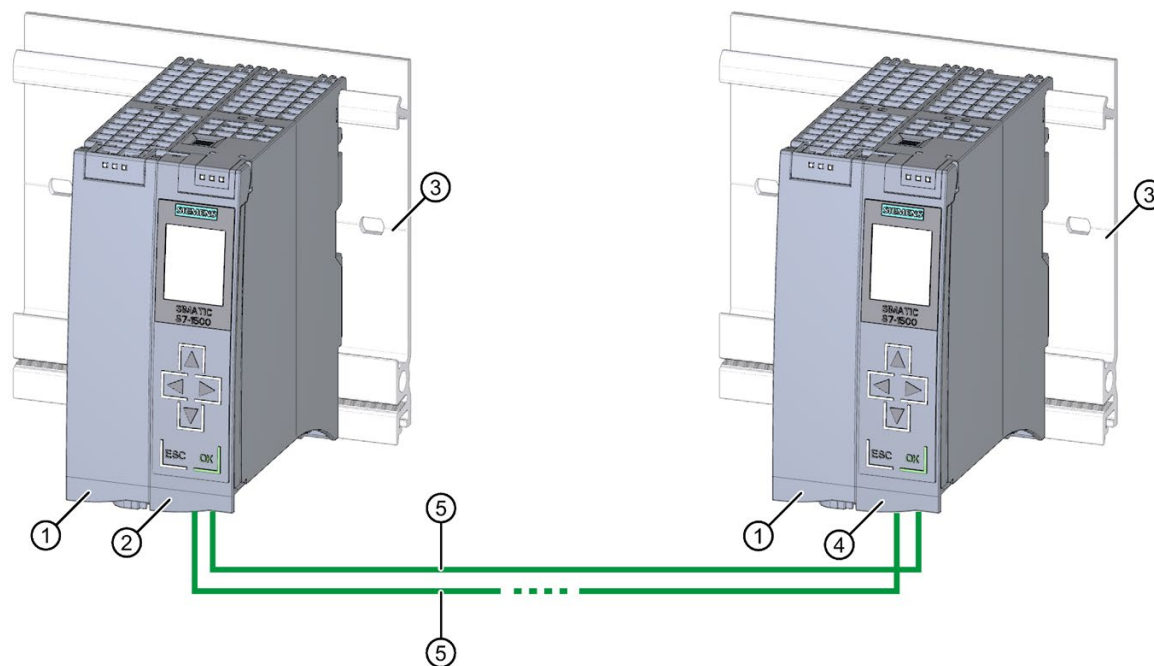

- ① Optional load current supply
- ② First CPU
- ③ Mounting rail with integrated DIN rail profile
- ④ Second CPU
- ⑤ PROFINET cable (PROFINET ring)

Figure 2-1 Configuration example for S7-1500R

Principle of operation

One of the two CPUs in the redundant system takes on the role of CPU for process control (primary CPU). The other CPU takes on the role of the following CPU (backup CPU). The assigned role of the CPUs can change during operation. Synchronization of all relevant data between primary CPU and backup CPU ensures fast switching between CPUs in the event of a primary CPU failure. If the primary CPU fails, the backup CPU retains control of the process as the new primary CPU at the point of interruption.

The redundancy connections are the PROFINET ring with MRP. The CPUs are synchronized via a PROFINET ring.

Reference

You can find a detailed description of the operation and design of the CPUs in the system manual Redundant System S7-1500R/H

(<https://support.industry.siemens.com/cs/ww/en/view/109754833>).

2.2 Hardware properties

Article number

6ES7513-1RL00-0AB0

View of the module

The figure below shows the CPU 1513R-1 PN.



Figure 2-2 CPU 1513R-1 PN

Note

Protective film

Note that there is a removable protective foil on the display when the CPUs are delivered.

Properties

CPU 1513R-1 PN has the following technical properties:

Property	Description	Additional information
CPU display	<p>All CPUs of the redundant system S7 1500R/H have a display with plain text information. The display provides you with diagnostic messages as well as information about the article number, the firmware version and the serial number of the CPU.</p> <p>You can also view and assign the IP addresses, the PROFINET device name and the redundancy ID of the CPU. The system IP address can't be viewed via STEP 7 but not in the display.</p> <p>In addition to the functions listed here, a large number of other functions are available on the display. These additional functions are described in the SIMATIC S7 1500 Display Simulator.</p>	<ul style="list-style-type: none"> • Redundant System S7-1500R/H (https://support.industry.siemens.com/cs/ww/en/view/109754833) System Manual • SIMATIC S7-1500 Display Simulator (http://www.automation.siemens.com/salesmaterial-as/interactive-manuals/getting-started_simatic-s7-1500/disp_tool/start_en.html)
Supply voltage	<p>The 24 V DC supply voltage is fed via a 4-pin plug located on the front of the CPU.</p>	<ul style="list-style-type: none"> • Section Connecting (Page 22) • Redundant System S7-1500R/H (https://support.industry.siemens.com/cs/ww/en/view/109754833) System Manual

Property	Description	Additional information
PROFINET IO		
PROFINET IO interface (X1 P1 R and X1 P2 R)	<p>The CPU has an X1 interface with two ports (X1 P1 R and X1 P2 R).</p> <ul style="list-style-type: none"> The PROFINET IO interface X1 (default P1 R) is used to set up the PROFINET ring with the two CPUs and the IO devices. The PROFINET IO interface X1 (default P2 R) is used to make the connection between the two R-CPU's in the PROFINET ring. <p>In the PROFINET ring, the synchronization frames between the CPUs are transmitted via the following connections:</p> <ul style="list-style-type: none"> The direct connection (X1 P2 R) The indirect connection (X1 P1 R) via the IO devices <ul style="list-style-type: none"> The interface supports PROFINET IO RT (Real-Time) and PROFINET basic functionality. <p>Basic PROFINET functionality comprises:</p> <ul style="list-style-type: none"> HMI communication Communication with the configuration system Communication with a higher-level network (backbone, router, Internet) Communication with another machine or automation cell 	<ul style="list-style-type: none"> Redundant System S7-1500R/H (https://support.industry.siemens.com/cs/ww/en/view/109754833) System Manual Function manual PROFINET (https://support.industry.siemens.com/cs/ww/en/view/49948856)
Operation of the CPUs as IO controllers	<p>IO controller: As IO controllers the CPUs address the following configured IO devices:</p> <ul style="list-style-type: none"> IO devices within the PROFINET ring IO devices that are decoupled from the PROFINET ring via a switch 	

Note

PROFINET basic functionality

CPU 1513R-1 PN has a PROFINET IO interface with two ports (X1 P1 R and X1 P2 R).

To connect an HMI device or PG/PC to the CPUs via Industrial Ethernet, build the PROFINET ring via the PROFINET X1 interface. Install a switch in the PROFINET ring. Make an Industrial Ethernet connection via the switch.

Accessories

You can find information on the topic of "Accessories/spare parts" in the system manual for Redundant System S7-1500R/H (<https://support.industry.siemens.com/cs/ww/en/view/109754833>).

2.3 Firmware functions

Functions

CPU 1513R-1 PN supports the following firmware functions:

Function	Description	Additional information
CPU redundancy	There are two duplicate CPUs that synchronize their data via redundancy connections within a PROFINET ring. If one of the CPUs fails, the other CPU retains control of the process.	Redundant System S7-1500R/H (https://support.industry.siemens.com/cs/ww/en/view/109754833) System Manual
Integrated system diagnostics	The system automatically generates the messages for the system diagnostics and outputs these messages via a programming device/PC, HMI device or the integrated display. System diagnostics information is also available when the CPUs are in operating state STOP.	Function manual Diagnostics (http://support.automation.siemens.com/WW/view/en/59192926)
Integrated trace functionality	Trace functionality supports you in troubleshooting and/or optimizing the user program. You record device tags and evaluate the recordings with the trace and logic analyzer function. Tags are, for example, drive parameters or system and user tags of a CPU. Trace and logic analyzer functions are suitable for monitoring highly dynamic processes. Note: Note that the S7-1500R/H redundant system supports recording of measurements. However, saving the measurements to the SIMATIC memory card is not supported.	Function manual Using the trace and logic analyzer function (http://support.automation.siemens.com/WW/view/en/64897128)
PROFINET IO		
System redundancy S2	All IO devices are connected redundantly in the redundant S7 1500R/H system. All IO devices assigned to the system must therefore support system redundancy S2. If the role of the CPUs changes, the new primary CPU takes over the PROFINET IO communication.	<ul style="list-style-type: none"> Redundant System S7-1500R/H (https://support.industry.siemens.com/cs/ww/en/view/109754833) System Manual Function manual PROFINET (http://support.automation.siemens.com/WW/view/en/49948856)
RT (real time)	RT prioritizes PROFINET IO frames over standard frames. This ensures the required determinism in the automation technology. In this process the data is transferred via prioritized Ethernet frames.	Function manual PROFINET (http://support.automation.siemens.com/WW/view/en/49948856)
MRP (Media Redundancy Protocol)	The Media Redundancy Protocol enables the configuration of redundant networks. Redundant transmission links (ring topology) ensure that an alternative communication path is made available if a transmission link fails. Within the PROFINET ring, the R-CPU's assume the role of the MRP Manager following appropriate project configuration and all other devices in the ring assume the role of the MRP clients.	

Function	Description	Additional information
PROFenergy	PROFenergy is a PROFINET-based data interface for switching off consumers centrally and with full coordination during pause times regardless of the manufacturer or device type. Through this, the process should only be provided with the energy that is absolutely required. Most of the energy is saved by the process. The PROFINET device itself only contributes a few watts to the savings potential.	
Integrated technology		
Integrated closed-loop control functionality	The CPUs support PID basic functions. No controller support: <ul style="list-style-type: none"> • PID_Compact • PID_3Step • PID_Temp 	Function manual PID Control (https://support.industry.siemens.com/cs/ww/en/view/108210036)
Security Integrated		
Know-how protection	The know-how protection protects user blocks against unauthorized access and modifications.	Redundant System S7-1500R/H (https://support.industry.siemens.com/cs/ww/en/view/109754833) System Manual
Access protection	You can use authorization levels to assign separate rights to different user groups.	
Integrity protection	The CPUs dispose of integrity protection by default. Integrity protection identifies possible manipulations of engineering data on the SIMATIC memory card or during data transfer between STEP 7 and the CPUs. Integrity protection also checks the communication from a SIMATIC HMI system to the CPUs for possible manipulations of engineering data. If integrity protection identifies the manipulation of engineering data, the user receives a corresponding message.	
Password provider	As an alternative to manual password entry, you can link a password provider to STEP 7. A password provider offers the following advantages: <ul style="list-style-type: none"> • Convenient handling of passwords. STEP 7 automatically imports the password for the blocks. This saves you time. • Optimum block protection because the users do not know the password itself. 	

2.4 Operator controls and display elements

2.4.1 Front view of the module with front panel

The figure below shows the front view of the CPU 1513R-1 PN.

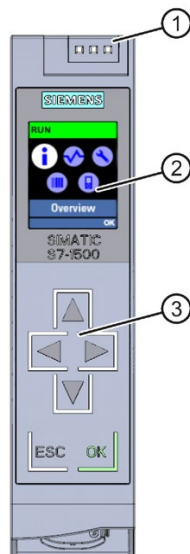

- ① LEDs for the current operating state and diagnostic status of the CPU
- ② Display
- ③ Control keys

Figure 2-3 View of the CPU 1513R-1 PN (with front panel) - front

Note

Temperature range for display

To increase its service life, the display switches off at a temperature below the permitted operating temperature of the device. When the display cools down, it automatically switches itself on again. When the display is switched off, the LEDs continue to show the status of the CPUs.

You can find additional information on the temperatures at which the display switches itself on and off in the Technical specifications (Page 30).

Pulling and plugging the front panel with display

You can pull and plug the front panel with display during operation.

! WARNING
Personal injury and damage to property may occur
If you remove or attach the front panel of a redundant system S7-1500R/H during operation, personal injury or damage to property can occur in hazardous area zone 2.
Before you remove or fit the front panel, always switch off the power supply to the S7-1500R/H redundant system in hazardous area zone 2.

Locking the front panel

You can lock the front panel to protect the SIMATIC memory card and the mode selector of the CPU against unauthorized access.

You can attach a security seal or a padlock with a hoop diameter of 3 mm to the front panel.

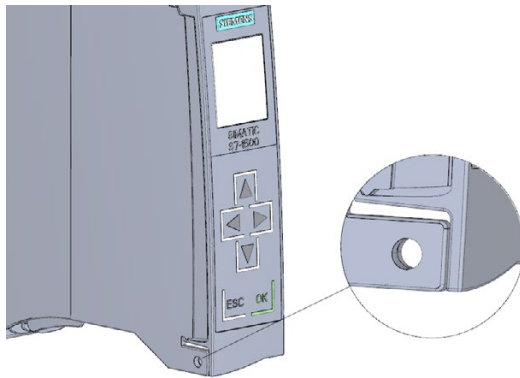

Figure 2-4 Locking latch on the CPU

In addition to the mechanical lock, you can also block access to a password-protected CPU on the display (local lock) and assign a password for the display. You can find additional information on the display, the configurable protection levels and the local lock in the system manual for Redundant System S7-1500R/H (<https://support.industry.siemens.com/cs/ww/en/view/109754833>).

Reference

You can find detailed information on the individual display options, a training course and a simulation of the available menu commands in the SIMATIC S7-1500 Display Simulator (http://www.automation.siemens.com/salesmaterial-as/interactive-manuals/getting-started_simatic-s7-1500/disp_tool/start_en.html).

2.4.2 Front view of the module without front panel

The figure below shows the operator controls and connection elements of the CPU 1513R-1 PN.

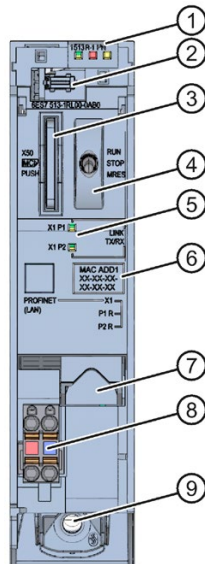

- ① LEDs for the current operating state and diagnostic status of the CPUs
- ② Display connector
- ③ Slot for the SIMATIC memory card
- ④ Mode selector
- ⑤ LEDs for the 2 ports of the PROFINET interface X1
- ⑥ MAC address of the X1 interface
- ⑦ PROFINET IO interface X1 with 2 ports
- ⑧ Connector for power supply
- ⑨ Fastening screw

Figure 2-5 View of the CPU 1513R-1 PN (without front panel) - front

2.4.3 Rear view of the module

The figure below shows the connection elements on the rear of the CPU 1513R-1 PN.

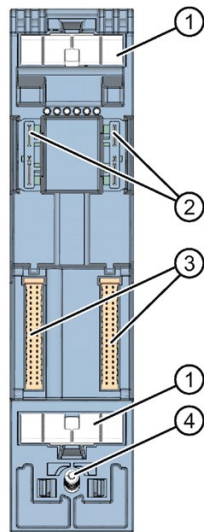

- ① Shield contact surface
- ② Plug-in connection for power supply
- ③ Plug-in connection for backplane bus
- ④ Fastening screw

Figure 2-6 View of the CPU 1513R-1 PN - rear

2.5 Mode selector

You use the mode selector to:

- Request a change to a specific operating state
- Disable or enable the change of a specific operating state

(if, for example, the mode selector is set to STOP, you cannot switch the CPU to RUN via a communication task or the display)

The following table shows the position of the switch and the corresponding meaning.

Table 2- 1 Mode switch settings

Position	Meaning	Explanation
RUN	RUN operating state	The CPU has permission to go to RUN.
STOP	STOP operating state	The CPU does not have permission to go to RUN.
MRES	Memory reset	Position for CPU memory reset.

Reference

You can find a brief overview of the various operating states and system states in the section Status and error display of the CPU (Page 25).

You can find a detailed description of the operating states and system states in the system manual for S7-1500R/H Redundant System (<https://support.industry.siemens.com/cs/ww/en/view/109754833>).

Connecting

3.1 Terminal assignment

This section provides information on the terminal assignment of the individual interfaces and the block diagram of the CPU 1513R-1 PN.

24 V DC supply voltage (X80)

The connector for the power supply is plugged in when the CPU ships from the factory.

The following table shows the terminal assignment for a 24 V DC power supply.

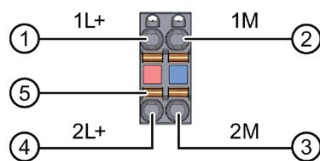

- ① +24 V DC of the supply voltage
- ② Ground of the supply voltage
- ③ Ground of the supply voltage for loop-through (maximum of 10 A permitted)
- ④ +24 V DC of the supply voltage for loop-through (maximum of 10 A permitted)
- ⑤ Spring opener (one spring opener per terminal)

Bridged internally:

- ① and ④
- ② and ③

Figure 3-1 Supply voltage connection

You can find information on the various supply options in the system manual for Redundant System S7-1500R/H (<https://support.industry.siemens.com/cs/ww/en/view/109754833>).

PROFINET interface X1 with 2-port switch (X1 P1 R and X1 P2 R)

The assignment corresponds to the Ethernet standard for a RJ45 connector.

- When autonegotiation is deactivated, the RJ45 socket is allocated as a switch (MDI-X).
- When autonegotiation is activated, autocrossing is in effect and the RJ45 socket is allocated either as data terminal equipment (MDI) or a switch (MDI-X).

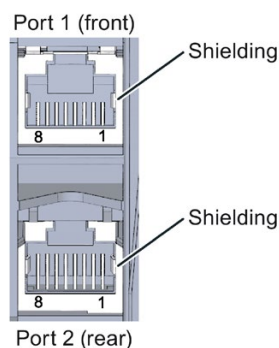

Figure 3-2 Interface assignments

Reference

You can find additional information on the topic of "Connecting the CPU" and on the topic "Accessories/spare parts" in the system manual for Redundant System S7-1500R/H (<https://support.industry.siemens.com/cs/ww/en/view/109754833>).

Assignment of the MAC addresses

CPU 1513R-1 PN has a PROFINET interface with two ports for each CPU. The PROFINET interface itself has a MAC address, and each of the two PROFINET ports has its own MAC address. There are a total of six MAC addresses for the two CPUs of the CPU 1513R-1 PN.

The MAC addresses of the PROFINET ports are needed for the LLDP protocol, for example for the neighborhood discovery function.

The number range of the MAC addresses is sequential. The first and last MAC addresses are printed on the rating plate on the right side of each CPU 1513R-1 PN.

The table below shows how the MAC addresses are assigned.

Table 3- 1 Assignment of MAC addresses using the example of a single CPU

	Assignment	Labeling
MAC address 1	PROFINET interface X1 (visible in STEP 7 for accessible devices)	<ul style="list-style-type: none"> • Front printed • Right-side printed (start of number range)
MAC address 2	Port X1 P1 R (required for LLDP, for example)	---
MAC address 3	Port X1 P2 R (required for LLDP, for example)	<ul style="list-style-type: none"> • Right-side printed (end of number range)

Block diagram

The following figure shows the block diagram of the CPU 1513R-1 PN.

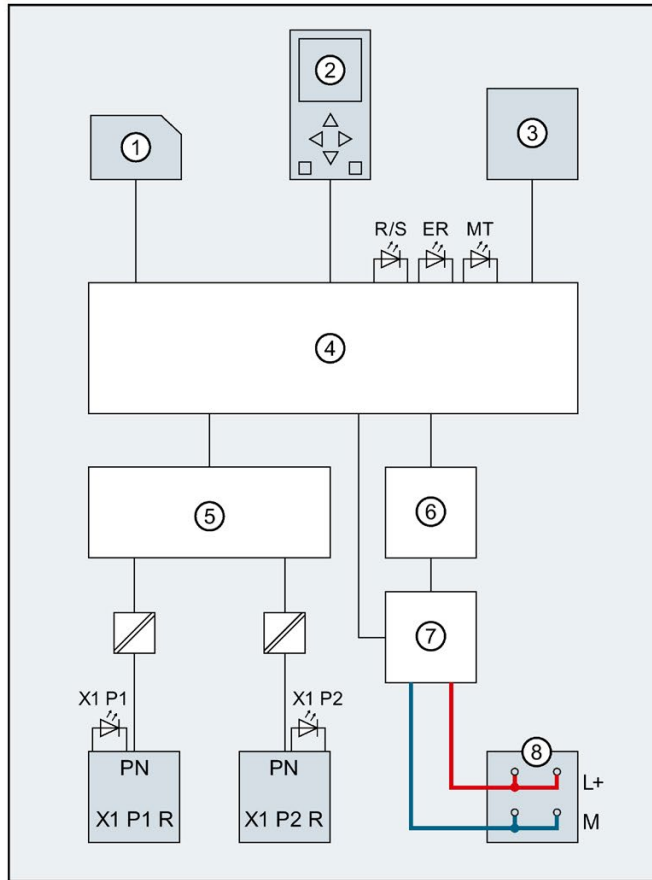

- | | | | |
|---|--|-----------------|------------------------------|
| ① | SIMATIC memory card (X50) | PN X1 P1 R | PROFINET interface X1 port 1 |
| ② | Display | PN X1 P2 R | PROFINET interface X1 port 2 |
| ③ | Mode selector RUN/STOP/MRES | L+ | 24 V DC supply voltage |
| ④ | Electronics | M | Ground |
| ⑤ | PROFINET 2-port switch | R/S | RUN/STOP LED (yellow/green) |
| ⑥ | Backplane bus connection
(connection to backplane bus not configurable) | ER | ERROR LED (red) |
| ⑦ | Internal supply voltage | MT | MAINT LED (yellow) |
| ⑧ | Supply of the 24 V DC supply voltage (X80) | X1 P1,
X1 P2 | LED Link TX/RX |

Figure 3-3 Block diagram of the CPU 1513R-1 PN

Interrupts, diagnostics, error messages and system events

4

4.1 Status and error display of the CPU

The LED displays of the CPUs are described below.

You can find more detailed information on "Interrupts" in the STEP 7 online help.

You can find additional information on the topic of "Diagnostics" and "System events" in the Diagnostics (<http://support.automation.siemens.com/WW/view/en/59192926>) function manual and in the system manual Redundant System S7-1500R/H (<https://support.industry.siemens.com/cs/ww/en/view/109754833>).

You can find additional information on the topic of "Operating states and system states" as well as various failure scenarios in the system manual for S7-1500R/H Redundant System (<https://support.industry.siemens.com/cs/ww/en/view/109754833>).

LED display

The figure below shows the LED displays of the CPU 1513R-1 PN.

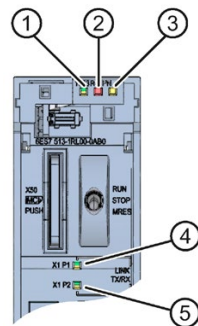

- ① RUN/STOP LED (yellow/green LED)
- ② ERROR LED (red LED)
- ③ MAINT LED (yellow LED)
- ④ LINK RX/TX LED for port X1 P1 (yellow/green LED)
- ⑤ LINK RX/TX LED for port X1 P2 (yellow/green LED)

Figure 4-1 LED display of the CPU 1513R-1 PN (without front panel)

4.1 Status and error display of the CPU

LED displays depending on operating states and system states

CPU 1513R-1 PN has the following LEDs for displaying the current operating state and diagnostics status.

- RUN/STOP LED
- ERROR LED
- MAINT LED

The LEDs indicate the operating state of the respective CPU within the redundant system. Operating states describe the behavior of a single CPU at a specific time. The combination of the operating states of the CPUs forms the system state.

The following figure shows the possible operating states of the CPUs and the resulting system states.

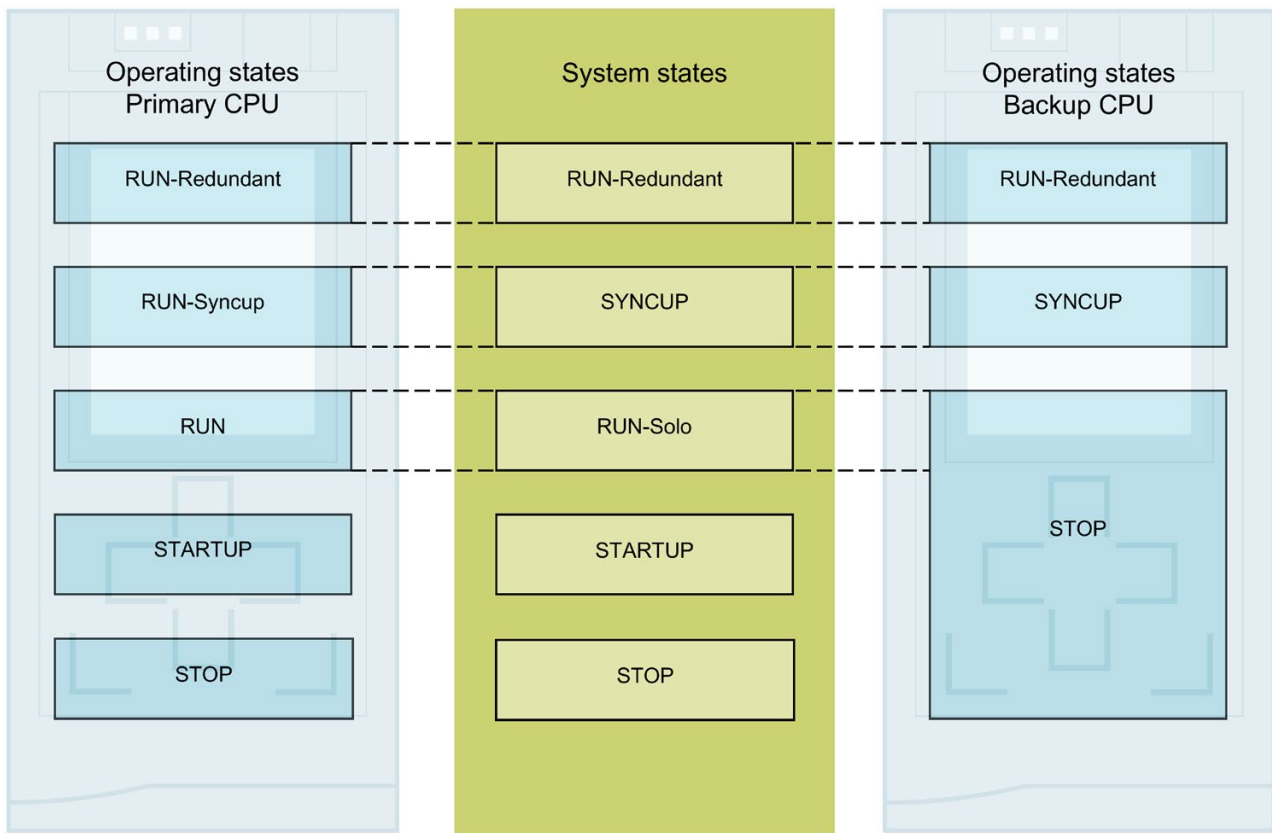

Figure 4-2 Operating states and system states

Meaning of the RUN/STOP, ERROR and MAINT LEDs

CPU 1513R-1 PN has three LEDs for displaying the current operating state and diagnostics status.

Note

LED patterns of the redundant system S7 1500R

Note that it is not always possible to:

- Determine the state of the CPU from the signal pattern
- Determine the state of the other CPU from the signal pattern

The "Meaning" column only shows a possible typical cause.







































To investigate the cause of the signal pattern, use the diagnostic buffer and its display via:

- STEP 7
 - HMI devices
 - Displays of the CPUs
-

4.1 Status and error display of the CPU

The following table shows the meaning of the various color combinations for the RUN/STOP, ERROR and MAINT LEDs.

Table 4- 1 Meaning of the LEDs

RUN/STOP LED	ERROR LED	MAINT LED	Meaning
 LED off	 LED off	 LED off	Missing or insufficient supply voltage on the CPU.
 LED flashes yellow/green	 LED flashes red	 LED flashes yellow	Startup (CPU booting)
			Test of LEDs during startup, inserting a module.
			LED flashing test
 LED lit yellow	 LED off	 LED lit yellow	CPU is in operating state STOP.
			Completion of system initialization
 LED flashes yellow	 LED off	 LED lit yellow	CPU executes internal activities in an operating state ≠ RUN-Redundant.
 LED lit yellow	 LED flashes red	 LED flashes yellow	CPU defective
 LED lit yellow	 LED off	 LED flashes yellow	Firmware update successfully completed.
 LED flashes yellow/green	 LED off	 LED lit yellow	The primary CPU is in operating state STARTUP.
 LED flashes yellow/green	 LED flashes red	 LED lit yellow	The backup CPU is in operating state SYNCUP. The backup CPU has not yet been restarted for SYNCUP during this phase.
 LED flashes yellow	 LED off	 LED off	The CPU performs a warm restart.
 LED lit green	 LED off	 LED lit yellow	Maintenance demanded for the plant. You need to check/replace the affected hardware within a short period of time.
			The primary CPU is in operating state RUN-Syncup.
			Active Force job
			PROFInergy pause
 LED lit green	 LED off	 LED off	The primary CPU is in operating state RUN.
			The CPU is in operating state RUN-Redundant. There are no events, requirements, errors, etc.
 LED lit green	 LED flashes red	 LED off	A diagnostic event is pending in operating state RUN-Redundant.
 LED lit green	 LED flashes red	 LED lit yellow	A diagnostic event (e.g. failure of an IO device within the PROFINET ring or no access to SIMATIC memory card possible ¹⁾) and maintenance is demanded (e.g. interruption of the PROFINET ring).

¹⁾ If access to the SIMATIC memory card is not possible in RUN-Redundant (wrong card, card full/write protected), the system switches to RUN-Solo. The ERROR LED flashes three times. The MAINT LED lights up until the RUN-Redundant system status is reached again.

Note

MAINT LED of the two CPUs

The MAINT LEDs of both CPUs only go out when the following conditions are fulfilled:

- The CPUs are in the RUN-Redundant system state.
- No maintenance is demanded.

Note

ERROR LED of the backup CPU

In non-redundant operation, the backup CPU does not establish a connection to the IO devices. Therefore, in addition to the LED patterns shown in the "Meaning of the LEDs" table, note that the ERROR LED of the backup CPU always flashes red in this state.

Note





LED displays in redundant operating state

In the RUN-Redundant system state, the LED displays on both CPUs are identical.

Meaning of LINK RX/TX LED

Each port has a LINK RX/TX LED. The table below shows the various LED patterns of the ports of the CPU 1513R-1 PN.

Table 4- 2 Meaning of LINK RX/TX LED

LINK TX/RX LED	Meaning
 off	There is no Ethernet connection between the PROFINET interface of the PROFINET device and the communication partner. No data is currently being sent/received via the PROFINET interface. There is no LINK connection. The redundancy connections were interrupted.
 Flashes green	The CPU performs an LED flash test.
 Illuminated green	There is an Ethernet connection between the PROFINET interface of your PROFINET device and a communication partner. The redundancy connections are OK.
 LED flashes yellow/green	Data is currently being received/sent by a communication partner via the PROFINET interface of the PROFINET device.

Technical specifications

General technical specifications

Article number	6ES7513-1RL00-0AB0
General information	
Product type designation	CPU 1513R-1 PN
HW functional status	FS01
Firmware version	V2.6
Engineering with	
<ul style="list-style-type: none"> STEP 7 TIA Portal configurable/integrated as of version 	STEP 7 V15.1 or higher
Display	
Screen diagonal [cm]	3.45 cm
Control elements	
Number of keys	6
Mode selector switch	1
Supply voltage	
Type of supply voltage	24 V DC
permissible range, lower limit (DC)	19.2 V
permissible range, upper limit (DC)	28.8 V
Reverse polarity protection	Yes
Mains buffering	
<ul style="list-style-type: none"> Mains/voltage failure stored energy time 	5 ms
Input current	
Current consumption (rated value)	0.7 A
Inrush current, max.	1.9 A; Rated value
I^2t	0.02 A ² ·s
Power loss	
Power loss, typ.	5.7 W
Memory	
Number of slots for SIMATIC memory card	1
SIMATIC memory card required	Yes
Work memory	
<ul style="list-style-type: none"> integrated (for program) 	300 kbyte
<ul style="list-style-type: none"> integrated (for data) 	1.5 Mbyte
Load memory	
<ul style="list-style-type: none"> Plug-in (SIMATIC Memory Card), max. 	32 Gbyte

Article number	6ES7513-1RL00-0AB0
Backup	
<ul style="list-style-type: none"> • maintenance-free 	Yes
CPU processing times	
for bit operations, typ.	80 ns
for word operations, typ.	96 ns
for fixed point arithmetic, typ.	128 ns
for floating point arithmetic, typ.	512 ns
CPU-blocks	
Number of elements (total)	2 000; Blocks (OB, FB, FC, DB) and UDTs
DB	
<ul style="list-style-type: none"> • Number range • Size, max. 	Number range: 1 to 59 999 1.5 Mbyte; For non-optimized block accesses, the max. size of the DB is 64 KB
FB	
<ul style="list-style-type: none"> • Number range • Size, max. 	0 ... 65 535 300 kbyte
FC	
<ul style="list-style-type: none"> • Number range • Size, max. 	0 ... 65 535 300 kbyte
OB	
<ul style="list-style-type: none"> • Size, max. • Number of free cycle OBs • Number of time alarm OBs • Number of delay alarm OBs • Number of cyclic interrupt OBs • Number of process alarm OBs • Number of startup OBs • Number of asynchronous error OBs • Number of synchronous error OBs • Number of diagnostic alarm OBs 	300 kbyte 100 20 20 20 50 100 4 2 1
Nesting depth	
<ul style="list-style-type: none"> • per priority class 	24
Counters, timers and their retentivity	
S7 counter	
<ul style="list-style-type: none"> • Number 	2 048
Retentivity	
– adjustable	Yes

Article number	6ES7513-1RL00-0AB0
IEC counter	
• Number	Any (only limited by the main memory)
Retentivity	
– adjustable	Yes
S7 times	
• Number	2 048
Retentivity	
– adjustable	Yes
IEC timer	
• Number	Any (only limited by the main memory)
Retentivity	
– adjustable	Yes
Data areas and their retentivity	
Retentive data area (incl. timers, counters, flags), max.	128 kbyte
Flag	
• Number, max.	16 kbyte
• Number of clock memories	8
Data blocks	
• Retentivity adjustable	Yes
• Retentivity preset	No
Local data	
• per priority class, max.	64 kbyte; max. 16 KB per block
Address area	
Number of IO modules	2 048
I/O address area	
• Inputs	32 kbyte
• Outputs	32 kbyte
per integrated IO subsystem	
– Inputs (volume)	8 kbyte
– Outputs (volume)	8 kbyte
Subprocess images	
• Number of subprocess images, max.	32
Number of IO Controllers	
• integrated	1

Article number	6ES7513-1RL00-0AB0
Time of day	
Clock	
<ul style="list-style-type: none"> Backup time Deviation per day, max. 	<p>6 wk; At 40 °C ambient temperature, typically</p> <p>10 s; Typ.: 2 s</p>
Operating hours counter	
<ul style="list-style-type: none"> Number 	16
Clock synchronization	
<ul style="list-style-type: none"> supported in AS, master in AS, slave on Ethernet via NTP 	<p>Yes</p> <p>No</p> <p>No</p> <p>Yes</p>
Interfaces	
Number of PROFINET interfaces	1
1. Interface	
Interface types	
<ul style="list-style-type: none"> Number of ports integrated switch RJ 45 (Ethernet) 	<p>2</p> <p>Yes</p> <p>Yes; X1</p>
Protocols	
<ul style="list-style-type: none"> IP protocol PROFINET IO Controller PROFINET IO Device SIMATIC communication Open IE communication Web server Media redundancy 	<p>Yes; IPv4</p> <p>Yes</p> <p>No</p> <p>Yes; Only Server</p> <p>Yes</p> <p>No</p> <p>Yes; MRP Automanager according to IEC 62439-2 Edition 2.0</p>

Article number	6ES7513-1RL00-0AB0
PROFINET IO Controller	
Services	
– PG/OP communication	Yes
– S7 routing	No
– Isochronous mode	No
– Open IE communication	Yes
– IRT	No
– MRP	Yes; Only Manager Auto, max. 50 nodes; only 16 are recommended, however
– MRPD	No
– PROFIenergy	Yes
– Number of connectable IO Devices, max.	64
Update time for RT	
– for send cycle of 1 ms	1 ms to 512 ms
Interface types	
RJ 45 (Ethernet)	
• 100 Mbps	Yes
• Autonegotiation	Yes
• Autocrossing	Yes
• Industrial Ethernet status LED	Yes
Protocols	
Number of connections	
• Number of connections, max.	88
• Number of connections reserved for ES/HMI/web	10
PROFINET IO Controller	
Services	
– MRP	Yes; Manager Auto is permanently set in TIA. Max. 50 nodes are possible, 16 are recommended
– MRPD	No
SIMATIC communication	
• S7 communication, as server	Yes
• S7 communication, as client	No

Article number	6ES7513-1RL00-0AB0
Open IE communication	
<ul style="list-style-type: none"> • TCP/IP <ul style="list-style-type: none"> – Data length, max. 64 kbyte – several passive connections per port, supported Yes • ISO-on-TCP (RFC1006) Yes <ul style="list-style-type: none"> – Data length, max. 64 kbyte • UDP Yes <ul style="list-style-type: none"> – Data length, max. 2 kbyte; 1 472 bytes for UDP broadcast – UDP multicast Yes; Max. 5 multicast circuits • DHCP No • SNMP Yes • DCP Yes • LLDP Yes 	
Web server	
<ul style="list-style-type: none"> • HTTP No • HTTPS No 	
OPC UA	
<ul style="list-style-type: none"> • OPC UA client No • OPC UA server No 	
Further protocols	
<ul style="list-style-type: none"> • MODBUS Yes; MODBUS TCP 	
Media redundancy	
<ul style="list-style-type: none"> • Switchover time on line break, typ. 200 ms; PROFINET MRP • Number of stations in the ring, max. 50; Only 16 are recommended, however 	
S7 message functions	
Program alarms	No
Test commissioning functions	
Joint commission (Team Engineering)	No
Status block	Yes; up to 8 simultaneously
Single step	No
Status/control	
<ul style="list-style-type: none"> • Status/control variable Yes • Variables Inputs/outputs, memory bits, DBs, distributed I/Os, timers, counters • Number of variables, max. <ul style="list-style-type: none"> – of which status variables, max. 200; per job – of which control variables, max. 200; per job 	

Article number	6ES7513-1RL00-0AB0
Forcing	
<ul style="list-style-type: none"> Forcing, variables Number of variables, max. 	<p>Peripheral inputs/outputs</p> <p>200</p>
Diagnostic buffer	
<ul style="list-style-type: none"> present Number of entries, max. <ul style="list-style-type: none"> – of which powerfail-proof 	<p>Yes</p> <p>1 000</p> <p>500</p>
Traces	
<ul style="list-style-type: none"> Number of configurable Traces Memory size per trace, max. 	<p>4</p> <p>512 kbyte</p>
Interrupts/diagnostics/status information	
Diagnostics indication LED	
<ul style="list-style-type: none"> RUN/STOP LED ERROR LED MAINT LED 	<p>Yes</p> <p>Yes</p> <p>Yes</p>
Supported technology objects	
Motion Control Controller	No
<ul style="list-style-type: none"> PID_Compact PID_3Step PID-Temp 	<p>No</p> <p>No</p> <p>No</p>
Counting and measuring	
<ul style="list-style-type: none"> High-speed counter 	No
Ambient conditions	
Ambient temperature during operation	
<ul style="list-style-type: none"> horizontal installation, min. horizontal installation, max. vertical installation, min. vertical installation, max. 	<p>0 °C</p> <p>60 °C; Display: 50 °C, at an operating temperature of typically 50 °C, the display is switched off</p> <p>0 °C</p> <p>40 °C; Display: 40 °C, at an operating temperature of typically 40 °C, the display is switched off</p>
Ambient temperature during storage/transportation	
<ul style="list-style-type: none"> min. max. 	<p>-40 °C</p> <p>70 °C</p>

Article number	6ES7513-1RL00-0AB0
Configuration	
Programming	
Programming language	
– LAD	Yes
– FBD	Yes
– STL	Yes
– SCL	Yes
– GRAPH	No
Know-how protection	
• User program protection/password protection	Yes
• Copy protection	No
• Block protection	Yes
Access protection	
• Password for display	Yes
• Protection level: Write protection	Yes
• Protection level: Read/write protection	Yes
• Protection level: Complete protection	Yes
Dimensions	
Width	35 mm
Height	147 mm
Depth	129 mm
Weights	
Weight, approx.	430 g

You can find information on the general technical specifications, such as standards and approvals, electromagnetic compatibility, protection class, etc. in the system manual for Redundant System S7-1500R/H

(<https://support.industry.siemens.com/cs/ww/en/view/109754833>).

Dimension drawing

A.1 Dimension drawing

This section contains the dimensional drawing of the module on the mounting rail, as well as a dimensional drawing with the front panel open. Keep to the dimensions when installing in cabinets, control rooms, etc.

Dimension drawings of the CPU 1513R-1 PN

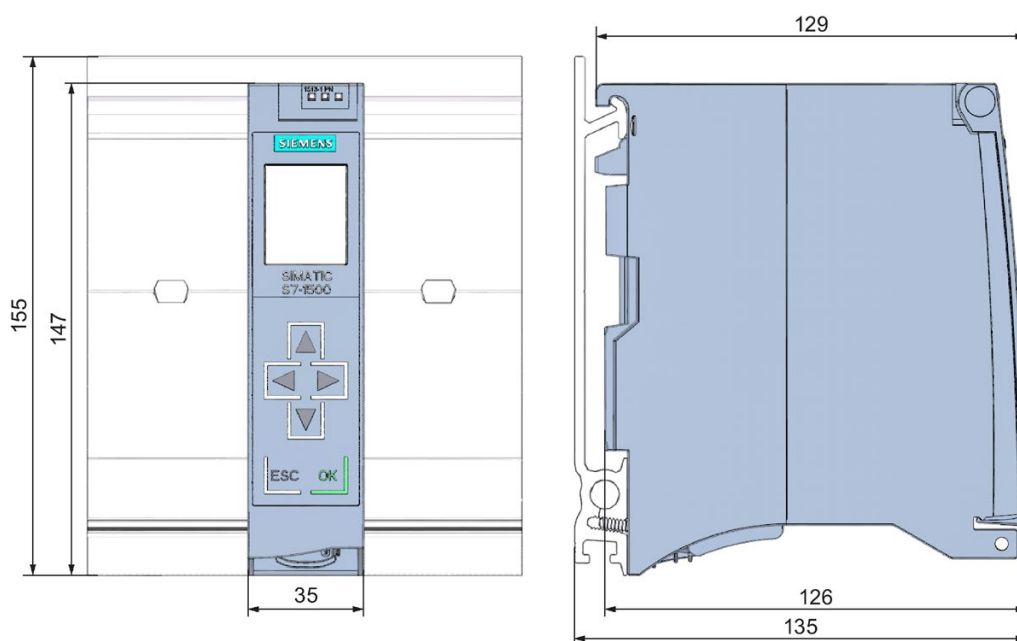

Figure A-1 Dimension drawing of the CPU 1513R-1 PN, front and side view

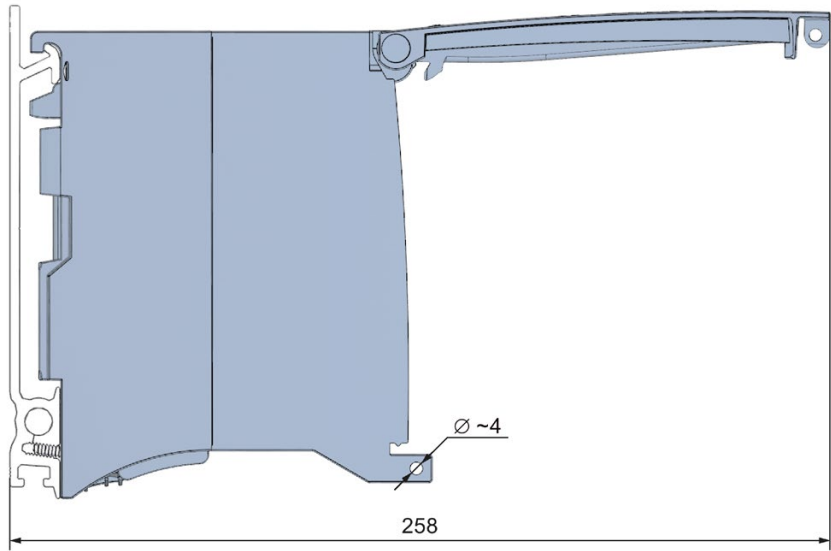

Figure A-2 Dimension drawing of the CPU 1513R-1 PN, side view with front panel open