

**Circuit
Breaker
Lighting
Panel
Type P1**

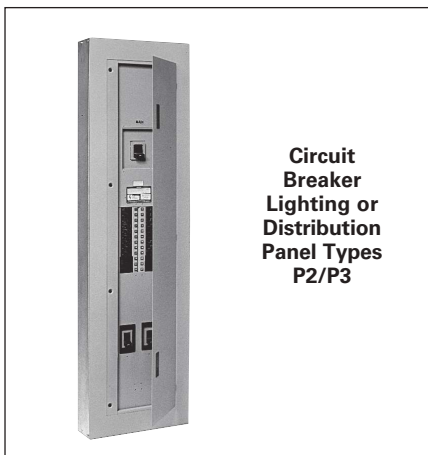

**Circuit
Breaker
Lighting or
Distribution
Panel Types
P2/P3**

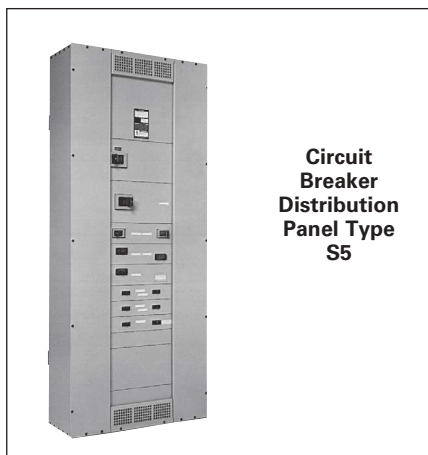

**Circuit
Breaker
Distribution
Panel Type
S5**

Contents

Features, Reference Guide & General Specifications	10-2 – 10-9
Distributor Stock - Type P1 Panelboards	10-10 – 10-11
Warehouse Stock/Unassembled – Type P1 Panelboards	10-12 – 10-14
Panelboard Replacement, Modification, and Additions	10-15
Factory Assembled Panelboard Coding System	10-16
Type P1	
Specifications	10-17
Main Breaker	10-18
Main Lug and Branch Circuit Breakers	10-19
Kits and Accessories	10-20 – 10-21
Panel Options & Modifications	10-22 – 10-23
Enclosure Dimensions	10-24
Type P2	
Specifications	10-25
Distributor Stock/Unassembled - Type P2 Main Lug Only	10-26 – 10-27
Main Breaker and Subfeed Breakers	10-28 – 10-30
Branch Breakers	10-31
Modifications and Additions	10-32
SEM3 Embedded Micro Metering Module	10-33 – 10-34
Standard Modifications and Additions	10-35
Enclosure Modifications	10-36
Kits and Accessories	10-37
Enclosure Dimensions	10-38
Type P3	
Specifications	10-39
Enclosure Selection/ Dimensions	10-40
Alternate Main, Branch and Subfeed Breakers	10-41 – 10-42
Modifications and Additions	10-43 – 10-45
Kits and Accessories	10-46
Enclosure Dimensions	10-47
Lighting Panel Filler Plates	10-48 – 10-49
Lighting Panel Kits	10-50 – 10-51
B74FLR Enclosures & Related Bottom Covers	10-52 – 10-53
Type S5	
Specifications	10-54
Main Lug and Main Breaker Selection	10-55
Branch Breakers	10-56
Modifications and Additions	10-57
Modifications, Additions, Replacements for Circuit Breakers	10-58
Type F2	
Specifications and Fuse Types	10-59
Main Lug and Main Fusible	10-60
Modifications and Additions	10-61
Modifications, Additions, Replacements for Fusible Switches	10-62
SEM3 Embedded Micro Metering Module	10-63
Panel Skirt/System Types, AC & DC Voltages	10-64
Type HCP Switchboard Units	
Selection and accessories	10-65
Dimensions	10-66
Type C1/C2	
Specifications	10-67
Main, Branch and Subfeed Breakers	10-68
Circuit Breaker / Column Type, Modifications and Additions	10-69
Conduit Enclosing Shield (Panel Skirts)	10-70
Enclosure/System Types, AC & DC Voltages	10-71
Dimensions and Panelboard Configurations	10-72 – 10-73
Fuse Curves	10-74

Panelboards

Introduction

General

This generation of panelboards from Siemens offers the high level of engineering and innovation you've come to expect from the leader in power distribution technology. The "P Series" line of panelboards offers a stepped approach to power distribution.

Additional strength has been added to an already rugged and durable panelboard family. Engineered specifically to provide maximum flexibility, the new designs simplify wiring and reduce material requirements making them easier to install and less costly than competitive products. At the heart of the product line is the extensive research and technology found among Siemens circuit protection devices – both fusible switches and molded case circuit breakers.

The line is anchored by the innovative P1. Featuring the industry's most flexible designs, the P1 virtually eliminates common errors, such as feed direction, and main lug versus main breaker. Increasing distribution is simplified by the ability to add feed-thru lugs. The Next Gen P1 design introduced in June 2015 has added Extended Circuits up to 66 and has available smaller Enclosures with no Subfeed option for added flexibility.

Subsequent steps in the P Series offer increased capacity and more design options:

- The highly flexible P2 provides options to fit the most demanding specifications.
- Sized more like a lighting panel, the P3 packs the power of a distribution panel in a space-saving, highly flexible design.

- The powerful S5 and F2 are distribution power panels that allow circuit breakers as branch and main devices.

Siemens also offers a number of specialty panels, like column panels, SEM3 (Embedded Micro Metering Module™) and others. Don't see a panel to meet your requirements? Ask your Siemens representative about our custom capabilities.

Features Overview

P Series lighting panel features include Fas-Latch trim, which is popular among installers; the jacking screw system, that permits adjustments even after wiring has been installed; our exclusive split neutral, and more. Many panelboards have the capability of mixing and matching breakers of different sizes and ratings – or changing from main lug to main breaker, or adding subfeed breakers without changing the box size. Other models accept a wide range of fuse types, including Siemens exclusive Vacu-Break® technology.

Key Panelboard Features

	P1	P2	P3	S5	F2
Lighting And Appliance Applications	●	●	●	●	●
Power Panelboard Applications	—	●	●	●	●
Convertible From Top Feed To Bottom Feed Or Vice Versa	●	—	—	—	—
Change From Main Lug To Main Breaker Or Add Subfeed Without Changing Enclosure Size [®]	●	—	—	—	—
Space-Saving, Horizontally Mounted Main Breaker	Up To 250 Amps	Up To 250 Amps	—	●	●
Short-Circuit Rating Label Giving Performance Level	●	●	●	●	●
Standard Aluminum Ground Assembly	●	●	●	●	●
Blank End-Walls Standard [®]	●	●	●	●	●
Bolted Current-Carrying Parts	●	●	●	●	●
Split Neutral	●	—	●	●	●
Connection Accessible From Front	●	●	●	●	●
Screw-Type Mechanical Lugs	●	●	●	●	●
Time-Reducing Wing Nuts To Secure Interior Without Tools	●	●	●	●	●
Main and Branch Devices Connected With Case-Hardened Hardware	●	●	●	●	●
Flush Lock, Concealed Door Hinges/Trim Screws	●	●	●	—	—
Symmetrical Interior Mounting Studs To Eliminate Upside-Down Mounting of Box	●	●	●	●	●
Interior Height Adjustment For Flush Applications	●	●	●	—	—
Shallow Depth	5.75"	5.75"	7.75"	12.75"	12.75"
Accepts A Wide Range Of Fuse Types	—	—	—	—	●
Accepts Vacu-Break Fusible Switch	—	—	—	—	●
Accepts A Wide Range Of Circuit Breakers	●	●	●	●	●
Optional Compression Lugs	●	●	●	●	●

● Standard

® KO's available on P1 and P2 – 5.75" Deep x 20" Wide boxes and P3 7.75" deep X 24" wide boxes.

® For Next Gen P1, only when Subfeed Space is selected, Interior Part Number ends with "T". When "N" is at end there is no Subfeed Space available

Panelboards

General Specifications

General

Service Entrance Equipment

When a panelboard is used as service entrance equipment, it must be located as close as practicable to the point of entrance of building supply conductors. Panelboards must be identified as "Service Entrance" at the time of order entry in order to be supplied with the appropriate CSA certification and labelling. Panels must include a connector for bonding and grounding neutral conductor. Please consult CSA, CEC and local inspection authorities for specification and installation guidelines.

Integrated Equipment Short Circuit Rating

The term "Integrated Equipment Short Circuit Rating" refers to the application of series connected circuit breakers in a combination that allows some breakers to have lower individual interrupting ratings than the available fault current. This is permitted as long as the series combination has been tested and certified by CSA. "Series Rated" must be identified at the time of order entry.

Standards

CSA: C22.2 No.29. Certified under files # 93833
UL: 67 and 50. Listed by Underwriter's Laboratories, Inc., under "Panelboards" File #E2269, and #E4016.

Wire Connectors

Standard wire connectors in Siemens panels are suitable for copper or aluminum cables rated 60/75 degree. Copper main lugs are a price-added option for most panel types and some Circuit Breakers (check with Siemens sales for availability). It should be noted that most copper lugs will only accept copper cables. Some applications, 100% rated devices in particular, require that the cable and connectors be rated 90 degree but are sized to the 75 degree tables.

Standard ground connectors are also suitable for copper or aluminum wire. Ground connector assemblies (EGK, IGK) have (7) 1/0 max. and (15) #6 max. connections. The 1/0 holes are capable of connecting up (3) #10 max. wires. Copper ground assemblies (ECGK, ICGK) are rated for copper wire only and have the same wiring capacity as the Al/Cu connectors.

Standard neutrals, like standard main lugs, are also rated for copper or aluminum wire. The neutral cross bar material follows the selection bus. Copper neutral lugs are rated for copper cable only and available as a price added option.

Lug Data Feed-Thru Lugs

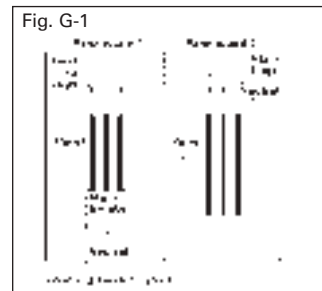

Subfeed Lugs or Double Lug

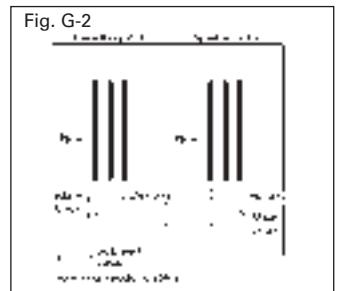

Feed-thru lugs are mounted at the opposite end of the main bus from the main lugs or main breaker and are used to connect two or more panelboards to the incoming feeder. The feeder cables are brought into Panelboard 1 and connected to the main lugs or main breaker. Cables interconnecting the two panelboards are connected to the feed-thru lugs in Panelboard 1 and are carried over the main lugs in Panelboard 2. This arrangement could be reversed with the main lugs located at the top and the feed-thru lugs at the bottom of the panel.

Subfeed lugs are mounted directly beside the main incoming lugs and are used to connect two or more panelboards to the incoming feeder. The feeder cables are brought into Panelboard 1 and connected to the main lugs. Another set of cables that are the same size are connected to the subfeed lugs of Panelboard 1 and are carried over the main lugs of Panelboard 2.

Panelboards

General Specifications

General

Bussing Sequence

Interiors are designed to accommodate top or bottom feed.

All breakers have bolted connections.

The panel design provides bracing up to 200,000A IR CSA short circuit rating.

Case-hardened, high performance, thread rolling screws are used on branch bus.

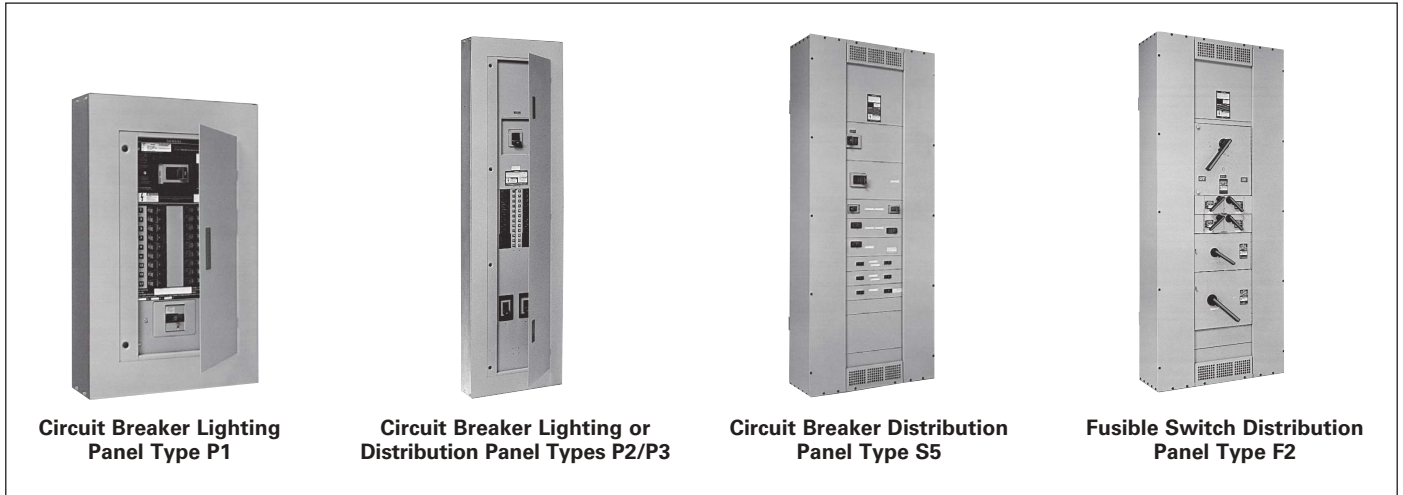

Panelboard Ratings

Description	Next Gen P1	P2	P3	S5	F2
Max. Voltage	600Y/347V AC Max.	600V AC Max. 250V DC Max.	600V AC Max. 250V DC Max.	600V AC Max. 250V DC Max.	600V AC Max. 250V DC Max.
System	1-Phase, 2-wire 1-Phase, 3-wire 3-Phase, 3-wire 3-Phase, 4-wire	1-Phase, 2-wire 1-Phase, 3-wire 3-Phase, 3-wire 3-Phase, 4-wire	1-Phase, 2-wire 1-Phase, 3-wire 3-Phase, 4-wire 3-Phase, 3-wire	1-Phase, 3-wire 3-Phase, 4-wire 3-Phase, 3-wire	1-Phase, 3-wire 3-Phase, 4-wire 3-Phase, 3-wire
Mains					
Main Lugs	125A-400A	125A-600A	400A-800A	225A-1200A	225A-1200A
Main Breaker	100A-400A	100A-600A	400A-600A	400A-1200A	—
Main Switch	—	—	—	—	200A-600A
Circuits	18, 30, 42, 54, 66 (250A) 30, 42, 54, 66 (400A)	18, 30, 42, 54, 66 78, 90 ^①	18, 30, 42, 54, 66, 78, 90	—	—
Branch Ratings	15-125A (Interior) 250A Max. (Subfeed breaker)	15-225A (Interior) 250A Max. (Subfeed breaker)	15-225A (Interior) 400A Max. (Subfeed breaker)	15-1200A MCCB	30-1200A Fusible
Branch Disconnect Devices	BL, BLH, HBL, BQD, BQD6, BLE, BLEH, BLF2, BLHF2, HBLF2, BLFB, BLHFB, BAF2, BAFH2, HBAF2, BFGA2, BFGAH2, HBFGA2, NGB ^②	BL, BLH, HBL, BQD, BQD6, QR2 ^③ , QRH2 ^③ , HQR2 ^③ , HQR2H ^③ , ED2, ED4, HED4, ED6, CED6, BLE, BLEH, BLF2, BLHF2, HBLF2, BLFB, BLHFB, BAF2, BAFH2, HBAF2, BFGA2, BFGAH2, HBFGA2, NGB2, HGB2, LGB2	BL, BLH, HBL, BQD, BQD6, QR2 ^③ , QRH2 ^③ , HQR2 ^③ , HQR2H ^③ , ED2, ED4, HED4, ED6, BLE, BLHF, BLEH, BLF2, BLHF2, HBLF2, BLFB, BAF2, BAFH2, HBAF2, BFGA2, BFGAH2, HBFGA2, NGB2, HGB2, LGB2	All 15-1200A MCCBs, and VL DG, FG, JG	All 30-600A VB switches, 30-200A VK switches, and 800-1200A HCP switches
Subfeed Circuit Breakers ^{②③}	ED2, ED4, ED6, HED4, QR2, QRH2, HQR2, HQR2H, FD6, HFD6, FXD6, HFXD6	JD6, HJD6, JXD6, HJXD6, FD6, HFD6, FXD6, HFXD6	JD6, HJD6, JXD6, HJXD6, FD6, HFD6, FXD6, HFXD6	—	—
Enclosure Heights Inches – (mm)	26, 32, 38, 44, 50, 56 @250A (660, 813, 965, 1118, 1270, 1422) 56, 62, 68, 74 @400A (1422, 1575, 1727, 1880)	26, 32, 38, 44, 50, 56, 62, 68, 74 (660-1880)	56, 62, 68, 74, 80 (1422-2032)	60, 75, 90 (1524, 1905, 2286)	60, 75, 90 (1524, 1905, 2286)
Standard Trims	Fas-Latch – 1 Piece Surface or Flush	Fas-Latch – 1 Piece Surface or Flush	Fas-Latch – 1 Piece Surface or Flush	—	—

① P1 panels with NGB breakers are limited to NGB branch devices only. BL and BQD frames may not be mixed in this panel type.

② P1 can have max. 1 subfeed breaker when Subfeed Space is available. P2 and P3 can have up to (2) FD subfeed breakers.

③ JD and FD breakers are mounted vertical. Limitations apply.

④ A maximum of (3) QR breakers may be mounted in a P2 Panel and are single mounted.

⑤ A maximum of (4) QR breakers may be mounted in a P3 panel and are twin mounted.

Panelboards

General Specifications

General

Typical Panelboard Modifications

Description	Lighting and Distribution Panelboards			Distribution Panelboards	
	P1	P2	P3	S5	F2
Box					
Type 1	Standard (20" W)	Standard (20" W)	Standard (24" W)	Standard	Standard
Type 1 Enclosure with Hood (available from distributor stock)	●	●	●	●	●
Type 1 w/Gasket between box and front	●	●	●	●	●
Type 2 Enclosure - Drip Tight [Ⓞ]	●	●	●	●	●
Type 3R/12	●	●	●	●	●
Type 4, 4X (size varies by type/material)	●	●	●	—	—
Wider Box (check w/factory for custom options)	● (24"W)	● (24", 30" or 36"W)	● (30" or 36"W)	● (custom)	● (custom)
Deeper Box (check w/factory for custom options)	(7.75"D)	● (7.75"D)	● (custom)	● (custom)	● (custom)
Front					
Front with Door	Standard	Standard	Standard	●	●
4-piece Front	—	—	—	Standard	Standard
4-piece Front w/Hinged Gutter Covers	—	—	—	●	●
Hinged-to-Box Front/Skew-to-Box Front	●	●	●	(see Door-in-Door)	(see Door-in-Door)
Door-in-Door Front	●	●	●	●	●
Door with padlock	●	●	●	—	—
Special Locks	●	●	●	●	●
Nameplate	●	●	●	●	●
Interior					
Aluminum Equipment Ground Bar	Standard	Standard	Standard	Standard	Standard
Copper Equipment Ground Bar	●	●	●	●	●
Insulated Equipment Ground (CU or AL)	●	●	●	●	●
Subfeed Lugs	—	●	●	●	●
Feed-Thru Lugs	●	●	●	●	●
Compression Lugs	●	●	●	●	●
Copper Lugs	●	●	●	●	●
200% Neutral	●	●	●	400 - 600A	400 - 600A
Tin Plated Aluminum Bussing	Standard	Standard	Standard	Standard	Standard
Tin Plated Copper Bussing	●	●	●	●	●
Silver Plated Copper Bussing	—	●	●	●	●
R, J and T Fuse Clips	—	—	—	—	●

● Available as an option. — Not Available

[Ⓞ] To meet sprinkler proof requirements (CEC Rule 26-008):
 - P1/P2/P3 Panels:
 - Select Type 2 enclosure for non-service entrance applications.
 - Select Type 3R enclosure for service entrance applications.
 - S5/F2 Panels:
 - Select Type 3R enclosure.

Panelboards

Trim / Front

Dimensions



Standard Trim (FAS-Latch)
(14 Gage Standard)

(Into stock includes surface or flush versions of this style in chart on page 11.

Standard Trim (FAS-Latch) Typical Dimensions (Hinges available as shown on right side only)

(Typical 14 Gage Steel construction or approved equivalent)

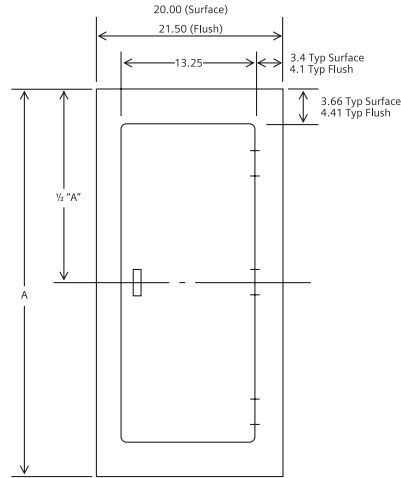

Box Size	Surface	Flush	# of Hinges
	A	A	
26	26	27.5	2
32	32	33.5	2
38	38	39.5	2
44	44	45.5	3
50	50	51.5	3

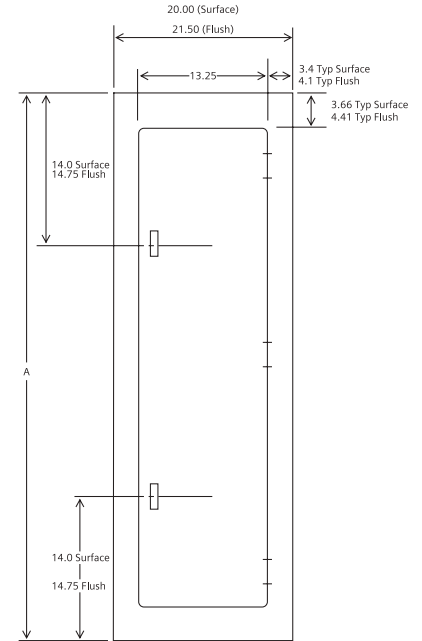

Box Size	Surface	Flush	# of Hinges
	A	A	
56	56	57.5	3
62	62	63.5	3
68	68	69.5	3
74	74	75.5	3



Door in Door Front
(14 Gage Standard)



Hinged to Box Front
(14 Gage Standard)

Also available

- Screw to Box Trim (14 Gauge Std.)
- Piano Hinge Trim (14 Gauge Std.)
 - a) Screw to box with Piano Hinge Door
 - b) Hinge to Box with Piano Hinge and Piano Hinge Door
 - c) Door-in-Door with Piano Hinge, Both Doors

Panelboards

Special Enclosures

Options



TYPE 3R/12 Enclosures
(Sizes vary by construction)



TYPE 4 Enclosures/TYPE 4X Enclosures
(Sizes vary by construction)

Panel Family Portrait



"P" Series Panelboard Family for Lighting and Appliance and Distribution Panel Applications

Panelboards

Distribution Connector Kits (Circuit Breakers)

Reference

Max Amp Rating	Breaker Family	Branch Breaker Type	Next Gen P1	P2	P3	S5	F2
100	General	BL, BLH, HBL, BQD6	No kit required	BBKB32	BBKB32	6BL2C ^③	—
125	General	NGB	No kit required ^①	BBKNB32	BBKNB32	SNBD	—
	General	NGB2, HGB2, LGB2	—	BBKGB32	BBKGB32	SGB2DCAN	—
	General	HEB	—	—	BBKEB32	SEBD	—
	Sentron	ED2, ED4, ED6, HED4	—	BBKED32	BBKED32	6E62 ^{②③}	—
	Sentron	CED6	—	BBKCED32	—	6CLE2 ^②	—
150	VL	NDG, LDG	—	—	—	SDGD	—
225	General Purpose	QR2, QR2H, HQR2, HQR2H	—	BBKQR1	BBKQR2	6QR2CAN ^④	—
250	Sentron	FXD6, FD6, HFD6, HHFD6	—	—	—	6F62 ^②	—
	VL	NFG, LFG	—	—	—	SFGD	—
	Sentron	CFD6	—	—	—	6CLF1C	—
400	Sentron	JXD6, JD6, HJD6, HHJD6	—	—	—	6JJ62 ^②	—
	VL (Single)	NJG, LJG	—	—	—	SJG1D	—
	VL (Twin)	NJG, LJG	—	—	—	SJG2D	—
	Sentron	CJD6	—	—	—	6CLJ1C	—
600	Sentron	LXD6, LD6, HLD6, HHLD6, SLD6, SHLD6, SJD6, SHJD6	—	—	—	6LL61C	—
	Sentron	CLD6	—	—	—	6CLL1C	—
	Sentron	SCJD6, SCLD6	—	—	—	6SCL61C	—
800	Sentron	MXD6, MD6, HMD6, CMD6, SHMD6, SCMD6	—	—	—	6M61C	—
1200	Sentron	NXD6, ND6, HND6, CND6, SHND6, SCND6	—	—	—	6N61C	—

① NGB branch breakers can be installed in P1 interior ending with suffix "-NGB" only.

② These are aluminum connectors. If copper is required please add suffix C.

③ 3.75" plate accommodates six 1-pole breakers.

④ For QR filler plate only, use p/n: **6QR2FKCAN**. For copper QR kit, use p/n: **6QR2CCAN**.

Panelboards

Features / Benefits

Reference

The standard Siemens P1 panelboard has some unique features that make it easier to design for an engineer, easier to reconfigure in the field for a contractor, and easier to upgrade and maintain for the Owner. The P1 is the smallest panel in the Siemens lineup, with bus sizes up to 400A. What makes it different is the split neutral design and the open ended bus. In the Siemens panel, instead of the common single neutral bus on one end, we have a neutral bus on both sides that is cross-bussed. This makes branch wiring simpler and cleaner – the lead lengths for line and neutral can now be made nearly the same, creating more room and a neater installation. It also allows access to both ends of the bus as a standard feature – this provides the flexibility to make changes in the field, even if it wasn't part of the original configuration. Next Gen P1 introduced in 2015 has extended circuits up to 66 available and also non-feed thru versions are available, without the Subfeed Space, in a 6" smaller enclosure.

MAIN BREAKER or SUB-FEED BREAKER

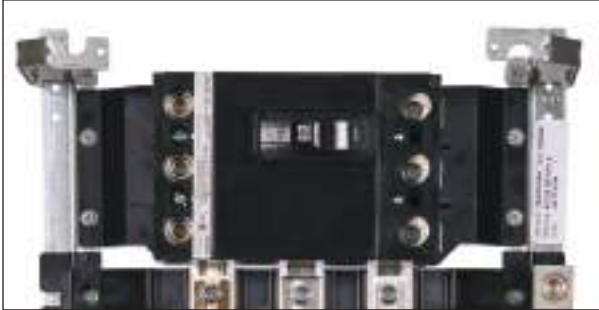

MAIN LUGS or FEED-THROUGH LUGS



INTEGRAL BUS MOUNTED SPD

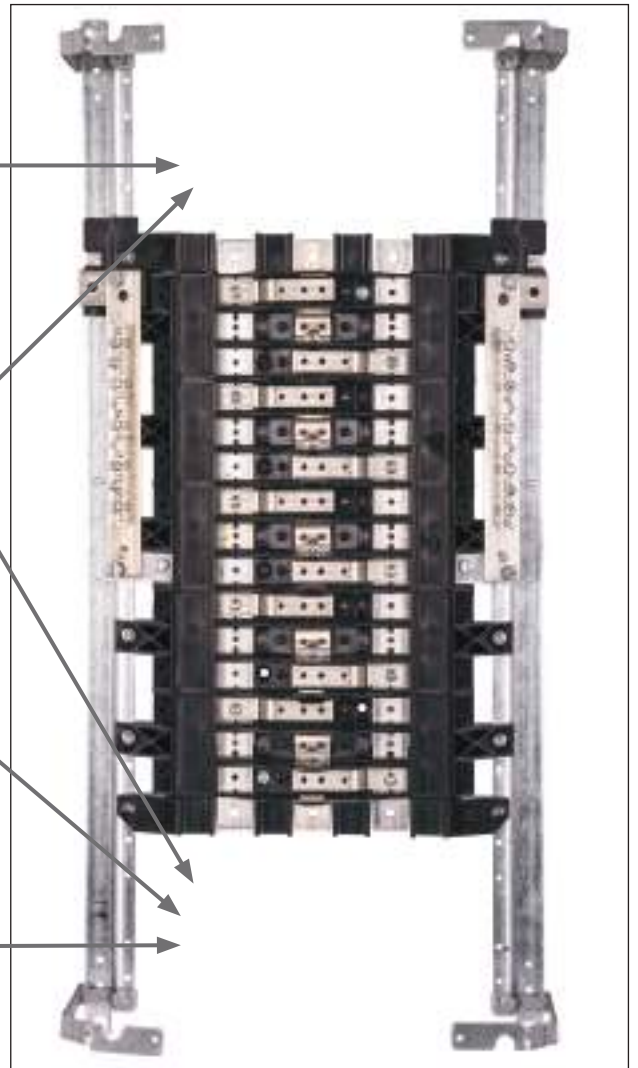

The following can be done to a standard P1 panelboard **in the field** with no modifications:

- Change from top fed to bottom fed
- Add feed-through lugs^①
- Add an Integral bus-mounted SPD^①
- Add a sub feed breaker up to 250 amps^①
- Change from Main Lugs to Main Breaker
- Change from Main Breaker to Main Lugs
- Panel may have up to two ground assemblies. Options are: (a) standard aluminum, (b) optional copper, or (c) optional insulated/isolated aluminum or copper. Mounting provisions in opposing corners of the box are standard. Any of these options may be added after installation.

^① Only when Subfeed Space is selected/available.

Panelboards

Distributor stock - Type P1 Ready To Assemble Panelboards

Reference

Type P1 ready to assemble panelboards are completely convertible from main lug to main breaker and vice-versa. Additionally, feed-thru lugs or subfeed circuit breakers up to 400 amperes can be added without increasing the box height for Next Gen P1 with "T" suffix, see the chart.

1. Compute total number of poles to determine interior catalog number. (Note: BL / BQD (or) or NGB Main Breaker will use unit space. The total number of poles should include 2 or 3 poles for 1-phase or 3-phase mains.
2. List catalog number of interior, box and front.
3. Select main lug kit or main breaker kit from appropriate tables.

- Note:** Main/Subfeed Breaker mounting kits may be ordered with or without breakers included, see page 10-12 and 10-13 for selection.
4. List required branch circuit breakers and filler plates to cover any unused positions.
 5. Select any modifications or accessories.

Note: Next Gen P1 was introduced in June 2015. All original P1 devices do not include the "Subfeed Space" Indicator. All original P1 included the Subfeed Space as standard.

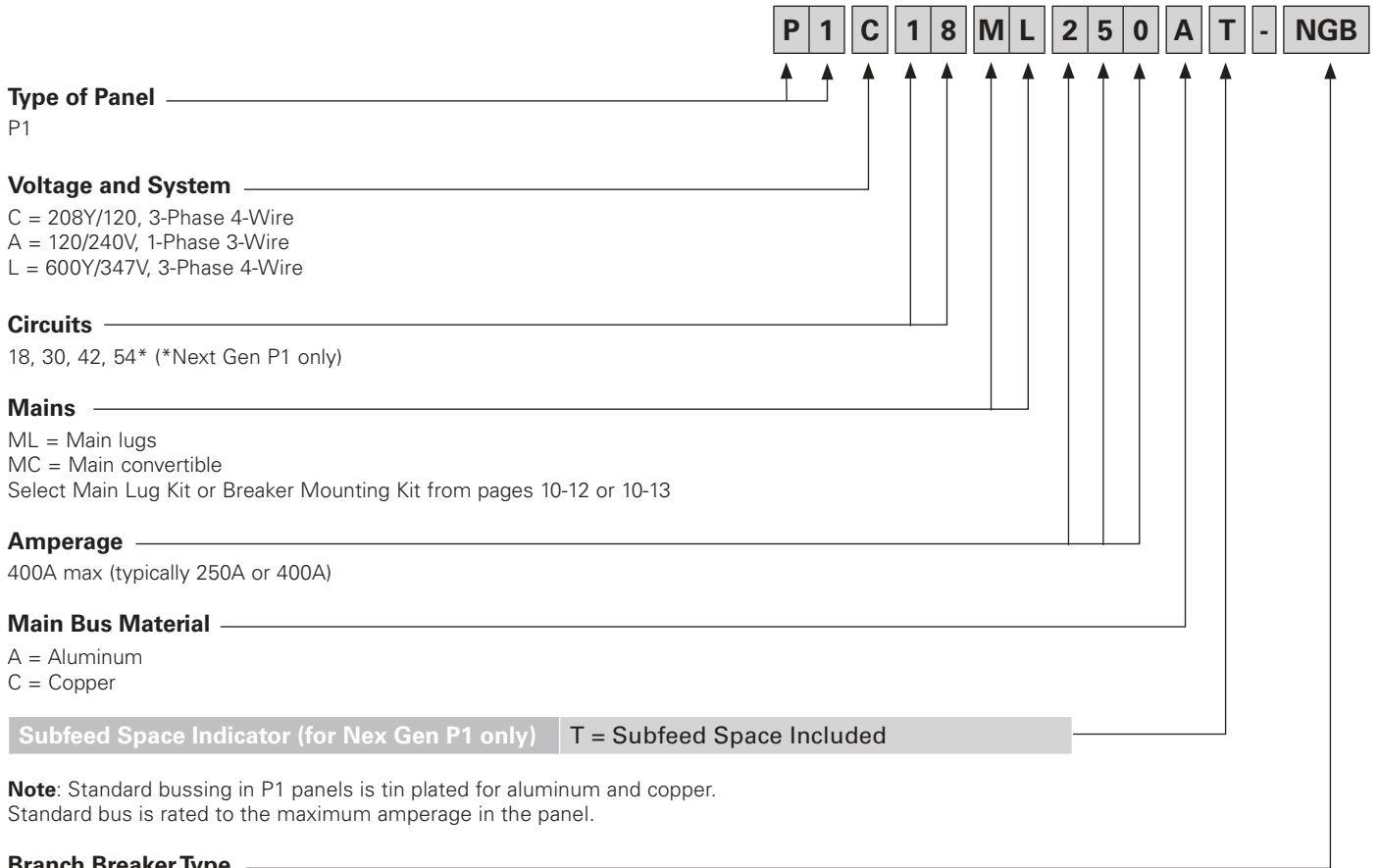

Note: Standard bussing in P1 panels is tin plated for aluminum and copper. Standard bus is rated to the maximum amperage in the panel.

Branch Breakers

Panel Type	Voltage (Max.)	Breaker Type	Additional Information
Next Gen P1	240	BL, BLH, HBL, BQD, NGB	See Page 10-13 and 10-14
	480 / 277	BQD, NGB	
	600 / 347	BQD6, NGB	

Panelboards

Distributor Stock - Type P1 Ready To Assemble Panelboards

Reference

400A Max. — 20" Wide x 5.75" Deep

1. Choose the appropriate Interior from the table below.
2. Choose the Main Device: Main Lugs from page 10-12, Main Breaker Kit from pages 10-12 - 10-13.
3. Choose Branch Breakers. BL, BQD and NGB breakers from pages 10-13 - 10-14.
4. Choose Feed-Thru Lugs or Subfeed Breaker Kit from page 10-12.

Type P1 Into Stock Panelboards (Next Gen P1 introduced in June 2015)

Amps	Max. #of Poles	Original Main Lugs Interior Cat. Number	Next Gen P1 Main Lug Interior Cat. Number	Original Main Convertible Interior Cat. Number	Next Gen P1 Main Convertible Interior Cat. Number	Box Size	Type 1 Encl.	Type 3R/12 Encl.®	Type 1 Front Surface	Type1 Front Flush
1-Phase, 3-Wire 120/240V										
250	18	P1A18ML250A	P1A18ML250AT	P1A18MC250A	P1A18MC250AT	32	B32	WP32	S32B	F32B
	30	P1A30ML250A	P1A30ML250AT	P1A30MC250A	P1A30MC250AT	38	B38	WP38	S38B	F38B
	42	P1A42ML250A	P1A42ML250AT	P1A42MC250A	P1A42MC250AT	44	B44	WP44	S44B	F44B
	54	—	P1A54ML250AT	—	P1A54MC250AT	50	B50	WP50	S50B	F50B
400	18	P1A18ML400A	—	P1A18MC400A	—	62	B62	—	—	—
	30	P1A30ML400A	P1A30ML400AT	P1A30MC400A	P1A30MC400AT	68	B68	WP68	S68B	F68B
	42	P1A42ML400A	P1A42ML400AT	P1A42MC400A	P1A42MC400AT	74	B74	WP74	S74B	F74B
	54	—	P1A54ML400AT	—	P1A54MC400AT	—	—	—	—	—
250	18	P1A18ML250C	P1A18ML250CT	P1A18MC250C	P1A18MC250CT	32	B32	WP32	S32B	F32B
	30	P1A30ML250C	P1A30ML250CT	P1A30MC250C	P1A30MC250CT	38	B38	WP38	S38B	F38B
	42	P1A42ML250C	P1A42ML250CT	P1A42MC250C	P1A42MC250CT	44	B44	WP44	S44B	F44B
	54	—	P1A54ML250CT	—	P1A54MC250CT	50	B50	WP50	S50B	F50B
400	18	P1A18ML400C	—	P1A18MC400C	—	62	B62	—	—	—
	30	P1A30ML400C	P1A30ML400CT	P1A30MC400C	P1A30MC400CT	68	B68	WP68	S68B	F68B
	42	P1A42ML400C	P1A42ML400CT	P1A42MC400C	P1A42MC400CT	74	B74	WP74	S74B	F74B
	54	—	P1A54ML400CT	—	P1A54MC400CT	—	—	—	—	—
3-Phase, 4-Wire 208Y / 120V										
250	18	P1C18ML250A	P1C18ML250AT	P1C18MC250A	P1C18MC250AT	32	B32	WP32	S32B	F32B
	30	P1C30ML250A	P1C30ML250AT	P1C30MC250A	P1C30MC250AT	38	B38	WP38	S38B	F38B
	42	P1C42ML250A	P1C42ML250AT	P1C42MC250A	P1C42MC250AT	44	B44	WP44	S44B	F44B
	54	—	P1C54ML250AT	—	P1C54MC250AT	50	B50	WP50	S50B	F50B
400	18	P1C18ML400A	—	P1C18MC400A	—	62	B62	—	—	—
	30	P1C30ML400A	P1C30ML400AT	P1C30MC400A	P1C30MC400AT	68	B68	WP68	S68B	F68B
	42	P1C42ML400A	P1C42ML400AT	P1C42MC400A	P1C42MC400AT	74	B74	WP74	S74B	F74B
	54	—	P1C54ML400AT	—	P1C54MC400AT	—	—	—	—	—
250	18	P1C18ML250C	P1C18ML250CT	P1C18MC250C	P1C18MC250CT	32	B32	WP32	S32B	F32B
	30	P1C30ML250C	P1C30ML250CT	P1C30MC250C	P1C30MC250CT	38	B38	WP38	S38B	F38B
	42	P1C42ML250C	P1C42ML250CT	P1C42MC250C	P1C42MC250CT	44	B44	WP44	S44B	F44B
	54	—	P1C54ML250CT	—	P1C54MC250CT	50	B50	WP50	S50B	F50B
400	18	P1C18ML400C	—	P1C18MC400C	—	62	B62	—	—	—
	30	P1C30ML400C	P1C30ML400CT	P1C30MC400C	P1C30MC400CT	68	B68	WP68	S68B	F68B
	42	P1C42ML400C	P1C42ML400CT	P1C42MC400C	P1C42MC400CT	74	B74	WP74	S74B	F74B
	54	—	P1C54ML400CT	—	P1C54MC400CT	—	—	—	—	—
3-Phase, 4-Wire 600Y/347V										
250	18	P1L18ML250A	P1L18ML250AT	P1L18MC250A	P1L18MC250AT	32	B32	WP32	S32B	F32B
	30	P1L30ML250A	P1L30ML250AT	P1L30MC250A	P1L30MC250AT	38	B38	WP38	S38B	F38B
	42	P1L42ML250A	P1L42ML250AT	P1L42MC250A	P1L42MC250AT	44	B44	WP44	S44B	F44B
	54	—	P1L54ML250AT	—	P1L54MC250AT	50	B50	WP50	S50B	F50B
400	18	P1L18ML400A	—	P1L18MC400A	—	62	B62	—	—	—
	30	P1L30ML400A	P1L30ML400AT	P1L30MC400A	P1L30MC400AT	68	B68	WP68	S68B	F68B
	42	P1L42ML400A	P1L42ML400AT	P1L42MC400A	P1L42MC400AT	74	B74	WP74	S74B	F74B
	54	—	P1L54ML400AT	—	P1L54MC400AT	—	—	—	—	—
250	18	P1L18ML250C	P1L18ML250CT	P1L18MC250C	P1L18MC250CT	32	B32	WP32	S32B	F32B
	30	P1L30ML250C	P1L30ML250CT	P1L30MC250C	P1L30MC250CT	38	B38	WP38	S38B	F38B
	42	P1L42ML250C	P1L42ML250CT	P1L42MC250C	P1L42MC250CT	44	B44	WP44	S44B	F44B
	54	—	P1L54ML250CT	—	P1L54MC250CT	50	B50	WP50	S50B	F50B
400	18	P1L18ML400C	—	P1L18MC400C	—	62	B62	—	—	—
	30	P1L30ML400C	P1L30ML400CT	P1L30MC400C	P1L30MC400CT	68	B68	WP68	S68B	F68B
	42	P1L42ML400C	P1L42ML400CT	P1L42MC400C	P1L42MC400CT	74	B74	WP74	S74B	F74B
	54	—	P1L54ML400CT	—	P1L54MC400CT	—	—	—	—	—
Interiors for NGB Breakers — 3-Phase, 4-Wire 600Y/347V										
250	18	—	P1L18ML250AT-NGB	—	P1L18MC250AT-NGB	32	B32	WP32	S32B	F32B
	30	—	P1L30ML250AT-NGB	—	P1L30MC250AT-NGB	38	B38	WP38	S38B	F38B
	42	—	P1L42ML250AT-NGB	—	P1L42MC250AT-NGB	44	B44	WP44	S44B	F44B
	54	—	P1L54ML250AT-NGB	—	P1L54MC250AT-NGB	50	B50	WP50	S50B	F50B
400	18	—	—	—	—	62	B62	—	—	—
	30	—	P1L30ML400AT-NGB	—	P1L30MC400AT-NGB	68	B68	WP68	S68B	F68B
	42	—	P1L42ML400AT-NGB	—	P1L42MC400AT-NGB	74	B74	WP74	S74B	F74B
	54	—	P1L54ML400AT-NGB	—	P1L54MC400AT-NGB	—	—	—	—	—
250	18	—	P1L18ML250CT-NGB	—	P1L18MC250CT-NGB	32	B32	WP32	S32B	F32B
	30	—	P1L30ML250CT-NGB	—	P1L30MC250CT-NGB	38	B38	WP38	S38B	F38B
	42	—	P1L42ML250CT-NGB	—	P1L42MC250CT-NGB	44	B44	WP44	S44B	F44B
	54	—	P1L54ML250CT-NGB	—	P1L54MC250CT-NGB	50	B50	WP50	S50B	F50B
400	18	—	—	—	—	62	B62	—	—	—
	30	—	P1L30ML400CT-NGB	—	P1L30MC400CT-NGB	68	B68	WP68	S68B	F68B
	42	—	P1L42ML400CT-NGB	—	P1L42MC400CT-NGB	74	B74	WP74	S74B	F74B
	54	—	P1L54ML400CT-NGB	—	P1L54MC400CT-NGB	—	—	—	—	—

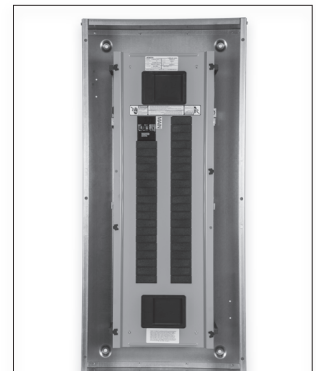

42 circuit with Back-fed Main



54 circuit 400A

© Front included in type 3R/12 Box.

Panelboards

Warehouse Stock – Type P1 Panelboards

Selection

Lug Kits – Main or Feed Thru

Amp Rating	Matl.	Wire Range (includes Neutral)	Service	Original P1 Cat. No.	Next Gen P1 Cat. No.
250	AL	(1) #6 AWG- 350 kcmil (CU or AL)	1 Phase	MLKA1	MLKA1A
			3 Phase	MLKA3	MLKA3A
	CU	(1) #6 AWG- 350 kcmil (CU or AL)	1 Phase	MLKC1	MLKC1A
			3 Phase	MLKC3	MLKC3A
400	AL	(2) 1/0 - 250 kcmil or (1) #2 AWG-600 kcmil	1 Phase	4MLKA1	4MLKA1A
			3 Phase	4MLKA3	4MLKA3A
	CU	(2) 1/0 - 4/0 or (1) 1/0 - 600 kcmil	1 Phase	4MLKC1	4MLKC1A
			3 Phase	4MLKC3	4MLKC3A
400	AL	(1) AL 1/0-750 kcmil (2) AL/CU 250 kcmil max. [max.(1) 600 kcmil CU wire]	1 Phase	–	4MLKA1B
			3 Phase	–	4MLKA3B

Breaker Mounting Kits 250A Max. – Main or Subfeed w/o Breaker

Amp Rating	Breaker Types	Service	Original P1 Cat. No.	Next Gen P1 Cat. No.	
100A	BL, BLH, HBL	1-Phase	MBKBL1	Use Back-fed Main Label Kit # MBKBFA [Ⓢ]	
		3-Phase	MBKBL3		
100A	BQD	1-Phase	–		
		3-Phase	–		
125A	NGB	1-Phase	MBKNB1		
		3-Phase	MBKNB3		
125A	ED4, ED6, HED4, HED6	1-Phase	MBKED1		MBKED1A
		3-Phase	MBKED3		MBKED3A
225A [Ⓢ]	QR2, QRH2, HQR2, HQR2H	1-Phase	MBKQR1		MBKQR1A
		3-Phase	MBKQR3		MBKQR3A
250A	FXD6, FD6, HFD6, HFXD6	1-Phase	MBKFD1	MBKFD1A	
		3-Phase	MBKFD3	MBKFD3A	
400A [Ⓢ]	JXD2, JD6, JXD6, HJD6, HJXD6	1-Phase	MBKJD1	MBKJD1A	
		3-Phase	MBKJD3	MBKJD3A	

Copper Neutral Lug Kits – 250A

No. of Circuits	Description	Original P1 Cat. No.	Next Gen P1 Cat. No.
18	2 or 4 Branch Neutral Strips, 1 Main Neutral Lug, Hardware	CNKL18	Use 30 ckt kit
30		CNKL30	CNLK30A
42		CNKL42	CNLK42A
54, 66		–	CNLK54A

2/0 Neutral Lug Kits – 250A and 400A

No. of Circuits	Description	Original P1 Cat. No.	Next Gen P1 Cat. No.
18	2 or 4 Branch Neutral Strips, Hardware	–	Use 30 ckt kit
30		–	LNLK30A
42		–	LNLK42A
54, 66		–	LNLK54A

200% Neutral Lug Kits/250A

No. of Circuits	Description	Original P1 Cat. No.	Next Gen P1 Cat. No.
18	2 or 4 Branch Neutral Strips, 2 Main Neutral Lugs, Hardware	2NLK18	Use 30 ckt kit
30		2NLK30	2NLK30A
42		2NLK42	2NLK42A
54, 66		–	2NLK54A

200% Neutral Lug Kits/400A

No. of Circuits	Description	Original P1 Cat. No.	Next Gen P1 Cat. No.
18	2 or 4 Branch Neutral Strips, 1 Main 600MCM Neutral Lug, Hardware	42NLK18	Use 30 ckt kit
30		42NLK30	42NLK30A
42		42NLK42	42NLK42A
54, 66		–	42NLK54A



MBKFD3A



Miscellaneous Parts and Accessories

Catalogue Number	Description
BK1	Bonding Kit for 400A max. Original P1 Panels
BK1A	Bonding Kit for 400A max. Next Gen P1 Panels
BK2	Bonding kit for S1/S2 400 & 600
BK3	Bonding kit for S3 Panel
IMK1	Interior Adjusting Kit
9271-1	Directory Card Holder
MCHK	Metal Card Holder Kit
NBK03	Number Strips 1–42. Stick-on type; Use w/ P1 series Panels
NBK04	Number Strips 43–84. Stick-on type; Use w/ P1 series Panels
NBK05	Number Strips 85–126. Stick-on type; Use w/ P1 series Panels
NBK06	Number Strips 127–168. Stick-on type; Use w/ P1 series Panels
EGK	AL Ground Bus 44 Connections
ECGK	CU Ground Bus 44 Connections
IGK	Insulated AL Ground Bus
ICGK	Insulated CU Ground Bus
EWK1	End Wall Kit with Knockouts (20" W x 5.75" DP)
EWK2	End Wall Kit with Knockouts (24" W x 7.75" DP)
P1SCRWS	Package of 42 breaker mounting screws for P1
DFFP1	1" Branch circuit filler plate (suitable for replacing QF3 in P1 thru P5 Panelboards and Switchboards)
P1CONBPHCU [Ⓢ]	Connector kit – 6 pcs. B-phase Copper
P1CONBPHAL [Ⓢ]	Connector kit – 6 pcs. B-phase Aluminum
P1CONACPHCU [Ⓢ]	Connector kit – 6 pcs. A or C-phase Copper
P1CONACPHAL [Ⓢ]	Connector kit – 6 pcs. A or C-phase Aluminum
MBKQRFK	P1/Next Gen P1 Filler for 1PH/3PH QR. Horizontal mount only.
TPS9IKITP1	P1 mounting bracket for SPD TPS3 09

Ⓢ 400 amp kit is for main only – not allowed for subfeed breaker.

Ⓢ MBKBFA kit is available to mount BL/BQD/NGB 2-pole or 3-pole in unit space as a "Back-Fed Main". This occupies branch space and reduces circuit count by 2 or 3 positions. (includes Neutral Lug, "MAIN" label and instructions).

Ⓢ Although QR is rated 250A, it is limited to 225A in panelboard.

Ⓢ Original P1 kits will not work with Next Gen P1 interiors if the chart shows different part numbers for each.

Ⓢ Next Gen P1 kits will not work with Original P1 interiors if the chart shows different part numbers for each.

Ⓢ Replacement parts only.

Ⓢ PDF can be downloaded and printed at this location: <http://www.nema.org/standards/pages/Panelboards.aspx> (ref. Material #11-1056-01)

Panelboards

Warehouse Stock – Type P1 Panelboards

Selection

Main Breaker Mounting Kits with Breakers for P1 Panels (250A and lower can be used as subfeed kits also)

Nex Gen P1 Catalogue No.	Description	Ratings	
		240V	600V
MBKED33100A	Kit w/3-pole ED6 100A breaker	65kA	18kA
MBKED33125A	Kit w/3-pole ED6 125A breaker	65kA	18kA
MBKQR12225A	Kit w/2-pole QR2 225A breaker	10kA	—
MBKQR33150A	Kit w/3-pole QR2 150A breaker	10kA	—
MBKQR33200A	Kit w/3-pole QR2 200A breaker	10kA	—
MBKQR33225A	Kit w/3-pole QR2 225A breaker	10kA	—
MBKFD33200A	Kit w/3-pole FXD6 200A breaker	65kA	22kA
MBKFD33225A	Kit w/3-pole FXD6 225A breaker	65kA	22kA
MBKFD33250A	Kit w/3-pole FXD6 250A breaker	65kA	22kA
MBKHF33250A	Kit with 3-Pole HFD6 250A Breaker	100kA	25kA
MBKJD33400A [Ⓞ]	Kit w/3-pole JXD6 400A breaker	65kA	25kA

NOTE: *Next Gen P1* Kits above only work for interior numbers ending in "T" or "N". Use *Original P1* main connector kits and loose breaker for all others.

GFCI Personnel Protection (5MA)

Breaker Type	Ampere Rating	Catalogue Number	Interrupting Ratings (kA) RMS Symmetrical Amperes		
			Volts AC		
			120	120/240	240
BLF2 1-Pole	15	BF115A BF120A BF130A	10	—	—
	20				
	30				
BLFB 2-Pole	15	BF215A BF220A BF230A BF240A BF250A BF260A	—	10	—
	20				
	30				
	40				
	50				
60					
BLHF2 1-Pole	15	BF115AH BF120AH BF130AH	22	—	—
	20				
	30				
BLHFB 2-Pole	15	BF215AH■ BF220AH BF230AH BF240AH■ BF250AH■ BF260AH	—	22	—
	20				
	30				
	40				
	50				
60					
HBLF2 1-Pole	15	BF115AHH BF120AHH BF130AHH	65	—	—
	20				
	30				



300A Main installed.
These Next Gen P1 kits can now be used as top or bottom feed.

AFCI – Combination Type Arc Fault Circuit Interrupter

Breaker Type	Ampere Rating	Catalogue Number	Interrupting Ratings (kA) RMS Symmetrical Amperes		
			Volts AC		
			120	120/240	240
BAF2 1-pole	15	BA115AFC	10	—	—
	20	BA120AFC	10	—	—
BAFH2 1-pole	15	BA115AFCH	22	—	—
	20	BA120AFCH	22	—	—
HBAF2 1-pole	15	BA115AFCHH	65	—	—
	20	BA120AFCHH	65	—	—
BAF 2-pole	15	B215AFC	—	10	—
	20	B20AFC	—	10	—
BAF2 2-pole	15	B215AFCH	—	22	—
	20	B220AFCH	—	22	—

Dual Function AFCI/GFCI Circuit Breakers

Breaker Type	Ampere Rating	Catalogue Number	Interrupting Ratings (kA) RMS Symmetrical Amperes		
			Volts AC		
			120	120/240	240
BFGA2 1-pole	15	B115DF	10	—	—
	20	B120DF	10	—	—
BFGAH2 1-pole	15	B115DFH	22	—	—
	20	B120DFH	22	—	—
HBFGA2 1-pole	15	B115DFHH	65	—	—
	20	B120DFHH	65	—	—

■ Built to order. Allow 8-10 weeks for delivery.

Ⓞ Kits are for Main only. New "Next Gen P1" kits can be used for either top feed or bottom feed.

Panelboards

Warehouse Stock/Unassembled – Type P1 Panelboards

Selection

Branch Breakers Selection for P1

Selection Guide

1. Select breaker type.
2. Select required amperage.
3. Select number of poles.
4. Select branch breaker catalog numbers.
5. Select ground bar and filler plates.
(See replacement parts & accessories on page 10-12.)

BL Branch Breakers – 10,000A IR^①

Amp Rating	1-Pole 120/240V	2-Pole 120/240V	2-Pole 240V	3-Pole 240V
15	B115	B215	B215R	B315
20	B120	B220	B220R	B320
25	B125	B225	B225R	B325
30	B130	B230	B230R	B330
35	B135	B235	B235R	B335
40	B140	B240	B240R	B340
45	B145	B245	B245R	B345
50	B150	B250	B250R	B350
55	B155	—	—	—
60	B160	B260	—	B360
70	B170	B270	—	B370
80	—	B280	—	B380
90	—	B290	—	B390
100	—	B2100	—	B3100

BLH Branch Breakers – 22,000A IR^①

Amp Rating	1-Pole 120/240V	2-Pole 120/240V	3-Pole 240V
15	B115H	B215H	B315H
20	B120H	B220H	B320H
25	B125H	B225H	B325H
30	B130H	B230H	B330H
35	B135H	B235H	B335H
40	B140H	B240H	B340H
45	B145H	B245H	B345H
50	B150H	B250H	B350H
55	B155H	—	—
60	B160H	B260H	B360H
70	B170H	B270H	B370H
80	—	B280H	B380H
90	—	B290H	B390H
100	—	B2100H	B3100H

HBL Branch Breakers – 65,000A IR^①

Amp Rating	1-Pole 120/240V	2-Pole 120/240V	3-Pole 240V
15	B115HH	B215HH	B315HH
20	B120HH	B220HH	B320HH
30	B130HH	B230HH	B330HH
40	B140HH	B240HH	B340HH
50	B150HH	B250HH	B350HH
60	—	B260HH	B360HH
70	—	B270HH	B370HH
80	—	B280HH	B380HH
90	—	B290HH	B390HH
100	—	B2100HH	B3100HH

BQD Branch Breakers – 14,000A IR Max. @ 480/277 Vac / 65,000A IR max. @ 240 Vac^②

Amp Rating	1-Pole 277V	2-Pole 480Y/277V	3-Pole 480Y/277V
15	BQD115	BQD215	BQD315
20	BQD120	BQD220	BQD320
25	BQD125	BQD225	BQD325
30	BQD130	BQD230	BQD330
35	BQD135	BQD235	BQD335
40	BQD140	BQD240	BQD340
45	BQD145	BQD245	BQD345
50	BQD150	BQD250	BQD350
55	BQD155	BQD255	BQD355
60	BQD160	BQD260	BQD360
70	BQD170	BQD270	BQD370
80	BQD180	BQD280	BQD380
90	BQD190	BQD290	BQD390
100	BQD1100	BQD2100	BQD3100

BQD6 Branch Breakers – 10,000A IR max. @ 600/347 Vac

Ampere Rating	Catalogue Number		
	1-Pole 347V	2-Pole 600Y/347V	3-Pole 600Y/347V
15	BQD6115	BQD6215	BQD6315
20	BQD6120	BQD6220	BQD6320
25	BQD6125	BQD6225	BQD6325
30	BQD6130	BQD6230	BQD6330
35	BQD6135	BQD6235	BQD6335
40	BQD6140	BQD6240	BQD6340
45	BQD6145	BQD6245	BQD6345
50	BQD6150	BQD6250	BQD6350
60	BQD6160	BQD6260	BQD6360
70	BQD6170	BQD6270	BQD6370

NGB Family Branch Breakers

NGB – 14,000A IR Max. @ 600Y/347V AC / 100,000A IR @ 240V AC

Amp Rating	1-pole 347V	2-pole 600Y/347V	3-pole 600Y/347V
15	NGB1B015B	NGB2B015B	NGB3B015B
20	NGB1B020B	NGB2B020B	NGB3B020B
25	NGB1B025B	NGB2B025B	NGB3B025B
30	NGB1B030B	NGB2B030B	NGB3B030B
35	NGB1B035B	NGB2B035B	NGB3B035B
40	NGB1B040B	NGB2B040B	NGB3B040B
45	NGB1B045B	NGB2B045B	NGB3B045B
50	NGB1B050B	NGB2B050B	NGB3B050B
60	NGB1B060B	NGB2B060B	NGB3B060B
70	NGB1B070B	NGB2B070B	NGB3B070B
80	NGB1B080B	NGB2B080B	NGB3B080B
90	NGB1B090B	NGB2B090B	NGB3B090B
100	NGB1B100B	NGB2B100B	NGB3B100B
110	NGB1B110B	NGB2B110B	NGB3B110B
125	NGB1B125B	NGB2B125B	NGB3B125B

■ Built to order. Allow 8-10 weeks for delivery. ① To add shunt trip to BL breakers, see Breaker Accessories.
② To add shunt trip to BQD breakers, see Breaker Accessories.

Panelboards

Panelboard Replacement, Modification, and Additions

Selection

S1/S2 Panels—All the original P1 panel kits for 250 amp and below panels will work for 250 amp maximum S1/S2 panels.

Note: Nex Gen P1 kits will not work with S1/S2

400/600 Amp S1/S2 and All SE Panels

Lug Kits – Main or Feed Thru

Ampere Rating	Material	Wire Range	Service	Catalogue Number
125A/250A	Al/Cu	(2) 1/0–250 kcmil	1-Phase	MLKA1
125A/250A	Al/Cu	(2) 1/0–250 kcmil	3-Phase	MLKA3
400A/600A	Al/Cu	(2) #3/40—250 kcmil or (1) 3/0-500 kcmil	1-Phase	SMLKA1
400A/600A	Al/Cu	(2) #3/40—250 kcmil or (1) 3/0-500 kcmil	3-Phase	SMLKA3

Breaker Mounting Kits

Ampere Rating	Breaker Types	Service	Catalogue Number
125A	ED2, ED4, ED6, HED4, HED6, HHED6	1-Phase	SMBKED1
125A	ED2, ED4, ED6, HED4, HED6, HHED6	3-Phase	SMBKED3
250A	FXD6, FD6, HFXD6, HFD6	1-Phase	SMBKFD1
250A	FXD6, FD6, HFXD6, HFD6	3-Phase	SMBKFD3
400A	JD6, JXD6, HJD6, HJXD6	1-Phase	SMBKJD1
400A	JD6, JXD6, HJD6, HJXD6	3-Phase	SMBKJD3
600A	LD6, LXD6, HLD6, HLXD6	1-Phase	SMBKLD1
600A	LD6, LXD6, HLD6, HLXD6	3-Phase	SMBKLD3

Neutral Kits

Ampere Rating	Description	Catalogue Number
250A max.	30/42 circuit 200% neutral kit	2NLK2
400/600A max.	42 circuit 200% neutral kit	2NLK1

For CDP-7 and S3

Breaker Mounting Kits

Ampere Rating	Breaker Types	Material	Catalogue Number
70A	BQD6	Aluminum	7BQD6-2
70A	BQD6	Copper	7BQD6-2C
100A	BL	Aluminum	7BL-2
100A	BL	Copper	7BL-2C
100A	BQD	Aluminum	7BQ-2
100A	BQD	Copper	7BQ-2C
125A	ED2, ED4, ED6, HED4	Aluminum	7E6-2
125A	ED2, ED4, ED6, HED4	Copper	7E6-2C

For CDP-6, VB-6, SPP-6 and FPP6:

Breaker Mounting Kits

Ampere Rating	Breaker Types	Material	Catalogue Number
100A	BL	Copper	6BL2C
125A	ED2, ED4, ED6, HED4	Copper	6E62C
125A	CED6	Copper	6CLE2C
250A	FD6, FXD6, HFD6	Copper	6F62C
400A	JXD6, JD6, HJD6, SJD6	Copper	6JJ62C

Panelboards

Factory Assembled

Selection

Catalogue Numbering System



Type of Panel P1, P2, P3, S5, F2

Voltage and System*

- | | |
|--|---|
| C = 208Y/120 3Ø 4 W Wye AC - All | R = 415/240 3Ø 4 W Wye AC - All |
| E = 480Y/277 3Ø 4 W Wye AC - All | S = 440/250 3Ø 4 W Wye AC - All |
| D = 240 3Ø 3 W Delta AC - All | L = 600/347 3Ø 4 W Wye AC - All |
| F = 480 3Ø 3 W Delta AC - All | T = 230 3Ø 3 W Delta AC - All |
| G = 600 3Ø 3 W Delta AC - P2, P3, P4, P5 | W = 380 3Ø 3 W Delta AC - P2, P3, P4, P5 |
| I = 347 3Ø 3 W Delta AC P2, P3, P4, P5 | 1 = 24V DC 1-Pole Branch Only - P2, P3, P4, P5 |
| B = 240/120 3Ø 4 W Delta BØ High Leg AC - P2, P3, P4, P5 | 2 = 24V DC 2-Pole Branch Only - P2, P3, P4, P5 |
| Q = 240/120 3Ø 4 W Delta CØ High Leg AC - P2, P3, P4, P5 | 3 = 48V DC 1-Pole Branch Only - P2, P3, P4, P5 |
| A = 120/240 1Ø 3 W Grounded Neutral AC - All | 4 = 48V DC 2-Pole Branch Only - P2, P3, P4, P5 |
| H = 120 1Ø 2 W Grounded Neutral AC - P2, P3, P4, P5 | 5 = 125V DC 1-Pole Branch Only - P2, P3, P4, P5 |
| J = 240 1Ø 2 W No Neutral AC - All | N = 125V DC 2-Pole Branch Only - P2, P3, P4, P5 |
| Y = 125 1Ø 2 W Grounded Neutral AC - P2, P3, P4, P5 | O = 125/250V DC 2-Pole Branch Only - P2, P3, P4, P5 |
| Z = No Longer Available | P = 125/250V DC 2 & 3-Pole Branch - All |
| K = 220/127 3Ø 4 W Wye AC - All | U = 120V AC 3Ø3W - All |
| M = 380/220 3Ø 4 W Wye AC - All | V = 240V 3Ø3W Grounded B Phase - P2, P3, P4, P5 |

*For any voltage system not listed, check with sales for availability.

Circuits or **Enclosure Height**
P1 – 18, 30, 42, 54, 66
P2 – 18, 30, 42, 54, 66, 78, 90
P3 – 18, 30, 42, 54, 66, 78, 90
S5, F2 - 60, 75, 90

Main Lug (ML), Main Breaker
(See Main Breaker Table coding below)

Amperage
100–400A = P1 400–800A = P3
100–600A = P2 400–1200A = S5, F2

Bus Code®	Bus Material	Bus Plating	P1	P2	P3	S5	F2
A	Aluminum	Tin-Plated	•	•	•	•	•
C	Copper	Tin-Plated	optional	optional	optional	n/a	n/a
E	Copper	Silver-Plated	optional	optional	optional	•	•

• Indicates default for this bus type.

Feed Location T = Top B = Bottom

Mounting
S = Surface
F = Flush. Flush trims extend 1 1/2" beyond the base box dimensions on P1, P2 and P3.

Subfeed Space Indicator (for P1 only) T = Subfeed Space Included N[®] = No Subfeed Space

Branch Breaker Type
NONE = BL/BOD type
NGB = NGB type only

Main Breaker Coding

Code	Breaker Type	Code	Breaker Type	Code	Breaker Type	Code	Breaker Type	Code	Breaker Type	Code	Breaker Type	Code	Breaker Type	Code	Breaker Type
BL	BL	H2	HFXD6	J6	JD6	L6	LD6	MD	MD6	ND	ND6	L3	LLK	N8	HNG
BH	BLH	H1	HHFD6	JD	JXD2	LX	LXD6	MX	MXD6	NX	NXD6	J2	NJG	N2	HNX
BR	BLR	H3	HHFXD6	JX	JXD6	LH	LXD6H	MH	MXD6H	NT	NXD6H	J1	NJX	N5	HNY
HB	HBL	G2	HGB	JH	JXD6H	S1	SCLD6	SO	SCMD6	SR	SCND6	J4	NJY	N9	LNG
BQ	BQD	G3	LGB	SC	SCJD6	S2	SHLD6	SQ	SCMD6H	ST	SCND6H	L2	HLK	N3	LNX
B6	BQD6	NB	NGB	SX	SHJD6	SL	SLD6	S5	SHMD6	AD	SHND6	L7	NLK	N6	LNK
CE	CED6	G4	NGB2	SY	SHJD6H	—	—	S6	SHMD6H	SD	SHND6H	M5	HMG	N7	NNG
E4	ED4	G5	HGB2	SJ	SJD6	—	—	SM	SMD6	SN	SND6	M2	HMX	N1	NNX
E6	ED6	G6	LGB2	SH	SJD6H	—	—	AX	SMD6H	AY	SND6H	M8	HMY	N4	NNY
H4	HED4	CJ	CJD6	CL	CLD6	C9	CMD6	CN	CND6	J6	HJG	M6	LMG	QR	QR2
HA	HHED6	6H	HHJD6	HH	HLHD6	CH	CMD6H	C6	CND6H	J7	HJX	M3	LMX	Q4	QRH2
CF	CFD6	H9	HHJXD6	XH	HHLXD6	HM	HMD6	HN	HND6	J5	HJY	M9	LMY	Q5	HQR2
FD	FD6	H6	HJD6	HL	HLD6	HR	HMXD6	HT	HNXD6	J9	LJG	M4	NMG	Q6	HQR2H
FX	FXD6	H5	HJXD6	HO	HLXD6	HS	HMXD6H	HX	HNXD6H	J3	LJX	M1	NMX	Q7	QR2-MCS
HF	HFD6	H7	HJXD6H	HP	HLXD6H	—	—	—	—	J8	LJY	M7	NMY	—	—

® Standard bussing in P1, P2 and P3 panels is tin-plated for aluminum and copper.
® Not available for Next Gen P1 NGB interiors.

Panelboards

Circuit Breaker / Lighting and Distribution

General

Next Gen Type P1

**600Y/ 347 Vac Maximum
400 Ampere Mains
400 Ampere Maximum Branch
Short Circuit Rating –
200,000 A. @ 240 Vac / 100,000 A. @
600Y/347 Vac. IR Maximum
Branch Breaker Symmetrical
Interrupting Capacity**

Based on CSA's Test Procedure

Feed thru and subfeed lugs may result in lower interrupting ratings if not protected by a main device. Consult sales office.

Panelboards

Certified by CSA under file #165172 and listed by Underwriters' Laboratories, Inc., under "Panelboards" File #E2269 for interiors and #E4016 for boxes and fronts.

Service

1-phase 2-wire - 120 Vac, 240 Vac,

1-phase 3-wire - 120/240 Vac,

3-phase 3-wire - 480Y/277 (when derived from 3-phase 4-wire system), 240 Vac, 120 Vac

3-phase 4-wire - 208Y/120 Vac, 480Y/277 Vac, 600Y/347 Vac, 380/220 Vac.

Panelboard Fronts and Doors

Standard panelboards are furnished with trim featuring concealed fasteners and hinges with a flush door lock. All are factory-assembled for ease of installation. Fronts are fabricated from code gauge steel and finished ANSI-61. See page <?> for optional fronts.

Main Breakers

BL, BLH, HBL, NGB, BQD, BQD6, ED4, ED6, HED4, QR2, QRH2, HQR2, HQR2H, FXD6, FD6, HFD6, HFXD6, JXD6, JD6, HJXD6, HJD6. (All main breakers except 400 amp frame are mounted horizontal.)

Note: All Next Gen P1 interiors with BL, BQD or GB Type Mains are Back-fed in unit space (GB Type = NGB).BQD, BQD6

Main Breaker Panel Connectors

Ampere Rating	Connectors Suitable for Cu or Al
100	(1)—#14 1/0 AWG
125	(1)—#4 1/0 AWG
225	(1)—#4 AWG-300 kcmil
250	(1)—#4/0 AWG-350 kcmil Al (1)—#6/0 AWG-350 kcmil Cu
400 ^①	(2)—#3/0 AWG-250 kcmil Al or (1)—#3/0 AWG-500 kcmil Al

Connector ranges indicated do not apply to all main breaker types. Refer to molded case circuit breaker standard pressure wire connector chart (Section 5) for the connector range of a specific frame.

Main Lug Connectors

125	(1)—#6 AWG-350 kcmil
250	(1)—#6 AWG-350 kcmil
400 std.	AL (2) 110-250 kcmil or (1) #2 AWG-600 kcmil
400 opt.	CU (2) 1/0-4/0 or (1) 110-600 kcmil
400 opt.	AL (1) AL 1/0-750 kcmil (2) AL/CU 250 kcmil max. [max. (1) 600 kcmil (1) wire]

Boxes

20" wide, 5.75" deep

- End walls are blank as standard.
- End walls with knockouts will be supplied at no charge on 5.75" deep panels if requested at time of order.

Main Breaker Gutter Dimensions - Inches

Main Breaker	Side Gutter		Neutral Location
	20" w/box	24" w/box	20" w/box
BL, BLH, HBL, BQD, BQD6	8.500	10.5	11.5
NGB	8.000	10	11.5
ED4, ED6, HED4	6.125	8.125	11.5
QR2, QRH2, HQR2, HQR2H	6.500	8.5	11.5
FD6, FXD6, HFD6, HFDX6	5.250	7.25	11.5
JD6 ^② , JXD6 ^②	15.000	15	26.75

Main Lug End Gutter Dimensions - Inches

Amp Rating	End Gutter	Neutral Location
125	10.500	11.5
250	10.500	11.5
400 ^③	25.500	26.75

Side Gutter Wiring Space - Inches

Reference Letter	Panel Width 20"	Panel Width 24" (Optional)
A	6.375	7.375
B	5.500	7.5
C	6.125	8.125
D	6.500	8.5
E ^④	5.250	7.25
F	5.000	7

Branch Breaker Side Gutters

← A →	BL, BLH, HBL	BL, BLH, HBL	← A →
← B →	BLF, BLHF	BLF, BLHF	← B →
← C →	BQD, BQD6	BQD, BQD6	← C →
← D →	ED, ED4, ED6, HED4		← D →
← E →	QJ2, QJH2, QJ2H QR2, QRH2, HQR2, HQR2H		← E →
← F →	FXD6, FD6, HFD6, HFDX6 ^⑤	FXD6, FD6, HFD6, HFDX6 ^⑤	← F →
← F →	NGB	NGB	← F →

Weight — Approximate

Total panelboard weight when filled with a normal quantity of breakers and accessories is:

- About 3 lbs. per inch of box height

Gauge Steel Boxes (Type 1)

Width	Height	Gauge Steel
20"	All	#14

Fronts — Surface, Flush (Type 1)

20"	All	#14
-----	-----	-----

Series Connected Short Circuit Ratings

The term "Series Connected Short Circuit Rating" refers to the application of series connected circuit breakers in a combination that allows some breakers to have lower individual interrupting ratings than the available fault current. This is permitted as long as the series combination has been tested and certified by CSA.

The table below lists specific main and branch breaker series combinations that are marked on all P1 panels. All combinations shown have been tested for use in P1 panelboards and are CSA listed. Other combinations are available. See Circuit Breaker Section, of this book.

These series ratings must be specified on order at time of entry.

① P1 400 amp main breaker panels have wire bending space available for 600 kcmil.

② 400A main breaker is vertical mounted.

③ Feed-thru lug wire bending space is 15.000" (381mm) and neutral wire bending space is 15.880" (413mm) on 400A panel.

④ P1 panel limited to (1) subfeed 250 amperes max.

⑤ See Branch Breaker Side Gutter Chart for Nex Gen P1 Backfed Options.

Panelboards

Circuit Breaker / Lighting and Distribution

Selection

Table P1-3 – Main Breaker Panel Size Selector – Next Gen P1

Max Ampere rating	Main Breaker Types	Connections suitable for Cu or Al	Max # Poles FT ^①	Max # Poles NFT	Dimensions in inches (mm)			Weight in Lbs. (kg)
					Unit Space		Box Height B	
					FT A	NFT A		
100	BL ^② , BLH ^② , HBL ^② , BQD ^② , BQD6 ^②	#8-#6 AWG Cu or Al #8-6 AWG Cu or #8-4 AWG Al #8-#1 AWG Cu or #6-#1/0 AWG Al	–	18	–	9	26 (661)	90 (41)
			18	30	9	15	32 (813)	105 (48)
			30	42	15	21	38 (965)	120 (55)
			42	54	21	27	44 (1118)	135 (61)
			54	66	27	33	50 (1270)	150 (67)
125	NGB ^②	15-30 amp: #14-#6 Cu or #12-#6 Al 35-125 amp: #6-1/0 Cu #4-2/0 Al	–	18	–	9	26 (661)	95 (43)
			18	30	9	15	32 (813)	110 (50)
	ED2, ED4 ED6, HED4	#14-#10 AWG Cu or #12-10 AWG Al #3-3/0 Cu or #1-2/0 Al #3-3/0 Cu or #1-2/0 Al	30	42	15	21	38 (965)	125 (57)
			42	54	21	27	44 (1118)	140 (64)
			54	66	27	33	50 (1270)	155 (71)
225	QR2, QRH2, HQR2, HQR2H	#6 AWG-300 Kcmil (Cu) or #4 AWG-300 Kcmil (Al)	–	18	–	9	26 (661)	95 (43)
			18	30	9	15	32 (813)	110 (50)
			30	42	15	21	38 (965)	125 (57)
			42	54	21	27	44 (1118)	140 (64)
			54	66	27	33	50 (1270)	155 (71)
250	FXD6, FD6, HFD6, HFXD6	#6 AWG-350 Kcmil (Cu) or #4 AWG-350 Kcmil (Al)	–	30	–	15	56 (1423)	172 (78)
			30	42	15	21	62 (1575)	190 (86)
			42	54	21	27	68 (1728)	208 (95)
			54	66	27	33	74 (1880)	226 (104)
			66	–	33	–	56 (1423)	170 (78)
400	JD6, JXD6, HJD6, HJXD6	3/0-500 Kcmil (Cu) or 4/0-500 Kcmil (Al)	–	30	–	15	56 (1423)	172 (78)
			30	42	15	21	62 (1575)	190 (86)
			42	54	21	27	68 (1728)	208 (95)
			54	66	27	33	74 (1880)	226 (104)
			66	–	33	–	56 (1423)	170 (78)



Note: Main breakers use breaker connectors. For sizes, see breaker connector chart. 400A MLO Panels have wire bend space for 600kcmil CU & AL wire when using standard lugs. With optional 750kcmil AL/CU connectors, wire bend space is available for up to 750kcmil AL wire, but is still limited to 600kcmil CU wire.

Table P1-4 – Main Breaker Selection

Ampere Rating	Breaker Types	Max. Ir (kA) at			Main Breaker Code	Additional Trip Values
		240 AC	480/277V AC	600Y/347V		
70	BQD6	65	–	10	B6	15, 20, 25, 30, 35, 40, 45, 50, 60, 70
100	BL (STD)	10	14	–	BL	15, 20, 25, 30, 35, 40, 45, 50, 60, 70, 80, 90, 100
	BLH	22	–	–	BH	15, 20, 25, 30, 35, 40, 45, 50, 60, 70, 80, 90, 100
	HBL	65	–	–	HB	15, 20, 25, 30, 35, 40, 45, 50, 60, 70, 80, 90, 100
	BQD	65	–	–	BQ	15, 20, 25, 30, 35, 40, 45, 50, 60, 70, 80, 90, 100
125	NGB (STD)	100	25	14	NB ^③	50, 60, 70, 80, 90, 100, 110, 125
	ED6 (STD)	65	25	18	E4	50, 60, 70, 80, 90, 100, 110, 125
	HED4	42	42	–	H4	50, 60, 70, 80, 90, 100, 110, 125
225	QR2	10	–	–	QR	100, 110, 125, 150, 175, 200, 225
	QRH2	25	–	–	Q4	100, 110, 125, 150, 175, 200, 225
	HQR2	65	–	–	Q5	100, 110, 125, 150, 175, 200, 225
	HQR2H	100	–	–	Q6	100, 110, 125, 150, 175, 200, 225
250	FXD6 (STD)	65	35	22	FX	70, 80, 90, 100, 110, 125, 150, 175, 200, 225, 250
	FD6	65	35	22	FD	70, 80, 90, 100, 110, 125, 150, 175, 200, 225, 250
	HFD6	100	65	25	HF	70, 80, 90, 100, 150, 175, 200, 225, 250
	HFXD6	100	65	25	H2	70, 80, 90, 100, 110, 125, 150, 175, 200, 225, 250
400	JXD2	65	–	–	JD	300, 400
	JXD6 (STD)	65	35	25	JX	200, 225, 250, 300, 350, 400
	JD6	65	35	25	J6	200, 225, 250, 300, 350, 400
	HJD6	100	65	35	H6	200, 225, 250, 300, 350, 400
	HJXD6	100	65	35	H5	200, 225, 250, 300, 350, 400

① 400A 66 circuit only available with non-feed thru versions.

② BL, BLH, HBL, BQD, BQD6, and xGB mount in unit space and count in max. # of poles.

③ xGB interiors are not available as non-feed-thru without sub-feed space.

Panelboards

Circuit Breaker / Lighting and Distribution

Selection

Table P1-5 - Main Lug Panel Size Selector - Next Gen P1

Maximum Ampere rating	Max # Poles FT	Max # Poles NFT	Dimensions in inches (mm)				Weight in Lbs. (kg)	MLO Connectors Suitable for
			Unit Space		Box Height B"			
			FT A	NFT A				
125 (or) 250	18	30	9	15	26 (661)	90 (41)	(1) #6 AWG - 350 kcmil (CU or AL)	
	30	42	15	21	32 (813)	105 (48)		
	42	54	21	27	44 (1118)	135 (61)		
	54	66	27	33	50 (1270)	150 (67)		
	66	-	33	-	56 (1423)	165 (73)		
400	-	30	-	15	56 (1423)	120 (55)	AL (2) 1/0 - 250 kcmil or (1) #2 AWG - 600 kcmil CU (2) 1/0 - 4/0 or (1) #2 AWG - 600 kcmil	
	30	42	15	21	62 (1575)	135 (61)		
	42	54	21	27	68 (1728)	150 (68)		
	54	66	27	33	74 (1880)	165 (75)		

Table P1-6 – Branch Circuit Breakers

Max. Amp Rating	Breaker Type	Number of Poles	Max. Interrupting Rating (kA)							Available Trip Values	Connections Suitable for Cu or Al	
			120V	120/240V	240V	277V	480/277V	347V	600Y/347V			
70	BQD6	1	-	65	-	-	-	-	10	-	15, 20, 25, 30, 35, 40, 50, 60, 70	15-40A #14-#6 AWG Cu #12-#6 AWG Al 45-70A #8-#1 AWG Cu #6-#1/0 AWG Al
		2	-	65	-	-	-	-	10	15, 20, 25, 30, 35, 40, 50, 60, 70		
		3	-	-	65	-	-	-	-	10	15, 20, 25, 30, 35, 40, 50, 60, 70	
100	BL	1	10	-	-	-	-	-	-	-	15, 20, 25, 30, 35, 40, 45, 50, 55, 60, 70	15-20A #14-#10 AWG Cu #12-#10 AWG Al 25-35A #8-#6 AWG Cu #8-#6 AWG Al 40-50A #8-#6 AWG Cu #8-#4 AWG Al 55-70A #8-#4 AWG Cu #8-#2 AWG Al 80-100A #4-#1/0 AWG Cu #2-#1/0 AWG Al
		2	-	10	-	-	-	-	-	-	15, 20, 25, 30, 35, 40, 50, 60, 70, 80, 90, 100	
		3	-	-	10	-	-	-	-	-	15, 20, 25, 30, 35, 40, 50, 60, 70, 80, 90, 100	
	BLR	2	-	-	10	-	-	-	-	-	15, 20, 30, 40, 50, 60, 70, 90, 100	
		2	10	-	-	-	-	-	-	-	15, 20, 30	
	BLH	1	-	22	-	-	-	-	-	-	15, 20, 30, 40, 50, 55, 60, 70	
		2	-	22	-	-	-	-	-	-	15, 20, 30, 40, 50, 60, 70, 90, 100	
		3	-	-	22	-	-	-	-	-	15, 20, 30, 40, 50, 60, 70, 80, 90, 100	
	HBL	1	-	65	-	-	-	-	-	-	15, 20, 30, 40, 50	
		2	-	65	-	-	-	-	-	-	15, 20, 30, 40, 50, 60, 70	
		3	-	-	65	-	-	-	-	-	15, 20, 30, 40, 50, 60, 70, 80, 90, 100	
	BLF2	1	10	-	-	-	-	-	-	-	15, 20, 30	
		2	-	10	-	-	-	-	-	-	15, 20, 30, 40, 50, 60	
	BLHF2	1	22	-	-	-	-	-	-	-	15, 20, 30	
		2	-	22	-	-	-	-	-	-	15, 20, 30, 40, 50, 60	
HBLF2	1	65	-	-	-	-	-	-	-	15, 20, 30		
BLE	1	10	-	-	-	-	-	-	-	15, 20, 30		
	2	-	10	-	-	-	-	-	-	15, 20, 30, 40, 50, 60		
BLEH	1	22	-	-	-	-	-	-	-	15, 20, 30		
	2	-	22	-	-	-	-	-	-	15, 20, 30, 40, 50, 60		
BAF	1	10	-	-	-	-	-	-	-	15, 20		
BAFH	1	22	-	-	-	-	-	-	-	15, 20		
BQD	1	-	65	-	14	-	-	-	-	15, 20, 25, 30, 35, 40, 50, 60, 70, 80, 90, 100	15-40A #14-#6 AWG Cu #12-#6 AWG Al 45-100A #8-#1 AWG Cu #6-#1/0 AWG Al	
	2	-	65	-	-	14	-	-	-	15, 20, 25, 30, 35, 40, 50, 60, 70, 80, 90, 100		
	3	-	-	65	-	14	-	-	-	15, 20, 25, 30, 35, 40, 50, 60, 70, 80, 90, 100		
125	NGB ^{②③}	1	100	-	-	25	-	14	-	15, 20, 25, 30, 35, 40, 50, 60, 70, 80, 90, 100, 125 ^③	15-30A #14-#6 Cu #12-#6 Al 35-125 #6-1/0 Cu #4-2/0 Al	
		2	-	100	100	-	25	-	14	15, 20, 25, 30, 35, 40, 50, 60, 70, 80, 90, 100, 125 ^③		
		3	-	100	100	-	25	-	14	15, 20, 25, 30, 35, 40, 50, 60, 70, 80, 90, 100, 125 ^③		

① Two-pole breaker is one phase and neutral. Three-pole is two phases and neutral.

② P1 panel with NGB branch devices will not accept BL or BQD frames in the same panel as branch devices.

③ The New Next Gen P1 (18 circuit 250A only) is limited to 100A per connection (200A per pair) when installing Branch Breakers across from one another.

All other configurations allow 125A per connection max. (250A per pair max.)

NOTE: BL, HBL and BQD breakers are mounted in common mountings in 3" or (6) pole increments.

Panelboards

Circuit Breaker / Lighting and Distribution

Dimensions

Table P1-7 – Subfeed Breakers

Breaker Type	Number of Poles	Max. Interrupting Rating (kA)			Available Trip Values
		240V	480Y/277V	600Y/347V	
QR2	2, 3	10	–	–	100, 110, 125, 150, 175, 200, 225
QRH2	2, 3	25	–	–	100, 110, 125, 150, 175, 200, 225
HQR2	2, 3	65	–	–	100, 110, 125, 150, 175, 200, 225
HQR2H	2, 3	100	–	–	100, 110, 125, 150, 175, 200, 225
ED6	2, 3	65	18	18	15, 20, 25, 30, 35, 40, 45, 50, 55, 60, 70, 80, 90, 100, 110, 125
HED4	2, 3	100	42	–	15, 20, 25, 30, 35, 40, 45, 50, 55, 60, 70, 80, 90, 100, 110, 125
FXD6	2, 3	65	35	22	70, 80, 90, 100, 110, 125, 150, 175, 200, 225, 250
FD6	2, 3	65	35	22	70, 80, 90, 100, 110, 125, 150, 175, 200, 225, 250
HFD6	2, 3	100	65	22	70, 80, 90, 100, 110, 125, 150, 175, 200, 225, 250
HFXD6	2, 3	100	65	25	70, 80, 90, 100, 110, 125, 150, 175, 200, 225, 250

**Table P1-8 – Breaker Mounting Kit
Main or Subfeed Strap Kit w/o Breaker**

Amp Rating	Breaker Types	Service	Original P1 Cat. No.	Next Gen P1 Cat. No.
100A	BL, BLH, HBL	1-Phase	MBKBL1	Use Back-fed Main Label Kit # MBKBFA [®]
		3-Phase	MBKBL3	
100A	BQD	1-Phase	–	
		3-Phase	–	
125A	NGB	1-Phase	MBKNB1	
		3-Phase	MBKNB3	
125A	ED4, ED6, HED4, HED6	1-Phase	MBKED1	MBKED1A
		3-Phase	MBKED3	MBKED3A
225A [®]	QR2, QRH2, HQR2, HQR2H	1-Phase	MBKQR1	MBKQR1A
		3-Phase	MBKQR3	MBKQR3A
250A	FXD6, FD6, HFD, HFXD6	1-Phase	MBKFD1	MBKFD1A
		3-Phase	MBKFD3	MBKFD3A
400A ^①	JXD6, JD6, HJD6, HJXD6	1-Phase	MBKJD1	MBKJD1A
		3-Phase	MBKJD3	MBKJD3A

① 400 amp kit is for main—only, not allowed for subfeed breaker.
 ② MBKBFA kit is available to mount BL/BQD/NGB 2-pole or 3-pole in unit space as a "Back-Fed Main". This occupies branch space and reduces circuit count by 2 or 3 positions. (includes Neutral Lug, "MAIN" label and instructions).
 ③ Although QR is rated 250A, it is limited to 225A in panelboard.

Table P1-9 – Lug Kits (Main or Feed-Thru)

Amp Rating	Matl.	Wire Range (includes Neutral)	Service	Original Catalogue Number	Nex Gen P1 Catalogue Number
250	AL	(1) #6 AWG-350 kcmil (CU or AL)	1 Phase	MLKA1	MLKA1A
			3 Phase	MLKA3	MLKA3A
	CU	(1) #6 AWG-350 kcmil (CU or AL)	1 Phase	MLKC1	MLKC1A
			3 Phase	MLKC3	MLKC3A
400	AL	(2) 1/0 - 250 kcmil or (1) #2 AWG-600 kcmil	1 Phase	4MLKA1	4MLKA1A
			3 Phase	4MLKA3	4MLKA3A
	CU	(2) 1/0 - 4/0 or (1) 1/0 - 600 kcmil	1 Phase	4MLKC1	4MLKC1A
			3 Phase	4MLKC3	4MLKC3A
400	AL	(1) AL 1/0-750 kcmil (2) AL/CU 250kcmil max. [max.(1) 600 kcmil CU wire]	1 Phase	–	4MLKA1B
			3 Phase	–	4MLKA3B

NOTES:
 ① Original P1 kits will not work with Next Gen P1 interiors if the chart shows different part numbers for each.
 ② Next Gen P1 kits will not work with Original P1 interiors if the chart shows different part numbers for each.

Table P1-10 – Copper Neutral Lug Kits – 250A

No. of Circuits	Description	Original P1 Catalogue Number	Nex Gen P1 Catalogue Number
18	2 or 4 Branch Neutral Strips, 1 Main Neutral Lug, Hardware	CNLK18	Use 30 ckt kit
30		CNLK30	CNLK30A
42		CNLK42	CNLK42A
54, 66		–	CNLK54A

Table P1-10A – 2/0 Neutral Lug Kits – 250A and 400A

No. of Circuits	Description	Original P1 Catalogue Number	Nex Gen P1 Catalogue Number
18	2 or 4 Branch Neutral Strips, Hardware	–	Use 30 ckt kit
30		–	LNLK30A
42		–	LNLK42A
54, 66		–	LNLK54A

Table P1-11 – 200% Neutral Lug Kits – 250A

No. of Circuits	Description	Original P1 Catalogue Number	Nex Gen P1 Catalogue Number
18	2 or 4 Branch Neutral Strips, 2 Main Neutral Lugs, Hardware	2NLK18	Use 30 ckt kit
30		2NLK30	2NLK30A
42		2NLK42	2NLK42A
54, 66		–	2NLK54A

Table P1-12 – 200% Neutral Lug Kits – 400A

No. of Circuits	Description	Original P1 Catalogue Number	Nex Gen P1 Catalogue Number
18	2 or 4 Branch Neutral Strips, 1 Main 600 kcmil Neutral Lug, Hardware	42NLK18	N/A
30		42NLK30	42NLK30A
42		42NLK42	42NLK42A
54, 66		–	42NLK54A

Panelboards

Type P1 Panelboards

General

Table P1-13 – Main Breaker Gutter Dimensions Inches (mm)

Main Breaker	Max. Interrupting Rating (kA)		Neutral Location
	20" wide box	24" wide box	20" wide box
BL, BLH, HBL, BQD, BQD6 ^②	8.500 (216) ^③	10.500 (267) ^③	10.500 (267)
NGB	8.000 (203) ^③	10.000 (254) ^③	10.500 (267)
ED2, ED4, ED6, HED4	6.125 (156)	8.125 (206)	10.500 (267)
QR2, QRH2, HQR2, HQR2H	6.500 (165)	8.500 (216)	10.500 (267)
FD6, FXD6, HFD6, HFXD6	5.250 (133)	7.250 (184)	10.500 (267)
JD6, JXD6 ^①	15.000 (381)	15.000 (381)	26.500 (674)

^① JD frame mounted vertically.

^② For Next Gen P1, use Side Gutter Wiring Specs Table P1-15. These are back-fed main breakers.

^③ These dimensions are for Original P1 as a reference only, not for Nex Gen P1.

Table P1-14 – Main Lug End Gutter Dimensions Inches (mm)

Amp Rating	End Gutter		Neutral Location	
	20" wide box	24" wide box	20" wide box	24" wide box
125	9.500 (242)	9.500 (242)	10.500 (267)	10.500 (267)
250	9.500 (242)	9.500 (242)	10.500 (267)	10.500 (267)
400	25.500 (648)	25.500 (648)	26.750 (680)	26.750 (680)

NOTE: Feed-thru lug and neutral wire bending space is 15.000" and 16.250" respectively on 400A panel.

Table P1-15 – Side Gutter Wiring Space Inches (mm) (Fig P1-1)

Reference Letter	Panel Width 20"	Panel Width 24" Optional
A ^②	6.375 (167)	8.375 (213)
B ^②	5.500 (140)	7.500 (191)
C ^②	5.000 (127)	7.000 (178)
D	6.125 (156)	8.125 (206)
E	6.500 (165)	8.500 (216)
F	5.250 (133)	7.250 (184)

^① Subfeed mounting limit per panel.

^② For all Nex Gen P1 panels using BL/BQD or xGB breakers as mains in back-fed position, use this chart for wiring space.

Fig P1-1

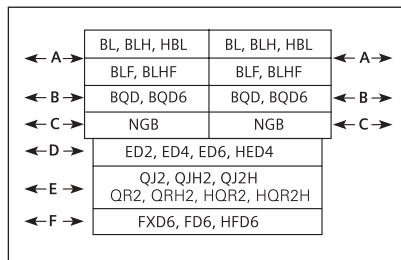

Panel Width
20 in. (508 mm)

Miscellaneous Parts and Accessories

Catalogue No.	Description
BK1	Bonding Kit for 400A max. Original P1 Panels
BK1A	Bonding Kit for 400A max. Next Gen P1 Panels
BK2	Bonding kit for S1/S2 400 & 600
BK3	Bonding kit
IMK1	Interior Adjusting Kit
9271-1	Directory Card Holder
MCHK	Metal Card Holder Kit
NBK03	Number Strips 1–42. Stick-on type; Use w/ P1 series Panels
NBK04	Number Strips 43–84. Stick-on type; Use w/ P1 series Panels
NBK05	Number Strips 85–126. Stick-on type; Use w/ P1 series Panels
NBK06	Number Strips 127–168. Stick-on type; Use w/ P1 series Panels
EGK	AL Ground Bus 44 Connections
ECGK	CU Ground Bus 44 Connections
IGK	Insulated AL Ground Bus
ICGK	Insulated CU Ground Bus
EWK1	End Wall Kit with Knockouts (20" W x 5.75" DP)
P1SCRWS	Package of 42 breaker mounting screws for P1
DFFP1	1" Branch circuit filler plate (suitable for replacing QF3 in P1 thru P5 Panelboards and Switchboards)
P1CONBPHCU ^①	Connector kit – 6 pcs. B-phase Copper
P1CONBPHAL ^①	Connector kit – 6 pcs. B-phase Aluminum
P1CONACPHCU ^①	Connector kit – 6 pcs. A or C-phase Copper
P1CONACPHAL ^①	Connector kit – 6 pcs. A or C-phase Aluminum
MBKQRFK	P1/Next Gen P1 Filler for 1PH/3PH QR. Horizontal mount only.
TPS9IKITP1	P1 mounting bracket for SPD TPS3 09

^① Replacement parts only.

Table P1-18 – Standard Enclosures

Box Height (in.)	Catalogue Number				
	Type 1 Standard Trim			Type 3R ^②	Type 3R/12 ^②
	Box ^③	Surface ^④	Flush ^⑤		
26	B26	S26B	F26B	NR26	WP26
32	B32	S32B	F32B	NR32	WP32
38	B38	S38B	F38B	NR38	WP38
44	B44	S44B	F44B	NR44	WP44
50	B50	S50B	F50B	NR50	WP50
56	B56	S56B	F56B	NR56	WP56
62	B62	S62B	F62B	NR62	WP62
68	B68	S68B	F68B	NR68	WP68
74	B74	S74B	F74B	NR74	WP74

^① 16 GA std., Optional 14 GA & 12 GA Enclosures only.

^② 14 Gauge Steel only.

^③ 16 Gauge Can w/ 14 Gauge Front.



Feed-Thru (FT)



Non-Feed-Thru (NFT)



Example of Back-fed NGB Main breaker installed

Panelboards

Type P1 Panelboard Modifications and Additions

Selection

Panel Options

Enclosures

- Extra gutter to sides or ends of the can
- 24" wide boxes
- Hinged trims
- Door-in-door trims
- Screw to the box trims
- Piano hinge trims
- Painted boxes
- Custom colors
- Stainless steel trims and boxes
- Type 1 enclosures (Std 16 Gage)
- Type 3R/12 enclosures 16 Gauge Can w/ 14 Gauge front)
- Type 4 enclosures (14 Gauge only)
- Type 4X enclosures (14 Gauge only - 304SS Std, 316SS Optional)
- Panel skirts
- Gaskets between trim and box

Surge Protection Devices

- TPS3 02
 - Bus connected
 - Internally mounted (30A breaker required to feed SPD)
 - Externally mounted in a 15" high aux. enclosure (30A breaker required to feed SPD)
- TPS3 09
 - Internally mounted (20A breaker required to feed SPD)
 - Externally mounted (20A breaker required to feed SPD)
- TPS3 12
 - Externally mounted (40A breaker required to feed SPD)

Panel Modifications

Enclosures

- Main Bus
Standard main bus is tin-plated aluminum. For copper main bus, add from the table for each panel. Includes copper neutral cross bar. For copper neutral branch lugs, see miscellaneous.
- Compression lug for MLO[Ⓞ]
- Contactor mains - Mount in 23" enclosure ahead of panel.
 - Asco 920 through 225 amps[Ⓞ]
 - Asco 911 through 150 amps[Ⓞ]
 - Siemens LEN through 30 amps[Ⓞ]
- Branch and main breaker accessories
 - Handle blocks
 - Handle locks
- Feed-thru lugs[Ⓞ]
Cannot be used in conjunction with SPD/TVSS or subfeed breakers. Do not add height to the panel.

- Copper lugs, mechanical line and branch neutral[Ⓞ]
- Bus mounted SPD/TVSS[Ⓞ]
- Grounding of Panelboards
Ground Bars except for brazed to box are shipped with the panel interior factory mounted.
 - Non-Insulated Equipment Ground Bar – Standard
 - Copper Non-Insulated Ground Bar
 - AL Insulated Equipment Ground Bar
 - CU Insulated Equipment Ground Bar
- Shunt Trip on Main or Branch
BL[Ⓞ], BLH[Ⓞ], HBL[Ⓞ], BQD[Ⓞ], NGB[Ⓞ] as branch use
1" unit space for shunt trip.

QR2, QRH2, HQR2, HQR2H, ED2, ED4, ED6,
HED4, FD6, FXD6, HFD6
HFXD6, JXD6, JD6, HJD6, HJXD6

Feed-thru Lugs Amp Rating	Type	Connector CU/AL Range
250	AL/CU Mechanical	(1)-#6 AWG-350 kcmil
	CU Mechanical	(1)-#6 AWG-350 kcmil
	AL/CU Compression	(1)-#6 AWG-350 kcmil
400	AL/CU AWG Mechanical	(2)-#1/0 - 250 kcmil or
		(1)-#2 AWG-600 kcmil
	CU	(1)-1/0-600 kcmil (2)-1/0-4/0
	AL/CU Compression	(1) 400-600 kcmil AL (1) 400-500 kcmil CU

- 200% neutral[Ⓞ]

NOTE: Specify copper or aluminum cable.

[Ⓞ] Do not increase panel or enclosure size.

[Ⓞ] Accessories on 1" pole breakers (BL, BQD, xGB, ED) will take 1" unit space.

[Ⓞ] External to the panel, supplied in a separate enclosure.

Panelboards

Type P1 Panelboard Modifications and Additions

Reference

Compression Lugs

Table P1-19 – Lugs

Style	Amp Rating	Breaker Type	Compression Connectors	Box Height Addition
MLO	125	N/A	(1) #6 AWG - 350 kcmil	None
	250			
	400	N/A	(1) 400 - 600 kcmil AL (1) 400 - 500 kcmil CU	None
Main Breaker	125	ED4, ED6, HED4	(1) #14 AWG - 2/0	Box must go to 24" wide
	225	QR2, QRH2, HQR2, HQR2H	(1) #6 AWG - 350 kcmil CU or AL	Box must go to 24" wide for All breakers
	250	FXD6, HFD6	(1) #6 AWG - 350 kcmil CU or AL	Box must go to 24" wide for All breakers

NOTE: Standard compression lugs used for P1 panels are range taking lugs and require a particular crimping tool (tool is Hubbell/Anderson Versa Crimp VC6 -for 250A) to accommodate the range. Consult factory for information. 200% neutral not available with compression lugs. xGB breakers cannot accommodate compression lugs. (For 400A tool use Hubbell/Anderson Versa Crimp VC6FT/VC7FT - see instruction sheet for details.)

Enclosure Modifications

Type-4–Water Tight, Dust Tight, Steel Enclosure

(Actual Type-4 enclosure is larger than standard Type 1 enclosure. See chart below for reference to approximate actual size.)

Table P1-20

Standard Box Height (in inches)	Actual NEMA 4 Enclosure Size		
	H	W	D
32	32	20	8
38	42	30	8
44	48	36	8
56	60	36	10

NOTE: Larger Type 4 enclosures are not available.

Remote Switch Modifications

Table P1-22 – Control Power Transformer

Size	VA Relay
0, 1	50
2	75
3	150
4	250

Table P1-24 – Remote Control Switch Modification

Description
Auxiliary Contacts (mounted, not wired)
2-Wire Control

Type-4X For Type P1

Water Tight, Dust Tight and Corrosion Resistant (consult plant to verify actual enclosure size)

Table P1-21

Catalogue Number	Enclosure – Stainless Steel Size (inches) (304SS is standard)		
	H	W	D
B4X26	26	20	5.75
B4X32	32	20	5.75
B4X38	38	20	5.75
B4X44	44	20	5.75
B4X50	50	20	5.75
B4X56	56	20	5.75
B4X62	62	20	5.75
B4X68	68	20	5.75
B4X74	74	20	5.75

NOTE: 316SS is available as an option – must be specified.

Table P1-23 – Applications for a Remote Switch

Switch Type	Modification
920	Mounts in 23" relay cabinet as a main only
LEN	30A mounts in 23" relay cabinet as a main only

Gauge Steel of Boxes/Fronts, Surface and Flush

Dimensions in Inches (mm)		Gauge Steel		
H	W	Box	Front/Door	Type
26-74 (660-1880)	20 (508)	16 ^①	14 ^③	Type 1
26-74 (660-1880)	20 (508)	16 ^②	16/14 ^②	Type 3R/12
32-60 (813-1524)	20-36 (508-914)	14 ^③	14 ^③	Type 4
26-74 (660-1879)	20 (508)	14 ^④	14 ^④	Type 4X
36-60 (914-1524)	30-36 (762-914)	N/A ^⑤	N/A ^⑤	Type 4X Non-Metallic

① 16 Gauge is Standard (14 Gauge & 12 Gauge are optional)

② 15 Gauge Steel Can with 14 Gauge Door or Similar Approved Construction

③ No Optional Gauge available

④ 304SS 14 Gauge Std., 316SS 14 Gauge optional

⑤ Sizes do not match Standard Enclosure Sizes - See Table P1-21 - material is non-metallic - No Gauge Specified.

Panelboards

Type P1 Enclosure Details

Dimensions

Type 1 Box

Box is symmetrical

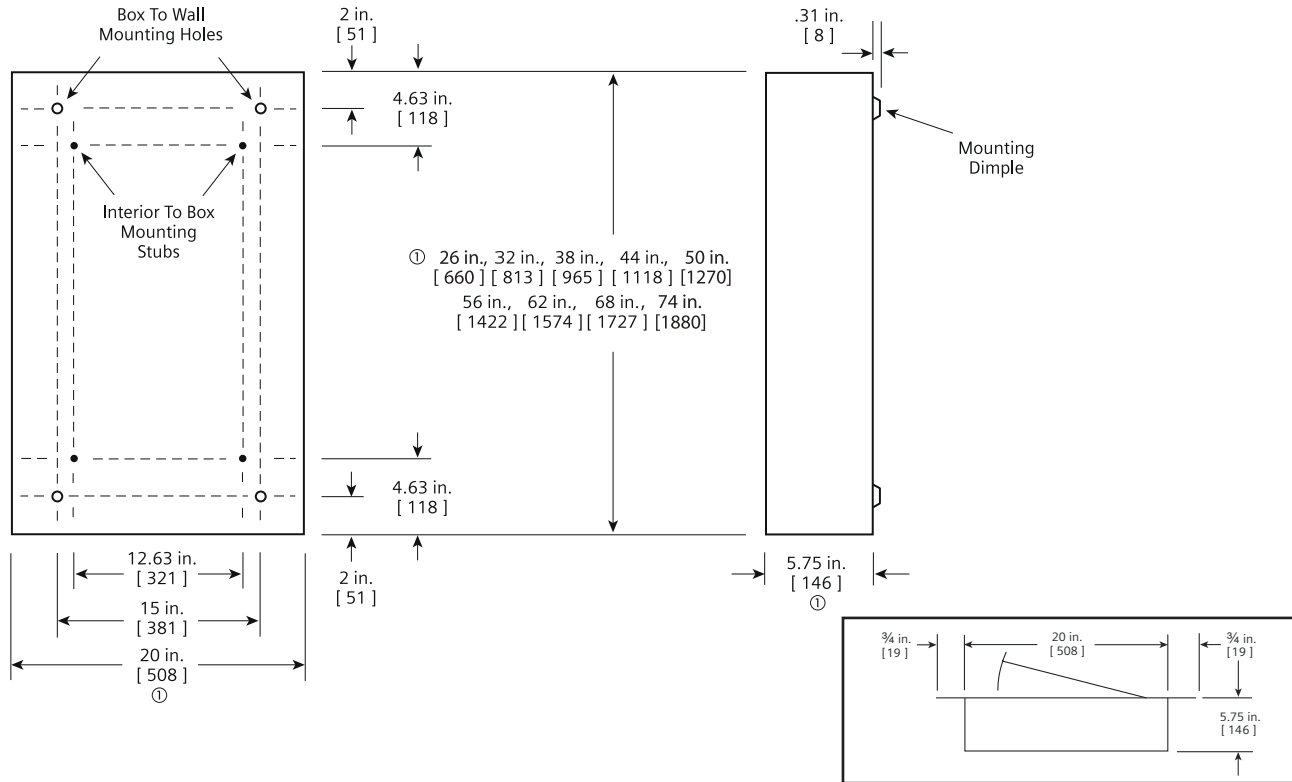

Flush Mounting

Type 3R and 3R/12 Box

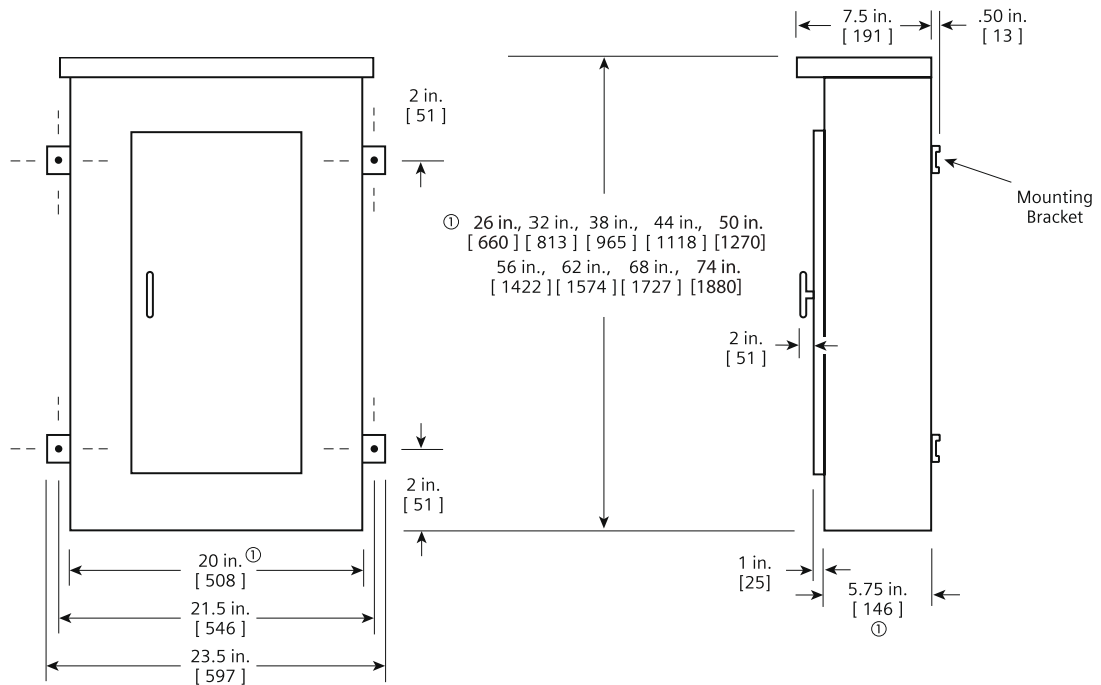

Ⓢ Dimensions are interior of the box. Add 5/8" to width for absolute dimension. Add 1/8" to height for absolute dimension.

Dimensions shown in inches and millimeters [].

Panelboards

Type P2 Panelboards

General

Features

Flexibility is the hallmark of the P2 panel. This panel offers a wide array of factory-assembled options to meet almost all lighting panel applications. With this design, the ability to mix breaker frames in unit space up to 250 amps will also meet many distribution panel requirements in a much smaller package. Bussing options for the P2 vary from aluminum to copper. Standard bussing in the P2 panel is tin-plated. Silver-plated copper is also offered as an option. Subfeed lugs (up to 400 amp) are just a few of the options of this unique panel.

Like a lighting panel, P2 is set up around 18, 30, 42, 54, 66, 78, and 90 circuit configurations. It will also allow the user to configure the panel to the smallest possible size. The P2 panel starts with 9" of unit space (18 circuits of 1" pole breakers). Breakers mounted in unit space can be mixed and matched to meet customer requirements. All 1" pole breakers (BL, BQD, ED frames) are mounted in 3" or 6" pole increments. Breaker frames, above 125 amps, are mounted in 6" single breaker mountings. As an example of a minimum panel, (6) 20 amp 1-pole BL breakers (3" of unit space) and a 3-pole 225 amp QR breaker (6" of unit space) equaling 9" of unit space can be configured in a P2 panel

without any extra provisions or space required. FD 250 amp and JD 400 amp breakers are mounted as subfeed breakers outside of unit space.

Another unique feature of the P2 panel is that blank unit space can be added to allow for future expansions or modifications. Any expansions or modifications must be in 3" increments. BL, BQD, and ED frame breakers have 3" or 6" pole kits, and can be mixed in unit space by these increments. Breakers of the same frame can cross from one mounting to another if contiguous. QR frame breakers are mounted in 6" increments for two- and three pole, single mounted units. Changes in the unit space length for BL, BQD, or ED frame breakers require an addition deadfront, center strip kit. Check with sales or the factory for additional unit space kits.

Main Lug / Main Breaker

Enclosure – Standard Type 1 enclosure is 20" wide x 5.75" deep. Box Height is determined by main device and unit space. See charts for box height.

Voltage – 600V AC max.
250V DC max.

Amperage – 600 amp max.

Short circuit rating – 200 KAIC max. symmetrical or equal to the lowest rated device installed unless a series rating is indicated. Panels with subfeed or feed-thru lugs without a main device, circuit breaker or fusible unit, are limited to a three-cycle rating. The three-cycle rating for the P2 panel is limited to 22 KAIC. Note that the main device may be mounted remote from the panel.

Bussing – The P2 panel has more options to meet market requirements. The standard bussing is temperature rated aluminum. The rating is per the requirements of CSA C22.2 No.29 – the standard for panelboards. All aluminum bussing is tin-plated. Optional bussing for the P2 panel is copper. The copper bus option for this panel is tin-plated as standard or silver.

Weight – Approximate

Total panelboard weight when filled with a normal quantity of breakers and accessories is about 3 lbs. (1 kg) per inch (54g per mm) of box height.

Gauge Steel of Boxes/Fronts, Surface and Flush

Dimensions in Inches (mm)		Gauge Steel		
Width	Height	Box	Front/Door	Type
20 (508)	26-74 (660-1880)	14	14	Type 1
20 (508)	26-74 (660-1880)	16 ^②	16/14 ^②	Type 3R/12
20-36 (508-914)	32-60 (813-1524)	14	14	Type 4
20 (508)	26-74 (660-1879)	14 ^③	14 ^③	Type 4X

① 16 Gauge is Standard (14 Gauge & 12 Gauge are optional)
 ② 15 Gauge Steel Can with 14 Gauge Door or Similar Approved Construction
 ③ 304SS 14 Gauge Std., 316SS 14 Gauge optional

Panelboards

Distributor Stock - Type P2 Main Lug Only

Reference

Interior Numbering System

Type P2 unassembled panelboards are available as main lug only and come with provisions for the branch breaker type selected.

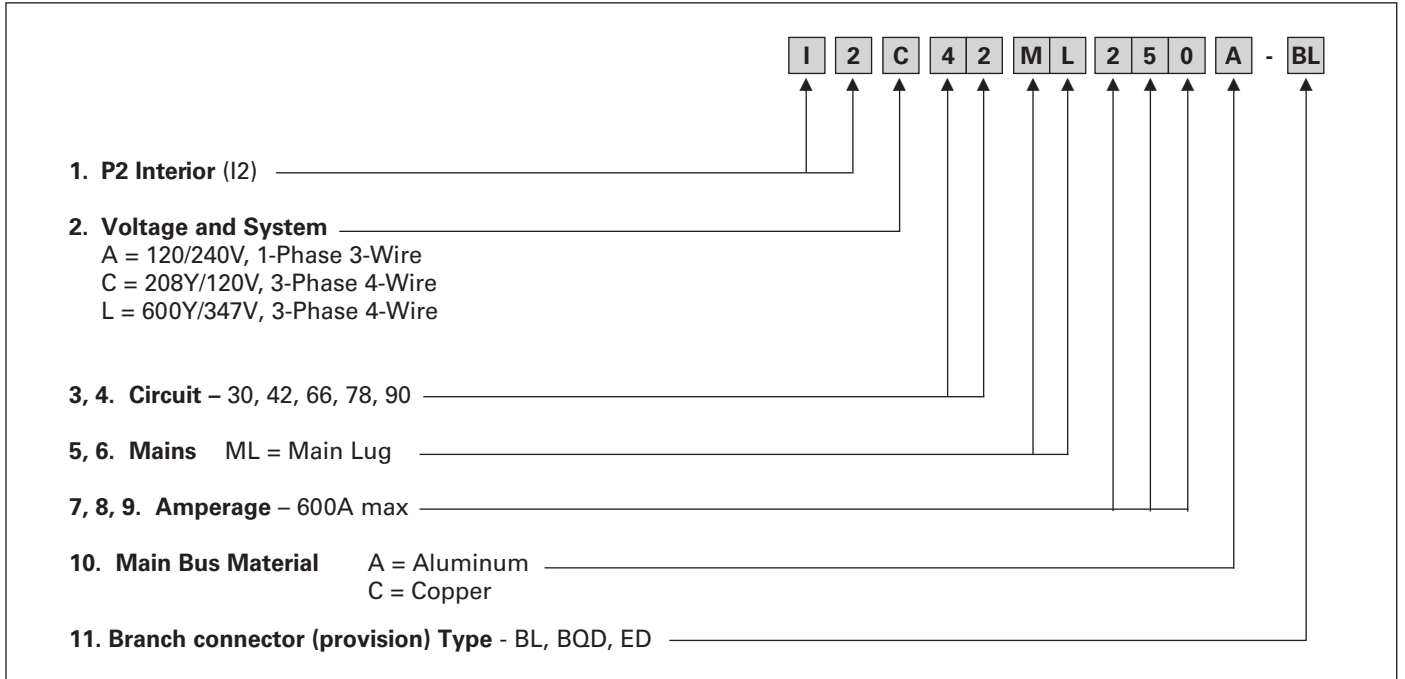

Branch Breakers

Panel Type	Voltage (Max.)	Breaker Type	Power Product Catalogue Page
P2	240	BL, BLH, HBL, BQD	See section 5
	600/347	BQD6, ED6	

Panelboards

Distributor Stock - Type P2 Main Lug Only

Selection

Interior, Box and Trim Selection

600A Max. — 20" Wide x 5.75" Deep

1. Determine voltage, system, amperage and type of branch breaker connectors to select the appropriate Interior from the table below.
2. Select the type of box and trim needed.
3. List required branch circuit breakers: Type BL, BQD or ED breakers.

Type P2 Unassembled Panelboards

Interiors Only - Less Branch Breakers				Boxes			Trim		
Amperes Rating Mains	Max. No. of Circuits	Provision Type	Main Lug + provisions	Height - Inches (mm)	Type 1	Type 3R/12 ^①	Surface	Flush ^②	
1-Phase, 3-Wire									120/240V
250	66	BL/BQD	I2A66ML250A-BL	56 (1422)	B56 B62	WP56 WP62	S56B S62B	F56B F62B	
	78		I2A78ML250A-BL	62 (1575)					
400	42	BL/BQD	I2A42ML400A-BL	50 (1270)	B50 B62	WP50 WP62	S50B S62B	F50B F62B	
	66		I2A66ML400A-BL	62 (1575)					
3-Phase, 4-Wire									208Y / 120V
250	42	BL/BQD	I2C42ML250A-BL	44 (1118)	B44 B56 B62	WP44 WP56 WP62	S44B S56B S62B	F44B F56B F62B	
	66		I2C66ML250A-BL	56 (1422)					
	78		I2C78ML250A-BL	62 (1575)					
400	42	BL/BQD	I2C42ML400A-BL	50 (1270)	B50 B62 B68 B74	WP50 WP62 WP68 WP74	S50B S62B S68B S74B	F50B F62B F68B F74B	
	66		I2C66ML400A-BL	62 (1575)					
	78		I2C78ML400A-BL	68 (1727)					
	90		I2C90ML400A-BL	74 (1880)					
600	66	BL/BQD	I2C66ML600A-BL	62 (1575)	B62	WP62	S62B	F62B	
3-Phase, 4-Wire									600Y / 347V
250	30	ED	I2L30ML250A-ED	38 (965)	B38	WP38	S38B	F38B	
	42	ED	I2L42ML250A-ED	44 (1118)	B44	WP44	S44B	F44B	
	66	BQD6 ED	I2L66ML250A-BQD	56 (1422)	B56 B56	WP56 WP56	S56B S56B	F56B F56B	
			I2L66ML250A-ED	56 (1422)					
78	BQD6 ED	I2L78ML250A-BQD	62 (1575)	B62 B62	WP62 WP62	S62B S62B	F62B F62B		
		I2L78ML250A-ED	62 (1575)						
400	42	BQD6 ED	I2L42ML400A-BQD	50 (1270)	B50 B50	WP50 WP50	S50B S50B	F50B F50B	
			I2L42ML400A-ED	50 (1270)					
	66	BQD6 ED	I2L66ML400A-BQD	62 (1575)	B62 B62	WP62 WP62	S62B S62B	F62B F62B	
			I2L66ML400A-ED	62 (1575)					
78	BQD6 ED	I2L78ML400A-BQD	68 (1727)	B68 B68	WP68 WP68	S68B S68B	F68B F68B		
		I2L78ML400A-ED	68 (1727)						
90	BQD6 ED	I2L90ML400A-BQD	74 (1880)	B74 B74	WP74 WP74	S74B S74B	F74B F74B		
		I2L90ML400A-ED	74 (1880)						
600	66	BQD6 ED	I2L66ML600A-BQD	62 (1575)	B62 B62	WP62 WP62	S62B S62B	F62B F62B	

① Hinged door included with type 3R/12 enclosures.

② Flush trims extend 3/4" beyond each side of the base box dimensions.

Panelboards

Type P2 Panelboards

Selection/Dimensions

Standard Circuit P2 Panels

Base Box Size Requirements for P2 Panels with Standard Line Lugs. Unit Spaces range from 9" to 45" (in 6" increments). Boxes range from 26" to 74" high (in 6" increments). Inclusion of optional modifications may require size increases that must be added to these base values to calculate the final box size for the panel (see pages 6-28, 10-31). Values in brackets [], at the bottom of each column, indicate the maximum allowable 1" module branch poles for each main type.

"B" Dimension Box Height	P2 Panels with Standard Line Lugs. Unit Space (starting with 9" and adding 6" increments) "A" Dimension															
	Main Lugs			Main Breakers												
	125A	250A	400A 600A	125A Horiz. BL, BQD, ED	125A Vert. ED ^①	125A Horiz. CED	225A Horiz. QR	225A Vert. QR ^①	250A Horiz. FD	250A Vert. FD ^①	250A CFD	400A JD	400A CJD	600A LD	600A CLD	
26	9	—	—	9	—	—	—	—	—	—	—	—	—	—	—	
32	15	9	—	15	9	9	—	—	—	—	—	—	—	—	—	
38	21	15	9	21	15	15	15	9	9	—	—	—	—	—	—	
44	27	21	15	27	21	21	21	15	15	9	—	—	—	—	—	
50	27	27	21	33	27	27	27	21	21	15	9	9	—	—	—	
56	39	27	27	39	33	33	33	27	27	21	15	15	—	9	—	
62	45	39	33	45	39	39	39	33	33	27	21	21	9	15	9	
68	51	45	39	51	45	45	45	39	39	33	27	27	15	21	15	
74	57	51	45	57	54	54	54	45	45	39	33	33	21	27	21	
	[114p]	[102p]	[90p]	[114p]	[102p]	[102p]	[102p]	[90p]	[90p]	[78p]	[66p]	[66p]	[42p]	[54p]	[42p]	

Main breaker wire bending space diagram

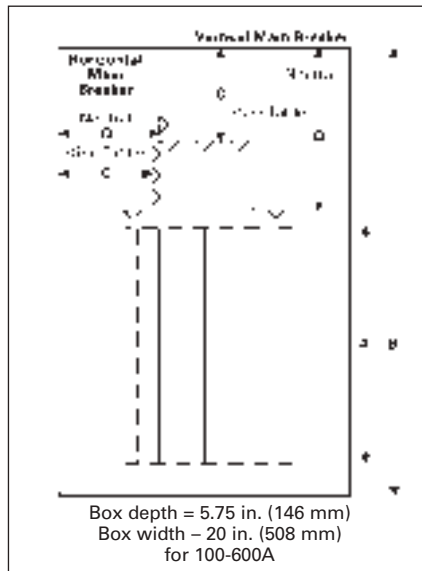

Main lug wire bending space diagram

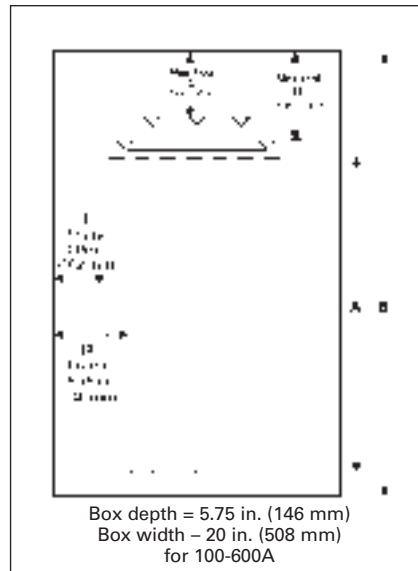

① NOTE: The vertical main breaker application for ED, QR, and FD adds 6" of box height.

Panelboards

Type P2 Panelboards

Selection/Dimensions

Standard Circuit P2 Panels

Main Breaker Wire Bending

Standard Circuits (up to 54 1" module branch poles)			
Panel Amps	Breaker Frames	C ^①	D ^①
100	BL	5.75	8.00
	BQD	5.13	8.00
125	ED (horiz.)	4.00	8.00
	ED (vert.)	6.56	11.13
225	QR (horiz.)	5.00	7.00
	QR (vert.)	10.06	16.69
250	FD (horiz.)	5.00	7.00
	FD (vert.)	13.25	22.72
400	JD	15.38	25.00
600	LD	15.38	23.00

Branch Breaker Side Gutters Inches (mm)

Reference Letter	Panel Width 20" (508)
A	5.750 (146)
B	5.125 (130)
C	4.000 (102)
D ^②	5.000 (127)
E	4.625 (117)

Main Lug Connectors

Standard Circuits (up to 54 1" module branch poles)			
Panel Amps	Standard Connectors	C ^①	D ^①
125	(1) #14-2/0	6.62	8.19
250	(1) #6 AWG - 350 MCM	11.75	10.72
400	(1) #4 AWG - 600 MCM or (2) #6 - 250 MCM	14.00	13.09
600	(2) #4 AWG - 500 MCM	14.00	11.00

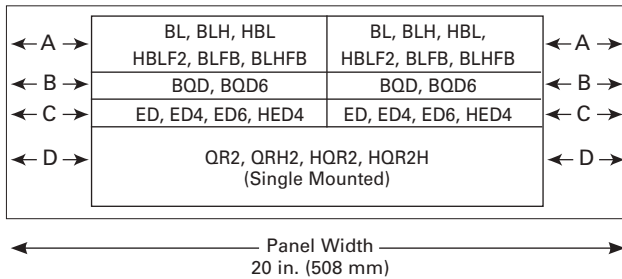

① Refer to diagrams at the bottom of page 10-26.
② Single branch mounting construction.

Panelboards

Type P2 Panelboards

Selection

Main Breaker Selection^①

Ampere Rating	Breaker Type	Max. Interrupting Rating (kA)			Ref. Catalogue No.	Available Trip Values
		240V	480V	600V		
70	BQD6	65	—	10	B6	15, 20, 25, 30, 35, 40, 45, 50, 60, 70
100	BL	10	—	—	BL	15, 20, 25, 30, 35, 40, 50, 60, 70, 80, 90, 100
	HBL	65	—	—	HB	15, 20, 25, 30, 35, 40, 50, 60, 70, 80, 90, 100
	BQD	65	14	—	BQ	15, 20, 25, 30, 35, 40, 50, 60, 70, 80, 90, 100
	BLH	22	—	—	BH	15, 20, 25, 30, 35, 40, 50, 60, 70, 80, 90, 100
125	ED4	65	18	—	E4	15, 20, 25, 30, 35, 40, 50, 60, 70, 80, 90, 100, 110, 125
	ED6	100	25	14	E6	15, 20, 25, 30, 35, 40, 50, 60, 70, 80, 90, 100, 110, 125
	HED4	100	42	—	H4	15, 20, 25, 30, 35, 40, 50, 60, 70, 80, 90, 100, 110, 125
225	QR2	10	—	—	QR	100, 110, 125, 150, 175, 200, 225
	QRH2	25	—	—	Q4	100, 110, 125, 150, 175, 200, 225
	HQR2	65	—	—	Q5	100, 110, 125, 150, 175, 200, 225
	HQR2H	100	—	—	Q6	100, 110, 125, 150, 175, 200, 225
	FD6	65	35	18	FD	70, 80, 90, 100, 110, 125, 150, 175, 200, 225
	FXD6	65	35	18	FX	70, 80, 90, 100, 110, 125, 150, 175, 200, 225
	HFD6	100	65	25	HF	70, 80, 90, 100, 110, 125, 150, 175, 200, 225
	HFXD6	100	65	25	H2	70, 80, 90, 100, 110, 125, 150, 175, 200, 225
	CFD6 ^②	200	200	100	CF	70, 80, 90, 100, 110, 125, 150, 175, 200, 225
	250	FD6	65	35	18	FD
FXD6		65	35	18	FX	70, 80, 90, 100, 110, 125, 150, 175, 200, 225, 250
HFD6		100	65	35	HF	70, 80, 90, 100, 110, 125, 150, 175, 200, 225, 250
HFXD6		65	35	25	H2	70, 80, 90, 100, 110, 125, 150, 175, 200, 225, 250
400	JXD6 ^②	65	35	25	JX	200, 225, 250, 300, 350, 400
	JD6 ^②	65	35	35	J6	200, 225, 250, 300, 350, 400
	HJXD6 ^②	100	65	35	H6	200, 225, 250, 300, 350, 400
	HJD6 ^②	100	65	35	H5	200, 225, 250, 300, 350, 400
	SJD6 ^②	65	35	25	SJ	200, 300, 400
	SHJD6 ^②	100	65	35	S2	200, 300, 400
	CJD6 ^②	200	200	100	CJ	200, 300, 400
	SCJD6 ^②	200	200	100	SC	200, 300, 400
600	LXD6 ^②	65	35	25	LX	450, 500, 600
	LD6 ^②	65	35	25	L6	250, 300, 350, 400, 450, 500, 600
	HLXD6 ^②	100	65	35	HL	250, 300, 350, 400, 450, 500, 600
	HLD6 ^②	100	65	35	HO	250, 300, 350, 400, 450, 500, 600
	SLD6 ^②	65	35	25	SL	300, 400, 500, 600
	SHLD6 ^②	100	65	35	S6	300, 400, 500, 600
	CLD6 ^②	200	150	100	CL	300, 400, 500, 600
	SCLD6	200	150	100	C6	300, 400, 500, 600

Vertically Mounted Main Breaker (available in 2-pole or 3-pole)

Ampere Rating	Breaker Type(s)	Unit Space (in.)
100	ED4, ED6, HED4	6
225	FXD6, FD6, HFD6 QR2, QRH2, HQR2, HQR2H	6

Subfeed Breakers (available in 2-pole or 3-pole)

Breaker Type	Mounting Position When Used as Subfeed Breaker	Ampere Ratings For Load	Maximum Interrupting Rating (kA) Symmetrical		
			240V AC	480V AC	600V AC
FD6 ^③ , FXD6	Twin	70–250	65	35	22
HFD6 ^③ , HFXD6	Twin	70–250	100	65	25
JD6 ^③ , JXD6	Single	200–250	65	35	25
HJD6 ^③ , HJXD6	Single	200–250	100	65	35

① Interchangeable trip main breakers are mounted at top of panel only.

② Vertically mounted.

③ Twin mounted subfeed breakers are mounted at the bottom of panelboard only and adds 24" to the panel height.

④ Subfeed breaker is mounted at bottom of panelboard only. 250 amp subfeed breaker adds 24" to the panel height. (Only for use with MLO)

Panelboards

Type P2 Panelboard Standard Modifications and Additions

Selection

Branch Circuit Breakers

Max. Amp Rating	Bolt-On Breaker Type	Amps	Availability			Maximum Interrupting Rating (kA)						
			1-Pole	2-Pole	3-Pole	120V AC	120/240V AC	240V AC	277V AC	480V AC	600V AC	250V DC
70	BQD6	15-70	✓	✓	✓	65	65	65	—	—	10	—
100	BL	15-60	✓	✓	✓	10	—	—	—	—	—	—
		70	✓	✓	✓	—	10	—	—	—	—	—
		80-100	—	✓	✓	—	—	10	—	—	—	—
	BLH	15-60	✓	✓	✓	—	22	—	—	—	—	—
		70	✓	✓	✓	—	22	—	—	—	—	—
		80-100	—	✓	✓	—	—	22	—	—	—	—
	HBL BLR (240V)	15-55	✓	✓	✓	—	65	—	—	—	—	—
		60-100	—	✓	✓	—	65	—	—	—	—	—
		15-60 70-100	—	✓	—	—	—	—	10	—	—	—
	BLE (GFCI)	15-30	✓	✓	—	10	—	—	—	—	—	—
		40-60	—	✓	—	—	10	—	—	—	—	—
	BLEH	20-30	✓	—	—	22	—	—	—	—	—	—
		15-60	✓	✓	—	—	22	—	—	—	—	—
	BLF (GFCI)	15-30	✓	✓	—	10	—	—	—	—	—	—
40-60		✓	✓	—	—	10	—	—	—	—	—	
BLHF (GFCI)	15-30	✓	✓	—	22	—	—	—	—	—	—	
	40-60	✓	✓	—	—	22	—	—	—	—	—	
HBLF2 (GFCI)	15-30	✓	—	—	65	—	—	—	—	—	—	
BAF BAFH	15-20	✓	✓	—	10	—	—	—	—	—	—	
	15-20	✓	✓	—	22	—	—	—	—	—	—	
BQD	15-60	✓	✓	✓	—	—	—	14	—	—	14	
	70-100	✓	✓	✓	—	65	—	—	—	14	14	
125	NGB2	15-60	✓	✓	✓	100	100	100	25	25	14	14 ^④
		70-100	✓	✓	✓	100	100	100	25	25	14	14 ^④
		110-125	—	✓	✓	100	100	100	25	25	14	14 ^④
	HGB2	15-60	✓	✓	✓	100	100	100	35	35	22	14 ^④
		70-100	✓	✓	✓	100	100	100	35	35	22	14 ^④
		110-125	—	✓	✓	100	100	100	35	35	22	14 ^④
	LGB2	15-60	✓	✓	✓	100	100	100	65	65	25	14 ^④
		70-100	✓	✓	✓	100	100	100	65	65	25	14 ^③
		110-125	—	✓	✓	100	100	100	65	65	25	14 ^③
	ED4	15-60	✓	✓	✓	65	—	—	22	—	—	—
		70-100	✓	✓	✓	—	—	65	—	18	—	30
		110-125	—	✓	✓	—	—	65	—	18	—	—
	ED6	15-60	—	✓	✓	—	—	65	—	25	18	30
		70-100	—	✓	✓	—	—	65	—	25	18	—
110-125		—	✓	✓	—	—	65	—	25	18	—	
HED4 ^①	15-60	✓	✓	✓	—	—	65	—	42	18	30	
	70-100	✓	✓	✓	—	—	65	—	42	18	—	
	110-125	—	✓	✓	—	—	65	—	42	18	—	
CED6 ^②	15	—	—	✓	—	—	200	—	—	100	—	
	20-125	—	✓	✓	—	—	200	—	—	100	—	
225	QR2	100-225	—	✓	✓	—	—	10	—	—	—	—
	QRH2	100-225	—	✓	✓	—	—	25	—	—	—	—
	HQR2	100-225	—	✓	✓	—	—	65	—	—	—	—
	HQR2H	100-225	—	✓	✓	—	—	100	—	—	—	—

Branch Neutral Connections

Wire Range	Max. Number of Connections	Max. Amp ^②
#14-#6	26	65
#14-1/0	28	125
#6-350 kcmil	3	250
(1) #4-600 kcmil or (2) #6-250 kcmil	1	400

① 1-Pole HED 4 15-30A Rated 65kA 35 through 100A Rated 25kA.
 ② Based on 75 degree copper.
 ③ 2-pole only (or) two outer poles of 3-pole breaker.
 ④ CED6 breaker can be used in 400A panel with copper bussing only.
 Panel enclosure required is 24" (610mm) wide.

NOTE: QR Breakers are single mounted in unit space and take 6" of unit space. Limited to (4) per panel max. BL, HBL, BLH and BQD breakers are mounted in common mountings in 3" or (6) pole increments. ED4, ED6 and HED4 breakers are mounted in common mountings in 3" or (6) pole increments.

Panelboards

Type P2 Panelboard Modifications and Additions

Selection

Enclosure Modifications

Description
Type 1 with gasket Type 1 with dripshield Type 3R - Waterproof and silicone free Type 3R/12 - Dustproof Type 4/4X - Standard type 304 Stainless Steel Type 4/4X - Type 316 Stainless Steel Wider enclosure - 24", 30" or 36" wide
Hinged trim Piano hinged trim Trim with padlock Door-in-door trim Screw to the box trim Trim with gasketed door Stainless steel trim
Trim mounted devices (Devices mounted into a 10" minimum box extension) <ul style="list-style-type: none"> • Pilot lights • Toggle switches • Push buttons
Painted boxes Custom colors Increase gauge trims and boxes Stainless steel trims and boxes, Type 1

Meters

(Contact sales for pricing and application engineering for space requirements)

Panel Skirts

See page 10-64

Panel Bus Modifications

Bus Material

Represented by "A", "C" or "E" in the 11th digit of the catalogue number.

Standard bussing is tin plated Al, alternate bus bar material can be selected:

- Tin plated copper
- Silver plated copper - optional

Subfeed and Feed-Thru (for 2-pole or 3-pole)

Ampere Rating	Connector Cu/Al Wire Range	Unit Space (inches)
100/125	(2)—#12 AWG - 2/0 AWG	6
225/250	(2)—#6 AWG-350 kcmil	6
400	(4)—250 kcmil (2)—600 kcmil	6

Subfeed (Double) Lugs for Main Lug Panelboards Only

Ampere Rating	Connector Cu/Al Wire Range	Unit Space (inches)
100/125	(2)—#12 AWG - 2/0 AWG	6
225/250	(2)—#6 AWG-350 kcmil	6
400	(4)—250 kcmil (2)—600 kcmil	6

Feed-Thru Lugs – Cannot be used in conjunction with SPD or Subfeed Breakers (200% Neutral not available)

Amp Rating	Type	Connector Wire Range
125	Al Mechanical	(1) #6 AWG - 2/0 AWG Al/Cu
	Cu Mechanical	(1) #6 AWG - 350 kcmil Cu
	Compression	(1) #6 AWG - 350 kcmil Al/Cu
250	Al Mechanical	(1) #6 AWG - 350 kcmil Al/Cu
	Cu Mechanical	(1) #6 AWG - 350 kcmil Cu
	Compression	(1) #6 AWG - 350 kcmil Al/Cu
400	Al Mechanical	(1) #2 AWG - 600 kcmil Al/Cu and (1) 1/0 AWG - 250 kcmil Al/Cu
	Cu Mechanical	(1) 1/0 AWG - 600 kcmil or (2) 1/0 AWG - 4/0 AWG
	Compression	(1) 250 kcmil - 600 kcmil Cu or (2) #6 AWG - 350 kcmil Al/Cu
600	Al Mechanical	(2) #2 AWG - 600 kcmil Al/Cu
	Cu Mechanical	(2) #2 AWG - 600 kcmil Cu
	Compression	(2) #6 AWG - 350 kcmil Al/Cu (2) 400 kcmil - 600 kcmil Al or (2) 400 kcmil - 500 kcmil Cu

Increase Capacity Neutral up to 200% (N/A on FeedThru Lugs & Subfeed Lugs)

Main Bus Amps
125
250
400
600

See page 10-31 for unit space adders and compatibility with other options.

(Devices mounted and wired to the trim should also have hinged trim specified)

Bus mounted SPD

See Section 9

- TPS3 01
 - Bus connected
 - Internally mounted (30A breaker required to feed SPD)
 - Externally mounted in a 15" high aux. enclosure (30A breaker required to feed SPD)
- TPS3 09
 - Internally mounted (20A breaker required to feed SPD)
 - Externally mounted (20A breaker required to feed SPD)
- TPS3 12
 - Externally mounted (40A breaker required to feed SPD)

Service Entrance Label

Type P2 Panelboards are factory labeled "SUITABLE FOR USE AS SERVICE ENTRANCE EQUIPMENT" when identified as "Service Entrance" at the time of order entry. For regulations governing this feature, please consult CEC, CSA or local electrical authorities.

Grounding of Panelboards

Ground Bars except for brazed to box are shipped with the panel interior factory mounted.

- Non-Insulated Equipment Ground Bar
- Copper Non-Insulated Ground Bar
- Al Insulated Equipment Ground Bar
- Cu Insulated Equipment Ground Bar

Shunt Trip on Main or Branch

BL, BLH, HBL, NGB, xGB2, ED6, HED4, uses 1" unit space for shunt trip. All others may be used on mains or subfeeds.

Contactors Mains or Submain*

- Asco 920 through 225 amps – adds 12" unit space as main, 15" unit space as submain
- External with manufacture supplied enclosure
- Siemens LEN through 30 amps - adds 6" as main; 18" for up to 100A submain and 21" for 200A. 7.75" depth cans for up to 100A and 10" depth cans for 200A.

Branch and Main Breaker Accessories

See breaker section of this catalog.

- Handle blocks
- Handle locks
- Aux. Contacts®
- UVR®

① Accessories on 1" pole breakers (BL, BQD, ED) will take unit space.

Panelboards

Embedded Micro Metering Module™ (Type P2 Panelboard)

Selection

SEM3 System configured in Panelboards

The Siemens SEM3 system can be configured for factory installation in branch circuit monitoring applications. This option can lower the installation time of the system for the installer while providing a factory warranted solution.

The SEM3 system can be factory installed in unit space in type P2 & S5 Siemens panel boards and in Siemens switchboards. Please note P1 and P3 configurations are not available at this time and the amount of unit space needed varies depending upon the application. Please note that lead time adders will apply and may vary depending upon the configuration of the system.

SEM3 for use in Siemens Panelboards



Type P2: Enclosure

- Available in a Type 1 rated enclosure.
- Minimum width & depth: 30" width x 7.75" depth
- Height: Up to 74" depending on branch breaker selection
 - Addition of monitoring on some mains (primary and subfeed) may require additional box length. In these cases the box will be increased to the next size available as a standard design. The option of monitoring on mains is not available for equipment rated for service entrance.
 - In cases where enclosure size is increased all multi-section panels will be increased to match the largest section.



Controller

SEM3 controller is mounted in a separate enclosure (relay cabinet) opposite of the feed location (i.e., bottom mount for top feed) with a height of 24". Each controller will be powered by direct tap connection to the panel section or through a 150VA potential transformer for systems above 480V. The direct tap connection will use 2 circuits from the distribution section (i.e., 42 circuits panel will have 40 circuits usable for distribution). Each controller can monitor up to 45 circuits. Applications that require monitoring more than 45 circuits will require additional P2 panel complete with SEM3.



Current Transformers (CTs)

Five sizes of CTs are available for use in the P2 panel: 50, 125, 250, 400 & 600 amp. All CTs are pre-mounted to a support bracket that attaches to the base rail of the interior of the panel board. Each bracket supports a maximum of 3 CTs and is designed for the breaker selected (brackets are not interchangeable between breaker frames). Each CT will be attached to a data module that is placed in the meter racks.



Meter Racks

All meter racks will be installed next to the SEM3 controller in the relay cabinet.

NOTE: Monitoring of 45 circuits will require: two 21 position racks and one 3 position rack

Panelboards

Embedded Micro Metering Module™ (Type P2 Panelboard)

Selection

P2 Devices

Enclosure sizes

Example P2 Panel with SEM3 Type 1 Enclosure (36" Wide x 7.75" Deep)

Enclosure heights are in 6" increments from 26" thru 74".
Enclosure heights: 26", 32", 38", 44", 50", 56", 62", 68", 74"

Example below is largest standard P2 enclosure for factory assembled panel with all small (1") branch breakers installed.

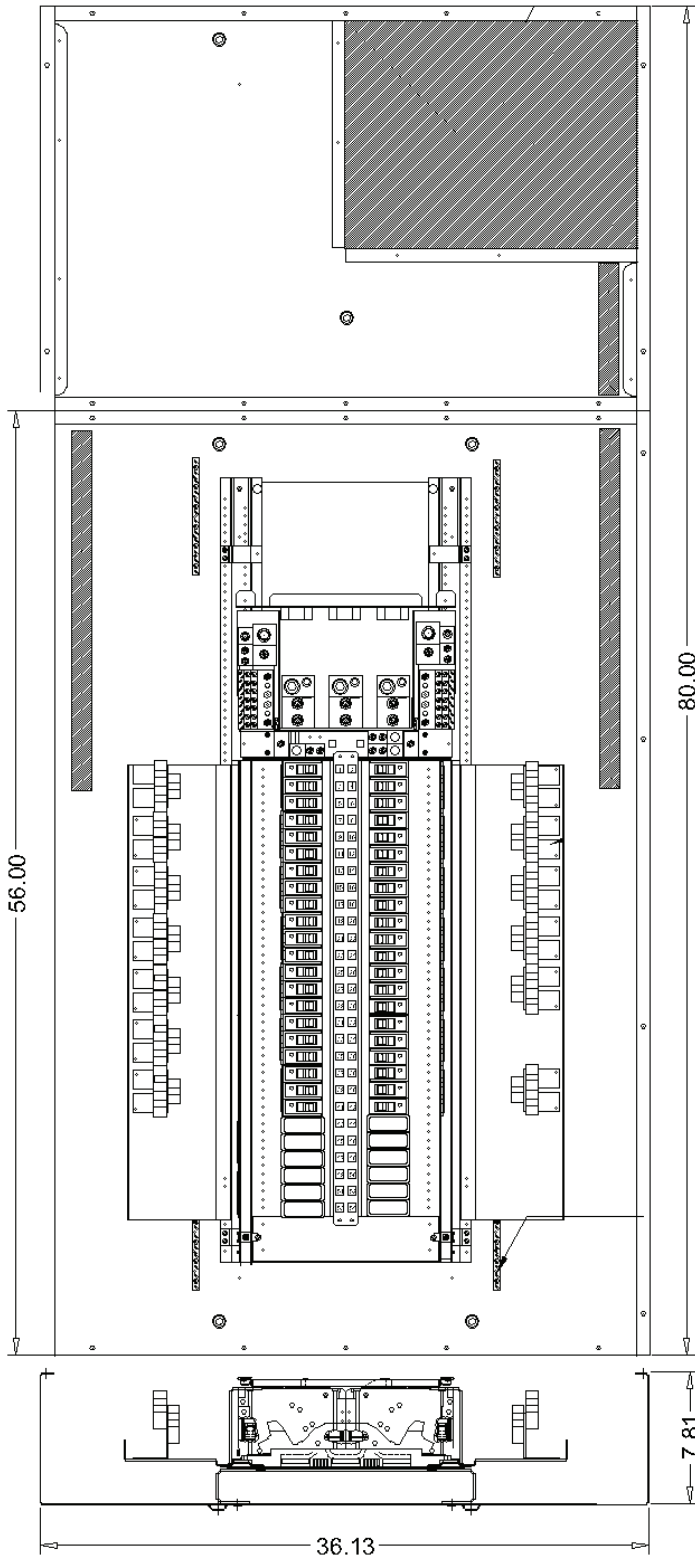

← 36" std. width →

Relay Cabinet which includes SEM3 components:

- Meter rack
- 3 Phase PT 150VA
- Controller:
 - 21 circuits monitored: one controller and one 21-pos rack
 - 42 circuits monitored: one controller and two 21-pos racks
 - 45 circuits monitored: one controller and two 21-pos racks plus one 3-pos rack

Main Breaker / Main Lug space varies based on selected options

Unit space varies based on selected options

Note: All circuits do not have to be monitored by SEM3 - user can select any circuits in this space to be monitored.

Based on smallest branch breakers and a 3-phase main being monitored. There is a maximum of 42 circuits that can be monitored with the configuration shown. Some selections of main breakers and other subfeed options could limit this further.

In this situation there is 27" of unit space available - so 54 branch circuits could be monitored. If monitoring the main three additional circuits could be monitored with a total of 57 circuits.

This requires two controllers and three 21 position racks using 15" of unit space.
- see below -

Note: If subfeed space is needed - it will take away from available unit space.

Panelboards

Type P2 Panelboard Standard Modifications and Additions

Selection

Box Size Additions for Optional Features

Options	Main Lugs				Main Breakers											
	125A	250A	400A	600A	125A Horiz. BL, BQD, ED, xGB	125A Horiz. CED	125A Vert. ED	225A Horiz. QR	225A Vert. QR	225A Horiz. FD	250A Vert. FD	250A Vert. CFD	400A JD	400A CJD	600A LD	600A CLD
*Min. Box Size	26"	32"	38"	38"	26"	32"	32"	32"	38"	38"	44"	50"	50"	62"	56"	62"
200% Neutral (lug type)	0	0	6 (all)	6 (all)	0	0	0	N/A	0	N/A	0	0	0	0	0	0
Std. Lugs (100% Neut. PNL)	0	0	0	0	0	0	0	0	0	0	0	0	0	0	0	0
CU Lugs (100% Neut. PNL)	6	6	6	0	N/A	N/A	0	N/A	0	N/A	0	0	0	0	0	0
Comp Lugs (100% Neut. PNL)	6	6	6	6	N/A	N/A	0	N/A	0	N/A	0	0	0	0	0	0
Feed-thru Standard Lugs	6	6	12	12	6	6	6	N/A	6	N/A	6	6	12	12	12	12
Feed-thru Cu Lugs Feed-thru	6	6	12	N/A	N/A	N/A	6	N/A	6	N/A	6	6	12	12	N/A	N/A
Comp Lugs	6	12	12	N/A	N/A	N/A	6	N/A	6	N/A	12	12	12	12	N/A	N/A
Subfeed Standard Lugs	0	6	6	N/A	—	—	—	—	—	—	—	—	N/A	—	—	—
(1) FD Subfeed (Horizontal Mtg.)	N/A	12	12	12	N/A	N/A	N/A	N/A	N/A	12	12	12	12	12	12	12
(2) FD Subfeed (Vertical Mtg.)	N/A	24	24	24	N/A	N/A	N/A	N/A	N/A	24	24	24	24	N/A	N/A	N/A
SPD	12	12	12	12	12	12	12	12	12	12	12	12	12	12	12	12

NOTE: N/A = OPTION NOT AVAILABLE

*Min. Box Size, corresponding to 9" of Unit Space.

Compression Lugs

Style	Amp Rating	Breaker Type	Compression Connectors	Box Height Addition - Inches (mm)
MLO	125	N/A	(1)#6 - 350 kcmil Al/Cu	6 (152)
	250	N/A	(1)#6 - 350 kcmil Al/Cu	6 (152)
	400	N/A	(1) 400 - 600 kcmil Cu or (2)#6 - 350 kcmil Al/Cu	6 (152)
	600	N/A	(2)#6 - 350 kcmil Cu or Cu/Al or 400 - 600 kcmil Al/Cu	6 (152)
Main Breaker	100	ED4, ED6, HED4, CED6 ^①	(1)#14-2/0 AWG Cu or Al	Box must go to 24" wide on CED6 breaker only Add 6" to box height for NØ
	225	QR2, QRH2, HQR2, HQR2H	(1)#6 AWG - 350 kcmil Cu or Al	Box must go to 24" wide
	250	FXD6, HFD6, CFD6	(1)#6 AWG - 350 kcmil Cu or Al	Box must go to 24" wide for all breakers Requires an additional 6.0" box height
	400	JD6, JXD6, HJD6, CJD6, SJD6, SHJD6, SCJD6	(2)#1/0 AWG - 500 kcmil Cu or Al	9 (229)
	600	LD6, LXD6, HLD6, CJD6, SLD6, SHLD6, SCLD6	(2)#2/0 AWG - 500 kcmil Cu or Al	6 (152)

Alternate Lugs

Style	Amp Rating	Breaker Type	Standard AL Connectors	Box Height Addition - Inches (mm)
MLO	400	N/A	(1) 250 - 750 kcmil or (2)#3/0 AWG - 250 kcmil Cu or Al	6 (152)
Main Breaker	400	JD6, JXD6, HJD6, CJD6, SJD6, SHJD6, SCJD6	(1)#4/0 AWG - 750 kcmil Cu or Al	6 (152)

① Not available for feed thru lug.

Panelboards

Type P2 Panelboard Connector Modifications

Selection

Enclosure Modifications

Description
Wider enclosure - 24" wide
Type 1 with gasket
Type 1 with dripshield
Type 2 enclosures
Type 3R enclosures
Type 3R/12 enclosures

Type 4—Water Tight, Dust Tight, Steel Enclosure® (Actual NEMA-4 enclosure is larger than standard Type 1 enclosure. See chart below for reference to approximate actual size.)

Standard Box Height (in inches)	Actual NEMA 4 Enclosure Size®		
	H	W	D
32	32	20	8
38	42	30	8
44	48	36	8
56	60	36	10

NOTE: Larger Type 4 enclosures are not available.

Type 4X—Water Tight, Dust Tight and Corrosion Resistant® (consult plant for actual enclosure size)

Catalogue Number	Enclosure – Stainless Steel Size (inches) (304SS is standard)		
	H	W	D
B4X26	26	20	5.75
B4X32	32	20	5.75
B4X38	38	20	5.75
B4X44	44	20	5.75
B4X50	50	20	5.75
B4X56	56	20	5.75
B4X62	62	20	5.75
B4X68	68	20	5.75
B4X74	74	20	5.75

NOTE: 316SS is available as an option - must be specified.

- ① 16 Gauge Cans w/ 14 Gauge Front)
- ② 14 Gauge only
- ③ 14 Gauge only - 304SS Std, 316SS Optional)

Gauge Steel of Boxes/Fronts, Surface and Flush

Dimensions in Inches (mm)		Gauge Steel		
Width	Height	Box	Front/Door	Type
20 (508)	26-74 (660-1880)	14	14 ^③	Type 1
20 (508)	26-74 (660-1880)	16 ^②	16/14 ^②	Type 3R/12
20-36 (508-914)	32-60 (813-1524)	14 ^③	14 ^③	Type 4
20 (508)	26-74 (660-1879)	14 ^④	14 ^④	Type 4X
30-36 (762-914)	36-60 (914-1524)	N/A ^⑤	N/A ^⑤	Type 4X Non-Metallic

- ① 15 Gauge Steel Can with 14 Gauge Door or Similar Approved Construction
- ② No Optional Gauge available
- ③ 304SS 14 Gauge Std., 316SS 14 Gauge optional
- ④ Sizes do not match Standard Enclosure Sizes - See Table P1-21 - material is non-metallic - No Gauge Specified.

Panelboards

Type P2 Panelboard Kits and Accessories

Selection

Standard Enclosures

Box Height Inches	Catalogue Number				
	Type 1 Standard Trim			Type 3R	Type 3R/12 ①
	Box	Surface	Flush		
26	B26	S26B	F26B	NR26	WP26
32	B32	S32B	F32B	NR32	WP32
38	B38	S38B	F38B	NR38	WP38
44	B44	S44B	F44B	NR44	WP44
50	B50	S50B	F50B	NR50	WP50
56	B56	S56B	F56B	NR56	WP56
62	B62	S62B	F62B	NR62	WP62
68	B68	S68B	F68B	NR68	WP68
74	B74	S74B	F74B	NR74	WP74

① Same as Type 3R with Gasket added for Type 12 Spec.

Options For Type 1 Trims

Items must be ordered as manual line item on Spartanburg
 Hinged trim – Replace “B” suffix with “H”
 Door-in-door – Replace “B” suffix with “D”
 Screw to Box - Replace “B” suffix with “C”
 Metal card holder - Add “M” suffix on all trims

Option For 24" Wide Enclosures with Equal Gutter on Both Sides (Excludes Type 3R)

24" wide with equal gutter on both sides - Add “24” as prefix

Breaker Kits and Accessories

Kit Number	Description	Contents
BBKB32 BBKB32AT BBKB32CS	BL/BQD 6-pole 3" branch breaker kit Cu/Tin BL/BQD 6-pole 3" branch breaker kit Al/Tin BL/BQD 6-pole 3" branch breaker kit Cu/Silver	Kit contains top barrier, (3) A/C connectors, (1) B connector, hardware
BBKCED32 BBKCED32CS	CED branch breaker kit Cu/Tin CED branch breaker kit Cu/Silver	Kit contains connector kit for P2 400A, 24" wide only
BBKED32 BBKED32AT BBKED32CS	ED 6-pole 3" branch breaker kit Cu/Tin ED 6-pole 3" branch breaker kit Al/Tin ED 6-pole 3" branch breaker kit Cu/Silver	Kit contains breaker support, inter-phase barrier, (3) A/C connectors, (1) B connector, hardware
BBKNB32 (P2/P3) BBKGB32	NGB 6-pole 3" branch breaker kit NGB2/HGB2/LGB2 6-pole	Kit contains top barrier, (3) A/C connectors, (1) B connector, hardware Kit contains top barrier, (3) A/C connectors, (1) B connector, hardware
BBKQR1 ①	QR branch breaker kit for 2 and 3-pole single mount in P2 panel	Kit to contain all connectors and cover plates necessary to mount both 2 and 3-pole breakers
DFK1	BL, BQD, ED deadfront kit for 1" pole breakers	Center strips 3", 6", 9", 15", 21" plus mounting hardware
DFFP3	Deadfront filler 3"	3" empty space filler and hardware
DFFP6	Deadfront filler 6"	6" empty space filler and hardware
BNK2	Branch neutral (P2)	Three tier lug with mounting hardware to increase neutral capacity
P2BK1	P2 250A max. Bonding Kit	Bonding strap and hardware
P2BK2	P2 400A max. Bonding Kit	Bonding strap and hardware
P2BK3	P2 600A max. Bonding Kit	Bonding strap and hardware
BBKQR1FK	P2 Filler for QR. Horizontal or vertical mount. 1-phase/3-phase.	Kit contains all cover plates necessary to change from QJ to QR both 2 and 3-pole breakers.

① Although QR is rated 250A, it is limited to 225A in panelboard.

Type P2 Panelboards

Miscellaneous Parts and Accessories

Catalogue Number	Description	Catalogue Number	Description
EGK	Al Ground Bus 44 Connections	NBK6	Number Strips 86-168 (snap-in type, P2/P3 panels)
P2BK1	P2 250A Bonding Kit	NBK7	Number Strips 169-210 (snap-in type, P2/P3 panels)
P2BK2	P2 400A Bonding Kit	NBK8	Number Strips 211-252 (snap-in type, P2/P3 panels)
P2BK3	P2 600A Bonding Kit	ECGK	Cu Ground Bus 44 Connections
IMK1	Interior Adjusting Kit	IGK	Insulated Al Ground Bus
9271-1	Plastic directory card holder	ICGK	Insulated Cu Ground Bus
SDKN	Drip shield 20"W x 5.75"D	EWK2	End Wall Kit with Knockouts (24" W x 7.75" DP)
NBK3	Number Strips 1-42 (snap-in type, P2/P3 panels)	DFFP1	1" Filler Plate – (suitable for replacing QF3-UL in P1 thru S5 Panelboards and Switchboards)
NBK4	Number Strips 43-84 (snap-in type, P2/P3 panels)	MCHK	Metallic directory card holder
NBK5	Number Strips 85-126 (snap-in type, P2/P3 panels)	EBF1	NEB/HEB Filler Plate

Panelboards

Type P2 Panelboards

Dimensions

Type 1 Box

Box is symmetrical

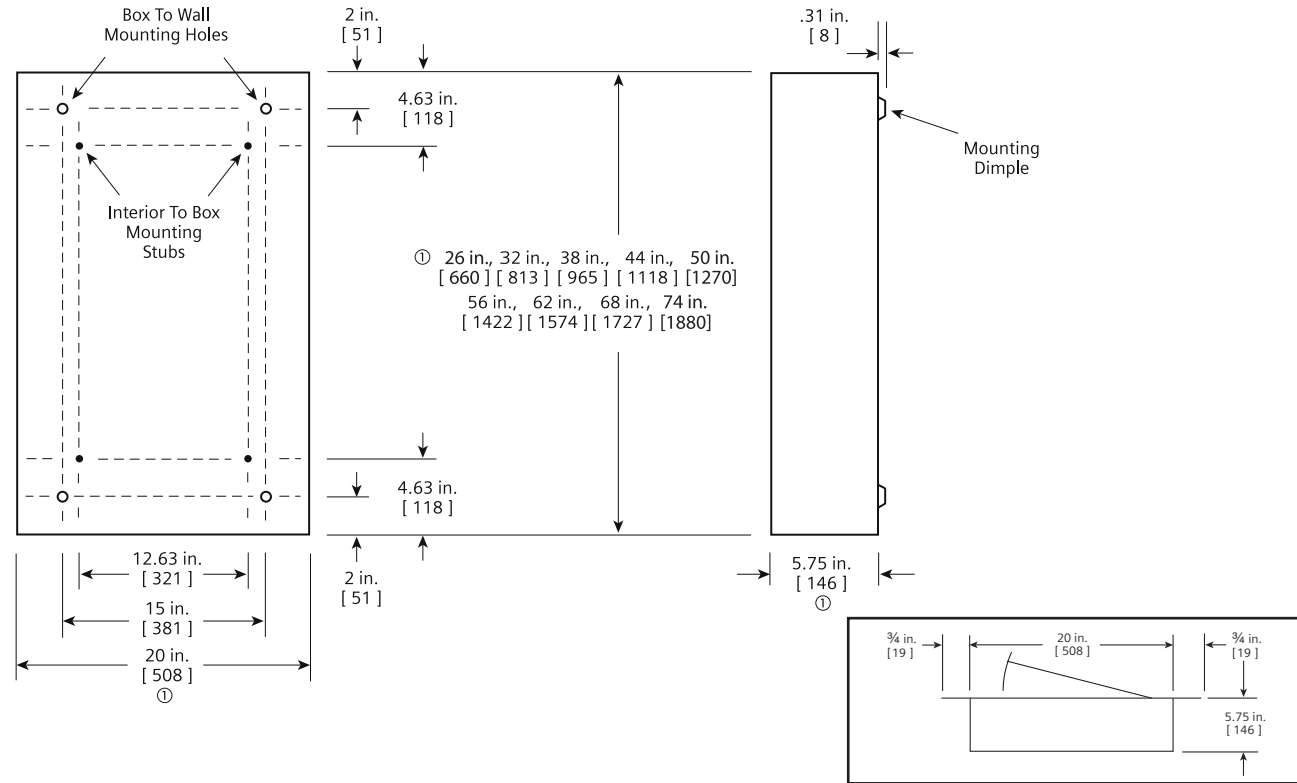

Flush Mounting

Type 3R and 3R/12 Box

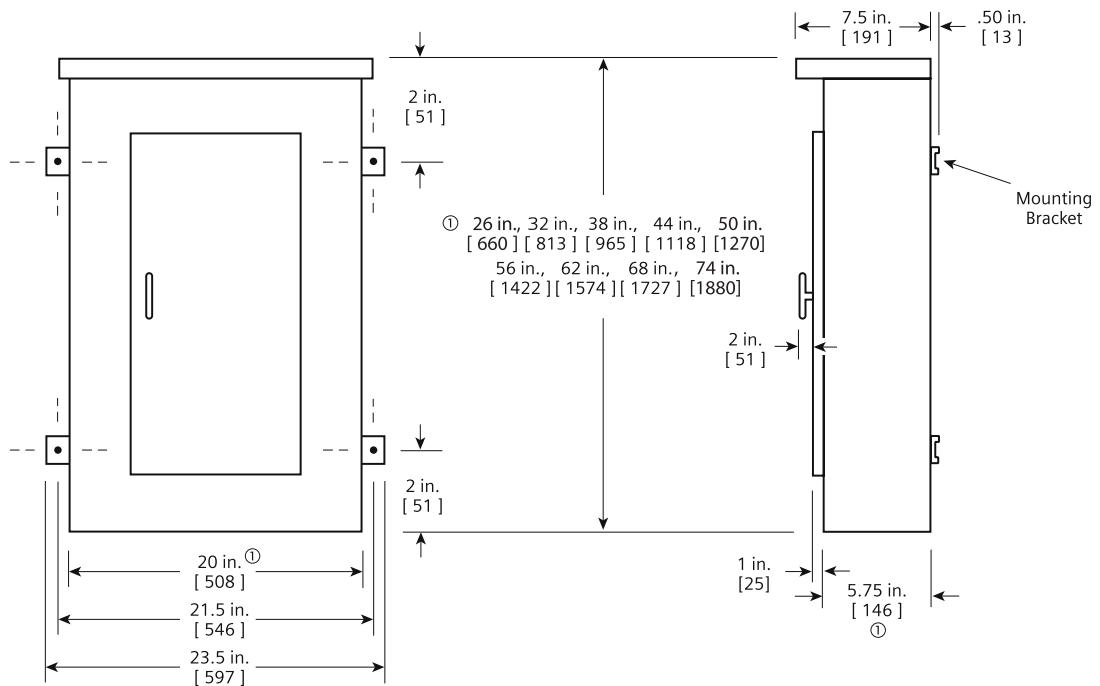

① Dimensions are interior of the box. Add 5/8" to width for absolute dimension. Add 1/8" to height for absolute dimension.

Dimensions shown in inches and millimeters [].

Panelboards

Type P3 Panelboards

General

Features

Another innovation from Siemens is the P3 panel. It is a smaller, footprint distribution panel to fit a large number of applications that require more (or larger) branch devices than the lighting panel class offer. This panel offers a wide array of factory-assembled options, and has the ability to mix breaker frames in unit space up to 250 amps. Bussing options for the P3 vary from the standard aluminum to copper designs. All bussing in the P3 panel is tin-plated as a standard. Silver-plated copper is offered as an option on a copper bus. Subfeed lugs (up to 400 amp) are just a few of the options of this unique panel.

The P3 panel configurations, defined by the unit space, allow for a given amperage, main device, and box height. The P3 panel starts with a 56" high box. Breaker unit space can be mixed and matched to meet customer requirements. All 1" pole breakers (BL, BQD, ED, xGB frames) are mounted in 3" or 6" pole increments. Breakers frames, above 125 amps, are mounted in 6" single or twin breaker mountings. As an example panel, FD 250 amp and JD 400 amp breakers are mounted as subfeed breakers outside of unit space.

Like other distribution panels, the P3 panel can have blank space added into the panel to allow for future expansions or modifications. Any expansions or modifications must be in 3" increments. BL, BQD and ED frame breakers have 3" or 6-pole kits and can be mixed in unit space by these increments. Breakers of the same frame can cross from one mounting to another if contiguous. xGB frame breakers cannot be mixed with other frame types. Any expansion or modification must be in 3" increments also. QR frame breakers are mounted in 6" increments for two and three pole single and twin mounted units. Changes in the unit space length for BL, BQD, xGB, or ED frame breakers require an additional deadfront center strip kit. Check with sales or the factory for additional unit space kits.

Main Lug/Main Breaker

Enclosure – Standard Type 1 enclosure is 24" wide x 7.75" deep. X Box Height is determined by main device and unit space. See charts for box height.

Voltage – 600V AC max.
250V DC max.

Amperage – 800 amp max.

Short Circuit Rating –
200,000 A @ 480 Vac

100,000 A @ 600 Vac IR max.
symmetrical or equal to the lowest rated device installed unless a series rating is indicated. Panels with subfeed or feed-thru lugs without a main device, circuit breaker or fusible unit, are limited to a three-cycle rating. The three-cycle rating for the P3 panel is limited to 22 Kaic. Note that the main device may be mounted remote from the panel.

Bussing – The P3 panel has more options to meet market requirements. The standard bussing is aluminum. The rating is per the requirements of CSA C22.2 No.29 – the standard for panelboards. All aluminum bussing is tin-plated. Optional bussing for the P3 panel is copper. The copper bus option for this panel is tin-plated.

Weight – Approximate

Total panelboard weight when filled with a normal quantity of breakers and accessories is about 5 lbs. (1 kg) per inch (54g per mm) of box height.

Gauge Steel of Boxes Fronts, Surface & Flush

Dimensions in inches (mm)		Gauge Steel	
Width	Height	Box	Front
24" (610)	56 - 80" (1422, 2032)	#14	#14

Panelboards

Type P3 Panelboards

Selection/Dimensions

Panel Unit Space To Box Height Requirements

"B" Dimension Box Height	P3 Panels With Standard Line Lugs. Unit Space (starting with 9" and adding 6" increments) "A" Dimension				
	Main Lugs			Main Breakers	
	400A	600A	800A	400A JD	600A LD
56	21	21	21	9	9
62	27	27	27	15	15
68	33	33	33	21	21
74	39	39	39	27	27
80	45	45	45	33	33

Main Lug Wire Bending

Panel Amps	Standard Connectors	C	D
400	(2) #3/0 AWG - 250 kcmil or (1) 600 kcmil	16.00	17.88
600	(2) #3/0 AWG - 500 kcmil	16.00	17.88
800	(2) 600 kcmil	16.00	17.88

Main Breaker Wire Bending - Inches (mm)

Panel Amps	C	E	F
JD	—	15.63 (397)	29.38 (746)
LD	—	14.75 (375)	29.38 (746)

Ⓢ This lug is removable.

Main Breaker Wire Bending Diagram

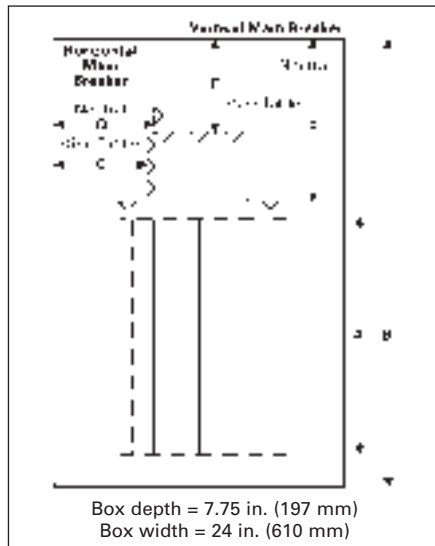

Main Breaker Wire Bending

Main Lug Wire Bending Diagram

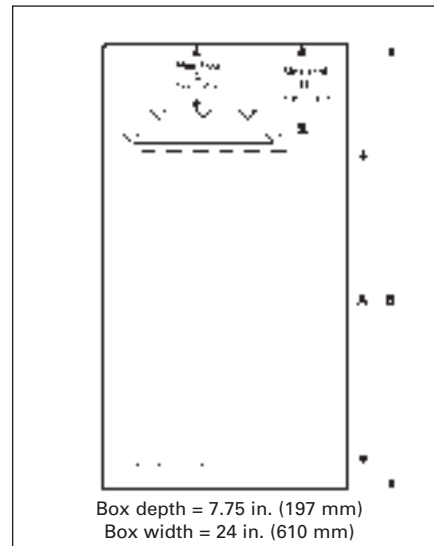

Main Lug Wire Bending

Branch Breaker Side Gutters Inches (mm)

Reference Letter	Panel Width 24" (609)
A	7.750 (197)
B	7.125 (181)
C	6.000 (152)
D [Ⓢ]	7.000 (178)
E	5.000 (127)
F	6.625 (168)

Ⓢ Single branch mounting construction.

Branch Breaker Wire Bending Diagram

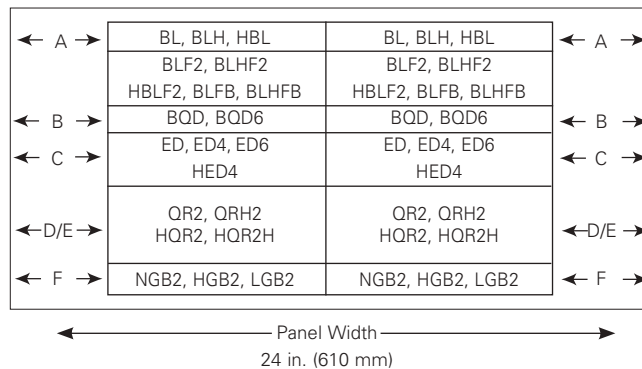

Branch Breaker Side Gutters

Panelboards

Type P3 Panelboards

Selection

Alternate Main Breakers

Ampere Rating	Breaker Type	Maximum Interrupting Rating (kA)			Ref. Catalogue Number	Available Configurations ^②			Available Trip Values
		240V	480V	600V		240V AC	480V AC	600V AC	
400	JXD6 ^①	65	35	25	JX	STD	STD	STD	200, 225, 250, 300, 350, 400
	JD6 ^①	65	35	25	J6	STD	STD	STD	200, 225, 250, 300, 350, 400
	HJXD6 ^①	100	65	35	H6	ADD	ADD	ADD	200, 225, 250, 300, 350, 400
	HJD6 ^①	100	65	35	H5	ADD	ADD	ADD	200, 225, 250, 300, 350, 400
	SJD6 ^①	65	35	25	SJ	ADD	ADD	ADD	200, 300, 400
	SHJD6 ^①	100	65	35	S2	ADD	ADD	ADD	200, 300, 400
600	LXD6 ^①	65	35	25	LX	STD	STD	STD	450, 500, 600
	LD6 ^①	65	35	25	L6	STD	STD	STD	250, 300, 350, 400, 450, 500, 600
	HLXD6 ^①	100	65	35	HL	ADD	ADD	ADD	250, 300, 350, 400, 450, 500, 600
	HLD6 ^①	100	65	35	HO	ADD	ADD	ADD	250, 300, 350, 400, 450, 500, 600
	SLD6 ^①	65	35	25	SL	ADD	ADD	ADD	300, 400, 500, 600
	SHLD6 ^①	100	65	35	S6	ADD	ADD	ADD	300, 400, 500, 600

① Vertically mounted

② STD = Standard configuration. ADD = Additional cost.

Panelboards

Type P3 Panelboards

Selection

Branch Circuit Breakers

Max. Amp Rating	Bolt-On Breaker Type	Amps	Provisions for Maximum Interrupting Rating (kA)								
			120V AC	120/240V AC	240V AC	277V AC	480V AC	600V AC	250V DC		
70	BQD6	15-70	—	65	65	—	—	—	10	14	
100	BL	15-60	10	—	—	—	—	—	—	—	
		70	—	10	—	—	—	—	—	—	
		80-100	—	—	10	—	—	—	—	—	
	BLH	15-60	—	—	22	—	—	—	—	—	—
		70	—	—	22	—	—	—	—	—	—
		80-100	—	—	—	22	—	—	—	—	—
	HBL	15-55	—	—	65	—	—	—	—	—	—
		60-100	—	—	—	65	—	—	—	—	—
	BLR (240V)	15-60	—	—	—	10	—	—	—	—	—
		70-100	—	—	—	—	10	—	—	—	—
	BLE (GFCI)	15-30	10	—	—	—	—	—	—	—	—
		40-60	—	10	—	—	—	—	—	—	—
	BLEH (GFCI)	15-30	22	—	—	—	—	—	—	—	—
15-60		—	22	—	—	—	—	—	—	—	
BLF (GFCI)	15-30	10	—	—	—	—	—	—	—	—	
	40-60	—	—	10	—	—	—	—	—	—	
BLHF (GFCI)	15-30	22	—	—	—	—	—	—	—	—	
	40-60	—	—	22	—	—	—	—	—	—	
HBLF2 (GFCI)	15-30	65	—	—	—	—	—	—	—	—	
	15-20	10	—	—	—	—	—	—	—	—	
BAF	15-20	22	—	—	—	—	—	—	—	—	
	15-20	—	22	—	—	—	—	—	—	—	
BQD	15-60	—	—	65	—	—	—	14	—	14	
	70-100	—	—	—	65	—	—	14	—	14	
125	NGB2	15-125	100	100	100	25	25	14	14	14 [ⓐ]	
		15-125	100	100	100	35	35	22	22	14 [ⓐ]	
		15-125	100	100	100	65	65	25	25	14 [ⓐ]	
	ED4	15-60	65	—	—	22	—	—	—	—	—
		70-100	—	—	65	—	18	—	—	—	30
		110-125	—	—	65	—	18	—	—	—	—
	ED6	15-60	—	—	65	—	25	18	—	—	30
		70-100	—	—	65	—	25	18	—	—	—
		110-125	100	—	—	—	—	—	—	—	—
	HED4	15-60	100	—	—	—	—	—	—	—	—
70-100		—	—	—	65	—	—	—	—	—	
110-125		—	—	—	65	—	—	—	—	—	
225	QR2	100-225	—	—	10	—	—	—	—	—	
	QRH2	100-225	—	—	25	—	—	—	—	—	
	HQR2	100-225	—	—	65	—	—	—	—	—	
	HQR2H	100-225	—	—	100	—	—	—	—	—	

Subfeed Breakers (available in 2-pole or 3-pole)

Breaker Type	Mounting Position When Used as Subfeed Breaker	Ampere Ratings For Load	Maximum Interrupting Rating (kA) Symmetrical		
			240V AC	480V AC	600V AC
FD6 [ⓐ] , FXD6	Vertical	70-250	65	35	18
HFD6 [ⓐ] , HFXD6	Twin	70-250	100	65	25
JD6 [ⓐ] , JXD6	Single	200-400	65	35	25
HJD6 [ⓐ] , HJXD6	Single	200-400	100	65	35

Neutral Connectors

Wire Range	Max. Number of Connections	Max. Amps
#14-#1/0	44	125
#4 - 350 kcmil	6	250
(1)#4 - 600 kcmil or (2)#6 - 250 kcmil	1	400

NOTE: QR Breakers are twin mounted in unit space and take 6" of unit space. Limited to (6) per panel max. BL, HBL, BLH and BQD breakers are mounted in common mountings in 3" or 4) pole increments. ED2, ED4, ED6 and HED4 breakers are mounted in common mountings in 3" or (6) pole increments.

ⓐ Twin mounted subfeed breakers are mounted at bottom of panelboard only and adds 24" to the panel height.
 ⓑ Subfeed breaker is mounted at bottom of panelboard only. 400 amp subfeed breaker adds 30" to the panel height.

ⓐ 2-pole only (or) two outer poles of 3-pole breaker.

Panelboards

Type P3 Panelboard Modifications and Additions

Selection

Enclosures

Extra Gutter to Sides or Ends of the Can (Type 1 Only)

Description
6" end gutter 2" side gutter Barrier in gutter (add to extra gutter price – min 4" required)
Hinged trims Piano hinged trims Door-in-door trims Screw to the box trims
Trim mounted devices <ul style="list-style-type: none"> • Pilot lights • Toggle switches • Push buttons
Painted boxes Custom colours Increase gauge trims and boxes Stainless steel trims, Type 1

Meters

(Contact sales for pricing and application engineering for space requirements)

Panel Skirts

See page 10-64

Panel Bus Modifications

Represented by "A", "C" or "E" in the 11th digit of the catalogue number

Standard bussing is tin plated Al, alternate bus bar material can be selected: <ul style="list-style-type: none"> ▪ Tin plated copper ▪ Silver plated copper - optional

Subfeed and Feed-Thru (for 2-pole or 3-pole)

Ampere Rating	Connector Cu / Al Wire Range	Unit Space (inches)
---------------	------------------------------	---------------------

Subfeed (Double) Lugs for Main Lug Panelboards Only

225/250	(2) – #6 AWG-350 kcmil	6
400	(2) – 250 kcmil (1) – 600 kcmil	6

Feed-Thru Lugs – Cannot Be Used in Conjunction with SPD or Subfeed Breakers

See page <?> for unit space adders and compatibility with other options.

225/250	(1) – #6 AWG-350 kcmil	6
400	(2) – 250 kcmil (1) – 600 kcmil	6
600	(2) – 250-500 kcmil	9
800	(2) – 600 kcmil	12

Branch and Main Breaker Accessories

See page 10-44 and Breaker Section <ul style="list-style-type: none"> • Handle blocks • Handle locks • Aux. Contacts[Ⓞ] • UVR[Ⓞ]
--

Increase capacity neutral up to 200%

Main Bus Amps
125
250
400
600

See page 10-44 for unit space adders and compatibility with other options.

Copper MLO Only

Main Bus Amps
125
250
400
600

(Devices mounted and wired to the trim should also have hinged trim specified)

Surge Protection Device

See Section 10

Service Entrance Label

Type P3 Panelboards are factory labeled "SUITABLE FOR USE AS SERVICE ENTRANCE EQUIPMENT" when identified as "Service Entrance" at the time of order entry. For regulations governing this feature, please consult CEC, CSA or local electrical authorities.

P3 service entrance panels are available in type 1 enclosure only (indoor application) and come standard with plated copper.

Grounding of Panelboards

Ground Bars are shipped with the panel interior factory mounted.

- Non-Insulated Equipment Ground Bar
- Copper Non-Insulated Ground Bar
- Al Insulated Equipment Ground Bar
- Cu Insulated Equipment Ground Bar

Shunt Trip on Main or Branch

BL, BLH, HBL, BQD, ED4, HED4, ED6, HED6, QR2, QRH2, HQR2, HQR2H as branch only. BL, BLH, HBL, NGB2, HGB2, LGB2, ED2, ED4, HED4, ED6, uses 1" unit space for shunt trip. All others may be used on mains or subfeeds.

Ⓞ Accessories on 1" pole breakers (BL, BQD, ED) will take unit space.

Panelboards

Type P3 Panelboard Standard Modifications

Selection

Option Combinations

Amps	Incoming	Subfeed Lugs	Feed-thru Lugs	FDa Subfeed	JD ^① Subfeed	FD ^② Subfeed	200% Neutral	Min. Box Size (in.)	Unit Space (in)	
400 ^{②③}	Main Lug Only	•	—	—	—	—	•	56	21	
		—	•	—	—	—	•	56	15	
		—	—	•	—	—	•	56	9	
		—	—	—	•	—	•	56	9	
		—	—	—	—	•	•	62	9	
	Main Breaker (JD)	None Std.	—	•	—	—	—	•	56	9
		—	—	—	•	—	—	•	62	9
		—	—	—	—	•	—	•	68	9
		—	—	—	—	—	•	•	68	9
		—	—	—	—	—	•	•	74	9
600 ^{②③}	Main Lug Only	—	•	—	—	—	•	56	21	
		—	—	•	—	—	•	56	15	
		—	—	—	•	—	•	56	9	
		—	—	—	—	•	—	56	9	
		—	—	—	—	—	•	•	62	9
	Main Breaker LD	—	—	•	—	—	—	•	56	9
		—	—	—	•	—	—	•	62	9
		—	—	—	—	•	—	•	68	9
		—	—	—	—	—	—	—	68	9
		—	—	—	—	—	•	•	74	9
800 ^{②③}	Main Lug Only	—	•	—	—	—	•	56	21	
		—	—	•	—	—	•	56	9	
		—	—	—	•	—	•	56	9	
		—	—	—	—	•	—	56	9	
		—	—	—	—	—	•	•	62	9

① Subfeed lugs are currently not offered as standard with main circuit breakers.

② Subfeed lugs on panels above 400A are not standard.

③ 200% neutral cannot be provided along with a 400A subfeed breaker because the breaker blocks the 4th lug site.

Panelboards

Type P3 Panelboard Modifications and Additions

Selection

Compression Lugs

Style	Amp Rating	Breaker Type	Compression Connectors	Box Height Addition
MLO	400	N/A	(1) 250 - 500 kcmil or (2)# 1/0 AWG - 250 kcmil	—
	600	N/A	(2)#3/0 AWG - 500 kcmil	—
	800	N/A	(2) 400-750 kcmil Cu only	—
Main Breaker	400	JD6, JXD6, HJD6, SJD6, SHJD6	(2)#1/0 AWG - 500 kcmil Cu or Al	—
	600	LD6, LXD6, HLD6, SLD6, SHLD6	(2)#2/0 AWG - 500 kcmil Cu or Al	—

Alternate Lugs

Style	Amp Rating	Breaker Type	Standard AL Connectors	Box Height Addition
MLO	400	N/A	(1) 250 - 750 kcmil or (2)#3/0 AWG - 250 kcmil Cu or Al	6
	800	N/A	(3) 500 kcmil	6
	800	N/A	(4) 1/0-750 kcmil Cu or Al	6
Main Breaker	400	JD6, JXD6, HJD6, SJD6, SHJD6	(1)#4/0 AWG - 750 kcmil Cu or Al	6

Enclosure Modifications

24" Panel Width Description
Type 3R enclosures
Type 3R/12 enclosures ^①
Gasket between trim and box (Type 1)

Type 4X For Type P3^③

Water Tight, Dust Tight and Corrosion Resistant

(consult plant for actual enclosure size and for Type 4^② enclosures)

Box Height Inches	Enclosure – Stainless Steel		
	H	W	D
56	56	24	7.75
62	62	24	7.75
68	68	24	7.75
74	74	24	7.75
80	80	24	7.75

① 16 Gauge Cans w/ 14 Gauge Front)

② 14 Gauge only

③ 14 Gauge only - 304SS Std, 316SS Optional)

Panelboards

Type P3 Panelboard Kits and Accessories

Selection

Standard Enclosures

Box Height (in.)	Catalog Number				
	Type 1 Standard Trim			Type 3R	Type 3R/12
	Box	Surface	Flush		
56	24WD56	P3S56	P3F56	24NRD56	24WPD56
62	24WD62	P3S62	P3F62	24NRD62	24WPD62
68	24WD68	P3S68	P3F68	24NRD68	24WPD68
74	24WD74	P3S74	P3F74	24NRD74	24WPD74
80	24WD80	P3S80	P3F80	24NRD80	24WPD80

Options For Type 1 Trims

Items must be ordered as manual line item on factory
 Hinged trim – Add "H" suffix
 Door-in-door – Add "D" suffix
 Metal card holder - Add "M" suffix
 Provision for padlock - Add "-PL" suffix
 Service entrance application - Add "SE" suffix

Breaker Kits and Accessories

Kit Number	Description	Contents
BBKGB32 (P2/P3)	NGB2, HGB2, LGB2 3" branch breaker kit	Kit contains top barrier, (3) A/C connectors, (1) B connector, hardware
BBKB32 (P2/P3)	BL/BQD 6-pole 3" branch breaker kit	Kit contains top barrier, (3) A/C connectors, (1) B connector, hardware
BBKNB32 (P2/P3)	NGB, 6-pole 3" branch breaker kit	Kit contains top barrier, (3) A/C connectors, (1) B connector, hardware
BBKEB32 (P3)	HEB 6-pole 3" branch breaker kit	Kit contains top barrier, (3) A/C connectors, (1) B connector, hardware
BBKED32 (P2/P3)	ED 6-pole 3" branch breaker kit	Kit contains breaker support, inter-phase barriers, (3) A/C connectors, (1) B connector, hardware
BBKQR2 [Ⓞ]	P3 twin BKR mounting kit for 1-phase/3-phase.	Kit contains all connectors and cover plates necessary to mount both 2 and 3-pole breakers
DFK1	BL, BQD, ED deadfront kit for 1" pole breakers	Center strips 3", 6", 9", 15", 21" plus mounting hardware
DFFP3	Deadfront filler 3"	3" empty space filler and hardware
DFFP6	Deadfront filler 6"	6" empty space filler and hardware
P3BK1	P3 bonding kit	Bonding strap and hardware
EBF1	HEB/NEB Filler Plate	Filler Plate
BBKQRP2FK	P3 Filler for QR. Dual mount horizontal. 1-phase/3-phase.	Kit contains all cover plates necessary to change from QJ to QR both 2 and 3-pole breakers. For 1-phase panel, both breakers must change from QJ to QR, cannot have one of each installed.

[Ⓞ] Although QR is rated 250A, it is limited to 225A in panelboard.

Type P3 Panelboards

Miscellaneous Parts and Accessories

Catalogue Number	Description
EGK	Al Ground Bus 44 Connections
BK1	Bonding kit for 250A max. and all P1 panels
IMK1	Interior Adjusting Kit
9271-1	Directory Card Holder
NBK3	1 Numbering Button Kit "Snap-in" type 1 @ 42
NBK4	1 Numbering Button Kit "Snap-in" type 43 @ 84
NBK5	1 Numbering Button Kit "Snap-in" type 85 @ 126
NBK6	Number Strips 127-168.
NBK7	Number Strips 169-210.
NBK8	Number Strips 211-252.
ECGK	Cu Ground Bus 44 Connections
IGK	Insulated Al Ground Bus
ICGK	Insulated Cu Ground Bus
EWK2	End Wall Kit with Knockouts (24" W x 7.75" D)
DFFP1	1" Filler Plate (Suitable for replacing QF3 in P1 thru S5 Panelboards and Switchboards)
P3BK1	P3 Bonding Kit
JCK24	24 trim screws and 24 trim clips
DFK1	BL, BQD, ED deadfront kit for 1" (include 7 different length centre strips)
12-1110-01	1 Directory card for 1-42 circuits
MCHK	1 Metallic directory card holder
FPLK2	2 Spare Fas-latch trim locks with 2 keys
DSK724	1 Dripshield 24"W x 7.75"D

Panelboards

Type P3 Panelboards

Dimensions

Type 1 Box

Box is symmetrical

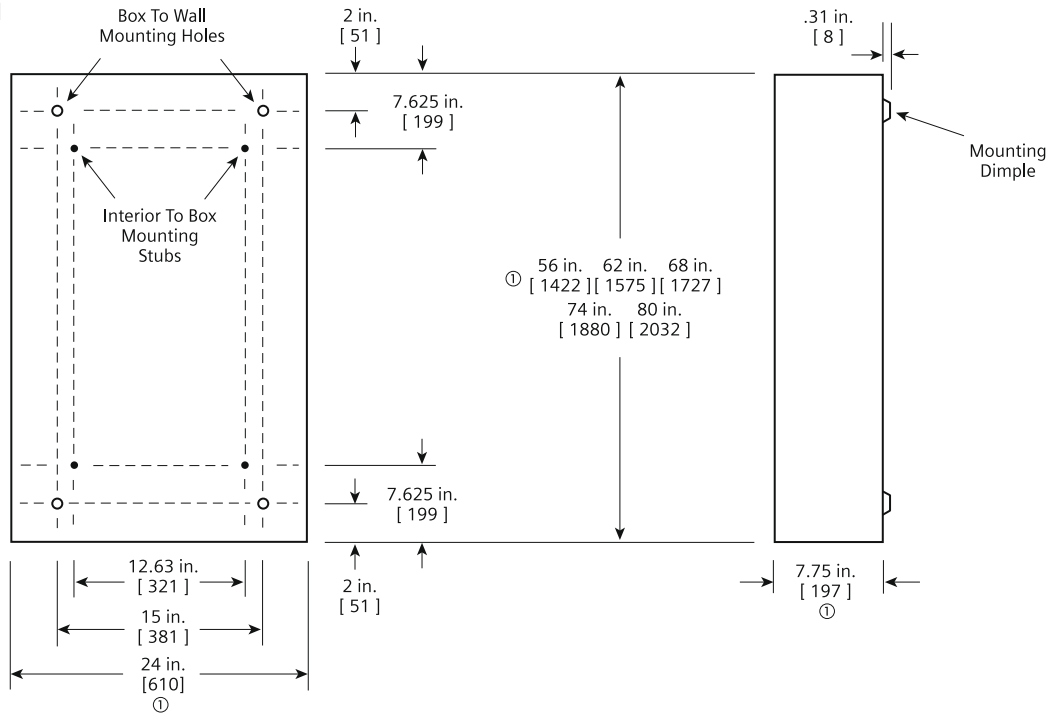

Type 3R and 3R/12 Box

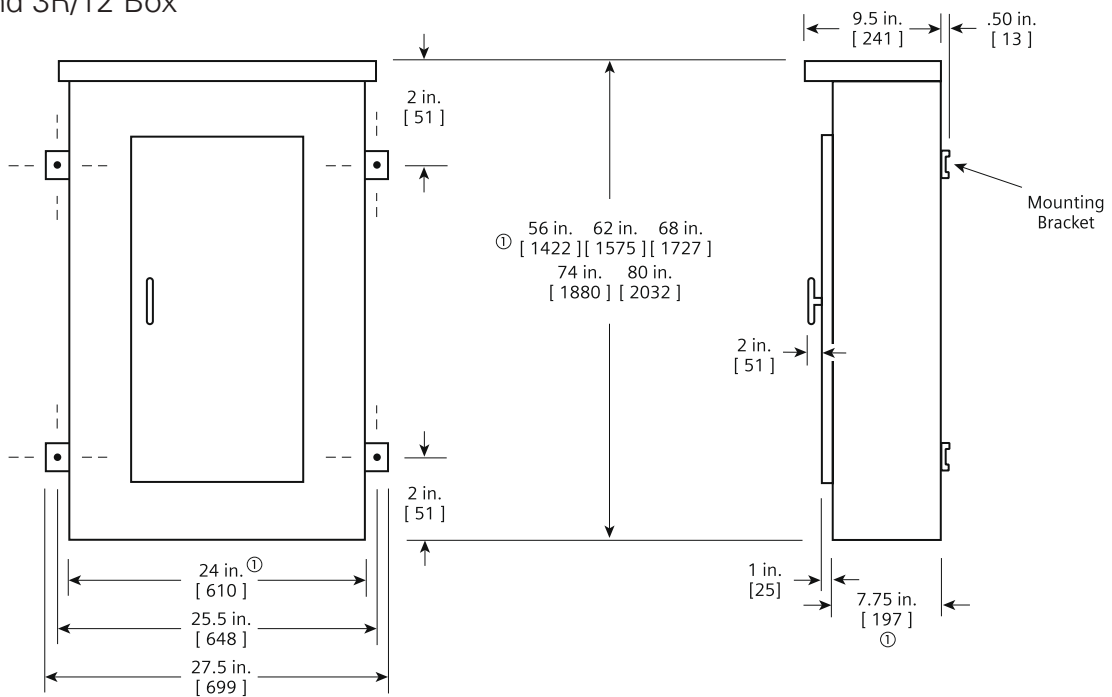

①Dimensions are interior of the box. Add 5/8" to width for absolute dimension. Add 1/8" to height for absolute dimension.
Dimensions shown in inches and millimeters [].

Panelboards

Lighting Panel Filler Plates

Filler plates are required for many applications, and over time Siemens has developed many different parts. The charts provided below are to help aid in determining which plate is needed for specific applications. Order by catalogue number for the proper filler plate.

Ref.	Panel Type	Breaker Position	Breaker Type	Orientation	Catalogue No.
A	P1 & RP1, P2, P3, C1, C2	Branch & Main ^a	BL/BQD/xGB/xGB2/ED [ⓐ]	Horizontal or Vertical (as needed)	DFFP1 [ⓐ]
B	P1 & RP1, C1	Main / Subfeed	Blank - No Breaker	Horizontal or Vertical	DFFP01ACAN
C	P1 & RP1	Main / Subfeed	ED, BL/BQD or xGB	Horizontal	DFFPED01CAN
D	P1 & RP1	Main / Subfeed	QJ 2-pole	Horizontal	DFFPQJ02CAN
E	P1 & RP1	Main / Subfeed	QJ 3-pole	Horizontal	DFFPQJ01CAN
F	P1 & RP1	Main / Subfeed	QR	Horizontal	MBKQRFK
G	P1 & RP1	Main / Subfeed	FD	Horizontal	DFFPFD01CAN
H	P1 & RP1	Main	JD	Vertical	DFFPJD01CAN
I	P2 & P3	Branch	BL/BQD/xGB/xGB2/ED	N/A [ⓐ]	DFK1
J	P2 & P3	Branch	Blank - No Breaker	Horizontal	DFFP3
K	P2 & P3	Branch	Blank - No Breaker	Horizontal	DFFP6
L	P2	Branch	QR	Horizontal or Vertical	BBKQRP1FK
M	P3	Branch	QR	Horizontal	BBKQRP2FK
N	P3	Branch	NEB/HEB	Horizontal	EBF1
O	P3	Branch	BL/BQD/xGB/xGB2/ED	Horizontal	DFFP3AP01CAN

[ⓐ] See next page for more specific information.

[ⓐ] QF3/DFFP1 compatibility

- DFFP1 fits tighter in the opening than the QF3 (small spring tabs are stronger on the sides, but otherwise almost identical), thus DFFP1 will not slide out of place without some force being applied.
- In a P1-P2-P3 deadfront, a QF3 will slide out of position when the deadfront is removed from a panel. This makes it difficult to put the deadfront back on the panel.
- Both the QF3 and DFFP1 are approved for use in all panelboards and switchboards. However, only QF3 is approved for use in residential products (load centers, meter combos, etc.).

Panelboards

Lighting Panel Filler Plates

Ref.	Catalogue No.	Catalogue Description / Comments	Filler Plate Eng Ref No.	Filler Description
A	DFFP1	1" Branch circuit filler plate (Used for BL/BQD/xGB/xGB2/ED blank positions. Suitable for replacing QF3 in P1-P5 Panelboards and Switchboards) - Also used to fill void where a 2-pole breaker is installed in a 3-pole position in various applications.	11-D-4554-01	Blank Filler 1"
B	DFFP01ACAN	P1 Main Blank Filler Plate - 1 Piece (use for Original or Revised P1 - also replaces 12-A-1801-01) (Vertical for 400A Main)	11-D-4560-01 [®] (replaces 12-A-1801-01)	P1 Blank Filler Plate
C	DFFPED01CAN	P1 Main Filler 100-125A frames ED, BL/BQD or xGB	12-A-1802-01	P1 100-125A frame Filler Plate
D	DFFPQJ02CAN	P1 QJ Main Filler Plate 2 pole - 1 Piece	12-A-1804-02	P1 QJ Filler Plate
E	DFFPQJ01CAN	P1 QJ Main Filler Plate 3 pole - 1 Piece	12-A-1804-01	P1 QJ Filler Plate
F	MBKQRFK	P1/Revised P1 Filler for 1PH/3PH QR. Horizontal Mount only.	11-D-4563-01 [®]	P1 QR Filler Plate
G	DFFPFD01CAN	P1 FD Main Filler Plate - 1 Piece	12-A-1803-01	FD Filler Plate
H	DFFPJD01CAN	P1 JD Main Filler Plate - 1 Piece	11-D-4522-01	Deadfront Filler 400 - 800A Breaker
I	DFK1	BL, BQD, ED deadfront kit for 1" pole breakers - Center strips 3", 6", 9", 12", 15", 18", 21" plus mounting hardware	multiple parts 11-D-3018-01 thru ...-07	Center strips included (7 sizes) 3", 6", 9", 12", 15", 18", 21" (branch height)
J	DFFP3	Deadfront filler, 3" steel blank filler plate (one each P2 & P3)	11-D-3014-02 11-D-3035-02	P2 Blank Deadfront Plate 3" P3 Blank Cover Plate 2.97"
K	DFFP6	Deadfront filler, 6" steel blank filler plate (one each P2 & P3)	11-D-3014-01 11-D-3035-01	P2 Blank Deadfront Plate 6" P3 Blank Cover Plate 5.97"
L	BBKQRP1FK	P2 Filler for QR. Horizontal or vertical mount. Contains all cover plates necessary to change from QJ to QR (both 2 and 3-pole breakers).	11-D-3282-01 11-D-4563-01 [®] 11-D-4564-01	QR Deadfront Plate P1 QR Filler Plate P2 QR Deadfront Filler
M	BBKQRP2FK	P3 Filler for QR. Dual mount horizontal. - Kit contains all cover plates necessary to change from QJ to QR (both 2 and 3-pole breakers). For 1-phase panel, both breakers must change from QJ to QR; cannot have one of each installed.	11-D-4565-01 11-D-3283-01 11-D-3284-01 11-D-3288-01 12-6812-34	P3 QR Deadfront Filler P3 DUAL QJ Deadfront Plate P3 DUAL QJ Deadfront Plate P3 QR-QJ Combo Deadfront Plate Breaker Blank Filler
N	EBF1	EB Filler Plate	11-D-4529-01	EB Deadfront Filler
O	DFP3AP01CAN	Used for filling space in a P3 deadfront when a BL, BQD, ED, xGB or GB2 branch breaker is installed. Can be replaced in field if lost or damaged.	11-D-3033-01	P3 BL/BQD/xGB/xGB2/ED Adapter Plate 3 inch - 1 Piece per pack.

© Bulk/OEM Kits available.

Ref.	Filler Plate Eng. Ref. No.	OEM/Bulk Catalog	Catalogue Description	Carton Qty.
A	11-D-4554-01	K11D455401CAN	RP1 Bulk 1" Blank Filler DFFP1	1300
B	11-D-4560-01	K11D456001CAN	RP1 Blank Filler - Main or Subfeed	158

Bulk/OEM kits are available in carton quantities only and are non-returnable.

Panelboards

Lighting Panel Kits

Based on customer and sales feedback, new field-installable kits are now available. These kits will provide easy access to parts and assemblies needed for field replacement or installation.

Ref.	Catalogue No.	Description	Primary Part Ref.	Comment / Intended use
A	LPDC01CAN	Panelboard directory card, 5.5"x 5" - 8 pieces per pack	9270-1 9270-3 9270-8 9270-9	New directory card kit includes 8 cards. New cards have 1-42, 43-84, 85-126, and 127-168 circuits..
B	BNK2	P2 neutral 3-step lug - Tin-plated aluminum - 1 piece per pack with mounting hardware	11-A-1862-01	Used in P2 neutral assemblies and can be replaced in the field. 14 connections for #6-1/0 wire and 12 connections for #14-#6 wire
C	BNK350NCAN	Narrow 350 KCMIL lug - Tin-plated aluminum - 1 piece per pack with mounting hardware	11-A-1869-01	Used in P2/P3 neutral, ground and other locations. Replaceable in the field as needed. One #6-350KCMIL connection.
D	LPP2NB01CAN	P2 Neutral 2-Step lug - Tin-plated aluminum - 1 piece per pack with mounting hardware	15-A-1800-01	Used in P2 neutral assemblies and can be replaced in the field. Three connections for #6-1/0 wire and 18 connections for #14-#6 wire.

Figure B

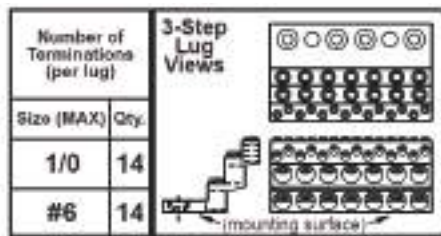

Figure C

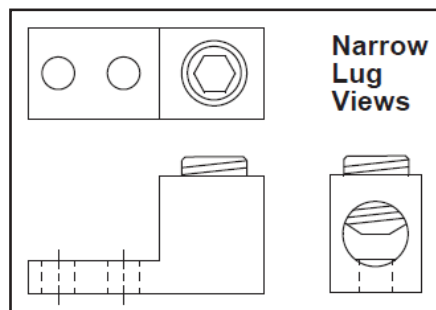
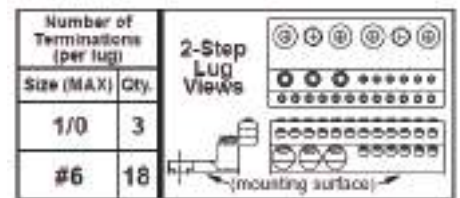

Figure D



Panelboards

Lighting Panel Kits

Ref.	Catalogue No.	Description	Primary Part Ref.	Comment / Intended use
E	JCK24	J-Type speed nut - lighting panel fronts - 24 pieces per pack	11-A-1820-01	Replacement J-nuts for use with lighting panel fronts and deadfronts. Also used in miscellaneous other applications.
F	DFFP01ACAN	P1 Main blank filler plate - 1 piece per pack	11-D-4560-01	Use for original or revised P1 and other horizontal mount applications (Vertical for 400A Main). Also replaces 12-A-1801-01 from legacy panels.
G	DFFPED01CAN	P1 ED Main filler plate - 1 piece	12-A-1802-01	Use for original or revised P1 and other horizontal mount applications.
H	DFFPFD01CAN	P1 FD Main filler plate - 1 piece	12-A-1803-01	Use for original or revised P1 and other horizontal mount applications.
I	DFFPJD01CAN	P1 JD Main filler plate - 1 piece	11-D-4522-01	Use for original or revised P1 400A main.
J	DFFPQJ01CAN	P1 QJ Main filler plate 3-pole - 1 piece	12-A-1804-01	Use for original or revised P1 and other horizontal mount applications.
K	DFFPQJ02CAN	P1 QJ Main filler plate 2-pole - 1 piece	12-A-1804-02	Use for original or revised P1 and other horizontal mount applications.
L	DFK-21 [Ⓞ]	P2 Deadfront center plate 21" - 1 piece	11-D-3018-07	Individual deadfront center plate 21 inches of unit space for P2 deadfronts
M	DFK-24 [Ⓞ]	P2 Deadfront center plate 24" - 1 piece	11-D-3018-08	Individual deadfront center plate 24 inches of unit space for P2 deadfronts
N	DFF3AP01CAN	P3 BL/BQD/ED/xGB adaptor plate 3" - 1 piece per pack	11-D-3033-01	Used for filling space in a P3 deadfront when a BL, BQD, ED or GB branch breaker is installed. Can be replaced in field if lost or damaged.
O	LPKEY01ACAN	Key for FAS-Latch lock - 4 pieces per pack	B363A	Replacement key for FAS-Latch lock - standard key only - Contact Customer Support for special keys.
P	LPKEY01BCAN	Key for FAS-Latch lock - 25 pieces per pack	B363A	Replacement key for FAS-Latch lock - standard key only - Contact Customer Support for special keys.
Q	FPLK2	FAS-Latch lock with 2 keys, 14-16 gauge door - for Lighting Panel Type 1 front	11-1895-01	Replacement lock for use when door thickness is 14-16 gauge painted steel - approx. 0.07-0.09" thick.
R	LPLOCK02ACAN	FAS-Latch lock with 2 keys, 12 gauge door - for Lighting Panel Type 1 front	11-1895-02	Replacement lock for use when door thickness is 12 gauge painted steel - approx. 0.10-0.12" thick.
S	LPLOCK03ACAN	FAS-Latch lock with 2 keys, 10 gauge door - for Lighting Panel Type 1 Front	11-1895-03	Replacement lock for use when door thickness is 10 gauge painted steel - approx. 0.13-0.15" thick.

Figure E

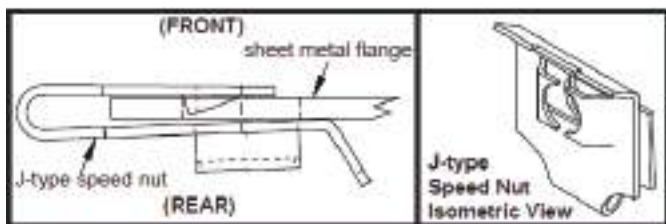
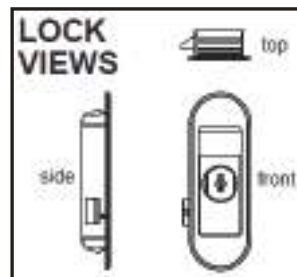

Figure Q, R, S



For more information visit: www.siemens.ca/powerdistribution.

[Ⓞ] Dead front center plates are available in 3" increments (starting with 3" and up to a maximum of 57"). DFK1-X where "X" represents the deadfront center length in inches.

Panelboards

B74FLR Enclosures & Related Bottom Covers

Quick & Easy Installation Features

This "universal fit" enclosure is capable of sitting on the floor or over the conduit, eliminating the need to extend conduit or cut knockouts. If installed correctly, there will be no need for a panel skirt.

This enclosure includes two bottom endwalls: a standard and a special endwall with a cutout. The standard endwall is mounted at the bottom as usual, and the special endwall is mounted above it with two screws. By removing the standard endwall and moving the special endwall to the lower position, the enclosure can be mounted around conduit stubbed up from the floor.*

Any size P1 or P2 interior from 26" to 74" can fit in this 20" wide enclosure with the proper lower cover installed. See chart below for part numbers (See back for details).

The bottom section of the enclosure left open by all fronts (except the 74" front) will require a special lower cover installation. These are available in both surface and flush variations in six-inch increments from 6" - 48" height, to match the front "void" sizes. The chart to the right shows which lower covers are available for the interior selected.

Contractor Labor Savings

When installed to code, the labor to cut knockouts and extend conduit to the bottom endwall is eliminated.

Instruction Sheets:

Enclosure: B74FLR Instructions
 Lower Cover: BXXCVR Instructions
 Endwall Kit: EWK3 Instructions

Enclosure Part Number: B74FLR

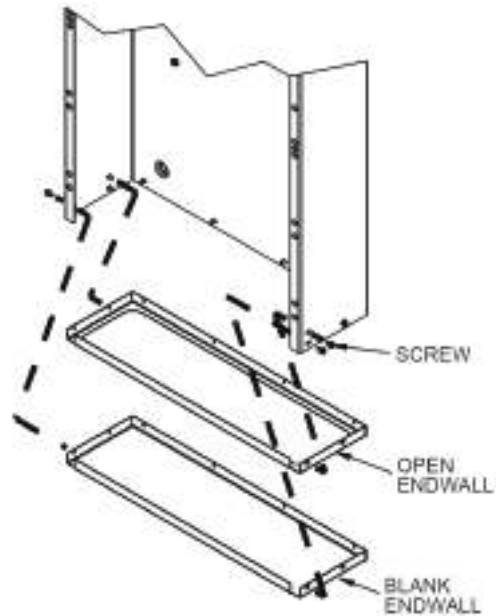

Standard Box Size	Standard Front Size	Required Lower Cover			
		Flush Mounted		Surface Mounted	
26" x 20"	26"	48"	BXXCVR48F	48"	BXXCVR48S
32" x 20"	32"	42"	BXXCVR42F	42"	BXXCVR42S
38" x 20"	38"	36"	BXXCVR36F	36"	BXXCVR36S
44" x 20"	44"	30"	BXXCVR30F	30"	BXXCVR30S
50" x 20"	50"	24"	BXXCVR24F	24"	BXXCVR24S
56" x 20"	56"	18"	BXXCVR18F	18"	BXXCVR18S
62" x 20"	62"	12"	BXXCVR12F	12"	BXXCVR12S
68" x 20"	68"	6"	BXXCVR06F	6"	BXXCVR06S
74" x 20"	74"	0"	None Required	0"	None Required

*Contractor is required to seal and install as required per local/national codes.

Panelboards

B74FLR Enclosures & Related Bottom Covers

The enclosure to the right shows two mounting studs at the top which are used for all sizes of P1/P2 panels that fit 20" wide x 5.75" deep enclosures. There are two studs at the bottom for mounting a 74" interior (Note: Interior sizes reference the standard enclosure size needed for the interior and front). The 74" can fits the 74" interior and front without any additional covers.

As interiors get shorter in six-inch increments, lower covers are needed to fill the space below the interior and standard front. Mounting holes and hardware are provided for attaching the bottom of the base rails.

Example: A 44" interior is 30" shorter than a 74" enclosure so it will need a 30" lower cover. Pick Surface or Flush to match the front.

Fronts available to use

- Standard FasLatch Front
 - Screw-to-box front (standard & piano hinge)
- Hinge-to-box front (standard & piano hinge)
- Door-to-door front (standard & piano hinge)

Note: Although stainless steel piano hinge fronts are available, stainless steel lower covers are NOT available at this time.

Special endwall retrofit kit: EWK3

This kit includes the "open" endwall that can be used to replace a standard endwall in any 20" wide x 5.75" deep enclosure if needed for special mounting situations. Contractor is responsible to seal and secure per local/national codes.

Note: This B74FLR Enclosure is cULus Listed as a Electric Cabinet Box and when additional gutter space is available (beyond the required minimum Enclosure size required by the Panel Interior), this additional Gutter space is considered part of the Enclosure and does not require special wiring rules that apply to a "wire way". It is not a Panel Skirt, although in some cases it can be used in place of an Enclosure plus a panel skirt when installed per local and National codes.

Think of this as you would a "Switchboard Enclosure" resting on the floor, similar wiring rules should apply to the open bottom.

Enclosure Part Number: B74FLR

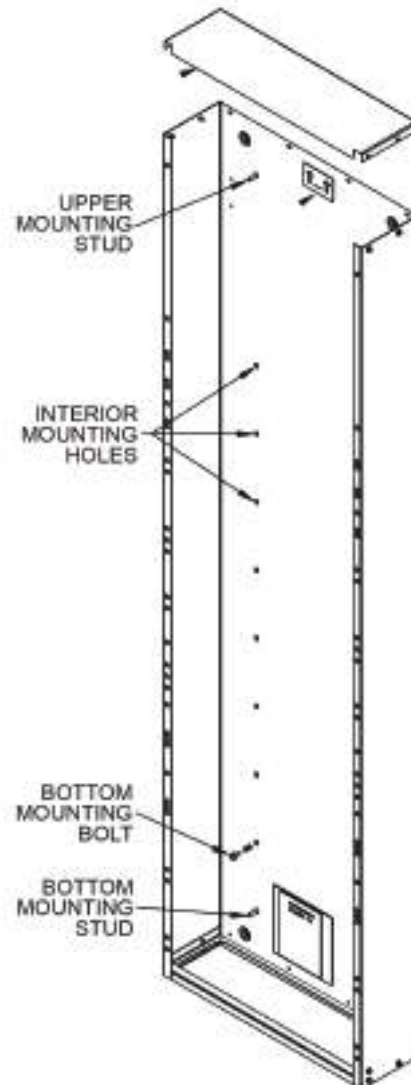

SIEMENS

TOP
↑ RR 6, RR12 ONLY ↑
(FOR TYPE 2012 USE UL LISTED MAIN BREAK CONDUIT HUBS)

S.O.	300 123 4567		
ITEM	020012		
CUSTOMER MARKING			
DATE	02/23/18		
CATALOG NO.	B74FLR		
ENCLOSURE TYPE	1		
BOX DIMENSIONS	5.75 Dp. x 20 W. x 74 H.		
LOCATION	D		

SEISMIC INSTALLATIONS ONLY:			
ENCLOSURE TYPE	GRADE 3 HARDWARE (QTY)	TORQUE (LBS-FT)	
1	1/2"-13 (4)	60	
3RD-12	3/8"-18 (8)	30	

1. Use hardware & tighten per table above.
2. Enlarge mounting holes if required.
3. See marking on drawings for seismic compliance.

MAIN BREAKER CONDUCTORS

NOTES:
• All line conductors should enter and leave enclosures in this pattern.
• The gauge is typical for each side of the enclosure. Gauges may be different on some panels.

USE SIEMENS EQUIPMENT GROUND BUS		Grid, bus location
TYPES: ESK, JJK, ECK, LCK		
Torque required to secure wire sizes listed below:		
Small Terminal	Large Terminal	
(1-2) Wires #14-#12 20 (lb-in)	(1-3) Wires #14-#10 35 (lb-in)	
(1) Wire #8-#6 25 (lb-in)	(1) Wire #8 40 (lb-in)	
(1) Wire #6-#4 30 (lb-in)	(1) Wire #6-#4 45 (lb-in)	
	(1) Wire #3-#2 50 (lb-in)	

Type 1, RR 6, RR 12 Enclosure
Siemens Industry, Inc.
Norcross, Georgia
15Jul2018 Rev. 2

Example of Label provided on each enclosure with UL/cULus marking

Panelboards

Power and Distribution

Selection

Type S5 (SPP6)

**600 Volts AC, 250 Volts DC Maximum
1200 Ampere Mains
1200 Ampere Maximum Branch
UL & CSA Short Circuit Rating —
200,000A IR Maximum**

**Branch Breaker Symmetrical
Interrupting Capacity**

**Based on Underwriters' Test
Procedure**

Meets 1996 NEC wire bending requirement, section 373-6.
CSA - C22.2 No. 0.12

Panelboards

Listed by Underwriters' Laboratories, Inc., under "Panelboards" File #E2269 for interiors and #E4016 for boxes and fronts. Meet Federal Specification W-C375B/Gen. & CSA File #LR93833.

Service

600 Volts AC, 250 Volts DC, Maximum.
1 Phase, 3 Wire; 3 Phase, 3 Wire; or
or 3 Phase, 4 Wire.

Panelboard Fronts and Doors

Standard panelboards are furnished with 4 piece trim with ventilation. Fronts are fabricated from code gauge steel and finished ASA61.

Main Breakers

All 400A and 1200A frame main breakers are mounted horizontally.

Main Lug Connectors

Ampere Rating	Connectors Suitable for Cu or Al
400	(1)-#3/0 AWG-500kcmil
400	(2)-#3/0 AWG-250kcmil
600	(2)-#3/0 AWG-500kcmil
800	(3)-#3/0 AWG-500kcmil
1200	(4)-#3/0 AWG-500kcmil

End Gutters

Ampere Rating	Main Lug (inches)	Main Breaker (inches)
400/600	15.967	13.0
800/1200	15.967	13.0

Boxes

38" wide, 12.75" deep (Type 1, 2)
38" wide, 14.25" deep (Type 3R/12)

Panelboard Specifications

Maximum Panel Ampere	Unit Space (MLO)	Box Height				
400A	30"	60"	120/240Volts 1 Phase, 3 Wire	120/208 Volts 3 Phase, 4 Wire	600 Volts 3 Phase, 3 Wire	347/600 Volts 3 Phase, 4 Wire
600A	45"	75"				
800A	60"	90"				
1200A	60"	90"				

Integrated Equipment Short Circuit Ratings

The term "Integrated Equipment Short Circuit Rating" refers to the application of series connected circuit breakers in a combination that allows some breakers to have lower individual interrupting ratings than the available fault current. This is permitted as long as the series combination has been tested and certified by UL & CSA.

Series ratings must be specified on order at time of entry.

Panelboards

Power and Distribution

Selection

Main Breaker Selection

Amperage Rating	Breaker Type	Trip Type	Maximum Interrupting Rating (kA)			Available Trip Values
			240V	480V	600V	
400	JXD6 JD6 HJD6 HHJD6 CJD6	Thermal Magnetic	65	35	25	200, 225, 250, 300, 350, 400
			65	35	25	200, 225, 250, 300, 350, 400
			100	65	35	200, 225, 250, 300, 350, 400
			200	100	50	200, 225, 250, 300, 350, 400
			200	150	100	200, 225, 250, 300, 350, 400
			200	150	100	200, 225, 250, 300, 350, 400
	SJD6 SHJD6 SCJD6	Electronic (Solid State)	65	35	25	200, 300, 400
			100	65	35	200, 300, 400
			200	150	100	200, 300, 400
600	LXD6 LD6 HLD6 HHL6 CLD6	Thermal Magnetic	65	35	25	450, 500, 600
			65	35	25	250, 300, 350, 400, 450, 500, 600
			100	65	35	250, 300, 350, 400, 450, 500, 600
			200	100	50	250, 300, 350, 400, 450, 500, 600
			200	150	100	450, 500, 600
	SLD6 SHLD6 SCLD6	Electronic (Solid State)	65	35	25	300, 400, 500, 600
			100	65	35	300, 400, 500, 600
			200	150	100	300, 400, 500, 600
			200	150	100	300, 400, 500, 600
800	MXD6 MD6 HMD6 CMD6	Thermal Magnetic	65	50	25	500, 600, 700, 800
			65	50	25	500, 600, 700, 800
			100	65	50	500, 600, 700, 800
	SMD6 SHMD6 SCMD6	Electronic (Solid State)	200	100	65	500, 600, 700, 800
			65	50	25	600, 700, 800
			100	65	50	600, 700, 800
1200	NXD6 ND6 HND6 CND6	Thermal Magnetic	65	50	25	800, 900, 1000, 1200
			65	50	25	800, 900, 1000, 1200
			100	65	50	800, 900, 1000, 1200
	SND6 SHND6 SCND6	Electronic (Solid State)	200	100	65	800, 900, 1000, 1200
			65	50	25	800, 1000, 1200
			100	65	50	800, 1000, 1200
200	100	65	800, 1000, 1200			

Branch Breaker Gutter Dimensions For 38"W Distribution Section (Table 5)

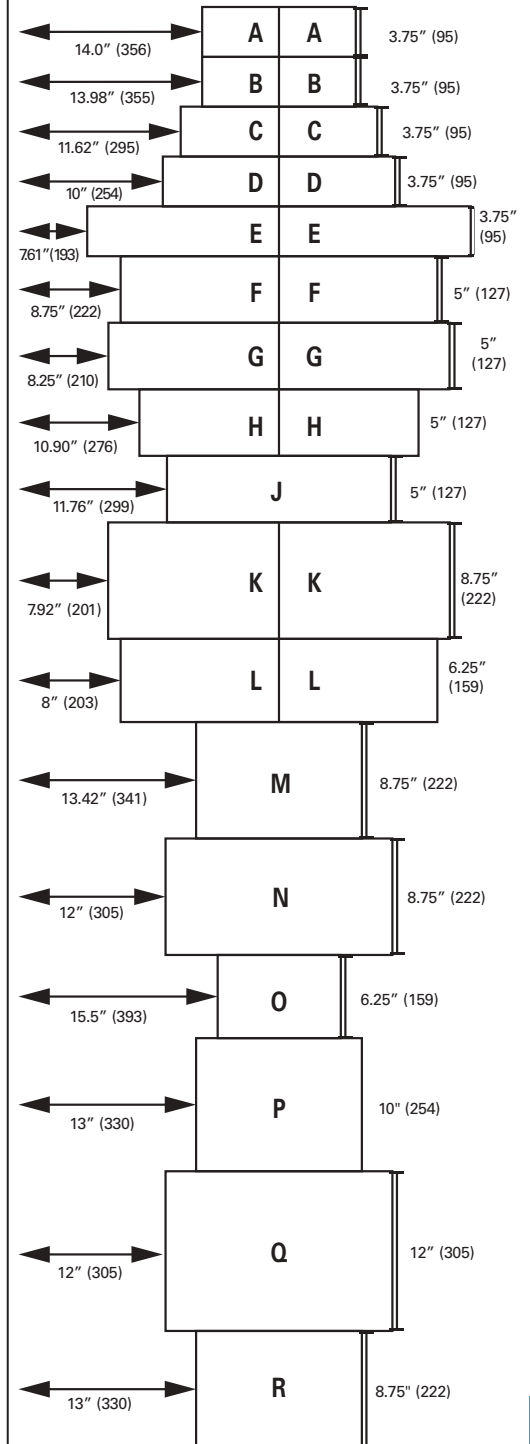

Panelboards

Modifications and Additions

Type S5

When required, special constructions or additions to standard panelboards may be specified for all **factory-assembled** Power and Distribution Panelboards. Below and on the next page are listed many of those available for Type S5 panelboards. In no case do these apply to **Narrow** (Column) Width Lighting Panelboards or **Unassembled** Panelboards.

1. Miscellaneous

ENCLOSURE TYPE
Type 1
Type 2 (Drip-proof)
Type 3R
Type 12

2. Painted Finish

Touch-Up Paint (ASA61, Light Gray) 12 oz. aerosol can, Catalog Number TUP61

3. Miscellaneous Accessories

Nameplate — laminated, engraved Tamper-Resistant Screws
--

4. Devices Mounted on Gutter Cover — Includes Device, Mounting — Wired or Unwired

Toggle Switch — SPST or 3-way; 15A
Pilot Light — General Purpose, Neon or Incandescent
Pushbutton

5. Feed-Thru Lugs^① (One Set Per Panel)

Ampere Rating	Unit Space (Additional inches)		
	3-Pole	2-Pole	MLO
400			10
600	Consult Sales	Consult Sales	10
800			17.5
1200			17.5

① For use on main lug, main breaker or main switch panels without subfeed breakers.
 ② Ground bar not installed in box.
 ③ For short circuit ratings with remote control switches, consult sales office.
 ④ Available in 90" high enclosure only. Unit space is 42 1/2" with Test and Monitor Panel; 45" without Test and Monitor Panel.

6. MLO Compression Lugs —

Available as main lugs and neutral lug.

Ampere Rating	Aluminum (Specify Size)	Copper (Specify Size)	Deduct From Available Unit Space (inches)
400	Consult Sales Office	Consult Sales Office	5
600			5
800			5
1200			5

7. Grounding of Panelboards^②

Non-Insulated Equipment Ground Bus Including Ground Lug
 Insulated Equipment Ground Bus Including Ground Lug

8. Remote Control Switches^{③④}

600V AC Ampere Rating	ASCO 920 Mechanically Held ^{③④}		Siemens CLH Electrically Held ^⑤	
	2-Pole	3-Pole	2-Pole	3-Pole
30	Unit space 20"		Unit space 20"	
60				
75				
100				
150 ^④				
200 ^④				
225				

9. Increased Capacity Neutral

Ampere Rating Phase	Unit Space (inches)	
	Neutral	
400	600	None
400	800	None
600	1200	None
800	1200	None

10. Circuit Breaker Accessories

Handle Blocking Device Blocks handle in either the "ON" or "OFF" position. Available for:

Breaker Type	Cat. Number
BL, BLH, HBL, BQ, BQH, HBQ	ECQL1
All BQD, GB	BQDHBD
All QR	HPLQR
All BQD, NGB, NGB2, HGB2, LGB2	BQDPLD
All ED	E2HBL
All FD	FD6HB1
All JD, LD	JD6HBL
All MD, ND, PD	MN6BL

⑤ Not available on Sensitrip III.
 ⑥ For required unit space — consult local sales office.
 ⑦ Price does not include control power transformer.
 ⑧ Price 600 Volt 7 1/2" high units.
 Mounting height increases to 6.25" when shunt trip is required.
 ⑨ Shunt Trip on 100A frame breakers increases mounting height to 6.25" for twin mounting.

Selection

Padlocking Device — Padlocks in "OFF" position. Available for:

Breaker Type	Cat. Number
BQ, BQH, BL, BLH, HBL	ECQLD3
One Pole BL, BLF, BE, BAF	ECPLD1
Two-Pole BL, BLF, BE	ECPLD2
All QR	HPLQR
All BQD, NGB, NGB2, HGB2, LGB2	BQDPLD
All ED	ED2HPL
All FD	FD6PL1
All JD, LD	JD6HPL
All MD, ND, PD	MN6PLD

11. Ground Fault Sensing Relay Kit^⑩ Equipment Protection (30 mA)

For Use with Breaker Types	Number of Poles	Description
ED4, ED6, HED4	1, 2, 3	Basic kit Basic kit with bell alarm

12. Main Bus

Standard main bus and ground bus are tin plated aluminum. For copper main bus, neutral bus and ground bus change prefix 'A' to 'C' on catalog number and contact your sales office for pricing.

13. Copper Lugs — For Main Lug Only Panels

Standard main lugs and neutral lugs are tin plated aluminum, UL & CSA listed for use with aluminum/copper cables. For copper lugs in the mains and neutral for use with copper cables only, contact sales.

14. Shunt Trip on Main^{⑤⑥⑦⑧⑨} and Branches

Description	Cat. Number
"BL, BQD6 (branch only) QR2, QRH2, HQR2, HQR2H, ED2, ED4, HED4 (branch only) All others through 1200A"	See breaker portion of this catalogue

15. Sentron TPS (TVSS Modules)

100kA, 150kA, 200kA, 250kA, 300kA
Options Surge Counter Remote Indicator

16. Customer Metering

Siemens Digital Metering with Remote Display SEM3 Embedded Metering
--

⑩ Not CSA approved.

Panelboards

Modifications and Additions Replacements for Circuit Breakers

Selection

Replacement Connecting Strap Guide

The following table may be used to obtain the proper connector kit by measuring the exterior dimensions of the panel. Every attempt has been made to make this table complete and accurate. The table is based on panels produced by ITE, Bulldog and Siemens from 1958 to present. Should any questions arise please contact your Siemens sales office for replacements.

Panelboard				
Tub Width	Depth	Panel Type	Replacement Max Amps	Note
30" - 36" - 42"	9"	OLD CDP	400	MCCB only.
	9.75"	OLD CDP	600	MCCB only.
32" - 38"	13.75"	CDP/VB6	1200A	MCCB series 6 connectors
			600A	"VB" style units only (*)
38"	12.75"	SPP/FPP6	1200A	MCCB series 6 connectors
			600A	"VK" or "VB" style (*)

* If switch unit width is 17" it is a vacubreak. If switch unit width is 23" or 28" it is a "VK" switch.

Connecting Strap For Use With SPP/FPP, S5^③

Max Amp Rating	Breaker Family	Breaker Type	Catalogue Number	Unit Height	Mounting
100	General	BQ, BQH, HB BL, BLH, HBL, BQD6	6BL2C ^{②③}	3.75" (95)	Twin
125	General	NGB	SNBD	3.75" (95)	Twin
		NGB2, HGB2, LGB2	SGB2DCAN	3.75" (95)	
		HEB	SEBD	3.75" (95)	
	ED2, ED4, ED6, HED4	6E62 ^{①②}	3.75" (95)		
	Sentron	CED6	6CLE2 ^①	3.75" (95)	
150	VL	NDG, LDG	SDGD	5" (127)	Twin
225	General Purpose	QR2, QR2H, HQR2, HQR2H	6QR2CAN ^④	5" (127)	Twin
250	Sentron	FXD6, FD6, HFD6, HHFD6	6F62 ^①	5" (127)	Twin
	VL	NFG, LFG	SFGD	5" (127)	
	Sentron	CFD6	6CLF1C	5" (127)	
400	Sentron	JXD6, JD6, HJD6, HHJD6	6JJ62 ^①	8.75" (222)	Twin
	VL	NJG, LJG	SJG1D	6.25" (159)	Single
		NJG, LJG	SJG2D	6.25" (159)	Twin
	Sentron	CJD6	6CLJ1C	8.75" (222)	Single
600	Sentron	LXD6, LD6, HLD6, HHL6, SLD6, SHLD6, SJD6, SHJD6	6LL61C	8.75" (222)	Single
		CLD6	6CLL1C	8.75" (222)	
		SCJD6, SCLD6	6SCL61C	8.75" (222)	
800	Sentron	MXD6, MD6, HMD6, CMD6, SHMD6, SCMD6, SJD6, SHJD6, SCJD6, SCLD6	6M61C	10" (254)	Single
1200	Sentron	NXD6, ND6, HND6, CND6, SHND6, SCND6	6N61C	10" (254)	Single

① These are aluminum connectors. If copper is required please add suffix **C**.

② 3.75" (95) plate accommodates six 1-pole breakers.

③ Connecting strap kits include connecting straps, hardware, and cover plates for switchboards and power panels. Breakers to be ordered separately.

④ QR filler plate only, use p/n: **6QR2FKCAN**.
For copper QR kit, use p/n: **6QR2CCAN**.

Blank Filler Plates (No Breaker Cutout)

For use with Series 6 CDP Panelboards, S5, F2, SMP, FCI and FCII Switchboards.	
Height	SPP/FPP/CDP/VB 6
1.25"	6FPB01
2.50"	6FPB02
3.75"	6FPB03
5.00"	6FPB05
10.00"	6FPB10
15.00"	6FPB15

Connecting Strap Kits and Front-Filler Plates^①

For use with NDP-CDP-7, S3

Breakers	Catalogue Number
BQD6 (S3 only)	7 BQD6-2
BL, BLH, HBL,	7 BL-2
ED2, ED4, ED6, HED4	7 E6-2
Filler 1 Pole	DFFP1

Panelboards

Fusible/Power and Distribution

Selection

Type F2

600 Volts AC, 250 Volts DC Maximum
600 Ampere Main Switch,
1200 Ampere Main Lugs Only
600 Ampere Maximum Branch
UL & CSA Short Circuit Rating –
200,000A IR Maximum

Meets 1996 NEC wire bending requirement, section 373-6.
 CSA - C22.2 No. 0.12

Panelboards

Listed by Underwriters' Laboratories, Inc., under "Panelboards" File #E2269 for interiors and #E4016 for boxes and fronts & CSA File #LR93833.

Service

600 Volts AC, 250 Volts DC, Maximum.
 1 Phase, 3 Wire; 3 Phase, 3 Wire; or 3 Phase, 4 Wire.

Boxes

38" wide, 12.75" deep, Type 1

Panelboard Fronts and Doors

Standard panelboards are furnished with 4 piece trim. Fronts are fabricated from code gauge steel and finished ASA61.

Fuses

The Proper Fuse Type for the Application is Selected Using the Following Parameters:

- Voltage Requirements
- Conductor Ampacity
- Horsepower Requirements
- Maximum Available RMS Fault Current
- CSA Fuse Class

Main Switch Panel Connectors

Ampere Rating	Connectors Suitable for Cu or Al
400	(1) - 750 kcmil OR (2) - 250 kcmil (Cu or Al)
600	(2) - 750 kcmil OR (4) - 250 kcmil (Cu or Al)
800	(3) - #3/0 AWG-500 kcmil
1200	(4) - #3/0 AWG-500 kcmil

Main Lug Panels

Ampere Rating	Connectors Suitable for Cu or Al
400 ^①	(1) - #3/0 AWG-500 kcmil (2) - #3/0 AWG-250 kcmil
600	(2) - #3/0 AWG-500 kcmil
800	(3) - #3/0 AWG-500 kcmil
1200	(4) - #3/0 AWG-500 kcmil

Branch Switch Connectors

Switch Ampere Rating	Wire and Cable Range
30	(1) - #14-#2 AWG (Cu or Al)
60	(1) - #14-#2 AWG (Cu or Al)
100	(1) - #14-#1/0 AWG (Cu or Al)
200	(1) - #6 AWG-350 kcmil (Cu or Al)
400	(1) - 750 kcmil OR (2) - 250 kcmil (Cu or Al)
600	(2) - 750 kcmil OR (4) - 250 kcmil (Cu or Al)

Gutters

Ampere Rating	End Gutters (Minimum inches)	Side Gutters (Minimum inches)
400	12	7.9
600	12	7.9
800	12	7.9
1200	12	7.9

Maximum VB HP Ratings

Amp Rating	3 Phase			Single Phase	DC
	Volts			Volts	Volts
	240	480	600	240	250
30	7.5	15	20	3	5
60	15	30	50	10	10
100	30	60	50	15	20
200	60	125	50	-	40
400	50	50	50	-	50
600	50	50	-	-	-

Maximum VK HP Ratings

Amp Rating	3 Phase			Single Phase	DC
	Volts			Volts	Volts
	240	480	600	240	250
30	7.5	15	20	3	5
60	1.5	30	50	10	10
100	30	50	75	15	20
200	60	125	150	15	40

CSA Fuse Classes

Class	Amperes	Volts	Interrupting Ratings	I^2t , I_p	Circuits
H (code)	1-600A	250 and 600V or less AC	10,000A	-	Less than 10,000A available
K ^②	1-600A	250 and 600V or less AC	50,000A	-	Feeder circuits
J	1-600A	600V or less	To 200,000A	I^2t -Low I_p -Low	Feeder circuits (motor load small %)
RK1	1/10-600A	600V or less 250V or less	To 200,000A	I^2t -Slightly > J I_p -Slightly > J	Feeder circuits (motor load small %)
RK5	1/10-600A	600V or less 250V or less	To 200,000A	I^2t - > RK-1 I_p - > RK-1	Motor starting currents a factor
T	1-600A	300 and 600V or less AC	To 200,000A	I^2t -Low I_p -Low	Non-motor loads
L	601-5000A	600V or less	To 200,000A	I^2t -Low I_p -Low	Feeder circuits motor loads

Panelboards

Power and Distribution

Selection

Type F2

Maximum Panel Ampere	Unit Space (MLO)	Box Height				
400A	30"	60"	120/240Volts 1 Phase, 3 Wire	120/208 Volts 3 Phase, 4 Wire	600 Volts 3 Phase, 3 Wire	347/600 Volts 3 Phase, 4 Wire
600A	45"	75"				
800A	60"	90"				
1200A	60"	90"				

Branch Switches 600V Maximum^①

Rating Ampere	Maximum Voltage	Fusing (1)	Mounting Height F2 38" W
30/30A (VK)	600V	J	6.25(159)
60/60A (VK)			6.25(159)
100/100A (VK)			7.5(190)
200/200A (VK)			10(254)
30/30A, 60/60A, 100/100A (VB)			7.5(190) ^②
200A (VB)			10(254)
400A (VB)			15(381)
600A (VB)			15(381)

① Single or twin units as listed and are valid for class C or J fuses. If class R or T fuse provisions are required add per table above.
② Not applicable to VB style units 400A and 600A.

③ Use of auxiliary switch kit will require the use of a 75" (190) high unit for 30 and 60 Amp. switches.
④ Refer to Siemens for single phase and DC horsepower requirements.

⑤ Ratings are based on UL test procedure. CSA will not recognize ratings above 100Hp.

Panelboards

Modifications and Additions

Selection

Type F2

When required, special constructions or additions to standard panelboards may be specified for all **factory-assembled** Power and Distribution Panelboards. Below and on the next page are listed many of those available, for Type F2 panelboards. In no case do these apply to **Narrow** (Column) Width Lighting Panelboards.

1. Miscellaneous

ENCLOSURE TYPE
Type 1
Type 2 (Drip-proof)
Type 3R
Type 12

2. Painted Finish

Description
Touch-Up Paint (ASA61, Light Gray) 12 oz. aerosol can, Catalog Number TUP-61

3. Miscellaneous Accessories

Nameplate — laminated, engraved Tamper-Proof Screws
--

4. Devices Mounted on Gutter Cover Includes Device, Mounting — Wired or Unwired

Description
Toggle Switch — SPST or 3-way; 15A
Pilot Light — General Purpose, Neon or Incandescent
Pushbutton

5. Grounding of Panelboards^③

Non-Insulated Equipment Ground Bus Including Ground Lug
Insulated Equipment Ground Bus Including Ground Lug

6. Remote Control Switches^④ 600V AC

600V AC Ampere Rating	ASCO 920 Mechanically Held ^⑤		Siemens CLH Electrically Held ^⑥	
	2-Pole	3-Pole	2-Pole	3-Pole
30 60 75 100 150 ^⑦ 200 ^⑦ 225	Unit space 20"		Unit space 20"	

7. Increased Capacity Neutral

Ampere Rating		Unit Space (inches)
Phase	Neutral	
400	600	None
400	800	None
600	1200	None
800	1200	None

8. Main Bus

Standard main bus and ground bus is tin plated aluminum. For copper main bus, neutral bus and ground bus change prefix 'A' to 'C' on catalog number and contact your sales office for pricing.

9. Copper Lugs — For Main Lug Only Panels

Standard main lugs and neutral lugs are tin plated aluminum, UL & CSA listed for use with aluminum/copper cables. For copper Lugs in the mains and neutral for use with copper cables only, contact sales.

10. Feed-Through Lugs^① (One Set Per Panel)

Ampere Rating			Unit Space (Additional inches)
	3-Pole	2-Pole	MLO
400	Consult Sales Office	Consult Sales Office	10
600			10
800			17.5
1200			17.5

11. MLO Compression Lugs

Available as main lugs and neutral lug.

Ampere Rating	Aluminum (Specify Size)	Copper (Specify Size)	Deduct From Available Unit Space (inches)
400			5
600			5
800			5
1200			5

12. VK Switch Accessories

Item	Cat. No.
Fuse Pullers (2) 30/60 mp	FP2
100 amp	FP3
200 amp	FP4

13. Sentron TPS (SPD Modules)

100 KA	200 KA	300 KA
150 KA	250 KA	
Options		
Surge Counter		
Remote Indicator		

14. Customer Metering

Siemens Digital Metering with Remote Display SEM3 Embedded Metering
--

① For use on main lug, main breaker or main switch panels without subfeed breakers.
② For increase in panelboard height — Consult local sales office.
③ Ground bar is not installed in box.

④ For required unit space — consult local sales office. Price includes increased enclosure height if required.
⑤ Devices listed by Underwriters' Laboratories, Inc. When 2 wire control is required. Relay and Terminal Block (9" of unit space required).

⑥ For short circuit ratings with remote control switches consult sales office.
⑦ Panelboard short circuit rating is limited to 5,000 RMS symmetrical.

Panelboards

Modifications, Additions Replacements for Fusible Switches

Selection

Type F2 Replacement Units^{①②}

Amperes Rating	600 Volts J Fuses Cat. No.	Height in (mm)
----------------	----------------------------	----------------

VK Switch For Use With FPP6 Panelboard^{③④⑤⑥}

Amperes Rating	VK Switch Cat. No.	Height in (mm)
30/30	VK23611JP	6.25 (159)
60/60	VK23622JP	6.25 (159)
100/100	VK33633JP	7.5 (90)
200/200	VK73644JP	10 (254)

VB Switch For Use With VB6 Panelboards^⑦

Amperes Rating	VB Switch Cat. No.	Height in (mm)
30/30	V7E3611JP	7.5(190)
60/60	V7E3622JP	7.5(190)
100/100	V7E3633JP	7.5(190)
200	V7F3604JP	10(254)
400	V7H3605JP	15(381)
600	V7H3606JP	15(381)

Panelboard				
Tub Width	Depth	Panel Type	Replacement Max Amps	Note
30" - 36" - 42"	9"	OLD CDP	400	MCCB only.
	9.75"	OLD CDP	600	MCCB only.
32" - 38"	13.75"	CDP6/VB6	1200A 600A	MCCB series 6 connectors "VB" style units only (*)
38"	12.75"	SPP6/FPP6	1200A	MCCB series 6 connectors "VK" or "VB" style (*)
			600A	

Connecting Strap Kits^⑩

Rating Amperes	VB Switch Cat. No.	VK Switch Cat. No.	HCP Switch Cat. No.
30/30	VB6-71	VK6-57	N/A
60/60			
100/100			
200			
200/200	N/A	VK6-72	
400-600	VB6-150	N/A	F6162DCAN
800-1200	N/A		

Blank Filler Plates^④

For use with Series 6 CDP Panelboards, S5, F2, FCI and FCII Switchboards.	
Height	SPP/FPP/CDP/VB 6
1.25"	6FPB01
2.50"	6FPB02
3.75"	6FPB03
5.00"	6FPB05
10.00"	6FPB10
15.00"	6FPB15

① For Series 6 Main Devices above 200A, add suffix MS to Catalog Number when ordering.
 ② When 2-Pole units are required, use 3-Pole.
 ③ Series 6 (VB6, CDP6) replacement units and connector kits also accommodates FCI and FCII distributions interiors. Units installed after October 1991 will be FPP6 type.
 ④ Refer to Siemens for units equipped with auxiliary switches.

⑤ Price is for two brackets – to be included with filler plates.
 ⑥ To be used in tubs with 30-200A, VB units or fillers in 12⁵/₈" deep tub.
 ⑦ Can be used as fillers or in place of circuit breakers, VK or VB Switches.
 ⑧ Special order

⑨ Fusible switch kits include fusible switches and cover plates for switchboards and power panels. Connecting strap kits to be ordered separately.
 ⑩ Connecting strap kits include connecting straps and hardware. See Note 9 for cover plates.

Panelboards

Embedded Micro Metering Module™

Selection

SEM3 System Configured in Panelboards

The Siemens SEM3 system can be configured for factory installation in branch circuit monitoring application. This option can lower the installation time of the system for the installer while providing a factory warranted solution.

The SEM3 system can be factory installed in unit space in type P2 & S5 Siemens panel boards. Please note P1 and P3 configurations are not available at this time and the amount of unit space needed varies depending upon the application. Please note that lead time adders will apply and may vary depending upon the configuration of the system.

SEM3 for use in Siemens Panelboards

Available in a Type 1 and 2 rated enclosure



Controller

Each SEM3 Controller can monitor up to 45 circuits. Applications that require monitoring more than 45 circuits will require additional controllers.



Current Transformers (CTs)

Five sizes of CTs are available for use in the S5 panel: 50, 125, 250, 400, 600, 800 & 1200 amp. Each bracket supports a maximum of 3 CTs and is designed for the breaker selected (brackets are not interchangeable between breaker frames). Each CT will be attached to a data module that is placed in the meter racks.



Meter Racks

All meter racks will be installed next to the SEM3 controller unit space. The 21 space meter rack is used as a default option where possible.

NOTE: Monitoring of 45 circuits will require: two 21 position racks and one 3 position rack

Other Considerations

Configuration: Data modules from CTs monitoring a circuit breaker must be mounted adjacent to one another in the meter rack. Any field changes to the factory configuration must take this into account.

Start-up & Commissioning: Siemens can provide these services. Contact your local Siemens sales office for more details.

Panelboards

Panel Skirts/System Types, AC & DC Voltages

Conduit Enclosing Shield (Panel Skirts)

Sheet metal to cover conduits above or below a standard panelboard box.

Skirt Length	Width	Depth
8, 9, 11, 12	20.00	5.75
14, 17, 18, 23, 25	20.00	5.75
26, 27, 28, 29, 30, 31, 32, 33, 34, 35, 36	20.00	5.75
37, 38, 39, 40, 41, 42, 43, 44	20.00	5.75
8, 9, 11, 12	24.00	7.75
14, 17, 18, 23, 25	24.00	7.75
26, 27, 28, 29, 30, 31, 32, 33, 34, 35, 36	24.00	7.75
37, 38, 39, 40, 41, 42, 43, 44	24.00	7.75

Panel Skirts Standard Length

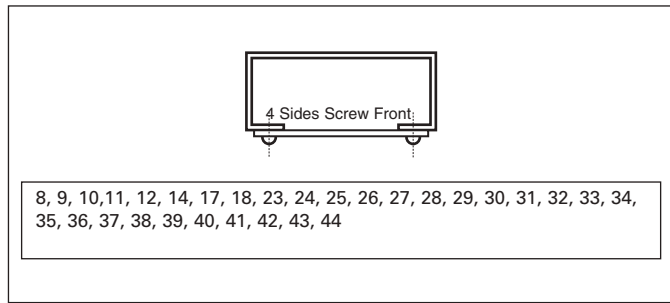

Busing

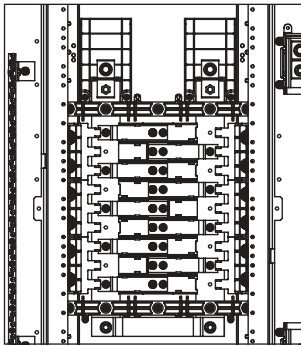

Single-phase

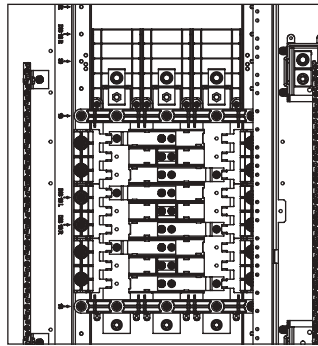

Three-phase

AC Voltages

1 phase, 2 wire

- 120V 1 phase, 2 wire
- 240V 1 phase, 2 wire

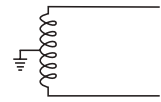

1 phase, 3 wire

- 120/240V 1 phase, 3 wire

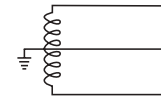

1 phase, 2 wire, Wye

- 277V 1 phase, 2 wire

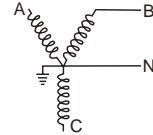

1 phase, 2 wire, Delta

- 480V 1 phase, 2 wire

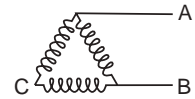

1 phase, 3 wire, Delta

- 240/480V 1 phase, 3 wire

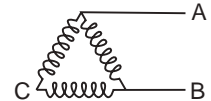

3 phase, 4 wire, Wye

- 208Y/120V 3 phase, 4 wire
- 480Y/277V 3 phase, 4 wire
- 600Y/347V 3 phase, 4 wire

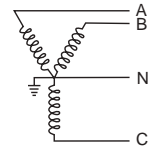

3 phase, 4 wire, Delta

- 240/120V 3 phase, 4 wire
- 480/240V 3 phase, 4 wire

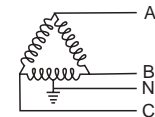

3 phase, 3 wire, Delta

- 240V, 3 phase, 3 wire
- 480V, 3 phase, 3 wire
- 600V, 3 phase, 3 wire
- 240V, 3 phase, 3 wire, grounded B
- 480V, 3 phase, 3 wire, grounded B
- 600V, 3 phase, 3 wire, grounded B

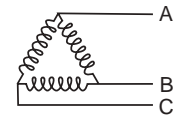

1 phase, 3 wire, Wye

- 208Y/120V 1 phase, 3 wire
- 480Y/277V 1 phase, 3 wire

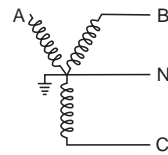

DC voltage

1 phase, 2 wire

- 125Vdc, 2 wire

(Up to 125Vdc, MLO option only.)

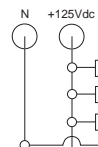

Panelboards

Type HCP Switchboard and Power Panel Units, Accessories

Selection

Features

- CSA certified under file #24563 and UL Listed under file #E6849 Vol 1, Sect. 8
- 400-1200A ratings
- Visible contacts
- Field installable shunt trip and auxiliary switch accessory kits
- Installs in existing Siemens switchboards
- Suitable for use on systems with up to 200,000A available fault current, RMS symmetrical when equipped with Class J or Class L fuses
- Group mounts with other 30A through 600A switches, and 100 through 1200 amp frame breakers
- Allows 800A and 1200A switches in standard 38" wide distribution sections in either main or branch configurations
- 16¼" mounting height is the smallest 1200A design in the industry, allowing up to 4 units in one vertical section
- Field reversible horizontal mounting design for left or right hand cabling
- Handle can be padlocked in the OFF position with up to three padlocks with 5/16" hasps. A cover padlocking provision is also supplied



3-Pole, Horizontal Mount ①

Catalogue Number	Maximum Ampere Rating	Maximum AC Voltage Rating ^②	Fuse Class	Dimensions (inches*)			Horsepower Rating						
							240V		480V		600V		250V DC
				H	W	D	Std	Max	Std	Max	Std	Max	
HCP367HJ400	400	600	J	16.25	17.22	7.38	50	125	100	250	125	350	40
HCP367HJ600	600	600	J	16.25	17.22	7.38	75	200	150	400	200	400	40
HCP327HT	800	240	T	16.25	17.22	7.38	100	250	—	—	—	—	50
HCP367H	800	600	L	16.25	17.22	7.38	100	250	200	500	250	500	50
HCP328HT	1200	240	T	16.25	17.22	7.38	100	250	—	—	—	—	50
HCP368H	1200	600	L	16.25	17.22	7.38	100	250	200	500	250	500	50

3-Pole, Vertical Mount

HCP367VJ400	400	600	J	17.00	16.25	7.38	50	125	100	250	125	350	40
HCP367VJ600▲	600	600	J	17.00	16.25	7.38	75	200	150	400	200	400	40
HCP327VT	800	240	T	17.00	16.25	7.38	100	250	—	—	—	—	50
HCP367V	800	600	L	17.00	16.25	7.38	100	250	200	500	250	500	50
HCP328VT	1200	240	T	17.00	16.25	7.38	100	250	—	—	—	—	50
HCP368V	1200	600	L	17.00	16.25	7.38	100	250	200	500	250	500	50

Accessories

Terminal Connectors (one lug per kit)

Ampere Rating	Catalogue Number	Connector Wire Range
400-600A	TA2K500	(2) #1 AWG-500 kcmil (Cu or Al)
400-600A	TC2K500	(2) #1 AWG-500 kcmil (Cu only)
400-800A	TA3K500	(3) #1 AWG-500 kcmil (Cu or Al)
400-800A	TC3K350	(3) #1 AWG-350 kcmil (Cu only)
800-1200A	TA4H500	(4) #2 AWG-500 kcmil (Cu or Al)
800-1200A	TA3H750	(3) 500-750 kcmil (Cu or Al)

Auxiliary Switch Kits

Contact Ampere Rating	Maximum Voltage		Switch Mounting	Contacts	Catalogue Number
	AC	DC			
15A	480	125	Left Pole	1NO/1NC	A01HCP4▲
15A	480	125	Right Pole	1NO/1NC	A01HCP4

Shunt Trip Kit

Control Voltage		Catalogue Number
AC	DC	
120	—	HCPST120
240	—	HCPST240▲
277	—	HCPST277
480	—	HCPST480▲

*For inches / millimeters conversion, multiply inches by 25.4.

Switchboard Connection Strap Kit ①

Switch Ampere Rating	Catalogue Number
400-1200A	F6162DCAN

▲ Built to order. Allow 6-8 weeks for delivery.
① For horizontal mounting only in either 38" wide min switchboards or S5/F2 power panelboards.

T Fuse Adapter Kits (one per pole)

Catalogue Number	Description
TFAK72	800A, 300V AC
TFAK75	800A, 600V AC
TFAK82	1200A, 300V AC

HCP Replacement Handle Kit (For use on all HCP switches)

SW Ampere Rating	Catalogue Number
400-1200A	HCPHK

Compression Lug Adapter Kit

The use of this kit provides for the mounting of up to four lugs per phase. Each kit accepts lugs with (2) 3/8" diameter mounting holes on 1" centers. One kit per pole line or load is required. Lugs are not provided.

Ampere Rating	Catalog Number
400-1200A	HCPCLP

② Both 240 and 600V AC switches are also rated 250V DC max.

Panelboards

Type HCP Switchboard Units

Dimensions

Horizontal Mount Drawing

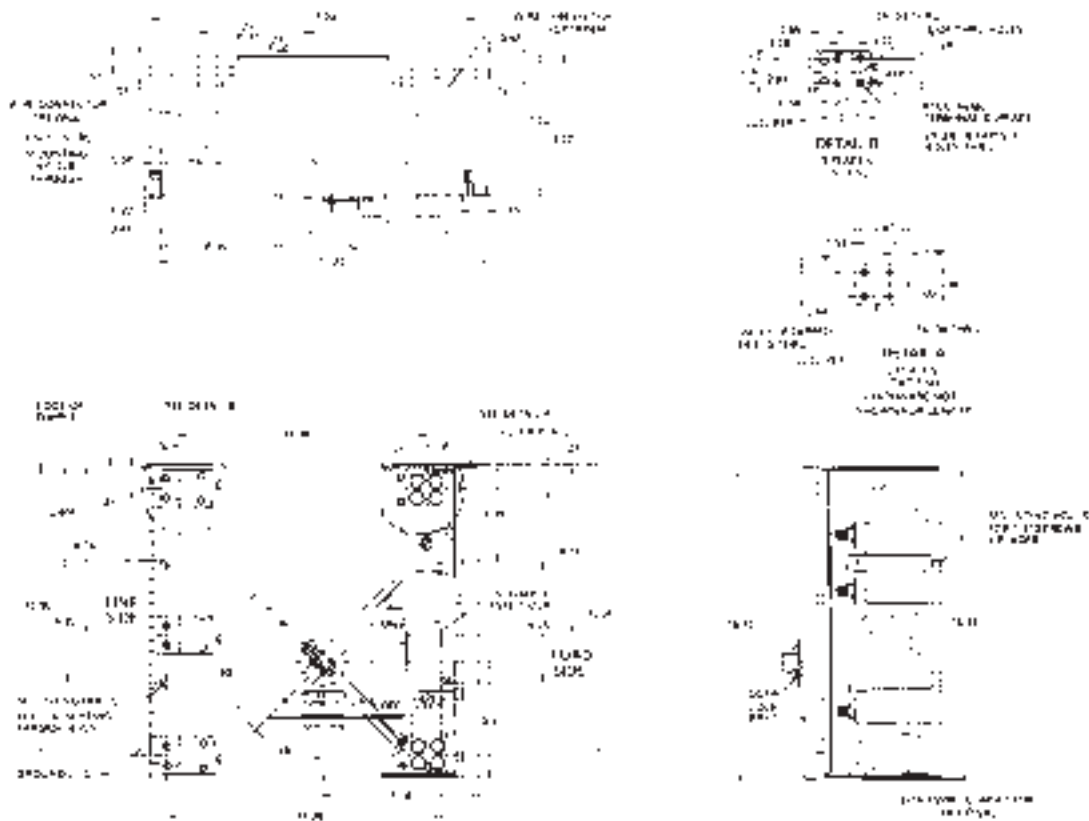

Group Mounting Assembly (Horizontal Mount Only)

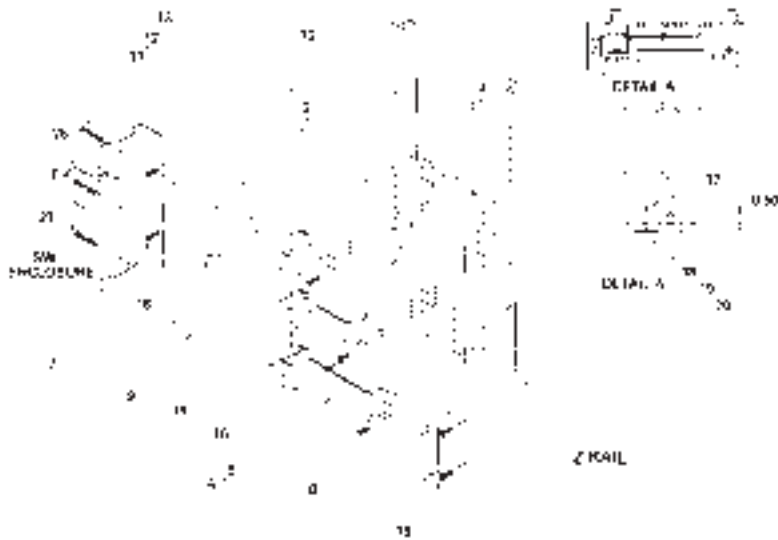

Item	Parts Supplied in Connection Strap Kit Cat. No. #5162D	Qty.
12	ACO Strap-Split	162
34	AC Strap	162
56	ACO Strap-Long	162
78	Switch Mounting Bracket	162
9	Insulation	1
10	1/2" Insulator	2
11	3/8" x 3/4" SHMS	2
12	3/8" Lock Washer	2
13	3/8" Flat Washer	2
14	3/8" x 3/4" SHMS	2
15	3/8" Bus Hardware Kit	2
16	1/4" x 3/8" SHMS	4
17	5/16" Insert	8
18	5/16" x 1" SHMS	8
19	5/16" Flat Washer	8
20	5/16" Lock Washer	8
21	1/4" x 1" SHMS	2
26	Ground Bracket	1
27	1/2" x 1/4" SHMS	2

Refer to the drawing for the dimensions of the unit.
Note: Items 26 & 27 are supplied with the unit and are not included in the connection kit.

Panelboards

Circuit Breaker / Column Type

General

Type C1

240 Volts AC Maximum
250 Ampere Mains
250 Ampere Maximum Branch
UL Short Circuit Rating –
200,000 IR Maximum

Branch Breaker Symmetrical
Interrupting Rating

Based on Underwriters' Test Procedure

Type C2

480Y/277 Volts AC Maximum
250 Ampere Mains
250 Ampere Maximum Branch
UL Short Circuit Rating –
100,000 IR Maximum

Meets NEC wire bending requirement, section 312-6.

Panelboards

Listed by Underwriter's Laboratories, Inc., under "Panelboards" File #E2269.

Meets Federal Specification W-C375B/Gen.

Service

240 Volts Maximum. 1-Phase, 3-Wire, or 3-Phase, 4-Wire.

Panelboards Fronts and Doors

Standard panelboards are furnished with trim with a flush door lock. All are factory assembled for ease of installation. Fronts are fabricated from code gauge steel and finished ANSI-61.

Main Breakers C1

BL, BLH and HBL frame breakers are mounted horizontally. All other frames are mounted vertically.

Main Breakers C2

BQD frame breakers are mounted horizontally. All other frames are mounted vertically.

Boxes

C1 — 7 $\frac{5}{8}$ " wide, 5 $\frac{3}{4}$ " deep.

C2 — 8 $\frac{1}{2}$ " wide, 5 $\frac{3}{4}$ " deep.

Branch Breaker Side Gutters

Type	Circuit Breaker	Side Gutter (inches)
C1	BL, BLH, HBL	3.505
C2	BQD	3.5

Weight—Approximate

Total panelboard weight when filled with a normal quantity of breakers and accessories is:

*About 3 lbs. per inch of box height.

Gauge Steel Boxes

Type	Width	Height	Gauge Steel
C1	7 $\frac{5}{8}$ "	48", 73", 85"	#14
C2	8 $\frac{1}{2}$ "	48", 73", 85"	#14

Fronts

C1	7 $\frac{5}{8}$ "	48", 73", 85"*	#14
C2	8 $\frac{1}{2}$ "	48", 73", 85"*	#14

*Note: Feed thru lugs and subfeed breaker not available for this height.

Main Breaker Connectors

Ampere Rating	Connectors suitable for Cu or Al
100	(1) #14-1/0 AWG
125	(1) #4-1/0 AWG
225	(1) #6 AWG-300 kcmil
250	(1) #4 AWG-350 kcmil Al (1) #6 AWG-350 kcmil Cu

Main Lugs

125	(1) #6 AWG-350 kcmil
250	(1) #6 AWG-350 kcmil

For inches / millimeters conversion, see Application Data section.

① Connector ranges indicated do not apply to all main breaker types. Refer to molded case circuit breaker standard pressure wire connectors in the breaker section of this catalog for the wire ranges for a specific breaker frame.

Panelboards

Circuit Breaker / Column Type

Selection

Branch Breaker Selection C1

Breaker Type	Available Ampere Rating	Availability			Maximum Interrupting Rating (kA)		
		1-Pole	2-Pole	3-Pole	120V	120/240V	240V
BL (120V)	15, 20, 30, 40, 50, 60	✓	✓	✓	—	10	—
	70	✓	✓	✓	—	10	—
	70, 80, 90, 100	—	✓	✓	—	10	—
BLF (GFCI)	15, 20, 30	✓	✓	—	10	—	—
	40, 50, 60	—	✓	—	10	—	—
BLE (EQGFI)	15, 20, 30	✓	✓	—	10	—	—
BGL (SWN)	15, 20, 30	—	✓	✓	10	—	—
BLR (240V)	15, 20, 30, 40, 50, 60	—	✓	—	—	—	10
	70, 80, 90, 100	—	✓	—	—	—	10
BLH (120V)	15, 20, 30, 40, 50, 60	✓	✓	✓	—	22	—
	70	✓	✓	✓	—	22	—
	70, 80, 90, 100	—	✓	✓	—	22	—
BLHF (GFCI)	15, 20, 30	✓	✓	—	—	22	—
	40, 50, 60	—	✓	—	—	22	—
HBL	15, 20, 30, 40, 50	✓	✓	✓	—	65	65
	60, 70, 80, 90, 100	—	✓	✓	—	65	65

Subfeed Breakers — Limit One Per Panel® C1 (Not available for 42 circuit panels)

ED4	15, 20, 30, 40, 50, 60, 70, 80, 90, 100	—	✓	✓	—	—	65
	110, 125	—	✓	✓	—	—	65
HED4	15, 20, 30, 40, 50, 60, 70, 80, 90, 100	—	✓	✓	—	—	65
	110, 125	—	✓	✓	—	—	100
QR2	100, 110, 125, 150, 175, 200, 225	—	✓	✓	—	—	10
FXD6	70, 80, 90, 100, 110, 125, 150, 175, 200, 225, 250	—	✓	✓	—	—	65
HFD6®	70, 80, 90, 100, 110, 125, 150, 175, 200, 225, 250	—	✓	✓	—	—	100

Alternate Main Breaker Selection ③ C2

Ampere Rating	Breaker Type	IR	Catalogue Number	Available Trip Values
100	BQD	14	BD	50, 60, 70, 80, 90, 100
	ED4	18	E4	50, 60, 70, 80, 90, 100
	ED6	25	E6	50, 60, 70, 80, 90, 100
	HED4	42	H4	50, 60, 70, 80, 90, 100
	HHED6	65	H6	50, 60, 70, 80, 90, 100
125	ED4	18	E4	110, 125
	ED6	25	E6	110, 125
	HED4	42	H4	110, 125
	HHED6	65	H6	110, 125
225	FXD6	35	FX	70, 80, 90, 100, 110, 125, 150, 175, 200, 225
	HFD6	65	HF	170, 80, 90, 100, 110, 125, 150, 175, 200, 225
250	FXD6	35	FX	250
	HFD6	65	HF	250

Branch Circuit Breakers C2

Breaker Type	Available Ampere Rating	Availability			Maximum Interrupting Rating (kA)		
		1-Pole	2-Pole	3-Pole	277V	480/277V	480V
BQD	15, 20, 30, 40, 50, 60	✓	✓	✓	14	14	—
	70, 80, 90, 100	✓	✓	✓	14	14	—

Subfeed Breakers — Limit One Per Panel® C2 (Not available for 42 circuit panels)

ED4	15, 20, 30, 40, 50, 60, 70, 80, 90, 100	—	✓	✓	—	18	18
	110, 125	—	✓	✓	—	18	18
ED6	15, 20, 30, 40, 50, 60, 70, 80, 90, 100	—	✓	✓	—	—	25
	110, 125	—	✓	✓	—	—	25
HED4	15, 20, 30, 40, 50, 60, 70, 80, 90, 100	—	✓	✓	—	—	42
	110, 125	—	✓	✓	—	—	42
FXD6	70, 80, 90, 100, 110, 125, 150, 175, 200, 225, 250	—	✓	✓	—	—	35
HFD6	70, 80, 90, 100, 110, 125, 150, 175, 200, 225, 250	—	✓	✓	—	—	65

① No increase in box height. Space is already built into C1 panel.

② Interchangeable trip breakers such as FD6 and HFD6 cannot be back fed. Must be top feed only.

③ BL, BLH, HBL and BQD are horizontally mounted. All others vertically mounted.

Panelboards

Circuit Breaker / Column Type, Modifications and Additions

Selection

Type C1/C2

When required, special constructions or additions to standard panelboards may be specified for factory-assembled column panelboards.

Box Modifications

Description
Gasketed
Metal Card Holder
Welded Metal Card Holder
Nameplate
Al Ground Bar
Cu Ground Bar
Insulated Al Ground Bar
Insulated Cu Ground Bar

Interior Modifications

Description
Feed-Thru Lugs
Cu Neutral Lugs
Cu main Lugs 125A
Cu main Lugs 250A

Box Sizing Chart

Certain modifications such as subfeed breakers and feed-thru lugs require additional unit space. Use this chart to determine proper enclosure size.

Panel Configuration	Box Height (inches)
All MLO 18 Circuit	48
All MLO 30 Circuit	73
All MLO 42 Circuit	85
All MLO 18 Circuit with feed-thru lugs	73
All MLO 30 Circuit with feed-thru lugs	85
All MLO 18 Circuit with subfeed breaker	73
All MLO 30 Circuit with subfeed breaker	85
All Main Breaker 18 Circuit	48
All Main Breaker 30 Circuit	73
All Main Breaker 42 Circuit	85
All Main Breaker 18 Circuit with feed-thru lugs	73
All Main Breaker 30 Circuit with feed-thru lugs	85
All Main Breaker 18 Circuit with subfeed breaker	73
All Main Breaker 30 Circuit with subfeed breaker	85

Breaker Kits and Accessories

Kit Number	Description	Contents
MBKQRC1FK	C1 Filler for QR in Main position 1PH or 3PH	Kit contains all cover plates necessary to change from QJ to QR both 2 and 3-pole breakers.

Column Extension

Available in various standard lengths, extensions are 5¼ inches deep and 7 inches wide.

Height (inches)	Catalogue Number ^①
14	LXX-14
20	LXX-20
26	LXX-26
32	LXX-32
38	LXX-38
41	LXX-41
44	LXX-44
53	LXX-53
56	LXX-56
62	LXX-62
65	LXX-65
68	LXX-68
74	LXX-74
80	LXX-80
86	LXX-86

Pull Boxes

Two styles of pull boxes are available, top and front mounted. When the panel and its extensions are mounted in a structural WF beam a front mounted pull box is required. When the panels are surface mounted, a top mounted pull box may be used. Provisions are made so that the neutral bar may be mounted in the pull box when required. (Front mounted pull box dimensions are 14" H. X 20" W.)

Description	Catalogue Number ^①
Top Mount	LXXP-T
Front Mount ^②	LXX50-F

For inches / millimeters conversion, see Application Data section.

① Must be ordered as a manual line.
② Includes 50" extension.

Panelboards

Circuit Breaker / Column Type

Selection

Conduit Enclosing Shield (Panel Skirts)

Sheet metal to cover conduits above or below a standard panelboard box.

Skirt Length	Width	Depth
8, 9, 11, 12	20.00	5.75
14, 17, 18, 23, 25	20.00	5.75
26, 27, 28, 29, 30, 31, 32, 33, 34, 35, 36	20.00	5.75
37, 38, 39, 40, 41, 42, 43, 44	20.00	5.75
8, 9, 11, 12	24.00	7.75
14, 17, 18, 23, 25	24.00	7.75
26, 27, 28, 29, 30, 31, 32, 33, 34, 35, 36	24.00	7.75
37, 38, 39, 40, 41, 42, 43, 44	24.00	7.75

Panel Skirts Standard Length

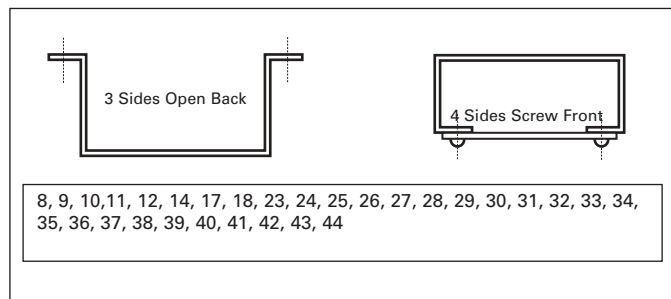

① Available only as a main switch for non-service equipment applications. Not available for branch devices.

Panelboards

Enclosure/System Types, AC & DC Voltages

Selection

Type 1

- Flush or surface mount.
- Galvanized steel with removable end walls –blank or with knockouts to order.
- Box sizes: 20" W x 5.75" D x 33", 50", 59" or 69" H (510 W x 145 D x 838, 1270, 1500 or 1753mm H). Box can be rotated 180° to accommodate conduit feed.
- Enclosure and chassis mounting instructions are found in supplied literature.
- Chassis mounts directly onto studs in the enclosure.
- Trim finished with gray powder coat paint over phosphatized steel (ANSI 61).
- Door and door-in-door configurations with locks.
- Door locks use key #2A1910-2.
- Circuit directory card is located on the inside of the door.
- Trim screws are concealed.

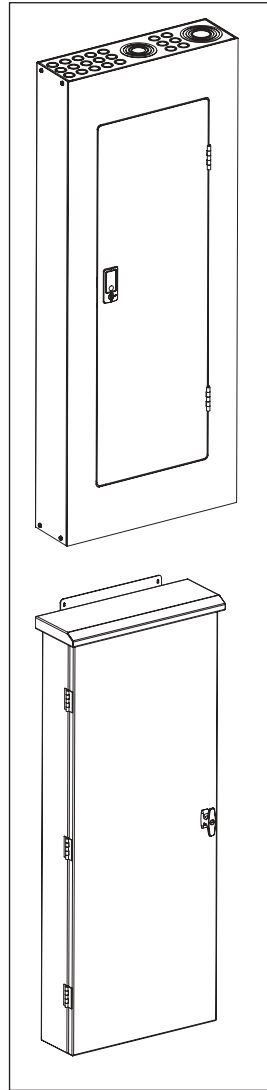

Type 3R

- Surface mount only.
- Finished with gray powder coat paint over phosphatized steel (ANSI 61).
- Bottom feed only, no knockouts
- Box sizes: 20" W x 7.7" D x 34.5", 51.5", 60.5" or 70.5 H (510 W x 195 D x 876, 1310, 1535 or 1791mm H).
- Enclosure and chassis mounting instructions are found in supplied literature
- Chassis mounts directly onto studs in the enclosure.
- Gasketed door has vault handle with lock.
- Door locks use key #2A1910-1.
- Circuit directory card is located on the inside of the door.

Busing

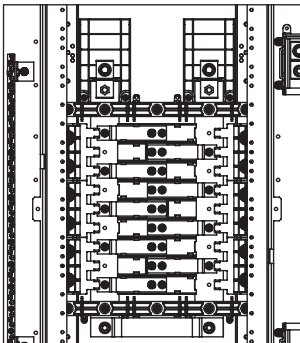

Single-phase

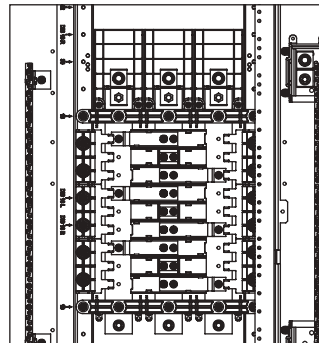

Three-phase

AC Voltages

- 1 phase, 2 wire
 - 120V 1 phase, 2 wire
 - 240V 1 phase, 2 wire

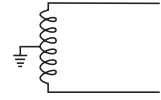

- 1 phase, 3 wire
 - 120/240V 1 phase, 3 wire

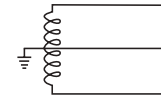

- 1 phase, 2 wire, Wye
 - 277V 1 phase, 2 wire

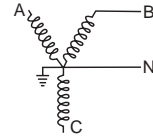

- 1 phase, 2 wire, Delta
 - 480V 1 phase, 2 wire

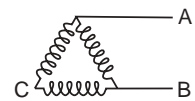

- 1 phase, 3 wire, Delta
 - 240/480V 1 phase, 3 wire

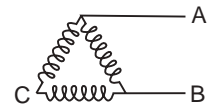

- 3 phase, 4 wire, Wye
 - 208Y/120V 3 phase, 4 wire
 - 480Y/277V 3 phase, 4 wire
 - 600Y/347V 3 phase, 4 wire

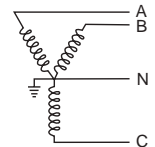

- 3 phase, 4 wire, Delta
 - 240/120V 3 phase, 4 wire
 - 480/240V 3 phase, 4 wire

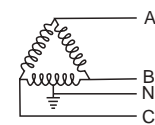

- 3 phase, 3 wire, Delta
 - 240V, 3 phase, 3 wire
 - 480V, 3 phase, 3 wire
 - 600V, 3 phase, 3 wire
 - 240V, 3 phase, 3 wire, grounded B
 - 480V, 3 phase, 3 wire, grounded B
 - 600V, 3 phase, 3 wire, grounded B

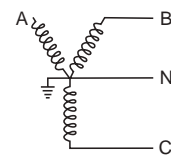
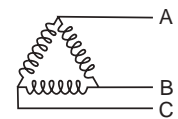

- 1 phase, 3 wire, Wye
 - 208Y/120V 1 phase, 3 wire
 - 480Y/277V 1 phase, 3 wire

DC voltage

- 1 phase, 2 wire
 - 125Vdc, 2 wire

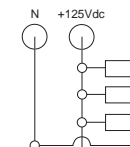

(Up to 125Vdc, MLO option only, SCCPB 40A or less.)

Panelboards

Dimensions and Panelboard Configurations

Selection

NEMA 1 and 3R Enclosure Dimensions

Encl. Type	Encl. Height	Dimensions (inches)								
		H	HC	MH	CH	DH	RH	SH	DW	D
NEMA 1	33	33.0	N/A	29.0	26.0	28.9	25.0	2.0	20.0	5.7
	50	50.0	N/A	43.0	40.0	37.9	39.0	3.5	20.0	5.7
	59	59.0	N/A	52.0	49.0	46.9	48.0	3.5	20.0	5.7
	69	69.0	N/A	62.0	59.0	56.9	58.0	3.5	20.0	5.7
NEMA 3R	33	33.0	34.5	35.5	26.0	28.9	25.0	2.0	20.0	6.3
	50	50.0	51.5	52.5	40.0	37.9	39.0	2.0	20.0	6.3
	59	59.0	60.5	61.5	49.0	46.9	48.0	2.0	20.0	6.3
	69	69.0	70.5	71.5	59.0	56.9	58.0	2.0	20.0	6.3

Available panelboard configurations

Based on enclosure height, panel amp rating and number of branch circuit positions

Encl. height (inches)	Panel amp rating	Branch positions	Available configurations
33"	30-200	18	· Main lug only, with or without feed-through lugs · Non-fused disconnect, no loadside options
		30	· Main lug only, no loadside options
50"	30-60	18	· 30 through 60A fused main disconnect with or without feed-through lugs or TVSS device
		30	· 30 through 60A fused main disconnect with or without feed-through lugs or TVSS device
		42	· 30 through 60A fused main disconnect with or without feed-through lugs or TVSS device
	70-200	18	· 70 through 200A fused main disconnect with or without feed-through lugs or TVSS device
		30	· 70 through 200A fused disconnect with or without feed-through lugs
	30-200	18	· Main lug only with TVSS device · Non-fused disconnect, with feed-through lugs or TVSS device
		30	· Main lugs only, with feed-through lugs or TVSS device · Non-fused disconnect, with or without feed through lugs
		42	· Main lug only, with or without feed-through lugs or TVSS device · Non-fused disconnect, with or without feed-through lugs
		225-400A	18
	30	· Main lug only, with or without feed-through lugs	
59"	70-200	30	· 70 through 200A fused main disconnect, with TVSS device
		42	· 70 through 200A fused main disconnect with or without feed-through lugs or TVSS device
	30-200	42	· Non-fused disconnect with TVSS device
	225-400A	18	· Main lug only with loadside disconnect · Non-fused disconnect, with TVSS device · 225 through 400A fused disconnect with or without feed-through lugs or TVSS device
		30	· Main lug only, with TVSS device · 225 through 400A fused disconnect, with no loadside options
		42	· Main lug only, with or without feed-through lugs or TVSS device · Non-fused disconnect, with no loadside options
69"	225-400A	18	· Non-fused disconnect, with loadside disconnect
		30	· Main lug only with loadside disconnect · 225 through 400A fused disconnect with feed-through lugs or TVSS device
		42	· Non-fused disconnect, with or without feed through lugs or TVSS device · 225 through 400A fused main disconnect, with or without feed-through lugs or TVSS device

Panelboards

NEMA 1 and NEMA 3R

Dimensions

NEMA 1 Enclosures and Interior

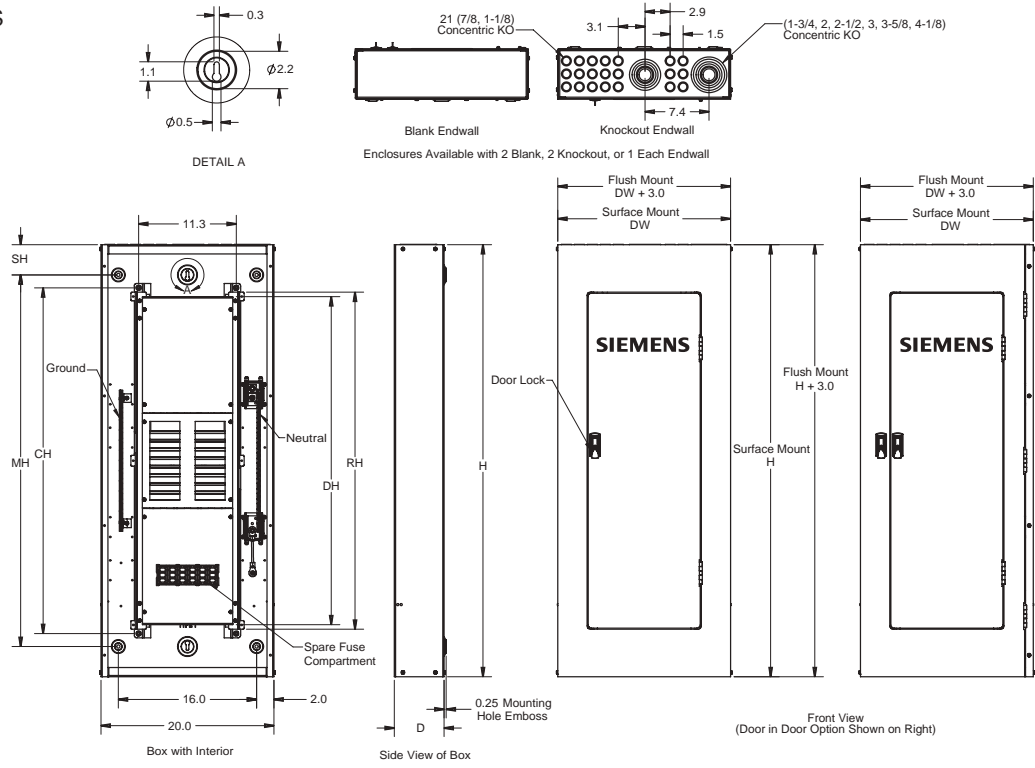

NEMA 3R Enclosures Interior same as NEMA 1

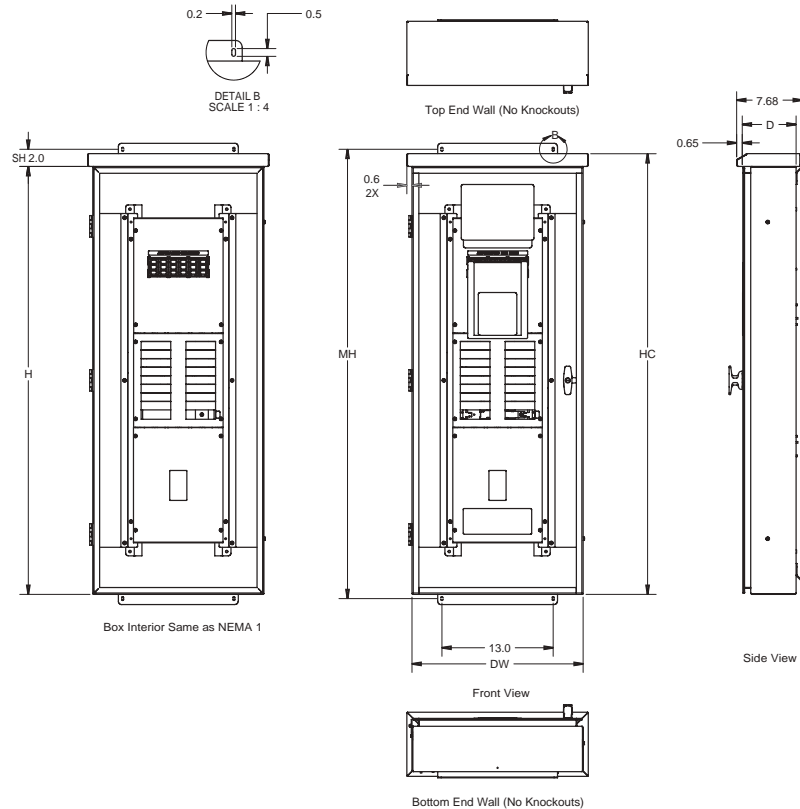

Panelboards

Fuse Curves

Selection

