



contents

3SE International (IEC) Limit Switches

3SE5 General data

Overview 13/4 - 13/9

3SE5 plastic enclosures

3SE5, selection and ordering data, 31 mm width 13/10 - 13/14

3SE5, selection and ordering data, 40 mm width 13/15 - 13/18

3SE5, selection and ordering data, 50 mm width 13/19 - 13/22

3SE5, selection and ordering data, ambient temperature to -40 C 13/23 - 13/26

3SE5 metal enclosures

3SE5, selection and ordering data, 31 mm width 13/27 - 13/30

3SE5, selection and ordering data, 40 mm width 13/31 - 13/34

3SE5, selection and ordering data, 56 mm width 13/35 - 13/38

3SE5, selection and ordering data, 56 mm width, XL 13/39 - 13/41

3SE5, selection and ordering data, ambient temperature to -40 C 13/42 - 13/44

3SE5 metal enclosures, compact design

3SE5, selection and ordering data 13/45 - 13/46

3SE5 open type design

3SE5, selection and ordering data 13/47

3SE5 accessories and spare parts

3SE5, selection and ordering data 13/48 - 13/50

3SE5 support information

Technical specifications 13/51

Configuration - actuation and operating travel 13/52 - 13/57

Dimensional drawings 13/58 - 13/60

Circuit diagrams 13/61

3SE03 North American (NEMA) Limit Switches

Plug-in and NEMA 6P Submersible

Overview 13/62

Technical specifications, modular plug-in and NEMA Type 6P submersible 13/63

Ordering and selection data:

Modular, plug-in metal housing 13/64

NEMA type 6P submersible, prewired cable 13/65

NEMA type 6P submersible, prewired receptacle 13/66

Modular, Plug-in and NEMA 6P submersible as components 13/67

Levers for plug-in and NEMA type 6P submersible 13/68 - 13/69

Wiring Diagrams 13/70

Dimension Diagrams 13/71 - 13/73

Metal Enclosure

Ordering and selection data 13/74 - 13/75

Specifications 13/74 - 13/75

Technical Data 13/75

Dimension drawings 13/74 - 13/75

Limit Switches and Safety

contents (cont.)

3SE Mechanical Safety

3SE7 Cable-operated Switches

Overview, technical data and travel diagrams	13/76
Selection and ordering data	13/77 - 13/79
Dimension drawings	13/80

3SE5 interlock switches with separate actuator

Overview	13/81
3SE5, selection and ordering data, plastic	13/82 - 13/83
3SE5, selection and ordering data, metal	13/84 - 13/85
3SE5, selection and ordering data, actuators	13/86
3SE2, selection and ordering data, plastic	13/87
Technical data	13/88
3SE5, operation and operating travel diagrams	13/89
3SE5, dimension drawings	13/90 - 13/91
3SE2, operation and operating travel diagrams	13/92
3SE2, dimension drawings	13/92

3SE5 interlock switches with solenoid locking

General data	13/93 - 13/94
3SE5, selection and ordering data, plastic enclosures	13/95
3SE5, selection and ordering data, metal enclosures	13/96
3SE5, selection and ordering data, actuators	13/97
Technical data	13/98
3SE5, Schematics, operation and operating travel diagrams	13/99
3SE5, dimension drawings	13/100

3SE5 / 3SE2 hinge switches

General data	13/101
3SE5, selection and ordering data, plastic	13/102
3SE5, selection and ordering data, metal	13/103
3SE2, selection and ordering data, plastic with integrated hinge	13/104
3SE5, contact blocks and operating travel diagrams	13/105
3SE5, dimension drawings	13/105
3SE2, technical data	13/106
3SE2, contact blocks and operating travel diagrams	13/106
3SE2, dimension drawings	13/106

3SE6 RFID Non-Contact Safety Switches

General data and system overview	13/107 - 13/108
Technical data	13/109
Selection and ordering data	13/110

3SE6 magnetic monitoring systems

General data	13/111
Selection and ordering data	13/112
Technical data	13/113
Dimension drawings	13/114
Circuit diagrams	13/115

3SU1 Two-hand Control.

3SU1, selection and ordering data	13/116
-----------------------------------	--------

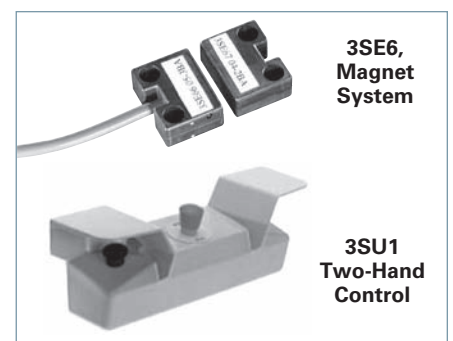

Limit Switches and Safety



contents (cont.)

Safety Relays

SIRIUS 3SK Safety Relays

General data and system overview	13/117 - 13/121
Technical data	13/122 - 13/123
Circuit diagrams	13/124 - 13/126
Selection and ordering data	13/127 - 13/132
Accessories	13/133 - 13/136
Cross reference from 3TK28	13/137 - 13/138

SIRIUS 3TK28 Safety Relays

3TK28 with relay enabling circuits	13/139 - 13/141
3TK28 with electronic enabling circuits	13/142 - 13/144
3TK28 with special functions	13/145 - 13/146
Accessories	13/147

3RK3 Modular Safety System

General data and system overview	13/148 - 13/151
Selection and ordering data	13/152 - 13/155
Technical data	13/156 - 13/157
Application data	13/158
Dimensional drawings	13/159

Overview



3SE5 23., 3SE5 21., 3SF1 2.4 3SE5 24., 3SF1 244 3SE5 13., 3SE5 11., 3SF1 114 3SE5 12., 3SF1 124 3SE5 16. 3SE5 232, 3SE5 212, 3SF1 2.4 3SE5 132, 3SE5 112, 3SF1 1.4

	Position switches, standard					Safety hinge switches	
Enclosure							
Plastic	✓	✓	✓	—	—	✓	✓
Metal	✓	—	✓	✓	✓	✓	✓
Dimensions (W x H x D) in mm	31 x 68 x 33	50 x 53 x 33	40 x 78 x 38	56 x 78 x 38	56 x 100 x 38	31 x 68 x 33	40 x 78 x 38
Degree of protection	IP65, IP66/IP67	IP66/IP67	IP66/IP67	IP66/IP67	IP66/IP67	IP65, IP66/IP67	IP66/IP67
Standards							
IEC 60947-5-1	Mounting and operating points acc. to EN 50047	Operating points acc. to EN 50047	Mounting and operating points acc. to EN 50041	Operating points acc. to EN 50041	Operating points acc. to EN 50047	Mounting and operating points acc. to EN 50047	Mounting and operating points acc. to EN 50041
Approvals	CE, UL, CSA, CCC		CE, UL, CSA, CCC			CE, UL, CSA, CCC	
Contact blocks							
2 slow-action contacts	1 NO + 1 NC, 2 NC		1 NO + 1 NC, 2 NC		—	1 NO + 1 NC	
2 snap-action contacts	1 NO + 1 NC		1 NO + 1 NC		—	1 NO + 1 NC	
• Short stroke	1 NO + 1 NC		✓		—	✓	
• With 2 x 2 mm contact gap	1 NO + 1 NC		✓		—	✓	
3 slow-action contacts	1 NO + 2 NC, 2 NO + 1 NC		1 NO + 2 NC, 2 NO + 1 NC		—	1 NO + 2 NC	
• With make-before-break	1 NO + 2 NC		1 NO + 2 NC		—	1 NO + 2 NC	
3 snap-action contacts	1 NO + 2 NC		1 NO + 2 NC		—	1 NO + 2 NC	
2 x (2 or 3 contacts)	—		—		✓	—	
Special features							
LED status display	✓		✓		—	✓	
Increased corrosion protection	✓		✓		✓	✓	
Explosion protection (ATEX)	—		✓		✓	✓	
ASIsafe integrated	✓		✓		—	✓	
Electrical specifications							
Insulation voltage U_i	400 V		400 V			400 V	
Conventional thermal current I_{the}	6 A/10 A (3-/2-pole)		6 A/10 A (3-/2-pole)			6 A/10 A (3-/2-pole)	
Connections							
Cable entry	1 x M20 x 1.5	2 x M20 x 1.5	1 x M20 x 1.5	3 x M20 x 1.5	1 x M20 x 1.5	1 x M20 x 1.5	1 x M20 x 1.5
M12 connector socket, 4-, 5- or 8-pole	✓	✓	✓	✓	✓	✓	✓
Connector socket, 6-pole + PE	—	—	✓	✓	—	—	—
Actuators							
Rounded plungers and roller plungers	✓		✓		—	—	
Roller and angular roller levers	✓		✓		—	—	
Spring rod	✓		✓		—	—	
Twist levers and rod actuators	✓		✓		—	—	
Fork lever	—		✓		—	—	
Hinge switches	—		—		—	✓	
Page							
Complete units	13/10, 13/27	13/19	13/15, 13/31	13/35	13/39	13/102	13/103
Modular system	13/13, 13/29	13/21	13/17, 13/33	13/37	13/40	—	—
Ambient temperature -40 °C	13/23, 13/42	13/23	13/26, 13/43	13/43	13/43	—	—
ASIsafe	on-line	on-line	on-line	on-line	—	on-line	on-line
ATEX	on-line	on-line	on-line	on-line	on-line	on-line	on-line

✓ Available
— Not available

Introduction



	Compact design	Open-type	Safety switches with separate actuator		Safety switches with solenoid interlocking	RFID safety switch
Enclosure						
Plastic	—	✓	✓	✓	✓	✓
Metal	✓	—	✓	✓	✓	—
Dimensions (W x H x D) in mm	30 x .. x .., 40 x .. x ..	30 x 48.5 x 20	31 x 68 x 33, 50 x 53 x 33	40 x 78 x 38, 56 x 78 x 38	54 x 185 x 44	25 x 91 x 22
Degree of protection	IP66/IP67	IP10 or IP20	IP65, IP66/IP67	IP66/IP67	IP66/IP67	IP69K
Standards	—	Mounting and operating points acc. to EN 50047	Mounting acc. to EN 50047	Mounting acc. to EN 50041	EN 1088	Category 4 acc. to ISO 13849-1, PL e acc. to ISO 13849-1, SIL 3 acc. to IEC 61508
IEC 60947-5-1						
Approvals	CE, UL, CSA	—	CE, TÜV, UL, CSA, CCC		CE, TÜV, UL, CSA, CCC	CE, TÜV
Contact blocks						
2 slow-action contacts	—	1 NO + 1 NC	1 NO + 1 NC	—	—	—
2 snap-action contacts	1 NO + 1 NC	1 NO + 1 NC	—	—	—	—
• Short stroke	—	✓	—	—	—	—
• With 2 x 2 mm contact gap	—	✓	—	—	—	—
3 slow-action contacts	—	1 NO + 2 NC	1 NO + 2 NC	—	—	—
• With make-before-break	—	1 NO + 2 NC	—	—	—	—
3 snap-action contacts	—	1 NO + 2 NC	—	—	—	—
6 slow-action contacts	—	—	—	—	2 x (1 NO + 2 NC)	—
Special features						
LED status display	—	—	✓	—	✓	✓
Increased corrosion protection	—	—	✓	—	✓	✓
Explosion protection (ATEX)	—	—	✓	—	—	—
ASIsafe integrated	—	—	✓	—	✓	—
Electrical specifications						
Insulation voltage U_i	400 V	400 V	400 V	—	400 V	—
Conventional thermal current I_{the}	10 A	6 A	6 A	—	6 A	—
Connections						
Cable entry	—	—	1 x M20 x 1.5, 2 x M20 x 1.5	1 x M20 x 1.5, 3 x M20 x 1.5	3 x M20 x 1.5	—
M12 connector socket, 4-, 5- or 8-pole	✓	—	✓	✓	✓	✓
Molded cables	✓	—	—	—	—	—
AS-Interface	—	—	✓	✓	✓	—
Actuators						
Plungers, twist levers	✓	✓	—	—	—	—
Separate actuators	—	—	✓	—	✓	—
Page						
Complete units	13/46	13/47	13/82	13/85	13/95	—
Modular system	—	—	—	—	—	13/110
ASIsafe	—	—	on-line	on-line	on-line	—
ATEX	—	—	on-line	on-line	—	—

✓ Available
— Not available

SIRIUS 3SE5 International Limit Switches

General Data

Overview

Position switches in the innovative SIRIUS 3SE5 series are modern in design, compact, modular and simple to connect.

Complete units

Popular versions of the position switches in standard enclosures are available as complete units.



Position switches with plastic and metal enclosures

Modular system

The 3SE5 series features a new modular system comprising different sizes of the basic switch and an actuator which must be ordered separately. Thanks to the modular construction of the switch the user can select the right solution for his application from numerous versions and install it himself in a very short time. The short delivery times of the modules enable fast replacement and thus ensure high plant availability.



Examples of selection options in the modular system

DesignEnclosure sizes

All enclosure versions have an integrated chlorinated rubber diaphragm for high functional safety in cold and aggressive environments.

The 3SE5 switches are available in five different enclosure sizes with 2 or 3 contacts and with the XL enclosure:

- Open-type position switch IP20 or IP10
- Plastic enclosures according to EN 50047 (31 mm wide), IP65, 1 cable entry
- Plastic enclosures (50 mm wide), IP66/IP67, 2 cable entries
- Metal enclosures according to EN 50047, (31 mm wide), IP66/IP67, 1 cable entry
- Plastic and metal enclosures according to EN 50041 (40 mm wide), IP66/IP67, 1 cable entry
- Metal enclosures (56 mm wide), IP66/IP67, 3 cable entries
- XL metal enclosures with 4 to 6 contacts, 56 mm wide, IP66/IP67, 3 cable entries

Various basic switches can be selected for the 3SE5 series:

- With contact blocks with two or three contacts (screw terminals) designed as slow-action or snap-action contacts; the slow-action contacts also make-before-break
- Optional LED status display
- With mounted four or five-pole M12 connector socket (available for the wide enclosures as an accessory for self-assembly)
- With 6-pole connector socket + PE on the metal enclosures
- With increased corrosion protection
- Versions for operating temperature to -40°C
- Metal enclosures for explosion protection (ATEX)
- AS-Interface version with integrated ASIsafe electronics for all enclosure designs

Actuator variants

All operating mechanisms can be rotate around the axis in increments of 22.5° . The following actuator variants are available:

- Standard, rounded and roller plungers
- Roller and angular roller levers
- Spring rods
- Twist levers and rod actuators
- Fork levers with twist actuator

The actuator rollers are available with various materials and diameters.

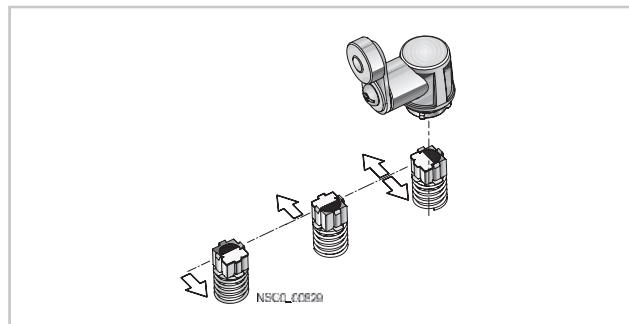

Twist actuators for twist levers and rod actuators, with setting of switching to right, left or right/left (standard for all twist actuators except version for fork levers)

SIRIUS 3SE5 International Limit Switches

General Data

Optional LED indicators

LED indicators available for all enclosure sizes



The enclosure versions can be supplied with an LED signaling indicator (1 × green + 1 × yellow). This is the first time that optical signaling equipment is also available for small standard enclosures according to EN 50047. The LED signaling indicators are available in all common voltages (24 V DC and 230 V AC).

Additional contacts

Exchangeable two and three-pole switching blocks for all enclosure sizes



The three-pole switching block (2 NC, 1 NO) in snap-action and slow-action is regularly available for all enclosure forms. It offers more switching through redundant shutdowns (2 NC contacts) with simultaneous signaling (1 NO contact). The same installation space is required as for a two-pole switching block.

Contact reliability

The new contact blocks ensure an extremely high contact stability. This applies even when the devices are switching low voltages and currents, e. g. 1 mA at 5 V DC.

Positive opening ☞

The NC contacts of the switch are forced open mechanically, positively-driven and reliably by the plunger. This is referred to as "positive opening".

Mounting

Easy plug-in method – for fast replacement of the actuator head

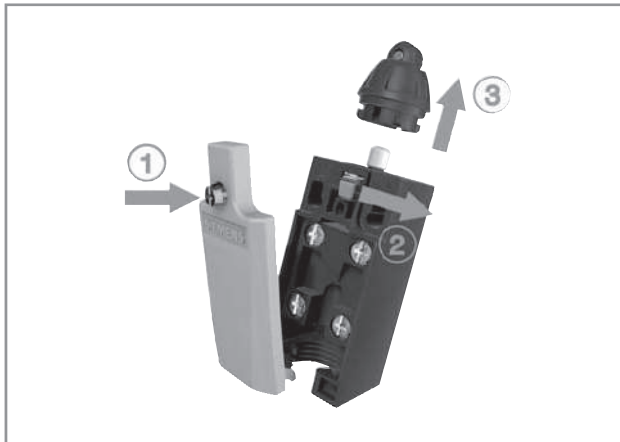

- (1) Open cover
- (2) Actuate locking lever
- (3) Replace the head (turnable by 16 x 22.5°)
- (4) Lock and close the cover

Fast connection method

For plastic enclosure with a width of 31 mm

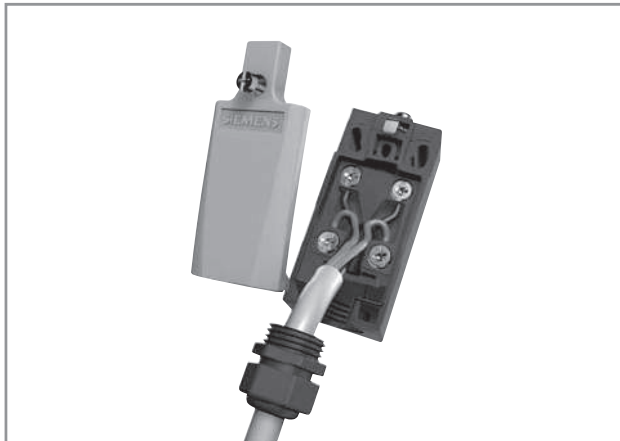

These position switches can be wired quickly and easily as an added customer benefit. The connecting cable is first connected to the terminals of the contact block and then guided through a slit into the cable gland opening. The time saved through this new connection method is approx. 20 to 25 %.

Benefits

The 3SE5 position switches differ from the previous series through the following new characteristics:

- The modular design of the product range allows a number of versions with a smaller number of bearing types for enclosures and operating mechanisms.
- All actuators can be turned around the axis in increments of 22.5° (see picture on page 13/6).
- Rounded and roller plungers according to EN 50041 with 3 mm overtravel (total travel 9 mm) for greater tolerance when switching
- All enclosure sizes – now also including the small enclosure 31 mm wide – are optionally available with an LED signaling indicator (see picture on page 13/7).
- All enclosure versions have an integrated chlorinated rubber diaphragm (high functional safety in cold and aggressive environments).
- All contact blocks are replaceable (see page 13/49).
- The three-pole contact blocks are available for all enclosure sizes (see picture on page 13/7).
- Elements with 1 NO + 2 NC slow-action contacts with make-before-break and 2 NO + 1 NC
- The short-stroke contact block 1 NO + 1 NC improves the precision of the switching operation through a reduced actuation path.
- The contact block with 1 NO + 1 NC snap-action contacts with 2 x 2 mm contact opening is suitable for simultaneous disconnection and signaling, particularly in the elevator industry
- NEW: XL enclosures for accommodating two 2- or 3-pole contact blocks
- The plastic enclosure with a width of 31 mm has simple and fast wiring equipment which makes it possible to save from approx. 20 to 25 % of the time when connecting (see picture on page 13/7).
- The ASIsafe electric component is integrated for the versions with the AS-Interface connection (see on-line); an additional adapter is not required.

Application

With the standard position switches, mechanical positions of moved machine parts are converted into electrical signals. Through their modular and uniform design and large number of versions, the devices can meet practically all requirements in industry.

Devices are available with enclosure versions to suit the particular ambient conditions. Different control tasks can be performed with the best contact blocks suited for the particular purpose. And many different actuator versions are available to match the mechanical configuration of the moved machined parts. Dimensions, fixing points and characteristics are largely in accordance with the EN 50041 or EN 50047 standards.

The devices are suitable for use in any climate.

Standards

IEC 60947-5-1 or EN 60947-5-1.

The protective measure of "total insulation" by the molded-plastic enclosure is guaranteed by the use of molded-plastic screw-glands.

Safety position switches

For controls according to IEC 60204-1 or EN 60204-1 the devices can be used as a safety position switch. To secure position switches against changes in their position, keyed techniques must be employed on installation.

Safety circuits

IEC 60947-5-1 and EN 60947-5-1 require positive opening of the NC contacts, i.e. for the purposes of personal safety, the assured opening of NC contacts is expressly stipulated for the electrical equipment of machines in all safety circuits and marked according to the IEC standard 60947-5-1 with the symbol q .

Category 2 according to ISO 13849-1 (EN 954-1) can be attained with 3SE5 position switches with q , and category 3 or 4 when using an additional position switch, if the corresponding failsafe evaluation units are selected and correctly installed, e.g. the 3TK28 safety relays or matching devices from the ASIsafe, SIMATIC or SINUMERIK product ranges. The operating mechanisms (actuators) must also be connected to the enclosure by keyed techniques. The corresponding operating mechanisms are marked in the catalog with q .

Contacts for each application

- Snap-action contacts: NC and NO contacts switch simultaneously – regardless of the actuating speed ($v_{\min} = 0.01$ m/s) and contact erosion.
- Slow-action contacts: Difference in travel between "NC contact opens" and "NO contact closes"; the switching speed is the same as or proportional to the actuating speed ($v_{\min} = 0.4$ m/s).
- Slow-action contacts with make-before-break: e.g. suitable for adding a second function to a sequence control.

Operating mechanisms for each applicationStandard, rounded and roller plungers

- Operation in direction of the plunger axis or in case of roller plunger with bar at right angles to the plunger axis
- The roller plunger is recommended for lateral actuation and relatively long overtravel.

Roller and angular roller levers

- For actuators made of finely ground steel in the form of cams, straight-edges (approach angle 30°) or cam disks

Spring rod

- Can be used for undefined actuations and changing starting conditions
- Starting from any direction is possible

Twist levers and rod actuators

- For a high starting speed ($v = 1.5$ m/s)
- Variety of starting options
- Insensitive to oil, grinding dust and coarse-grained material
- Adjustment of the lever in increments of 10°.
- Can be adjusted with left or right switching

Fork lever

- Switchable in two directions
- Latching actuator
- For reciprocating movements

SIRIUS 3SE5 International Limit Switches

General Data

Options

On the following pages you will find selection tables for complete units as well as components of the modular system.

- Complete units
- Modular system

The difference between units is indicated in the selection and ordering data by gray backgrounds.

Using the modular system you can assemble switch variants which are not available as complete units. Each complete unit can also be supplied as a module.

A basic switch for the modular system comprises an enclosure with a contact block and a cover. Among the basic switches the following versions, for example, can be selected:

- Basic enclosure with teflon plunger
- Version with increased corrosion protection
- Version with 2 LEDs

- Version with M12 connector socket or 6-pole + PE
- Version with M12 connector socket and with 2 LEDs

For the plastic enclosures with a width of 31 and 50 mm the basic switches are designed as complete units with rounded plunger (according to standard).

Online configurator

The online configurator helps you not only to select and order the right position switch but also to create complete product documentation.

- Product data sheets
- Dimensional drawings
- Operating travel diagrams
- CAD data in 2D and 3D model images
- Ordering data
- Product photos

www.siemens.com/sirius/configurators

Complete units

Ordering example

Required:

- Position switch according to EN 50047 in a plastic enclosure
- Contact block with slow-action contacts 1 NO + 1 NC
- Angular roller lever, metal lever and plastic roller

To be ordered:

Version	Complete units <input type="checkbox"/>
Order No.	
Complete units • Enclosure width 31 mm	
	Angular roller levers With metal lever and plastic roller 13 mm Slow-action contacts 1 NO + 1 NC 3SE5 232-0BF10

Modular system

Ordering example 1

Required:



- Position switch according to EN 50047 in a plastic enclosure
- Contact block with slow-action contacts 1 NO + 1 NC
- Angular roller lever, metal lever and plastic roller

Ordering example 2



Required:

- Position switch according to EN 50047 in a plastic enclosure
- Contact block with slow-action contacts 1 NO + 1 NC
- Twist lever, high-grade steel lever and plastic roller

To be ordered separately:

Version	Modular system <input checked="" type="checkbox"/>
Order No.	
Basic switches • Enclosure width 31 mm	
	With teflon plunger Slow-action contacts 1 NO + 1 NC 3SE5 232-0BC05
+	
Operating mechanisms	
	Angular roller levers Metal lever, plastic roller 3SE5 000-0AF10

To be ordered separately:

Version	Modular system <input checked="" type="checkbox"/>
Order No.	
Basic switches • Enclosure width 31 mm	
	With teflon plunger Slow-action contacts 1 NO + 1 NC 3SE5 232-0BC05
+	
Twist actuators	
	Twist actuators 3SE5 000-0AK00
	Twist levers High-grade steel lever, plastic roller 3SE5 000-0AA31

SIRIUS 3SE5 International Limit Switches

3SE5, plastic enclosures – Enclosure width 31 mm acc. to EN 50047

Selection and ordering data

Complete units

2 or 3 contacts · Degree of protection IP65 · Cable entry M20 × 1.5¹⁾

Version	Contacts	LEDs	DT	Complete units	Configurator	Order No.	Price per PU	PU (UNIT, SET, M)	PS*

Complete units²⁾ · Enclosure width 31 mm

Rounded plungers, type B, acc. to EN 50047

With teflon plunger

Slow-action contacts	1 NO + 1 NC	—	⊕ A	3SE5 232-0BC05	1	1 unit
Snap-action contacts	1 NO + 1 NC	—	⊕ B	3SE5 232-0CC05	1	1 unit
Snap-action contacts, integrated ³⁾	1 NO + 1 NC	—	⊕ A	3SE5 232-0HC05	1	1 unit
Snap-action contacts • Short stroke, integrated ³⁾	1 NO + 1 NC	—	⊕ B	3SE5 232-0FC05	1	1 unit
Snap-action contacts • 2 × 2 mm contact gap	1 NO + 1 NC	—	⊕ B	3SE5 232-0GC05	1	1 unit
Slow-action contacts	1 NO + 2 NC	—	⊕ A	3SE5 232-0KC05	1	1 unit
Snap-action contacts	1 NO + 2 NC	—	⊕ A	3SE5 232-0LC05	1	1 unit
Slow-action contacts with make-before-break	1 NO + 2 NC	—	⊕ ▶	3SE5 232-0MC05	1	1 unit
Slow-action contacts	2 NO + 1 NC	—	⊕ A	3SE5 232-0PC05	1	1 unit

With increased corrosion protection

Slow-action contacts	1 NO + 1 NC	—	⊕ B	3SE5 232-0BC05-1CA0	1	1 unit
Snap-action contacts	1 NO + 1 NC	—	⊕ B	3SE5 232-0CC05-1CA0	1	1 unit
Slow-action contacts	1 NO + 2 NC	—	⊕ B	3SE5 232-0KC05-1CA0	1	1 unit
Snap-action contacts	1 NO + 2 NC	—	⊕ B	3SE5 232-0LC05-1CA0	1	1 unit
Slow-action contacts with make-before-break	1 NO + 2 NC	—	⊕ B	3SE5 232-0MC05-1CA0	1	1 unit
Slow-action contacts	2 NO + 1 NC	—	⊕ B	3SE5 232-0PC05-1CA0	1	1 unit

With M12 connector socket, 4-pole (250 V, 4 A)

Slow-action contacts	1 NO + 1 NC	—	⊕ B	3SE5 234-0BC05-1AC4	1	1 unit
Snap-action contacts, integrated ³⁾	1 NO + 1 NC	—	⊕ A	3SE5 234-0HC05-1AC4	1	1 unit
Slow-action contacts	2 NC	—	⊕ B	3SE5 234-0KC05-1AE0	1	1 unit
Snap-action contacts	2 NC	—	⊕ A	3SE5 234-0LC05-1AE0	1	1 unit

With 2 LEDs, yellow/green

Slow-action contacts	1 NO + 2 NC	24 V DC	⊕ B	3SE5 232-1KC05	1	1 unit
Snap-action contacts	1 NO + 2 NC	24 V DC	⊕ B	3SE5 232-1LC05	1	1 unit
Slow-action contacts	1 NO + 2 NC	230 V AC	⊕ B	3SE5 232-3KC05	1	1 unit
Snap-action contacts	1 NO + 2 NC	230 V AC	⊕ B	3SE5 232-3LC05	1	1 unit

With M12 connector socket, 5-pole (125 V, 4 A) and 2 LEDs

Slow-action contacts	1 NO + 1 NC	24 V DC	⊕ B	3SE5 234-1BC05-1AF3	1	1 unit
Snap-action contacts	1 NO + 1 NC	24 V DC	⊕ B	3SE5 234-1CC05-1AF3	1	1 unit

For online configurator see www.siemens.com/sirius/configurators.

Positive opening according to IEC 60947-5-1, Appendix K.

¹⁾ A cable gland with seal must be used with the quick-connect method.

²⁾ Popular versions.

³⁾ Subsequent replacement of contact blocks is not possible.



Rounded plungers



With increased corrosion protection



With 2 LEDs





SIRIUS 3SE5 International Limit Switches

3SE5, plastic enclosures – Enclosure width 31 mm acc. to EN 50047

2 or 3 contacts · Degree of protection IP65 · Cable entry M20 × 1.5¹⁾

Version	Contacts	LEDs	DT	Complete units	<input type="checkbox"/>	PU (UNIT, SET, M)	PS*
				Configurator			
				Order No.		Price per PU	

Complete units²⁾ · Enclosure width 31 mm

 Roller plunger	Roller plungers, type C acc. to EN 50047						
	With plastic roller 10 mm						
	Slow-action contacts	1 NO + 1 NC	—	⊕ B	3SE5 232-0BD03		1 1 unit
	Snap-action contacts • Integrated ³⁾	1 NO + 1 NC	—	⊕ A	3SE5 232-0HD03		1 1 unit
	Snap-action contacts • Short stroke, integrated ³⁾	1 NO + 1 NC	—	⊕ B	3SE5 232-0FD03		1 1 unit
	Slow-action contacts	1 NO + 2 NC	—	⊕ B	3SE5 232-0KD03		1 1 unit
	Snap-action contacts	1 NO + 2 NC	—	⊕ ▶	3SE5 232-0LD03		1 1 unit
Actuator head rotated by 90°							
Snap-action contacts	1 NO + 2 NC	—	⊕ B	3SE5 232-0LD03-1AH0		1 1 unit	
With M12 connector socket, 4-pole (250 V, 4 A)							
Snap-action contacts, integrated ³⁾	1 NO + 1 NC	—	⊕ B	3SE5 234-0HD03-1AC4		1 1 unit	
 Roller plunger with central fixing	Roller plungers with central fixing						
	Snap-action contacts, integrated ³⁾	1 NO + 1 NC	—	⊕ B	3SE5 232-0HD10		1 1 unit
	Slow-action contacts	1 NO + 2 NC	—	⊕ B	3SE5 232-0KD10		1 1 unit
 Roller lever	Roller levers, type E acc. to EN 50047						
	With metal lever and plastic roller 13 mm						
	Slow-action contacts	1 NO + 1 NC	—	⊕ ▶	3SE5 232-0BE10		1 1 unit
	Snap-action contacts, integrated ³⁾	1 NO + 1 NC	—	⊕ A	3SE5 232-0HE10		1 1 unit
	Slow-action contacts	1 NO + 2 NC	—	⊕ B	3SE5 232-0KE10		1 1 unit
Snap-action contacts	1 NO + 2 NC	—	⊕ B	3SE5 232-0LE10		1 1 unit	
With M12 connector socket, 4-pole (250 V, 4 A)							
Snap-action contacts, integrated ³⁾	1 NO + 1 NC	—	⊕ B	3SE5 234-0HE10-1AC4		1 1 unit	
 Angular roller lever	Angular roller levers						
	With metal lever and plastic roller 13 mm						
	Slow-action contacts	1 NO + 1 NC	—	⊕ ▶	3SE5 232-0BF10		1 1 unit
	Snap-action contacts, integrated ³⁾	1 NO + 1 NC	—	⊕ ▶	3SE5 232-0HF10		1 1 unit
	Slow-action contacts	1 NO + 2 NC	—	⊕ B	3SE5 232-0KF10		1 1 unit
Snap-action contacts	1 NO + 2 NC	—	⊕ B	3SE5 232-0LF10		1 1 unit	

For online configurator see www.siemens.com/sirius/configurators.

⊕ Positive opening according to IEC 60947-5-1, Appendix K.

¹⁾ A cable gland with seal must be used with the quick-connect method.

²⁾ Popular versions.

³⁾ Subsequent replacement of contact blocks is not possible.

SIRIUS 3SE5 International Limit Switches

3SE5, plastic enclosures – Enclosure width 31 mm acc. to EN 50047

2 or 3 contacts · Degree of protection IP65 · Cable entry M20 × 1.5¹⁾

Version	Contacts	LEDs	DT	Complete units	<input type="checkbox"/>	PU (UNIT, SET, M)	PS*
				Configurator			
				Order No.	Price per PU		

Complete units²⁾ · Enclosure width 31 mm

Spring rods							
Length 142.5 mm, with plastic plunger 50 mm							
Snap-action contacts, integrated ³⁾ 1 NO + 1 NC — A 3SE5 232-0HR01 1 1 unit							
With M12 connector socket, 4-pole (250 V, 4 A)							
Snap-action contacts, integrated ³⁾ 1 NO + 1 NC — B 3SE5 234-0HR01-1AC4 1 1 unit							
Twist levers, type A acc. to EN 50047							
With metal lever 21 mm and plastic roller 19 mm							
Slow-action contacts 1 NO + 1 NC — 3SE5 232-0BK21 1 1 unit							
Snap-action contacts, integrated ³⁾ 1 NO + 1 NC — 3SE5 232-0HK21 1 1 unit							
Slow-action contacts 1 NO + 2 NC — B 3SE5 232-0KK21 1 1 unit							
Snap-action contacts 1 NO + 2 NC — B 3SE5 232-0LK21 1 1 unit							
With M12 connector socket, 4-pole (250 V, 4 A)							
Snap-action contacts, integrated ³⁾ 1 NO + 1 NC — B 3SE5 234-0HK21-1AC4 1 1 unit							
With metal lever 35 mm and plastic roller 19 mm							
Snap-action contacts, integrated ³⁾ 1 NO + 1 NC — B 3SE5 232-0HK15 1 1 unit							
Twist levers, adjustable length							
With metal lever with grid hole and plastic roller 19 mm							
Snap-action contacts, integrated ³⁾ 1 NO + 1 NC — A 3SE5 232-0HK60 1 1 unit							
With metal lever and plastic roller 19 mm							
Slow-action contacts 1 NO + 1 NC — B 3SE5 232-0BK50 1 1 unit							
Snap-action contacts, integrated ³⁾ 1 NO + 1 NC — 3SE5 232-0HK50 1 1 unit							
Snap-action contacts 1 NO + 2 NC — B 3SE5 232-0LK50 1 1 unit							
With M12 connector socket, 4-pole (250 V, 4 A)							
Snap-action contacts, integrated ³⁾ 1 NO + 1 NC — B 3SE5 234-0HK50-1AC4 1 1 unit							
Rod actuators							
With aluminum rod, length 200 mm							
Snap-action contacts, integrated ³⁾ 1 NO + 1 NC — B 3SE5 232-0HK80 1 1 unit							
With plastic rod, length 200 mm							
Snap-action contacts, integrated ³⁾ 1 NO + 1 NC — 3SE5 232-0HK82 1 1 unit							
With M12 connector socket, 4-pole (250 V, 4 A)							
Snap-action contacts, integrated ³⁾ 1 NO + 1 NC — B 3SE5 234-0HK82-1AC4 1 1 unit							



Spring rod



Twist lever



Twist lever, adjustable length



Rod actuator

For online configurator see www.siemens.com/sirius/configurators.

Positive opening according to IEC 60947-5-1, Appendix K.

¹⁾ A cable gland with seal must be used with the quick-connect method.

²⁾ Popular versions.

³⁾ Subsequent replacement of contact blocks is not possible.

Note:

If the device you require is not available as a complete unit, see "Modular System", page 13/13.

SIRIUS 3SE5 International Limit Switches

3SE5, plastic enclosures – Enclosure width 31 mm acc. to EN 50047

Modular system

2 or 3 contacts · Degree of protection IP65 · Cable entry M20 × 1.5¹⁾

Version	Contacts	LEDs	DT	Modular system		PU (UNIT, SET, M)	PS*
				Configurator			
				Order No.	Price per PU		

Basic switches · Enclosure width 31 mm (with rounded plunger²⁾)

	With teflon plunger						
	Slow-action contacts	1 NO + 1 NC	—	⊕ A	3SE5 232-0BC05	1	1 unit
	Snap-action contacts	1 NO + 1 NC	—	⊕ ▶	3SE5 232-0CC05	1	1 unit
	Snap-action contacts, integrated ³⁾	1 NO + 1 NC	—	⊕ ▶	3SE5 232-0HC05	1	1 unit
	Snap-action contacts • Short stroke, integrated ³⁾	1 NO + 1 NC	—	⊕ B	3SE5 232-0FC05	1	1 unit
	Snap-action contacts • 2 × 2 mm contact gap	1 NO + 1 NC	—	⊕ B	3SE5 232-0GC05	1	1 unit
	Slow-action contacts	1 NO + 2 NC	—	⊕ A	3SE5 232-0KC05	1	1 unit
	Snap-action contacts	1 NO + 2 NC	—	⊕ ▶	3SE5 232-0LC05	1	1 unit
	Slow-action contacts with make-before-break	1 NO + 2 NC	—	⊕ A	3SE5 232-0MC05	1	1 unit
Slow-action contacts	2 NO + 1 NC	—	⊕ A	3SE5 232-0PC05	1	1 unit	
	With increased corrosion protection⁴⁾						
	Slow-action contacts	1 NO + 1 NC	—	⊕ B	3SE5 232-0BC05-1CA0	1	1 unit
	Snap-action contacts	1 NO + 1 NC	—	⊕ B	3SE5 232-0CC05-1CA0	1	1 unit
	Slow-action contacts	1 NO + 2 NC	—	⊕ B	3SE5 232-0KC05-1CA0	1	1 unit
	Snap-action contacts	1 NO + 2 NC	—	⊕ B	3SE5 232-0LC05-1CA0	1	1 unit
	Slow-action contacts with make-before-break	1 NO + 2 NC	—	⊕ B	3SE5 232-0MC05-1CA0	1	1 unit
Slow-action contacts	2 NO + 1 NC	—	⊕ B	3SE5 232-0PC05-1CA0	1	1 unit	
	With M12 connector socket, 4-pole (250 V, 4 A)						
	Slow-action contacts	1 NO + 1 NC	—	⊕ B	3SE5 234-0BC05-1AC4	1	1 unit
	Snap-action contacts, integrated ³⁾	1 NO + 1 NC	—	⊕ A	3SE5 234-0HC05-1AC4	1	1 unit
	Slow-action contacts	2 NC	—	⊕ B	3SE5 234-0KC05-1AE0	1	1 unit
Snap-action contacts	2 NC	—	⊕ A	3SE5 234-0LC05-1AE0	1	1 unit	
	With 2 LEDs, yellow/green						
	Slow-action contacts	1 NO + 2 NC	24 V DC	⊕ B	3SE5 232-1KC05	1	1 unit
	Snap-action contacts	1 NO + 2 NC	24 V DC	⊕ B	3SE5 232-1LC05	1	1 unit
	Slow-action contacts	1 NO + 2 NC	230 V AC	⊕ B	3SE5 232-3KC05	1	1 unit
Snap-action contacts	1 NO + 2 NC	230 V AC	⊕ B	3SE5 232-3LC05	1	1 unit	
	With M12 connector socket, 5-pole (125 V, 4 A) and 2 LEDs						
	Slow-action contacts	1 NO + 1 NC	24 V DC	⊕ B	3SE5 234-1BC05-1AF3	1	1 unit
Snap-action contacts	1 NO + 1 NC	24 V DC	⊕ B	3SE5 234-1CC05-1AF3	1	1 unit	

For online configurator see www.siemens.com/sirius/configurators.

⊕ Positive opening according to IEC 60947-5-1, Appendix K, or positively driven actuator, necessary in safety circuits.

¹⁾ A cable gland with seal must be used with the quick-connect method.

²⁾ For enclosures with widths of 31mm, the basic switch is a complete unit with rounded plungers.

³⁾ Subsequent replacement of contact blocks is not possible.











⁴⁾ Use corresponding high-grade steel lever.

Note:

Selection aid [see page 13/9](#).

SIRIUS 3SE5 International Limit Switches

3SE5, plastic enclosures – Enclosure width 31 mm acc. to EN 50047

Version	Diameter	DT	Modular system	Price per PU	PU (UNIT, SET, M)	PS*
	mm		Order No.			
Operating mechanisms						
	Roller plungers, type C acc. to EN 50047					
	Plastic rollers	10	⊕ ▶	3SE5 000-0AD03	1	1 unit
	High-grade steel rollers	10	⊕ B	3SE5 000-0AD04	1	1 unit
	Roller plungers with central fixing					
	Plastic rollers	10	⊕ B	3SE5 000-0AD10	1	1 unit
	High-grade steel rollers	10	⊕ B	3SE5 000-0AD11	1	1 unit
	Roller levers, type E acc. to EN 50047					
	Metal lever, plastic roller	13	⊕ ▶	3SE5 000-0AE10	1	1 unit
	Metal lever, high-grade steel roller	13	⊕ ▶	3SE5 000-0AE11	1	1 unit
	High-grade steel lever, plastic roller	13	⊕ B	3SE5 000-0AE12	1	1 unit
	High-grade steel lever, high-grade steel roller	13	⊕ B	3SE5 000-0AE13	1	1 unit
	Angular roller levers					
	Metal lever, plastic roller	13	⊕ ▶	3SE5 000-0AF10	1	1 unit
	Metal lever, high-grade steel roller	13	⊕ B	3SE5 000-0AF11	1	1 unit
	High-grade steel lever, plastic roller	13	⊕ A	3SE5 000-0AF12	1	1 unit
	High-grade steel lever, high-grade steel roller	13	⊕ B	3SE5 000-0AF13	1	1 unit
	Spring rods (for switches with snap-action contacts only)					
	Plastic plunger and high-grade steel spring:	7				
	• Length 142.5 mm (spring 50 mm, plunger 50 mm)		▶	3SE5 000-0AR01	1	1 unit
	• Length 76 mm (spring 23.5 mm, plunger 10 mm)		▶	3SE5 000-0AR03	1	1 unit
	• Length 242.5 mm (spring 150 mm, plunger 50 mm)		B	3SE5 000-0AR04	1	1 unit
	High-grade steel plunger and spring:	7				
• Length 142.5 mm (spring 50 mm, plunger 50 mm)		B	3SE5 000-0AR02	1	1 unit	
Twist actuators						
	Twist actuators, plastic (without lever)					
	Switching right and/or left, adjustable		⊕ ▶	3SE5 000-0AK00	1	1 unit
Levers for twist actuators						
	Twist levers 21 mm, straight, type A acc. to EN 50047					
	Metal lever, plastic roller	19	⊕ ▶	3SE5 000-0AA21	1	1 unit
	Metal lever, high-grade steel roller	19	⊕ B	3SE5 000-0AA22	1	1 unit
	Metal lever, roller with ball bearing	19	⊕ B	3SE5 000-0AA23	1	1 unit
	Metal lever, plastic roller	30	⊕ B	3SE5 000-0AA25	1	1 unit
	High-grade steel lever, plastic roller	19	⊕ B	3SE5 000-0AA31	1	1 unit
	High-grade steel lever, high-grade steel roller	19	⊕ B	3SE5 000-0AA32	1	1 unit
	Twist levers 30 mm, straight¹⁾					
	Metal lever, plastic roller	19	⊕ B	3SE5 000-0AA24	1	1 unit
	Twist levers, adjustable length, with grid hole					
	Metal lever, plastic roller	19	⊕ ▶	3SE5 000-0AA60	1	1 unit
	Metal lever, high-grade steel roller	19	⊕ ▶	3SE5 000-0AA61	1	1 unit
	Metal lever, plastic roller	50	⊕ B	3SE5 000-0AA67	1	1 unit
	Metal lever, rubber roller	50	⊕ B	3SE5 000-0AA68	1	1 unit
	High-grade steel lever, plastic roller	19	⊕ B	3SE5 000-0AA62	1	1 unit
	High-grade steel lever, high-grade steel roller	19	⊕ B	3SE5 000-0AA63	1	1 unit
	Twist levers, adjustable length					
	Metal lever, plastic roller	19	A	3SE5 000-0AA50	1	1 unit
	Metal lever, high-grade steel roller	19	B	3SE5 000-0AA51	1	1 unit
	Metal lever, plastic roller	30	B	3SE5 000-0AA55	1	1 unit
	Metal lever, plastic roller	50	B	3SE5 000-0AA57	1	1 unit
	Metal lever, rubber roller	50	B	3SE5 000-0AA58	1	1 unit
	High-grade steel lever, plastic roller	19	B	3SE5 000-0AA52	1	1 unit
	High-grade steel lever, high-grade steel roller	19	B	3SE5 000-0AA53	1	1 unit
Rod actuators						
Aluminum rod, length 200 mm	6	▶	3SE5 000-0AA80	1	1 unit	
Spring rod, length 200 mm	6	B	3SE5 000-0AA81	1	1 unit	
Plastic rod, length 200 mm	6	▶	3SE5 000-0AA82	1	1 unit	

⊕ Positively driven actuator, necessary in safety circuits.

¹⁾ Can be clinch mounted (turned through 180°, rear of lever).

SIRIUS 3SE5 International Limit Switches

3SE5, plastic enclosures – Enclosure width 40 mm acc. to EN 50041

Selection and ordering data

Complete units

2 or 3 contacts · Degree of protection IP66/67 · Cable entry M20 x 1.5

Version	Contacts	LEDs	DT	Complete units	<input type="checkbox"/>	PU (UNIT, SET, M)	PS*
				Configurator			
				Order No.		Price per PU	

Complete units¹⁾ · Enclosure width 40 mm

	Plain plungers						
	With high-grade steel plunger						
	Slow-action contacts	1 NO + 1 NC	—	⊕ B	3SE5 132-0BB01	1	1 unit
	Snap-action contacts	1 NO + 1 NC	—	⊕ B	3SE5 132-0CB01	1	1 unit
	Slow-action contacts	1 NO + 2 NC	—	⊕ B	3SE5 132-0KB01	1	1 unit
	Snap-action contacts	1 NO + 2 NC	—	⊕ B	3SE5 132-0LB01	1	1 unit
	Slow-action contacts	2 NO + 1 NC	—	⊕ B	3SE5 132-0PB01	1	1 unit
	Rounded plungers, type B acc. to EN 50041						
	With plastic plunger						
	Slow-action contacts	1 NO + 1 NC	—	⊕ A	3SE5 132-0BC03	1	1 unit
	Snap-action contacts	1 NO + 1 NC	—	⊕ A	3SE5 132-0CC03	1	1 unit
	Slow-action contacts	1 NO + 2 NC	—	⊕ B	3SE5 132-0KC03	1	1 unit
	Snap-action contacts	1 NO + 2 NC	—	⊕ B	3SE5 132-0LC03	1	1 unit
	Slow-action contacts	2 NO + 1 NC	—	⊕ B	3SE5 132-0PC03	1	1 unit
	Roller plungers, type C acc. to EN 50041						
	With plastic roller 13 mm						
	Slow-action contacts	1 NO + 1 NC	—	⊕ B	3SE5 132-0BD05	1	1 unit
	Snap-action contacts	1 NO + 1 NC	—	⊕ A	3SE5 132-0CD05	1	1 unit
	Slow-action contacts	1 NO + 2 NC	—	⊕ B	3SE5 132-0KD05	1	1 unit
	Snap-action contacts	1 NO + 2 NC	—	⊕ B	3SE5 132-0LD05	1	1 unit
	Slow-action contacts	2 NO + 1 NC	—	⊕ B	3SE5 132-0PD05	1	1 unit
	Roller levers						
	With metal lever and plastic roller 22 mm						
	Slow-action contacts	1 NO + 1 NC	—	⊕ B	3SE5 132-0BE05	1	1 unit
	Snap-action contacts	1 NO + 1 NC	—	⊕ A	3SE5 132-0CE05	1	1 unit
	Slow-action contacts	1 NO + 2 NC	—	⊕ B	3SE5 132-0KE05	1	1 unit
	Snap-action contacts	1 NO + 2 NC	—	⊕ B	3SE5 132-0LE05	1	1 unit
	Slow-action contacts	2 NO + 1 NC	—	⊕ B	3SE5 132-0PE05	1	1 unit
	Angular roller levers						
	With metal lever and plastic roller 22 mm						
	Slow-action contacts	1 NO + 1 NC	—	⊕ B	3SE5 132-0BF05	1	1 unit
	Snap-action contacts	1 NO + 1 NC	—	⊕ B	3SE5 132-0CF05	1	1 unit
	Snap-action contacts	1 NO + 2 NC	—	⊕ B	3SE5 132-0LF05	1	1 unit
	Spring rods						
	Length 142.5 mm, with plastic plunger 50 mm						
	Snap-action contacts	1 NO + 1 NC	—	B	3SE5 132-0CR01	1	1 unit
	Snap-action contacts	1 NO + 2 NC	—	B	3SE5 132-0LR01	1	1 unit

For online configurator see www.siemens.com/sirius/configurators.

⊕ Positive opening according to IEC 60947-5-1, Appendix K.

¹⁾ Popular versions.

SIRIUS 3SE5 International Limit Switches

3SE5, plastic enclosures – Enclosure width 40 mm acc. to EN 50041

2 or 3 contacts · Degree of protection IP66/IP67 · Cable entry M20 × 1.5

Version	Contacts	LEDs	DT	Complete units	<input type="checkbox"/>	PU (UNIT, SET, M)	PS*
				Configurator			
				Order No.		Price per PU	

Complete units¹⁾ · Enclosure width 40 mm



Twist lever

Twist levers, type A acc. to EN 50041

With metal lever 27 mm and plastic roller 19 mm

Slow-action contacts	1 NO + 1 NC	—		A	3SE5 132-0BJ01	1	1 unit
Snap-action contacts	1 NO + 1 NC	—		▶	3SE5 132-0CJ01	1	1 unit
Slow-action contacts	1 NO + 2 NC	—		B	3SE5 132-0KJ01	1	1 unit
Snap-action contacts	1 NO + 2 NC	—		B	3SE5 132-0LJ01	1	1 unit
Slow-action contacts	2 NO + 1 NC	—		B	3SE5 132-0PJ01	1	1 unit

Twist levers, adjustable length

With metal lever with grid hole and plastic roller 19 mm

Snap-action contacts	1 NO + 1 NC	—		B	3SE5 132-0CJ60	1	1 unit
Snap-action contacts	1 NO + 2 NC	—		B	3SE5 132-0LJ60	1	1 unit



Twist lever, adjustable length, with grid hole

With metal lever and plastic roller 19 mm

Snap-action contacts	1 NO + 1 NC	—		A	3SE5 132-0CJ50	1	1 unit
Snap-action contacts	1 NO + 2 NC	—		B	3SE5 132-0LJ50	1	1 unit



Twist lever, adjustable length

Rod actuators, type D, acc. to EN 50041

With aluminum rod, length 200 mm

Snap-action contacts	1 NO + 1 NC	—		B	3SE5 132-0CJ80	1	1 unit
----------------------	-------------	---	--	---	-----------------------	---	--------

With plastic rod, length 200 mm

Snap-action contacts	1 NO + 1 NC	—		A	3SE5 132-0CJ82	1	1 unit
----------------------	-------------	---	--	---	-----------------------	---	--------



Rod actuator

For online configurator see www.siemens.com/sirius/configurators.

Positive opening according to IEC 60947-5-1, Appendix K.

¹⁾ Popular versions.

Note:

If the device you require is not available as a complete unit, see "Modular System", page 13/17.

SIRIUS 3SE5 International Limit Switches

3SE5, plastic enclosures – Enclosure width 40 mm acc. to EN 50041

Modular system

2 or 3 contacts · Degree of protection IP66/IP67 · Cable entry M20 × 1.5

Version	Contacts	LEDs	DT	Modular system	PU (UNIT, SET, M)	PS*
				Order No.	Price per PU	

Basic switches · Enclosure width 40 mm

Image	Description	Contacts	LEDs	DT	Order No.	Price per PU	PU (UNIT, SET, M)	PS*
	With M20 × 1.5 connecting thread							
	Slow-action contacts	1 NO + 1 NC	—	⊕ B	3SE5 132-0BA00		1	1 unit
	Snap-action contacts	1 NO + 1 NC	—	⊕ A	3SE5 132-0CA00		1	1 unit
	• Gold-plated contacts			⊕ B	3SE5 132-0CA00-1AC1		1	1 unit
	Slow-action contacts	1 NO + 2 NC	—	⊕ B	3SE5 132-0KA00		1	1 unit
	Snap-action contacts	1 NO + 2 NC	—	⊕ B	3SE5 132-0LA00		1	1 unit
	Slow-action contacts with make-before-break	1 NO + 2 NC	—	⊕ B	3SE5 132-0MA00		1	1 unit
Slow-action contacts	2 NO + 1 NC	—	⊕ B	3SE5 132-0PA00		1	1 unit	
	With increased corrosion protection¹⁾							
	Slow-action contacts	1 NO + 1 NC	—	⊕ B	3SE5 132-0BA00-1CA0		1	1 unit
	Snap-action contacts	1 NO + 1 NC	—	⊕ B	3SE5 132-0CA00-1CA0		1	1 unit
	Slow-action contacts	1 NO + 2 NC	—	⊕ B	3SE5 132-0KA00-1CA0		1	1 unit
	Snap-action contacts	1 NO + 2 NC	—	⊕ B	3SE5 132-0LA00-1CA0		1	1 unit
	Slow-action contacts with make-before-break	1 NO + 2 NC	—	⊕ B	3SE5 132-0MA00-1CA0		1	1 unit
	Slow-action contacts	2 NO + 1 NC	—	⊕ B	3SE5 132-0PA00-1CA0		1	1 unit
	With M12 connector socket, 4-pole (250 V, 4 A)							
	Slow-action contacts	1 NO + 1 NC	—	⊕ B	3SE5 134-0BA00-1AC4		1	1 unit
	Snap-action contacts	1 NO + 1 NC	—	⊕ B	3SE5 134-0CA00-1AC4		1	1 unit
	Slow-action contacts	2 NC	—	⊕ B	3SE5 134-0KA00-1AE0		1	1 unit
	Snap-action contacts	2 NC	—	⊕ B	3SE5 134-0LA00-1AE0		1	1 unit
	With 2 LEDs, yellow/green							
	Slow-action contacts	1 NO + 2 NC	24 V DC	⊕ C	3SE5 132-1KA00		1	1 unit
	Snap-action contacts	1 NO + 2 NC	24 V DC	⊕ C	3SE5 132-1LA00		1	1 unit
	Slow-action contacts	1 NO + 2 NC	230 V AC	⊕ C	3SE5 132-3KA00		1	1 unit
	Snap-action contacts	1 NO + 2 NC	230 V AC	⊕ C	3SE5 132-3LA00		1	1 unit

For online configurator see www.siemens.com/sirius/configurators.

Positive opening according to IEC 60947-5-1, Appendix K, or positively driven actuator, necessary in safety circuits.













¹⁾ Use corresponding high-grade steel lever.

Note:

Selection aid [see page 13/9](#).

SIRIUS 3SE5 International Limit Switches

3SE5, plastic enclosures – Enclosure width 40 mm acc. to EN 50041

Version	Diameter	DT	Modular system	Price per PU	PU (UNIT, SET, M)	PS*
	mm		Order No.			
Operating mechanisms						
	Plain plungers High-grade steel plungers	10	⊕ A	3SE5 000-0AB01	1	1 unit
Plain plunger						
	Rounded plungers, type B acc. to EN 50041 Plastic plungers	10	⊕ B	3SE5 000-0AC03	1	1 unit
Plunger						
	Roller plungers, type C acc. to EN 50041 Plastic plunger, plastic roller Plastic plunger, high-grade steel roller	13 13	⊕ B ⊕ B	3SE5 000-0AD05 3SE5 000-0AD06	1 1	1 unit 1 unit
Roller lever						
	Roller levers Metal lever with plastic roller, plastic base	22	⊕ B	3SE5 000-0AE05	1	1 unit
Angular roller lever						
	Angular roller levers Metal lever with plastic roller, plastic base	22	⊕ B	3SE5 000-0AF05	1	1 unit
Spring rod						
	Spring rods (for switches with snap-action contacts only) Plastic plunger and high-grade steel spring: • Length 142.5 mm (spring 50 mm, plunger 50 mm) • Length 76 mm (spring 23.5 mm, plunger 10 mm) • Length 242.5 mm (spring 150 mm, plunger 50 mm) High-grade steel plunger and spring: • Length 142.5 mm (spring 50 mm, plunger 50 mm)	7 7	B B B B	3SE5 000-0AR01 3SE5 000-0AR03 3SE5 000-0AR04 3SE5 000-0AR02	1 1 1 1	1 unit 1 unit 1 unit 1 unit
Twist actuators						
	Twist actuators , plastic (without lever) • For twist levers and rod actuators, switching right and/or left, adjustable		⊕ B	3SE5 000-0AJ00	1	1 unit
Twist actuator						
	Levers for twist actuators Twist levers, offset, type A acc. to EN 50041 Metal lever 27 mm, plastic roller Metal lever 27 mm, high-grade steel roller Metal lever 27 mm, roller with ball bearing Metal lever 27 mm, 2 plastic rollers Metal lever 27 mm, plastic roller Metal lever 27 mm, rubber roller High-grade steel lever 27 mm, plastic roller High-grade steel lever 27 mm, high-grade steel roller Metal lever 35 mm, plastic roller	19 19 19 19 30 50 19 19 19	⊕ ▶ ⊕ ▶ ⊕ B ⊕ ▶ ⊕ B ⊕ ▶ ⊕ B ⊕ ▶ ⊕ B	3SE5 000-0AA01 3SE5 000-0AA02 3SE5 000-0AA03 3SE5 000-0AA04 3SE5 000-0AA05 3SE5 000-0AA08 3SE5 000-0AA11 3SE5 000-0AA12 3SE5 000-0AA15	1 1 1 1 1 1 1 1 1	1 unit 1 unit 1 unit 1 unit 1 unit 1 unit 1 unit 1 unit 1 unit
Twist lever						
	Twist levers 30 mm, straight¹⁾ Metal lever, plastic roller Metal lever, plastic roller	19 30	⊕ B ⊕ B	3SE5 000-0AA24 3SE5 000-0AA26	1 1	1 unit 1 unit
Twist lever, adjustable length						
	Twist levers, adjustable length, with grid hole Metal lever, plastic roller Metal lever, high-grade steel roller Metal lever, rubber roller High-grade steel lever, plastic roller High-grade steel lever, high-grade steel roller	19 19 50 19 19	⊕ B ⊕ B ⊕ B ⊕ B ⊕ B	3SE5 000-0AA60 3SE5 000-0AA61 3SE5 000-0AA68 3SE5 000-0AA62 3SE5 000-0AA63	1 1 1 1 1	1 unit 1 unit 1 unit 1 unit 1 unit
Twist lever, adjustable length						
	Twist levers, adjustable length Metal lever, plastic roller Metal lever, high-grade steel roller Metal lever, plastic roller Metal lever, rubber roller High-grade steel lever, plastic roller High-grade steel lever, high-grade steel roller	19 19 30 50 19 19	A B B B B B	3SE5 000-0AA50 3SE5 000-0AA51 3SE5 000-0AA55 3SE5 000-0AA58 3SE5 000-0AA52 3SE5 000-0AA53	1 1 1 1 1 1	1 unit 1 unit 1 unit 1 unit 1 unit 1 unit
Rod actuator						
	Rod actuators, type D acc. to EN 50041 Aluminum rod, length 200 mm Spring rod, length 200 mm Plastic rod, length 200 mm	6 6 6	B B B	3SE5 000-0AA80 3SE5 000-0AA81 3SE5 000-0AA82	1 1 1	1 unit 1 unit 1 unit

⊕ Positively driven actuator, necessary in safety circuits.

¹⁾ Can be clinch mounted (turned through 180°, rear of lever).

SIRIUS 3SE5 International Limit Switches

3SE5, plastic enclosures – Enclosure width 50 mm





Selection and ordering data

Complete units

2 or 3 contacts · Degree of protection IP66/IP67 · Cable entry 2 × (M20 × 1.5)

Version	Contacts	LEDs	DT	Complete units	<input type="checkbox"/>	PU (UNIT, SET, M)	PS*
				Configurator			
				Order No.		Price per PU	

Complete units¹⁾ · Enclosure width 50 mm

 Rounded plunger	Rounded plungers						
	With teflon plunger						
	Slow-action contacts	1 NO + 1 NC	—	⊙ ▶	3SE5 242-0BC05		1 1 unit
	Snap-action contacts	1 NO + 1 NC	—	⊙ B	3SE5 242-0CC05		1 1 unit
	Snap-action contacts, integrated ²⁾	1 NO + 1 NC	—	⊙ ▶	3SE5 242-0HC05		1 1 unit
	Snap-action contacts • Short stroke, integrated ²⁾	1 NO + 1 NC	—	⊙ B	3SE5 242-0FC05		1 1 unit
	Snap-action contacts • 2 × 2 mm contact gap	1 NO + 1 NC	—	⊙ B	3SE5 242-0GC05		1 1 unit
	Slow-action contacts	1 NO + 2 NC	—	⊙ B	3SE5 242-0KC05		1 1 unit
	Snap-action contacts	1 NO + 2 NC	—	⊙ B	3SE5 242-0LC05		1 1 unit
	Slow-action contacts with make-before-break	1 NO + 2 NC	—	⊙ A	3SE5 242-0MC05		1 1 unit
Slow-action contacts	2 NO + 1 NC	—	⊙ A	3SE5 242-0PC05		1 1 unit	
 With increased corrosion protection	With increased corrosion protection						
	Slow-action contacts	1 NO + 1 NC	—	⊙ B	3SE5 242-0BC05-1CA0		1 1 unit
	Snap-action contacts, integrated ²⁾	1 NO + 1 NC	—	⊙ B	3SE5 242-0HC05-1CA0		1 1 unit
	Slow-action contacts	1 NO + 2 NC	—	⊙ B	3SE5 242-0KC05-1CA0		1 1 unit
	Snap-action contacts	1 NO + 2 NC	—	⊙ B	3SE5 242-0LC05-1CA0		1 1 unit
	Slow-action contacts with make-before-break	1 NO + 2 NC	—	⊙ B	3SE5 242-0MC05-1CA0		1 1 unit
Slow-action contacts	2 NO + 1 NC	—	⊙ B	3SE5 242-0PC05-1CA0		1 1 unit	
 With 2 LEDs	With 2 LEDs, yellow/green						
	Slow-action contacts	1 NO + 2 NC	24 V DC	⊙ B	3SE5 242-1KC05		1 1 unit
	Snap-action contacts	1 NO + 2 NC	24 V DC	⊙ B	3SE5 242-1LC05		1 1 unit
	Slow-action contacts	1 NO + 2 NC	230 V AC	⊙ B	3SE5 242-3KC05		1 1 unit
	Snap-action contacts	1 NO + 2 NC	230 V AC	⊙ B	3SE5 242-3LC05		1 1 unit
 Roller plunger	Roller plungers						
	With plastic roller 10 mm						
	Slow-action contacts	1 NO + 1 NC	—	⊙ ▶	3SE5 242-0BD03		1 1 unit
	Snap-action contacts, integrated ²⁾	1 NO + 1 NC	—	⊙ ▶	3SE5 242-0HD03		1 1 unit
Snap-action contacts	1 NO + 2 NC	—	⊙ ▶	3SE5 242-0LD03		1 1 unit	

For online configurator see www.siemens.com/sirius/configurators.

⊙ Positive opening according to IEC 60947-5-1, Appendix K.

¹⁾ Popular versions.

²⁾ Subsequent replacement of contact blocks is not possible.

SIRIUS 3SE5 International Limit Switches

3SE5, plastic enclosures – Enclosure width 50 mm

2 or 3 contacts · Degree of protection IP66/IP67 · Cable entry 2 × (M20 × 1.5)

Version	Contacts	LEDs	DT	Complete units	<input type="checkbox"/>	PU (UNIT, SET, M)	PS*
				Configurator			
				Order No.	Price per PU		

Complete units¹⁾ · Enclosure width 50 mm



Roller lever

Roller levers

With metal lever and plastic roller 13 mm

Slow-action contacts	1 NO + 1 NC	—		B	3SE5 242-0BE10	1	1 unit
Snap-action contacts, integrated ²⁾	1 NO + 1 NC	—		▶	3SE5 242-0HE10	1	1 unit
Snap-action contacts	1 NO + 2 NC	—		B	3SE5 242-0LE10	1	1 unit

With M12 connector socket, 4-pole right (250 V, 4 A)

Snap-action contacts	2 NC	—		B	3SE5 244-0LE10-1AE0	1	1 unit
----------------------	------	---	--	---	----------------------------	---	--------

Twist levers

With metal lever 21 mm and plastic roller 19 mm

Slow-action contacts	1 NO + 1 NC	—		B	3SE5 242-0BK21	1	1 unit
Snap-action contacts, integrated ²⁾	1 NO + 1 NC	—		▶	3SE5 242-0HK21	1	1 unit
Snap-action contacts	1 NO + 2 NC	—		B	3SE5 242-0LK21	1	1 unit



Twist lever

Twist levers, adjustable length

With metal lever and plastic roller 19 mm

Snap-action contacts, integrated ²⁾	1 NO + 1 NC	—		B	3SE5 242-0HK50	1	1 unit
--	-------------	---	--	---	-----------------------	---	--------

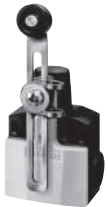

Twist lever, adjustable length

For online configurator see www.siemens.com/sirius/configurators.

Positive opening according to IEC 60947-5-1, Appendix K.

¹⁾ Popular versions.

²⁾ Subsequent replacement of contact blocks is not possible.

Note:

If the device you require is not available as a complete unit, see "Modular System", page 13/21.

SIRIUS 3SE5 International Limit Switches

3SE5, plastic enclosures – Enclosure width 50 mm

Modular system

2 or 3 contacts · Degree of protection IP66/IP67 · Cable entry 2 × (M20 × 1.5)

Version	Contacts	LEDs	DT	Modular system	PU (UNIT, SET, M)	PS*
				Order No.	Price per PU	

Basic switches · Enclosure width 50 mm (with rounded plunger¹⁾)

	With teflon plunger					
	Slow-action contacts	1 NO + 1 NC	—	⊕ ▶	3SE5 242-0BC05	1 1 unit
	Snap-action contacts	1 NO + 1 NC	—	⊕ B	3SE5 242-0CC05	1 1 unit
	Snap-action contacts, integrated ²⁾	1 NO + 1 NC	—	⊕ ▶	3SE5 242-0HC05	1 1 unit
	Snap-action contacts • Short stroke, integrated ²⁾	1 NO + 1 NC	—	⊕ B	3SE5 242-0FC05	1 1 unit
	Snap-action contacts • 2 × 2 mm contact gap	1 NO + 1 NC	—	⊕ B	3SE5 242-0GC05	1 1 unit
	Slow-action contacts	1 NO + 2 NC	—	⊕ B	3SE5 242-0KC05	1 1 unit
	Snap-action contacts	1 NO + 2 NC	—	⊕ B	3SE5 242-0LC05	1 1 unit
	Slow-action contacts with make-before-break	1 NO + 2 NC	—	⊕ A	3SE5 242-0MC05	1 1 unit
	Slow-action contacts	2 NO + 1 NC	—	⊕ A	3SE5 242-0PC05	1 1 unit
	With increased corrosion protection³⁾					
	Slow-action contacts	1 NO + 1 NC	—	⊕ B	3SE5 242-0BC05-1CA0	1 1 unit
	Snap-action contacts, integrated ²⁾	1 NO + 1 NC	—	⊕ B	3SE5 242-0HC05-1CA0	1 1 unit
	Slow-action contacts	1 NO + 2 NC	—	⊕ B	3SE5 242-0KC05-1CA0	1 1 unit
	Snap-action contacts	1 NO + 2 NC	—	⊕ B	3SE5 242-0LC05-1CA0	1 1 unit
	Slow-action contacts with make-before-break	1 NO + 2 NC	—	⊕ B	3SE5 242-0MC05-1CA0	1 1 unit
	With 2 LEDs, yellow/green					
	Slow-action contacts	1 NO + 2 NC	24 V DC	⊕ B	3SE5 242-1KC05	1 1 unit
	Snap-action contacts	1 NO + 2 NC	24 V DC	⊕ B	3SE5 242-1LC05	1 1 unit
	Slow-action contacts	1 NO + 2 NC	230 V AC	⊕ B	3SE5 242-3KC05	1 1 unit
	Snap-action contacts	1 NO + 2 NC	230 V AC	⊕ B	3SE5 242-3LC05	1 1 unit

⚙ For online configurator see www.siemens.com/sirius/configurators.

⊕ Positively opening according to IEC 60947-5-1, Appendix K, or positively driven actuator, necessary in safety circuits.

¹⁾ For enclosures with widths of 50 mm, the basic switch is a complete unit with rounded plungers.

²⁾ Subsequent replacement of contact blocks is not possible.

³⁾ Use corresponding high-grade steel lever.

Note:
Selection aid see page 13/9.

Version	Diameter	DT	Modular system	PU (UNIT, SET, M)	PS*
	mm				
			Order No.	Price per PU	

Operating mechanisms

	Roller plungers, type C acc. to EN 50047					
	Plastic rollers	10	—	⊕ A	3SE5 000-0AD03	1 1 unit
	High-grade steel rollers	10	—	⊕ B	3SE5 000-0AD04	1 1 unit
	Roller plungers with central fixing					
	Plastic rollers	10	—	⊕ B	3SE5 000-0AD10	1 1 unit
	High-grade steel rollers	10	—	⊕ B	3SE5 000-0AD11	1 1 unit



⊕ Positively driven actuator, necessary in safety circuits.

SIRIUS 3SE5 International Limit Switches





3SE5, plastic enclosures – Enclosure width 50 mm

Version	Diameter	DT	Modular system	PU (UNIT, SET, M)	PS*
	mm		Order No.	Price per PU	

Operating mechanisms

	Roller levers, type E acc. to EN 50047				
	Metal lever, plastic roller	13	⊕ A	3SE5 000-0AE10	1 1 unit
	Metal lever, high-grade steel roller	13	⊕ B	3SE5 000-0AE11	1 1 unit
	High-grade steel lever, plastic roller	13	⊕ B	3SE5 000-0AE12	1 1 unit
	Angular roller levers				
	Metal lever, plastic roller	13	⊕ A	3SE5 000-0AF10	1 1 unit
	Metal lever, high-grade steel roller	13	⊕ B	3SE5 000-0AF11	1 1 unit
	High-grade steel lever, plastic roller	13	⊕ A	3SE5 000-0AF12	1 1 unit
	Spring rods (for switches with snap-action contacts only)				
	Plastic plunger and high-grade steel spring:	7			
	• Length 142.5 mm (spring 50 mm, plunger 50 mm)		B	3SE5 000-0AR01	1 1 unit
	• Length 76 mm (spring 23.5 mm, plunger 10 mm)		B	3SE5 000-0AR03	1 1 unit
	• Length 242.5 mm (spring 150 mm, plunger 50 mm)		B	3SE5 000-0AR04	1 1 unit
High-grade steel plunger and spring:	7				
• Length 142.5 mm (spring 50 mm, plunger 50 mm)		B	3SE5 000-0AR02	1 1 unit	

Twist actuators

	Twist actuators, plastic (without lever)				
	Switching right and/or left, adjustable		⊕ A	3SE5 000-0AK00	1 1 unit
	Levers for twist actuators				
	Twist levers 21 mm, straight, type A acc. to EN 50047				
	Metal lever, plastic roller	19	⊕ A	3SE5 000-0AA21	1 1 unit
	Metal lever, high-grade steel roller	19	⊕ B	3SE5 000-0AA22	1 1 unit
	Metal lever, roller with ball bearing	19	⊕ B	3SE5 000-0AA23	1 1 unit
	Metal lever, plastic roller	30	⊕ B	3SE5 000-0AA25	1 1 unit
	Twist levers 30 mm, straight¹⁾				
	High-grade steel lever, plastic roller	19	⊕ B	3SE5 000-0AA31	1 1 unit
	High-grade steel lever, high-grade steel roller	19	⊕ B	3SE5 000-0AA32	1 1 unit
	Metal lever, plastic roller	19	⊕ B	3SE5 000-0AA24	1 1 unit
	Metal lever, plastic roller	30	⊕ B	3SE5 000-0AA26	1 1 unit
	Twist levers, adjustable length, with grid hole				
	Metal lever, plastic roller	19	⊕ B	3SE5 000-0AA60	1 1 unit
	Metal lever, high-grade steel roller	19	⊕ B	3SE5 000-0AA61	1 1 unit
	Metal lever, plastic roller	50	⊕ B	3SE5 000-0AA67	1 1 unit
	Metal lever, rubber roller	50	⊕ B	3SE5 000-0AA68	1 1 unit
	High-grade steel lever, plastic roller	19	⊕ B	3SE5 000-0AA62	1 1 unit
	High-grade steel lever, high-grade steel roller	19	⊕ B	3SE5 000-0AA63	1 1 unit
Twist levers, adjustable length					
	Metal lever, plastic roller	19	A	3SE5 000-0AA50	1 1 unit
	Metal lever, high-grade steel roller	19	B	3SE5 000-0AA51	1 1 unit
	Metal lever, plastic roller	30	B	3SE5 000-0AA55	1 1 unit
	Metal lever, plastic roller	50	B	3SE5 000-0AA57	1 1 unit
	Metal lever, rubber roller	50	B	3SE5 000-0AA58	1 1 unit
	High-grade steel lever, plastic roller	19	B	3SE5 000-0AA52	1 1 unit
	High-grade steel lever, high-grade steel roller	19	B	3SE5 000-0AA53	1 1 unit
	Rod actuators				
Aluminum rod, length 200 mm	6	B	3SE5 000-0AA80	1 1 unit	
Spring rod, length 200 mm	6	B	3SE5 000-0AA81	1 1 unit	
Plastic rod, length 200 mm	6	B	3SE5 000-0AA82	1 1 unit	

⊕ Positively driven actuator, necessary in safety circuits.

¹⁾ Can be clinch mounted (turned through 180°, rear of lever).

SIRIUS 3SE5 International Limit Switches

3SE5, plastic enclosures – Ambient temperature to –40 °C

Selection and ordering data

Complete units

2 or 3 contacts · Degree of protection IP65 or IP66/IP67 · Cable entry M20 × 1.5

Version	Contacts	LEDs	DT	Complete units	<input type="checkbox"/>	PU (UNIT, SET, M)	PS*	PG
				Configurator				
				Order No.	Price per PU			

Complete units¹⁾ · Enclosure width 31 mm



Roller plunger with central fixing

Roller plungers with central fixing								
Snap-action contacts	1 NO + 1 NC	—	⊕ B	3SE5 232-0CD10-1AJ0	1	1 unit	41K	



Twist lever

Twist levers, type A acc. to EN 50047								
With high-grade steel lever 21 mm and plastic roller 19 mm								
Snap-action contacts	1 NO + 1 NC	—	⊕ A	3SE5 232-0CK31-1AJ0	1	1 unit	41K	



Twist lever, adjustable length

Twist levers, adjustable length								
With high-grade steel lever with grid hole and plastic roller 19 mm								
Snap-action contacts	1 NO + 1 NC	—	⊕ A	3SE5 232-0CK62-1AJ0	1	1 unit	41K	
Snap-action contacts	1 NO + 2 NC	—	⊕ B	3SE5 232-0LK62-1AJ0	1	1 unit	41K	

Complete units¹⁾ · Enclosure width 50 mm



Twist lever, adjustable length

Twist levers								
With metal lever 21 mm and plastic roller 19 mm								
Snap-action contacts, integrated ²⁾	1 NO + 1 NC	—	⊕ B	3SE5 242-0HK21-1AJ0	1	1 unit	41K	
Twist levers, adjustable length								
With high-grade steel lever with grid hole and plastic roller 19 mm								
Snap-action contacts, integrated ²⁾	1 NO + 1 NC	—	⊕ B	3SE5 242-0HK62-1AJ0	1	1 unit	41K	

For online configurator see www.siemens.com/sirius/configurators.

⊕ Positive opening according to IEC 60947-5-1, Appendix K, or positively driven actuator, necessary in safety circuits.

¹⁾ Popular versions.

²⁾ Subsequent replacement of contact blocks is not possible.

Note:

If the device you require is not available as a complete unit, see “Modular System”, see page 13/24.

SIRIUS 3SE5 International Limit Switches

3SE5, plastic enclosures – Ambient temperature to –40 °C

Modular system

2 or 3 contacts · Degree of protection IP65 or IP66/IP67 · Cable entry M20 × 1.5

Version	Contacts	LEDs	DT	Modular system		PU (UNIT, SET, M)	PS*
				Configurator			
				Order No.	Price per PU		

Basic switches · Enclosure width 31 mm (with rounded plunger¹⁾)



With teflon plunger

Snap-action contacts	1 NO + 1 NC —		B	3SE5 232-0CC05-1AJ0	1	1 unit
Slow-action contacts	1 NO + 2 NC —		B	3SE5 232-0KC05-1AJ0	1	1 unit
Snap-action contacts	1 NO + 2 NC —		B	3SE5 232-0LC05-1AJ0	1	1 unit

Basic switch

Basic switches · Enclosure width 50 mm (with rounded plunger¹⁾)



With teflon plunger

Slow-action contacts	1 NO + 1 NC —		B	3SE5 242-0BC05-1AJ0	1	1 unit
Snap-action contacts, integrated ²⁾	1 NO + 1 NC —		B	3SE5 242-0HC05-1AJ0	1	1 unit

Basic switch

For online configurator see www.siemens.com/sirius/configurators.

Positive opening according to IEC 60947-5-1, Appendix K, or positively driven actuator, necessary in safety circuits.

¹⁾ For enclosures with widths of 31 and 50 mm, the basic switch is a complete unit with rounded plungers.







²⁾ Subsequent replacement of contact blocks is not possible.

Note:

Selection aid [see page 13/9](#).

SIRIUS 3SE5 International Limit Switches

3SE5, plastic enclosures – Ambient temperature to –40 °C

Version	Diameter	DT	Modular system	PU (UNIT, SET, M)	PS*
	mm		Order No. Price per PU		
Operating mechanisms					
 Roller plunger	Roller plungers, type C acc. to EN 50047				
	Plastic rollers	10	⊕ B	3SE5 000-0AD03-1AJ0	1 1 unit
 Roller lever	Roller levers, type E acc. to EN 50047				
	Metal lever, plastic roller	13	⊕ B	3SE5 000-0AE10-1AJ0	1 1 unit
	High-grade steel lever, plastic roller	13	⊕ B	3SE5 000-0AE12-1AJ0	1 1 unit
 Angular roller lever	Angular roller levers				
	Metal lever, plastic roller	13	⊕ B	3SE5 000-0AF10-1AJ0	1 1 unit
	High-grade steel lever, plastic roller	13	⊕ B	3SE5 000-0AF12-1AJ0	1 1 unit
Twist actuators					
 Twist actuator	Twist actuators, plastic (without lever)				
	Switching right and/or left, adjustable		⊕ B	3SE5 000-0AK00-1AJ0	1 1 unit
Levers for twist actuators					
 Twist lever	Twist levers straight, 21 mm, type A acc. to EN 50047				
	Metal lever, plastic roller	19	⊕ B	3SE5 000-0AA21-1AJ0	1 1 unit
	High-grade steel lever, plastic roller	19	⊕ B	3SE5 000-0AA31-1AJ0	1 1 unit
 Twist lever, adjustable length	Twist levers, adjustable length, with grid hole				
	Metal lever, plastic roller	19	⊕ B	3SE5 000-0AA60-1AJ0	1 1 unit
	High-grade steel lever, plastic roller	19	⊕ B	3SE5 000-0AA62-1AJ0	1 1 unit

⊕ Positively driven actuator, necessary in safety circuits.

SIRIUS 3SE5 International Limit Switches

3SE5, plastic enclosures – Ambient temperature to –40 °C

Modular system

2 or 3 contacts · Degree of protection IP66/IP67 · Cable entry M20 × 1.5

Version	Contacts	LEDs	DT	Modular system	PU (UNIT, SET, M)	PS*
				Order No.	Price per PU	

Basic switches · Enclosure width 40 mm



With M20 □ 1.5 connecting thread

Snap-action contacts	1 NO + 1 NC	—		B	3SE5 132-0CA00-1AJ0	1	1 unit
Slow-action contacts	1 NO + 2 NC	—		B	3SE5 132-0KA00-1AJ0	1	1 unit
Snap-action contacts	1 NO + 2 NC	—		B	3SE5 132-0LA00-1AJ0	1	1 unit

Basic switch

For online configurator see www.siemens.com/sirius/configurators.

Positive opening according to IEC 60947-5-1, Appendix K, or positively driven actuator, necessary in safety circuits.

Note:

Selection aid [see page 13/9](#).

Version	Diameter	DT	Modular system	PU (UNIT, SET, M)	PS*
	mm				
			Order No.	Price per PU	

Operating mechanisms



Rounded plunger

Rounded plungers, type B acc. to EN 50041

Plastic plunger	10		B	3SE5 000-0AC03-1AJ0	1	1 unit
-----------------	----	--	---	----------------------------	---	--------



Roller plunger

Roller plungers, type C acc. to EN 50041

Plastic plunger, plastic roller	13		B	3SE5 000-0AD05-1AJ0	1	1 unit
---------------------------------	----	--	---	----------------------------	---	--------



Roller lever

Roller levers

Metal lever with plastic roller, plastic base	22		B	3SE5 000-0AE05-1AJ0	1	1 unit
---	----	--	---	----------------------------	---	--------

Twist actuators



Twist actuator

Twist actuators, plastic (without lever)

<ul style="list-style-type: none"> For twist levers and rod actuators, switching right and/or left, adjustable 			B	3SE5 000-0AJ00-1AJ0	1	1 unit
---	--	--	---	----------------------------	---	--------



Twist levers

Levers for twist actuators

Twist lever, type A acc. to EN 50041

Metal lever, plastic roller	19		B	3SE5 000-0AA01-1AJ0	1	1 unit
High-grade steel lever, plastic roller	19		B	3SE5 000-0AA11-1AJ0	1	1 unit



Twist lever, adjustable length

Twist levers, adjustable length, with grid hole

Metal lever, plastic roller	19		B	3SE5 000-0AA60-1AJ0	1	1 unit
High-grade steel lever, plastic roller	19		B	3SE5 000-0AA62-1AJ0	1	1 unit

Positively driven actuator, necessary in safety circuits.

SIRIUS 3SE5 International Limit Switches

3SE5, metal enclosures – Enclosure width 31 mm acc. to EN 50047





Selection and ordering data

Complete units

2 or 3 contacts · Degree of protection IP66/IP67 · Cable entry M20 × 1.5

Version	Contacts	LEDs	DT	Complete units	<input type="checkbox"/>	PU (UNIT, SET, M)	PS*
				Configurator			
				Order No.		Price per PU	

Complete units¹⁾ · Enclosure width 31 mm

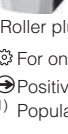
Rounded plungers, type B, acc. to EN 50047							
	With plunger						
	Slow-action contacts	1 NO + 1 NC	—	⊕ A	3SE5 212-0BC05	1	1 unit
	Snap-action contacts	1 NO + 1 NC	—	⊕ A	3SE5 212-0CC05	1	1 unit
	Slow-action contacts	1 NO + 2 NC	—	⊕ A	3SE5 212-0KC05	1	1 unit
	Snap-action contacts	1 NO + 2 NC	—	⊕ A	3SE5 212-0LC05	1	1 unit
	Slow-action contacts with make-before-break	1 NO + 2 NC	—	⊕ A	3SE5 212-0MC05	1	1 unit
Slow-action contacts	2 NO + 1 NC	—	⊕ A	3SE5 212-0PC05	1	1 unit	
	With increased corrosion protection						
	Slow-action contacts	1 NO + 1 NC	—	⊕ B	3SE5 212-0BC05-1CA0	1	1 unit
	Snap-action contacts	1 NO + 1 NC	—	⊕ B	3SE5 212-0CC05-1CA0	1	1 unit
	Slow-action contacts	1 NO + 2 NC	—	⊕ B	3SE5 212-0KC05-1CA0	1	1 unit
	Snap-action contacts	1 NO + 2 NC	—	⊕ B	3SE5 212-0LC05-1CA0	1	1 unit
	Slow-action contacts with make-before-break	1 NO + 2 NC	—	⊕ B	3SE5 212-0MC05-1CA0	1	1 unit
Slow-action contacts	2 NO + 1 NC	—	⊕ B	3SE5 212-0PC05-1CA0	1	1 unit	
	With M12 connector socket, 5-pole (125 V, 4 A)						
	Slow-action contacts	1 NO + 1 NC	—	⊕ B	3SE5 214-0BC05-1AC5	1	1 unit
	Snap-action contacts	1 NO + 1 NC	—	⊕ B	3SE5 214-0CC05-1AC5	1	1 unit
	Slow-action contacts	2 NC	—	⊕ B	3SE5 214-0KC05-1AE1	1	1 unit
	Snap-action contacts	2 NC	—	⊕ B	3SE5 214-0LC05-1AE1	1	1 unit
	With 2 LEDs, yellow/green						
Slow-action contacts	1 NO + 2 NC	24 V DC	⊕ B	3SE5 212-1KC05	1	1 unit	
Snap-action contacts	1 NO + 2 NC	24 V DC	⊕ A	3SE5 212-1LC05	1	1 unit	
Slow-action contacts	1 NO + 2 NC	230 V AC	⊕ B	3SE5 212-3KC05	1	1 unit	
Snap-action contacts	1 NO + 2 NC	230 V AC	⊕ B	3SE5 212-3LC05	1	1 unit	
	With M12 connector socket, 5-pole (125 V, 4 A) and 2 LEDs						
	Slow-action contacts	1 NO + 1 NC	24 V DC	⊕ B	3SE5 214-1BC05-1AF3	1	1 unit
	Snap-action contacts	1 NO + 1 NC	24 V DC	⊕ B	3SE5 214-1CC05-1AF3	1	1 unit
Plain plungers							
	With high-grade steel plunger						
	Slow-action contacts	1 NO + 1 NC	—	⊕ B	3SE5 212-0BB01	1	1 unit
	Snap-action contacts	1 NO + 1 NC	—	⊕ B	3SE5 212-0CB01	1	1 unit
	Slow-action contacts	1 NO + 2 NC	—	⊕ B	3SE5 212-0KB01	1	1 unit
Snap-action contacts	1 NO + 2 NC	—	⊕ B	3SE5 212-0LB01	1	1 unit	
Roller plungers, type C acc. to EN 50047							
	With plastic roller 10 mm						
	Slow-action contacts	1 NO + 1 NC	—	⊕ A	3SE5 212-0BD03	1	1 unit
	Snap-action contacts	1 NO + 1 NC	—	⊕ B	3SE5 212-0CD03	1	1 unit
	Slow-action contacts	1 NO + 2 NC	—	⊕ A	3SE5 212-0KD03	1	1 unit
Snap-action contacts	1 NO + 2 NC	—	⊕ B	3SE5 212-0LD03	1	1 unit	

For online configurator see www.siemens.com/sirius/configurators.

⊕ Positive opening according to IEC 60947-5-1, Appendix K.

¹⁾ Popular versions.

SIRIUS 3SE5 International Limit Switches

3SE5, metal enclosures – Enclosure width 31 mm acc. to EN 50047

2 or 3 contacts · Degree of protection IP66/IP67 · Cable entry M20 × 1.5

Version	Contacts	LEDs	DT	Complete units	<input type="checkbox"/>	PU (UNIT, SET, M)	PS*
				Configurator			
				Order No.	Price per PU		

Complete units¹⁾ · Enclosure width 31 mm

Roller levers, type E acc. to EN 50047



Roller lever

With metal lever and plastic roller 13 mm

Slow-action contacts	1 NO + 1 NC	—	⊕ A	3SE5 212-0BE10		1	1 unit
Snap-action contacts	1 NO + 1 NC	—	⊕ B	3SE5 212-0CE10		1	1 unit
Slow-action contacts	1 NO + 2 NC	—	⊕ B	3SE5 212-0KE10		1	1 unit
Snap-action contacts	1 NO + 2 NC	—	⊕ B	3SE5 212-0LE10		1	1 unit

Angular roller levers



Angular roller lever

With metal lever and plastic roller 13 mm

Slow-action contacts	1 NO + 1 NC	—	⊕ B	3SE5 212-0BF10		1	1 unit
Snap-action contacts	1 NO + 1 NC	—	⊕ B	3SE5 212-0CF10		1	1 unit
Slow-action contacts	1 NO + 2 NC	—	⊕ B	3SE5 212-0KF10		1	1 unit
Snap-action contacts	1 NO + 2 NC	—	⊕ B	3SE5 212-0LF10		1	1 unit

Twist levers, type A acc. to EN 50047



Twist lever

With metal lever 21 mm and plastic roller 19 mm

Slow-action contacts	1 NO + 1 NC	—	⊕ A	3SE5 212-0BK21		1	1 unit
Snap-action contacts	1 NO + 1 NC	—	⊕ A	3SE5 212-0CK21		1	1 unit
Slow-action contacts	1 NO + 2 NC	—	⊕ B	3SE5 212-0KK21		1	1 unit
Snap-action contacts	1 NO + 2 NC	—	⊕ B	3SE5 212-0LK21		1	1 unit

Twist levers, adjustable length



Twist lever, adjustable length

With metal lever with grid hole and plastic roller 19 mm

Snap-action contacts	1 NO + 1 NC	—	⊕ A	3SE5 212-0CK60		1	1 unit
Slow-action contacts	1 NO + 2 NC	—	⊕ B	3SE5 212-0KK60		1	1 unit
Snap-action contacts	1 NO + 2 NC	—	⊕ B	3SE5 212-0LK60		1	1 unit

With metal lever and plastic roller 19 mm

Slow-action contacts	1 NO + 1 NC	—	A	3SE5 212-0BK50		1	1 unit
Snap-action contacts	1 NO + 1 NC	—	B	3SE5 212-0CK50		1	1 unit
Snap-action contacts	1 NO + 2 NC	—	B	3SE5 212-0LK50		1	1 unit

For online configurator see www.siemens.com/sirius/configurators.

Positive opening according to IEC 60947-5-1, Appendix K.

¹⁾ Popular versions.

Note:

If the device you require is not available as a complete unit, see "Modular System", see page 13/29.

SIRIUS 3SE5 International Limit Switches





3SE5, metal enclosures – Enclosure width 31 mm acc. to EN 50047

Modular system

2 or 3 contacts · Degree of protection IP66/IP67 · Cable entry M20 × 1.5

Version	Contacts	LEDs	DT	Modular system	☒	PU (UNIT, SET, M)	PS*
				Configurator	⚙️		
				Order No.	Price per PU		

Basic switches · Enclosure width 31 mm (with rounded plunger¹⁾)

	With plunger						
	Slow-action contacts	1 NO + 1 NC	—	⊕ A	3SE5 212-0BC05	1	1 unit
	Snap-action contacts	1 NO + 1 NC	—	⊕ A	3SE5 212-0CC05	1	1 unit
	Slow-action contacts	1 NO + 2 NC	—	⊕ A	3SE5 212-0KC05	1	1 unit
	Snap-action contacts	1 NO + 2 NC	—	⊕ A	3SE5 212-0LC05	1	1 unit
	Slow-action contacts with make-before-break	1 NO + 2 NC	—	⊕ A	3SE5 212-0MC05	1	1 unit
	Slow-action contacts	2 NO + 1 NC	—	⊕ A	3SE5 212-0PC05	1	1 unit
	With increased corrosion protection²⁾						
	Slow-action contacts	1 NO + 1 NC	—	⊕ B	3SE5 212-0BC05-1CA0	1	1 unit
	Snap-action contacts	1 NO + 1 NC	—	⊕ B	3SE5 212-0CC05-1CA0	1	1 unit
	Slow-action contacts	1 NO + 2 NC	—	⊕ B	3SE5 212-0KC05-1CA0	1	1 unit
	Snap-action contacts	1 NO + 2 NC	—	⊕ B	3SE5 212-0LC05-1CA0	1	1 unit
	Slow-action contacts with make-before-break	1 NO + 2 NC	—	⊕ B	3SE5 212-0MC05-1CA0	1	1 unit
	Slow-action contacts	2 NO + 1 NC	—	⊕ B	3SE5 212-0PC05-1CA0	1	1 unit
	With M12 connector socket, 5-pole (125 V, 4 A)						
	Slow-action contacts	1 NO + 1 NC	—	⊕ B	3SE5 214-0BC05-1AC5	1	1 unit
	Snap-action contacts	1 NO + 1 NC	—	⊕ B	3SE5 214-0CC05-1AC5	1	1 unit
	Slow-action contacts	2 NC	—	⊕ B	3SE5 214-0KC05-1AE1	1	1 unit
	Snap-action contacts	2 NC	—	⊕ B	3SE5 214-0LC05-1AE1	1	1 unit
	With 2 LEDs, yellow/green						
	Slow-action contacts	1 NO + 2 NC	24 V DC	⊕ B	3SE5 212-1KC05	1	1 unit
	Snap-action contacts	1 NO + 2 NC	24 V DC	⊕ A	3SE5 212-1LC05	1	1 unit
	Slow-action contacts	1 NO + 2 NC	230 V AC	⊕ B	3SE5 212-3KC05	1	1 unit
	Snap-action contacts	1 NO + 2 NC	230 V AC	⊕ B	3SE5 212-3LC05	1	1 unit
	With M12 connector socket, 5-pole (125 V, 4 A) and 2 LEDs						
	Slow-action contacts	1 NO + 1 NC	24 V DC	⊕ B	3SE5 214-1BC05-1AF3	1	1 unit
	Snap-action contacts	1 NO + 1 NC	24 V DC	⊕ B	3SE5 214-1CC05-1AF3	1	1 unit

⚙️ For online configurator see www.siemens.com/sirius/configurators.

⊕ Positive opening according to IEC 60947-5-1, Appendix K, or positively driven actuator, necessary in safety circuits.

¹⁾ For enclosures with widths of 31mm, the basic switch is a complete unit with rounded plungers.



²⁾ Use corresponding high-grade steel lever.

Note:

Selection aid [see page 13/9](#).

Version	Diameter	DT	Modular system	☒	PU (UNIT, SET, M)	PS*
	mm		Order No.	Price per PU		











Operating mechanisms

	Plain plungers					
	High-grade steel plungers	10	⊕ A	3SE5 000-0AB01	1	1 unit
	Roller plungers, type C acc. to EN 50047					
	Plastic rollers	10	⊕ A	3SE5 000-0AD03	1	1 unit
	High-grade steel rollers	10	⊕ B	3SE5 000-0AD04	1	1 unit

⊕ Positively driven actuator, necessary in safety circuits.

SIRIUS 3SE5 International Limit Switches

3SE5, metal enclosures – Enclosure width 31 mm acc. to EN 50047

Version	Diameter	DT	Modular system	Price per PU	PU (UNIT, SET, M)	PS*
	mm		Order No.			
Operating mechanisms						
	Roller plungers with central fixing					
	Plastic rollers	10	⊕ B	3SE5 000-0AD10		1 1 unit
	High-grade steel rollers	10	⊕ B	3SE5 000-0AD11		1 1 unit
With central fixing						
	Roller levers, type E acc. to EN 50047					
	Metal lever, plastic roller	13	⊕ A	3SE5 000-0AE10		1 1 unit
	Metal lever, high-grade steel roller	13	⊕ B	3SE5 000-0AE11		1 1 unit
	High-grade steel lever, plastic roller	13	⊕ B	3SE5 000-0AE12		1 1 unit
	High-grade steel lever, high-grade steel roller	13	⊕ B	3SE5 000-0AE13		1 1 unit
Angular roller levers						
	Metal lever, plastic roller	13	⊕ A	3SE5 000-0AF10		1 1 unit
	Metal lever, high-grade steel roller	13	⊕ B	3SE5 000-0AF11		1 1 unit
	High-grade steel lever, plastic roller	13	⊕ A	3SE5 000-0AF12		1 1 unit
	High-grade steel lever, high-grade steel roller	13	⊕ B	3SE5 000-0AF13		1 1 unit
Spring rods (for switches with snap-action contacts only)						
	Plastic plunger and high-grade steel spring:					
		7				
	• Length 142.5 mm (spring 50 mm, plunger 50 mm)		B	3SE5 000-0AR01		1 1 unit
	• Length 76 mm (spring 23.5 mm, plunger 10 mm)		B	3SE5 000-0AR03		1 1 unit
	• Length 242.5 mm (spring 150 mm, plunger 50 mm)		B	3SE5 000-0AR04		1 1 unit
High-grade steel plunger and spring:		7				
			B	3SE5 000-0AR02		1 1 unit
Twist actuators						
	Twist actuators, plastic (without lever)					
	Switching right and/or left, adjustable		⊕ A	3SE5 000-0AK00		1 1 unit
Levers for twist actuators						
	Twist levers, straight, type A acc. to EN 50047					
	Metal lever 21 mm, plastic roller	19	⊕ A	3SE5 000-0AA21		1 1 unit
	Metal lever 21 mm, high-grade steel roller	19	⊕ B	3SE5 000-0AA22		1 1 unit
	Metal lever 21 mm, roller with ball bearing	19	⊕ B	3SE5 000-0AA23		1 1 unit
	Metal lever 21 mm, plastic roller	30	⊕ B	3SE5 000-0AA25		1 1 unit
	High-grade steel lever 21 mm, plastic roller	19	⊕ B	3SE5 000-0AA31		1 1 unit
	High-grade steel lever 21 mm, high-grade steel roller	19	⊕ B	3SE5 000-0AA32		1 1 unit
Twist levers 30 mm, straight¹⁾						
	Metal lever, plastic roller	19	⊕ B	3SE5 000-0AA24		1 1 unit
	Metal lever, plastic roller	30	⊕ B	3SE5 000-0AA26		1 1 unit
Twist levers, adjustable length, with grid hole						
	Metal lever, plastic roller	19	⊕ B	3SE5 000-0AA60		1 1 unit
	Metal lever, high-grade steel roller	19	⊕ B	3SE5 000-0AA61		1 1 unit
	Metal lever, plastic roller	50	⊕ B	3SE5 000-0AA67		1 1 unit
	Metal lever, rubber roller	50	⊕ B	3SE5 000-0AA68		1 1 unit
	High-grade steel lever, plastic roller	19	⊕ B	3SE5 000-0AA62		1 1 unit
	High-grade steel lever, high-grade steel roller	19	⊕ B	3SE5 000-0AA63		1 1 unit
	Twist levers, adjustable length					
	Metal lever, plastic roller	19	A	3SE5 000-0AA50		1 1 unit
	Metal lever, high-grade steel roller	19	B	3SE5 000-0AA51		1 1 unit
	Metal lever, plastic roller	30	B	3SE5 000-0AA55		1 1 unit
	Metal lever, plastic roller	50	B	3SE5 000-0AA57		1 1 unit
	Metal lever, rubber roller	50	B	3SE5 000-0AA58		1 1 unit
	High-grade steel lever, plastic roller	19	B	3SE5 000-0AA52		1 1 unit
	High-grade steel lever, high-grade steel roller	19	B	3SE5 000-0AA53		1 1 unit
Rod actuators, type D acc. to EN 50041						
	Aluminum rod, length 200 mm	6	B	3SE5 000-0AA80		1 1 unit
	Spring rod, length 200 mm	6	B	3SE5 000-0AA81		1 1 unit
	Plastic rod, length 200 mm	6	B	3SE5 000-0AA82		1 1 unit
	Plastic rod, length 330 mm	6	B	3SE5 000-0AA83		1 1 unit

⊕ Positively driven actuator, necessary in safety circuits.

¹⁾ Can be clinch mounted (turned through 180°, rear of lever).

SIRIUS 3SE5 International Limit Switches

3SE5, metal enclosures – Enclosure width 40 mm acc. to EN 50041



Selection and ordering data

Complete units

2 or 3 contacts · Degree of protection IP66/IP67 · Cable entry M20 × 1.5

Version	Contacts	LEDs	DT	Complete units	<input type="checkbox"/>	PU (UNIT, SET, M)	PS*
				Configurator			
				Order No.		Price per PU	

Complete units¹⁾ · Enclosure width 40 mm

	Plain plungers						
	With high-grade steel plunger						
	Slow-action contacts	1 NO + 1 NC —	⊕ A	3SE5 112-0BB01		1	1 unit
	Snap-action contacts	1 NO + 1 NC —	⊕ A	3SE5 112-0CB01		1	1 unit
	Slow-action contacts	1 NO + 2 NC —	⊕ ▶	3SE5 112-0KB01		1	1 unit
	Snap-action contacts	1 NO + 2 NC —	⊕ B	3SE5 112-0LB01		1	1 unit
	Rounded plungers, type B acc. to EN 50041						
	With high-grade steel plungers, with 3 mm overtravel						
	Slow-action contacts	1 NO + 1 NC —	⊕ ▶	3SE5 112-0BC02		1	1 unit
	Snap-action contacts	1 NO + 1 NC —	⊕ ▶	3SE5 112-0CC02		1	1 unit
	Slow-action contacts	1 NO + 2 NC —	⊕ B	3SE5 112-0KC02		1	1 unit
	Snap-action contacts	1 NO + 2 NC —	⊕ B	3SE5 112-0LC02		1	1 unit
	Roller plungers, type C acc. to EN 50041						
	With high-grade steel roller 13 mm, with 3 mm overtravel						
	Slow-action contacts	1 NO + 1 NC —	⊕ ▶	3SE5 112-0BD02		1	1 unit
	Snap-action contacts	1 NO + 1 NC —	⊕ ▶	3SE5 112-0CD02		1	1 unit
	Slow-action contacts	1 NO + 2 NC —	⊕ ▶	3SE5 112-0KD02		1	1 unit
	Snap-action contacts	1 NO + 2 NC —	⊕ ▶	3SE5 112-0LD02		1	1 unit
	With M12 connector socket, 5-pole (125 V, 4 A) and 2 LEDs						
	Snap-action contacts	1 NO + 1 NC 24 V DC	⊕ B	3SE5 114-1CD02-1AF3		1	1 unit
	Roller levers						
	With metal lever and plastic roller 22 mm						
	Slow-action contacts	1 NO + 1 NC —	⊕ ▶	3SE5 112-0BE01		1	1 unit
	Snap-action contacts	1 NO + 1 NC —	⊕ ▶	3SE5 112-0CE01		1	1 unit
	Slow-action contacts	1 NO + 2 NC —	⊕ B	3SE5 112-0KE01		1	1 unit
	Snap-action contacts	1 NO + 2 NC —	⊕ B	3SE5 112-0LE01		1	1 unit
	Angular roller levers						
	With metal lever and plastic roller 22 mm						
	Slow-action contacts	1 NO + 1 NC —	⊕ B	3SE5 112-0BF01		1	1 unit
	Snap-action contacts	1 NO + 1 NC —	⊕ ▶	3SE5 112-0CF01		1	1 unit
	Snap-action contacts	1 NO + 2 NC —	⊕ B	3SE5 112-0LF01		1	1 unit
	Spring rods						
	Length 142.5 mm, with plastic plunger 50 mm						
	Snap-action contacts	1 NO + 1 NC —	▶	3SE5 112-0CR01		1	1 unit

For online configurator see www.siemens.com/sirius/configurators.

Positive opening according to IEC 60947-5-1, Appendix K.

¹⁾ Popular versions.

SIRIUS 3SE5 International Limit Switches

3SE5, metal enclosures – Enclosure width 40 mm acc. to EN 50041

2 or 3 contacts · Degree of protection IP66/IP67 · Cable entry M20 × 1.5

Version	Contacts	LEDs	DT	Complete units	<input type="checkbox"/>	PU (UNIT, SET, M)	PS*
				Configurator			
				Order No.	Price per PU		

Complete units¹⁾ · Enclosure width 40 mm

Twist levers, type A acc. to EN 50041

With metal lever 27 mm and plastic roller 19 mm

Slow-action contacts	1 NO + 1 NC	—	⊕ ▶	3SE5 112-0BH01		1	1 unit
Snap-action contacts	1 NO + 1 NC	—	⊕ ▶	3SE5 112-0CH01		1	1 unit
Slow-action contacts	1 NO + 2 NC	—	⊕ ▶	3SE5 112-0KH01		1	1 unit
Snap-action contacts	1 NO + 2 NC	—	⊕ B	3SE5 112-0LH01		1	1 unit

With M12 connector socket, 5-pole (125 V, 4 A)

Snap-action contacts	1 NO + 1 NC	—	⊕ A	3SE5 114-0CH01-1AC5		1	1 unit
----------------------	-------------	---	-----	----------------------------	--	---	--------

With M12 connector socket, 5-pole (125 V, 4 A) and 2 LEDs

Snap-action contacts	1 NO + 1 NC	24 V DC	⊕ B	3SE5 114-1CH01-1AF3		1	1 unit
----------------------	-------------	---------	-----	----------------------------	--	---	--------

With metal lever 27 mm and high-grade steel roller 19 mm

Slow-action contacts	1 NO + 1 NC	—	⊕ B	3SE5 112-0BH02		1	1 unit
Snap-action contacts	1 NO + 1 NC	—	⊕ ▶	3SE5 112-0CH02		1	1 unit

With M12 connector socket, 5-pole (125 V, 4 A) and 2 LEDs

Snap-action contacts	1 NO + 1 NC	—	⊕ B	3SE5 114-1CH02-1AF3		1	1 unit
----------------------	-------------	---	-----	----------------------------	--	---	--------

With metal lever 30 mm and plastic roller 19 mm

Snap-action contacts	1 NO + 1 NC	—	⊕ A	3SE5 112-0CH24		1	1 unit
----------------------	-------------	---	-----	-----------------------	--	---	--------

Twist levers, adjustable length

With metal lever with grid hole and plastic roller 19 mm

Slow-action contacts	1 NO + 1 NC	—	⊕ ▶	3SE5 112-0BH60		1	1 unit
Snap-action contacts	1 NO + 1 NC	—	⊕ ▶	3SE5 112-0CH60		1	1 unit
Snap-action contacts	1 NO + 2 NC	—	⊕ B	3SE5 112-0LH60		1	1 unit

With metal lever and plastic roller 19 mm

Slow-action contacts	1 NO + 1 NC	—	B	3SE5 112-0BH50		1	1 unit
Snap-action contacts	1 NO + 1 NC	—	▶	3SE5 112-0CH50		1	1 unit
Snap-action contacts	1 NO + 2 NC	—	B	3SE5 112-0LH50		1	1 unit

With M12 connector socket, 8-pole (30 V, 2 A) and 2 LEDs

Snap-action contacts	1 NO + 2 NC	24 V DC	B	3SE5 114-1LH50-1AD4		1	1 unit
----------------------	-------------	---------	---	----------------------------	--	---	--------

With metal lever and high-grade steel roller 19 mm

Snap-action contacts	1 NO + 1 NC	—	B	3SE5 112-0CH51		1	1 unit
----------------------	-------------	---	---	-----------------------	--	---	--------

Fork levers, latching

With metal lever and 2 plastic rollers 19 mm

Snap-action contacts	1 NO + 1 NC	—	⊕ B	3SE5 112-0CT11		1	1 unit
----------------------	-------------	---	-----	-----------------------	--	---	--------

Rod actuators, type D, acc. to EN 50041

With aluminum rod, length 200 mm

Snap-action contacts	1 NO + 1 NC	—	▶	3SE5 112-0CH80		1	1 unit
----------------------	-------------	---	---	-----------------------	--	---	--------

With plastic rod, length 200 mm

Snap-action contacts	1 NO + 1 NC	—	B	3SE5 112-0CH82		1	1 unit
----------------------	-------------	---	---	-----------------------	--	---	--------



Twist lever



Twist lever, adjustable length, with grid hole



Twist lever, adjustable length



Fork lever



Rod actuator

For online configurator see www.siemens.com/sirius/configurators.

Positive opening according to IEC 60947-5-1, Appendix K.

¹⁾ Popular versions.

Note:

If the device you require is not available as a complete unit, see "Modular System", page 13/33.

SIRIUS 3SE5 International Limit Switches

3SE5, metal enclosures – Enclosure width 40 mm acc. to EN 50041

Modular system

2 or 3 contacts · Degree of protection IP66/IP67 · Cable entry M20 × 1.5

Version	Contacts	LEDs	DT	Modular system	PU (UNIT, SET, M)	PS*
				Order No.	Price per PU	
Basic switches · Enclosure width 40 mm						
With M20 × 1.5 connecting thread						
	Slow-action contacts	1 NO + 1 NC	—	⊕ ▶	3SE5 112-0BA00	1 1 unit
	Snap-action contacts	1 NO + 1 NC	—	⊕ ▶	3SE5 112-0CA00	1 1 unit
	• Gold-plated contacts			⊕ B	3SE5 112-0CA00-1AC1	1 1 unit
	Slow-action contacts	1 NO + 2 NC	—	⊕ A	3SE5 112-0KA00	1 1 unit
	Snap-action contacts	1 NO + 2 NC	—	⊕ ▶	3SE5 112-0LA00	1 1 unit
	Slow-action contacts with make-before-break	1 NO + 2 NC	—	⊕ ▶	3SE5 112-0MA00	1 1 unit
	Slow-action contacts	2 NO + 1 NC	—	⊕ ▶	3SE5 112-0PA00	1 1 unit
	With increased corrosion protection¹⁾					
	Slow-action contacts	1 NO + 1 NC	—	⊕ B	3SE5 112-0BA00-1CA0	1 1 unit
	Snap-action contacts	1 NO + 1 NC	—	⊕ B	3SE5 112-0CA00-1CA0	1 1 unit
	Slow-action contacts	1 NO + 2 NC	—	⊕ B	3SE5 112-0KA00-1CA0	1 1 unit
	Snap-action contacts	1 NO + 2 NC	—	⊕ B	3SE5 112-0LA00-1CA0	1 1 unit
	Slow-action contacts with make-before-break	1 NO + 2 NC	—	⊕ B	3SE5 112-0MA00-1CA0	1 1 unit
	Slow-action contacts	2 NO + 1 NC	—	⊕ B	3SE5 112-0PA00-1CA0	1 1 unit
	With M12 connector socket, 5-pole (125 V, 4 A)					
	Slow-action contacts	1 NO + 1 NC	—	⊕ B	3SE5 114-0BA00-1AC5	1 1 unit
	Snap-action contacts	1 NO + 1 NC	—	⊕ ▶	3SE5 114-0CA00-1AC5	1 1 unit
	Slow-action contacts	2 NC	—	⊕ B	3SE5 114-0KA00-1AE1	1 1 unit
	Snap-action contacts	2 NC	—	⊕ B	3SE5 114-0LA00-1AE1	1 1 unit
	With connector socket, 6-pole + PE (250 V, 10 A)					
	Slow-action contacts	1 NO + 2 NC	—	⊕ B	3SE5 115-0KA00-1AD1	1 1 unit
	Snap-action contacts	1 NO + 2 NC	—	⊕ ▶	3SE5 115-0LA00-1AD1	1 1 unit
	With connector socket, 6-pole + PE (250 V, 10 A) and quick-release device					
	Snap-action contacts	1 NO + 1 NC	—	⊕ B	3SE5 115-0CA00-1AD0	1 1 unit
	With 2 LEDs, yellow/green					
	Slow-action contacts	1 NO + 2 NC	24 V DC	⊕ B	3SE5 112-1KA00	1 1 unit
	Snap-action contacts	1 NO + 2 NC	24 V DC	⊕ ▶	3SE5 112-1LA00	1 1 unit
	Slow-action contacts	1 NO + 2 NC	230 V AC	⊕ B	3SE5 112-3KA00	1 1 unit
	Snap-action contacts	1 NO + 2 NC	230 V AC	⊕ B	3SE5 112-3LA00	1 1 unit
	With M12 connector socket, 5-pole (125 V, 4 A) and 2 LEDs					
	Slow-action contacts	1 NO + 1 NC	24 V DC	⊕ B	3SE5 114-1BA00-1AF3	1 1 unit
	Snap-action contacts	1 NO + 1 NC	24 V DC	⊕ B	3SE5 114-1CA00-1AF3	1 1 unit
	With M12 connector socket, 8-pole (30 V, 2 A) and 2 LEDs					
	Snap-action contacts	1 NO + 2 NC	24 V DC	⊕ B	3SE5 114-1LA00-1AD4	1 1 unit
	With connector socket, 6-pole + PE (10 A), and 2 LEDs					
	Slow-action contacts	1 NO + 1 NC	24 V DC	⊕ B	3SE5 115-1BA00-1AF2	1 1 unit
	Snap-action contacts	1 NO + 1 NC	24 V DC	⊕ B	3SE5 115-1CA00-1AF2	1 1 unit
	Snap-action contacts	2 NC	24 V DC	⊕ B	3SE5 115-1LA00-1AD2	1 1 unit

For online configurator see www.siemens.com/sirius/configurators.

⊕ Positive opening according to IEC 60947-5-1, Appendix K, or positively driven actuator, necessary in safety circuits.









¹⁾ Use corresponding high-grade steel lever.

Note:

Selection aid, see page 13/9.

SIRIUS 3SE5 International Limit Switches

3SE5, metal enclosures – Enclosure width 40 mm acc. to EN 50041

Version	Diameter	DT	Modular system	Price per PU	PU (UNIT, SET, M)	PS*	
	mm		Order No.				
Operating mechanisms							
	Plain plungers						
	High-grade steel plungers	10	⊕ A	3SE5 000-0AB01	1	1 unit	
	Rounded plungers, type B acc. to EN 50041						
	High-grade steel plungers, with 3 mm overtravel	10	⊕ ▶	3SE5 000-0AC02	1	1 unit	
	Roller plungers, type C acc. to EN 50041						
	High-grade steel roller, with 3 mm overtravel	13	⊕ ▶	3SE5 000-0AD02	1	1 unit	
	Roller levers						
	Metal lever, plastic roller	22	⊕ ▶	3SE5 000-0AE01	1	1 unit	
	Metal lever, high-grade steel roller	22	⊕ ▶	3SE5 000-0AE02	1	1 unit	
	High-grade steel lever, plastic roller	22	⊕ B	3SE5 000-0AE03	1	1 unit	
	Angular roller levers						
	Metal lever, plastic roller	22	⊕ ▶	3SE5 000-0AF01	1	1 unit	
	Metal lever, high-grade steel roller	22	⊕ B	3SE5 000-0AF02	1	1 unit	
	High-grade steel lever, plastic roller	22	⊕ B	3SE5 000-0AF03	1	1 unit	
	High-grade steel roller, high-grade steel roller						
		22	⊕ B	3SE5 000-0AE04	1	1 unit	
	Spring rods (for switches with snap-action contacts only)						
	Plastic plunger and high-grade steel spring:	7					
	• Length 142.5 mm (spring 50 mm, plunger 50 mm)		B	3SE5 000-0AR01	1	1 unit	
	• Length 76 mm (spring 23.5 mm, plunger 10 mm)		B	3SE5 000-0AR03	1	1 unit	
	• Length 242.5 mm (spring 150 mm, plunger 50 mm)		B	3SE5 000-0AR04	1	1 unit	
	High-grade steel plunger and spring:		7				
	• Length 142.5 mm (spring 50 mm, plunger 50 mm)		B	3SE5 000-0AR02	1	1 unit	
	Twist actuators						
		Twist actuators, metal (without lever)					
		• For twist levers and rod actuators, switching right and/or left, adjustable		⊕ A	3SE5 000-0AH00	1	1 unit
		• For fork levers, latching		⊕ ▶	3SE5 000-0AT10	1	1 unit
		Levers for twist actuators					
Twist levers, offset, type A acc. to EN 50041							
Metal lever 27 mm, plastic roller		19	⊕ A	3SE5 000-0AA01	1	1 unit	
Metal lever 27 mm, high-grade steel roller		19	⊕ A	3SE5 000-0AA02	1	1 unit	
Metal lever 27 mm, roller with ball bearing		19	⊕ B	3SE5 000-0AA03	1	1 unit	
Metal lever 27 mm, 2 plastic rollers		19	⊕ B	3SE5 000-0AA04	1	1 unit	
Metal lever 27 mm, plastic roller		30	⊕ B	3SE5 000-0AA05	1	1 unit	
Metal lever 27 mm, rubber roller		50	⊕ B	3SE5 000-0AA08	1	1 unit	
High-grade steel lever 27 mm, plastic roller		19	⊕ B	3SE5 000-0AA11	1	1 unit	
High-grade steel lever 27 mm, high-grade steel roller		19	⊕ B	3SE5 000-0AA12	1	1 unit	
Metal lever 35 mm, plastic roller		19	⊕ B	3SE5 000-0AA15	1	1 unit	
		Twist levers 30 mm, straight¹⁾					
		Metal lever, plastic roller	19	⊕ B	3SE5 000-0AA24	1	1 unit
		Twist levers, adjustable length, with grid hole					
	Metal lever, plastic roller	19	⊕ B	3SE5 000-0AA60	1	1 unit	
	Metal lever, high-grade steel roller	19	⊕ B	3SE5 000-0AA61	1	1 unit	
	Metal lever, rubber roller	50	⊕ B	3SE5 000-0AA68	1	1 unit	
	High-grade steel lever, plastic roller	19	⊕ B	3SE5 000-0AA62	1	1 unit	
	High-grade steel lever, high-grade steel roller	19	⊕ B	3SE5 000-0AA63	1	1 unit	
	Twist levers, adjustable length						
	Metal lever, plastic roller	19	A	3SE5 000-0AA50	1	1 unit	
	Metal lever, high-grade steel roller	19	B	3SE5 000-0AA51	1	1 unit	
	Metal lever, plastic roller	30	B	3SE5 000-0AA55	1	1 unit	
	Metal lever, rubber roller	50	B	3SE5 000-0AA58	1	1 unit	
	High-grade steel lever, plastic roller	19	B	3SE5 000-0AA52	1	1 unit	
	High-grade steel lever, high-grade steel roller	19	B	3SE5 000-0AA53	1	1 unit	
	Fork levers (for switches with snap-action contacts only)						
	2 metal levers, 2 plastic rollers	19	⊕ ▶	3SE5 000-0AT01	1	1 unit	
	2 metal levers, 2 high-grade steel rollers	19	⊕ B	3SE5 000-0AT02	1	1 unit	
	2 high-grade steel levers, 2 plastic rollers	19	⊕ B	3SE5 000-0AT03	1	1 unit	
Rod actuators, type D acc. to EN 50041							
Aluminum rod, length 200 mm	6	B	3SE5 000-0AA80	1	1 unit		
Spring rod, length 200 mm	6	B	3SE5 000-0AA81	1	1 unit		
Plastic rod, length 200 mm	6	B	3SE5 000-0AA82	1	1 unit		

⊕ Positively driven actuator, necessary in safety circuits.

¹⁾ Can be clinch mounted (turned through 180°, rear of lever).

SIRIUS 3SE5 International Limit Switches

3SE5, metal enclosures – Enclosure width 56 mm

Selection and ordering data

Complete units

2 or 3 contacts · Degree of protection IP66/IP67 · Cable entry 3 × (M20 × 1.5)

Version	Contacts	LEDs	DT	Complete units	<input type="checkbox"/>	PU (UNIT, SET, M)	PS*
				Configurator			
				Order No.		Price per PU	

Complete units¹⁾ · Enclosure width 56 mm



Plain plunger

Plain plungers

With high-grade steel plunger

Slow-action contacts	1 NO + 1 NC	—	⊕ B	3SE5 122-0BB01		1	1 unit
Snap-action contacts	1 NO + 1 NC	—	⊕ B	3SE5 122-0CB01		1	1 unit
Slow-action contacts	1 NO + 2 NC	—	⊕ B	3SE5 122-0KB01		1	1 unit
Snap-action contacts	1 NO + 2 NC	—	⊕ B	3SE5 122-0LB01		1	1 unit
Slow-action contacts	2 NO + 1 NC	—	⊕ B	3SE5 122-0PB01		1	1 unit



Rounded plunger

Rounded plungers

With high-grade steel plungers, with 3 mm overtravel

Slow-action contacts	1 NO + 1 NC	—	⊕ B	3SE5 122-0BC02		1	1 unit
Snap-action contacts	1 NO + 1 NC	—	⊕ ▶	3SE5 122-0CC02		1	1 unit
Slow-action contacts	1 NO + 2 NC	—	⊕ B	3SE5 122-0KC02		1	1 unit
Snap-action contacts	1 NO + 2 NC	—	⊕ B	3SE5 122-0LC02		1	1 unit
Slow-action contacts	2 NO + 1 NC	—	⊕ B	3SE5 122-0PC02		1	1 unit



Roller plunger

Roller plungers

With high-grade steel roller 13 mm, with 3 mm overtravel

Slow-action contacts	1 NO + 1 NC	—	⊕ ▶	3SE5 122-0BD02		1	1 unit
Snap-action contacts	1 NO + 1 NC	—	⊕ ▶	3SE5 122-0CD02		1	1 unit
Slow-action contacts	1 NO + 2 NC	—	⊕ ▶	3SE5 122-0KD02		1	1 unit
Snap-action contacts	1 NO + 2 NC	—	⊕ B	3SE5 122-0LD02		1	1 unit



Roller lever

Roller levers

With metal lever and plastic roller 22 mm

Slow-action contacts	1 NO + 1 NC	—	⊕ ▶	3SE5 122-0BE01		1	1 unit
Snap-action contacts	1 NO + 1 NC	—	⊕ ▶	3SE5 122-0CE01		1	1 unit
Slow-action contacts	1 NO + 2 NC	—	⊕ ▶	3SE5 122-0KE01		1	1 unit
Snap-action contacts	1 NO + 2 NC	—	⊕ B	3SE5 122-0LE01		1	1 unit
Slow-action contacts	2 NO + 1 NC	—	⊕ B	3SE5 122-0PE01		1	1 unit

With metal lever and high-grade steel roller 22 mm

Snap-action contacts	1 NO + 1 NC	—	⊕ B	3SE5 122-0CE02		1	1 unit
----------------------	-------------	---	-----	-----------------------	--	---	--------



Angular roller lever

Angular roller levers

With metal lever and plastic roller 22 mm

Slow-action contacts	1 NO + 1 NC	—	⊕ B	3SE5 122-0BF01		1	1 unit
Snap-action contacts	1 NO + 1 NC	—	⊕ ▶	3SE5 122-0CF01		1	1 unit
Slow-action contacts	2 NO + 1 NC	—	⊕ B	3SE5 122-0PF01		1	1 unit

For online configurator see www.siemens.com/sirius/configurators.

⊕ Positive opening according to IEC 60947-5-1, Appendix K.

¹⁾ Popular versions.

SIRIUS 3SE5 International Limit Switches

3SE5, metal enclosures – Enclosure width 56 mm

2 or 3 contacts · Degree of protection IP66/IP67 · Cable entry 3 × (M20 × 1.5)

Version	Contacts	LEDs	DT	Complete units	<input type="checkbox"/>	PU (UNIT, SET, M)	PS*
				Configurator			
				Order No.	Price per PU		

Complete units¹⁾ · Enclosure width 56 mm



Spring rod

Spring rods

Length 142.5 mm, with plastic plunger 50 mm

Snap-action contacts	1 NO + 1 NC	—	▶	3SE5 122-0CR01		1	1 unit
----------------------	-------------	---	---	-----------------------	--	---	--------



Twist lever

Twist levers

With metal lever 27 mm and plastic roller 19 mm

Slow-action contacts	1 NO + 1 NC	—	⊕ B	3SE5 122-0BH01		1	1 unit
Snap-action contacts	1 NO + 1 NC	—	⊕ A	3SE5 122-0CH01		1	1 unit
Slow-action contacts	1 NO + 2 NC	—	⊕ B	3SE5 122-0KH01		1	1 unit
Snap-action contacts	1 NO + 2 NC	—	⊕ B	3SE5 122-0LH01		1	1 unit
Slow-action contacts	2 NO + 1 NC	—	⊕ B	3SE5 122-0PH01		1	1 unit

With metal lever 27 mm and high-grade steel roller 19 mm

Snap-action contacts	1 NO + 1 NC	—	⊕ B	3SE5 122-0CH02		1	1 unit
Snap-action contacts	1 NO + 2 NC	—	⊕ B	3SE5 122-0LH02		1	1 unit



Twist lever, adjustable length

Twist levers, adjustable length

With metal lever with grid hole and plastic roller 19 mm

Slow-action contacts	1 NO + 1 NC	—	⊕ B	3SE5 122-0BH60		1	1 unit
Snap-action contacts	1 NO + 1 NC	—	⊕ B	3SE5 122-0CH60		1	1 unit
Snap-action contacts	1 NO + 2 NC	—	⊕ B	3SE5 122-0LH60		1	1 unit

With metal lever and plastic roller 19 mm

Slow-action contacts	1 NO + 1 NC	—	B	3SE5 122-0BH50		1	1 unit
Snap-action contacts	1 NO + 1 NC	—	▶	3SE5 122-0CH50		1	1 unit
Snap-action contacts	1 NO + 2 NC	—	B	3SE5 122-0LH50		1	1 unit



Fork lever

Fork levers, latching

With metal lever and 2 plastic rollers 19 mm

Snap-action contacts	1 NO + 1 NC	—	⊕ B	3SE5 122-0CT11		1	1 unit
----------------------	-------------	---	-----	-----------------------	--	---	--------



Rod actuator

Rod actuators

With aluminum rod, length 200 mm

Snap-action contacts	1 NO + 1 NC	—	B	3SE5 122-0CH80		1	1 unit
----------------------	-------------	---	---	-----------------------	--	---	--------

With plastic rod, length 200 mm

Snap-action contacts	1 NO + 1 NC	—	B	3SE5 122-0CH82		1	1 unit
----------------------	-------------	---	---	-----------------------	--	---	--------

For online configurator see www.siemens.com/sirius/configurators .

Positive opening according to IEC 60947-5-1, Appendix K.

¹⁾ Popular versions.

Note:

If the device you require is not available as a complete unit, see "Modular System", page 13/37.

SIRIUS 3SE5 International Limit Switches

3SE5, metal enclosures – Enclosure width 56 mm

Modular system

2 or 3 contacts · Degree of protection IP66/IP67 · Cable entry 3 × (M20 × 1.5)

Version	Contacts	LEDs	DT	Modular system	PU (UNIT, SET, M)	PS*
				Order No.	Price per PU	

Basic switches · Enclosure width 56 mm

Image	Description	Contacts	LEDs	DT	Part No.	PU (UNIT, SET, M)	PS*	
	With 3 x M20 x 1.5 connecting thread							
	Slow-action contacts	1 NO + 1 NC	—	⊕ ▶	3SE5 122-0BA00	1	1 unit	
	Snap-action contacts	1 NO + 1 NC	—	⊕ ▶	3SE5 122-0CA00	1	1 unit	
	Slow-action contacts	1 NO + 2 NC	—	⊕ B	3SE5 122-0KA00	1	1 unit	
	Snap-action contacts	1 NO + 2 NC	—	⊕ A	3SE5 122-0LA00	1	1 unit	
	Slow-action contacts with make-before-break	1 NO + 2 NC	—	⊕ A	3SE5 122-0MA00	1	1 unit	
	With increased corrosion protection¹⁾							
	Slow-action contacts	1 NO + 1 NC	—	⊕ B	3SE5 122-0BA00-1CA0	1	1 unit	
	Snap-action contacts	1 NO + 1 NC	—	⊕ B	3SE5 122-0CA00-1CA0	1	1 unit	
	Slow-action contacts	1 NO + 2 NC	—	⊕ B	3SE5 122-0KA00-1CA0	1	1 unit	
	Snap-action contacts	1 NO + 2 NC	—	⊕ B	3SE5 122-0LA00-1CA0	1	1 unit	
	Slow-action contacts with make-before-break	1 NO + 2 NC	—	⊕ B	3SE5 122-0MA00-1CA0	1	1 unit	
	With 2 LEDs, yellow/green							
	Slow-action contacts	1 NO + 2 NC	24 V DC	⊕ B	3SE5 122-1KA00	1	1 unit	
	Snap-action contacts	1 NO + 2 NC	24 V DC	⊕ B	3SE5 122-1LA00	1	1 unit	
	Slow-action contacts	1 NO + 2 NC	230 V AC	⊕ B	3SE5 122-3KA00	1	1 unit	
	Snap-action contacts	1 NO + 2 NC	230 V AC	⊕ B	3SE5 122-3LA00	1	1 unit	

For online configurator see www.siemens.com/sirius/configurators.

Positive opening according to IEC 60947-5-1, Appendix K, or positively driven actuator, necessary in safety circuits.

¹⁾ Use corresponding high-grade steel lever.

Note:

Selection aid see page 13/9.





Version	Diameter	DT	Modular system	PU (UNIT, SET, M)	PS*
	mm				
			Order No.	Price per PU	

Operating mechanisms

Image	Description	Diameter	DT	Part No.	PU (UNIT, SET, M)	PS*	
	Plain plungers						
	High-grade steel plungers	10	⊕ A	3SE5 000-0AB01	1	1 unit	
	Rounded plungers, type B acc. to EN 50041						
	High-grade steel plungers, with 3 mm overtravel	10	⊕ B	3SE5 000-0AC02	1	1 unit	
	Roller plungers, type C acc. to EN 50041						
	High-grade steel roller, with 3 mm overtravel	13	⊕ B	3SE5 000-0AD02	1	1 unit	
	Roller levers						
	Metal lever, plastic roller	22	⊕ A	3SE5 000-0AE01	1	1 unit	
	Metal lever, high-grade steel roller	22	⊕ B	3SE5 000-0AE02	1	1 unit	
	High-grade steel lever, plastic roller	22	⊕ B	3SE5 000-0AE03	1	1 unit	
	High-grade steel lever, high-grade steel roller	22	⊕ B	3SE5 000-0AE04	1	1 unit	
	Angular roller levers						
	Metal lever, plastic roller	22	⊕ A	3SE5 000-0AF01	1	1 unit	
	Metal lever, high-grade steel roller	22	⊕ B	3SE5 000-0AF02	1	1 unit	
	High-grade steel lever, plastic roller	22	⊕ B	3SE5 000-0AF03	1	1 unit	
	High-grade steel lever, high-grade steel roller	22	⊕ B	3SE5 000-0AF04	1	1 unit	
	Spring rods (for switches with snap-action contacts only)						
	Plastic plunger and high-grade steel spring: 7						
		• Length 142.5 mm (spring 50 mm, plunger 50 mm)		B	3SE5 000-0AR01	1	1 unit
		• Length 76 mm (spring 23.5 mm, plunger 10 mm)		B	3SE5 000-0AR03	1	1 unit
		• Length 242.5 mm (spring 150 mm, plunger 50 mm)		B	3SE5 000-0AR04	1	1 unit
	High-grade steel plunger and spring: 7						
	• Length 142.5 mm (spring 50 mm, plunger 50 mm)		B	3SE5 000-0AR02	1	1 unit	

SIRIUS 3SE5 International Limit Switches

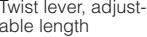
3SE5, metal enclosures – Enclosure width 56 mm

Version	Diameter	DT	Modular system	PU (UNIT, SET, M)	PS*	
	mm		Order No.	Price per PU		
Twist actuators						
	Twist actuators, metal (without lever)					
	<ul style="list-style-type: none"> For twist levers and rod actuators, switching right and/or left, adjustable For fork levers, latching 	<ul style="list-style-type: none"> ⊕ A ⊕ B 	<ul style="list-style-type: none"> 3SE5 000-0AH00 3SE5 000-0AT10 	<ul style="list-style-type: none"> 1 1 	<ul style="list-style-type: none"> 1 unit 1 unit 	
Levers for twist actuators						
	Twist levers 27 mm, offset, type A acc. to EN 50041					
	Metal lever, plastic roller	19	⊕ A	3SE5 000-0AA01	1	1 unit
	Metal lever, high-grade steel roller	19	⊕ A	3SE5 000-0AA02	1	1 unit
	Metal lever, roller with ball bearing	19	⊕ B	3SE5 000-0AA03	1	1 unit
	Metal lever, 2 plastic rollers	19	⊕ B	3SE5 000-0AA04	1	1 unit
	Metal lever, plastic roller	30	⊕ B	3SE5 000-0AA05	1	1 unit
	Metal lever, plastic roller	50	⊕ B	3SE5 000-0AA07	1	1 unit
	Metal lever, rubber roller	50	⊕ B	3SE5 000-0AA08	1	1 unit
	High-grade steel lever, plastic roller	19	⊕ B	3SE5 000-0AA11	1	1 unit
	High-grade steel lever, high-grade steel roller	19	⊕ B	3SE5 000-0AA12	1	1 unit
	Twist levers 35 mm, offset					
	Metal lever, plastic roller	19	⊕ B	3SE5 000-0AA15	1	1 unit
	Twist levers 30 mm, straight¹⁾					
	Metal lever, plastic roller	19	⊕ B	3SE5 000-0AA24	1	1 unit
	Metal lever, plastic roller	30	⊕ B	3SE5 000-0AA26	1	1 unit
	Twist levers, adjustable length, with grid hole					
	Metal lever, plastic roller	19	⊕ B	3SE5 000-0AA60	1	1 unit
	Metal lever, high-grade steel roller	19	⊕ B	3SE5 000-0AA61	1	1 unit
	Metal lever, plastic roller	50	⊕ B	3SE5 000-0AA67	1	1 unit
	Metal lever, rubber roller	50	⊕ B	3SE5 000-0AA68	1	1 unit
	High-grade steel lever, plastic roller	19	⊕ B	3SE5 000-0AA62	1	1 unit
High-grade steel lever, high-grade steel roller	19	⊕ B	3SE5 000-0AA63	1	1 unit	
	Twist levers, adjustable length					
	Metal lever, plastic roller	19	A	3SE5 000-0AA50	1	1 unit
	Metal lever, high-grade steel roller	19	B	3SE5 000-0AA51	1	1 unit
	Metal lever, plastic roller	30	B	3SE5 000-0AA55	1	1 unit
	Metal lever, plastic roller	50	B	3SE5 000-0AA57	1	1 unit
	Metal lever, rubber roller	50	B	3SE5 000-0AA58	1	1 unit
	High-grade steel lever, plastic roller	19	B	3SE5 000-0AA52	1	1 unit
	High-grade steel lever, high-grade steel roller	19	B	3SE5 000-0AA53	1	1 unit
	Fork levers (for switches with snap-action contacts only)					
	2 metal levers, 2 plastic rollers	19	⊕ B	3SE5 000-0AT01	1	1 unit
	2 metal levers, 2 high-grade steel rollers	19	⊕ B	3SE5 000-0AT02	1	1 unit
	2 high-grade steel levers, 2 plastic rollers	19	⊕ B	3SE5 000-0AT03	1	1 unit
	2 high-grade steel levers, 2 high-grade steel rollers	19	⊕ B	3SE5 000-0AT04	1	1 unit
	Rod actuators, type D acc. to EN 50041					
	Aluminum rod, length 200 mm	6	B	3SE5 000-0AA80	1	1 unit
	Spring rod, length 200 mm	6	B	3SE5 000-0AA81	1	1 unit
	Plastic rod, length 200 mm	6	B	3SE5 000-0AA82	1	1 unit

⊕ Positively driven actuator, necessary in safety circuits.

¹⁾ Can be clinch mounted (turned through 180°, rear of lever).

SIRIUS 3SE5 International Limit Switches

Metal enclosures – Enclosure width 56 mm, XL

Selection and ordering data

Complete units

4 or 5 contacts · Degree of protection IP66/IP67 · Cable entry 3 × (M20 × 1.5)

Version	Contacts	LEDs	DT	Complete units	PU (UNIT, SET, M)	PS*
				Order No.	Price per PU	

Complete units¹⁾ · Enclosure width 56 mm, XL



Plain plunger

Plain plungers

With high-grade steel plunger

Snap-action contacts 2 × (1 NO + 1 NC) — ⊕ B **3SE5 162-0CB01** 1 1 unit



Rounded plunger

Rounded plungers

With high-grade steel plungers, with 3 mm overtravel

Slow-action contacts 1 NO + 1 NC and — ⊕ B **3SE5 162-0EC02** 1 1 unit
 Slow-action contacts with make-before-break 1 NO + 2 NC
 2 mm travel difference



Roller plunger

Roller plungers

With high-grade steel roller 13 mm, with 3 mm overtravel

Slow-action contacts 2 × (1 NO + 1 NC) — ⊕ B **3SE5 162-0BD02** 1 1 unit
 Snap-action contacts 2 × (1 NO + 1 NC) — ⊕ A **3SE5 162-0CD02** 1 1 unit



Roller lever

Roller levers

With metal lever and plastic roller 22 mm

Slow-action contacts 2 × (1 NO + 1 NC) — ⊕ B **3SE5 162-0BE01** 1 1 unit
 Snap-action contacts 2 × (1 NO + 1 NC) — ⊕ A **3SE5 162-0CE01** 1 1 unit

With metal lever and high-grade steel roller 22 mm

Snap-action contacts 2 × (1 NO + 1 NC) — ⊕ B **3SE5 162-0CE02** 1 1 unit



Angular roller lever

Angular roller levers

With metal lever and plastic roller 22 mm

Snap-action contacts 2 × (1 NO + 1 NC) — ⊕ B **3SE5 162-0CF01** 1 1 unit



Twist lever

Twist levers

With metal lever 27 mm and plastic roller 19 mm

Snap-action contacts 2 × (1 NO + 1 NC) — ⊕ A **3SE5 162-0CH01** 1 1 unit

For online configurator see www.siemens.com/sirius/configurators.

Positive opening according to IEC 60947-5-1, Appendix K.

¹⁾ Popular versions.

Note:

If the device you require is not available as a complete unit, see "Modular System", page 13/40.

SIRIUS 3SE5 International Limit Switches

Metal enclosures – Enclosure width 56 mm, XL

Modular system

4 or 6 contacts · Degree of protection IP66/IP67 · Cable entry 3 × (M20 × 1.5)

Version	Contacts	LEDs	DT	Modular system	PU (UNIT, SET, M)	PS*
				Order No.	Price per PU	

Basic switches · Enclosure width 56 mm, XL



Basic switch

With 3 x M20 x 1.5 connecting thread						
Slow-action contacts	2 × (1 NO + 1 NC)	—	⊕ ▶	3SE5 162-0BA00	1	1 unit
Snap-action contacts	2 × (1 NO + 1 NC)	—	⊕ A	3SE5 162-0CA00	1	1 unit
Slow-action contacts with make-before-break	2 × (1 NO + 2 NC)	—	⊕ A	3SE5 162-0DA00	1	1 unit
With increased corrosion protection ¹⁾						
Slow-action contacts	2 × (1 NO + 1 NC)	—	⊕ B	3SE5 162-0BA00-1CA0	1	1 unit
Snap-action contacts	2 × (1 NO + 1 NC)	—	⊕ B	3SE5 162-0CA00-1CA0	1	1 unit
Slow-action contacts with make-before-break	2 × (1 NO + 2 NC)	—	⊕ B	3SE5 162-0DA00-1CA0	1	1 unit

For online configurator see www.siemens.com/sirius/configurators.

Positive opening according to IEC 60947-5-1, Appendix K, or positively driven actuator, necessary in safety circuits.

¹⁾ Use corresponding high-grade steel lever.

Note:

Selection aid [see page 13/9](#).

Version	Diameter	DT	Modular system	PU (UNIT, SET, M)	PS*
	mm		Order No.	Price per PU	

Operating mechanisms



Plain plunger

Plain plungers						
High-grade steel plungers	10	⊕ A	3SE5 000-0AB01	1	1 unit	



Rounded plunger

Rounded plungers, type B acc. to EN 50041						
High-grade steel plungers, with 3 mm overtravel	10	⊕ B	3SE5 000-0AC02	1	1 unit	



Roller plunger

Roller plungers, type C acc. to EN 50041						
High-grade steel roller, with 3 mm overtravel	13	⊕ B	3SE5 000-0AD02	1	1 unit	



Roller lever

Roller levers						
Metal lever, plastic roller	22	⊕ A	3SE5 000-0AE01	1	1 unit	
Metal lever, high-grade steel roller	22	⊕ B	3SE5 000-0AE02	1	1 unit	
High-grade steel lever, plastic roller	22	⊕ B	3SE5 000-0AE03	1	1 unit	
High-grade steel lever, high-grade steel roller	22	⊕ B	3SE5 000-0AE04	1	1 unit	



Angular roller lever

Angular roller levers						
Metal lever, plastic roller	22	⊕ A	3SE5 000-0AF01	1	1 unit	
Metal lever, high-grade steel roller	22	⊕ B	3SE5 000-0AF02	1	1 unit	
High-grade steel lever, plastic roller	22	⊕ B	3SE5 000-0AF03	1	1 unit	
High-grade steel lever, high-grade steel roller	22	⊕ B	3SE5 000-0AF04	1	1 unit	







Spring rod

Spring rods (for switches with snap-action contacts only)						
Plastic plunger and high-grade steel spring:	7					
• Length 142.5 mm (spring 50 mm, plunger 50 mm)		B	3SE5 000-0AR01	1	1 unit	
• Length 76 mm (spring 23.5 mm, plunger 10 mm)		B	3SE5 000-0AR03	1	1 unit	
• Length 242.5 mm (spring 150 mm, plunger 50 mm)		B	3SE5 000-0AR04	1	1 unit	
High-grade steel plunger and spring:	7					
• Length 142.5 mm (spring 50 mm, plunger 50 mm)		B	3SE5 000-0AR02	1	1 unit	

Positively driven actuator, necessary in safety circuits.

SIRIUS 3SE5 International Limit Switches

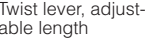
Metal enclosures – Enclosure width 56mm and 56mm, XL

Version	Diameter	DT	Modular system	PU (UNIT, SET, M)	PS*	
	mm		Order No.	Price per PU		
Twist actuators						
	Twist actuators, metal (without lever)					
	<ul style="list-style-type: none"> For twist levers and rod actuators, switching right and/or left, adjustable For fork levers, latching 					
		⊕ A	3SE5 000-0AH00	1	1 unit	
		⊕ B	3SE5 000-0AT10	1	1 unit	
Levers for twist actuators						
	Twist levers 27 mm, offset, type A acc. to EN 50041					
	Metal lever, plastic roller	19	⊕ A	3SE5 000-0AA01	1	1 unit
	Metal lever, high-grade steel roller	19	⊕ A	3SE5 000-0AA02	1	1 unit
	Metal lever, roller with ball bearing	19	⊕ B	3SE5 000-0AA03	1	1 unit
	Metal lever, 2 plastic rollers	19	⊕ B	3SE5 000-0AA04	1	1 unit
	Metal lever, plastic roller	30	⊕ B	3SE5 000-0AA05	1	1 unit
	Metal lever, plastic roller	50	⊕ B	3SE5 000-0AA07	1	1 unit
	Metal lever, rubber roller	50	⊕ B	3SE5 000-0AA08	1	1 unit
	High-grade steel lever, plastic roller	19	⊕ B	3SE5 000-0AA11	1	1 unit
	High-grade steel lever, high-grade steel roller	19	⊕ B	3SE5 000-0AA12	1	1 unit
	Twist levers 35 mm, offset					
Metal lever, plastic roller	19	⊕ B	3SE5 000-0AA15	1	1 unit	
Twist levers 30 mm, straight¹⁾						
Metal lever, plastic roller	19	⊕ B	3SE5 000-0AA24	1	1 unit	
Metal lever, plastic roller	30	⊕ B	3SE5 000-0AA26	1	1 unit	
	Twist levers, adjustable length, with grid hole					
	Metal lever, plastic roller	19	⊕ B	3SE5 000-0AA60	1	1 unit
	Metal lever, high-grade steel roller	19	⊕ B	3SE5 000-0AA61	1	1 unit
	Metal lever, plastic roller	50	⊕ B	3SE5 000-0AA67	1	1 unit
	Metal lever, rubber roller	50	⊕ B	3SE5 000-0AA68	1	1 unit
	High-grade steel lever, plastic roller	19	⊕ B	3SE5 000-0AA62	1	1 unit
High-grade steel lever, high-grade steel roller	19	⊕ B	3SE5 000-0AA63	1	1 unit	
	Twist levers, adjustable length					
	Metal lever, plastic roller	19	A	3SE5 000-0AA50	1	1 unit
	Metal lever, high-grade steel roller	19	B	3SE5 000-0AA51	1	1 unit
	Metal lever, plastic roller	30	B	3SE5 000-0AA55	1	1 unit
	Metal lever, plastic roller	50	B	3SE5 000-0AA57	1	1 unit
	Metal lever, rubber roller	50	B	3SE5 000-0AA58	1	1 unit
	High-grade steel lever, plastic roller	19	B	3SE5 000-0AA52	1	1 unit
	High-grade steel lever, high-grade steel roller	19	B	3SE5 000-0AA53	1	1 unit
	Fork levers (for switches with snap-action contacts only)					
	2 metal levers, 2 plastic rollers	19	⊕ B	3SE5 000-0AT01	1	1 unit
	2 metal levers, 2 high-grade steel rollers	19	⊕ B	3SE5 000-0AT02	1	1 unit
	2 high-grade steel levers, 2 plastic rollers	19	⊕ B	3SE5 000-0AT03	1	1 unit
	2 high-grade steel levers, 2 high-grade steel rollers	19	⊕ B	3SE5 000-0AT04	1	1 unit
	Rod actuators, type D acc. to EN 50041					
	Aluminum rod, length 200 mm	6	B	3SE5 000-0AA80	1	1 unit
	Spring rod, length 200 mm	6	B	3SE5 000-0AA81	1	1 unit
	Plastic rod, length 200 mm	6	B	3SE5 000-0AA82	1	1 unit
	Plastic rod, length 330 mm	6	B	3SE5 000-0AA83²⁾	1	1 unit

⊕ Positively driven actuator, necessary in safety circuits.

¹⁾ Can be clinch mounted (turned through 180°, rear of lever).

²⁾ For Enclosure width 56mm XL only.

SIRIUS 3SE5 International Limit Switches

3SE5, metal enclosures – Ambient temperature to –40 °C

Selection and ordering data

Modular system

2 or 3 contacts · Degree of protection IP66/IP67 · Cable entry M20 × 1.5

Version	Contacts	LEDs	DT	Modular system	PU (UNIT, SET, M)	PS*
				Order No.	Price per PU	

Basic switches · Enclosure width 31 mm (with rounded plunger¹⁾)



Basic switch

With plunger

Snap-action contacts	1 NO + 1 NC	—		B	3SE5 212-0CC05-1AJ0	1	1 unit
Slow-action contacts	1 NO + 2 NC	—		B	3SE5 212-0KC05-1AJ0	1	1 unit
Snap-action contacts	1 NO + 2 NC	—		B	3SE5 212-0LC05-1AJ0	1	1 unit

For online configurator see www.siemens.com/sirius/configurators.

Positive opening according to IEC 60947-5-1, Appendix K, or positively driven actuator, necessary in safety circuits.

¹⁾ For enclosures with widths of 31 mm, the basic switch is a complete unit with rounded plungers.

Note:

Selection aid [see page 13/9](#).

Version	Diameter	DT	Modular system	PU (UNIT, SET, M)	PS*
	mm		Order No.	Price per PU	

Operating mechanisms



Roller plunger

Roller plungers, type C acc. to EN 50047

Plastic rollers	10		B	3SE5 000-0AD03-1AJ0	1	1 unit
-----------------	----	--	---	----------------------------	---	--------



Roller lever

Roller levers, type E acc. to EN 50047

Metal lever, plastic roller	13		B	3SE5 000-0AE10-1AJ0	1	1 unit
High-grade steel lever, plastic roller	13		B	3SE5 000-0AE12-1AJ0	1	1 unit



Angular roller lever

Angular roller levers

Metal lever, plastic roller	13		B	3SE5 000-0AF10-1AJ0	1	1 unit
High-grade steel lever, plastic roller	13		B	3SE5 000-0AF12-1AJ0	1	1 unit

Twist actuators



Twist actuator

Twist actuators, plastic (without lever)

Switching right and/or left, adjustable			B	3SE5 000-0AK00-1AJ0	1	1 unit
---	--	--	---	----------------------------	---	--------

Levers for twist actuators



Twist lever

Twist lever straight, 21 mm, type A acc. to EN 50047

Metal lever, plastic roller	19		B	3SE5 000-0AA21-1AJ0	1	1 unit
High-grade steel lever, plastic roller	19		B	3SE5 000-0AA31-1AJ0	1	1 unit



Twist lever, adjustable length

Twist levers, adjustable length, with grid hole

Metal lever, plastic roller	19		B	3SE5 000-0AA60-1AJ0	1	1 unit
High-grade steel lever, plastic roller	19		B	3SE5 000-0AA62-1AJ0	1	1 unit

Positively driven actuator, necessary in safety circuits.

SIRIUS 3SE5 International Limit Switches

3SE5, metal enclosures – Ambient temperature to –40 °C

Complete units

2 or 3 contacts · Degree of protection IP66/IP67 · Cable entry M20 × 1.5

Version	Contacts	LEDs	DT	Complete units	Configurator	Order No.	Price per PU	PU (UNIT, SET, M)	PS*

Complete units · Enclosure width 40 mm



Rounded plunger

Rounded plungers, type B acc. to EN 50041

With high-grade steel plungers, with 3 mm overtravel

Snap-action contacts	1 NO + 1 NC	—		B	3SE5 112-0CC02-1AJ0			1	1 unit
----------------------	-------------	---	--	---	---------------------	--	--	---	--------



Twist lever, adjustable length

Twist levers, adjustable length

With high-grade steel lever with grid hole and plastic roller 19 mm

Snap-action contacts	1 NO + 1 NC	—		B	3SE5 112-0CH62-1AJ0			1	1 unit
----------------------	-------------	---	--	---	---------------------	--	--	---	--------

For online configurator see www.siemens.com/sirius/configurators.

Positive opening according to IEC 60947-5-1, Appendix K or positively driven actuator, necessary in safety circuits.

Note:

If the device you require is not available as a complete unit, see "Modular System".

Modular system

2, 3 or 4 contacts · Degree of protection IP66/IP67 · Cable entry M20 × 1.5

Version	Contacts	LEDs	DT	Modular system	Configurator	Order No.	Price per PU	PU (UNIT, SET, M)	PS*

Basic switches · Enclosure width 40 mm



Basic switch

With M20 □ 1.5 connecting thread

Snap-action contacts	1 NO + 1 NC	—		B	3SE5 112-0CA00-1AJ0			1	1 unit
Slow-action contacts	1 NO + 2 NC	—		B	3SE5 112-0KA00-1AJ0			1	1 unit
Snap-action contacts	1 NO + 2 NC	—		B	3SE5 112-0LA00-1AJ0			1	1 unit

Basic switches · Enclosure width 56 mm



Basic switch

With 3 x M20 x 1.5 connecting thread

Snap-action contacts	1 NO + 1 NC	—		B	3SE5 122-0CA00-1AJ0			1	1 unit
Slow-action contacts	1 NO + 2 NC	—		B	3SE5 122-0KA00-1AJ0			1	1 unit
Snap-action contacts	1 NO + 2 NC	—		B	3SE5 122-0LA00-1AJ0			1	1 unit

Basic switches · Enclosure width 56 mm, XL



Basic switch

With 3 x M20 x 1.5 connecting thread

Slow-action contacts	2 × (1 NO + 1 NC)	—		B	3SE5 162-0BA00-1AJ0			1	1 unit
Snap-action contacts	2 × (1 NO + 1 NC)	—		B	3SE5 162-0CA00-1AJ0			1	1 unit

For online configurator see www.siemens.com/sirius/configurators.







Positive opening according to IEC 60947-5-1, Appendix K or positively driven actuator, necessary in safety circuits.

Note:

Selection aid [see page 13/9](#).

SIRIUS 3SE5 International Limit Switches

3SE5, metal enclosures – Ambient temperature to –40 °C

Version	Diameter	DT	Modular system	PU (UNIT, SET, M)	PS*
	mm		Order No. Price per PU		
Operating mechanisms					
	Rounded plungers, type B acc. to EN 50041 High-grade steel plungers, with 3 mm overtravel	10	⊕ B	3SE5 000-0AC02-1AJ0	1 1 unit
Rounded plunger					
	Roller plungers, type C acc. to EN 50041 High-grade steel roller, with 3 mm overtravel	10	⊕ B	3SE5 000-0AD02-1AJ0	1 1 unit
Roller plunger					
Roller levers					
	Metal lever, plastic roller	13	⊕ B	3SE5 000-0AE01-1AJ0	1 1 unit
Roller lever	High-grade steel lever, plastic roller	13	⊕ B	3SE5 000-0AE03-1AJ0	1 1 unit
Angular roller levers					
	Metal lever, plastic roller	13	⊕ B	3SE5 000-0AF01-1AJ0	1 1 unit
Angular roller lever	High-grade steel lever, plastic roller	13	⊕ B	3SE5 000-0AF03-1AJ0	1 1 unit
Twist actuators					
	Twist actuators, metal (without lever) Switching right and/or left, adjustable		⊕ B	3SE5 000-0AH00-1AJ0	1 1 unit
Twist actuator					
Levers for twist actuators					
	Twist levers, type A acc. to EN 50041 Metal lever, plastic roller	19	⊕ B	3SE5 000-0AA01-1AJ0	1 1 unit
Twist lever	High-grade steel lever, plastic roller	19	⊕ B	3SE5 000-0AA11-1AJ0	1 1 unit
Twist levers, adjustable length, with grid hole					
	Metal lever, plastic roller	19	⊕ B	3SE5 000-0AA60-1AJ0	1 1 unit
Twist lever, adjustable length	High-grade steel lever, plastic roller	19	⊕ B	3SE5 000-0AA62-1AJ0	1 1 unit

⊕ Positively driven actuator, necessary in safety circuits.

SIRIUS 3SE5 International Limit Switches

3SE5, metal enclosures – Compact design

Overview

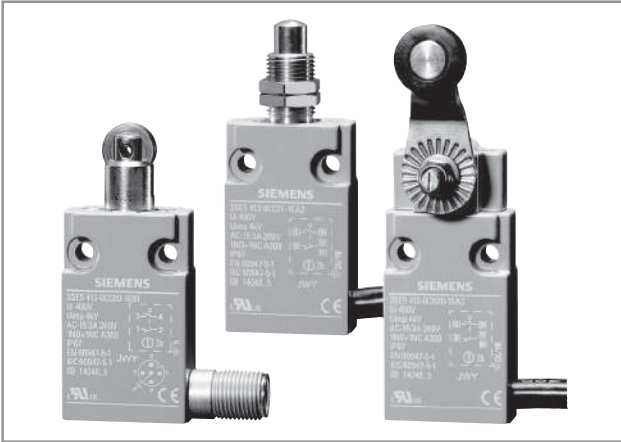

Compact design in width 30 mm

Particularly in harsh environments or on equipment with limited space, the small 3SE5 4 position switches in compact design with a depth of 16 mm and a weight of only 80 g (without cable) are ideal. Above all the versions with molded cable can be mounted in the most confined places.

3SE5 4 compact position switches are available in two different widths as complete units:

- The 3SE5 413 series complies with the EU standard and features a 30 mm wide enclosure with drilled holes at a distance of 20 mm.
- The 3SE5 423 series meets the requirements of the US market and features a 40 mm wide enclosure with drilled holes at a spacing of 25 mm.

Both the enclosure and the twist actuator are made of metal and comply with the high IP67 degree of protection. Following actuators are available:

- Rounded plungers
- Rounded plungers with central fixing
- Rounded plungers with external seal
- Roller plungers
- Roller plunger with central fixing
- Twist levers

The contact block is designed with snap-action contacts 1 NO + 1 NC. The NC contact complies with the requirements for positive opening acc. to IEC 60947-5-1.

Use in safety circuits up to Category 4 according to EN ISO 13849-1.

Connection:

- With molded cable, 2 m or 5 m long
- With M12 connector socket

Benefits

- Very compact yet with the same rating as the 3SE51 standard switches, for notable space savings in confined installation conditions
- Various actuator versions available
- Actuator heads rotatable in increments of 90°
- Time is saved when mounting the fully assembled unit
- With metal enclosure of degree of protection IP67, ideal for use in rough industrial environments
- Insensitive to electromagnetic interference

SIRIUS 3SE5 International Limit Switches

3SE5, metal enclosures – Compact design

Selection and ordering data

2 snap-action contacts 1 NO + 1 NC · Degree of protection IP67 · With connecting cable or M12 connector socket

Operating mechanism	Enclosure width mm	DT	Configurator 		PU (UNIT, SET, M)	PS*
			Order No.	Price per PU		

Complete units · Enclosure width 30 or 40 mm

Rounded plungers

- Standard mounting
 - With 2 m cable 5 x 0.75 mm²
 - With 5 m cable 5 x 0.75 mm²
 - With M12 connector socket



Rounded plunger

- With central fixing M12 x 1
 - With 2 m cable 5 x 0.75 mm²



With central fixing

- With external seal
 - With 2 m cable 5 x 0.75 mm²



With external seal

Roller plungers

- Standard mounting
 - With 2 m cable 5 x 0.75 mm²
 - With 5 m cable 5 x 0.75 mm²
 - With M12 connector socket



Roller plunger

- With central fixing M12 x 1
 - With 2 m cable 5 x 0.75 mm²



With plug

- Actuator head rotated 90°
 - With 2 m cable 5 x 0.75 mm²



With plug, enclosure width 40 mm

Twist levers

- Standard mounting
 - With 2 m cable 5 x 0.75 mm²
 - With 5 m cable 5 x 0.75 mm²
 - With M12 connector socket



Twist lever

30	⊕ A	3SE5 413-0CC20-1EA2	1	1 unit
40	⊕ ▶	3SE5 423-0CC20-1EA2	1	1 unit
30	⊕ B	3SE5 413-0CC20-1EA5	1	1 unit
30	⊕ A	3SE5 413-0CC20-1EB1	1	1 unit
40	⊕ A	3SE5 423-0CC20-1EB1	1	1 unit
30	⊕ ▶	3SE5 413-0CC21-1EA2	1	1 unit
40	⊕ A	3SE5 423-0CC21-1EA2	1	1 unit
30	⊕ A	3SE5 413-0CC22-1EA2	1	1 unit
40	⊕ A	3SE5 423-0CC22-1EA2	1	1 unit
30	⊕ ▶	3SE5 413-0CD20-1EA2	1	1 unit
40	⊕ ▶	3SE5 423-0CD20-1EA2	1	1 unit
30	⊕ B	3SE5 413-0CD20-1EA5	1	1 unit
30	⊕ A	3SE5 413-0CD20-1EB1	1	1 unit
40	⊕ A	3SE5 423-0CD20-1EB1	1	1 unit
30	⊕ A	3SE5 413-0CD21-1EA2	1	1 unit
40	⊕ A	3SE5 423-0CD21-1EA2	1	1 unit
30	⊕ A	3SE5 413-0CD23-1EA2	1	1 unit
30	⊕ ▶	3SE5 413-0CN20-1EA2	1	1 unit
40	⊕ A	3SE5 423-0CN20-1EA2	1	1 unit
30	⊕ A	3SE5 413-0CN20-1EA5	1	1 unit
30	⊕ A	3SE5 413-0CN20-1EB1	1	1 unit
40	⊕ A	3SE5 423-0CN20-1EB1	1	1 unit

 For online configurator see www.siemens.com/sirius/configurators.

 Positive opening according to IEC 60947-5-1, Appendix K.

SIRIUS 3SE5 International Limit Switches

3SE5, open-type design

Overview



Open-type design

Their compact design makes these switches particularly suitable for use in confined conditions. The fixing dimensions and operating points are according to EN 50047.

The switches are equipped with two or three contacts in slow-action or snap-action versions. The stroke is 6 mm.

The empty enclosure can be equipped with all switch block versions (see page 13/49).

Selection and ordering data

2 or 3 contacts · Degree of protection IP20 (2 contacts), IP10 (3 contacts)

Version	Contacts	DT	Configurator	Order No.	Price per PU	PU (UNIT, SET, M)	PS*
---------	----------	----	--------------	-----------	--------------	-------------------	-----

Plastic enclosures · Enclosure width 30 mm

With teflon plunger, Ø 6 mm



2 contacts

Slow-action contacts	1 NO + 1 NC	⊕ ▶	3SE5 250-0BC05			1	1 unit
Snap-action contacts	1 NO + 1 NC	⊕ ▶	3SE5 250-0CC05			1	1 unit



3 contacts

Slow-action contacts	1 NO + 2 NC	⊕ ▶	3SE5 250-0KC05			1	1 unit
Snap-action contacts	1 NO + 2 NC	⊕ ▶	3SE5 250-0LC05			1	1 unit
Slow-action contacts with make-before-break	1 NO + 2 NC	⊕ A	3SE5 250-0MC05			1	1 unit
Slow-action contacts	2 NO + 1 NC	⊕ ▶	3SE5 250-0PC05			1	1 unit



Empty enclosures

Empty enclosures without contact block	—	⊕ B	3SE5 250-0AC05			1	1 unit
--	---	-----	-----------------------	--	--	---	--------



2 contacts

Contact blocks with 2 contacts for open-type design¹⁾

• Slow-action contacts	1 NO + 1 NC	⊕ B	3SE5 050-0BA00			1	1 unit
• Snap-action contacts	1 NO + 1 NC	⊕ B	3SE5 050-0CA00			1	1 unit
- Standard		⊕ B	3SE5 050-0GA00			1	1 unit
- 2 × 2 mm switching interval		⊕ B	3SE5 050-0GA00			1	1 unit
- Short stroke		⊕ B	3SE5 050-0NA00			1	1 unit

⚙ For online configurator see www.siemens.com/sirius/configurators.

⊕ Positive opening according to IEC 60947-5-1, Appendix K.

¹⁾ Contact blocks with 3 contacts see page 13/49.







Selection and ordering data

Version	DT	Order No.	List Price \$ per PU	PU (UNIT, SET, M)	PS*	PG	Weight per PU approx. kg
Plug-in connections for M20 × 1.5 connecting threads							
		Connector sockets (6-pole+PE), for M20×1.5		1	1 unit	102	0.030
		For max. 250 V, 10 A					
		With 0.75 mm ² connecting cable, plastic, degree of protection IP65, ambient temperature -40 to +90 °C					
		Cable boxes (6-pole + PE)¹⁾		1	1 unit	102	0.065
		With terminal compartment, can be pre-assembled, plastic, degree of protection IP65					
		Connector sockets (4-pole), M12, for M20 × 1.5, fixed		1	1 unit	102	0.010
		For max 250 V, 4 A, $U_{imp} = 2500$ V					
		With four 0.25 mm ² connecting cables, plastic, degree of protection IP67, ambient temperature -40 to +85 °C					
		Cable boxes (4-pole), M12, with terminal compartment, can be pre-assembled		1	1 unit	574	0.015
		Angular cable boxes (4-pole), M12, with terminal compartment, can be pre-assembled		1	1 unit	574	0.015
		Connector sockets (5-pole), M12, for M20 × 1.5, fixed		1	1 unit	102	0.010
		For max 125 V, 4 A, $U_{imp} = 1500$ V					
		With five 0.25 mm ² connecting cables, plastic, degree of protection IP67, ambient temperature -40 to +85 °C					
		Cable boxes (5-pole), M12, with terminal compartment, can be pre-assembled		1	1 unit	574	0.016
		Angular cable boxes (5-pole), M12, with terminal compartment, can be pre-assembled		1	1 unit	574	0.016
		Connector sockets (8-pole), M12, for M20 × 1.5, fixed, metal version		1	1 unit	102	0.025
		For max 30 V, 2 A, $U_{imp} = 800$ V					
		With eight 0.25 mm ² connecting cables, metal, degree of protection IP67, ambient temperature -40 to +85 °C					
		Cable boxes (8-pole), M12		1	1 unit	574	0.335
		With 5 m PUR cable, 8 × 0.25 mm ² , IP67					
Adaptors for 3SE. (with M 16)							
		metal M16 x 1.5 to 1/2" NPT		1	1 unit		0.022
Adaptors for 3SE2 (with M 20)							
		plastic M20 x 1.5 wire gland		1	1 unit		0.011
		metal M20 x 1.5 to 1/2" NPT		1	1 unit		0.022
		plastic M20 x 1.5 to 1/2" NPT		1	1 unit		0.012
							
		plastic cable gland, M20 x 1.5		1	1 unit		0.010
Adaptors for 3SE. (with M 25)							
		metal M 25 x 1.5 to 1/2" NPT		1	1 unit		0.022

¹⁾ For wiring, a crimping tool is necessary, max. conductor cross-section 1 mm².

SIRIUS 3SE5 International Limit Switches

Accessories and spare parts

Version	Color/ contacts	DT	Order No.	Price per PU	PU (UNIT, SET, M)	PS*
Optional accessories for 3SE52						
	Protective caps, rubber, for rounded plungers acc. to EN 50047, 3SE5 ...-...C05	Black	A	3SE5 000-0AC30	1	1 unit
Spare parts for 3SE51, 3SE52						
	Empty enclosures, plastic	Turquoise				
	Enclosure width 31 mm		B	3SE5 232-0AC05	1	1 unit
	• With increased corrosion protection		B	3SE5 232-0AC05-1CA0	1	1 unit
	Enclosure width 50 mm		B	3SE5 242-0AC05	1	1 unit
	• With increased corrosion protection		B	3SE5 242-0AC05-1CA0	1	1 unit
	Empty enclosures, metal	Turquoise				
	Enclosure width 31 mm		B	3SE5 212-0AC05	1	1 unit
	• With increased corrosion protection		B	3SE5 212-0AC05-1CA0	1	1 unit
	Enclosure width 40 mm		B	3SE5 112-0AA00	1	1 unit
	• With increased corrosion protection		B	3SE5 112-0AA00-1CA0	1	1 unit
	Enclosure width 56 mm		B	3SE5 122-0AA00	1	1 unit
	• With increased corrosion protection		B	3SE5 122-0AA00-1CA0	1	1 unit
	Enclosure width 56 mm, XL ¹⁾		B	3SE5 162-0AA00	1	1 unit
	Contact blocks with 2 contacts²⁾					
	• Slow-action contacts	1 NO + 1 NC	⊕ ▶	3SE5 000-0BA00	1	1 unit
	• Snap-action contacts	1 NO + 1 NC				
	- Standard		⊕ B	3SE5 000-0CA00	1	1 unit
	- Gold-plated contacts		⊕ B	3SE5 000-0CA00-1AC1	1	1 unit
	- 2 x 2 mm switching interval		⊕ B	3SE5 000-0GA00	1	1 unit
- Short stroke		⊕ B	3SE5 000-0NA00	1	1 unit	
	Contact blocks with 3 contacts					
	• Slow-action contacts	1 NO + 2 NC	⊕ B	3SE5 000-0KA00	1	1 unit
	• Snap-action contacts	1 NO + 2 NC	⊕ B	3SE5 000-0LA00	1	1 unit
	• Slow-action contacts with make-before-break	1 NO + 2 NC	⊕ A	3SE5 000-0MA00	1	1 unit
	• Slow-action contacts	2 NO + 1 NC	A	3SE5 000-0PA00	1	1 unit
	Contact blocks for enclosure XL¹⁾					
	• Slow-action contacts	1 NO + 1 NC	⊕ B	3SE5 060-0BA00	1	1 unit
	• Snap-action contacts	1 NO + 1 NC	⊕ B	3SE5 060-0CA00	1	1 unit
	• Slow-action contacts with make-before-break	1 NO + 2 NC	⊕ B	3SE5 060-0MA00	1	1 unit







⊕ Positive opening according to IEC 60947-5-1, Appendix K.

1) Equip XL enclosures only with contact combinations according to pages 12/11, 12/42 and 12/43.

2) Unsuitable for open-type position switches; see page 13/47.

SIRIUS 3SE5 International Limit Switches

Accessories and spare parts

Version	Rated voltage LED	DT	Order No.	Price per PU	PU (UNIT, SET, M)	PS*
V						
Spare parts for 3SE51, 3SE52						
 31 mm, turquoise with LED	Covers for plastic enclosures, width 31 mm					
	• Turquoise with LED	24 DC	B	3SE5 230-1AA00		1 1 unit
		230 AC	B	3SE5 230-3AA00		1 1 unit
	• Yellow	—	B	3SE5 230-0AA00-1AG0		1 1 unit
	• Yellow with LED	24 DC	B	3SE5 230-1AA00-1AG0		1 1 unit
		230 AC	B	3SE5 230-3AA00-1AG0		1 1 unit
 40 mm, yellow with LED	Covers for plastic enclosures, width 40 mm					
	• Turquoise with LED	24 DC	B	3SE5 130-1AA00		1 1 unit
		230 AC	B	3SE5 130-3AA00		1 1 unit
	• Yellow	—	B	3SE5 130-0AA00-1AG0		1 1 unit
	• Yellow with LED	24 DC	B	3SE5 130-1AA00-1AG0		1 1 unit
		230 AC	B	3SE5 130-3AA00-1AG0		1 1 unit
 50 mm, turquoise with LED	Covers for plastic enclosures, width 50 mm					
	• Turquoise with LED	24 DC	B	3SE5 240-1AA00		1 1 unit
		230 AC	B	3SE5 240-3AA00		1 1 unit
	• Yellow	—	B	3SE5 240-0AA00-1AG0		1 1 unit
	• Yellow with LED	24 DC	B	3SE5 240-1AA00-1AG0		1 1 unit
		230 AC	B	3SE5 240-3AA00-1AG0		1 1 unit
 31 mm, turquoise with LED	Covers for metal enclosures, width 31 mm					
	• Turquoise with LED	24 DC	B	3SE5 210-1AA00		1 1 unit
		230 AC	B	3SE5 210-3AA00		1 1 unit
	• Yellow	—	B	3SE5 210-0AA00-1AG0		1 1 unit
	• Yellow with LED	24 DC	B	3SE5 210-1AA00-1AG0		1 1 unit
		230 AC	B	3SE5 210-3AA00-1AG0		1 1 unit
 40 mm, yellow with LED	Covers for metal enclosures, width 40 mm					
	• Turquoise with LED	24 DC	B	3SE5 110-1AA00		1 1 unit
		230 AC	B	3SE5 110-3AA00		1 1 unit
	• Yellow	—	B	3SE5 110-0AA00-1AG0		1 1 unit
	• Yellow with LED	24 DC	B	3SE5 110-1AA00-1AG0		1 1 unit
		230 AC	B	3SE5 110-3AA00-1AG0		1 1 unit
 56 mm, yellow with LED	Covers for metal enclosures, width 56 mm					
	• Turquoise with LED	24 DC	B	3SE5 120-1AA00		1 1 unit
		230 AC	B	3SE5 120-3AA00		1 1 unit
	• Yellow	—	B	3SE5 120-0AA00-1AG0		1 1 unit
	• Yellow with LED	24 DC	B	3SE5 120-1AA00-1AG0		1 1 unit
		230 AC	B	3SE5 120-3AA00-1AG0		1 1 unit
Covers for XL metal enclosures, width 56 mm						
• Yellow	—	B	3SE5 160-0AA00-1AG0		1 1 unit	

Technical specifications

Type		3SE5 1..., 3SE5 2..	3SE5 41.	3SE5 42.
General data				
Standards		IEC 60947-5-1, EN 60947-5-1		
Rated insulation voltage U_i	V	400	400	
Pollution degree acc. to IEC 60664-1		Class 3	Class 3	
Rated impulse withstand voltage U_{imp}	kV	6	4	
Rated operational voltage U_e	V	400 V AC, over 300 V AC only for equal potential ¹⁾	300 AC	
Conventional thermal current I_{th}	A	10	6	10
Rated operational current I_e		2-pole	3-pole	2-pole
• With alternating current 50/60 Hz		$I_e/AC-15$	$I_e/AC-15$	$I_e/AC-15$
- At 24 V	A	6	6	6
- At 120 V	A	6	3	6
- At 240 V	A	3	1.5	3
• For direct current		$I_e/DC-13$	$I_e/DC-13$	$I_e/DC-13$
- At 24 V	A	3	3	3
- At 125 V	A	0.55	0.55	0.55
- At 250 V	A	0.27	0.27	0.27
Short-circuit protection²⁾				
• With DIAZED fuse links, gG operational class	A	6		
• With miniature circuit breaker, Char. C	A	1	2	1
Mechanical endurance				
• Basic switches		15 × 10 ⁶ operating cycles	30 × 10 ⁶ operating cycles	30 × 10 ⁶ operating cycles
• With spring rod, 3SE5 ...-R..		10 × 10 ⁶ operating cycles	—	—
• With fork lever 3SE5 1...-T..		1 × 10 ⁶ operating cycles	—	—
Electrical endurance				
• With 3RH.1, 3RT contactors in size S00, S0		10 × 10 ⁶ operating cycles	10 × 10 ⁶ operating cycles	5 × 10 ⁶ operating cycles
• For utilization category AC-15 when switching off $I_e/AC-15$ at 240 V		0.1 × 10 ⁶ operating cycles	—	—
• With utilization category DC-12/DC-13		For direct current depending on the loading of the switch		
Switching frequency With 3RH.1, 3RT contactors in size S00, S0		6000 operating cycles/h	1800 operating cycles/h	
Switching accuracy For repeated switching, measured at the plunger of the contact block	mm	0.05		
• With twist actuators		1°		
Rated data acc. to \mathcal{E}, \mathcal{R} and \mathcal{A}				
• Rated voltage	V	300		
• Uninterrupted current	A	6		
• Switching capacity		Heavy duty, A 300 / B 300 / Q 300	A 300 / Q 300	

¹⁾ For slow-action contacts 1 NO + 2 NC with make-before-break and
2 NO + 1 NC the following applies: over 250 V AC only equal potential

²⁾ Without any welds according to IEC 60947-5-1.

Type		3SE5 23.	3SE5 13	3SE5 24.	3SE5 21.	3SE5 11.	3SE5 12., 3SE5 16.	3SE5 4..	3SE5 25.
Enclosure									
Enclosure		Ultramid A3X2G7			Zinc diecasting GD Zn Al4 Cu1			—	
• Material									
• Width	mm	31	40	50	31	40	56	30 / 40	30
Degree of protection acc. to IEC 60529		IP65	IP66/IP67 ¹⁾					IP67	IP20, IP10
Ambient temperature									
• During operation	°C	-25 ... +85						-25 ... +85	-25 ... +85
• In operation, switch with LEDs	°C	-25 ... +70						—	—
• Storage, transport	°C	-40 ... +90						-40 ... +90	-40 ... +90
Mounting position		Any							
Connection									
Cable entry		1 × (M20 × 1.5)	2 × (M20 × 1.5)	1 × (M20 × 1.5)	3 × (M20 × 1.5)	—			
Conductor cross-sections²⁾									
• Solid	mm ²	2 × (0.5 ... 0.75), 1 × (0.5 ... 1.5)							
• Finely stranded with end sleeve	mm ²	2 × (0.5 ... 1.5)							
Tightening torque , contact block	Nm	0.8 ... 1.0							
Protective conductor connection inside enclosure		—			M3.5			—	

¹⁾ For twist actuators with spring rod and rod actuators: IP65/IP67.

²⁾ For the maximum number of connectable conductors for the respective contact block see operating instructions.

SIRIUS 3SE5 International Limit Switches

3SE5, plastic enclosures – Enclosure widths 31 mm and 50 mm

Configuration

Actuation and operating travel (angle) for enclosure width 31 mm and 50 mm

Operation by bar (standard)	Slow-action contacts	Snap-action contacts
<ul style="list-style-type: none"> ○ Operating point acc. to EN 50047 (snap-action) * Operating point on return (snap-action) ⊕ Positive opening acc. to EN 60947-5-1 → Direction of operation v_{max} Max. actuating speed ■ Contact closed □ Contact open 	1 NO + 1 NC Ident. No. 11	1 NO + 1 NC Ident. No. 11
	1 NO + 2 NC Ident. No. 12	1 NO + 2 NC Ident. No. 12

Rounded plungers, type B

3SE5 2...-C05

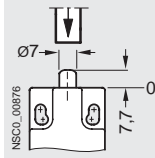

v_{max} = 1 m/s
 Minimum force required in direction of operation: 18 N

Actuation along plunger axis		Actuation along plunger axis			
-BC05 Ident. No. 11	-KC05 Ident. No. 12	-CC05, -HC05 Ident. No. 11	-FC05 Ident. No. 11	-GC05 Ident. No. 11	-LC05 Ident. No. 12

Angular roller levers

3SE5 2...-F1.

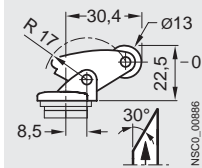

v_{max} = 1 m/s
 Minimum force required in direction of operation: 9 N

Actuation along plunger axis		Actuation along plunger axis			
-BF10 Ident. No. 11	-KF10 Ident. No. 12	-HF10 Ident. No. 11	-FC05 + head¹⁾ Ident. No. 11	-GC05 + head¹⁾ Ident. No. 11	-LF10 Ident. No. 12

Operation by bar (standard)

- Operating point acc. to EN 50047 (snap-action)
- * Operating point on return (snap-action)
- ⊕ Positive opening acc. to EN 60947-5-1
- Direction of operation
- v_{max} Max. actuating speed
- Contact closed
- Contact open

Slow-action contacts

- Contact closed
- Contact open

Snap-action contacts

- Contact closed
- Contact open

Roller plungers

3SE5 2...-D03, -D04 3SE5 2...-D10, -D11

Form C

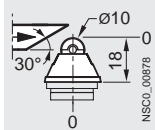

Central fixing

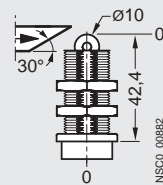

v_{max} = 1 m/s
 Minimum force required in direction of operation: 18 N

Lateral actuation		Lateral actuation	
1 NO + 1 NC Ident. No. 11	3SE5 2...-BD03 Ident. No. 11	1 NO + 1 NC Ident. No. 11	3SE5 2...-HD03, -HD10 Ident. No. 11
1 NO + 2 NC Ident. No. 12	3SE5 2...-KD03, -KD10 Ident. No. 12	1 NO + 1 NC Ident. No. 11	3SE5 2...-FC05 + head¹⁾ Ident. No. 11
		1 NO + 2 NC Ident. No. 12	3SE5 2...-LD03 Ident. No. 12

¹⁾ The basic switch and actuator head/actuator head must be ordered separately.

SIRIUS 3SE5 International Limit Switches

3SE5, plastic enclosures – Enclosure widths 31 mm and 50 mm

Configuration

Actuation and operating travel (angle) for enclosure width 31 mm and 50 mm

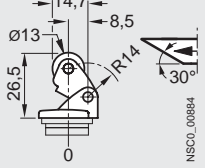
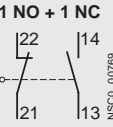
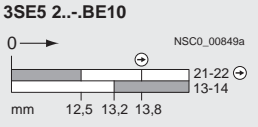
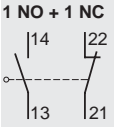
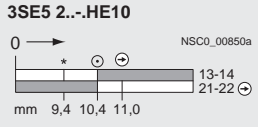
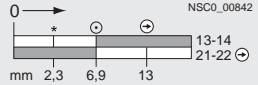
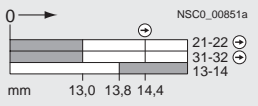
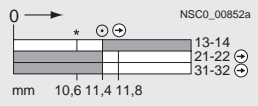
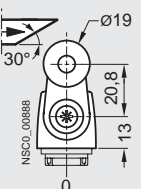
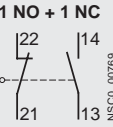
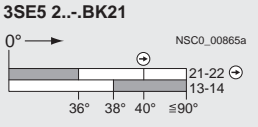
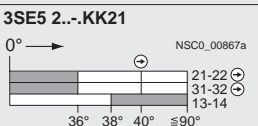
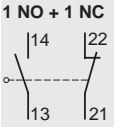
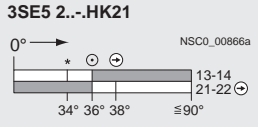
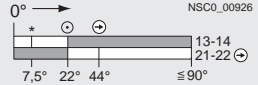
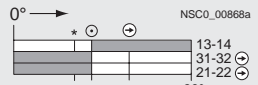
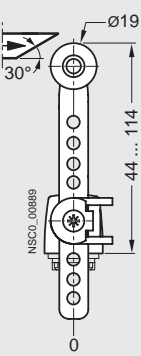
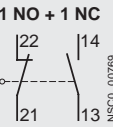
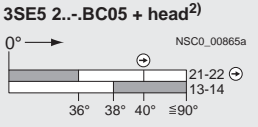
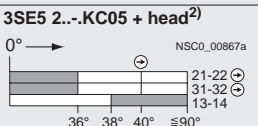
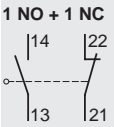
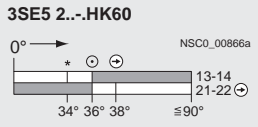
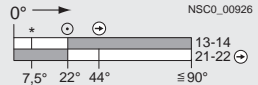
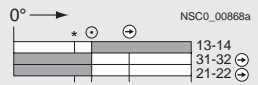
Operation by bar (standard) ○ Operating point acc. to EN 50047 (snap-action) * Operating point on return (snap-action) ⊕ Positive opening acc. to EN 60947-5-1 → Direction of operation v_{max} Max. actuating speed	Slow-action contacts ■ Contact closed □ Contact open	Snap-action contacts ■ Contact closed □ Contact open
Roller levers, type E 3SE5 2...-E1.  $v_{max} = 1 \text{ m/s}$ Minimum force required in direction of operation: 9 N	Lateral actuation 1 NO + 1 NC  Ident. No. 11 3SE5 2...-BE10  Ident. No. 11	Lateral actuation 1 NO + 1 NC  Ident. No. 11 3SE5 2...-HE10  Ident. No. 11 3SE5 2...-FC05 + head²⁾  Short stroke Ident. No. 11 3SE5 2...-KE10  Ident. No. 12 3SE5 2...-LE10  Ident. No. 12
Twist levers¹⁾, type A 3SE5 2...-K2.  $v_{max} = 1.5 \text{ m/s}$ Minimum torque in direction of operation: 0.25 Nm	Deflection in direction of rotation 1 NO + 1 NC  Ident. No. 11 3SE5 2...-BK21  Ident. No. 11 3SE5 2...-KK21  Ident. No. 12	Deflection in direction of rotation 1 NO + 1 NC  Ident. No. 11 3SE5 2...-HK21  Ident. No. 11 3SE5 2...-FC05 + head²⁾  Short stroke Ident. No. 11 3SE5 2...-LK21  Ident. No. 12
Twist levers¹⁾, adjustable length 3SE5 2...-K6.  $v_{max} = 1.5 \text{ m/s}$ Minimum torque in direction of operation: 0.25 Nm	Deflection in direction of rotation 1 NO + 1 NC  Ident. No. 11 3SE5 2...-BC05 + head²⁾  Ident. No. 11 3SE5 2...-KC05 + head²⁾  Ident. No. 12	Deflection in direction of rotation 1 NO + 1 NC  Ident. No. 11 3SE5 2...-HK60  Ident. No. 11 3SE5 2...-FC05 + head²⁾  Short stroke Ident. No. 11 3SE5 2...-LC05 + head²⁾  Ident. No. 12

¹⁾ Adjustment of the lever in increments of 10°, maximum deflection 90°.

²⁾ The basic switch and actuator head must be ordered separately.

SIRIUS 3SE5 International Limit Switches

3SE5, plastic enclosures – Enclosure widths 31 mm and 50 mm

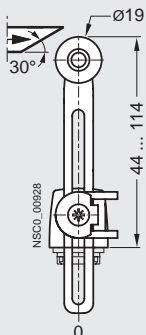
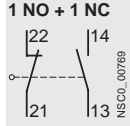
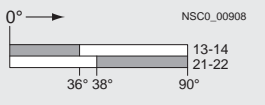
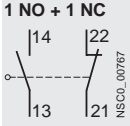
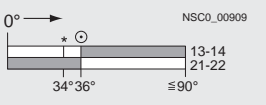
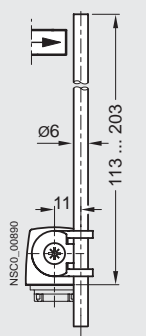
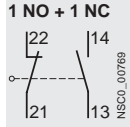
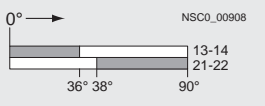
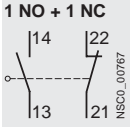
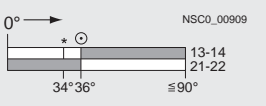
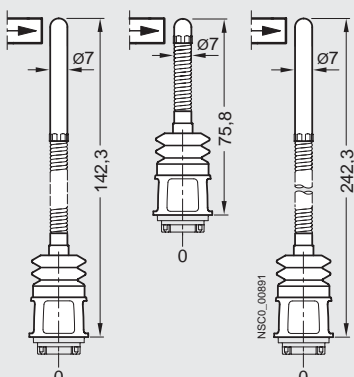
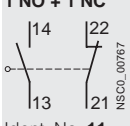
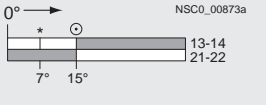
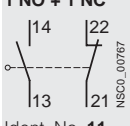
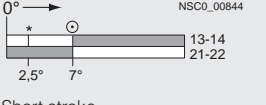
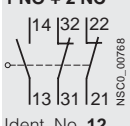
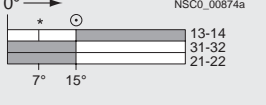
Operation by bar (standard) ○ Operating point acc. to EN 50041/47 (snap-action) * Operating point on return (snap-action) ⊕ Positive opening acc. to EN 60947-5-1 → Direction of operation v_{max} Max. actuating speed	Slow-action contacts ■ Contact closed □ Contact open	Snap-action contacts ■ Contact closed □ Contact open
Twist levers¹⁾, adjustable length 3SE5 2...-K5.  <p>$v_{max} = 1.5$ m/s Minimum torque in direction of operation: 0.25 Nm</p>	1 NO + 1 NC  Ident. No. 11 3SE5 2...-BK50  NSCO_00908 13-14, 21-22	1 NO + 1 NC  Ident. No. 11 3SE5 2...-HK50  NSCO_00909 13-14, 21-22
Rod actuators¹⁾, type D 3SE5 2...-K8.  <p>$v_{max} = 1.5$ m/s Minimum torque in direction of operation: 0.25 Nm</p>	1 NO + 1 NC  Ident. No. 11 3SE5 2...-BC05 + head²⁾  NSCO_00908 13-14, 21-22	1 NO + 1 NC  Ident. No. 11 3SE5 2...-HK80, -HK82  NSCO_00909 13-14, 21-22
Spring rods 3SE5 2...-R0.  <p>$v_{max} = 1$ m/s Minimum force required in direction of operation: 9 N</p>	The spring rods can be used only with snap-action contacts.	1 NO + 1 NC  Ident. No. 11 3SE5 2...-HR01  NSCO_00873a 13-14, 21-22
		1 NO + 1 NC  Ident. No. 11 3SE5 2...-FC05 + head²⁾  NSCO_00844 13-14, 21-22
		1 NO + 2 NC  Ident. No. 12 3SE5 2...-LC05 + head²⁾  NSCO_00874a 13-14, 31-32, 21-22

¹⁾ Adjustment of the lever in increments of 10°, maximum deflection 90°.

²⁾ The basic switch and actuator head must be ordered separately.

SIRIUS 3SE5 International Limit Switches

3SE5, metal enclosures – Enclosure widths 40 mm and 56 mm

Configuration

Actuation and operating travel (angle) for enclosure width 40 mm and 56 mm

Operation by bar (standard)	Slow-action contacts	Snap-action contacts		
<ul style="list-style-type: none"> Operating point acc. to EN 50041 (snap-action) * Operating point on return (snap-action) Positive opening acc. to EN 60947-5-1 → Direction of operation v_{max} Max. actuating speed Contact closed Contact open 	1 NO + 1 NC Ident. No. 11	1 NO + 2 NC Ident. No. 12	1 NO + 1 NC Ident. No. 11	1 NO + 2 NC Ident. No. 12

Rounded plungers, type B	Actuation along plunger axis		Actuation along plunger axis	
3SE5 1...-C02 $v_{max} = 1.5 \text{ m/s}$ Minimum force required in direction of operation: 18 N	3SE5 1...-BC02 Ident. No. NSCO_00831a	3SE5 1...-KC02 Ident. No. NSCO_00833a	3SE5 1...-CC02 Ident. No. NSCO_00832a	3SE5 1...-LC02 Ident. No. NSCO_00834a

Angular roller levers	Actuation along plunger axis		Actuation along plunger axis	
3SE5 112...F0. $v_{max} = 2.5 \text{ m/s}$ Minimum force required in direction of operation: 9 N	3SE5 1...-BF01 Ident. No. NSCO_00861a	3SE5 1...-KA00 + head¹⁾ Ident. No. NSCO_00863a	3SE5 1...-CF01 Ident. No. NSCO_00862a	3SE5 1...-LF01 Ident. No. NSCO_00864a

Operation by bar (standard)	Slow-action contacts	Snap-action contacts	
<ul style="list-style-type: none"> Operating point acc. to EN 50041 (snap-action) * Operating point on return (snap-action) Positive opening acc. to EN 60947-5-1 → Direction of operation v_{max} Max. actuating speed Contact closed Contact open 			

Roller plungers, type C	Lateral actuation		Lateral actuation	
3SE5 1...-D02 $v_{max} = 1 \text{ m/s}$ Minimum force required in direction of operation: 18 N	1 NO + 1 NC Ident. No. 11	3SE5 1...-BD02 Ident. No. NSCO_00845a	1 NO + 1 NC Ident. No. 11	3SE5 1...-CD02 Ident. No. NSCO_00846a
	1 NO + 2 NC Ident. No. 12	3SE5 1...-KD02 Ident. No. NSCO_00847a	1 NO + 2 NC Ident. No. 12	3SE5 1...-LD02 Ident. No. NSCO_00848a

¹⁾ The basic switch and actuator head must be ordered separately.

SIRIUS 3SE5 International Limit Switches

3SE5, plastic enclosures – Enclosure widths 31 mm and 50 mm

Configuration

Actuation and operating travel (angle) for enclosure width 40 mm and 56 mm

Operation by bar (standard)

- ⊙ Operating point acc. to EN 50041 (snap-action)
- * Operating point on return (snap-action)
- ⊕ Positive opening acc. to EN 60947-5-1
- Direction of operation
- v_{max} Max. actuating speed

Slow-action contacts

- Contact closed
- Contact open

Snap-action contacts

- Contact closed
- Contact open

Roller levers

3SE5 1...-E0.

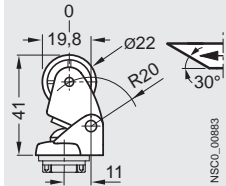

$v_{max} = 2.5$ m/s
Minimum force required in direction of operation: 9 N

Lateral actuation

1 NO + 1 NC

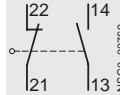

Ident. No. 11

Lateral actuation

3SE5 1...-BE01

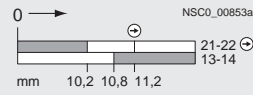

Ident. No. 11

Lateral actuation

1 NO + 1 NC

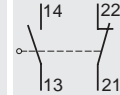

Ident. No. 11

Lateral actuation

3SE5 1...-GE01

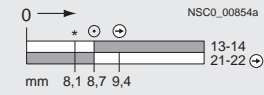

Ident. No. 11

1 NO + 2 NC

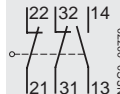

Ident. No. 12

3SE5 1...-KE01

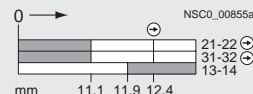

Ident. No. 12

1 NO + 2 NC

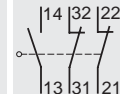

Ident. No. 12

3SE5 1...-LE01



Ident. No. 12

Twist levers¹⁾, type A

3SE5 1...-H0.

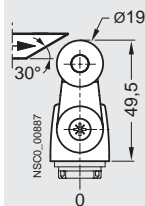

$v_{max} = 1.5$ m/s
Minimum torque in direction of operation: 0.25 Nm

1 NO + 1 NC

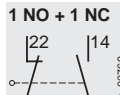

Ident. No. 11

Deflection in direction of rotation

3SE5 1...-BH01

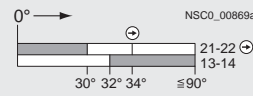

Ident. No. 11

1 NO + 1 NC

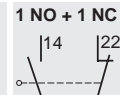

Ident. No. 11

Deflection in direction of rotation

3SE5 1...-CH01

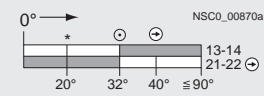

Ident. No. 11

1 NO + 2 NC

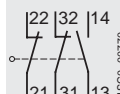

Ident. No. 12

3SE5 1...-KH01

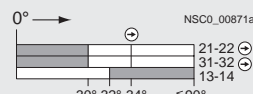

Ident. No. 12

1 NO + 2 NC

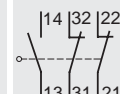

Ident. No. 12

3SE5 1...-LH01

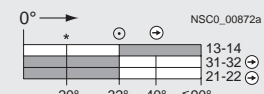

Ident. No. 12

Twist levers¹⁾, adjustable length

3SE5 1...-H6.

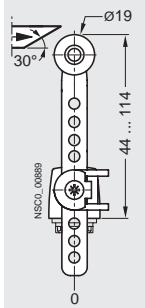

$v_{max} = 1.5$ m/s
Minimum torque in direction of operation: 0.25 Nm

1 NO + 1 NC

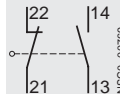

Ident. No. 11

Deflection in direction of rotation

3SE5 1...-BH60

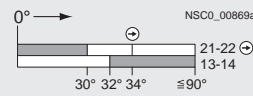

Ident. No. 11

1 NO + 1 NC

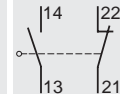

Ident. No. 11

Deflection in direction of rotation

3SE5 1...-CH60

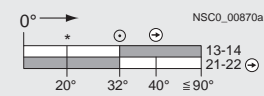

Ident. No. 11

1 NO + 2 NC

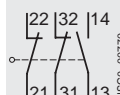

Ident. No. 12

3SE5 1...-KA00 + head²⁾

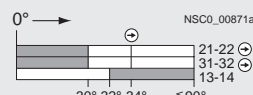

Ident. No. 12

1 NO + 2 NC

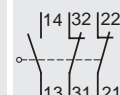

Ident. No. 12

3SE5 1...-LH60

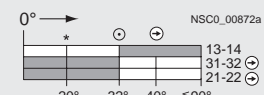

Ident. No. 12

Fork levers¹⁾

3SE5 1...-T1.

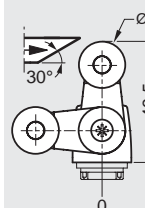

$v_{max} = 1.5$ m/s
Minimum torque in direction of operation: 0.25 Nm

The fork levers can be used only with snap-action contacts.

1 NO + 1 NC

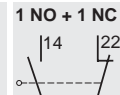

Ident. No. 11

Deflection in direction of rotation

3SE5 1...-CT11

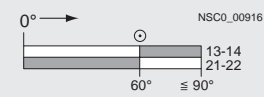

Ident. No. 11

1 NO + 2 NC

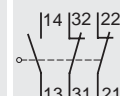

Ident. No. 12

3SE5 1...-LA00 + head²⁾

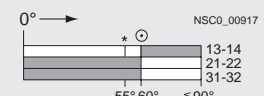

Ident. No. 12

¹⁾ Adjustment of the lever in increments of 10°, maximum deflection 90°.

²⁾ The basic switch and actuator head must be ordered separately.

SIRIUS 3SE5 International Limit Switches

3SE5, metal enclosures – Enclosure widths 40 mm and 56 mm

Operation by bar (standard)

- Operating point acc. to EN 50041/47 (snap-action)
- * Operating point on return (snap-action)
- ⊕ Positive opening acc. to EN 60947-5-1
- Direction of operation
- v_{ma} Max. actuating speed

Twist levers¹⁾, adjustable length

3SE5 1...-H5.

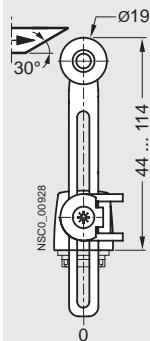

$v_{max} = 1.5$ m/s
Minimum torque in direction of operation: 0.25 Nm

Rod actuators¹⁾, type D

3SE5 1...-H8.

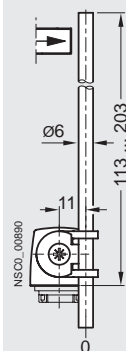

$v_{max} = 1.5$ m/s
Minimum torque in direction of operation: 0.25 Nm

Spring rods

3SE5 1...-R0.

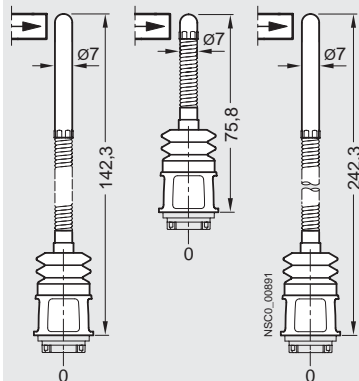

$v_{max} = 1$ m/s
Minimum force required in direction of operation: 9 N

Slow-action contacts

- Contact closed
- Contact open

1 NO + 1 NC

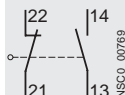

Ident. No. 11

1 NO + 2 NC

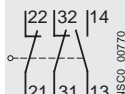

Ident. No. 12

Deflection in direction of rotation

3SE5 1...-BH50

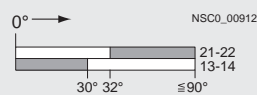

3SE5 1...-KA00 + head²⁾

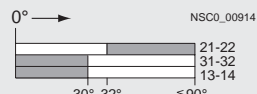

Snap-action contacts

- Contact closed
- Contact open

1 NO + 1 NC

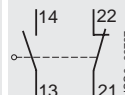

Ident. No. 11

1 NO + 2 NC

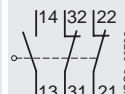

Ident. No. 12

Deflection in direction of rotation

3SE5 1...-CH50, -CH51

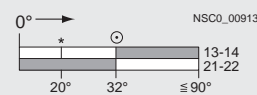

3SE5 1...-LH50

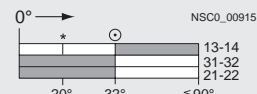

1 NO + 1 NC

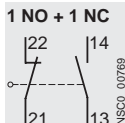

Ident. No. 11

1 NO + 2 NC

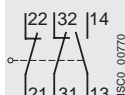

Ident. No. 12

Deflection in direction of rotation

3SE5 1...-BA00 + head²⁾

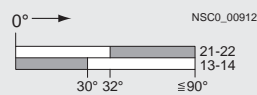

3SE5 1...-KA00 + head²⁾

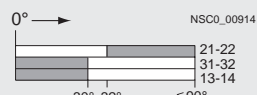

1 NO + 1 NC

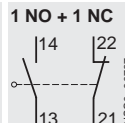

Ident. No. 11

1 NO + 2 NC

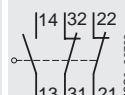

Ident. No. 12

Deflection in direction of rotation

3SE5 1...-CH80, -CH82

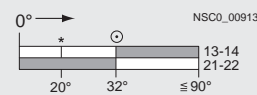

3SE5 1...-LA00 + head²⁾

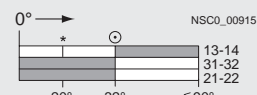

The spring rods can be used only with snap-action contacts.

1 NO + 1 NC



Ident. No. 11

1 NO + 2 NC

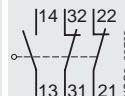

Ident. No. 12

Deflection of spring rod

3SE5 1...-CR01

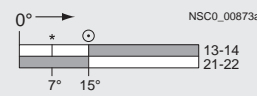

3SE5 1...-LA00 + head²⁾

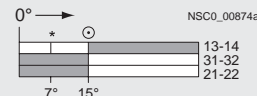

¹⁾ Adjustment of the lever in increments of 10°, maximum deflection 90°.

²⁾ The basic switch and actuator head must be ordered separately.

SIRIUS 3SE5 International Limit Switches

Dimensional drawings

Dimensions of the basic switches

Enclosure width 31 mm, EN 50047, with M20 x 1.5 connecting thread 3SE5 232, 3SE5 212

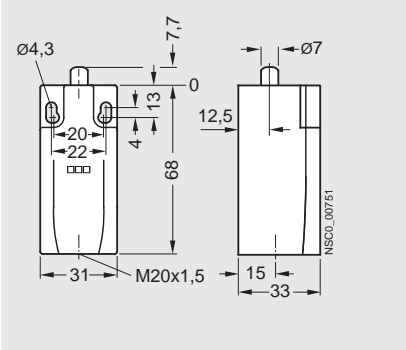

Enclosure width 31 mm, EN 50047, rear with fixing holes 3SE5 232, 3SE5 212

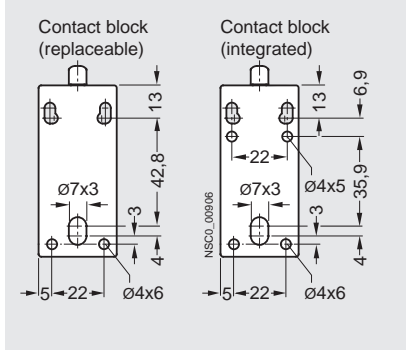

Enclosure width 31 mm, EN 50047, with M12 connector socket 3SE5 234, 3SE5 212

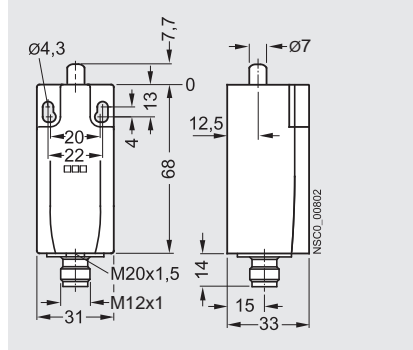

Enclosure width 50 mm, with M20 x 1.5 connecting thread 3SE5 242

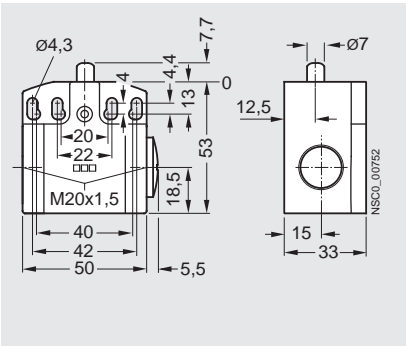

Enclosure width 50 mm, rear with fixing holes 3SE5 242

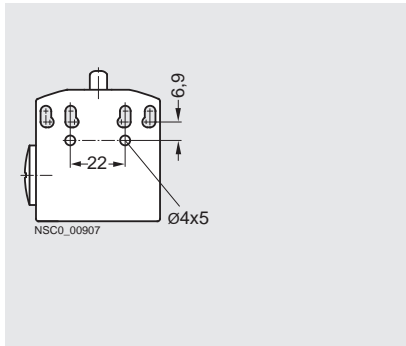

Enclosure width 40 mm, EN 50041, with M20 x 1.5 connecting thread 3SE5 112, 3SE5 132

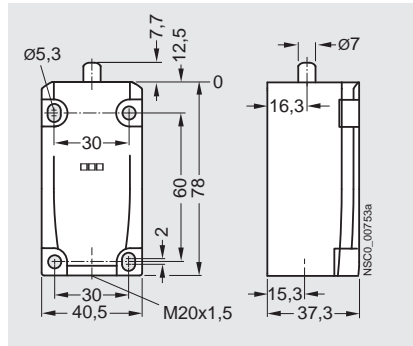

Enclosure width 40 mm, EN 50041, with 6-pole connector socket 3SE5 115

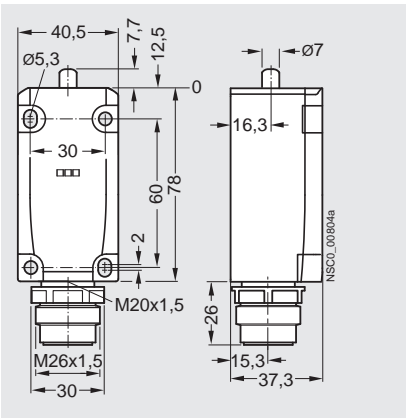

Enclosure width 56 mm, with M20 x 1.5 connecting thread 3SE5 122

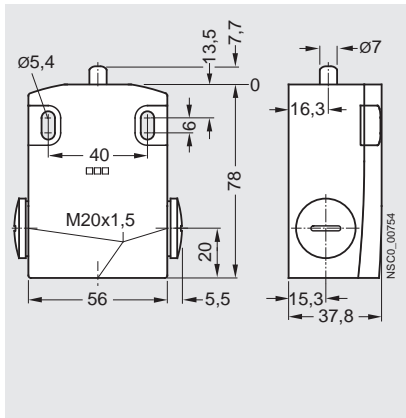

XL enclosure, width 56 mm, with M20 x 1.5 connecting thread 3SE5 162

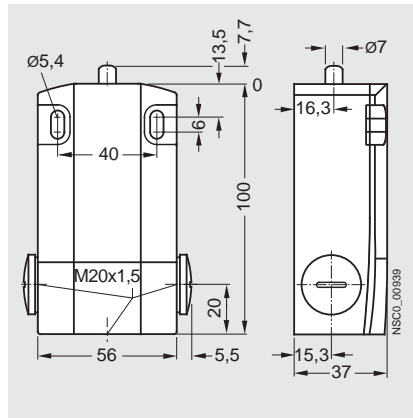

Operating mechanisms for basic switches, see pages 13/59 and 13/60.

SIRIUS 3SE5 International Limit Switches

3SE5, open-type design

Operating mechanisms for enclosure width 31 mm and 50 mm

Roller plunger, type C acc. to EN 50047

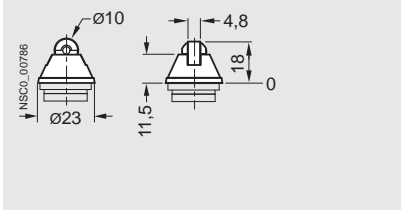

Roller plunger with central fixing

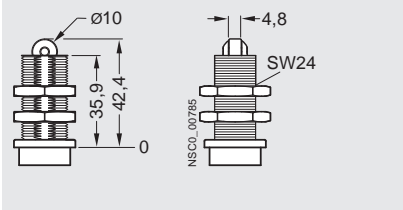

Roller lever, type E acc. to EN 50047

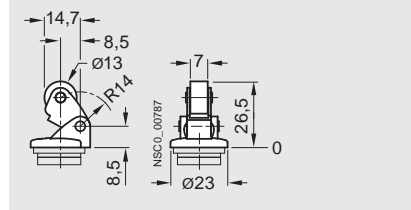

Angular roller lever

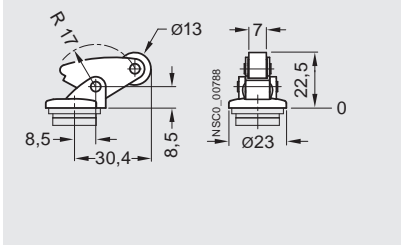

Twist lever, type A acc. to EN 50047

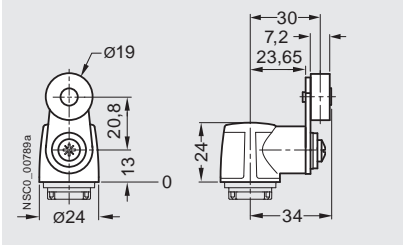

Twist lever, roller 30 mm

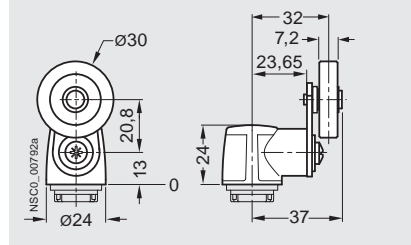

Operating mechanism for enclosure width 40 mm and 56 mm

Plain plunger



Rounded plunger, type B acc. to EN 50041

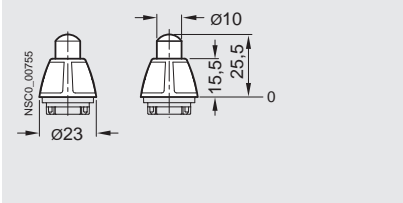

Roller plunger, type C acc. to EN 50041

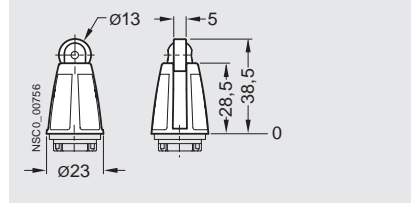

Roller lever

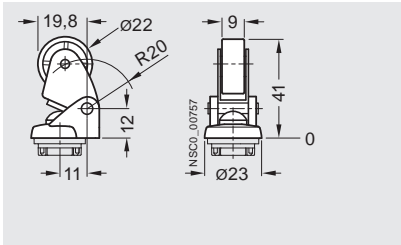

Angular roller lever

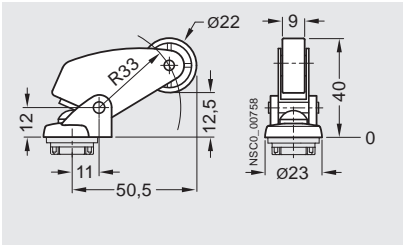

Twist lever, type A acc. to EN 50041

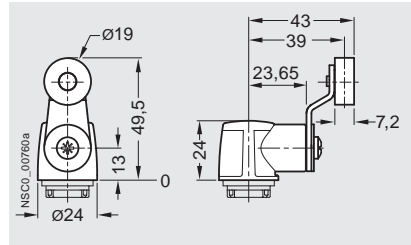

Twist lever, 2 rollers 19 mm

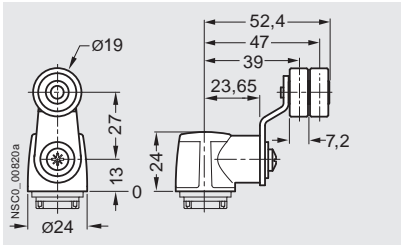

Fork lever, roller 19 mm

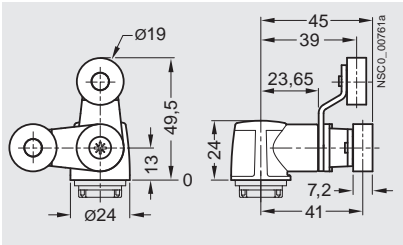

Twist lever, roller 30 mm

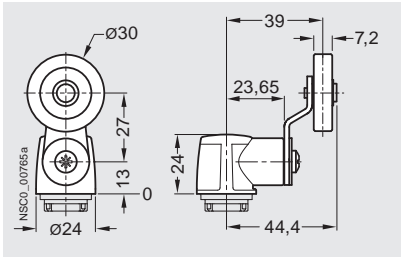

Twist lever, roller 50 mm

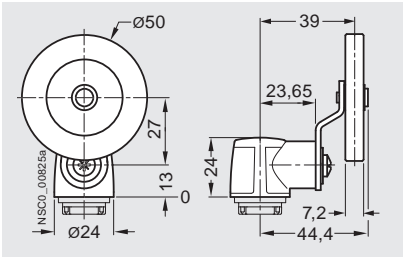

Twist lever, rubber roller 50 mm

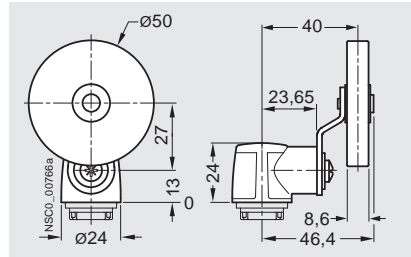

SIRIUS 3SE5 International Limit Switches

Dimensional drawings

Operating mechanisms for all enclosure widths

Twist lever, adjustable length, roller 19 mm

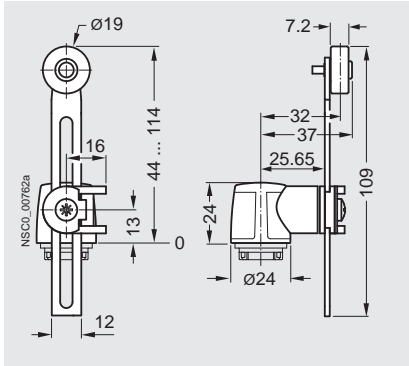

Twist lever, adjustable length, with grid hole, roller 19 mm

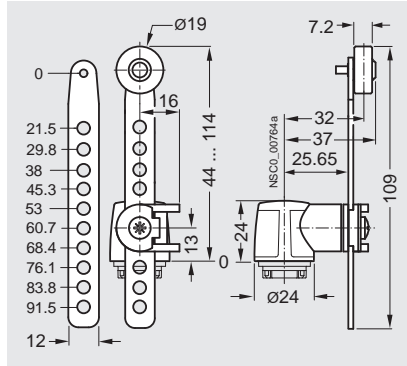

Twist lever, adjustable length, roller 30 mm

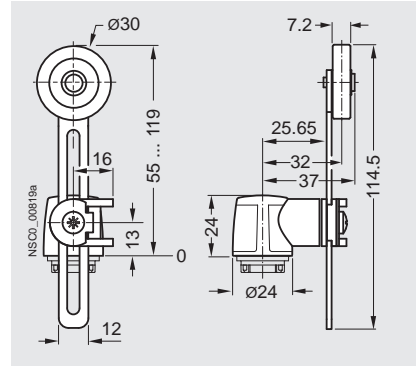

Twist lever, adjustable length, roller 50 mm

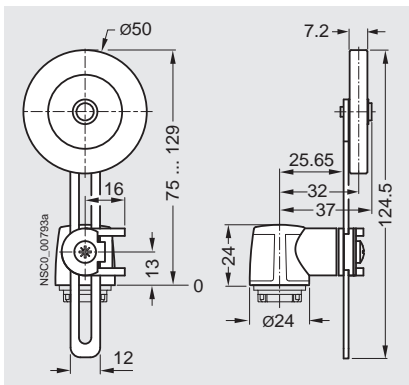

Twist lever, adjustable length, rubber roller 50 mm

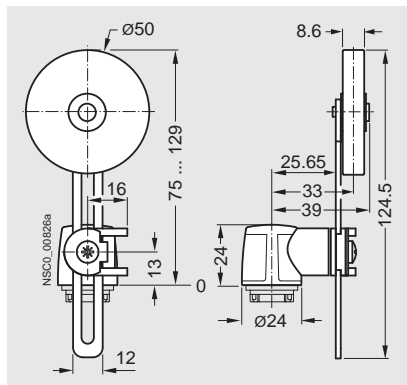

Twist lever, adjustable length, with grid hole, rubber roller 50 mm

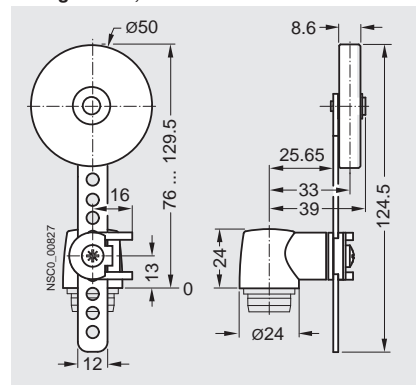

Rod actuator

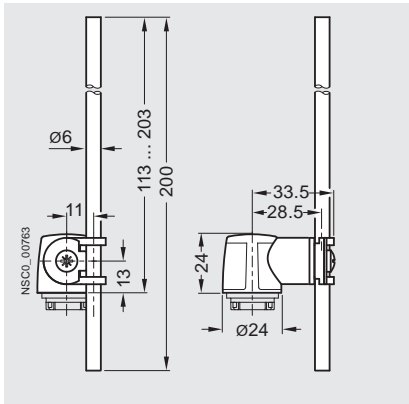

Spring rod, length 142.5 mm

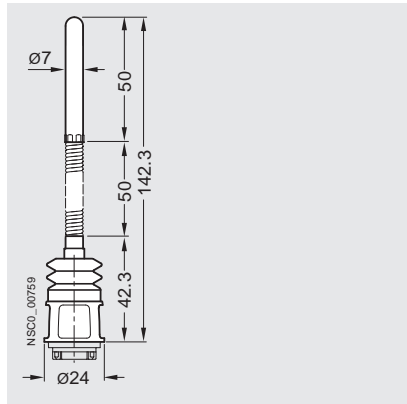

Spring rod, length 242.5 mm

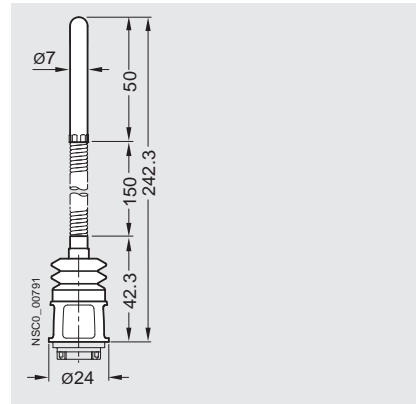

Spring rod, length 76 mm

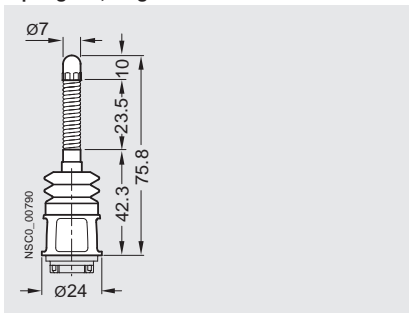

SIRIUS 3SE5 International Limit Switches

Dimensional drawings

Circuit diagrams

Enclosure widths 31, 40, 50 and 56 mm

Slow-action contacts
1 NO + 1 NC
3SE5 ...-B..., -R...

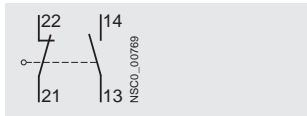

Slow-action contacts
2 NO + 1 NC
3SE5 ...-P...

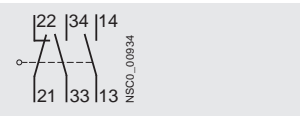

Snap-action contacts
1 NO + 1 NC
3SE5 ...-C..., -F..., -G..., -H..., -N...

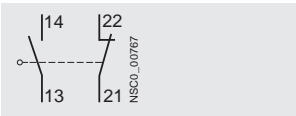

Slow-action contacts
1 NO + 2 NC
3SE5 ...-K..., -Q...

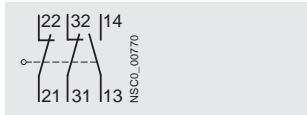

Slow-action contacts
1 NO + 2 NC with make-before-break, 3SE5 ...-M...

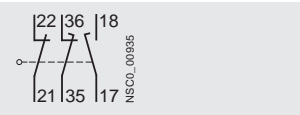

Snap-action contacts
1 NO + 2 NC
3SE5 ...-L...

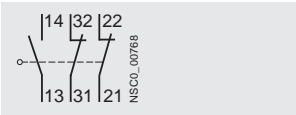

XL enclosures, width 56 mm

Slow-action contacts
2 x (1 NO + 1 NC)
3SE5 162-0B...

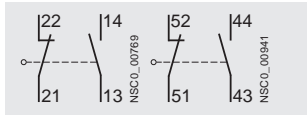

Slow-action contacts
2 x (1 NO + 2 NC) with make-before-break, 3SE5 162-0D...

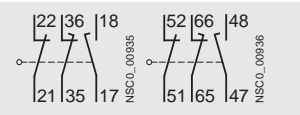

For slow-action contacts
1 NO + 2 NC with make-before-break, 1 NO + 1 NC, 3SE5 162-0E...

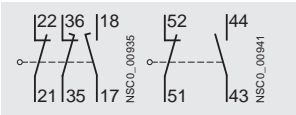

Snap-action contacts
2 x (1 NO + 1 NC)
3SE5 162-0C...

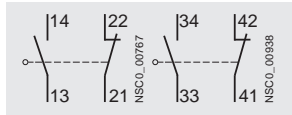

3SE5 connector assignment

M12 connector socket, 4-pole
3SY3 127

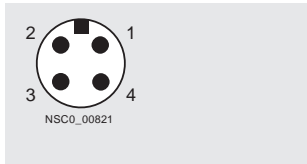

M12 connector socket, 5-pole
3SY3 128

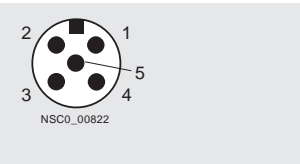

M12 connector socket, 8-pole
3SY3 134

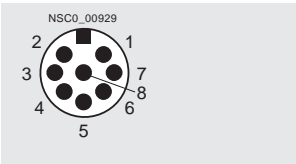

Connector sockets, 6-pole + PE
3SY3 131

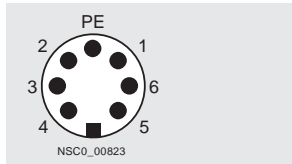

Order No.	Connector sockets		LEDs	Connections								
	Type	Version		Pin 1	Pin 2	Pin 3	Pin 4	Pin 5	Pin 6	Pin 7	Pin 8	PE
M12 connector sockets (4-, 5- or 8-pole)												
3SE5..4-0....-1AC4	3SY3 127	1 NO + 1 NC	—	21	22	13	14	—	—	—	—	—
3SE5..4-0....-1AC5	3SY3 128	1 NO + 1 NC	—	21	22	13	14	PE	—	—	—	—
3SE5..4-0....-1AE0	3SY3 127	2 NC	—	21	22	31	32	—	—	—	—	—
3SE5..4-0....-1AE1	3SY3 128	2 NC	—	21	22	31	32	PE	—	—	—	—
3SE5..4-1C....-1AF3	3SY3 128	1 NO + 1 NC snap action	2 LEDs	21	22	13 / LED gn	14 / LED ye	Ground LED	—	—	—	—
3SE5..4-1B....-1AF3	3SY3 128	1 NO + 1 NC slow-action	2 LEDs	21	22	14 / LED gn	13 / LED ye	Ground LED	—	—	—	—
3SE5..4-1L....-1AD4	3SY3 134	1 NO + 2 NC snap action	2 LEDs	21	22	13 / LED gn	14 / LED ye	31	32	Ground LED	PE	—
3SE5..4-1K....-1AD4	3SY3 134	1 NO + 2 NC slow-action	2 LEDs	21	22	14 / LED gn	13 / LED ye	31	32	Ground LED	PE	—
Connector sockets, 6-pole + PE												
3SE5..5-0....-1AD0	3SY3 131	1 NO + 1 NC	—	21	22	13	14	—	—	—	—	✓
3SE5..5-0....-1AD1	3SY3 131	1 NO + 2 NC	—	21	22	13	14	31	32	—	—	✓
3SE5..5-C....-1AF2	3SY3 131	1 NO + 1 NC snap action	2 LEDs	21	22	13 / LED gn	14 / LED ye	—	Ground LED	—	—	✓
3SE5..5-B....-1AF2	3SY3 131	1 NO + 1 NC slow-action	2 LEDs	21	22	14 / LED gn	13 / LED ye	—	Ground LED	—	—	✓
3SE5..5-L....-1AD2	3SY3 131	2 NC snap-action	2 LEDs	21	22	31	32	13 / LED gn	Ground LED	—	—	✓
3SE5..5-K....-1AD2	3SY3 131	2 NC slow-action	2 LEDs	21	22	31	32	14 / LED gn	Ground LED	—	—	✓

gn Green
ye Yellow

✓ Connected
— Not available

3SE03 North American Limit Switches

General Information

Features

Modular plug-in



Prewired receptacle with pin connector



Prewired cable



Features

- UL Listed, CSA Certified.
- UL File: E47512
- All Metal Captive Screws.
- Keyed, Four-Directional Head.
- Steel-Reinforced Diaphragm Seal Between Operational Head And Switch Body.
- Permanent Instructions for Adjusting Operational Head.
- Modular, Plug-In Housing
 1. Heavy-Duty, Bifurcated, Plug-In Prongs.
 2. Ample Receptacle Wiring Space with 1/2" NPT threaded conduit opening.
 3. Stepped Terminals On Single Pole; Deep Center Trough On Double Pole.
- NEMA Type 6P Submersible
 1. Completely Sealed With Epoxy.
 2. SOOW-A Cable or Prewired Receptacle With Pin Connector.
 3. Factory wired cable features a 350 pound pullput capacity.
- Rotary heads are field convertible CW, CCW, or both without special tools.

Design

Modular Plug-In Housing

These heavy duty plug-in limit switches may be provided as complete devices using a composite catalog number; or, separately as components; operating head, plug-in module and base receptacle.

Example:

Complete Switch:

3SE03-AR1

Single Pole, Double Throw contacts with Side Rotary, Momentary Head

Components

3SE03-SA⓪

Single Pole, Double Throw Plug-in Module

3SE03-DR1

Side Rotary Head, Momentary

3SE03-RA⓪

Standard, Single Pole Receptacle, 1 NO + 1 NC

Since components may be interchanged, operating heads, plug-in modules and receptacles may be combined to satisfy most of your everyday limit switch requirements. This leads to less inventory with greater flexibility.

Operating heads include side rotary; plain and roller plunger; and, wobble. A variety of levers are available.

The zinc die-cast housing has an epoxy finish to protect against corrosion. All screws on the module and head are captive.

NEMA Type 6P Submersible

These heavy duty prewired, factory sealed switches meet the demanding enclosure requirements of UL (NEMA) Type 3, 4, 4X, 6P, 12, and 13. They are intended for wet environments where the integrity of the threaded conduit and switch body seals must be assured.

The switch body cavity including threaded conduit entry is completely sealed with epoxy. An 8 foot, 5 or 9 conductor SOOW-A cable; or 5 or 9 pin prewired receptacle with pin connector is provided as standard.

Switches are provided as complete devices using composite catalog numbers; or, separately as components; operating head and switch body.

UL (NEMA) Type 6P switches are designed to provide a degree of protection against the entry of water during prolonged submersion at limited depths (tested with a 6 foot head of water for 24 hours).

Both the Modular Plug-in and the (NEMA) Type 6P Submersible styles provide 60 Amp make and 6 Amp break—120V AC and 10 Amp continuous current for 120, 240, 480 and 600V AC. The circuit contact configuration depends on the device selected and the application criteria.

Switches are available with momentary or maintained operating heads; and, single pole, double pole or center neutral (modular, plug-in only) contact configurations.

3SE03 limit switches offer a new standard of reliability and quality in automatic control circuits under heavy duty applications.

⓪ Plug-in module and receptacle are keyed.

3SE03 North American Limit Switches

Modular, plug-in and NEMA type 6P submersible

Technical data

Type	Modular, Plug-in and NEMA Type 6P Submersible					
Mechanical life	Side rotary: 13×10^6 make-break operations minimum All others: 10×10^6 make-break operations minimum					
Electrical life	Single Pole: 1×10^6 operations typical at full load Double Pole: 1×10^5 operations typical at full load					
Switching frequency	8×10^3 make-break operations per hour (maximum)					
Operating point accuracy	Side operated: 0.0012 in. (modular, plug-in housing) Side rotary: 0.0014 in. (modular plug-in). Top operated: 0.0003 in. (modular, plug-in housing)					
Cable entry	1/2 in.-NPT, Prewired Cable or Prewired Receptacle with Pin Connector					
Ambient temperature	Without Cable: -10° to $+121^\circ\text{C}$, 14° to 250°F With Cable: -10° to $+105^\circ\text{C}$, 14° to 221°F					
Degree of protection	NEMA Type 1, 3, 3S, 4, 4X, 6, 6P, 13; IP67					
Conductor size	22–12 AWG (modular, plug-in housing), single or stranded wire 5 or 9 conductor, 16 AWG yellow jacketed type SOOW-A cable (prewired cable) 5 or 9 pin, 0.87 in. (22 mm) diameter receptacle (prewired receptacle with pin connector)					
Mounting	Any position					
Tightening Torque	Switch body screws: 25–30 lb-in. Operating head screws: 14–18 lb-in.					
NEMA rating	DC, NEMA R300		AC, NEMA A600			
Maximum current at	125V	250V	120V	240V	480V	600V
Make	0.22A	0.11A	60A	30A	15A	12A
Break	0.22A	0.11A	6A	3A	1.5A	1.2A
Max. volt-ampere						
Make	28VA	28VA	7200VA	7200VA	7200VA	7200VA
Break	28VA	28VA	720VA	720VA	720VA	720VA
Rated thermal current	DC, 1A		AC, 10A			
Rated operating voltage	DC, 300V		AC, 600V			

Operating temperature ^{1) 2)}

Temperature rating	Operation		Temperature range	
	Type	Return	Without cable	With cable
1	Side rotary ³⁾	Momentary CW only or CCW only	10°F to 200°F -12°C to 94°C	10°F to 200°F -12°C to 94°C
2	Center neutral Side rotary Side plunger Two-sided plunger Roller side plunger ⁴⁾	Momentary CW or CCW Maintained Momentary Maintained Momentary	14°F to 200°F -10°C to 94°C	14°F to 200°F -10°C to 94°C
3	Top plunger Top roller plunger ⁴⁾ Wobble head	Momentary Momentary Momentary	14°F to 250°F -10°C to 121°C	14°F to 221°F -10°C to 105°C

1) Temperature ranges below $+32^\circ\text{F}$ (0°C) are based on absence of freezing moisture or water.

2) For temperature rating of specific switch, refer to page 13/70, Operating Heads.











3) For CW only or CCW only operation, upper temperature limit increases to 250°F (121°C) without cable, and 221°F (105°C) with pre-wired cable.

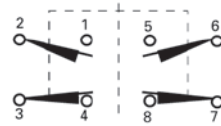



4) Roller direction can be converted in the field.

3SE03 North American Limit Switches

Modular, plug-in metal housing

Complete switches without lever - threaded cable entry:

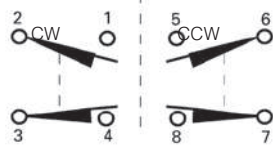
		Standard single pole 1 NO + 1 NC (3SE03-SA)		Standard double pole 2 NO + 2 NC (3SE03-SB)	
		Single pole (3SE03-RA) 		Double pole (3SE03-RB) 	
Composite catalog number consisting of head, module and receptacle					
Operating head type			DT	Catalog Number	List Price \$ 1 unit
	Standard momentary (3SE03-DR1)		▶	3SE03-AR1 ^①	
	Standard maintained (3SE03-DM1)		▶	3SE03-AM1	
	Low torqued momentary (3SE03-DL1)		▶	3SE03-AL1 ^②	
	Momentary (3SE03-DS1)		▶	3SE03-AS1	
	Momentary (3SE03-DS3)		▶	3SE03-AS3	
	Maintained (3SE03-DH1)			3SE03-AH1	
	Momentary (3SE03-DT1)		▶	3SE03-AT1	
	Momentary (3SE03-DT3)			3SE03-AT3	
	Momentary (3SE03-DW1)		▶	3SE03-AW1	

		Center neutral Double pole 2 NO + 2 NC (3SE03-SN)			
		Center neutral (3SE03-RB) 			
Composite catalog number consisting of head, module and receptacle					
Operating head type			DT	Catalog Number	List Price \$ 1 unit
	Center	(3SE03-DN1)	▶	3SE03-NN1 ^①	
	Neutral	(3SE03-DN2)	▶	3SE03-NN2 ^②	

① 5° pretravel to operate contacts.





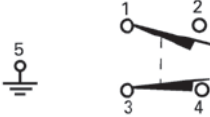
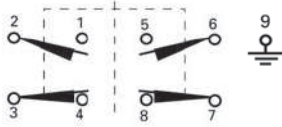

② 15° pretravel to operate contacts.

3SE03 North American Limit Switches

NEMA type 6P submersible, prewired cable

Complete switches without lever - prewired cable:

 <p>Switch body type—prewired cable with 8 foot cable</p>	<p>Single pole 1 NO + 1 NC (3SE03-SA6P)</p> <p>Cable color code 1 - White 2 - Black 3 - Red 4 - Orange 5 - Green</p>	<p>Double pole 2 NO + 2 NC (3SE03-SB6P)</p> <p>Cable color code 1 - White 6 - Pink 2 - Black 7 - Yellow 3 - Red 8 - Blue 4 - Orange 9 - Green 5 - Brown</p>
		





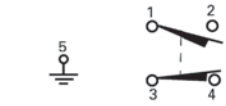
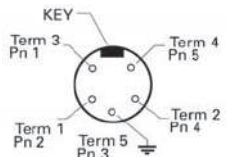
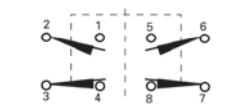
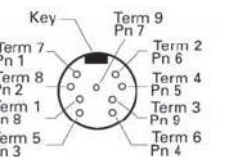

Operating head type		Composite catalog number consisting of head and switch body				
		DT	Catalog Number	List Price \$ 1 unit	Catalog Number	List Price \$ 1 unit
 <p>Side rotary CW and CCW operation convertible to CW only or CCW only</p>	Standard momentary (3SE03-DR1)	▶	3SE03-AR16P		3SE03-BR16P	
	Standard maintained (3SE03-DM1)		3SE03-AM16P		3SE03-BM16P	
	Low torqued momentary (3SE03-DL1)		3SE03-AL16P		3SE03-BL16P	
 <p>Plain side plunger</p>	Momentary (3SE03-DS1)		3SE03-AS16P		3SE03-BS16P	
 <p>Roller side plunger</p>	Momentary (3SE03-DS3)		3SE03-AS36P		3SE03-BS36P	
 <p>Two-sided plunger</p>	Maintained (3SE03-DH1)		3SE03-AH16P		Not available	
 <p>Plain top plunger</p>	Momentary (3SE03-DT1)		3SE03-AT16P		3SE03-BT16P	
 <p>Roller top plunger</p>	Momentary (3SE03-DT3)		3SE03-AT36P		3SE03-BT36P	
 <p>Wobble head (without lever)</p>	Momentary (3SE03-DW1)		3SE03-AW16P		3SE03-BW16P	

3SE03 North American Limit Switches

NEMA type 6P submersible, prewired receptacle

Complete switches without lever - prewired receptacle with pin connector:



 <p>Switch Body Type—prewired receptacle with pin connector</p>	<p>Single pole 1 NO + 1 NC (3SE03-SA6PC)</p>  	<p>Double pole 2 NO + 2 NC (3SE03-SB6PC)</p>  
--	--	--

Operating head type		Composite catalog number consisting of head and switch body				
		DT	Catalog Number	List Price \$ 1 unit	Catalog Number	List Price \$ 1 unit
 <p>Side rotary CW and CCW operation convertible to CW only or CCW only</p>	Standard momentary (3SE03-DR1)	▶	3SE03-AR16PC		3SE03-BR16PC	
	Standard maintained (3SE03-DM1)		3SE03-AM16PC		3SE03-BM16PC	
	Low torqued momentary (3SE03-DL1)		3SE03-AL16PC		3SE03-BL16PC	
 <p>Plain side plunger</p>	Momentary (3SE03-DS1)		3SE03-AS16PC		3SE03-BS16PC	
 <p>Roller side plunger</p>	Momentary (3SE03-DS3)		3SE03-AS36PC		3SE03-BS36PC	
 <p>Two-sided plunger</p>	Maintained (3SE03-DH1)		3SE03-AH16PC		Not available	
 <p>Plain top plunger</p>	Momentary (3SE03-DT1)		3SE03-AT16PC		3SE03-BT16PC	
 <p>Roller top plunger</p>	Momentary (3SE03-DT3)		3SE03-AT36PC		3SE03-BT36PC	
 <p>Wobble head (without lever)</p>	Momentary (3SE03-DW1)		3SE03-AW16PC		3SE03-BW16PC	



3SE03 North American Limit Switches

Modular, plug-in and NEMA type 6P submersible









Components:

 <p>Plug-in module</p>	Plug-in module	DT	Catalog Number	List Price \$ 1 unit
	Standard single pole 1 NO + 1 NC	▶	3SE03-SA	
	Standard double pole 2 NO + 2 NC	▶	3SE03-SB	
	Center neutral 2 NO + 2 NC ^①	▶	3SE03-SN	
 <p>Receptacle</p>	Receptacle for plug-in module		Catalog Number	List Price \$ 1 unit
	Single pole 1 NO + 1 NC (5 terminals)	▶	3SE03-RA	
	Single pole 2 NO + 2 NC (9 terminals)		3SE03-RB	

Switch body—NEMA type 6P submersible:

 <p>Prewired cable</p>  <p>Prewired receptacle</p>		Prewired cable 8 foot length			Prewired receptacle with pin connector		
	Switch body	DT	Catalog Number	List Price \$ 1 unit	DT	Catalog Number	List Price \$ 1 unit
	Single pole 1 NO + 1 NC	▶	3SE03-SA6P			—	—
	Single pole 2 NO + 2 NC	▶	3SE03-SB6P			—	—
	Single pole 1 NO + 1 NC		—	—	▶	3SE03-SA6PC	
	Single pole 2 NO + 2 NC		—	—	▶	3SE03-SB6PC	

Operating heads^②:

		Nominal operating data								
Operating head type		Total travel	Pretravel	Operating force	Release position	Minimum return force	Operating temp range^④	DT	Catalog Number	List Price \$ 1 unit
 <p>Side rotary^③</p>	Standard momentary ^④	90°	5°	3 lb-in.	2°	4.5 oz-in.	1	▶	3SE03-DR1	
	Low torqued momentary ^④	90°	15°	1.5 lb-in.	6°	2.5 oz-in.	1	▶	3SE03-DL1	
	Standard maintained	90°	50°	3 lb-in.	50°	—	2	▶	3SE03-DM1	
 <p>Plain side plunger</p>	Momentary	0.25 in.	0.065 in.	4 lbs	0.03 in.	8 oz.	2	▶	3SE03-DS1	
 <p>Roller side plunger</p>	Momentary ^⑦	0.25 in.	0.065 in.	4 lbs	0.03 in.	8 oz.	2	▶	3SE03-DS3	
 <p>Two-sided plunger</p>	Maintained	0.32 in.	0.2 in.	5 lbs	0.13 in.	5 lbs	2	▶	3SE03-DH1	
 <p>Plain top plunger</p>	Momentary	0.28 in.	0.04 in.	4 lbs	0.02 in.	8 oz.	3	▶	3SE03-DT1	
 <p>Roller top plunger</p>	Momentary	0.28 in.	0.04 in.	4 lbs	0.02 in.	8 oz.	3	▶	3SE03-DT3	
 <p>Wobble head^{⑤⑧}</p>	Momentary	15°	10°	2 lb-in.	6°	2.4 oz-in.	3	▶	3SE03-DW1	
 <p>Center neutral^{⑤⑨}</p>	Momentary	90°	5°	1.8 lb-in.	2°	2.5 oz-in.	2	▶	3SE03-DN1	
			90°	15°	1.8 lb-in.	2°	2.5 oz-in.	2	▶	3SE03-DN2

① For use with 3SE03-DN1, -DN2 operating heads and 3SE03-RB receptacle only.

② For use with modular, Plug-in and NEMA Type 6P.

③

④ Refer to "Operating Temperature", Catalog page 13/118 for Temperature Ranges.

⑤ Without Operating Levers.

⑥ CW and CCW operation. Convertible to CW or CCW operation only.

⑦ Convertible—Horizontal to Vertical.





⑧ Requires Lever.

⑨ For use with 3SE03-SN plug-in module only.

3SE03 North American Limit Switches

Modular, plug-in metal housing

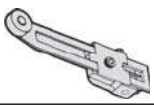
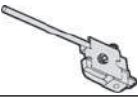
Levers for plug-in and non-plug-in versions—most widely used

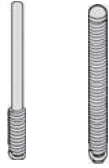
Description	Length ^①	Roller mounted on side of lever	Roller material	Roller diameter	Roller face width	Max required ^② return torque (oz-in.)	DT	Catalog Number	List Price \$ 1 unit
	1.5 (38)	Front	Nylatron	0.75 (19)	0.31 (8)	0.53	▶	3SX03-KL200	
	1.5 (38)	Front	Cast aluminum	0.75 (19)	0.31 (8)	1.10	▶	3SX03-KL355	
	1.5 (38)	Back	Cast aluminum	0.75 (19)	0.31 (8)	1.10	▶	3SX03-KL579	
	1.5 (38)	Back / back	Nylatron	0.75 (19)	0.31	-	▶	3SX03-KL204	
	1-3.5 (25-89)	Front	Nylatron	0.75 (19)	0.31 (8)	1.90 ^⑤	▶	3SX03-KL201	
	1-3.5 (25-89)	Front	Metal	0.75 (19)	0.31 (8)	3.40 ^⑤	▶	3SX03-KL538	
	9 (229)	-	Stainless steel	-	-	7.00 ^⑤	▶	3SX03-KL220	
	Adjustable spring rod	12.125 (308)	-	Nylon	-	-	3.50 ^⑤	▶	3SX03-KL556
	6 (152)	-	Nylatron	-	-	0.40	▶	3SX03-KL142	
Levers									
	Rod	-	Nylon	-	-	-	▶	3SX03-KW2	
	Coil spring	-	Coil spring	-	-	-	▶	3SX03-KW4	
	For plunger actuated switches wobble actuators	⑥							

Levers for plug-in and non-plug-in versions:

Operator	Length ^①	Roller			Max required ^② return torque (oz-in.)	Catalog Number			List Price \$ 1 unit
		Type	Diameter	Face (width)		Stainless steel	DT	Cast aluminum	
	1.37 (35)	Metal	0.75 (19)	0.31 (8)	0.95	-	▶	3SX03-KL40	
	1.50 (38)	Nylatron	0.75 (19)	1.00 (25)	0.92	-	▶	3SX03-KL337	
		Ball bearing	0.69 (17)	0.25 (6)	0.77	-	▶	3SX03-KL531	
		Without roller	-	-	0.32	-	▶	3SX03-KL32	
	2.00 (51)	Nylatron	0.75 (19)	0.31 (8)	0.71	-	▶	3SX03-KL546	
		Nylatron	0.75 (19)	1.00 (25)	1.45	-	▶	3SX03-KL572	
		Metal	0.75 (19)	0.31 (8)	1.5	-	▶	3SX03-KL549	
		Ball bearing	0.69 (17)	0.25 (6)	1.1	-	▶	3SX03-KL552	
	250 (64)	Nylatron	0.75 (19)	0.31 (8)	1.0	-	▶	3SX03-KL547	
		Nylatron	0.75 (19)	1.00 (25)	1.8	-	▶	3SX03-KL573	
Nylatron		1.5 (38)	0.28 (7)	1.4	-	▶	3SX03-KL575		
Metal		0.75 (19)	0.31 (8)	2.0	-	▶	3SX03-KL550		
Ball bearing		0.69 (17)	0.25 (6)	1.5	-	▶	3SX03-KL553		
Cast aluminum	3.00 (76)	Nylatron	0.75 (19)	0.31 (8)	1.3	-	▶	3SX03-KL548	
		Nylatron	0.75 (19)	1.00 (25)	2.3	-	▶	3SX03-KL574	
		Nylatron	1.5 (38)	0.28 (7)	1.8	-	▶	3SX03-KL576	
		Metal	0.75 (19)	0.31 (8)	2.5	-	▶	3SX03-KL551	
		Ball bearing	0.69 (17)	0.25 (6)	1.8	-	▶	3SX03-KL554	

All dimensions shown in inches and (millimeters). For reference purposes only. Not to be used for design or construction purposes.

① Roller lever: Length from the operating shaft axis to the roller axis.
All other: Length from the operating shaft axis to the tip.

② Caution—When selecting lever, required return torque should not exceed minimum return torque in operating head.







③ Cap screw accommodates 3/64 inch Allen wrench.
④ By re-assembling lever minimum can be reduced another 0.50 (13).

⑤ Applies when lever extended to maximum dimension.
⑥ See dimensions page 13/76.





3SE03 North American Limit Switches

Modular, plug-in and NEMA type 6P submersible

Levers for plug-in and non-plug-in versions—most widely used

Operator	Length ^① Inches (mm)	Roller			Min. required return torque oz-in ^⑤	Catalog Number				
		Type	Diameter In. (mm)	Face width in. (mm)		DT	Stainless steel	Cast aluminum	List Price \$ 1 unit	
Roller levers										
	Roller on reverse side	1.50 (38)	Nylatron	0.75 (19)	0.31 (8)	0.53	▶	–	3SX03-KL310	
			Nylatron	1.5 (38)	0.28 (7)	0.96	–	–	3SX03-KL536	
			Ball bearing	0.69 (17)	0.25 (6)	0.77	–	–	3SX03-KL580	
	Offset lever (Inboard roller shown)	1.50 (38)	Nylatron	0.75 (19)	0.31 (8)	0.65	▶	3SX03-KL24	–	
			Metal	0.75 (19)	0.31 (8)	1.20	▶	3SX03-KL25	–	
		1.50 (38)	Nylatron	0.75 (19)	0.31 (8)	0.65	▶	3SX03-KL27	–	
			Metal	0.75 (19)	0.31 (8)	1.20	▶	3SX03-KL28	–	
			Ball bearing	0.69 (17)	0.25 (6)	0.90	▶	3SX03-KL29	–	
			Nylatron	0.75 (19)	1 (25)	1.10	▶	3SX03-KL30	–	
	Bantam lever	0.69 (18)	Metal	0.88 (22)	0.19 (5)	0.45	▶	3SX03-KL532		
	Precision adjustment	1.50 (38) ^②	Nylatron	0.75 (19)	0.31 (8)	0.65	–	3SX03-KL340		
			Metal	0.75 (19)	0.31 (8)	1.20	–	3SX03-KL465		
			Ball bearing	0.69 (17)	0.25 (6)	0.90	▶	3SX03-KL535		
	Adjustable roller	1–3.75 (25–95) ^③	Nylatron	0.75 (19)	0.5 (13)	1.90 ^④	▶	3SX03-KL599		
			Nylatron	0.75 (19)	1 (25)	3.10 ^④	▶	3SX03-KL537		
		1.62–3.75 (41–95) ^③	Nylatron	1.5 (38)	0.28 (7)	2.50 ^④	▶	3SX03-KL443		
			Large nylatron	4 (102)	0.11 (3)	4.50 ^④	▶	3SX03-KL598		
		0.50–3.75 (13–95)	Ball bearing	0.69 (17)	0.25 (6)	2.50 ^④	▶	3SX03-KL539		
			Without roller	–	–	1.20 ^④	▶	3SX03-KL31		
	Fork lever _ both rollers one side	1.50 (38)	Nylatron	0.75 (19)	1 (25)	–	▶	3SX03-KL543		
			Metal	0.75 (19)	0.31 (8)	–	▶	3SX03-KL544		
			Ball bearing	0.69 (17)	0.25 (6)	–	▶	3SX03-KL545		
	Fork lever _ both rollers outside, one side	1.50 (38)	Nylatron	0.75 (19)	0.31 (8)	–	▶	3SX03-KL203		
			Metal	0.75 (19)	0.31 (8)	–	▶	3SX03-KL541		
			Ball bearing	0.69 (17)	0.25 (6)	–	▶	3SX03-KL542		

Levers for plug-in and non-plug-in versions:

Operator		Length ^① Inches (mm)	Description Inches (mm)	Min. required return force oz-in. ^⑤	DT	Catalog Number	List Price \$ 1 unit
	Adjustable rod	5.50 (140) Max.	Nylon Rod—0.19 (5) Dia.	0.40 ^④	▶	3SX03-KL399	
		5.50 (140) Max.	Metal Rod—0.12 (3) Dia.	0.92 ^④	▶	3SX03-KL202	
		8.75 (222) Max.	Metal Rod (Square)—0.12 (3) Max.	2.20 ^④	▶	3SX03-KL581	
		12 (305) Max.	Steel (Formable) Rod—0.12 (3) Dia.	5.00 ^④	▶	3SX03-KL226	
		–	Clamp Only—0.19 (5) Hole	–	▶	3SX03-KL35	
		–	Clamp Only—0.12 (3) Hole	–	▶	3SX03-KL36	
	Spring rod	11.62 (295)	Metal rod	2.80		3SX03-KL421	
	Adjustable wire	12.12 (308) max.	Nylon covered wire	1.50 ^④	▶	3SX03-KL533	
	Adjustable wide roller lever	3.9 (99)	0.75 (19) Dia. Nylatron Roller 0.19 (30) Dia. Rod	4.50 ^④	▶	3SX03-KL37	
Wobble head operators							
See dimensions page 13/76	Stainless steel rod	–	Rod diameter - 0.06 (2)	–	▶	3SX03-KW3	

① Length from operating shaft axis to the roller axis.
 ② Maximum dimensions, precision adjustable to lesser dimensions.
 ③ By re-assembling lever minimum can be reduced by 1/2 in.

④ Applies when lever extended to maximum dimension.
 ⑤ Caution—When selecting lever, required return torque should not exceed minimum return force in operating head.

All dimensions shown in inches and (millimeters). For reference purposes only. Not to be used for design or construction purposes.

3SE03 North American Limit Switches

Modular, plug-in and NEMA type 6P submersible

Wiring diagrams

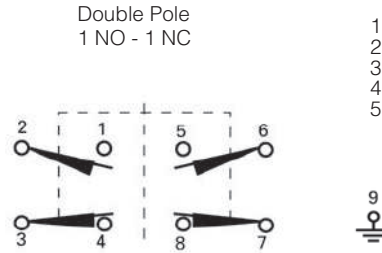
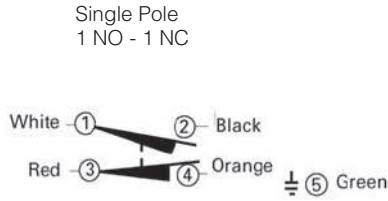

- Cable color code
- | | |
|------------|------------|
| 1 - White | 6 - Pink |
| 2 - Black | 7 - Yellow |
| 3 - Red | 8 - Blue |
| 4 - Orange | 9 - Green |
| 5 - Brown | |
- Pre-wired cable

Modular, plug-in and prewired cable

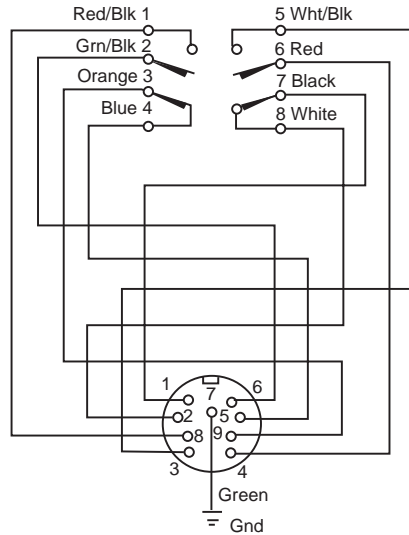
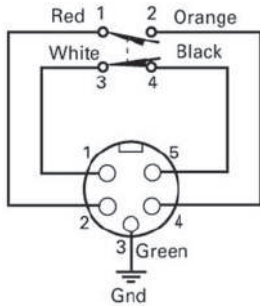

Prewired receptacle with pin connector

Typical connector cable (supplied by user)

Cable length ft.	Manufacturers part number			
	Daniel Woodhead Brad Harrison	Cooper Crouse-Hinds	Molex (Industrial Interface)	Lumberg USA
5 Pin connector cable				
3	105000A01F030	5000111-3_	14541	RK50-77/1M
6	105000A01F060	5000111-4_	14542	RK50-77/2M
12	105000A01F120	5000111-5_	14544	RK50-77/4M
9 Pin connector cable				
3	309000A01F030	X8990-3	-	-
6	309000A01F060	X8990-4	-	-
12	309000A01F120	X8990-5	-	-

3SE03 North American Limit Switches

Modular, plug-in and NEMA type 6P submersible

Dimension drawings

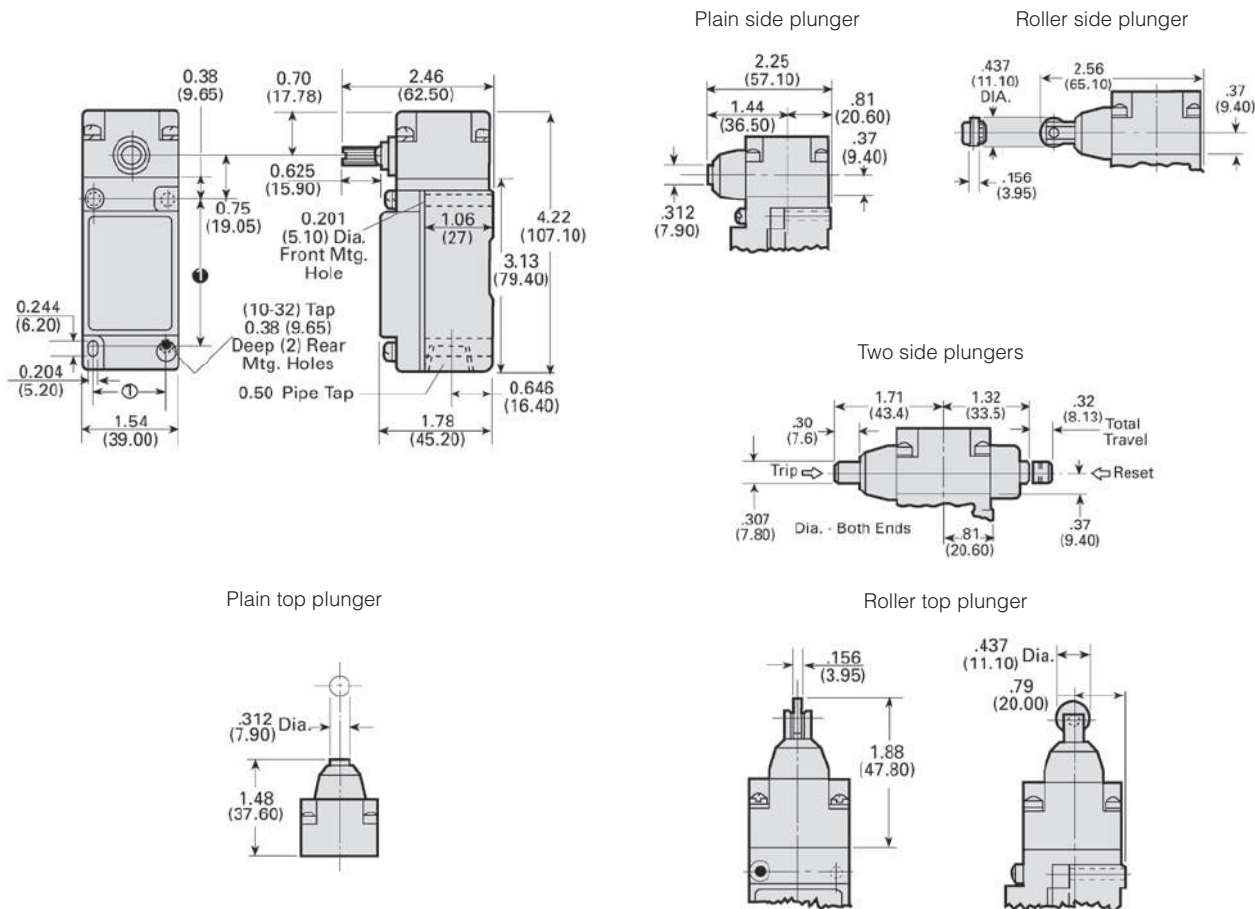

Rotary lever operators

Catalog Number	Dimensions						Catalog Number	Dimensions					
	A	B	C	D	E	F		A	B	C	D	E	F
3SX03-KL200	1.50 (38.1)	0.75 (19.0)	0.32 (8.1)	0.44 (11.2)	0.20 (5.1)	0.24 (6.1)	3SX03-KL554	3.00 (76.2)	0.688 (17.5)	0.25 (6.4)	0.42 (10.7)	0.12 (3.0)	0.18 (4.6)
3SX03-KL355	1.50 (38.1)	0.75 (19.0)	0.32 (8.1)	0.44 (11.2)	0.20 (5.1)	0.24 (6.1)	3SX03-KL572	2.00 (50.8)	0.75 (19.0)	1.00 (25.4)	0.42 (10.7)	0.90 (22.9)	0.90 (22.9)
3SX03-KL531	1.50 (38.1)	0.688 (17.5)	0.25 (6.4)	0.44 (11.2)	0.12 (3.0)	0.18 (4.6)	3SX03-KL573	2.50 (63.5)	0.75 (19.0)	1.00 (25.4)	0.42 (10.7)	0.90 (22.9)	0.90 (22.9)
3SX03-KL546	2.00 (50.8)	0.75 (19.0)	0.32 (8.1)	0.42 (10.7)	0.20 (5.1)	0.24 (6.1)	3SX03-KL574	3.00 (76.2)	0.75 (19.0)	1.00 (25.4)	0.42 (10.7)	0.90 (22.9)	0.90 (22.9)
3SX03-KL547	2.50 (63.5)	0.75 (19.0)	0.32 (8.1)	0.42 (10.7)	0.20 (5.1)	0.24 (6.1)	3SX03-KL575	2.50 (63.5)	1.50 (38.1)	0.29 (7.4)	0.42 (10.7)	0.18 (4.6)	0.24 (6.1)
3SX03-KL548	3.00 (76.2)	0.75 (19.0)	0.32 (8.1)	0.42 (10.7)	0.20 (5.1)	0.24 (6.1)	3SX03-KL576	3.00 (76.2)	1.50 (38.1)	0.29 (7.4)	0.42 (10.7)	0.18 (4.6)	0.24 (6.1)
3SX03-KL549	2.00 (50.8)	0.75 (19.0)	0.32 (8.1)	0.42 (10.7)	0.20 (5.1)	0.24 (6.1)	With rollers on reverse side						
3SX03-KL550	2.50 (63.5)	0.75 (19.0)	0.32 (8.1)	0.42 (10.7)	0.20 (5.1)	0.24 (6.1)	3SX03-KL310	1.50 (38.1)	0.75 (19.0)	0.32 (8.1)	0.44 (11.2)	0.34 (8.6)	0.38 (9.7)
3SX03-KL551	3.00 (76.2)	0.75 (19.0)	0.32 (8.1)	0.42 (10.7)	0.20 (5.1)	0.24 (6.1)	3SX03-KL536	1.50 (38.1)	1.50 (38.1)	0.28 (7.1)	0.44 (11.2)	0.30 (7.6)	0.38 (9.7)
3SX03-KL552	2.00 (50.8)	0.688 (17.5)	0.25 (6.4)	0.42 (10.7)	0.12 (3.0)	0.18 (4.6)	3SX03-KL579	1.50 (38.1)	0.75 (19.0)	0.32 (8.1)	0.44 (11.2)	0.34 (8.6)	0.38 (9.7)
3SX03-KL553	2.50 (63.5)	0.688 (17.5)	0.25 (6.4)	0.42 (10.7)	0.12 (3.0)	0.18 (4.6)	3SX03-KL580	1.50 (38.1)	0.688 (17.5)	0.25 (6.4)	0.44 (11.2)	0.25 (6.4)	0.31 (7.9)

All dimensions shown in inches and (millimeters). For reference purpose only. Not to be used for design or construction purposes.

© Can accommodate both U.S. 1.16 (29.4) x 2.34 (59.5) and DIN 1.18 (30.0) x 2.36 (60.0) mounting dimensions.

3SE03 North American Limit Switches

Modular, plug-in and NEMA type 6P submersible

Dimension drawings

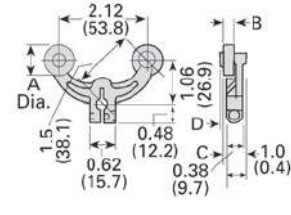
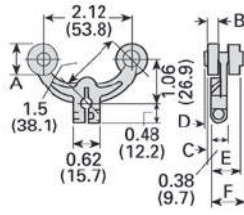
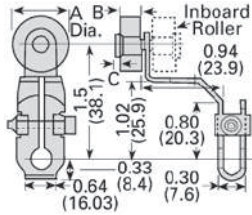

Offset roller levers

Catalog Number	Dimensions		
	A	B	C
Outboard roller			
3SX03-KL27	0.75 (19)	0.32 (8)	0.03 (1)
3SX03-KL28	0.75 (19)	0.32 (8)	0.03 (1)
3SX03-KL29	0.69 (18)	0.25 (6)	0.04 (1)
3SX03-KL30	0.75 (19)	1.0 (25)	-
Inboard roller			
3SX03-KL24	0.75 (19)	0.32 (8)	0.03 (1)
3SX03-KL25	0.75 (19)	0.32 (8)	0.03 (1)
3SX03-KL26	0.69 (18)	0.25 (6)	0.04 (1)

Fork lever, one roller inside, one roller outside

Catalog Number	Dimensions					
	A	B	C	D	E	F
3SX03-KL203	0.75 (19)	0.32 (8)	0.16 (4)	0.20 (5)	0.73 (19)	0.77 (20)
3SX03-KL541	0.75 (19)	0.32 (8)	0.16 (4)	0.20 (5)	0.73 (19)	0.77 (20)
3SX03-KL542	0.69 (18)	0.25 (6)	0.08 (2)	0.14 (4)	0.64 (16)	0.70 (18)

Fork lever - Both rollers on one side

Catalog Number	Dimensions			
	A	B	C	D
3SX03-KL204	0.75 (19)	0.32 (8)	0.16 (4)	0.20 (5)
3SX03-KL543	0.75 (19)	1.0 (25)	0.86 (22)	0.86 (22)
3SX03-KL544	0.75 (19)	0.32 (8)	0.16 (4)	0.20 (5)
3SX03-KL545	0.69 (18)	0.25 (6)	0.08 (2)	0.1 (3)

Bantam roller lever

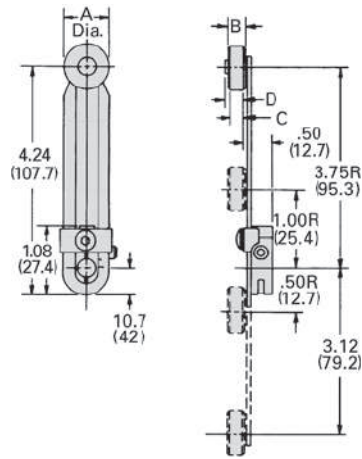
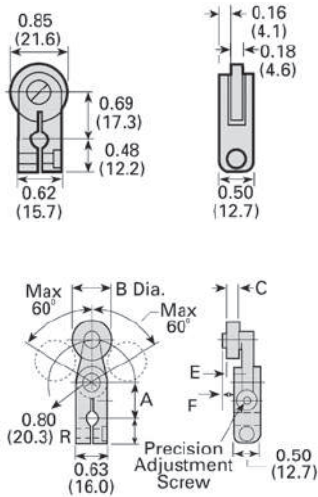

Precision adjustment roller lever

Catalog Number	Dimensions					
	A	B	C	D	E	F
3SX03-KL340	0.69 (18)	0.75 (19)	0.32 (8)	0.48 (12)	0.24 (6)	0.28 (7)
3SX03-KL465	0.69 (18)	0.75 (19)	0.32 (8)	0.48 (12)	0.24 (6)	0.28 (7)
3SX03-KL535	0.69 (18)	0.69 (18)	0.25 (6)	0.48 (12)	0.16 (4)	0.22 (6)

Adjustable roller lever

Catalog Number	Dimensions			
	A	B	C	D
3SX03-KL201	0.75 (19)	0.32 (8)	0.29 (7)	0.33 (8)
3SX03-KL443	1.5 (38)	0.29 (7)	0.26 (7)	0.32 (8)
3SX03-KL537	0.75 (19)	0.32 (8)	0.29 (7)	0.33 (8)
3SX03-KL538	0.69 (18)	0.25 (6)	0.21 (5)	0.27 (7)
3SX03-KL539	0.69 (18)	0.25 (6)	0.21 (5)	0.27 (7)
3SX03-KL598	0.39 (10)	0.11 (3)	0.11 (3)	0.19 (5)
3SX03-KL599	0.75 (19)	0.5 (13)	0.46 (12)	0.47 (12)

All dimensions shown in inches and (millimeters). For reference purposes only. Not to be used for design or construction purposes.

3SE03 North American Limit Switches

Modular, plug-in and NEMA type 6P submersible

Dimension drawings

Nylon Spring Rod Actuator
3SX03-KL556

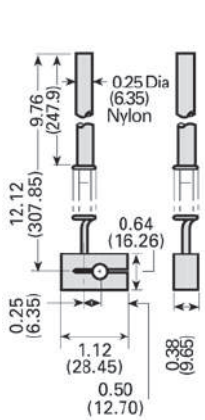

Nylon Covered Wire Actuator
3SX03-KL533

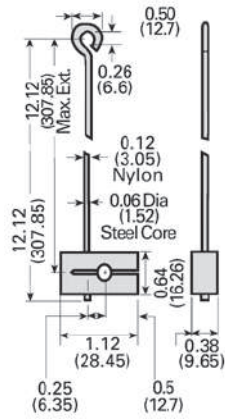

Stainless Steel Spring Actuator
3SX03-KL421

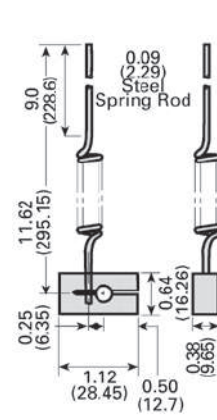

Adjustable Rod Actuator

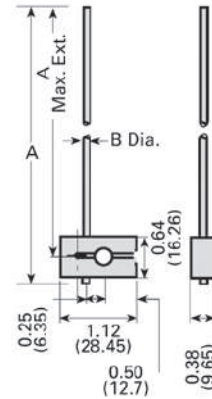

Adjustable Wire Roller Actuator
3SX03-KL37

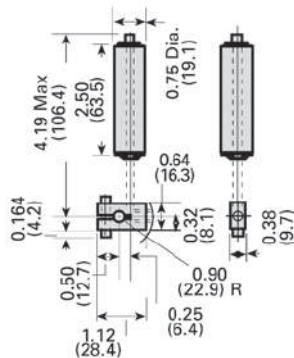

Nylatron Loop Actuator
3SX03-KL142

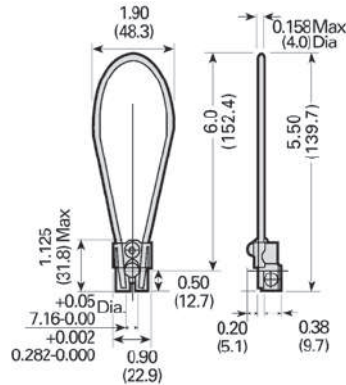

Adjustable rod actuators

Catalog Number	Material	Dimensions	
		A	B
3SX03-KL202	Steel-Round	5.50 (140)	0.120 (3)
3SX03-KL581	Steel-Square	8.75 (222)	0.125 (3)
3SX03-KL399	Nylon	5.50 (140)	0.190 (5)
3SX03-KL220	Stainless Steel	9.00 (229)	0.190 (5)
3SX03-KL226	Plated Steel	12.0 (305)	0.120 (3)

Wobble head with nylon head
3SE03-DW1
3SX03-KW2

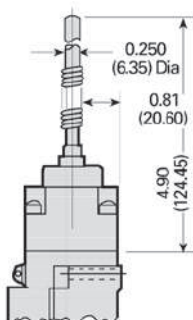

Wobble head with coil spring
3SE03-DW1
3SX03-KW4

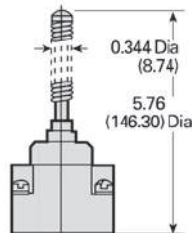

Wobble head with stainless steel rod
3SE03-DW1
3SX03-KW3

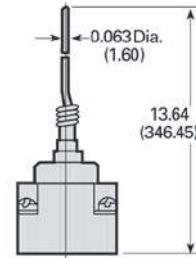

All dimensions shown in inches and (millimeters). For reference purposes only. Not to be used for design or construction purposes.

3SE03 North American Limit Switches

3SE03 Metal enclosure

Description

Features

- NEMA 1 Enclosed Aluminum Die Cast Housing
- Screw Terminals
- Booted versions for added protection

Features

- 1/2" Conduit Entrance
- NEMA A600, R300 Contacts
- UL Recognized
- CSA Certified
- INO/INC Snap-action contacts (form c)

Application

These switches are designed for accurate repeatability. Their compact size makes them ideal for use in space-restricted areas.

Typical applications include overhead, folding and elevator doors, sliding gates and other automated equipment.

Overall dimensions	Specifications ①	DT	Catalog Number	List Price \$ 1 unit
Plunger actuator	OF Max. - 8.82 - 12.3 oz. (250 - 350 g) RF Min. 4.02 oz. (114 g) PT Max. - 0.016 in. (0.4 mm) OT Min. - 0.217 in. (5.5 mm) MD Max. - 0.002 in. (0.05 mm) OP - 1.504 in. (38.2 mm)	▶	3SE03 - EB05	
Booted plunger	OF Max. - 28.22 oz. (800 g) RF Min. 8.46 oz. (240 g) PT Max. - 0.079 in. (2.0 mm) OT Min. - 0.197 in. (5.0 mm) MD Max. - 0.004 in. (0.1 mm) OP - 1.803 in. (45.8 mm)	▶	3SE03 - EB06	
Roller lever	OF Max. - 20.1 oz. (570 g) RF Min. 6.0 oz. (170 g) PT Max. - 0.157 in. (4.0 mm) OT Min. - 0.236 in. (6.0 mm) MD Max. - 0.016 in. (0.4 mm)	▶	3SE03 - EB32	
Booted roller lever	OF Max. - 22.57 oz. (640 g) RF Min. 8.11 oz. (230 g) PT Max. - 0.197 in. (5.0 mm) OT Min. - 0.236 in. (6.0 mm) MD Max. - 0.016 in. (0.4 mm)	▶	3SE03 - EB33	

① OF = Operating Force
 RF = Return Force
 PT = Pretravel
 OT = Operating Travel
 MD = Movement Differential
 OP = Operating Position

3SE03 North American Limit Switches

3SE03 Metal enclosure

Dimension drawings

Overall dimensions	Specifications	DT	Catalog Number	List Price \$ 1 unit
<p>Roller plunger</p>	<p>OF Max. - 9.92 - 12.3 oz. (250 - 350 g) RF Min. 4.02 oz. (114 g) PT Max. - 0.02 in. (0.5 mm) OT Min. - 0.142 in. (3.6 mm) MD Max. - 0.002 in. (0.05 mm) OP - 1.957 in. (49.7 mm)</p>	▶	3SE03 - EB07	
<p>Booted roller plunger</p>	<p>OF Max. - 17.64 oz. (500 g) RF Min. 3.53 oz. (100 g) PT Max. - 0.039 in. (1.0 mm) OT Min. - 0.138 in. (3.5 mm) MD Max. - 0.006 in. (0.12 mm) OP - 1.957 in. (49.7 mm)</p>	▶	3SE03 - EB08	

Technical data								
Mechanical Life	3,000,000 operations maximum							
Electrical Life	500,000 operations minimum							
Operating Speed	0.01 m/second to 1m/second							
Cable Entry	1/2" NPT							
Temperature Range	-15° to 80° (5° to 176°F)							
Degree of Protection	NEMA 1							
Mounting	Any Position							
NEMA Rating	A600, R300							
Rated Voltage (V) ¹⁾²⁾	Non-Inductive Load (A)			Inductive load (A)			Inrush current (A)	
	Resistive load		Lamp load	Inductive load		Motor load	NO	NC
	NC-NO	NO	NC	NC-NO	NO	NC		
125 VAC	15	3	1.5	15	5	2.5	30 maximum	15 maximum
250 VAC	15	2.5	1.25	15	3	1.5		
500 VAC	3	1.5	0.75	2.5	1.5	0.75		
8 VDC	15	3	1.5	15	5	2.5		
14 VDC	15	3	1.5	10	5	2.5		
30 VDC	6 (2)	3	1.5	5	5	2.5		
125 VDC	0.4	0.4	0.4	0.05	0.05	0.05		
250 VDC	0.2	0.2	0.2	0.03	0.03	0.03		

1) Inductive load has power factor of 0.04 minimum (AC) and a time of 7m/second (DC)

2) Lamp load has an inrush current of 6 times steady-state current.

SIRIUS 3SE7 Cable-Operated Switches

General Information

Application

Cable-operated switches are used for monitoring or for EMERGENCY-STOP facilities on particularly endangered system sections. They are available with metal enclosures.

As the effective range of a cable-operated switch is limited by the length of the pull-wire, large systems can also be protected.

Cable-operated switches (requiring pulling at both ends) and conveyor belt unbalance trackers are used primarily for monitoring very long belt systems.

Specifications

Switches with latching for implementation in EMERGENCY-STOP equipment correspond to the EN 418 standard.

Principle of operation

The switch contacts of the cable-operated switches and the conveyor belt unbalance protection devices are positive opening.

Cable-operated switches with one-side operation are held in free position by the pre-tension force on the turnbuckle.

- In the 3SE7 140, -150 and -160 cable-operated switches, both switching contacts are available for cable-break/cable pull signaling. The NO contact is used, for example, for signaling purposes.

For switches with latching, with a pretensioned cable, the locking must be deactivated beforehand in order to return the switch to its free position.

Technical data

Type	3SE7 120	3SE7 150	3SE7 140	3SE7 141	3SE7 160	3SE7 310
Standards	IEC 60947-5-1, EN 60947-5-1; IEC 60204-1, EN 60204-1; EN ISO 13850					
Certifications	UL / CSA					
Electrical design	Contacts electrically isolated from each other					
Electrical loading	<ul style="list-style-type: none"> at AC-15 minimum 					
	AC 400 V, 6A			AC 250 V, 2A	AC 400 V, 6A	
	AC/DC 24 V, 10 mA					
Short circuit protection	6 A (Slow acting)					
Mechanical endurance	> 1 x 10 ⁶ operating cycles					
Contact material	Fine silver					
Actuation	By pulling or breaking of a rope (cable)					
Rope length, maximum Spacing between rope supports, maximum	10 m 2.5 m	25 m 3 m	50 m 5 m	75 m ¹⁾ 5 m	2 x 50 m 5 m	– –
Enclosure	GDAL alloy, coated (color), dark black RAL 9005					
Cover	Shock-resistant thermoplastic					
Degree of protection acc. To IEC 60529	IP65			IP67	1P65	
Ambient temperature	-25C to +70C					
Mounting	Designed for M 5					
Mounting space	30 mm and 40 mm					
Cable entry	2x(M20x1.5)	2x(M20x1.5)	1x(M16x1.5)	3x(M20x1.5)	2x(M25x1.5)	
Type of connection	M3.5 screw connection; Self-lifting pressure plate terminals					

Travel diagrams

3SE7 120-2DD01

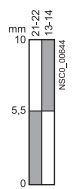

Central position

3SE7 140-1.F00

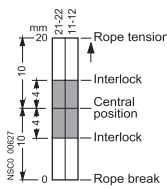

Central position

3SE7 141-1EG10

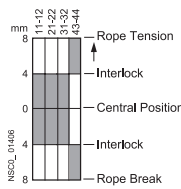

Central position

3SE7 140-1.D0.

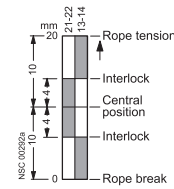

Central position

3SE7 120-1BF00, 3SE7 150-1BF00

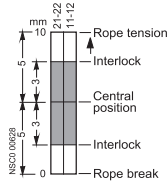

Central position

3SE7 160-1AE, 3SE7 310-1AE

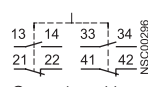
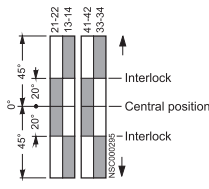

Central position

3SE7 150-1.D00, 3SE7 150-2DD00

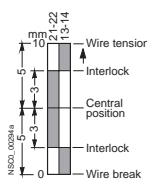

Central position

1) 75 m cable length possible provided the ambient temperature range is strictly observed, otherwise, 50 m.

SIRIUS 3SE7 Cable-Operated Switches

Selection

Selection and ordering data

Version	Wire length	Contacts	DT	Order No.	Price per PU	PU (UNIT, SET, M)	PS*	
Cable-operated switches								
 <p>3SE7 120-1BH00</p>	Metal enclosures, IP65 (cover made of molded plastic)	10						
		<ul style="list-style-type: none"> Without latching, only cable pull monitoring 	1 NO + 1 NC	↻	A	3SE7 120-2DD01	1	1 unit
		<ul style="list-style-type: none"> With latching and button reset 	2 NC	↻	A	3SE7 120-1BF00	1	1 unit
		<ul style="list-style-type: none"> With latching and button reset - With yellow lid 	1 NO + 2 NC	↻	A	3SE7 120-1BH00	1	1 unit
 <p>3SE7 150-1BD00 3SE7 150-1BH00</p>	Metal enclosures, IP65 (cover made of molded plastic), with alignment window	25						
		<ul style="list-style-type: none"> Without latching 	1 NO + 1 NC	↻	A	3SE7 150-2DD00	1	1 unit
		<ul style="list-style-type: none"> With latching and button reset 	1 NO + 1 NC	↻	▶	3SE7 150-1BD00	1	1 unit
			2 NC	↻	▶	3SE7 150-1BF00	1	1 unit
		<ul style="list-style-type: none"> With latching and button reset - With yellow lid 	1 NO + 2 NC	↻	▶	3SE7 150-1BH00	1	1 unit
<ul style="list-style-type: none"> With latching and key unlatching 	1 NO + 1 NC	↻	B	3SE7 150-1CD00	1	1 unit		
 <p>3SE7 150-1BD04</p>	Metal enclosures, IP65 (cover made of molded plastic), with alignment window, with LED, red, 24 V DC	25						
		<ul style="list-style-type: none"> Without latching 	1 NO + 1 NC	↻	B	3SE7 150-2DD04	1	1 unit
		<ul style="list-style-type: none"> With latching and button reset 	1 NO + 1 NC	↻	▶	3SE7 150-1BD04	1	1 unit
 <p>3SE7 140-1B.00</p>	Metal enclosures, IP65 (cover made of molded plastic)	50						
		<ul style="list-style-type: none"> With latching and button reset 	1 NO + 1 NC	↻	A	3SE7 140-1BD00	1	1 unit
			2 NC	↻	▶	3SE7 140-1BF00	1	1 unit
		<ul style="list-style-type: none"> In addition with LED, red, 24 V DC 	1 NO + 1 NC	↻	B	3SE7 140-1BD04	1	1 unit
<ul style="list-style-type: none"> With latching and key unlatching 	1 NO + 1 NC	↻	B	3SE7 140-1CD00	1	1 unit		
 <p>3SE7 141-1EG10</p>	Metal enclosures, IP67 (cover made of molded plastic), with EMERGENCY-STOP mushroom, with rotate-to-unlatch mechanism	75						
			1 NO + 3 NC	↻	▶	3SE7 141-1EG10	1	1 unit
 <p>3SE7 160-1AE00</p>	Metal enclosures, IP65 with actuation on both sides	2 × 75						
		<ul style="list-style-type: none"> With latching and button reset 	2 NO + 2 NC	↻	A	3SE7 160-1AE00	1	1 unit
			1 NO + 1 NC	↻	B	3SE7 160-1BD00	1	1 unit
<ul style="list-style-type: none"> In addition with LED, red, 24 V DC 	2 NO + 2 NC	↻	B	3SE7 160-1AE04	1	1 unit		

↻ Positive opening according to IEC 60947-5-1, Appendix K.

SIRIUS 3SE7 Cable-Operated Switches

Selection

Version	Contacts	DT	Order No.	Price per PU	PU (UNIT, SET, M)	PS*
---------	----------	----	-----------	--------------	-------------------	-----

Conveyor belt unbalance trackers



3SE7 310-1AE00

Metal enclosures, IP65

- With latching and button reset
- In addition with LED, red, 24 V DC

2 NO + 2 NC	↻	B	3SE7 310-1AE00		1	1 unit
2 NO + 2 NC	↻	B	3SE7 310-1AE04		1	1 unit

↻ Positive opening according to IEC 60947-5-1, Appendix K.

Product Category: SFTY

Accessories

Configuration of the cable-operated switches

Short lengths of wire up to 25 m

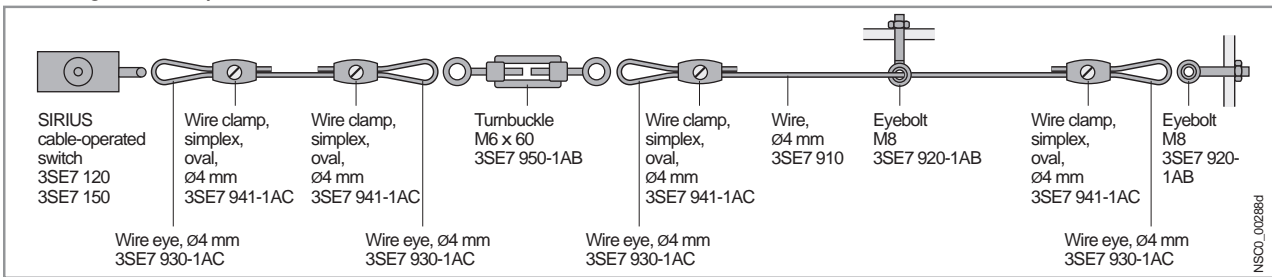

Long lengths of wire up to 50 m

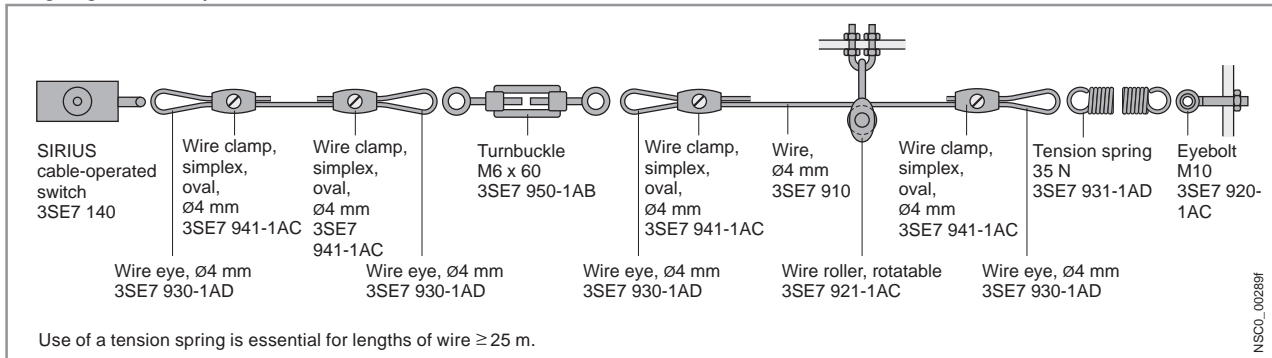

Pulling from both sides up to 2 x 75 m

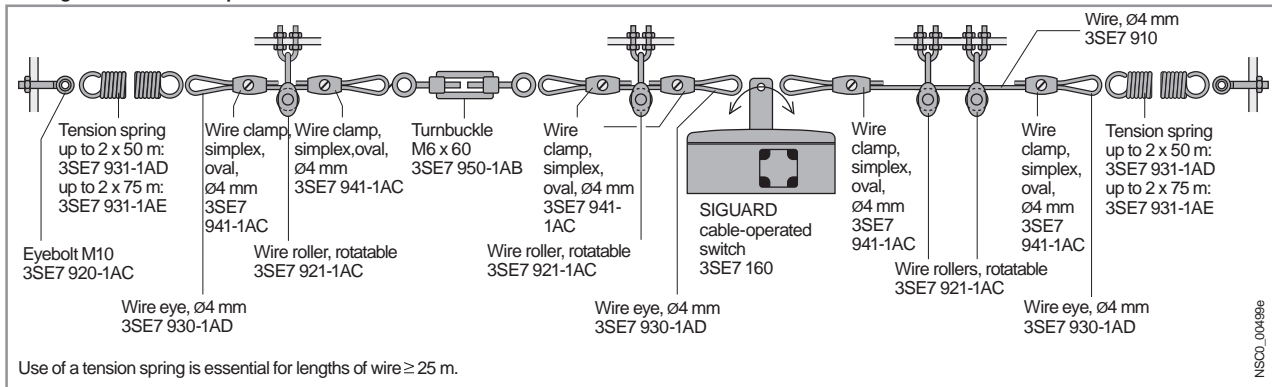









Note:

Large temperature fluctuations require corresponding compensation springs. For reliable connection the PVC sheath must be

removed from the clamping area of the steel trip-wire. Wire supports must be used at the recommended intervals.

SIRIUS 3SE7 Cable-Operated Switches

Accessories

Version	Wire length/ diameter	DT	Order No.	Price per PU	PU (UNIT, SET, M)	PS*
Trip-wire with fixing						
	Steel wires , with red plastic sheath, Ø 4 mm ¹⁾	10 m	A	3SE7 910-3AA	1	1 unit
		15 m	A	3SE7 910-3AB	1	1 unit
		20 m	▶	3SE7 910-3AC	1	1 unit
		50 m	A	3SE7 910-3AH	1	1 unit
	Wire clamps , galvanized white					
	• Oval	2 × Ø 4 mm	A	3SE7 941-1AC	1	1 unit
	• Simplex (1 set = 4 units)	2 × Ø 4 mm	▶	3SE7 943-1AC	1	4 units
	• Duplex (1 set = 4 units)	2 × Ø 4 mm	A	3SE7 944-1AC	1	4 units
	• Single (1 set = 4 units)	2 × Ø 4 mm	A	3SE7 942-1AA	1	4 units
	Tension springs (zinc-plated) to maintain the counter tension					
	• 13 N		A	3SE7 931-1AB	1	1 unit
	• 35 N, for trip-wires up to 50 m		▶	3SE7 931-1AD	1	1 unit
	• > 35 N, for trip-wires up to 2 × 75 m		▶	3SE7 931-1AE	1	1 unit
	Wire rollers for changing the direction of the wire, Ø 4 mm rotatable		A	3SE7 921-1AC	1	1 unit
	Fixtures for the wire rollers (incl. fixing nuts)		▶	3SE7 921-1AA	1	1 unit
	Wire eyes for changes in wire direction and improved power transmission at the fixing points (1 set = 4 units)	Ø 4 mm	▶	3SE7 930-1AD	1	4 units
	Eyebolts for fixing the wire					
	• Including M8 nut		A	3SE7 920-1AB	1	1 unit
	• Including M10 nut		▶	3SE7 920-1AC	1	1 unit
	Turnbuckles for precise adjustment of the pretension					
	• M6 x 60		A	3SE7 950-1AB	1	1 unit
	• M6 x 110		A	3SE7 950-1AD	1	1 unit
Spare parts						
	LED lamps , red 24 V DC 25 mm diameter; for M20 x 1.5 connection		D	3SX3 235	1	1 unit

¹⁾ Diameter including casing; the diameter of the steel wire is 3.2 mm.

SIRIUS 3SE7 Cable-Operated Switches

3SE7, metal enclosures

Dimension drawings

Metal enclosure

3SE7 120-2DD.., 3SE7 150-2DD..
without latching

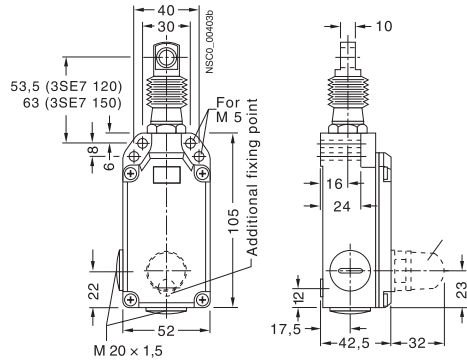

3SE7 120-1B..., 3SE7 150-1B...
with latching and button reset

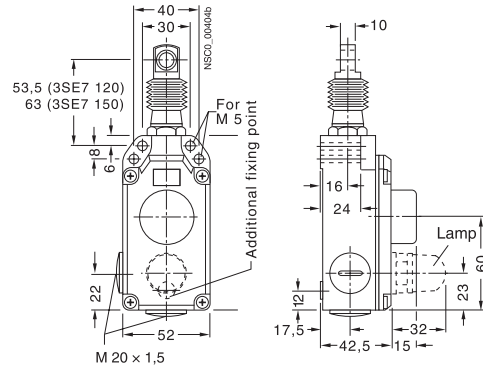

Metal enclosure

3SE7 140-1B...
with latching and button reset

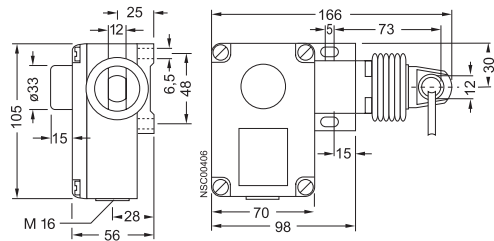

3SE7 140-1ECD.
with latching and key reset

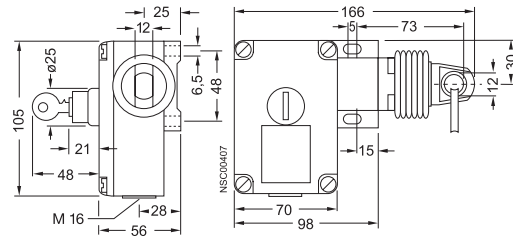

Metal enclosure

3SE7 150-1CD..
with latching and key reset

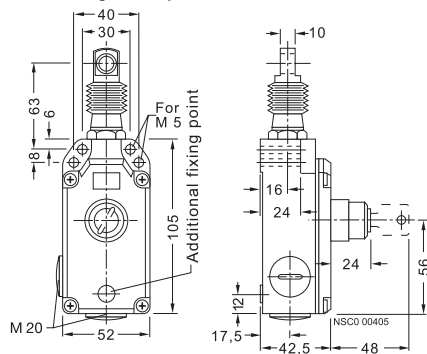

3SE7 141-1EG10.
with EMERGENCY STOP and Lockout release

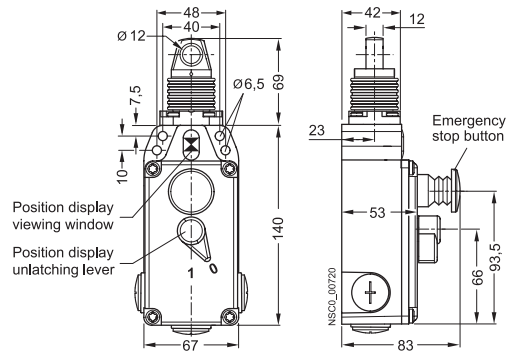

3SE7 160-1AE..
with latching and button reset

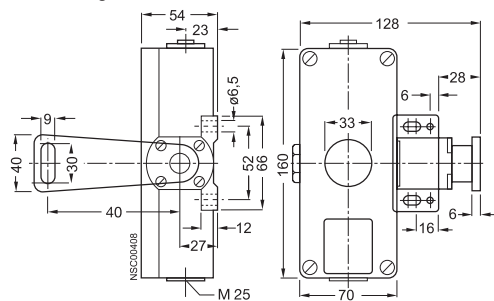

3SE7 310-1AE.. conveyor belt unbalance protection device
with latching and button reset

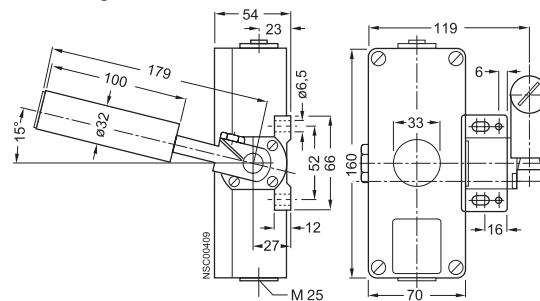

SIRIUS 3SE5 Interlock Switches

General data

Overview

Position switches with separate actuator are used where the position of doors, covers or protective grills must be monitored for safety reasons.

3SE5 position switches with separate actuator have the same enclosures as the standard switches (modular system).



Position switches with head for separate actuator

Design

Enclosure sizes

The 3SE5 switches are available in various enclosure sizes:

- Plastic enclosures according to EN 50047, 31 mm wide, IP65, 1 cable entry
- Metal enclosures according to EN 50047, 31 mm wide, IP66/IP67, 1 cable entry
- Plastic and metal enclosures according to EN 50041, 40 mm wide, IP66/IP67, 1 cable entry
- Plastic enclosures, 50 mm wide, IP66/IP67, 2 cable entries
- Metal enclosures, 56 mm wide, IP66/IP67, 3 cable entries

Also available is a switch in the 3SE2 series which has arisen in this form according to general market requirements:

- Molded-plastic enclosures outside of the standards, enclosure width 52 mm, IP67

Enclosure versions

Various basic versions can be selected for the enclosures of the 3SE5 series:

- Available with two- or three-pole contact blocks designed as slow-action contacts
- Optional LED status display
- With mounted four- or five-pole M12 connector socket (available for the wide enclosures as an accessory for self-assembly)
- With 6-pole connector socket + PE on the metal enclosures
- Similarly with a combination of connector socket and LED indicators
- Metal enclosures for explosion protection (ATEX) ([see online](#))
- AS-Interface version with integrated ASIsafe electronics for all enclosure designs ([see online](#))

For a description of the basic switches, [see page 13/6](#).

Operation

The actuator head is included in the scope of supply. For actuation from four directions it can be adjusted through $4 \times 90^\circ$. The switches can also be approached from above.

The twist actuators of the 3SE2 243 and 3SE2 257 switches with special enclosures cannot be changed. The switches can be approached from the two broad sides and from above.

The actuators are not included in the scope of supply of the position switch and must be ordered separately from various versions to suit the application ([see page 13/86](#)).

The actuator is encoded. Simple overruling by hand or auxiliary devices is impossible.

Radius actuators

The position switches with radius actuators are particularly suitable for rotatable protective devices. The movable actuation key allows even small radii to be approached. Damage to the switch and the actuator due to inaccurate approach is prevented.

Locking devices

A high-grade steel blocking insert for attaching up to eight padlocks is available for even more safety ([see page 13/86](#)).



Blocking insert with padlock

Dust protection

A rubber cap to protect the twist actuator from contamination is available for operation in dusty environments ([see page 13/86](#)).

Contact reliability

The new contact blocks ensure an extremely high contact stability. This applies even when the devices are switching low voltages and currents, e.g. 1 mA at 5 V DC.

Positive opening 

The NC contacts of the switch are forced open mechanically, positively-driven and reliably by the plunger. This is referred to as "positive opening".



SIRIUS 3SE5 Interlock Switches

3SE5, plastic enclosures with separate actuator

Selection and ordering data

Complete units

2 or 3 contacts · 5 directions of approach · Degree of protection IP65 or IP66/IP67 · Cable entry M20 × 1.5

Version ¹⁾	Contacts	LEDs	DT	Complete units	<input type="checkbox"/>	PU (UNIT, SET, M)	PS*	PG	Weight per PU approx.
				Order No.	List Price \$ per PU				kg
Enclosure width 31 mm to EN 50047									
5 directions of approach									
	Slow-action contacts	1 NO + 1 NC --	⊙ ▶	3SE5 232-0RV40		1	1 unit	102	0.150
	Slow-action contacts	1 NO + 2 NC --	⊙ ▶	3SE5 232-0QV40		1	1 unit	102	0.155
With increased minimum pull-out force 30 N									
	Slow-action contacts	1 NO + 1 NC --	⊙ B	3SE5 232-0QV40-1AA1		1	1 unit	102	0.150
With M12 connector socket, 4-pole (250 V, 4 A)									
	Slow-action contacts	1 NO + 1 NC --	⊙ B	3SE5 234-0RV40-1AC4		1	1 unit	102	0.165
	Slow-action contacts	1 NO + 2 NC --	⊙ B	3SE5 234-0QV40-1AE0		1	1 unit	102	0.170
With 2 LEDs, yellow/green									
	Slow-action contacts	1 NO + 1 NC 24 V DC	⊙ B	3SE5 232-1RV40		1	1 unit	102	0.155
	Slow-action contacts	1 NO + 1 NC 230 V AC	⊙ B	3SE5 232-3RV40		1	1 unit	102	0.110
With M12 connector socket, 5-pole (125 V, 4 A) and 2 LEDs									
	Slow-action contacts	1 NO + 1 NC 24 V DC	⊙ C	3SE5 234-1RV40-1AF3		1	1 unit	102	0.175
Enclosure width 50 mm									
5 directions of approach									
	Slow-action contacts	1 NO + 2 NC --	⊙ B	3SE5 242-0QV40		1	1 unit	102	0.110
With increased minimum pull-out force 30 N									
	Slow-action contacts	1 NO + 1 NC --	⊙ B	3SE5 242-0RV40-1AA1		1	1 unit	102	0.110
With 2 LEDs, yellow/green									
	Slow-action contacts	1 NO + 2 NC 24 V DC	⊙ B	3SE5 242-1QV40		1	1 unit	102	0.120
	Slow-action contacts	1 NO + 2 NC 230 V AC	⊙ C	3SE5 242-3QV40		1	1 unit	102	0.120

⊙ Positive opening according to IEC 6094751, Appendix K.

1) Supplied without actuator. Please order separately (see page 13/86).

For 1/2" NPT adaptors and cable glands, see page 13/48.

SIRIUS 3SE5 Interlock Switches

3SE5, plastic enclosures – Enclosure width 40 mm acc. to EN 50041

Selection and ordering data

Complete units

2 or 3 contacts · 5 directions of approach · Degree of protection IP66/IP67 · Cable entry M20 × 1.5

Version ¹⁾	Contacts	LEDs	DT	Complete units	PU (UNIT, SET, M)	PS*
						
				Order No.	Price per PU	

Enclosure width 40 mm acc. to EN 50041



With separate actuator

5 directions of approach								
Slow-action contacts	1 NO + 2 NC	—	↻ B	3SE5 132-0QV20	1	1 unit		
With 2 LEDs, yellow/green								
Slow-action contacts	1 NO + 2 NC	24 V DC	↻ C	3SE5 132-1QV20	1	1 unit		
Slow-action contacts	1 NO + 2 NC	230 V AC	↻ C	3SE5 132-3QV20	1	1 unit		



With 2 LEDs

 For online configurator see www.siemens.com/sirius/configurators.

 Positive opening according to IEC 60947-5-1, Appendix K.

1) Supplied without actuator. Please order separately (see page 13/86).

SIRIUS 3SE5 Interlock Switches

3SE5, metal enclosures – Enclosure width 31 mm acc. to EN 50047



Selection and ordering data

Complete units

2 or 3 contacts · 5 directions of approach · Degree of protection IP66/IP67 · Cable entry M20 × 1.5

Version ¹⁾	Contacts	LEDs	DT	Complete units	PU (UNIT, SET, M)	PS*
						
				Order No.	Price per PU	

Enclosure width 31 mm acc. to EN 50047

		Contacts	LEDs	DT	Order No.	Price per PU	PU (UNIT, SET, M)	PS*
	5 directions of approach							
	Slow-action contacts	1 NO + 1 NC	—	↻ A	3SE5 212-0RV40		1	1 unit
	Slow-action contacts	1 NO + 2 NC	—	↻ B	3SE5 212-0QV40		1	1 unit
	With 2 LEDs, yellow/green							
	Slow-action contacts	1 NO + 1 NC	24 V DC	↻ B	3SE5 212-1RV40		1	1 unit
	Slow-action contacts	1 NO + 1 NC	230 V AC	↻ B	3SE5 212-3RV40		1	1 unit

 For online configurator see www.siemens.com/sirius/configurators.

 Positive opening according to IEC 60947-5-1, Appendix K.

1) Supplied without actuator. Please order separately (see page 13/86).

SIRIUS 3SE5 Interlock Switches

3SE5, metal enclosures with separate actuator

Selection and ordering data

Complete units

2 or 3 contacts · 5 directions of approach · Degree of protection IP66/IP67 · Cable entry M20 × 1.5

Version ¹⁾	Contacts	LEDs	DT	Complete units	PU (UNIT, SET, M)	PS*	PG	Weight per PU approx.
				Order No.	List Price \$ per PU			kg

Enclosure width 40 mm to EN 50041



With separate actuator

5 directions of approach								
Slow-action contacts	1 NO + 2 NC --		⊕ ▶	3SE5 112-0QV10		1	1 unit	102 0.360
With increased minimum pull-out force 30 N								
Slow-action contacts	1 NO + 2 NC --		⊕ B	3SE5 112-0QV10-1AA7		1	1 unit	102 0.360



With M12 socket

With M12 connector socket, 5-pole (125 V, 4 A)								
Slow-action contacts	1 NO + 1 NC --		⊕ C	3SE5 114-0RV10-1AC5		1	1 unit	102 0.360
Slow-action contacts	2 NC --		⊕ C	3SE5 114-0QV10-1AE1		1	1 unit	102 0.360
With connector socket, 6-pole + PE (250 V, 10 A)								
Slow-action contacts	1 NO + 2 NC --		⊕ C	3SE5 115-0QV10-1AD1		1	1 unit	102 0.380



With 2 LEDs

With 2 LEDs, yellow/green								
Slow-action contacts	1 NO + 2 NC 24 V DC		⊕ B	3SE5 112-1QV10		1	1 unit	102 0.370
Slow-action contacts	1 NO + 2 NC 230 V AC		⊕ C	3SE5 112-3QV10		1	1 unit	102 0.370
With M12 connector socket, 5-pole (125 V, 4 A) and 2 LEDs								
Slow-action contacts	1 NO + 1 NC 24 V DC		⊕ C	3SE5 114-1RV10-1AF3		1	1 unit	102 0.360
With connector socket, 6-pole + PE (10 A) and 2 LEDs								
Slow-action contacts	1 NO + 1 NC 24 V DC		⊕ C	3SE5 115-1RV10-1AF2		1	1 unit	102 0.380

Enclosure width 56 mm



With separate actuator

5 directions of approach								
Slow-action contacts	1 NO + 2 NC --		⊕ ▶	3SE5 122-0QV10		1	1 unit	102 0.360
With increased minimum pull-out force 30 N								
Slow-action contacts	1 NO + 2 NC --		⊕ B	3SE5 122-0QV10-1AA7		1	1 unit	102 0.360



With 2 LEDs

With 2 LEDs, yellow/green								
Slow-action contacts	1 NO + 2 NC 24 V DC		⊕ ▶	3SE5 122-1QV10		1	1 unit	102 0.370
Slow-action contacts	1 NO + 2 NC 230 V AC		⊕ C	3SE5 122-3QV10		1	1 unit	102 0.370

⊕ Positive opening according to IEC 60947-5-1, Appendix K.

1) Supplied without actuator. Please order separately (see page 13/86).

For 1/2" NPT adaptors and cable glands, see page 13/48.

SIRIUS 3SE5 Interlock Switches

3SE5, metal and plastic enclosures – Accessories

Selection and ordering data

Version	DT	Order No.	List Price \$ per PU	PU (UNIT, SET, M)	PS*	PG	Weight per PU approx. kg
Actuators for 3SE5							
 3SE5 000-0AV01		Standard actuators, length 75.6 mm	A	3SE5 000-0AV01	1	1 unit	102 0.040
 3SE5 000-0AV02		With vertical fixing, length 53 mm	▶	3SE5 000-0AV02	1	1 unit	102 0.070
 3SE5 000-0AV03		With transverse fixing, length 47 mm	▶	3SE5 000-0AV03	1	1 unit	102 0.070
 3SE5 000-0AV06		Radius actuators, length 51 mm	▶	3SE5 000-0AV04	1	1 unit	102 0.070
		• Direction of approach from the left	▶	3SE5 000-0AV06	1	1 unit	102 0.070
		• Direction of approach from the right	A				
 3SE5 000-0AV05		Universal radius actuators, length 77 mm	▶	3SE5 000-0AV05	1	1 unit	102 0.090
 3SE5 000-0AV07		Universal radius actuators, heavy-duty	A	3SE5 000-0AV07-1AK2	1	1 unit	102 0.120
		• Length 67 mm	A	3SE5 000-0AV07	1	1 unit	102 0.090
		• Length 77 mm					
Optional accessories for 3SE5							
 3SE5 000-0AV08-1AA2		Protective caps made of black rubber for the actuator head, to protect the actuator openings from contamination Not to be used for 3SE5 2.. plastic enclosures.	B	3SE5 000-0AV08-1AA2	1	1 unit	102 0.010
 3SE5 000-0AV08-1AA3		Blocking inserts , high-grade steel, for actuator head, for up to 8 padlocks	B	3SE5 000-0AV08-1AA3	1	1 unit	102 0.065
Connections for 3SE5, 3SE2							
 3SY3 127		Connector sockets (4-pole), M12, fixed for M20 x 1.5 For max. 250 V, 4 A With 0.25 mm ² connecting cable, plastic, degree of protection IP67, ambient temperature -40 to +85 °C	B	3SY3 127	1	1 unit	102 0.010
 3RX8 000		Cable boxes (4-pole), M12 With terminal compartment, can be pre-assembled	A	3RX8 000-0CB45	1	1 unit	574 0.015
		Angular cable boxes (4-pole), M12 With terminal compartment, can be pre-assembled	A	3RX8 000-0CC45	1	1 unit	574 0.015
 3SX9 926		Connector sockets (5-pole), M12, fixed for M20 x 1.5 For max. 125 V, 4 A With 0.25 mm ² connecting cable, plastic, degree of protection IP67, ambient temperature -40 to +85 °C	B	3SY3 128	1	1 unit	102 0.010
		Cable boxes (5-pole), M12 With terminal compart., can be pre-assembled	A	3RX8 000-0CB55	1	1 unit	574 0.016
		Angular cable boxes (5-pole), M12 With terminal compart., can be pre-assembled	A	3RX8 000-0CC55	1	1 unit	574 0.016
		Cable glands M20 x 1.5 Plastic	A	3SX9 926	1	1 unit	102 0.010

3SE2 Interlock Switches

3SE2, plastic enclosures with separate actuator

Selection and ordering data

1 contact · 3 contacts · Moving double-break contacts ^{1) 2)}

Actuation	Enclosure width	Length of actuator	DT	3SE. position switches with 3 slow-action contacts	3SE. position switches with 1 slow-action contact	Wght. approx.
				<p>Ident. No. 12 acc. to EN 50 013</p>	<p>Ident. No. 01 acc. to EN 50 013</p>	
	mm	mm		Order No.	List Price \$ 1 unit	kg
					Order No.	List Price \$ 1 unit
						kg

Molded plastic enclosure IP 67

3SE2 243-0XX

Top and side entry¹⁾



M20 x 1.5 connecting thread

- Extraction force 5 N 52
- Extraction force 30 N 52
- With automatic ejection 52

M16 x 1.5 connecting thread

- Extraction force 5 N 52
- Extraction force 30 N 52
- With automatic ejection 52

Actuators



- Standard actuator ($r_{min.} = 150$ mm) 28



- Radius actuator (universal) ($r_{min.} = 45$ mm) 33



- Ball catch (up to 100 N) 28



- Actuator with dust protector and slit cover (1 set) 34

- Radius actuator 82

Accessories

- Slit cover only for 3SX3234 (1 set = 3 units)

- 3SE2 243-0XX40 0.140
- 3SE2 243-0XX 0.140
- 3SE2 243-0XX30 0.140

- 3SE2 243-0XX48 0.140
- 3SE2 243-0XX18 0.140
- 3SE2 243-0XX38 0.140

- 3SE2 257-6XX40 0.120
- 3SE2 257-6XX 0.120
- 3SE2 257-6XX30 0.120

- 3SE2 257-6XX48 0.140
- 3SE2 257-6XX18 0.140
- 3SE2 257-6XX38 0.140

3SX3 218

0.020

3SX3 228

0.025

3SX3 217

0.035

3SX3 234

0.035

3SX3 256

0.020

3SX3 233

0.005

For operation, operating speed and travel, see Page 13/92.

→ Positive opening acc. to IEC 60 947-5-1, Appendix K, and DIN VDE 0660 Part 200.

1) Supplied without actuator.

2) For conduit thread adaptors, see page 13/48.

SIRIUS 3SE5 Interlock Switches

Technical data

Benefits

The 3SE5 position switches with separate actuator differ from the previous series through the following new characteristics:

- All enclosure sizes with increased corrosion protection
- All enclosure sizes are optionally available with a LED signaling indicator.
- The three-pole contact block 1 NO + 2 NC is available for all enclosure sizes.
- The plastic enclosure has simple and fast wiring equipment which makes it possible to save from approx. 20 to 25 % of the time when connecting.
- The ASIsafe electric component is integrated for the versions with the AS-Interface connection (see online); an adapter is not required.

Application

Position switches with separate actuator are used where the position of doors, covers or protective grills must be monitored for safety reasons.

The position switch can only be operated with the matching coded actuator. Simple overruling by hand or auxiliary devices is impossible.

Devices are available with enclosure versions to suit the particular ambient conditions. Different control tasks can be performed with the best contact blocks suited for the particular purpose. Dimensions, fixing points of the enclosure are in

accordance with EN 50041 or EN 50047 standards. The devices are suitable for use in any climate.

Standards

IEC 60947-5-1 or EN 60947-5-1.

The protective measure of "total insulation" by the molded-plastic enclosure is guaranteed by the use of molded-plastic screw-lands.

Safety position switches

For controls according to IEC 60204-1 or EN 60204-1 the devices can be used as a safety position switch. To secure position switches against changes in their position, keyed techniques must be employed on installation.

Safety circuits

IEC 60947-5-1 and EN 60947-5-1 require positive opening of the NC contacts, i.e. for the purposes of personal safety, the assured opening of NC contacts is expressly stipulated for the electrical equipment of machines in all safety circuits and marked according to the IEC standard 60947-5-1 with the symbol ☞.

Category 3 according to ISO 13849-1 (EN 954-1) can be attained with a position switch with a separate actuator if the corresponding failsafe evaluation units are selected and correctly installed, e.g. the 3TK28 safety relays or matching units from the ASIsafe, SIMATIC or SINUMERIK product ranges.

Category 4 can be achieved when using an additional position switch.

Technical specifications

Type		3SE5 1...-V.., 3SE5 2...-V..	3SE2 257-XX..	3SE2 243-XX..			
General data							
Standards		IEC 60947-5-1, EN 60947-5-1					
Rated insulation voltage U_i	V	400	500				
Pollution degree acc. to IEC 60664-1		Class 3	Class 3				
Rated impulse withstand voltage U_{imp}	kV	6					
Rated operational voltage U_e	V	400 AC; over 300 V AC only equal potential	500 AC; over 380 V AC only equal potential				
Conventional thermal current I_{th}	A	6	10				
Rated operational current I_e		2-pole	3-pole	1-pole	3-pole		
• With alternating current 50/60 Hz		$I_e/AC-15$	$I_e/AC-15$	$I_e/AC-12$	$I_e/AC-15$	$I_e/AC-12$	$I_e/AC-15$
- At 24 V	A	6	6	10	10	10	10
- At 120 V	A	6	3	10	10	10	10
- At 240 V	A	3	1.5	10	6	10	4
- At 400 V	A	—	—	10	4	10	4
- At 500 V	A	—	—	10	3	10	3
• For direct current		$I_e/DC-13$	$I_e/DC-13$	$I_e/DC-12$	$I_e/DC-13$	$I_e/DC-12$	$I_e/DC-13$
- At 24 V	A	3	3	10	10	10	10
- At 125 V	A	0.55	0.55	—	—	—	—
- At 250 V	A	0.27	0.27	—	—	—	—
- At 110 V	A	—	—	4	1	4	1
- At 220 V	A	—	—	1	0.4	1	0.4
- At 440 V	A	—	—	0.5	0.2	0.5	0.2
Short-circuit protection¹⁾							
• With DIAZED fuse links, gG operational class	A	6	6				
• With fuse links, quick		—	10				
• With miniature circuit breaker, Char. C	A	1	2	—			
Mechanical endurance		1 × 10 ⁶ operating cycles					
Electrical endurance							
• With 3RH.1, 3RT contactors in size S00, S0		10 × 10 ⁶ operating cycles		> 1 × 10 ⁶ operating cycles			
• For utilization category AC-15 when switching off $I_e/AC-15$ at 240 V		0.1 × 10 ⁶ operating cycles		0.5 × 10 ⁶ operating cycles			
Switching frequency		6000 operating cycles/h					
With 3RH.1, 3RT contactors in size S00, S0							
Minimum pull-out force for positive opening	N	20	10		30		

SIRIUS 3SE5 Interlock Switches

3SE5 with separate actuator – Metal and plastic enclosures

Configuration

Operation and operating travel of actuators

<p>Operation by a separate actuator</p> <p>⊕ Positive opening acc. to EN 60947-5-1</p> <p>v_{max} Max. actuating speed</p> <p>→ Direction of operation</p>	<p>Contact blocks</p> <p>Terminal designation acc. to EN 50013</p>	<p>Nominal travel</p> <p>■ Contact closed</p> <p>□ Contact open</p> <p>Actuator in actuator head: NC is closed</p>
--	---	---

Separate actuators

Standard actuators

Axial and lateral actuation ($4 \times 90^\circ$)

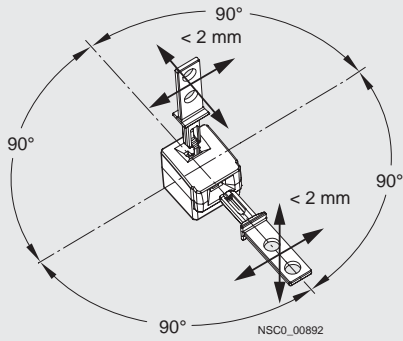

Minimum force required in operating direction 30 N (on retraction)

Slow-action contacts

1 NO + 1 NC

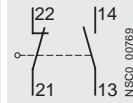

Ident. No. 11

Lateral actuation

3SE5 ...-RV..

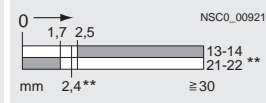

Axial actuation

3SE5 ...-RV..

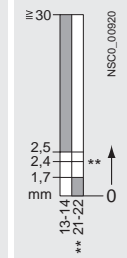

1 NO + 2 NC

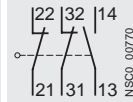

Ident. No. 12

3SE5 ...-QV..

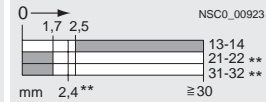

3SE5 ...-QV..

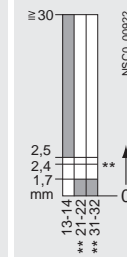

Radius actuators (all directions of approach)

Example: direction of approach from the left

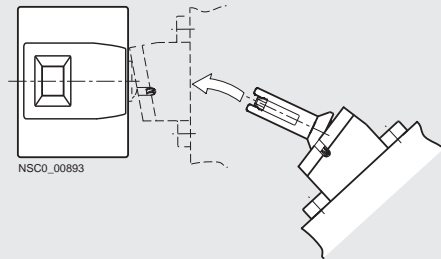

For connector assignment, see page 13/61.

SIRIUS 3SE5 Interlock Switches

3SE5 with separate actuator – Metal and plastic enclosures

Dimensional drawings

Complete units

Enclosure width 31 mm
3SE5 23.-.QV40, 3SE5 23.-.RV40

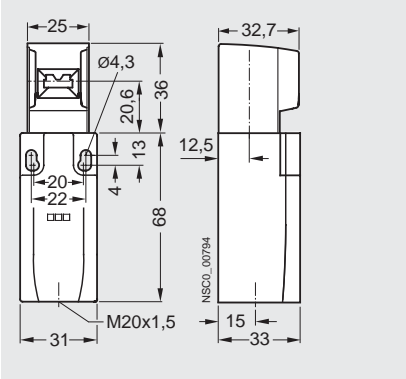

Enclosure width 50 mm
3SE5 24.-.QV40, 3SE5 24.-.RV40

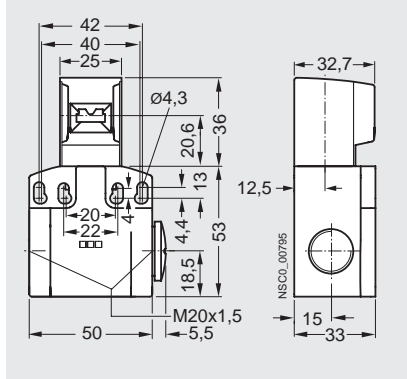

Enclosure width 40 mm
3SE5 11.-.QV10, 3SE5 11.-.RV10

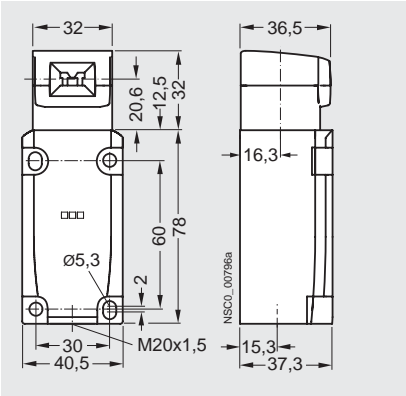

Enclosure width 56 mm
3SE5 12.-.QV10, 3SE5 12.-.RV10

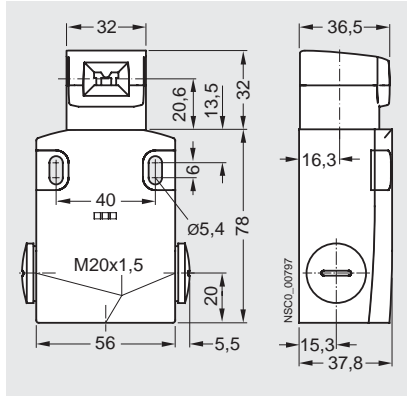

Actuators

3SE5 000-0AV01
standard actuator

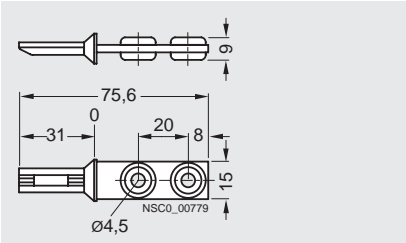

3SE5 000-0AV02
actuator with vertical fixing

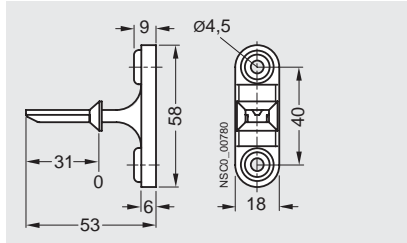

3SE5 000-0AV03
actuator with horizontal fixing

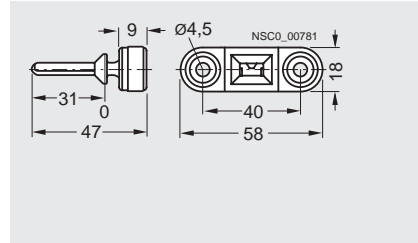

3SE5 000-0AV04
radius actuator, approach from left

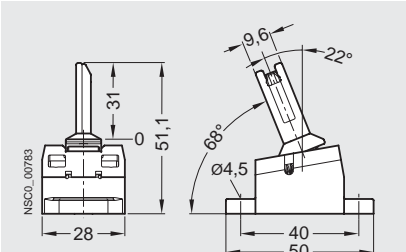

3SE5 000-0AV06
radius actuator approach from right

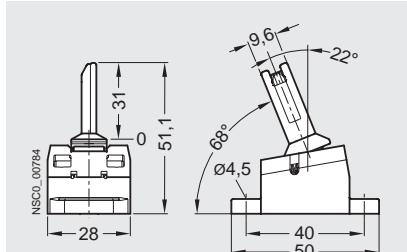

3SE5 000-0AV05
universal radius actuator

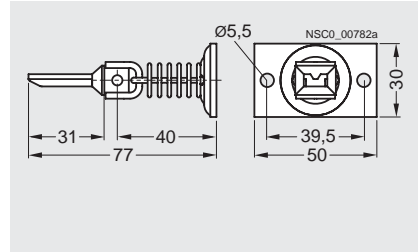

SIRIUS 3SE5 Interlock Switches

3SE5 with separate actuator – Metal and plastic enclosures

3SE5 000-0AV07
universal radius actuator, heavy duty

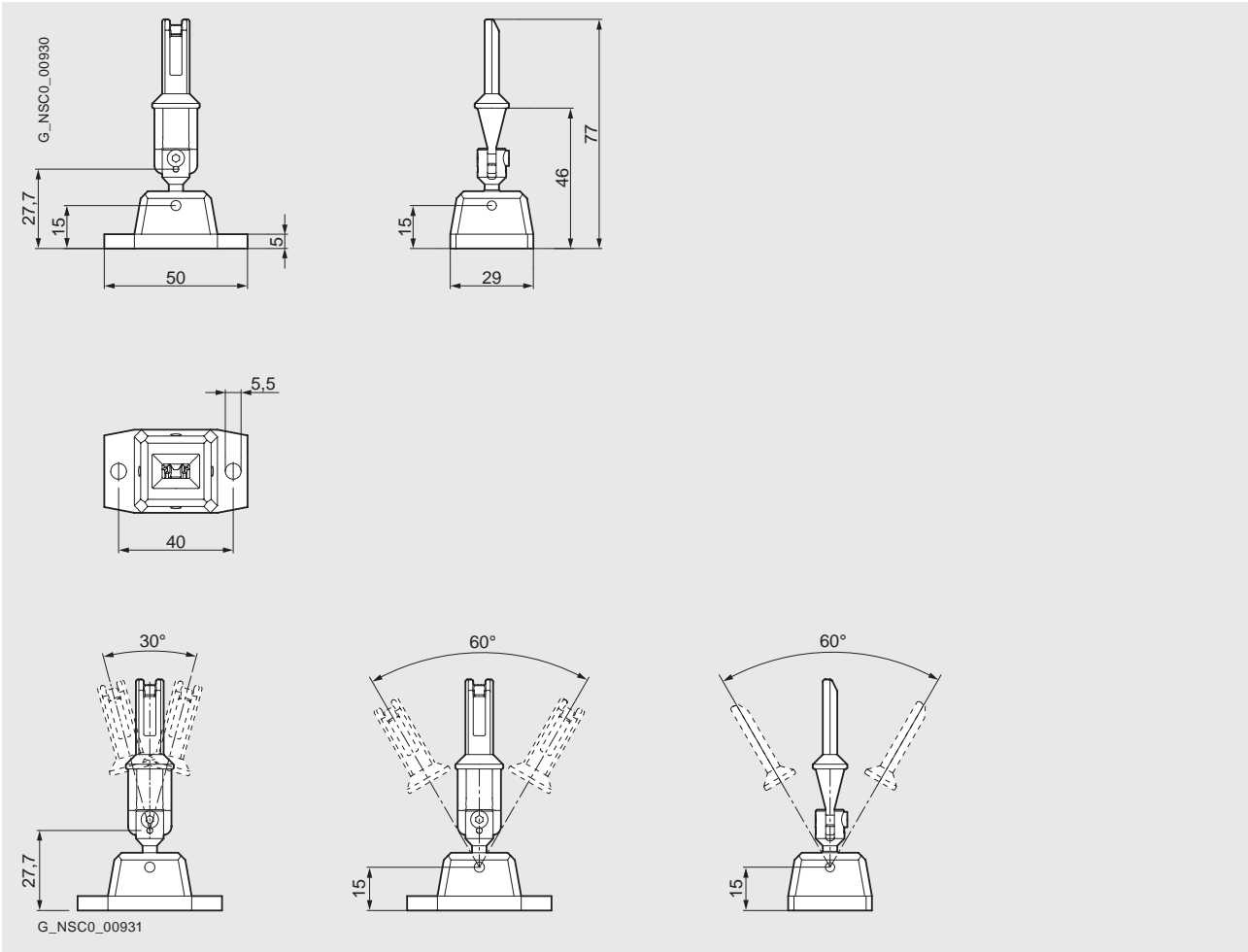

SIRIUS 3SE5 Interlock Switches

3SE2 with separate actuator – Plastic enclosures

Configuration

Operation and operating travel of actuators

<p>Operation by a separate actuator</p> <p>v_{max} Max. actuating speed \rightarrow Direction of operation</p> <p>Radius actuation: for all directions of approach</p>	<p>Contact blocks</p> <p>Terminal designation acc. to EN 50013</p>	<p>Nominal travel</p> <p>■ Contact closed □ Contact open</p> <p>Actuator in actuator head: NC is closed</p>	<p>Minimum force required in operating direction on retraction</p>
---	---	--	--

Separate actuators

Standard and radius actuators

Axial and lateral actuation

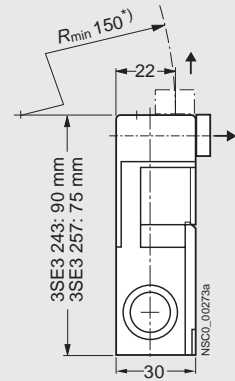

*) Radius actuator: $R_{min} > 38$ mm.

Slow-action contacts

1 NC



Ident. No. 01

1 NO + 2 NC

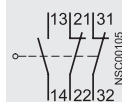

Ident. No. 12

Lateral actuation

3SE2 257-XX..

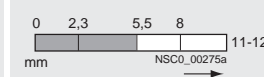

30 N
or
5 N

3SE2 243-XX..

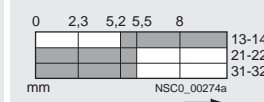

30 N
or
5 N

Dimensional drawings

3SE2 243, lateral and front-end actuation, with 3SX3 218 standard actuator

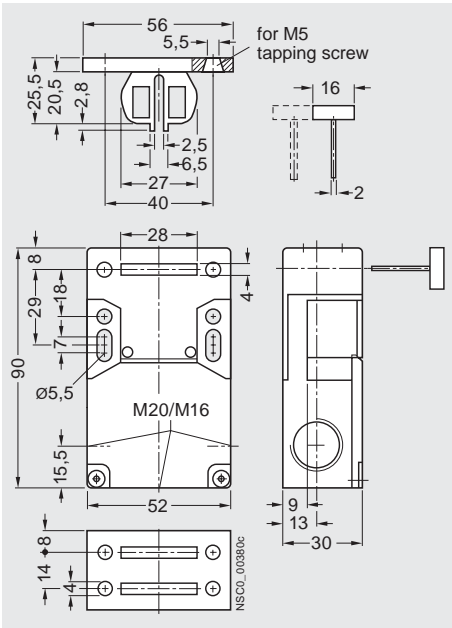

3SE2 257, lateral and front-end actuation

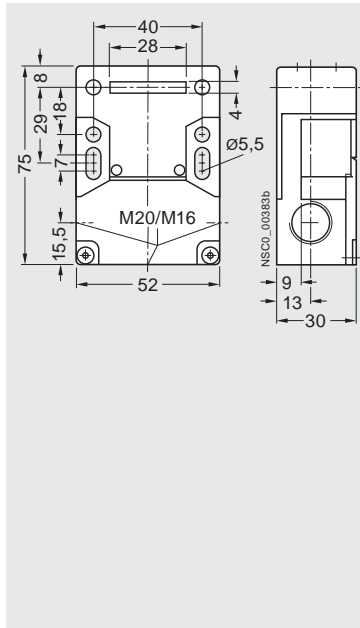

3SX3 228 universal radius actuator

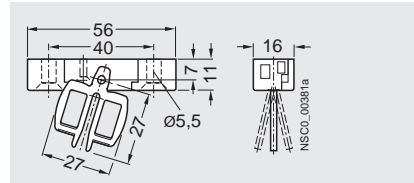

3SX3 217 actuator with ball locating

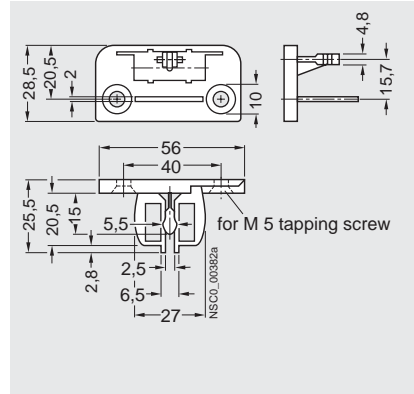

SIRIUS 3SE5 Interlock Switches

3SE5 / 3SE2 with solenoid locking – General data

Overview

The position switches with solenoid interlocking are exceptional, technically safe devices which restrict and prevent an unforeseen or intentional opening of protective doors, protective grilles or other covers as long as a dangerous situation is present (i.e. follow-on motion of the shutdown machine).



The safety position switches with solenoid interlocking are comprised of a switch part with electromechanical interlock and a mechanical actuator which has to be ordered separately.

They are rugged protective devices that enable the greatest possible safety for man and machine.

The position switches with solenoid interlocking are offered in plastic or metal enclosures.

Dimensions (W × H × D):

- 3SE5 3: 54 mm × 185 mm × 43.5 mm,
- 3SE2 8: 90 mm × 100 mm (+ head 41.3 mm) × 45 mm.

Operation

The actuator head is included in the scope of supply. For actuation from four directions it can be adjusted through 4 × 90°. The 3SE5 3 switches can also be approached from above.

The actuators are not included in the scope of supply of the position switch and must be ordered separately from a choice of six versions to suit the application (see page 13/97).

Actuation data:

- Maximum actuating speed $v_{\max} = 1.5$ m/s
- Minimum actuating speed $v_{\min} = 0.4$ mm/s
- Minimum force in the direction of actuation $F_{\min} = 30$ N

The actuator is encoded. Simple overruling by hand or auxiliary devices is impossible.

Radius actuators

The position switches with radius actuators are particularly suitable for rotatable protective devices. The movable actuation key allows even small radii to be approached. Damage to the switch and the actuator due to inaccurate approach is prevented.

Locking devices

A high-grade steel locking device for attaching up to eight padlocks is available for even more safety (see page 13/97).

Dust protection

A rubber cap to protect the actuator head from contamination is available for operation in dusty environments (see page 13/97).

Solenoid interlocking

There are two versions for locking the actuator:

- Spring-actuated lock (closed-circuit principle) with various release mechanisms
- Magnetic field lock (open-circuit principle)

The spring-actuated switch is equipped with an auxiliary release for emergency situations or setup mode. Available as options:

- Escape release or
- Emergency release

Contact blocks

The position switches with solenoid interlocking have one contact block each for:

- Monitoring the actuator or the position of the protective door
- Monitoring the position of the solenoid

The mechanical design of the switch corresponds to the requirements of the failsafe principle according to EN 1088.

Optical signaling equipment

The position switches with solenoid interlocking are available with an optional optical signaling device.

The signaling device indicates the switch position of the lock and the protective device optically by means of 2 LEDs on the front.

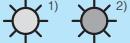
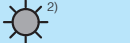
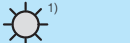
Protective device	Interlock	Display	Meaning
Closed	Released		Actuator free to be pulled
Closed	Closed		Actuator locked
Open	Open		Actuator pulled

Note:

The voltage of the LEDs at the monitored contacts must be the same as the operational voltage of the solenoid (same potential).

¹⁾ Yellow LED.

²⁾ Green LED.

SIRIUS 3SE5 Interlock Switches

3SE5 / 3SE2 with solenoid locking – General data

Benefits

The new generation of 3SE5 3 position switches offers:

- More safety through higher locking forces:
 - 1300 N with plastic enclosure
 - 2600 N with metal enclosure
- Various release mechanisms: lock release, escape release and emergency release
- Two contact blocks each with three contacts as standard equipment, hence fewer versions needed
- Same dimensions for all enclosure variants: Plastic, metal or with integrated ASIsafe
- An extensive range of actuators
- An optional LED status display 24 V DC, 115 V AC or 230 V AC for all switch variants

Application

The position switches with solenoid interlocking are exceptional, technically safe devices which restrict and prevent an unforeseen or intentional opening of protective doors, protective grilles or other covers as long as a dangerous situation is present (i.e. follow-on motion of the shutdown machine).

The safety position switches with solenoid interlocking have the following functions:

- Enabling the machine or process with closed and locked protective device
- Locking the machine or process with opened protective device
- Position monitoring of the protective device and solenoid

Standards

The switches comply with the standards IEC 60947-1 (Low-Voltage Controlgear, General) and IEC 60947-5-1 (Electromechanical Control Devices).

The mechanical design of the switch corresponds to the requirements of the failsafe principle according to EN 1088.

Approvals

The switches are approved for use with locking devices according to EN 1088 and EN 292, Parts 1 and 2.

3SE5 3 position switches with solenoid interlocking bear the VDE test mark for tested according to GS-ET 19 (Test Principles of the German Trade Association for Locking Devices with Electromagnetic Interlocks).

The 3SE2 8 metal-enclosed position switches with solenoid interlocking have been awarded a test certificate from the BIA (Berufsgenossenschaftliches Institut für Arbeitssicherheit).

Category 3 according to ISO 13849-1 (EN 954-1) can be attained with a position switch with solenoid interlocking if the corresponding failsafe evaluation units are selected and correctly installed, e. g. the 3TK28 safety relays or matching units from the ASIsafe, SIMATIC or SINUMERIK product ranges.

Category 4 can be achieved when using an additional position switch.

They are approved according to UL 508, UL 50 and UL 746-C.

Solenoid interlocking

The separate actuator operates in a similar way to the coding of a key and protects against manipulation. It transmits the locking force to the protective device and helps to monitor its position.

There are two versions of locking:

Spring-actuated lock (closed-circuit principle)

- In the standard version, the position switch locks by means of spring force and releases by means of electromagnetic force. In the case of voltage failure, it reliably prevents the protective device from opening when machine parts are still moving.
- The switch is equipped with an auxiliary release for emergency situations or setup mode.
- An auxiliary release which can be secured with a lock to prevent misuse is available as a version.

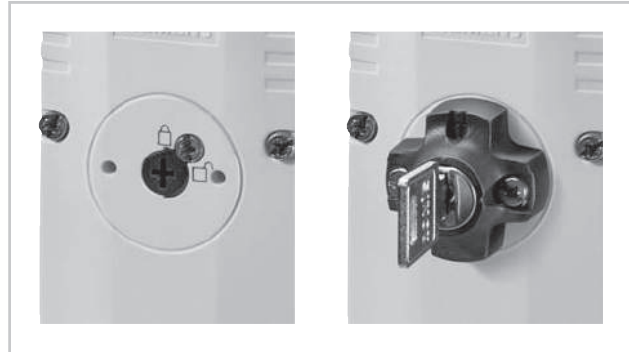

Auxiliary release

Auxiliary release with lock

The new 3SE5 3 position switches are also available with an escape release or an emergency release.

- Personnel working inside the hazard zone can use the escape release feature to manually release the interlock without tools from the escape side (hazardous area side) so that they can exit the hazard area. An intentional act (in this case pulling the gray actuator) is required to release the locking mechanism and restore the normal operating state.
- The emergency release enables someone in an emergency situation to manually release the interlock without tools from the access side (outside the hazardous area). Releasing the lock and restoring the normal operating state must require effort which is comparable to repair activity, in this case disassembly of the red actuator and resetting the mechanical lock.

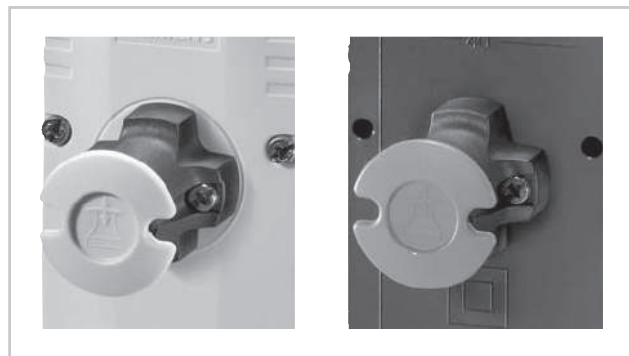

Escape release from the front

Emergency release from the back

Magnetic field lock (open-circuit principle)

- The second version offers locking by means of electromagnetic force and release by means of spring force. This version has an advantage when it is necessary to quickly access the machine after a power failure occurs, or in the case of very short overtravel times.

SIRIUS 3SE5 Interlock Switches







3SE5, plastic enclosures with locking force up to 1200 N

Selection and ordering data

6 slow-action contacts · 5 directions of approach · Cable entry 3 × M20 × 1.5 · Degree of protection IP66/IP67
 Locking force 1300 N (1000 N according to GS-ET 19)

Interlock ¹⁾	LEDs	Solenoid Rated operational voltage	DT	Complete units Position monitoring: Actuators: 1 NO + 2 NC Solenoid: 1 NO + 2 NC	PU (UNIT, SET, M)	PS*	PG	Weight per PU approx.
		V		Order No.	Price \$ per PU			kg

1300 N locking force · Enclosure width 54 mm

		Interlock ¹⁾	LEDs	Solenoid Rated operational voltage	DT	Complete units Position monitoring: Actuators: 1 NO + 2 NC Solenoid: 1 NO + 2 NC	PU (UNIT, SET, M)	PS*	PG	Weight per PU approx.
				V		Order No.	Price \$ per PU			kg
	Spring-actuated locks									
	• With auxiliary release	--		24 DC	⊕ A	3SE5 322-0SD21	1	1 unit	102	0.590
		--		115 AC	⊕ B	3SE5 322-0SD22	1	1 unit	102	0.590
		--		230 AC	⊕ B	3SE5 322-0SD23	1	1 unit	102	0.590
		Yellow/Green		24 DC	⊕ A	3SE5 322-1SD21	1	1 unit	102	0.590
		Yellow/Green		115 AC	⊕ B	3SE5 322-2SD22	1	1 unit	102	0.590
	Yellow/Green		230 AC	⊕ B	3SE5 322-3SD23	1	1 unit	102	0.590	
	• With auxiliary release With lock	--		24 DC	⊕ ▶	3SE5 322-0SE21	1	1 unit	102	0.745
		--		115 AC	⊕ B	3SE5 322-0SE22	1	1 unit	102	0.745
		--		230 AC	⊕ B	3SE5 322-0SE23	1	1 unit	102	0.745
		Yellow/Green		24 DC	⊕ B	3SE5 322-1SE21	1	1 unit	102	0.745
		Yellow/Green		115 AC	⊕ B	3SE5 322-2SE22	1	1 unit	102	0.745
		Yellow/Green		230 AC	⊕ B	3SE5 322-3SE23	1	1 unit	102	0.745
	• With escape release from the front	--		24 DC	⊕ B	3SE5 322-0SF21	1	1 unit	102	0.590
		--		115 AC	⊕ B	3SE5 322-0SF22	1	1 unit	102	0.590
		--		230 AC	⊕ B	3SE5 322-0SF23	1	1 unit	102	0.590
		Yellow/Green		24 DC	⊕ B	3SE5 322-1SF21	1	1 unit	102	0.590
		Yellow/Green		115 AC	⊕ B	3SE5 322-2SF22	1	1 unit	102	0.590
		Yellow/Green		230 AC	⊕ B	3SE5 322-3SF23	1	1 unit	102	0.590
	• With escape release from the front and emergency release from back	--		24 DC	⊕ B	3SE5 322-0SL21	1	1 unit	102	0.590
	• For ambient temperature up to to -40 °C	--		24 DC	⊕ B	3SE5 322-0SL21-1AJ0	1	1 unit	102	0.590
	• With escape release from the back and auxiliary release from the front	--		24 DC	⊕ B	3SE5 322-0SG21	1	1 unit	102	0.590
		--		115 AC	⊕ B	3SE5 322-0SG22	1	1 unit	102	0.590
		--		230 AC	⊕ B	3SE5 322-0SG23	1	1 unit	102	0.590
		Yellow/Green		24 DC	⊕ ▶	3SE5 322-1SG21	1	1 unit	102	0.590
	• With escape release from the back and auxiliary release with lock from the front	--		24 DC	⊕ B	3SE5 322-0SH21	1	1 unit	102	0.745
	• With emergency release from the back and auxiliary release from the front	--		24 DC	⊕ B	3SE5 322-0SJ21	1	1 unit	102	0.745
		--		115 AC	⊕ B	3SE5 322-0SJ22	1	1 unit	102	0.745
		--		230 AC	⊕ B	3SE5 322-0SJ23	1	1 unit	102	0.745
		Yellow/Green		24 DC	⊕ B	3SE5 322-1SJ21	1	1 unit	102	0.745
		Yellow/Green		115 AC	⊕ B	3SE5 322-2SJ22	1	1 unit	102	0.745
	• With emergency release from the back and auxiliary release from the front	--		230 AC	⊕ B	3SE5 322-3SJ23	1	1 unit	102	0.745
		Yellow/Green		24 DC	⊕ A	3SE5 322-1SB21	1	1 unit	102	0.590
		Yellow/Green		115 AC	⊕ B	3SE5 322-2SB22	1	1 unit	102	0.590
		Yellow/Green		230 AC	⊕ B	3SE5 322-3SB23	1	1 unit	102	0.590
		Yellow/Green		24 DC	⊕ A	3SE5 322-1SB21	1	1 unit	102	0.590
		Yellow/Green		115 AC	⊕ B	3SE5 322-2SB22	1	1 unit	102	0.590
	Magnetic field locks	--		24 DC	⊕ ▶	3SE5 322-0SB21	1	1 unit	102	0.590
		--		115 AC	⊕ B	3SE5 322-0SB22	1	1 unit	102	0.590
		--		230 AC	⊕ B	3SE5 322-0SB23	1	1 unit	102	0.590

⊕ Positive opening according to IEC 60947-5-1, Appendix K.

1) Supplied without actuator. Please order separately (see page 13/97).

For 1/2" NPT adaptors and cable glands, see page 13/48.

SIRIUS 3SE5 Interlock Switches

3SE5, metal enclosures with locking force up to 2000 N

Selection and ordering data

6 slow-action contacts · 5 directions of approach · Cable entry 3 × M20 × 1.5 · Degree of protection IP66/IP67
 Locking force 2600 N (2000 N according to GS-ET 19)

Interlock ¹⁾	LEDs	Solenoid Rated opera- tional voltage	DT	Complete units Position monitoring: Actuators: 1 NO + 2 NC Solenoid: 1 NO + 2 NC	<input type="checkbox"/>	PU (UNIT, SET, M)	PS*	PG	Weight per PU approx.
		V		Order No.	Price \$ per PU				kg

2600 N locking force · Enclosure width 54 mm

Spring-actuated locks

- With auxiliary release

--	24 DC	⊕ ▶	3SE5 312-0SD11	1	1 unit	102	1.030
--	115 AC	⊕ ▶	3SE5 312-0SD12	1	1 unit	102	1.030
--	230 AC	⊕ B	3SE5 312-0SD13	1	1 unit	102	1.030
Yellow/Green	24 DC	⊕ B	3SE5 312-1SD11	1	1 unit	102	1.040
Yellow/Green	115 AC	⊕ ▶	3SE5 312-2SD12	1	1 unit	102	1.040
Yellow/Green	230 AC	⊕ B	3SE5 312-3SD13	1	1 unit	102	1.040

3SE5 312-0SD1.

- With auxiliary release
With lock

--	24 DC	⊕ B	3SE5 312-0SE11	1	1 unit	102	1.180
--	115 AC	⊕ B	3SE5 312-0SE12	1	1 unit	102	1.180
--	230 AC	⊕ B	3SE5 312-0SE13	1	1 unit	102	1.180
48 AC/DC		⊕ C	3SE5 312-0SE14	1	1 unit	102	1.180
Yellow/Green	24 DC	⊕ B	3SE5 312-1SE11	1	1 unit	102	1.180
Yellow/Green	115 AC	⊕ B	3SE5 312-2SE12	1	1 unit	102	1.180
Yellow/Green	230 AC	⊕ B	3SE5 312-3SE13	1	1 unit	102	1.180

3SE5 312-0SE1.

- With escape release
from the front

--	24 DC	⊕ B	3SE5 312-0SF11	1	1 unit	102	1.180
--	115 AC	⊕ B	3SE5 312-0SF12	1	1 unit	102	1.180
--	230 AC	⊕ B	3SE5 312-0SF13	1	1 unit	102	1.180
Yellow/Green	24 DC	⊕ B	3SE5 312-1SF11	1	1 unit	102	1.180
Yellow/Green	115 AC	⊕ B	3SE5 312-2SF12	1	1 unit	102	1.180
Yellow/Green	230 AC	⊕ B	3SE5 312-3SF13	1	1 unit	102	1.180

3SE5 312-0SF1.

- With escape release
from the back
and auxiliary release
from the front

--	24 DC	⊕ B	3SE5 312-0SG11	1	1 unit	102	1.175
--	115 AC	⊕ B	3SE5 312-0SG12	1	1 unit	102	1.175
--	230 AC	⊕ B	3SE5 312-0SG13	1	1 unit	102	1.175
Yellow/Green	24 DC	⊕ ▶	3SE5 312-1SG11	1	1 unit	102	1.180
Yellow/Green	115 AC	⊕ B	3SE5 312-2SG12	1	1 unit	102	1.180
Yellow/Green	230 AC	⊕ B	3SE5 312-3SG13	1	1 unit	102	1.180

3SE5 312-0SG1.

- With escape release
from the back
and auxiliary release
with lock from the front

--	24 DC	⊕ B	3SE5 312-0SH11	1	1 unit	102	1.180
----	-------	-----	-----------------------	---	--------	-----	-------

- With emergency release
from the back
and auxiliary release
from the front

--	24 DC	⊕ B	3SE5 312-0SJ11	1	1 unit	102	1.180
--	115 AC	⊕ B	3SE5 312-0SJ12	1	1 unit	102	1.180
--	230 AC	⊕ B	3SE5 312-0SJ13	1	1 unit	102	1.180
Yellow/Green	24 DC	⊕ B	3SE5 312-1SJ11	1	1 unit	102	1.180
Yellow/Green	115 AC	⊕ B	3SE5 312-2SJ12	1	1 unit	102	1.180
Yellow/Green	230 AC	⊕ B	3SE5 312-3SJ13	1	1 unit	102	1.180

3SE5 312-0SJ1.

Magnetic field locks

--	24 DC	⊕ ▶	3SE5 312-0SB11	1	1 unit	102	1.030
--	115 AC	⊕ B	3SE5 312-0SB12	1	1 unit	102	1.030
--	230 AC	⊕ B	3SE5 312-0SB13	1	1 unit	102	1.030
Yellow/Green	24 DC	⊕ B	3SE5 312-1SB11	1	1 unit	102	1.040
Yellow/Green	115 AC	⊕ B	3SE5 312-2SB12	1	1 unit	102	1.040
Yellow/Green	230 AC	⊕ B	3SE5 312-3SB13	1	1 unit	102	1.040

3SE5 312-0SB1.

⊕ Positive opening according to IEC 60947-5-1, Appendix K.

1) Supplied without actuator. Please order separately (see page 13/97).

For 1/2" NPT adaptors and cable glands, see page 13/48.

SIRIUS 3SE5 Interlock Switches

3SE5, metal and plastic enclosures – Accessories

Selection and ordering data

Version	DT	Order No.	List Price \$ per PU	PU (UNIT, SET, M)	PS*	PG	Weight per PU approx. kg	
Actuators for 3SE5 ¹⁾								
 3SE5 000-0AV01		Standard actuators, length 75.6 mm	A	3SE5 000-0AV01	1	1 unit	102 0.040	
 3SE5 000-0AV02		With vertical fixing, length 53 mm	A	3SE5 000-0AV02	1	1 unit	102 0.070	
 3SE5 000-0AV03		With transverse fixing, length 47 mm	A	3SE5 000-0AV03	1	1 unit	102 0.070	
 3SE5 000-0AV04		Radius actuators, length 51 mm • Direction of approach from the left • Direction of approach from the right	A	3SE5 000-0AV04	1	1 unit	102 0.070	
	A		3SE5 000-0AV06	1	1 unit	102 0.070		
 3SE5 000-0AV05		Universal radius actuators, • Length 77 mm • Length 77 mm, tab rotated 90°	A	3SE5 000-0AV05	1	1 unit	102 0.090	
	A		3SE5 000-0AV05-1AA6	1	1 unit	102 0.090		
 3SE5 000-0AV07		Universal radius actuators, heavy-duty • Length 67 mm • Length 77 mm	A	3SE5 000-0AV07-1AK2	1	1 unit	102 0.120	
	A		3SE5 000-0AV07	1	1 unit	102 0.090		
Optional accessories for 3SE5								
 3SE5 000-0AV08-1AA2		Protective caps made of black rubber for the actuator head, to protect the actuator openings from contamination	B	3SE5 000-0AV08-1AA2	1	1 unit	102 0.010	
 3SE5 000-0AV08-1AA3		Blocking inserts , high-grade steel, for actuator head, for up to 8 padlocks	B	3SE5 000-0AV08-1AA3	1	1 unit	102 0.065	
Connections for 3SE5, 3SE2								
 3SY3 127		Connector sockets (4-pole), M12, fixed for M20 x 1.5 For max. 250 V, 4 A With 0.25 mm ² connecting cable, plastic, degree of protection IP67, ambient temperature -40 to +85 °C	B	3SY3 127	1	1 unit	102 0.010	
	 3RX8 000		Cable boxes (4-pole), M12, non-adjustable With terminal compartment, can be pre-assembled	A	3RX8 000-0CB45	1	1 unit	574 0.015
			Angular cable boxes (4-pole), M12 With terminal compartment, can be pre-assembled	A	3RX8 000-0CC45	1	1 unit	574 0.015
 3SX9 926		Connector sockets (5-pole), M12 for M20 x 1.5 For max. 125 V, 4 A With 0.25 mm ² connecting cable, plastic, degree of protection IP67, ambient temperature -40 to +85 °C	B	3SY3 128	1	1 unit	102 0.010	
		Cable boxes (5-pole), M12 With terminal compart., can be pre-assembled	A	3RX8 000-0CB55	1	1 unit	574 0.016	
		Angular cable boxes (5-pole), M12 With terminal compart., can be pre-assembled	A	3RX8 000-0CC55	1	1 unit	574 0.016	
		Cable glands M20 x 1.5 Plastic	A	3SX9 926	1	1 unit	102 0.010	

1) See page 13/90 for dimensions drawings.

SIRIUS 3SE5 Interlock Switches

3SE5 / 3SE2 with solenoid locking

Technical specifications

Type	3SE5 322	3SE5 312	3SE2 83, 3SE2 84	
General data				
Standards	IEC 60947-5-1, EN 60947-5-1			
Rated insulation voltage U_i	V	250		
Degree of pollution acc. to EN 60664-1		Class 3		
Rated impulse withstand voltage U_{imp}	kV	4	6	
Rated operational voltage U_e				
• DC	V	24	24	
• AC 50/60 Hz	V	230	110 ... 130	230
Conventional thermal current I_{th}	A	6	10	
Rated operational current I_e				
• With alternating current 50/60 Hz		I_e /AC-15 or B300	I_e /AC-12	I_e /AC-15
- At 24 V	A	6	10	4
- At 120 V	A	3	10	4
- At 230 V	A	1.5	10	4
• For direct current		I_e /DC-13 or Q300	I_e /DC-12	I_e /DC-13
- At 24 V	A	3	10	3
- At 60 V		--	5	1.5
- At 110 V		--	2.5	0.7
- At 125 V	A	0.55	--	--
- At 220 V		--	1	0.3
- At 250 V	A	0.27	--	--
Magnet				
• Locking force, max.	N	1300	2600	1820
• Locking force acc. to GS-ET 19	N	1000	2000	1400
• Power consumption at U_c	W	3.5	5.2	
Short-circuit protection¹⁾				
• With DIAZED fuse links, operational class gG	A	6	6	
• Characteristic quick		--	10	
• With miniature circuit breaker, Char. C	A	0.5	--	
Mechanical endurance		1 × 10 ⁶ operating cycles		1 × 10 ⁶ operating cycles
Electrical endurance				
• With 3RH11, 3RT10 16 to 3RT10 26 contactors		1 × 10 ⁶ operating cycles		1 × 10 ⁶ operating cycles
• For AC-15 utilization category		1 × 10 ⁵ operating cycles, when interrupting I_e /AC-15 at 230 V		0.5 × 10 ⁶ operating cycles, when interrupting I_e /AC-15 at 230 V
• For DC-13 utilization category		With DC current the contact endurance depends not only on the breaking current but also on the voltage, the circuit inductance and the speed of switching. No generally valid information can be given.		
Switching frequency With 3RH11, 3RT10 16 to 3RT10 26 contactors		6 × 10 ³ operating cycles/h		
Shock resistance acc. to IEC 60068-2-27		30 g/11 ms		--

Type	3SE5 322	3SE5 312	3SE2 83, 3SE2 84	
Enclosure				
Enclosure material	Ultramid A3X2G7		Zinc diecasting GD Zn Al4 Cu1	Aluminum (GD - AISi 12)
Degree of protection acc. to EN 60529	IP66/IP67		IP67	
Ambient temperature				
• During operation	°C	-25 ... +60		-30 ... +70
• During storage, transport	°C	-40 ... +80		--
Mounting position	Any			
Connection				
Cable entry	M 20 × 1.5		M 20 × 1.5	
Conductor cross-sections				
• Solid	mm ²	1 × (0.5 ... 1.5)		2 × 2.5
• Finely stranded with end sleeve	mm ²	2 × (0.5 ... 0.75)		2 × 1.5
Protective conductor connection Inside enclosure		--	M3.5	

¹⁾ Without any welds according to IEC 60947-5-1.

SIRIUS 3SE5 Interlock Switches

3SE5 with solenoid locking Metal and plastic enclosures

Schematics

3SE5

Monitoring the actuator:

Slow-action contacts 1 NO + 2 NC

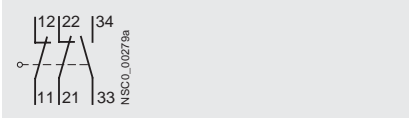

Monitoring the solenoid:

Slow-action contacts 1 NO + 2 NC

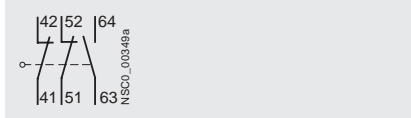

Configuration

Operation and operating travel of actuators

Operation by a separate actuator

- ⊕ Positive opening acc. to EN 60947-5-1
- v_{max} Max. actuating speed
- Direction of operation

Contact blocks

Terminal designation acc. to EN 50013

Nominal travel

- Contact closed
- Contact open
- Actuator in actuator head: NC is closed

Separate actuators with solenoid interlocking

Standard actuators

Axial and lateral actuation ($4 \times 90^\circ$)

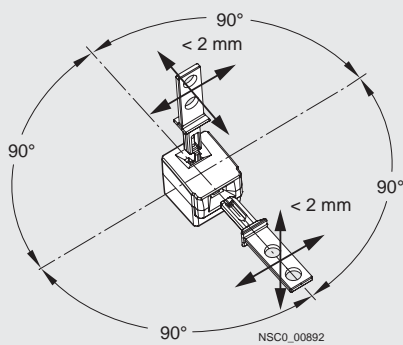

Minimum force required in operating direction 30 N (on retraction)

Radius actuators (all directions of approach)

Example: Direction of approach from the left

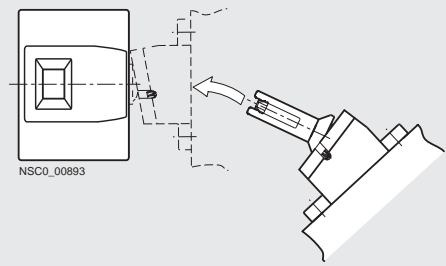

For connector socket assignment, see page 13/61.

Slow-action contacts

1 NO + 2 NC

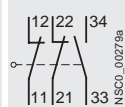

Ident. No. 12

Lateral actuation

3SE5 3...-S...



Axial actuation

3SE5 3...-S...

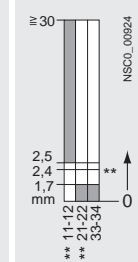

SIRIUS 3SE5 Interlock Switches

3SE5 with solenoid locking Metal and plastic enclosures

Dimensional drawings

Spring-actuated lock, with auxiliary release
 3SE5 322-SD2., 3SE5 322-SG2., 3SE5 322-SJ2.,
 3SE5 312-SD1., 3SE5 312-SG1., 3SE5 312-SJ1.,

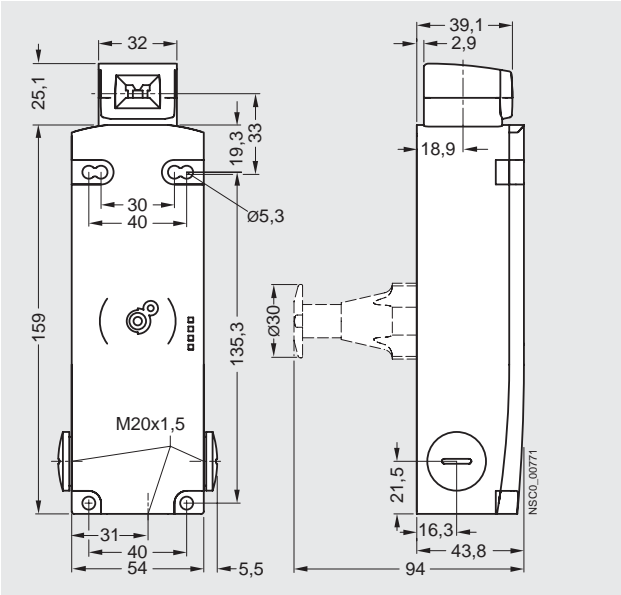

Spring-actuated lock, with auxiliary release with lock
 3SE5 322-SE2.,
 3SE5 312-SE1.

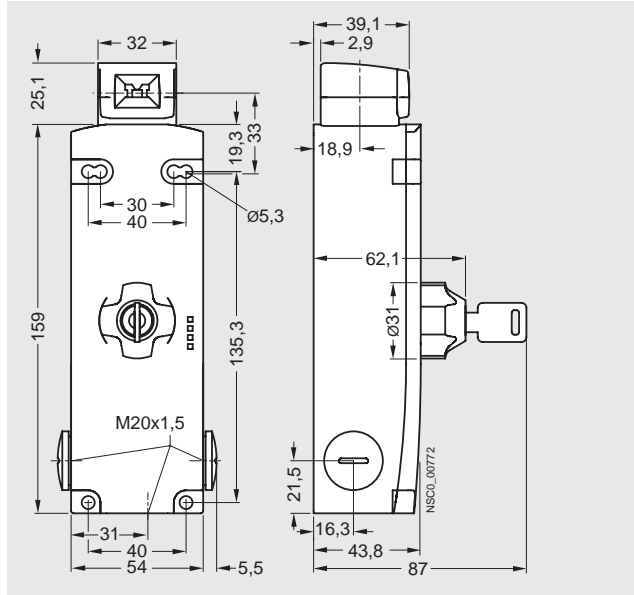

Spring-actuated lock, with escape release
 3SE5 322-SF2.,
 3SE5 312-SF1.

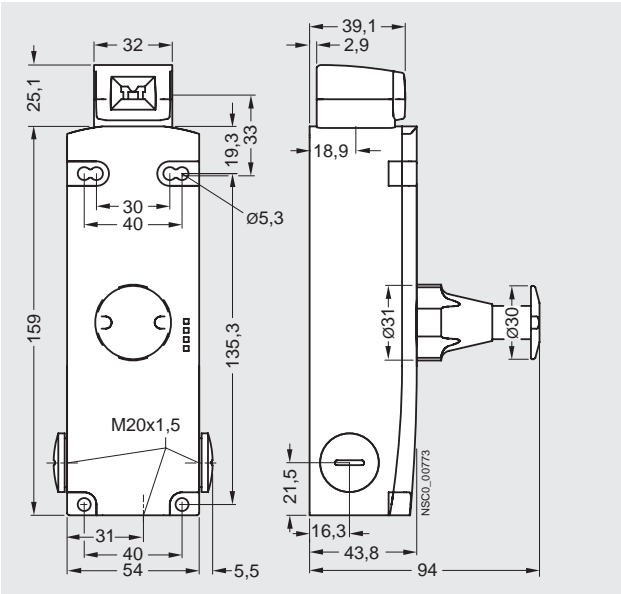

Magnetic field lock
 3SE5 322-SB2.,
 3SE5 312-SB1.

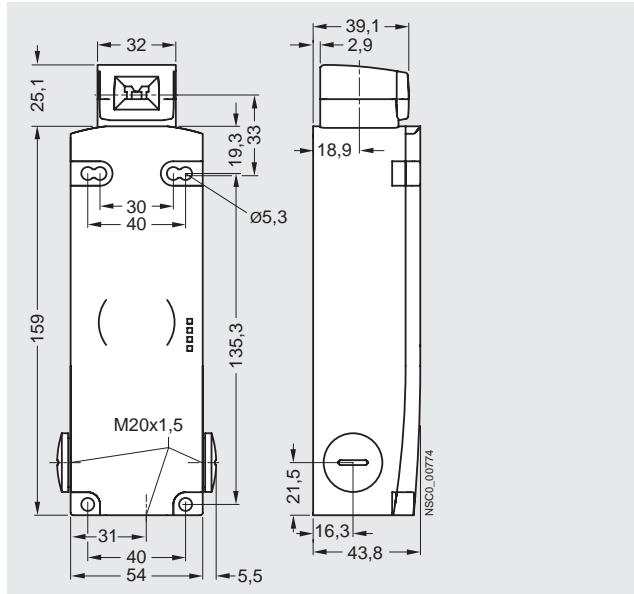

The plastic enclosures have knock-out openings behind the connecting thread; they are delivered therefore without protective caps.
 For actuators see page 13/90.

SIRIUS 3SE5 Hinge Switches

General data

Overview

3SE5 hinge switches have the same enclosures as the standard switches (modular system).



Hinge switches

Design

Enclosure sizes

The 3SE5 switches are available as complete units in two enclosure sizes:

- Plastic enclosures according to EN 50047, 31 mm wide, IP65, 1 cable entry
- Metal enclosures according to EN 50047, 31 mm wide, IP66/IP67, 1 cable entry
- Plastic and metal enclosures according to EN 50041, 40 mm wide, IP66/IP67, 1 cable entry

Enclosure versions

Various basic versions can be selected for the enclosures:

- Available with two or three-pole contact blocks designed as snap-action contacts
- Metal enclosures for explosion protection (ATEX) ([see online](#))
- AS-Interface version with integrated ASIsafe electronics for all enclosure designs ([see online](#))

For a description of the basic switches, [see page 13/6](#).

Operating mechanism

The hinge switches are provided for mounting on hinges. The actuator head is included in the scope of supply. There are two versions:

- Operating mechanism with hollow shaft, inner diameter 8 mm, outer 12 mm
- Operating mechanism with solid shaft, diameter 10 mm

Benefits

The 3SE5 hinge switches differ from the previous series through the following new characteristics:

- All actuators can be turned around the axis in increments of 22.5° ([see picture on page 13/6](#)).
- The new three-pole contact block 1 NO + 2 NC is available for all enclosure sizes ([see picture on page 13/7](#)).
- The plastic enclosure with a width of 31 mm has simple and fast wiring equipment which makes it possible to save from approx. 20 to 25 % of the time when connecting ([see picture on page 13/7](#)).
- The ASIsafe electric component is integrated for the versions with the AS-Interface connection ([see online](#)); an additional adapter is not required.

Application

The hinge switches are used in those areas where the position of swiveling protective devices such as doors or flaps must be monitored. With these switches, the position of the doors and hinge switches is converted into electric signals. The switches allow shutdown and signaling without delay in the event of a small opening angle through the snap-action contacts with an operating angle of 10°.

Devices are available with enclosure versions to suit the particular ambient conditions. Different control tasks can be performed with the best contact blocks suited for the particular purpose. Dimensions and fixing points of the enclosures are in accordance with EN 50041 or EN 50047 standards.

The devices are suitable for use in any climate.

Standards

IEC 60947-5-1 or EN 60947-5-1.

The protective measure of "total insulation" by the molded-plastic enclosure is guaranteed by the use of molded-plastic screw-glands.

Safety position switches

For controls according to IEC 60204-1 or EN 60204-1 the devices can be used as a safety position switch. To secure position switches against changes in their position, keyed techniques must be employed on installation.

Safety circuits

IEC 60947-5-1 and EN 60947-5-1 require positive opening of the NC contacts, i.e. for the purposes of personal safety, the assured opening of NC contacts is expressly stipulated for the electrical equipment of machines in all safety circuits and marked according to IEC 60947-5-1 with the symbol

Category 4 according to EN 954-1 can be attained with the 3SE5 hinge switches with if the corresponding failsafe evaluation units are selected and correctly installed, e.g. the 3TK28 safety relays or matching devices from the ASIsafe, SIMATIC or SINUMERIK product ranges.

SIRIUS 3SE5 Hinge Switches

3SE5, plastic enclosures – Enclosure width 31 mm / 40 mm

Selection and ordering data

Complete units

2 or 3 contacts · Degree of protection IP65 (31 mm) or IP67/IP68 (40 mm) · Cable entry M20 × 1.5

Version	Snap-action contacts	DT	Complete units	<input type="checkbox"/>	PU (UNIT, SET, M)	PS*
			Configurator			
		Order No.	Price per PU			

Plastic enclosures · Enclosure width 31 mm acc. to EN 50047



With hollow shaft

With hollow shaft						
Operating angle 10°	1 NO + 1 NC		B	3SE5 232-0HU21	1	1 unit
Operating angle 10°	1 NO + 2 NC		B	3SE5 232-0LU21	1	1 unit



With solid shaft

With solid shaft						
Operating angle 10°	1 NO + 1 NC		B	3SE5 232-0HU22	1	1 unit
Operating angle 10°	1 NO + 2 NC		B	3SE5 232-0LU22	1	1 unit

Plastic enclosures · Enclosure width 40 mm acc. to EN 50041



With hollow shaft

With hollow shaft						
Operating angle 10°	1 NO + 2 NC		B	3SE5 132-0LU21	1	1 unit



With solid shaft

With solid shaft						
Operating angle 10°	1 NO + 2 NC		B	3SE5 132-0LU22	1	1 unit

For online configurator see www.siemens.com/sirius/configurators .

Positive opening according to IEC 60947-5-1, Appendix K.

Spare parts

Version	DT	Order No.	Price per PU	PU (UNIT, SET, M)	PS*
---------	----	-----------	--------------	-------------------	-----

Actuator heads



With hollow shaft

With hollow shaft					
Operating angle 10°		B	3SE5 000-0AU21	1	1 unit



With solid shaft

With solid shaft					
Operating angle 10°		B	3SE5 000-0AU22	1	1 unit

Note:

The respective actuators are included in the scope of supply for the complete units.

SIRIUS 3SE5 Hinge Switches

3SE5, metal enclosures – Enclosure width 31 mm / 40 mm

Selection and ordering data

Complete units

3 contacts · Degree of protection IP66/IP67 · Cable entry M20 × 1.5

Version	Snap-action con- tacts	DT	Complete units	<input type="checkbox"/>	PU (UNIT, SET, M)
			Configurator		
		Order No.	Price per PU		

Metal enclosures · Enclosure width 31 mm acc. to EN 50047



With hollow shaft

With hollow shaft Operating angle 10°	1 NO + 2 NC	B	3SE5 212-0LU21		1
---	-------------	---	-----------------------	--	---



With solid shaft

With solid shaft Operating angle 10°	1 NO + 2 NC	B	3SE5 212-0LU22		1
--	-------------	---	-----------------------	--	---

Metal enclosures · Enclosure width 40 mm acc. to EN 50041



With hollow shaft

With hollow shaft Operating angle 10°	1 NO + 2 NC	B	3SE5 112-0LU21		1
---	-------------	---	-----------------------	--	---



With solid shaft

With solid shaft Operating angle 10°	1 NO + 2 NC	B	3SE5 112-0LU22		1
--	-------------	---	-----------------------	--	---

For online configurator see www.siemens.com/sirius/configurators .

Positive opening according to IEC 60947-5-1, Appendix K.

Spare parts

Version	DT	Order No.	Price per PU	PU (UNIT, SET, M)	PS*
---------	----	-----------	-----------------	-------------------------	-----



With hollow shaft

With hollow shaft Operating angle 10°	B	3SE5 000-0AU21		1	1 unit
---	---	-----------------------	--	---	--------



With solid shaft

With solid shaft Operating angle 10°	B	3SE5 000-0AU22		1	1 unit
--	---	-----------------------	--	---	--------

Note:

The respective actuators are included in the scope of supply for the complete units.

SIRIUS 3SE2 Hinge Switches

3SE2, plastic enclosures with integrated hinge

Overview

The 3SE2 283 hinge switches are particularly suitable for use in doors and flaps of machines that must be closed to ensure the safety of operating personnel. Their thin profile and compact design allow them to be directly mounted on a hinged protective cover and the stable frame.

Benefits

- Easy mounting through use of versions with integrated hinge
- Versions with small operating angle of 4°
- Protection against personal injury provided by positively driven NC contacts according to IEC 60947-5-1
- Simultaneous shutdown and reporting by 1 NO + 2 NC contacts

Selection and ordering data

3 contacts · Degree of protection IP65 · Cable entry 2 × (M20 × 1.5)

Version	Slow-action contacts	DT	Complete units	<input type="checkbox"/>	PU (UNIT, SET, M)	PS*	PG	Weight per PU approx.
			Order No.	List Price \$ per PU				kg

Plastic enclosures with integrated hinge

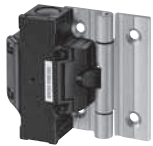

3SE2 283

Version	Slow-action contacts	DT	Complete units	<input type="checkbox"/>	PU (UNIT, SET, M)	PS*	PG	Weight per PU approx.
With mounted hinges (delivered with additional hinge and fixing accessories)								
• Aluminum hinge								
- Operating angle 4°	1 NO + 2 NC	⊕ A	3SE2 283-0GA43		1	1 unit	102	0.425
- Operating angle 4°	3 NC	⊕ A	3SE2 283-6GA43		1	1 unit	102	0.425
- Operating angle 8°	1 NO + 2 NC	⊕ D	3SE2 283-0GA53		1	1 unit	102	0.420
- Operating angle 8°	3 NC	⊕ C	3SE2 283-6GA53		1	1 unit	102	0.420
• High-grade steel hinge								
- Operating angle 4°	1 NO + 2 NC	⊕ A	3SE2 283-0GA44		1	1 unit	102	0.800
- Operating angle 4°	3 NC	⊕ C	3SE2 283-6GA44		1	1 unit	102	0.800

⊕ Positive opening according to IEC 60947-5-1, Appendix K.

Accessories/spare parts

Version	DT	Order No.	List Price \$ per PU	PU (UNIT, SET, M)	PS*	PG	Weight per PU approx.
---------	----	-----------	----------------------	-------------------	-----	----	-----------------------

Accessories



3SX3 225

Additional hinges (delivered with fixing accessories)								
• Made of aluminum								
	⊕ D	3SX3 225		1	1 unit	102	0.160	
• Made of high-grade steel								
	⊕ D	3SX3 231		1	1 unit	102	0.330	

For 1/2" NPT adaptors and cable glands, see page 13/48.

SIRIUS 3SE5 Hinge Switches

3SE5, plastic and metal enclosures

Configuration

Contact blocks and operating travel of actuators

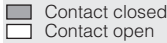
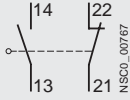
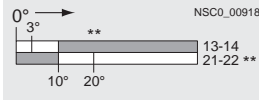
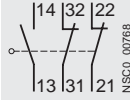
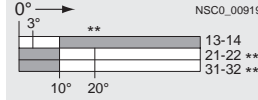
Contact blocks	Nominal travel	Contact blocks	Nominal travel
Terminal designation acc. to EN 50013	 Contact closed Contact open	Terminal designation acc. to EN 50013	
Hinge switches		Snap-action contacts	
1 NO + 1 NC  Ident. No. 11	3SE5 ...-0HU2.  NSCO_00918	1 NO + 2 NC  Ident. No. 12	3SE5 ..-0LU2.  NSCO_00919

Dimensional drawings

Enclosure width 31 mm with hollow shaft
3SE5 212-0.U21, 3SE5 232-0.U21

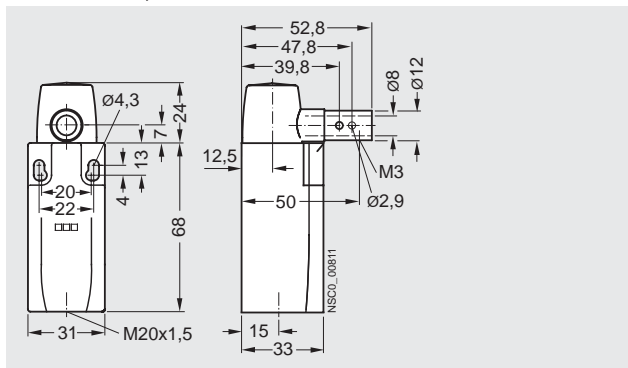

Enclosure width 31 mm with solid shaft
3SE5 212-0.U22, 3SE5 232-0.U22

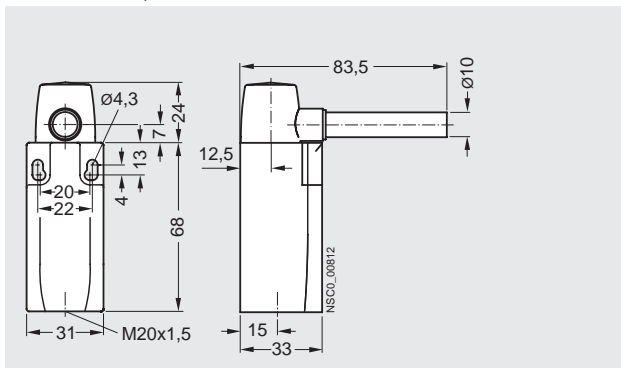

Enclosure width 40 mm with hollow shaft
3SE5 112-0.U21, 3SE5 132-0.U21

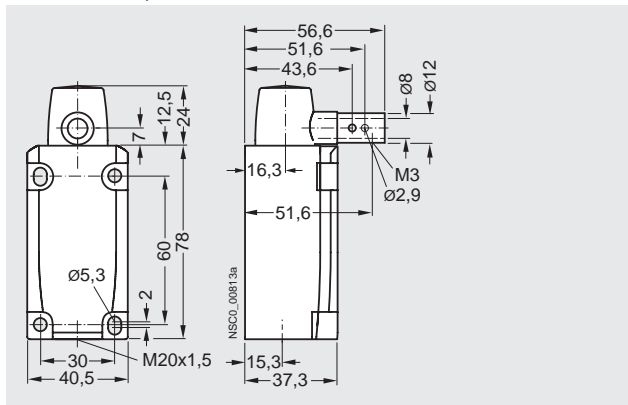

Enclosure width 40 mm with solid shaft
3SE5 122-0.U22, 3SE5 132-0.U22

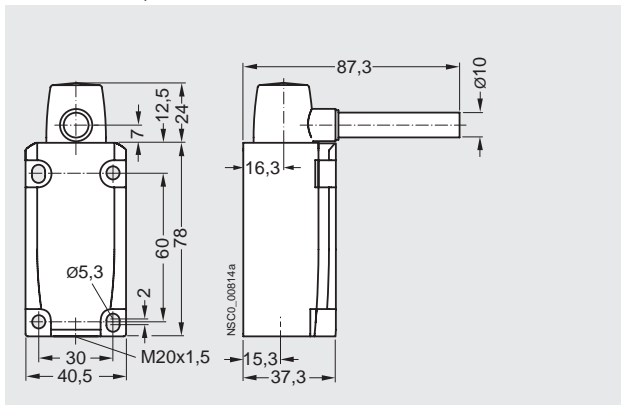

SIRIUS 3SE2 Hinge Switches

3SE2, plastic enclosures with integrated hinge

Overview

The hinge switches are used for monitoring and protecting hinged protective devices such as doors and flaps.

Characteristics

- Special design, with 2 × M20 × 1.5 connecting thread
- Degree of protection IP65
- 3 contacts
- Operating angle of 4° or 8°

Design

The 3SE2 283 hinge switch has an integrated electromechanical contact block that is actuated when the hinged protective cover is opened. If the cover is opened by 4° or 8°, the NC contact is positively opened by a direct (not spring-action) mechanism. These positively driven contacts guarantee interruption of the electric circuit and stopping of the machine. The NO contact is closed when the cover is moved by 13.5°.

Technical specifications

Type	3SE2 283	
Rated insulation voltage U_i	V	250
Conventional thermal current I_{th}	A	2.5
Rated operational current I_e		
• At AC-15, 120 V	A	4.2
• At AC-15, 250 V	A	2
• At DC-13, 24 V	A	1
Min. make-break capacity	> 5 V/1 mA	
Short-circuit protection		
• Operational class gG	A	2
Mechanical endurance	> 1 × 10 ⁶ operating cycles	
Switching frequency	1200 operating cycles/hour	
Positive opening	2 mm after opening point	
Enclosure material	Plastic	
Degree of protection	IP65	
Ambient temperature	°C	-25 ... +65
Shock resistance	30 g/18 ms	
Resistance to vibrations	20 g/10 ... 200 Hz	
Cable entry	2 × (M20 × 1.5)	
Screw terminals	0.5 ... 1.5 mm ² /AWG 15	

Configuration

Contact blocks and operating travel of actuators (operating angle 4°)

Contact blocks	Nominal travel	Contact blocks	Nominal travel
Terminal designation acc. to EN 50013		Terminal designation acc. to EN 50013	
Hinge switches		Slow-action contacts	
1 NO + 2 NC Ident. No. 12	3SE2 283-0GA4. NSC0_00614a	3 NC Ident. No. 03	3SE2 283-6GA4. NSC0_00615a

Dimensional drawings

3SE2 283-.GA.3 hinge switch with hinge

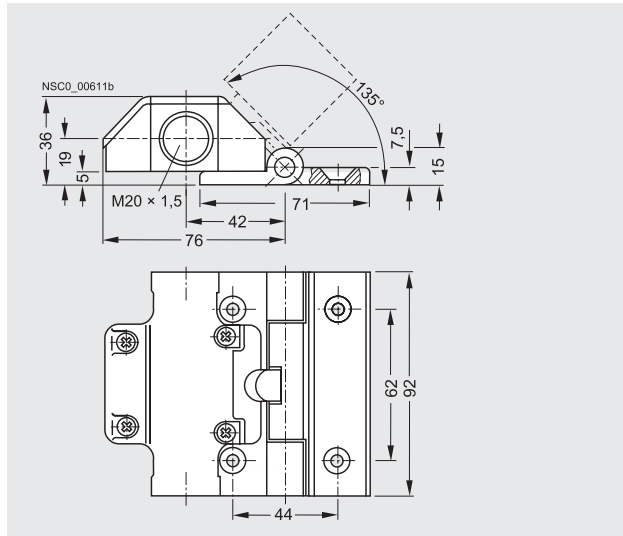

3SX3 225 additional hinge

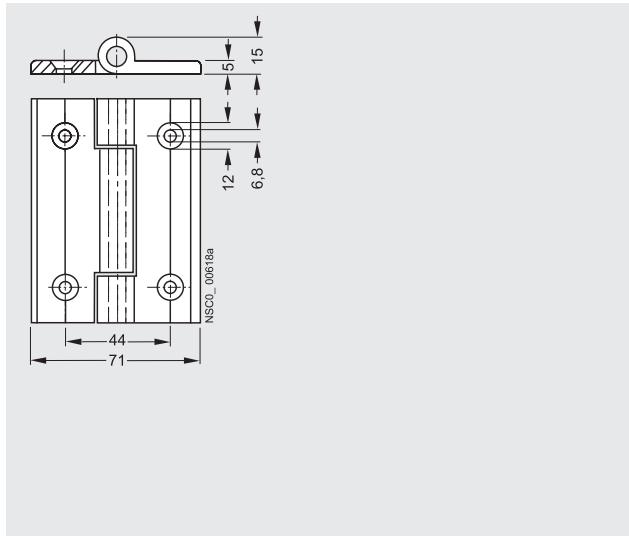

SIRIUS 3SE6 RFID Non-Contact Safety Switches

General data

Overview



Non-contact RFID safety switches with maximum tamper resistance

3SE63 RFID contactless safety switches meet the highest safety requirements, SIL3 or Cat. 4, for monitoring the positions of movable protective devices.

An RFID safety switch consists of a coded RFID switch with an 8-pole M12 connector plug and an identical RFID actuator.

The switch is available in several versions:

- Family coded with M12 plug or with additional 18 N magnetic catch as an option
- Individually coded, programmable once, with M12 plug or with additional 18 N magnetic catch as an option
- Individually coded, programmable more than once (an unlimited number of times), with M12 plug or version with additional 18 N magnetic catch

The actuator is therefore available in two versions:

- Standard
- With 18 N magnetic catch

The magnetic catch keeps doors and hinge switches closed with permanent magnets.

Optional accessories

- Covers for sealing mounting holes, also suitable for tamper-proofing screw fixings
- Spacers (approx. 3 mm high) to facilitate cleaning under the installation surface when using pressure washers, for example

Mounting and maintenance

Reduction in the number of versions, because

- switches can be mounted on right or left sides
- the actuator can be mounted on all sides

Quick and easy mounting by thanks to universal mounting holes

- Standard gauge/holes for 3SE6 magnetically operated switch
- Fine adjustment thanks to slotted holes

Little adjustment or maintenance required

- Threshold indication by LED on the switch for quick and easy adjustment during installation and maintenance
- Molded switch allows it to be used as an end stop for small and medium-sized doors

Note:

Keep metal parts and cuttings away from the vicinity of the switch

Minimum distance between two switches 100 mm

Coding

Family coded

These safety switches are delivered ready to use, i.e. no programming is necessary.

Individually coded, programmable once

The assignment of safety switch and actuator thus created is irreversible.

The actuator is programmed simply by routine during startup, thus permanently preventing any form of tampering by means of a replacement actuator.

Individually coded, programmable several times

The procedure for programming a new actuator can be repeated an unlimited number of times. When a new actuator is programmed the previous code becomes invalid. A protected coding process allows new actuators to be programmed for service purposes.

After this, a ten-minute lockout provides enhanced tamper protection. The green LED flashes until the lockout time has ended and the new actuator has been detected. If the operational voltage is interrupted during this time, the ten-minute guard time is restarted.

Programming procedure for individual coding

1. Apply operational voltage to safety sensor
2. Move actuator into detecting range: red LED lights up, yellow LED flashes (1 Hz)
3. After 10 s it changes to a shorter flashing frequency (3 Hz). In this state switch off operational voltage.
4. After the next time the operational voltage is switched on, the actuator is detected again to activate the programmed actuator code. The activated code is thus stored permanently.

Diagnostics

The RFID safety switch indicates its operating state including faults by means of the LED indicator in the switch and the short-circuit resistant diagnostic output. The signals can then be used for central displays or non-safety-related control tasks.

There are two diagnostics functions:

- Crossover monitoring
- Open-circuit monitoring
- External voltage monitoring
- Ambient temperature too high
- Wrong or defective actuator
- Switching interval threshold identification with LED indication

The signal combination "diagnostics output switched off" and "safety outputs still switched on" can be used to move the machine into a controlled stop position.

Any crossover or a fault that is not currently compromising the safe operation of a safety switch results in the disconnection of the safety channels after a 30 minute delay. However, the diagnostics output switches off instantaneously.

SIRIUS 3SE6 RFID Non-Contact Safety Switches

General data

Mode of operation of the diagnostics LEDs

The safety switch indicates not only its operating state, but also faults by means of LEDs in three colors at the ends of the RFID switch.

- The green LED indicates readiness for operation when the control supply voltage is connected.
- The yellow LED indicates that there is an actuator in detecting range. If the actuator is in the switching interval threshold, this is indicated by flashing. This flashing can be used to identify a change in the distance between sensor and actuator at an early stage (e.g. as a result of the sagging of a protective door). The installation should be tested before the distance increases further, the safety outputs switch off and the machine stops.
- The red LED indicates the individual causes of the fault by means of defined flashing frequencies.

Benefits

- Maximum tamper resistance by means of individual coding of switches and actuators at the highest safety level
- Plastic enclosure with integrated connector
- 2 electronic short-circuit proof safety outputs, each 250 mA
- Integrated crossover, open circuit and external voltage monitoring, with series circuit as far as the control cabinet
- Safety and diagnostics signals can be connected in series
- Series connection of safety circuits in Cat. 4 / PL e / SIL 3
- LED status indication including switching interval threshold indication for quick and easy adjustment during installation and maintenance
- Short-circuit proof conventional diagnostics output
- Optional version with magnetic catch for interlocking hatches or small doors even when de-energized

- Highly rugged thanks to the use of tested enclosure materials, resistant to aggressive cleaning products, with a degree of protection of up to IP69K
- Fine adjustment thanks to slotted holes
- Little adjustment or maintenance required
- Molded switch allows it to be used as an end stop for small and medium-sized doors

Application

RFID contactless safety switches are designed for use in safety circuits, and are used to monitor the positions of movable protective devices. They monitor the positions of rotating, laterally sliding or removable protective devices using the coded electronic actuator.

Their high degree of protection (IP69K) and the use of cleaning product-resistant materials means that these switches are optimized for use under extreme environmental conditions.

Their electronic operating principle makes these switches ideal for metalworking machinery.

The switches have a larger switching interval and switching displacement than mechanical switches, improve the mounting tolerance of the protective door, and offer a wide range of diagnostics options.

The RFID switches can be connected to all standard evaluation units, e.g. a PLC, 3TK28 safety evaluation units (in which the built-in crossover monitoring function can be deactivated), or the 3RK3 modular safety system.

The following safety categories can be achieved in safety circuits:

- Category 4 according to EN ISO 13849-1 (EN 954-1)
- PL e according to EN ISO 13849-1
- SIL 3 according to IEC 61508

Technical specifications

Type	3SE6 3	
General data		
Standards	IEC 60947-5-3, IEC 61508, EN ISO 13849-1	
Enclosure material	Fiber-glass strengthened thermoplast, self-extinguishing	
Degree of protection	IP69K	
Ambient temperature		
• During operation	°C	-25 ... +70
• During storage, transport	°C	-25 ... +85
Shock resistance	30 g/11 ms	
Vibration resistance	10 ... 55 Hz amplitude 1 mm	
Electrical specifications		
Rated insulation voltage U_i	V	32
Pollution degree acc. to IEC 60664-1		3
Rated impulse withstand voltage U_{imp}	V	800
Rated conditional short-circuit current	A	100
Rated operational voltage U_e (PELV acc. to IEC 60204-1)	V DC	24 – 15/+10 %
Protection class	II	
Overvoltage category	III	
Rated operational current I_e	A	0.6
Smallest operational current I_m	mA	0.5
No-load supply current I_0	mA	35

Type	3SE6 3	
Inputs/outputs		
Safety inputs X1/X2		
• Input voltage	V DC	24 – 15/+10 %
• Power consumption per input	mA	5
Safety outputs OSSD1/OSSD2		
p operation		
• Max. rated operational current I_e	A	0.25
• Rated operational current $I_e/DC-12/DC-13$ at U_e	A	0.25
• Voltage drop U_e	V	< 1
• Switching frequency	Hz	1
• Response time, max.	ms	100
• Risk time, max.	ms	200
• Recovery, max.	s	5
Diagnostics output		
p operation		
• Max. rated operational current $I_{e2\max}$	A	0.05
• Rated operational current $I_e/DC-12/DC-13$ at U_e	A	0.05
• Voltage drop U_e	V	< 2
• Operational current	mA	150
• Conductor capacity, max.	nF	50

SIRIUS 3SE6 RFID Non-Contact Safety Switches

Technical data

Directions of approach and switching interval

The side area permits a maximum height offset of the switch and actuator of ± 8 mm (e.g. mounting tolerance or due to sagging of the protective door). The transverse offset also equals max. ± 8 mm.

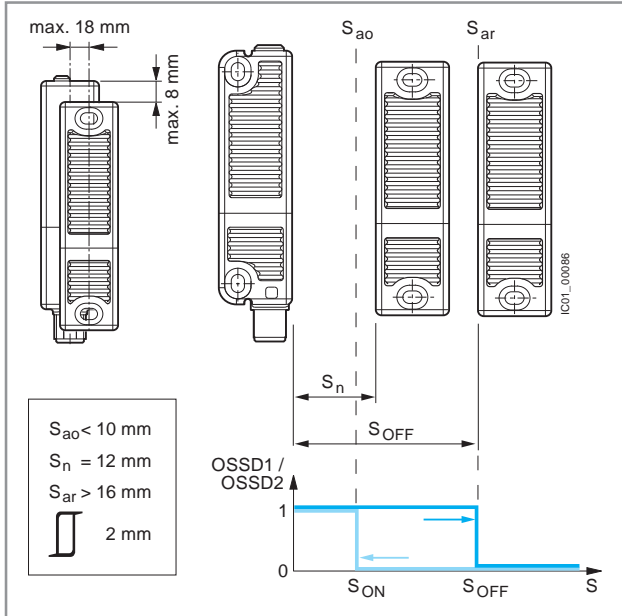

Switching interval: output signal with hysteresis

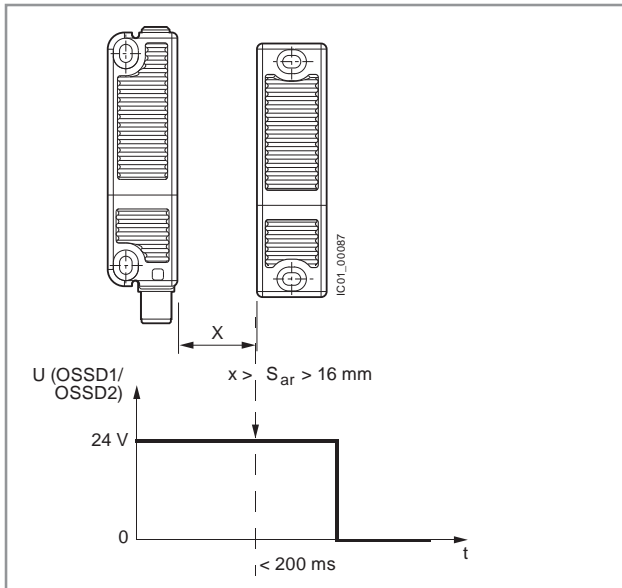

Switching interval: Output signal

Connector assignment

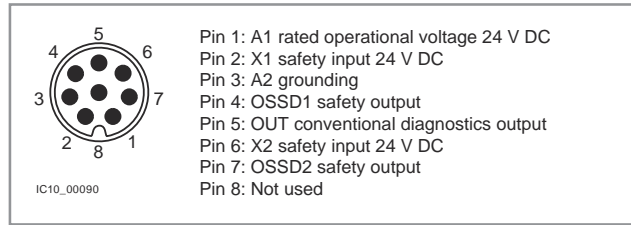

Dimensional drawings

RFID switches 3SE6 315

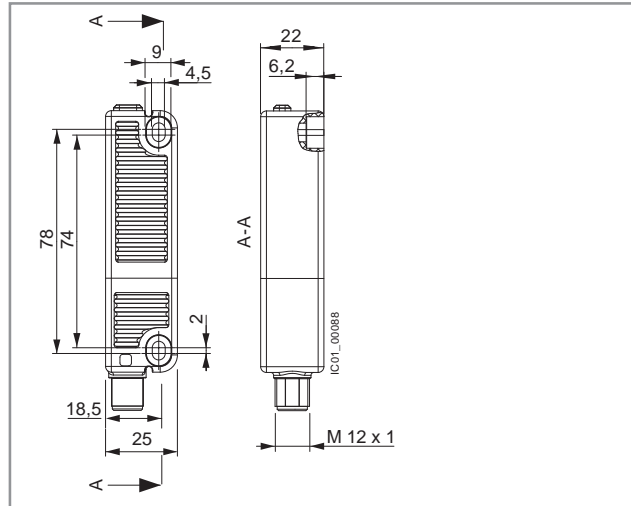

RFID actuator 3SE6 310

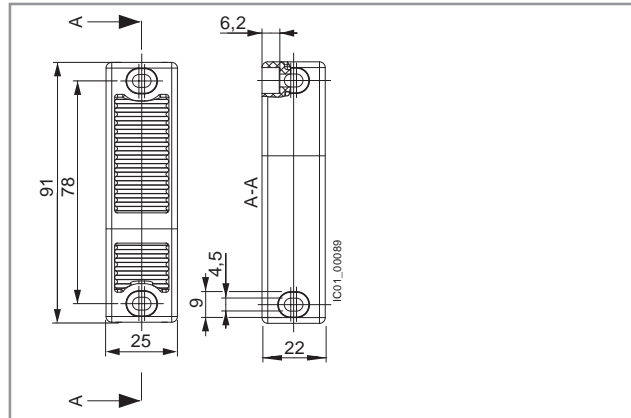





SIRIUS 3SE6 RFID Non-Contact Safety Switches

Selection

Selection and ordering data

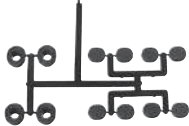
With M12 connector, 8-pole

Version/coding	Latching / length	DT	Order No.	Price per PU	PU (UNIT, SET, M)	PS*
Rectangular safety switches 91 mm x 25 mm						
RFID safety switches						
 <p>3SE6 315</p>	• Family coded	None	▶ 3SE6 315-0BB01		1	1 unit
		With 18 N magnetic catch	▶ 3SE6 315-1BB01		1	1 unit
	• Individually coded, programmable several times	None	▶ 3SE6 315-0BB02		1	1 unit
		With 18 N magnetic catch	▶ 3SE6 315-1BB02		1	1 unit
	• Individually coded, programmable once	None	▶ 3SE6 315-0BB03		1	1 unit
		With 18 N magnetic catch	▶ 3SE6 315-1BB03		1	1 unit
RFID actuators						
 <p>3SE6 310</p>	• Standard	None	▶ 3SE6 310-0BC01		1	1 unit
		With 18 N magnetic catch	▶ 3SE6 310-1BC01		1	1 unit
Optional accessories						
 <p>3SX5 600-1G</p>	Covers and spacers		A 3SX5 600-1G		1	1 unit
	One pack (1 unit) contains 8 covers and 4 spacers					
 <p>3SX5 601-2GA</p>	Connecting cables, 8-pole, with 1 straight M12 socket	Length 3 m	A 3SX5 601-2GA03		1	1 unit
		Length 5 m	A 3SX5 601-2GA05		1	1 unit
		Length 10 m	A 3SX5 601-2GA10		1	1 unit
Rated voltage 30 V						
Rated current 2 A						

For monitoring units see Chapter 14, "Industrial Communication"

3SE6 Magnetic Monitoring Systems

General data

Overview

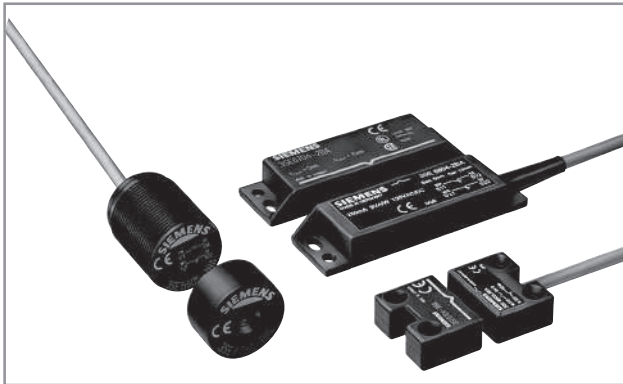

Switching magnets and contact blocks

A magnetically operated switch is comprised of a coded switching magnet and a contact block (sensor unit). Evaluation requires a safety relay or connection to a bus system.

3SE6 806 safety relays

Up to six protective devices (sensors) can be connected to the safety relay.

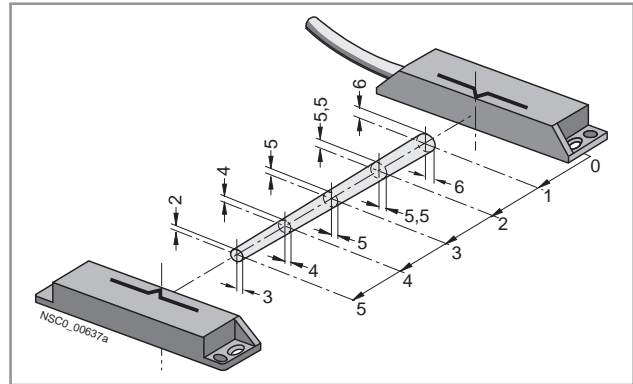

Enabling range (example)

The device has six current-sourcing semiconductor outputs (Y1 ... Y6) which signal the state of the connected protective devices.

The 3SE6 806 safety relay has two floating enabling circuits (safe circuits) as NO contact circuits and one floating signaling circuit as a NC circuit. The number of enabling circuits can be increased by adding one or more 3TK28 30 expansion modules.

Application

SIRIUS 3SE6 magnetically operated switches are designed for mounting on movable protective guards (hoods, hinge switches, doors, etc.). Evaluation can be performed by means of a safety relay or through connection to a bus system.

The 3SE6 6 non-contact, magnetically operated safety switches stand out due to their enclosed design with degree of protection IP67. They are particularly suitable therefore for areas exposed to contamination, cleaning or disinfecting.

A magnetic monitoring system comprises one or more magnetically operated switches and an evaluation unit, e.g. a safety relay. When contact blocks 1 NO + 1 NC are used the 3SE6 806 safety relay provides a high degree of protection against manipulation and can be installed in safety circuits up to Category 3 according to ISO 13849-1 (EN 954-1).

Combination of monitoring units and magnetically operated switches





Monitoring units	Magnetically operated switches (contact block + switching magnet)					Achievable category (EN 954-1)/ Performance level (EN ISO 13849-1)				
	1 NO + 1 NC	2 NC	1 NO + 2 NC	3SE6 605-1BA	3SE6 605-2BA		3SE6 605-3BA	3SE6 604-2BA	3SE6 606-3BA	3SE6 704-1BA
Relay outputs										
SIRIUS safety relays, 6-fold	3SE6 806-2CD00					Cat. 3				
SIRIUS safety relays	3TK28 20				✓	Cat. 4/e				
	3TK28 26	✓	✓	✓	✓	Cat. 4/e				
Solid-state outputs										
SIRIUS safety relays	3TK28 40				✓	Cat. 3/d				
	3TK28 41, 3TK28 42, 3TK28 45				✓	Cat. 4/e				
SIRIUS safety relays with contactor relay	3TK28 50, 3TK28 51, 3TK28 52				✓	Cat. 3/d				
	3TK28 53				✓	Cat. 4/e				
ASIsafe compact safety modules	3RK1 205, 3RK1 405				✓	Cat. 4				
SIMATIC S7-31xF-2 DP or SIMATIC ET 200M	SM 326 F, 24 DI, 24 V DC, SM 326 F, 8 DI, NAMUR	✓	✓	✓	✓	Cat. 4				
SIMATIC ET 200S PROFIsafe	4/8 F-DI / 3 F-DO, 24 V DC	✓	✓	✓	✓	Cat. 3				
	4/8 F DI, 24 V DC	✓	✓	✓	✓	Cat. 4				
SIMATIC ET 200eco	4/8 F DI, 24 V DC	✓	✓	✓	✓	Cat. 4				
SIMATIC ET 200pro	8/16 F-DI, 24 V DC, 4/8 F-DI / 4 F-DO 2 A, 24 V DC, F-Switch	✓	✓	✓	✓	Cat. 4				
Modular Safety System	3RK3	✓	✓	✓	✓	Cat. 4/e				

✓ Suitable magnetically operated switch

3SE6 Magnetic Monitoring Systems

Selection

Selection and ordering data

		Design	Size	S _{an} ... S _{ab}	Contacts	DT	Order No.	List Price \$ 1 unit	Weight approx. kg
Round sensor unit. IP67									
	3SE6 704-1BA	3SE6 605-1BA	Switching magnet (coded)	M 30			3SE6 704-1BA		0.035
			Switch block with 3 m cable	M 30	5 to 15	1 NO + 1 NC	3SE6 605-1BA		0.166
			Switch block with M12, 4-pole male receptacle ¹⁾	M 30	5 to 15	1 NO + 1 NC	3SE6 605-1BA02		0.130
Rectangular sensor unit. IP67									
	3SE6 605-2BA, 3SE6 704-2BA	3SE6 605-3BA, 3SE6 704-3BA	Switching magnet (coded)	25 x 88			3SE6 704-2BA		0.027
			Switch block with 1 m cable	25 x 88	5 to 15	1 NO + 1 NC 2 NC	3SE6 605-2BA 3SE6 604-2BA		0.165 0.165
			Switch block with M8 male receptacle	25 x 88	5 to 15	1 NO + 1 NC 2 NC	3SE6 605-2BA01 3SE6 604-2BA01		0.040 0.130
			Switching magnet (coded)	25 x 33			3SE6 704-3BA		0.014
			Switch block with 3 m cable	25 x 33	4 to 14	1 NO + 1 NC	3SE6 605-3BA		0.151
		Switch block with 3 m cable	25 x 33	4 to 14	1 NO + 2 NC	3SE6 606-3BA		0.151	
Accessories									
	3SX3 260	3SX3 261	Spacer for rectangular sensor unit	25 x 88			3SX3 260		0.015
			Spacer for rectangular sensor unit	25 x 33			3SX3 261		0.010
Monitoring units									
	3SE6 806-2CD00						3SE6 806-2CD00		0.200
				Rated control supply voltage	Width	Enable circuits/signal. circuits	Max. number of connectable sensors		
			DC V	mm				1 unit	kg

1) Pin 1 (S21) + Pin 2 (S22) = Normally Closed; Pin 3 (S13) + Pin 4 (S14) = Normally Open
 Typical 4-pole Female Plugs with black 5 meter cable include: 3RX1542 (right-angle) or 3RX1513 (straight plug).

Technical specifications

Magnet Switches

Type	3SE6 60.-1BA 3SE6 60.-2BA	3SE6 60.-3BA
Form	M30, 25 mm x 88 mm	25 mm x 33 mm
Standards	DIN EN 50947-5-3 ³⁾	
Sensing type	Magnetic	
Rated voltage	AC/DC 100 V, 120 V	DC 24 V
Rated current	400 mA	100 mA
Performance	10 VA/W	1 W
Max. switching frequency	5 Hz	
Max. sensing distance $S_{an} \dots S_{ab}$	5 ... 15 mm	4 ... 14 mm
Housing material	Fiber-glass strengthened with glass fiber	
Degree of protection acc. to IEC 60529	IP67	
Permissible ambient temperature	<ul style="list-style-type: none"> • Operating • Storage -25 to +70 °C -25 to +70 °C	
Shock resistance	10 g/11ms	
Vibration resistance	10 ... 55 Hz, 1 mm amplitude	
Conductor	Cable LiYY 4 x 0.25 mm ² 3 m length	
Receptacle, male	M12, M8	-
Cable length (max for connecting to monitoring unit)	1000 m	100 m

Magnet Switch Monitoring Unit

Type	3SE6 806-2CD00
Standards	EN ISO 13849-1, EN 1088
Rated control supply voltage U_c	DC 24 V
Rated control supply voltage tolerance	0.85 ... 1.2 x U_s
Rated power (without signal outputs Y1 ... Y6)	3 W
Maximum load current	<ul style="list-style-type: none"> • Signaling circuit Y1 ... Y6 • Signaling circuit 31, 32 20 mA 2 A
Inputs	6 sensors (1 NO or 1 NC)
Outputs	6 signaling outputs 1 relay output 2 enabling circuits
Response time	<ul style="list-style-type: none"> • Automatic start • Manual start 150 ms typical 25 ms typical
Release time	20 ms max.
Recovery time	350 ms
Degree of protection to IEC 60529	IP20
Switching capacity ¹⁾	Release circuits (13, 14 and 23, 24) Continuous current, I_{th} Rated operational current, I_e ²⁾ <ul style="list-style-type: none"> • AC-15 @ 203 V • DC-13 <ul style="list-style-type: none"> - 24 V - 115 V - 230 V 6 A 6 A 6 A 0.2 A 0.1 A
Short circuit protection	DIAZED <ul style="list-style-type: none"> • Fuse type • Duty class <ul style="list-style-type: none"> - gL(gC) - Quick response 6 A 10 A
Permissible ambient temperature, T_u	<ul style="list-style-type: none"> • Operating • Storage -25 to +45 °C -25 to +70 °C

1) Utilization category per DIN VDE 0660, Part 200, IEC 60947-5-1
 2) With all release circuits loaded

3) In combination with monitoring unit or AS-Interface.

Dimension drawings

Round sensor units

Switch block 3SE6 605-1BA

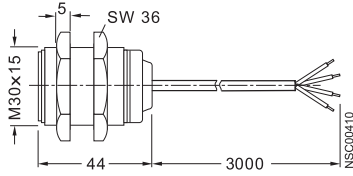

Switch block 3SE6 605-1BA02

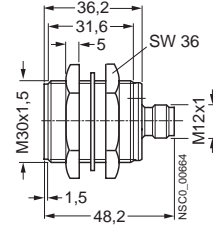

Coded switching magnet 3SE6 704-1BA

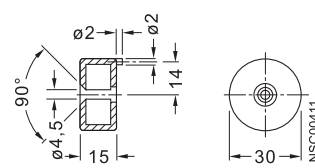

Rectangular sensor units

Switch block 3SE6 605-2BA

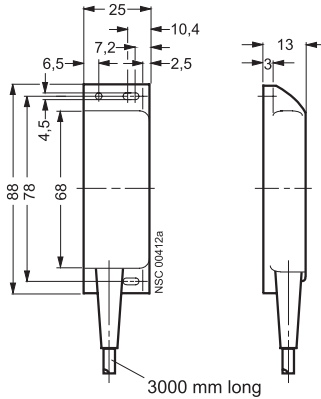

Switching magnet without lead

Switch block 3SE6 60.-2BA0.

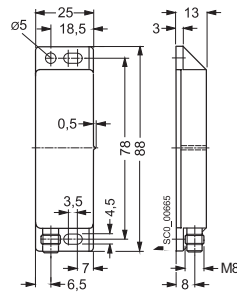

Switch block 3SE7 704-2BA

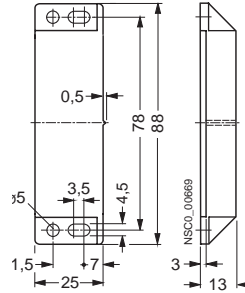

3SX3 260 spacer

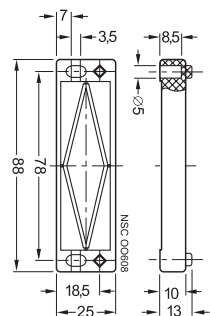

Switch block 3SE6 605-3BA

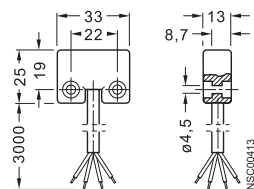

Coded switching magnet 3SE6 704-3BA

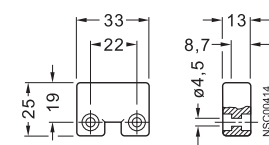

3SX3 261 spacer

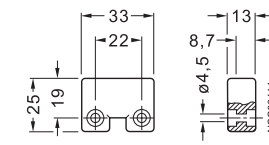

Monitoring unit

Magnet Switch Monitor 3SE6 806-2CD00

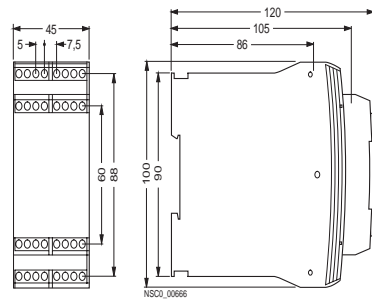

Circuit diagrams

Connection example

Single Channel Control, Manual Start, Category 3 to EN ISO 13849-1

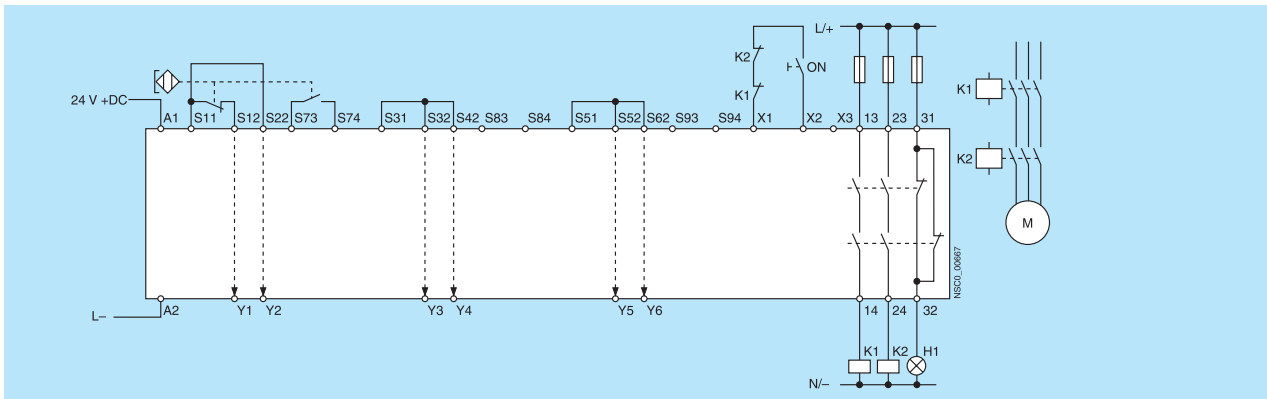

Six Channel Control. Automatic Start, Category 3 to EN ISO 13849-1

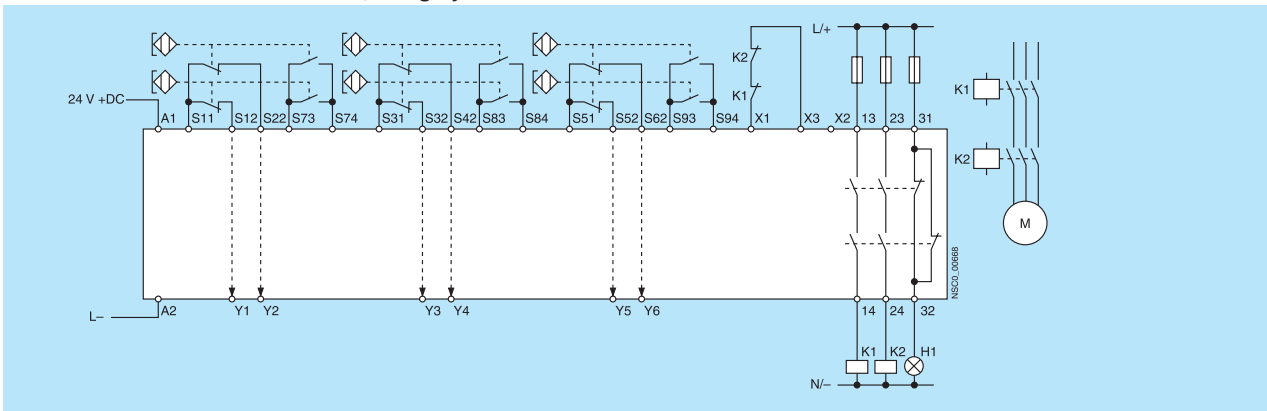

Terminal Assignments

Power	A1+, L+	U _s
	A2-, L-	24 V DC
Sensors	S11, S12	Channel 1, NC contact
	S11, S22	Channel 2, NC contact
	S31, S32	Channel 3, NC contact
	S31, S42	Channel 4, NC contact
	S51, S52	Channel 5, NC contact
	S51, S62	Channel 6, NC contact

Sensors (Cont.)	S73, S74	Channel 1+2, NO contact (parallel)
	S83, S84	Channel 3+4, NO contact (parallel)
	S93, S94	Channel 5+6, NO contact (parallel)
Outputs	13, 14	Release circuit 1 (safety NO contact)
	23, 24	Release circuit 2 (safety NO contact)
	31, 32	Floating signaling circuit
	Y1 to Y6	Status of Channels 1 through 6

3SE6 604-2BA magnetically operated switch with 3TK28 safety relay, Category 4 to EN ISO 13849-1

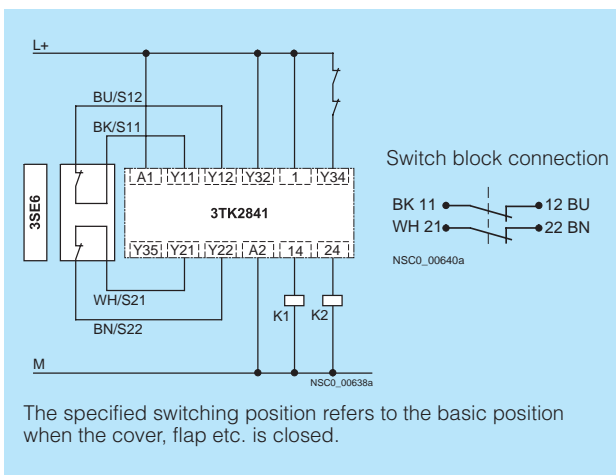

3SE6 604-2BA magnetically operated switch on AS-Interface Safety at Work, safe K45F or K60F compact module, Category 4 to EN ISO 13849-1

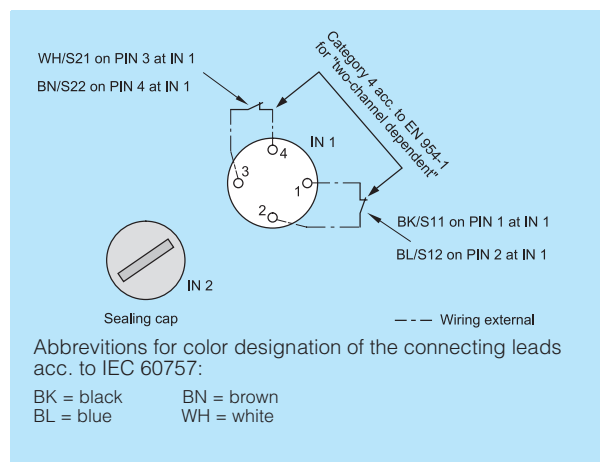

3SU1 Two-Hand Control

Selection

Application

Two-hand operation consoles are required for use with machines and systems that have hazardous areas, in order to direct both hands of the operator to one position.

Operation consoles are primarily used on presses, stamping machines, printing presses and paper converting machines, in the chemical industry and in the rubber and plastics industries.

Specifications

Two-hand operation consoles fulfill the requirements laid down in DIN 24 980 and EN 574.

Construction

Equipment

All consoles are pre-equipped with SIGNUM 3SU1 control devices. The metal version is also available as an unequipped empty enclosure.

The plastic version can be retrofitted with up to 8 command points, in line with the customer's requirements. The surface of the console has premachined breaking points for this purpose.

Installation



The two-hand operation consoles can be mounted either on the stand available or directly on the machine by means of the holes in the rear panel.

Principle of operation

The control command is given by pressing the two operating elements simultaneously (within

0.5 s of each other) and must be maintained for as long as a hazard exists.

Selection and ordering data

Design	DT	Order No.	List Price \$ 1 unit	Weight approx. kg	
 <p>3SU1853-3NB00-1AA1</p> <p>SIGUARD two-hand operation console Degree of protection IP 65, acc. to DIN 24 980 (EN 574), Standard equipment with 2 black operating elements (mushroom button 3SU1000-1BD10-0AA0, Ø 40 mm, 1 NO + 1 NC) and a red EMERGENCY-STOP mushroom button 3SU1000-1HB20-0AA0, latching Ø 40 mm, 2 NC</p> <ul style="list-style-type: none"> • Metal version <ul style="list-style-type: none"> - with standard equipment - with standard equipment and 4 additional holes for control devices 22.5 mm - empty enclosure, unequipped • Plastic version <ul style="list-style-type: none"> - with standard equipment and predetermined breaking points for 8 further command points 22.5 mm - with cable inlet holes for metric screwed cable glands 					
			3SU1853-3NB00-1AA1	4.800	
			3SU1853-3NB00-1AD1	4.800	
			3SU1853-3AA00-0AA1	4.800	
 <p>3SU1950-0HN10-0AA0</p> <p>Stand for SIGUARD two-hand operation consoles</p> <ul style="list-style-type: none"> • with cable inlet holes for metric screwed cable glands 					
			3SU1803-3NB00-1AE1	2.300	
		3SU1950-0HN10-0AA0	4.500		

Dimension drawings

3SU1853-3NB00-1AA1 operator panel with metal enclosure

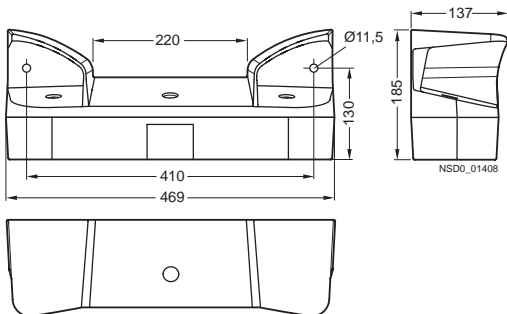

3SU1950-0HN10-0AA0 stand

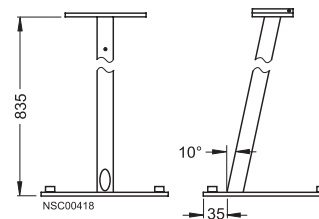

Note:
Also available with AS-Interface connection, contact your local Siemens representative.

Overview



SIRIUS 3SK safety relays

SIRIUS 3SK safety relays are the key elements of a consistent, cost-effective safety chain. Whether you need EMERGENCY-STOP disconnection, protective door monitoring, light arrays, laser scanners or the protection of presses or punches – with SIRIUS safety relays, all safety applications can be implemented within a minimum width to optimum effect in terms of engineering and price.

The following safety-related functions are available:

- Monitoring the safety functions of sensors
- Monitoring the sensor leads
- Monitoring the correct device function of the safety relay
- Monitoring the actuators in the shutdown circuit
- Safety-related disconnection when dangers arise

SIRIUS 3SK safety relays are approved for applications up to SIL 3 (IEC 61508/IEC 62061) or PL e (EN ISO 13849-1).

Device series

SIRIUS 3SK safety relays stand out due to their flexibility for both parameterization and system designs with several evaluation units. Optimized solutions when selecting components are facilitated by a clearly structured component range:

- 3SK1 Standard basic units
- 3SK1 Advanced basic units
- 3SK2 basic units
- 3SK output expansions
- 3SK1 input expansions
- Accessories

3SK1 Standard basic units

The 3SK1 Standard basic units are characterized by the following features:

- Compact design
- Simple operation
- Relay and semiconductor outputs
- Economical solution

3SK1 Advanced basic units

The 3SK1 Advanced basic units also offer:

- Universal application possibilities thanks to multifunctionality
- Time-delayed outputs
- Expansion of inputs and outputs

3SK2 basic units

The 3SK2 basic units also offer:

- Up to six fail-safe shutdown functions
- Flexible in use thanks to software parameterization
- Powerful semiconductor outputs
- User-friendly diagnostics using diagnostics display and configuring software

In the case of 3SK1 Advanced basic units or 3SK2 basic units, the 3ZY12 device connector allows safety functions involving several sensors and actuators to be constructed very quickly.

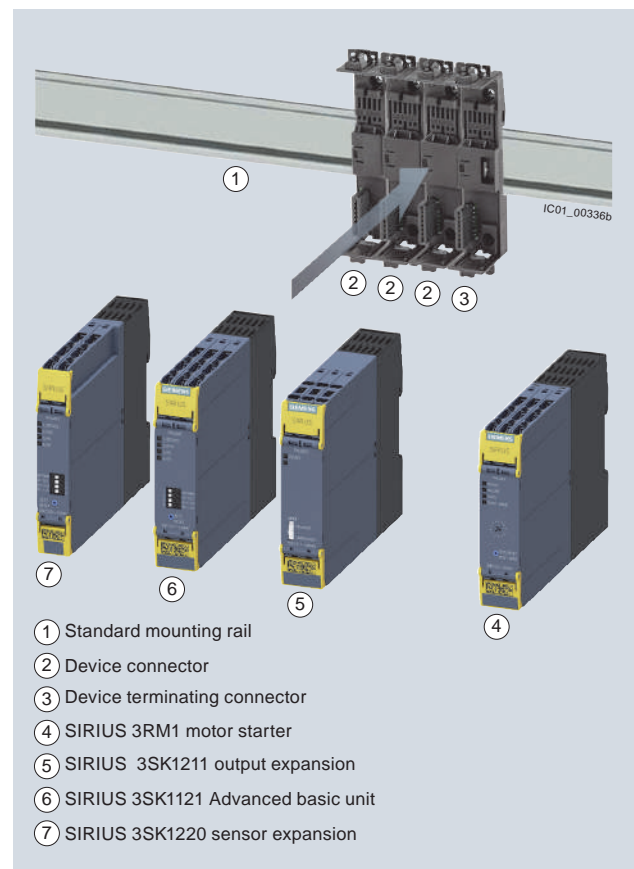

System configuration example

The 3SK1 and 3SK2 Standard and Advanced series are a high-quality replacement for the 3TK28 safety relays. In their narrower design, and equipped with greater functionality, they can replace every 3TK28 device. The only exception to this are the 3TK2810 devices.

Note:

Conversions from 3TK28 to 3SK, see www.siemens.com/sirius/conversion-tool.

Overview of functions of the 3SK series

Type	3SK1 Standard basic units		3SK1 Advanced basic units		3SK2 basic units	
	Safe relay outputs	Safe semiconductor outputs	Safe relay outputs	Safe semiconductor outputs	22.5 mm Safe semiconductor outputs	45 mm Safe semiconductor outputs
Sensors						
• Mechanical	✓	✓	✓	✓	✓	✓
• Single-ended	✓ ¹⁾	✓	✓	✓	✓	✓
• Antivalent	--	--	✓	✓	✓	✓
• Expandable	--	✓ by means of cascading	✓	✓	--	--
Inputs						
• Freely parameterizable	--	--	--	--	10 single-channel, 5 two-channel	20 single-channel, 10 two-channel
Parameters						
• Start (auto/monitored)	✓	✓	✓	✓	A variety of functions can be set for each input/output by means of software parameterization.	
• Sensor connection, 2 x 1-channel/ 1 x 2-channel	✓ by means of wiring	✓	✓	✓		
• Cross-circuit detection	✓ by means of wiring	✓	✓	✓		
• Start test ON/OFF	--	✓	✓	✓		
• Monitoring of two-hand operator controls according to EN 574	--	--	✓	✓		
• Pressure-sensitive mat	--	--	✓	✓		
Safe outputs						
• Instantaneous	✓	✓	✓	✓	Parameterizable	Parameterizable
• Time-delayed	--	--	✓	✓	Parameterizable	Parameterizable
• Expandable with safe relay outputs	✓ by means of wiring	✓ by means of wiring	✓	✓	✓	✓
• Independent	--	--	--	--	✓ ⁴⁾	✓ ⁵⁾
• Device connectors	--	--	✓	✓	✓	✓
Options						
• External memory module	--	--	--	--	--	✓
• Display on the device	--	--	--	--	--	✓
• External diagnostics module can be connected	--	--	--	--	✓	✓
Rated control supply voltage						
• 24 V DC	✓ ²⁾	✓	✓	✓	✓	✓
• 115 ... 240 V AC/DC	✓	--	✓ ³⁾	✓ ³⁾	--	--

✓ Available
 -- Not available

1) 24 V basic units only.
 2) 24 V AC/DC.
 3) Possible using 3SK1230 power supply via device connector.
 4) Up to 4 independent safe outputs, two of which via device connectors.
 5) Up to 6 independent safe outputs, two of which via device connectors.

SIRIUS 3SK

General Data

Parameterization

3SK112 and 3SK1112 with DIP switch

The 3SK112 and 3SK1112 safety relays are configurable safety relays. They are used as evaluation units for typical safety chains (identify, evaluate, realize). A number of functions can be set using the DIP switches on the front. 3SK112 and 3SK1112 are therefore universally applicable.

DIP switch No.	OFF	ON	Schematic
1	Sensor input Autostart	Sensor input Monitored start	
2	Without crossover monitoring	With crossover monitoring	
3	2 x single-channel sensor connection	1 x 2-channel sensor connection	
4	With start test	Without start test	

3SK2 with software

The 3SK2 safety relays are configured with the SIRIUS Safety ES software. The behavior of a 3SK2 device as well as the functioning of the individual safe outputs can thus be parameterized simply and conveniently in the logic diagram. In addition, the configuration can be printed out for documentation purposes. The software also supports users in commissioning and troubleshooting by means of online diagnostics and the option of "forcing" signals in the logic diagram. The 3SK2 safety relays thus offer maximum flexibility and universal application options.

Note:

For SIRIUS Safety ES, [see page 13/155](#).

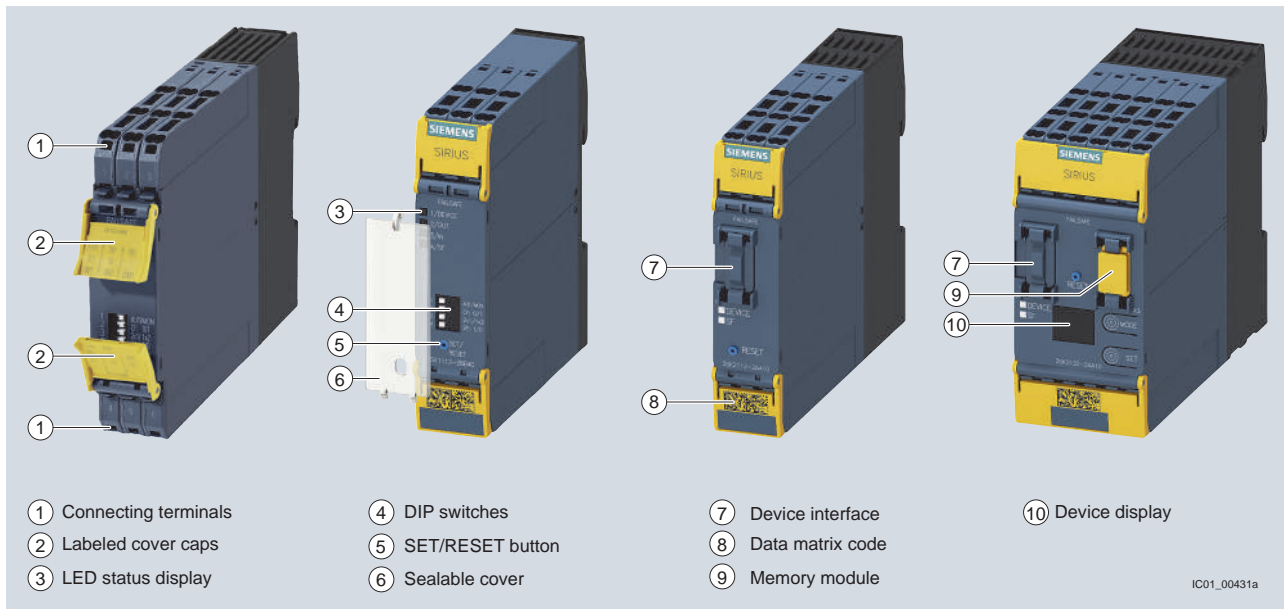

Innovative enclosure concept for SIRIUS 3SK safety relays

Expansion option by adding the 3RM1 motor starter

With previous safety relay and motor feeder configurations, a huge amount of wiring was required to monitor the motor feeders in safety applications.

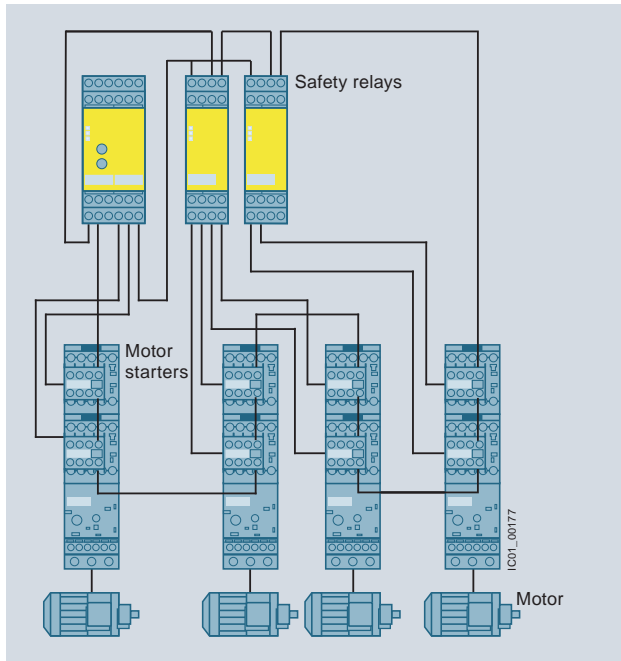

Conventional system configuration

With the integration of the SIRIUS 3RM1 motor starter into the SIRIUS 3SK safety relay system family, this wiring has been minimized for the first time.

Motor starters up to 3 kW can easily be integrated into the safety relay system using SIRIUS 3ZY12 device connectors, without additional wiring between the evaluation unit and the motor starter.

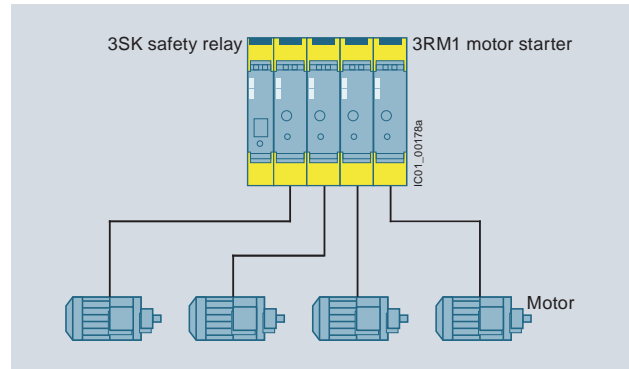

System design using 3SK and 3RM1

Article No. scheme

3SK1

Digit of the Article No.	1st - 3rd	4th	5th	6th	7th	8th	9th	10th	11th	12th	
Safety relays	3SK										
Generation		<input type="checkbox"/>									
Device version			<input type="checkbox"/>								
Device series				<input type="checkbox"/>							
Type of outputs					<input type="checkbox"/>						
Connection type						<input type="checkbox"/>					
Rated control supply voltage							<input type="checkbox"/>				
Type of rated control supply voltage								<input type="checkbox"/>			
Time delay									<input type="checkbox"/>		
Example	3SK	1	1	2	1	-	1	A	B	4	0

3SK2

Digit of the Article No.	1st - 3rd	4th	5th	6th	7th	8th	9th	10th	11th	12th	
Safety relays	3SK										
Generation		<input type="checkbox"/>									
Device version			<input type="checkbox"/>								
Device version, alternative volume of project data				<input type="checkbox"/>							
Type of outputs					<input type="checkbox"/>						
Connection type						<input type="checkbox"/>					
Example	3SK	2	1	1	2	-	1	A	A	1	0

Note:

The Article No. scheme is presented here merely for information purposes and for better understanding of the logic behind the article numbers.

For your orders, please use the article numbers quoted in the catalog in the Selection and ordering data.

Benefits**General**

- Approved for all safety applications because of its compliance with the highest safety requirements (SIL 3 and PL e)
- Universally usable thanks to adjustable parameters
- Usable worldwide thanks to globally valid certificates
- Compact SIRIUS design
- Device connectors with standard rail mounting for flexible connectability and expandability
- Removable terminals for greater plant availability
- Yellow terminal covers clearly identify the device as a safety component.
- Sensor cable up to 2 000 m long allows it to be used in extensive plants.

Relay outputs

- Different voltages can be switched through the floating contacts.
- The power relay contacts allow currents of up to 5 A at AC-15/DC-13 to be connected.

Semiconductor outputs

- Wear-free
- Suitable for operation in fast switching applications
- Insensitive to vibrations and dirt
- Good electrical endurance

Power outputs (3SK1213 output expansion)

- Different voltages can be switched through the floating contacts.
- The power relay contacts allow currents of up to 10 A AC-15/6 A DC-13 to be connected.
- High mechanical and electrical endurance
- Protective separation between safe outputs and electronics

Expansion option by adding the 3RM1 motor starter

SIRIUS 3SK safety relays are ideal for combining with the SIRIUS 3RM1 motor starters.

Combinations are made by means of

- SIRIUS 3ZY12 device connectors (in combination with 3SK1 Advanced/3SK2) or
- Conventional wiring (for all 3SK1 and 3SK2 basic units).

This makes collective shutdown very easy in assemblies. The wiring, and ultimately the shutting down of the control supply voltage for the expansion components in EMERGENCY-STOP situations, is performed via the device connector. There is no further need for complex looping of the connecting cables between the safety relay and the motor starters.

The 3RM1 motor starter combines the benefits of semiconductor technology and relay technology. This combination is also known as hybrid technology.

The hybrid technology in the motor starter is characterized by the following features:

- The inrush current in the case of motorized loads is conducted briefly via the semiconductors. Advantages include protection of the relay contacts and a long service life due to low wear.
- The uninterrupted current is conducted via relay contacts. Advantages include lower heat losses compared with the semiconductor.
- Shutdown is implemented again via the semiconductor. The contacts are only slightly exposed to arcs, and this results in a longer service life.
- Integrated overload protection

3ZY12 device connectors

Using 3ZY12 device connectors to combine devices reduces the time required to configure and wire the components. At the same time errors are avoided during wiring, and this considerably reduces the testing required for the fully-assembled application.

Configuration and stock keeping

Variable setting options by means of DIP switches or software, a wide voltage range (3SK1111) and a special power supply unit (3SK1 only) reduce the cost of keeping stocks and the considerations involved in configuration where the evaluation units to be selected are concerned.

Application**3SK1 safety relays**

SIRIUS 3SK1 safety relays are used mainly in autonomous safety applications which are not connected to a safety-related bus system. Their function here is to evaluate the sensors and the safety-related shutdown of hazards. Also they check and monitor the sensors, actuators and safety-related functions of the safety relay.

3SK2 safety relays

SIRIUS 3SK2 safety relays are used primarily in autonomous, more complex safety applications for which the functional scope of the 3SK1 devices is no longer sufficient, such as in the implementation of independent shutdown functions. Their function here is to evaluate the sensors and the safety-related shutdown of hazards. Also they check and monitor the sensors, actuators and safety-related functions of the safety relay.

Technical specifications

SIRIUS 3SK1 safety relays

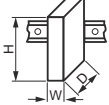
Type	3SK1111- .AB30, 3SK1211- .BB00, 3SK1211- .BB40	3SK1111- .AW20, 3SK1121, 3SK1211- .BW20	3SK1112	3SK1120	3SK1122	3SK1213	3SK1220		
Dimensions • Width • Height • Depth		mm	22.5	22.5	22.5	17.5	22.5	90	17.5
	mm	100	100	100	100	100	100	100	100
	mm	121.6	121.6	91.6	121.6	121.6	121.6	121.6	121.6

General data							
Ambient temperature							
• During operation	°C	-25 ... +60					
• During storage	°C	-40 ... +80					
Installation altitude at height above sea level maximum		m	2 000				
Air pressure		kPa	90 ... 106				
According to SN 31205							
Shock resistance			10 g / 11 ms			5 g / 10 ms	10 g / 11 ms
Vibration resistance			5 ... 500 Hz: 0.75 mm				
Acc. to IEC 60068-2-6							
IP degree of protection of the enclosure			IP20				
Touch protection against electric shock			Finger-safe				
Insulation voltage, rated value		V	300	50		300	50
Rated impulse withstand voltage		V	4 000	500		4 000	800
Safety integrity level (SIL)			SIL 3				
According to IEC 61508							
Performance level (PL)			e				
According to ISO 13849-1							
T1 value for proof test interval or a service duration		a	20				
According to IEC 61508							
EMC emitted interference			IEC 60947-5-1, class B	IEC 60947-5-1, class A		IEC 60947-5-1, class B	IEC 60947-5-1, class A
Certificate of suitability			Yes				
• UL certification			Yes				
• TÜV approval			Yes				

Type	3SK1111, 3SK1121-.AB40, 3SK1211	3SK1112, 3SK1122	3SK1120	3SK1121-.CB4.	3SK1213
------	---------------------------------------	---------------------	---------	---------------	---------

Switching capacity					
Switching capacity current of the NO contacts of the relay outputs					
• At AC-15 at 230 V	A	5	--	3	10
• At DC-13 at 24 V	A	5	--	3	6
Switching capacity current of the semiconductor outputs					
• At DC-13 at 24 V	A	--	2	0.5	--

Type	3SK1111- .AB30, 3SK1211	3SK1111- .AW20	3SK1112, 3SK1220	3SK1120, 3SK1122- .AB40	3SK1121- .AB40	3SK1121- .CB4.	3SK1122- .CB4.	3SK1213
------	-------------------------------	-------------------	---------------------	-------------------------------	-------------------	-------------------	-------------------	---------

PFHd and PFDavg values										
PFHD with high demand rate		1/h	1.7 x 10 ⁻⁹	1.5 x 10 ⁻⁹	1.0 x 10 ⁻⁹	1.3 x 10 ⁻⁹	2.5 x 10 ⁻⁹	3.7 x 10 ⁻⁹	1.5 x 10 ⁻⁹	1.0 x 10 ⁻⁹
according to EN 62061										
Average probability of failure of the safety function upon demand (PFDavg) at a low demand rate			1.0 x 10 ⁻⁶		7.0 x 10 ⁻⁶					1.0 x 10 ⁻⁶
acc. to IEC 61508										

Note:

For the 3SK1230 technical specifications, see Manual "3SK1 Safety Relays", <https://support.industry.siemens.com/cs/ww/en/view/67585885>.

SIRIUS 3SK

General Data

SIRIUS 3SK2 safety relays

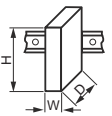
Type	3SK2112-.AA10		3SK2122-.AA10	
Dimensions: <ul style="list-style-type: none"> • Width • Height • Depth 		mm	22.5	45
		mm	100	100
		mm	124.5	124.5
General data				
Ambient temperature				
• During operation	°C	-25 ... +60		
• During storage	°C	-40 ... +80		
Installation altitude at height above sea level maximum	m	2 000		
Air pressure According to SN 31205	kPa	90 ... 106		
Shock resistance	15 g / 11 ms			
Vibration resistance acc. to IEC 60068-2-6	5 ... 500 Hz: 0.75 mm			
IP degree of protection of the enclosure	IP20			
Touch protection against electric shock	Finger-safe			
Insulation voltage, rated value	V	50		
Rated impulse withstand voltage	V	800		
Safety integrity level (SIL) According to IEC 61508	SIL 3			
Performance level (PL) According to EN ISO 13849-1	e			
T1 value for proof test interval or service duration According to IEC 61508	y	20		
EMC emitted interference According to IEC 60947-1	Class A			
Certificate of suitability				
• UL certification	Yes			
• TÜV approval	Yes			
Switching capacity				
Switching capacity current of the semiconductor outputs				
• At DC-13 at 24 V	A	4		
PFHd and PFDavg values				
PFHd with high demand rate according to EN 62061	1/h	1 x 10 ⁻⁸	1.2 x 10 ⁻⁸	
PFDavg at low demand rate according to IEC 61508		1.5 x 10 ⁻⁵	1.8 x 10 ⁻⁵	

Note:

Manual "3SK2 Safety Relays", see <https://support.industry.siemens.com/cs/ww/en/view/109444336>.

Circuit diagrams

3SK1 basic units

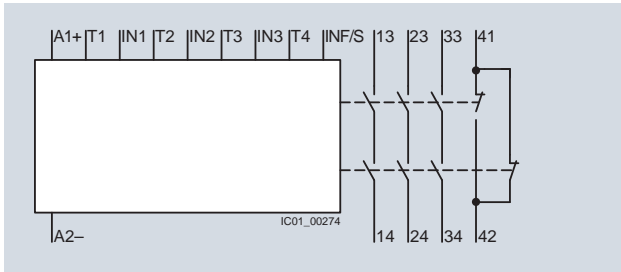

Basic unit 3SK1111-.AB30, Standard relay instantaneous (24 V AC/DC)

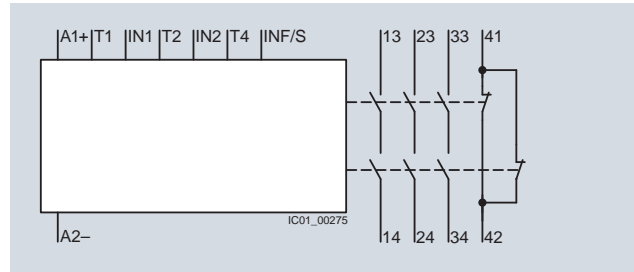

Basic unit 3SK1111-.AW20, Standard relay instantaneous (110 ... 240 V AC/DC)

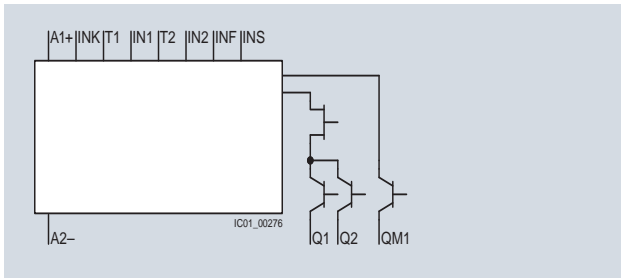

Basic unit 3SK1112-.BB40, Standard solid-state (24 V DC)

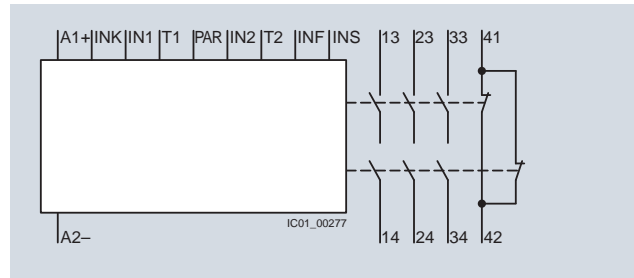

3SK1121-.AB40, Advanced relay instantaneous basic unit

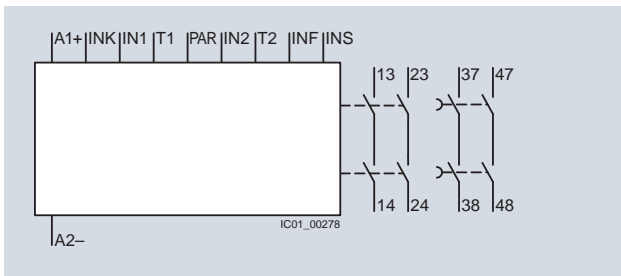

3SK1121-.CB4, Advanced relay instantaneous basic unit

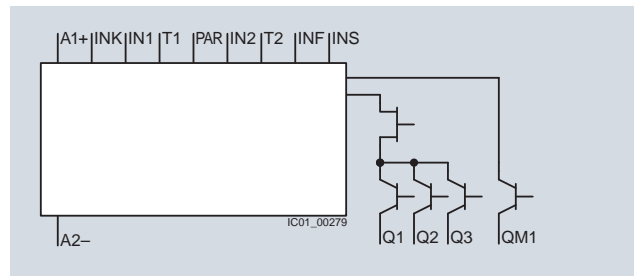

3SK1122-.AB40, Advanced solid-state instantaneous basic unit

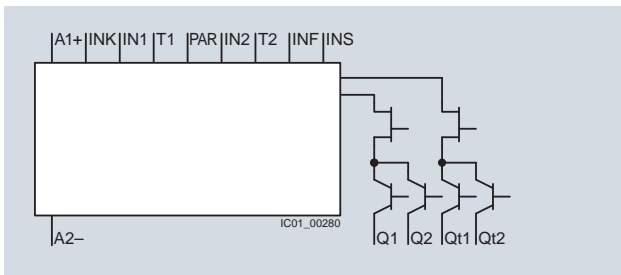

3SK1122-.CB4, Advanced solid-state instantaneous basic unit

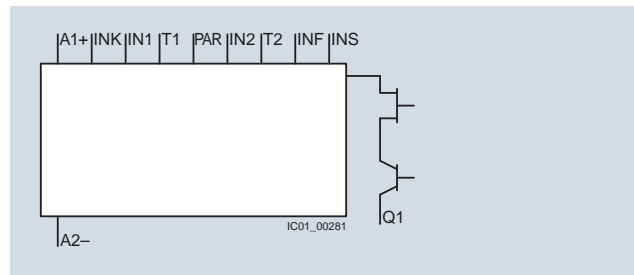

3SK1120-.AB40, Advanced 17.5 mm solid-state instantaneous basic unit

Legend:

- A1, A2 = Power supply of the device
- 13/14 to 33/34 = Instantaneous safe outputs, relays
- 41/42 = Feedback contact
- T1, T2 = Test signal
- IN1, IN2 = Sensor input
- INF = Feedback circuit

- INS = Start circuit
- INK = Cascading input
- PAR = Parameterizing input (NO/NC monitoring)
- Q1, Q2, Q3 = Instantaneous enabling circuit, solid-state
- QM1 = Signaling output, solid-state

3SK2 basic units

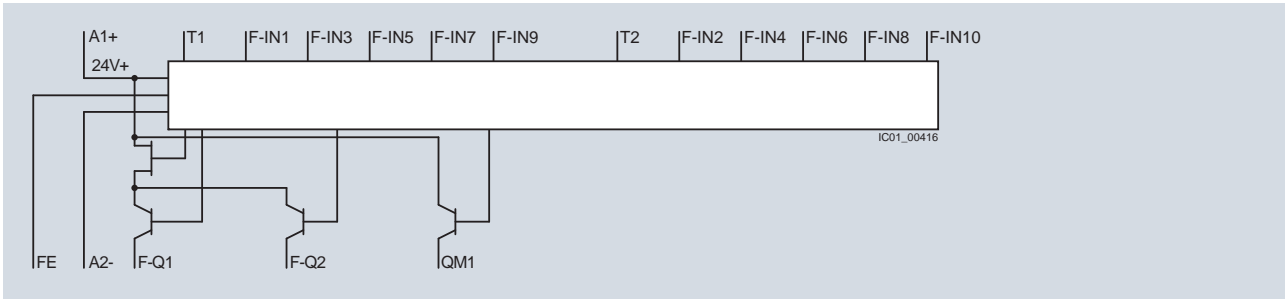

3SK2112 basic unit

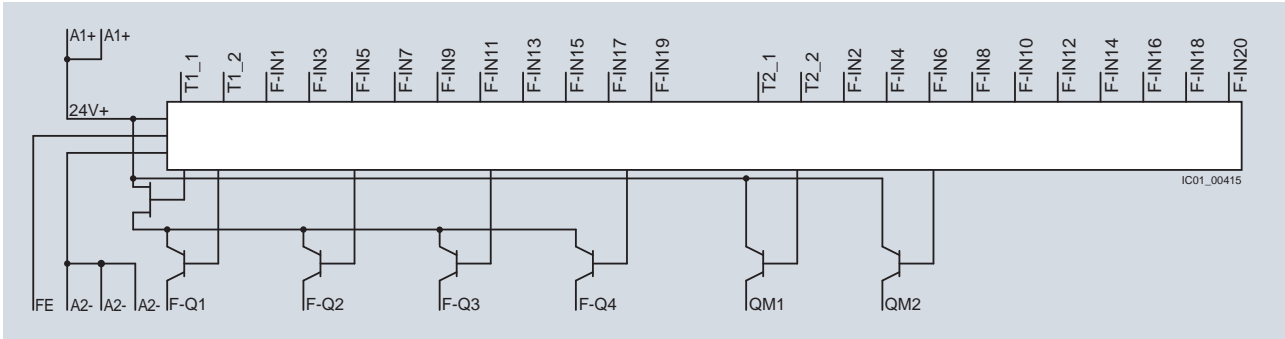

3SK2122 basic unit

Legend:

A1, A2 = Power supply of the device

FE = Functional ground

T1, T2 = Test signal

T1_1, T2_1 = First pair of test signals

T2_1, T2_2 = Second pair of test signals

F-IN1 to F-IN20 = Fail-safe sensor inputs 1 to 20

F-Q1 to F-Q4 = Fail-safe outputs, solid-state

QM1, QM2 = Signaling outputs, solid-state

Circuit diagrams

Expansion units

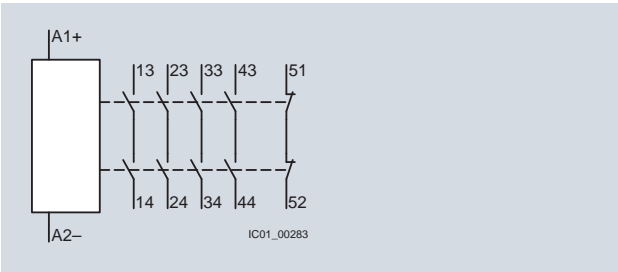

4RO 3SK1211 output expansion

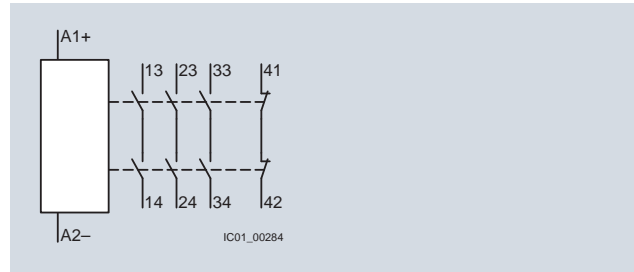

3RO 3SK1213 output expansion

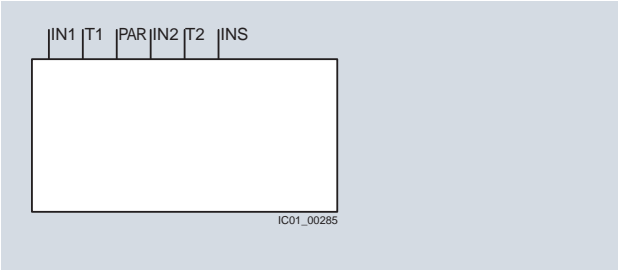

3SK1220 input expansion

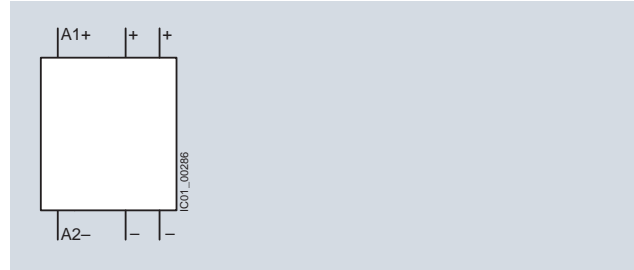

3SK1230 power supply

Legend:

A1, A2 = Power supply of the device
 13/14 to 43/44 = Safe outputs, relays
 41/42 to 51/52 = Feedback contact
 T1, T2 = Test signal

IN1, IN2 = Sensor input
 INS = Start circuit
 PAR = Parameterizing input (NO/NC monitoring)

More information

For the manual "3SK1 Safety Relays", see <https://support.industry.siemens.com/cs/ww/en/view/67585885>.

For the manual "3SK2 Safety Relays", see <https://support.industry.siemens.com/cs/ww/en/view/109444336>.

SIRIUS 3SK

3SK1 Standard basic units

Overview



3SK111 Standard basic units

The 3SK111 Standard basic units are characterized by simple, variable functionality. These devices are recommended for safety functions requiring only a few sensors and a small number of outputs on the safety relay.

Number of safe outputs

	Type and number of safe outputs				Signal- ing circuits	Device connec- tors
	Relays		Semiconductors			
	Instanta- neous	Time- delayed	Instanta- neous	Time- delayed		
3SK1 Standard basic units						
3SK1111-.A..0	3	--	--	--	1	--
3SK1112-.BB40	--	--	2	--	1	--

-- Not available

Selection and ordering data

PU (UNIT, SET, M) = 1
 PS* = 1 unit
 PG = 41L





3SK1111-1AB30



3SK1111-1AW20



3SK1112-1BB40

Rated control supply voltage U_s		DT	Screw terminals 	DT	Spring-type terminals (push-in) 	
At 50 Hz At AC	At DC		Article No.	Price per PU	Article No.	Price per PU
V		V				
Standard basic units with 3 safe relay outputs						
24	24	▶	3SK1111-1AB30	▶	3SK1111-2AB30	
110 ... 240	110 ... 240	A	3SK1111-1AW20	▶	3SK1111-2AW20	
Standard basic units with 2 safe semiconductor outputs						
--	24	A	3SK1112-1BB40	A	3SK1112-2BB40	

Overview



3SK112 Advanced basic units

The 3SK112 Advanced basic units form an innovative system landscape that allows even complex safety functions with large numbers of sensors and outputs to be built up using the device connectors. It is possible to increase both the number of inputs for sensors and the number of safe outputs of the basic unit without the need for wiring outlay between the devices.

Number of safe outputs

	Type and number of safe outputs				Signal- ing circuits	Device connec- tors
	Relays		Semiconductors			
	Instanta- neous	Time- delayed	Instanta- neous	Time- delayed		
3SK1 Advanced basic units						
3SK1120-.AB40	--	--	1	--	--	✓
3SK1121-.AB40	3	--	--	--	1	✓
3SK1121-.CB4.	2	2	--	--	--	✓
3SK1122-.AB40	--	--	3	--	1	✓
3SK1122-.CB4.	--	--	2	2	--	✓

- ✓ Available
- Not available

Selection and ordering data

PU (UNIT, SET, M) = 1
 PS* = 1 unit
 PG = 41L



3SK1121-1AB40



3SK1120-1AB40



3SK1122-1AB40



3SK1122-1CB41

Rated control supply voltage U_s at DC	Adjustable OFF-delay time	Number of outputs				DT	Screw terminals		DT	Spring-type terminals (push-in)	
		as contacting contact block		as contactless semiconductor contact block			Article No.	Price per PU		Article No.	Price per PU
V	s	Instantaneous switching	Delayed switching	Instantaneous switching	Delayed switching						
Advanced basic units with safe relay outputs											
24	--	3	--	--	--	▶	3SK1121-1AB40	▶	3SK1121-2AB40		
24	0.05 ... 3	2	2	--	--	A	3SK1121-1CB41	B	3SK1121-2CB41		
24	0.5 ... 30	2	2	--	--	▶	3SK1121-1CB42	A	3SK1121-2CB42		
24	5 ... 300	2	2	--	--	B	3SK1121-1CB44	B	3SK1121-2CB44		
Advanced basic units with safe semiconductor outputs											
24	--	--	--	1	--	A	3SK1120-1AB40	A	3SK1120-2AB40		
24	--	--	--	3	--	A	3SK1122-1AB40	A	3SK1122-2AB40		
24	0.05 ... 3	--	--	2	2	B	3SK1122-1CB41	B	3SK1122-2CB41		
24	0.5 ... 30	--	--	2	2	A	3SK1122-1CB42	A	3SK1122-2CB42		
24	5 ... 300	--	--	2	2	B	3SK1122-1CB44	B	3SK1122-2CB44		

Overview



3SK2 basic units

The 3SK2 basic units have a large number of inputs and outputs within a narrow width. In addition, demanding safety applications can be implemented simply with several independent safety functions. Flexible application options are enabled by powerful semiconductor outputs, as well as by expandability with additional 3SK output expansions and 3RM1 Failsafe motor starters. Flexible time functions and diagnostics options are also available.

Number of safe outputs

	Type and number of safe outputs Semiconductors	Signaling circuits Semi-conductors	Fail-safe outputs by means of device connectors
3SK2 basic units			
3SK2112-AA10	2	1	2
3SK2122-AA10	4	2	2

Selection and ordering data



PU (UNIT, SET, M) = 1
 PS* = 1 unit
 PG = 41L



3SK2112



3SK2122

Rated control supply voltage U_s At DC V	Number of outputs, safety-related 2-channel	Width mm	DT	Screw terminals 		Spring-type terminals (push-in) 	
				Article No.	Price per PU	Article No.	Price per PU
3SK2 basic units							
24	2	22.5	A	3SK2112-1AA10	A	3SK2112-2AA10	
24	4	45	A	3SK2122-1AA10	A	3SK2122-2AA10	

Overview



3SK121 output expansion

The 3SK121 output expansions can be used to expand all 3SK basic units.

3SK1211 output expansion

The 3SK1211 output expansion is used to expand the safe outputs of a basic unit by adding another four safe outputs. These outputs have a switching capacity of AC-15 5 A at a switching voltage of 230 V. The devices can be connected to any 3SK basic unit by means of wiring. In addition, the devices with a 24 V DC control supply voltage can also be connected to 3SK1 Advanced and 3SK2 basic units by means of the 3ZY12 device connectors.

3SK1213 output expansion

The 3SK1213 output expansion is used to expand the safe outputs of a basic unit by adding three safe outputs with high switching capacity. These outputs have a switching capacity of AC-15 10 A at a switching voltage of 230 V. The devices can be connected to any 3SK basic unit by means of wiring. As with the 3SK1211, the devices with a 24 V DC control supply voltage can also be connected to 3SK1 Advanced and 3SK2 basic units by means of the 3ZY12 device connectors.

Note:

It is only possible to expand the Standard basic units by means of wiring. Advanced basic units and 3SK2 basic units can be expanded using the 3ZY12 device connector.

Number of safe outputs

	Type and number of safe outputs		Signaling circuits	Device connectors
	Relays			
	Instantaneous	Time-delayed		

3SK output expansions

• 4RO				
3SK1211	4	--	1 ¹⁾	✓ ²⁾
• 3RO				
3SK1213	3	--	1 ¹⁾	✓ ²⁾

✓ Available

-- Not available

¹⁾ Feedback circuit.

²⁾ For 24 V DC.

Benefits

- Perfect adaptation of the number of inputs
- Simple expansion of instantaneous and time-delayed safe outputs of the Advanced basic units by means of backplane connection
- When using the device connector the outputs on the terminals can still be used
- Another two freely parameterizable shutdown functions on 3SK2 basic modules when using the device connectors
- Expansion with power contacts for high AC-15/DC-13 currents in the control circuit
- Wiring of the feedback circuit to the basic units not required when using the device connectors
- Shorter installation times
- Less configuring and testing required

SIRIUS 3SK

Output expansions

Selection and ordering data



PU (UNIT, SET, M) = 1
 PS* = 1 unit
 PG = 41L



3SK1211-1BB00



3SK1213-1AB40

Rated control supply voltage U_s		DT	Screw terminals 	DT	Spring-type terminals (push-in) 	
At 50 Hz At AC V	At DC V		Article No.	Price per PU	Article No.	Price per PU
3SK1211 output expansions with 4RO						
24	--	B	3SK1211-1BB00	B	3SK1211-2BB00	
--	24	▶	3SK1211-1BB40	A	3SK1211-2BB40	
110 ... 240	110 ... 240	A	3SK1211-1BW20	B	3SK1211-2BW20	
3SK1213 output expansions with 3RO						
--	24	B	3SK1213-1AB40	B	3SK1213-2AB40	
115	--	B	3SK1213-1AJ20	B	3SK1213-2AJ20	
230	--	B	3SK1213-1AL20	B	3SK1213-2AL20	

Overview



3SK1220 sensor expansion

With the input expansions

- 3SK1220 sensor expansion
- 3SK1230 power supply

the 3SK1 Advanced basic units can be made more flexible.

3SK1220 input expansion

The 3SK1220 input expansion allows additional sensors to be integrated easily and flexibly. The device monitors two 1-channel sensors or one 2-channel sensor, whatever their output technology (floating/single-ended).

Note:

The 3SK1220 sensor expansion can only be connected to the 3SK1 Advanced basic units by means of the 3ZY12 device connector.

3SK1230 power supply

The 3SK1230 power supply makes the 3SK1 devices universally usable, whatever control supply voltage is to be used.

Both devices can be combined with the 3SK112 basic units in the Advanced series without the need for wiring.

Note:

Alongside the 3ZY12 device connector, the 3SK1230 power supply can also be wired to act as a power supply for 3SK1 devices.

Benefits

- A wide voltage range of 110 ... 240 V AC/DC allows the devices to be used worldwide
- Low stock keeping due to little variance
- Flexible expansion of the number of sensors without the need for additional wiring between the devices
- Perfect adaptation of the number of inputs to suit the application
- Universal use thanks to the wide range of adjustable parameters for sensor expansion (parameters as for 3SK1 Advanced basic units)

Selection and ordering data



PU (UNIT, SET, M) = 1
 PS* = 1 unit
 PG = 41L



3SK1220-1AB40



3SK1230-1AW20

Version	DT	Screw terminals 	DT	Spring-type terminals (push-in) 	
		Article No.	Price per PU	Article No.	Price per PU
3SK1220 sensor expansions		Sensor expansions for safety-related expansion of the 3SK1 Advanced basic A units by adding a further 2-channel sensor or two 1-channel sensors			
<u>Note:</u> Can only be used in conjunction with 3ZY12 device connectors, see page 13/133.					
3SK1230 power supplies		Power supplies for supplying 3SK1 Advanced basic units via 3ZY12 device A connectors at voltages of 110 ... 240 V AC/DC			
		3SK1220-1AB40	A	3SK1220-2AB40	
		3SK1230-1AW20	A	3SK1230-2AW20	

Overview

The following accessories are available for SIRIUS 3SK safety relays:

- Device connectors
- Terminals
- Sealing covers
- Push-in lugs
- Coding pins
- Inscription labels
- Tools

And additionally for 3SK2:

- Connection cables (essential accessory)
- USB PC cables and adapters
- Diagnostics modules
- Memory modules
- Interface covers
- Door adapters

Device connectors for 3SK112., 3SK12.. and 3SK2

The device connector can be used to connect devices of the 3SK/ 3RM1 system together, with the last device in a system configuration being placed on a device terminating connector.

Device connectors are available in various versions specifically for the 3SK safety relays:

For type	Device connectors				Device terminating connectors	
	3ZY1212-1BA00 (for 3SK1, width 17.5 mm)	3ZY1212-2BA00 (for 3SK1, width 22.5 mm)	3ZY1212-2GA00 (for 3SK2, width 22.5 mm)	3ZY1212-4GA01 (for 3SK2, width 45 mm)	3ZY1212-2DA00 (for 3SK1, width 22.5 mm)	3ZY1212-0FA01 (for 3SK1, set for enclosures ≥ 45 mm)
3SK1 Advanced basic units						
3SK1120	✓	--	--	--	--	--
3SK1121	--	✓	--	--	✓	--
3SK1122	--	✓	--	--	✓	--
3SK2 basic units						
3SK2112	--	--	✓	--	--	--
3SK2122	--	--	--	✓	--	--
Output expansions						
3SK1211	--	✓	✓	✓	✓	--
3SK1213	--	--	✓	✓	--	✓
Input expansions						
3SK1220	✓	--	--	--	--	--
3SK1230	--	✓	--	--	--	--

✓ Available

-- Not available

Removable terminals for 3SK

The following removable terminals are available for the 3SK safety relays for pre-wiring of the terminals in the control cabinet, or for replacing terminals:

For type	Removable terminals			
	Screw terminals		Spring-type terminals (push-in)	
	2-pole 3ZY1121-1BA00	3-pole 3ZY1131-1BA00	2-pole 3ZY1121-2BA00	3-pole 3ZY1131-2BA00
3SK1 basic units				
3SK1111	--	✓	--	✓
3SK1112	✓	--	✓	--
3SK1120	--	✓	--	✓
3SK1121	--	✓	--	✓
3SK1122	✓ bottom	✓ top	✓ bottom	✓ top
3SK2 basic units				
3SK2112	--	✓	--	✓
3SK2122	--	✓ ¹⁾	--	✓ ¹⁾
Output expansions				
3SK1211	✓	--	✓	--
3SK1213	--	--	--	--
Input expansions				
3SK1220	--	✓ top	--	✓ top
3SK1230	✓ bottom	--	✓ bottom	--

✓ Available







-- Not available





¹⁾ Two sets of terminals are required for 3SK2122.

Selection and ordering data

Version	DT	Article No.	Price per PU	PU (UNIT, SET, M)	PS*	PG	
Device connectors for the electrical connection of SIRIUS devices in the industrial standard mounting rail enclosure							
Device connectors for 3SK1							
 3ZY1212-1BA00							
<ul style="list-style-type: none"> • Width 17.5 mm • Width 22.5 mm 							
	A	3ZY1212-1BA00		1	1 unit	41L	
	A	3ZY1212-2BA00		1	1 unit	41L	
Device connectors for 3SK2							
 3ZY1212-4GA01							
<ul style="list-style-type: none"> • Width 22.5 mm • Width 45 mm 							
	NEW A	3ZY1212-2GA00		1	1 unit	41L	
	NEW A	3ZY1212-4GA01		1	1 unit	41L	
Device terminating connectors							
 3ZY1212-2DA00							
For 3SK1, width 22.5 mm							
Note: Observe positions of the slide switch, see Manual "3SK1 Safety Relays", https://support.industry.siemens.com/cs/ww/en/view/67585885							
Device terminating connector set							
	A	3ZY1212-0FA01		1	1 unit	41L	
For 3SK1213, width > 45 mm, comprising 3ZY1212-2FA00 and 3ZY1210-2AA00							
Terminals for SIRIUS devices in the industrial standard mounting rail enclosure							
Removable terminals							
 3ZY1121-1BA00							
<ul style="list-style-type: none"> • 2-pole, screw terminals up to 2 x 1.5 mm² or 1 x 2.5 mm² • 3-pole, screw terminals up to max. 2 x 1.5 mm² or 1 x 2.5 mm² 1) 							
	A	Screw terminals 					
	A	3ZY1121-1BA00		1	6 units	41L	
	A	3ZY1131-1BA00		1	6 units	41L	
<ul style="list-style-type: none"> • 2-pole, push-in terminals up to max. 2 x 1.5 mm² • 3-pole, push-in terminals up to max. 2 x 1.5 mm² 1) 							
	A	Spring-type terminals (push-in) 					
	A	3ZY1121-2BA00		1	6 units	41L	
	A	3ZY1131-2BA00		1	6 units	41L	
Connection cables for 3SK2 (essential accessory)							
Connection cables							
 3UF7932-0AA00-0							
	For connecting diagnostics module to 3SK2 basic unit						
		▶	3UF7931-0AA00-0		1	1 unit	42J
		▶	3UF7935-0AA00-0		1	1 unit	42J
		▶	3UF7932-0AA00-0		1	1 unit	42J
		▶	3UF7932-0BA00-0		1	1 unit	42J
		▶	3UF7937-0BA00-0		1	1 unit	42J
	▶	3UF7933-0BA00-0		1	1 unit	42J	
PC cables and adapters for 3SK2							
USB PC cables							
 3UF7941-0AA00-0							
For connecting to the USB interface of a PC/PG, for communication with 3SK2 through the system interface, recommended for use in connection with 3SK2							
	▶	3UF7941-0AA00-0		1	1 unit	42J	
USB/serial adapters							
	B	3UF7946-0AA00-0		1	1 unit	42J	
For connecting an RS 232 PC cable to the USB interface of a PC							

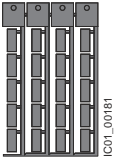
1) Two sets of terminals are required for 3SK2122.

Version	DT	Article No.	Price per PU	PU (UNIT, SET, M)	PS*	PG
Operating and monitoring modules for 3SK2						
	Diagnostics modules	A	3RK3611-3AA00	1	1 unit	42B
3RK3611-3AA00	From product version E04 or higher, for direct display of errors, e.g. of cross-circuits					
Door adapters for 3SK2						
	Door adapters	▶	3UF7920-0AA00-0	1	1 unit	42J
3UF7920-0AA00-0	For external connection of the system interface, e.g. outside a control cabinet					
Interface covers for 3SK2						
	Interface covers	▶	3UF7950-0AA00-0	1	5 units	42J
3UF7950-0AA00-0	For system interface					
Memory modules for 3SK2						
	Memory modules	A	3RK3931-0AA00	1	1 unit	42C
3RK3931-0AA00	For backing up the complete parameterization of the 3SK2 safety system without a PC/PG through the system interface					
Accessories for enclosures						
	Sealing covers	A	3ZY1321-1AA00	1	5 units	41L
	<ul style="list-style-type: none"> • 17.5 mm (for 3SK1120 and 3SK1220) 	A	3ZY1321-2AA00	1	5 units	41L
	<ul style="list-style-type: none"> • 22.5 mm (for all 3SK1 devices except 3SK1120 and 3SK1220) 					
	Push-in lugs	A	3ZY1311-0AA00	1	10 units	41L
3ZY1311-0AA00	For wall mounting					
	Coding pins	A	3ZY1440-1AA00	1	12 units	41L
3ZY1440-0AA00	For removable terminals of SIRIUS devices in the industrial standard mounting rail enclosure. They enable the mechanical coding of terminals, see Manual "3SK1 Safety Relays", https://support.industry.siemens.com/cs/ww/en/view/67585885					

Version	DT	Article No.	Price per PU	PU (UNIT, SET, M)	PS*	PG
Blank labels						
 <p>IC01_00181</p> <p>3RT2900-1SB20</p>	D	3RT2900-1SB20		100 340 units		41B
Tools for opening spring-type terminals						
 <p>3RA2908-1A</p>	A	Spring-type terminals  3RA2908-1A		1 1 unit		41B
Software for 3SK2						
 <p>3ZS1316-.C.10-0Y.5</p>		SIRIUS Safety ES NEW For software for configuring, commissioning, operating and diagnosing of 3SK2 and 3RK3, see page 13/155 .				

Code conversion table

The table below lists the existing 3TK28 order numbers with the corresponding 3SK1 order numbers.

Order number 3TK28 basic units	Order number 3SK1 Standard basic units	Order number 3SK1 Advanced basic units	Order number 3TK28 basic units	Order number 3SK1 Standard basic units	Order number 3SK1 Advanced basic units
3TK28 20			3TK28 28		
3TK28 20-1AJ20	3SK1 111-1AW20	3SK1 121-1AB40 + 3SK1 230-1AW20	3TK28 28-1AB20	--	--
3TK28 20-1AL20	3SK1 111-1AW20	3SK1 121-1AB40 + 3SK1 230-1AW20	3TK28 28-1AB21	--	--
3TK28 20-1CB30	3SK1 111-1AB30	3SK1 121-1AB40	3TK28 28-1AJ20	--	3SK1 121-1CB42 + 3SK1 230-1AW20
3TK28 20-2AJ20	3SK1 111-2AW20	3SK1 121-2AB40 + 3SK1 230-2AW20	3TK28 28-1AL20	--	3SK1 121-1CB41 + 3SK1 230-1AW20
3TK28 20-2AL20	3SK1 111-2AW20	3SK1 121-2AB40 + 3SK1 230-2AW20	3TK28 28-1AL21	--	3SK1 121-1CB42 + 3SK1 230-1AW20
3TK28 20-2CB30	3SK1 111-2AB30	3SK1 121-2AB40	3TK28 28-1BB40	--	3SK1 121-1CB41 + 3SK1 230-1AW20
3TK28 21			3TK28 28-1BB41	--	3SK1 121-1CB42
3TK28 21-1CB30	3SK1 111-1AB30	3SK1 121-1AB40	3TK28 28-2AB20	--	--
3TK28 21-2CB30	3SK1 111-2AB30	3SK1 121-2AB40	3TK28 28-2AB21	--	--
3TK28 22			3TK28 28-2AJ20	--	3SK1 121-2CB42 + 3SK1 230-2AW20
3TK28 22-1CB30	3SK1 111-1AB30	3SK1 121-1AB40	3TK28 28-2AJ21	--	3SK1 121-2CB41 + 3SK1 230-2AW20
3TK28 22-2CB30	3SK1 111-2AB30	3SK1 121-2AB40	3TK28 28-2AL20	--	3SK1 121-2CB42 + 3SK1 230-2AW20
3TK28 23			3TK28 28-2AL21	--	3SK1 121-2CB41 + 3SK1 230-2AW20
3TK28 23-1CB30	3SK1 111-1AB30	3SK1 121-1AB40	3TK28 28-2BB40	--	3SK1 121-2CB42
3TK28 23-2CB30	3SK1 111-2AB30	3SK1 121-2AB40	3TK28 30		
3TK28 24			3TK28 30-1AJ20	3SK1 211-1BW20	3SK1 211-1BB40
3TK28 24-1AJ20	3SK1 111-1AW20	3SK1 121-1AB40 + 3SK1 230-1AW20	3TK28 30-1AL20	3SK1 211-1BW20	3SK1 211-1BB40
3TK28 24-1AL20	3SK1 111-1AW20	3SK1 121-1AB40 + 3SK1 230-1AW20	3TK28 30-1CB30	3SK1 211-1BB40	3SK1 211-1BB40
3TK28 24-1BB40	3SK1 111-1AB30	3SK1 121-1AB40	3TK28 30-2AJ20	3SK1 211-2BW20	3SK1 211-2BB40
3TK28 24-1CB30	3SK1 111-1AB30	3SK1 121-1AB40	3TK28 30-2AL20	3SK1 211-2BW20	3SK1 211-2BB40
3TK28 24-2AJ20	3SK1 111-2AW20	3SK1 121-2AB40 + 3SK1 230-2AW20	3TK28 30-2CB30	3SK1 211-2BB40	3SK1 211-2BB40
3TK28 24-2AL20	3SK1 111-2AW20	3SK1 121-2AB40 + 3SK1 230-2AW20	3TK28 34		
3TK28 24-2BB40	3SK1 111-2AB30	3SK1 121-2AB40	3TK28 34-1AB20	--	--
3TK28 24-2CB30	3SK1 111-2AB30	3SK1 121-2AB40	3TK28 34-1AJ20	--	3SK1 121-1AB40 + 3SK1 230-1AW20
3TK28 25			3TK28 34-1AL20	--	3SK1 121-1AB40 + 3SK1 230-1AW20
3TK28 25-1AB20	3SK1 111-1AW20	3SK1 121-1AB40 + 3SK1 230-1AW20	3TK28 34-1BB40	--	3SK1 121-1AB40
3TK28 25-1AJ20	3SK1 111-1AW20	3SK1 121-1AB40 + 3SK1 230-1AW20	3TK28 34-2AB20	--	--
3TK28 25-1AL20	3SK1 111-1AW20	3SK1 121-1AB40 + 3SK1 230-1AW20	3TK28 34-2AJ20	--	3SK1 121-2AB40 + 3SK1 230-2AW20
3TK28 25-1BB40	3SK1 111-1AB30	3SK1 121-1AB40	3TK28 34-2AL20	--	3SK1 121-2AB40 + 3SK1 230-2AW20
3TK28 25-2AB20	3SK1 111-2AW20	3SK1 121-2AB40 + 3SK1 230-2AW20	3TK28 34-2BB40	--	3SK1 121-2AB40
3TK28 25-2AJ20	3SK1 111-2AW20	3SK1 121-2AB40 + 3SK1 230-2AW20	3TK28 40		
3TK28 25-2AL20	3SK1 111-2AW20	3SK1 121-2AB40 + 3SK1 230-2AW20	3TK28 40-1BB40	3SK1 112-1BB40	3SK1 122-1AB40
3TK28 25-2BB40	3SK1 111-2AB30	3SK1 121-2AB40	3TK28 40-2BB40	3SK1 112-2BB40	3SK1 122-2AB40
3TK28 27			3TK28 41		
3TK28 27-1AB20	--	--	3TK28 41-1BB40	3SK1 112-1BB40	3SK1 122-1AB40
3TK28 27-1AB21	--	--	3TK28 41-2BB40	3SK1 112-2BB40	3SK1 122-2AB40
3TK28 27-1AJ20	--	3SK1 121-1CB42 + 3SK1 230-1AW20	3TK28 42		
3TK28 27-1AJ21	--	3SK1 121-1CB41 + 3SK1 230-1AW20	3TK28 42-1BB41	--	3SK1 122-1CB41
3TK28 27-1AL20	--	3SK1 121-1CB42 + 3SK1 230-1AW20	3TK28 42-1BB42	--	3SK1 122-1CB42
3TK28 27-1AL21	--	3SK1 121-1CB41 + 3SK1 230-1AW20	3TK28 42-1BB44	--	3SK1 122-1CB44
3TK28 27-1BB40	--	3SK1 121-1CB42	3TK28 42-2BB41	--	3SK1 122-2CB41
3TK28 27-1BB41	--	3SK1 121-1CB41	3TK28 42-2BB42	--	3SK1 122-2CB42
3TK28 27-2AB20	--	--	3TK28 42-2BB44	--	3SK1 122-2CB44
3TK28 27-2AB21	--	3SK1 121-2CB42 + 3SK1 230-2AW20	3TK28 50		
3TK28 27-2AB20	--	3SK1 121-2CB41 + 3SK1 230-2AW20	3TK28 50-1AJ20	3SK1 111-1AW20 + 3SK1 213-1AJ20	3SK1 120-1AB40 + 3SK1 213-1AB40
3TK28 27-2AJ21	--	3SK1 121-2CB41 + 3SK1 230-2AW20	3TK28 50-1AL20	3SK1 111-1AW20 + 3SK1 213-1AL20	3SK1 120-1AB40 + 3SK1 213-1AB40
3TK28 27-2AL20	--	3SK1 121-2CB42 + 3SK1 230-2AW20	3TK28 50-1BB40	3SK1 111-1AB30 + 3SK1 213-1AB40	3SK1 120-1AB40 + 3SK1 213-1AB40
3TK28 27-2AL21	--	3SK1 121-2CB41 + 3SK1 230-2AW20	3TK28 50-2AJ20	3SK1 111-2AW20 + 3SK1 213-2AJ20	3SK1 120-2AB40 + 3SK1 213-2AB40
3TK28 27-2BB40	--	3SK1 121-2CB42	3TK28 50-2AL20	3SK1 111-2AW20 + 3SK1 213-2AL20	3SK1 120-2AB40 + 3SK1 213-2AB40
3TK28 27-2BB41	--	3SK1 121-2CB41	3TK28 50-2BB40	3SK1 111-2AB30 + 3SK1 213-2AB40	3SK1 120-2AB40 + 3SK1 213-2AB40

Order number 3TK28 basic units	Order number 3SK1 Standard basic units	Order number 3SK1 Advanced basic units
3TK28 51		
3TK28 51-1AJ20	3SK1 111-1AW20 + 3SK1 213-1AJ20	3SK1 120-1AB40 + 3SK1 213-1AB40
3TK28 51-1AL20	3SK1 111-1AW20 + 3SK1 213-1AL20	3SK1 120-1AB40 + 3SK1 213-1AB40
3TK28 51-1BB40	3SK1 111-1AB30 + 3SK1 213-1AB40	3SK1 120-1AB40 + 3SK1 213-1AB40
3TK28 51-2AJ20	3SK1 111-2AW20 + 3SK1 213-2AJ20	3SK1 120-2AB40 + 3SK1 213-2AB40
3TK28 51-2AL20	3SK1 111-2AW20 + 3SK1 213-2AL20	3SK1 120-2AB40 + 3SK1 213-2AB40
3TK28 51-2BB40	3SK1 111-2AB30 + 3SK1 213-2AB40	3SK1 120-2AB40 + 3SK1 213-2AB40
3TK28 52		
3TK28 52-1AL20	3SK1 111-1AW20 + 3SK1 213-1AL20	3SK1 120-1AB40 + 3SK1 213-1AB40
3TK28 52-1BB40	3SK1 111-1AB30 + 3SK1 213-1AB40	3SK1 120-1AB40 + 3SK1 213-1AB40
3TK28 52-2AL20	3SK1 111-2AW20 + 3SK1 213-2AL20	3SK1 120-2AB40 + 3SK1 213-2AB40
3TK28 52-2BB40	3SK1 111-2AB30 + 3SK1 213-2AB40	3SK1 120-2AB40 + 3SK1 213-2AB40

Order number 3TK28 basic units	Order number 3SK1 Standard basic units	Order number 3SK1 Advanced basic units
3TK28 53		
3TK28 53-1BB40	3SK1 111-1AB30 + 3SK1 213-1AB40	3SK1 120-1AB40 + 3SK1 213-1AB40
3TK28 53-2BB40	3SK1 111-2AB30 + 3SK1 213-2AB40	3SK1 120-2AB40 + 3SK1 213-2AB40
3TK28 56		
3TK28 56-1BB40	3SK1 213-1AB40	3SK1 213-1AB40
3TK28 56-2BB40	3SK1 213-2AB40	3SK1 213-2AB40
3TK28 57		
3TK28 57-1BB41	--	3SK1 213-1AB40 (delay as for basic unit)
3TK28 57-1BB42	--	3SK1 213-1AB40 (delay as for basic unit)
3TK28 57-1BB44	--	3SK1 213-1AB40 (delay as for basic unit)
3TK28 57-2BB41	--	3SK1 213-2AB40 (delay as for basic unit)
3TK28 57-2BB42	--	3SK1 213-2AB40 (delay as for basic unit)
3TK28 57-2BB44	--	3SK1 213-2AB40 (delay as for basic unit)

SIRIUS 3TK28

With relay enabling circuits

Overview



SIRIUS 3TK282. safety relay

Safety relays with relay enabling circuits – Safety with floating contacts

SIRIUS safety relays with relay enabling circuits are not only extremely space-saving thanks to their compact design, they also offer extra safety with positively driven NO and feedback contacts in pairs. If one of the contact welds, the other assumes the disconnection of the circuit. A positively driven feedback contact (NC) then performs the fault detection of the faulty NO contact.

3SK121. expansion units are available to increase the number of enabling circuits, [see page 13/130](#).

3TK2826 safety relays

The 3TK2826 is a parameterizable safety relay. It is used as an evaluation unit for typical safety chains (identify, evaluate, realize). A number of functions can be set using the DIP switches on the front. The 3TK2826 is therefore universally applicable.

Safety sensors (e.g. an EMERGENCY-STOP device) are connected at the input side while contactors or valves for disconnecting the "hazardous function" are connected at the output side.

The 3TK2826 performs the monitoring of the sensor and actuator functions as well as the safe disconnection of the outputs (enabling circuits).

3TK2826 with DIP switch:

DIP switch No.	ON	OFF	Schematic
1	Switching mat operation	Without crossover monitoring	
2	NC/NC evaluation	NC/NO evaluation	
3	1 x 2-channel	2 x 1-channel	
4	Debounce time for sensor inputs ≈ 10 ms	Debounce time for sensor inputs ≈ 50 ms	
5	Sensor input Monitored start	Sensor input Autostart	
6	Cascading input Monitored start	Cascading input Autostart	
7	Without start test	With start test	
8	Without automatic start after mains failure	Automatic start after mains failure (not permitted in connection with a start test)	

Benefits

- Compact design
- Floating safe outputs
- Can be used up to an ambient temperature of max. 70 °C
- Connection for all common sensor types
- Many functions available in just one device
- Status displays
- Extended diagnostic capabilities
- Approvals (EN ISO 13849-1, IEC 61508, UL/CSA)
- Reporting of trip faults in the actuator circuit
- Floating outputs
- Wide-range device
- Sensor condition saved in the event of voltage failure

Technical specifications

Type	Basic units			
	3TK2826 24 V DC	Wide voltage range	24 V DC t_v	Wide voltage range t_v
Sensors				
• Inputs	1	1	1	1
• Electronic	✓	--	✓	--
• With contacts	✓	✓	✓	✓
• Magnetically operated switch (Reed contacts)	✓	✓	✓	✓
Safety mats	✓	✓	✓	✓
Start				
• Auto	✓	✓	✓	✓
• Monitored	✓	✓	✓	✓
Cascading input 24 V DC	✓	✓	✓	✓
Key-operated switch	--	--	--	--
Enabling circuit, floating				
• Stop category 0	4 NO	4 NO	2 NO	2 NO
• Stop category 1	--	--	2 NO	2 NO
Enabling circuit, electronic				
• Stop category 0	--	--	--	--
• Stop category 1	--	--	--	--
Signaling outputs				
• Floating	1 NC	1 NO + 1 NC	2 NC	1 NO + 2 NC
• Electronic	2	--	2	--
Standards	IEC 60204-1, EN ISO 12100, EN ISO 13849-1, IEC 61508	IEC 60204-1, EN ISO 12100, EN ISO 13849-1, IEC 61508	IEC 60204-1, EN ISO 12100, EN ISO 13849-1, IEC 61508	IEC 60204-1, EN ISO 12100, EN ISO 13849-1, IEC 61508
Test certificates	TÜV, UL, CSA	TÜV, UL, CSA	TÜV, UL, CSA	TÜV, UL, CSA
SIL level max. according to IEC 61508	3	3	3	3
Performance level PL according to ISO 13849-1	e	e	e	e
Probability of a dangerous failure per hour (PFH_d)	7.8×10^{-9} 1/h	7.8×10^{-9} 1/h	7.8×10^{-9} 1/h	7.8×10^{-9} 1/h
Rated control supply voltage				
• 24 V DC	✓	--	✓	--
• 24 ... 240 V AC/DC	--	✓	--	✓
✓ Available				
-- Not available				

SIRIUS 3TK28

With relay enabling circuits

Selection and ordering data

PU (UNIT, SET, M) = 1
 PS* = 1 unit
 PG = 41L



3TK2826-1BB40



3TK2826-2BB40

Rated control supply voltage U_s	Start	OFF-delay t_v	DT	Screw terminals 	DT	Spring-type terminals 	
V		s		Article No.	Price per PU	Article No.	Price per PU

Basic units

With floating enabling circuits

3TK2826

Rated control supply voltage U_s	Start	OFF-delay t_v	DT	Screw terminals	DT	Spring-type terminals
• 24 DC	Auto/monitored	--	A	3TK2826-1BB40	A	3TK2826-2BB40
• 24 ... 240 AC/DC	Auto/monitored	--	A	3TK2826-1CW30	C	3TK2826-2CW30

With time-delayed enabling circuits

3TK2826 t_v

Rated control supply voltage U_s	Start	OFF-delay t_v	DT	Screw terminals	DT	Spring-type terminals
• 24 DC	Auto/monitored	0.05 ... 3	C	3TK2826-1BB41	C	3TK2826-2BB41
• 24 ... 240 AC/DC	Auto/monitored	0.05 ... 3	C	3TK2826-1CW31	C	3TK2826-2CW31
• 24 DC	Auto/monitored	0.5 ... 30	A	3TK2826-1BB42	C	3TK2826-2BB42
• 24 ... 240 AC/DC	Auto/monitored	0.5 ... 30	C	3TK2826-1CW32	C	3TK2826-2CW32
• 24 DC	Auto/monitored	5 ... 300	C	3TK2826-1BB44	C	3TK2826-2BB44
• 24 ... 240 AC/DC	Auto/monitored	5 ... 300	C	3TK2826-1CW34	C	3TK2826-2CW34

Overview

SIRIUS 3TK284. safety relay

Fast, safe and wear-free switching

Evaluation units with electronic components are becoming increasingly established in safety applications, as a considerably higher number of starting operations and electrical life of the devices is achieved with permanent functional checks and consistently wear-free operation. The compact and light devices also permit series connection or normal operational switching, e.g. through a PLC.

If several enabling circuits or floating enabling circuits are required in one application, the devices can be expanded with expansion units from the 3SK121. series, [see page 13/130](#).

3TK2845 multi-function units

Up to now, standard combinations of safety applications such as EMERGENCY-STOP and protective door monitoring were possible only by using several individual safety relays. 3TK2845 combines several functions in a single unit. Two electronic and two relay enabling circuits ensure safe disconnection – in just a few actions, quickly and cheaply.

Benefits

- Permanent function checking
- No wear because switched electronically
- High switching frequency
- Long electrical endurance
- Evaluation of electronic sensors
- Sensor lead up to max. 2 000 m
- Cascading possible
- Insensitive to vibrations and dirt
- Compact design, low weight
- Approved for the world market
- Two sensor inputs (e.g. EMERGENCY-STOP, protective door)
- Also suitable for protective door tumblers and OK button
- Two electronic and two relay enabling circuits

SIRIUS 3TK28

With electronic enabling circuits

Technical specifications

Type	Multi-function units 3TK2845							
	"Automatic and monitored start"	"Automatic and monitored start" <i>t_v</i>	"Monitored start"	"Monitored start" <i>t_v</i>	OK button	OK button <i>t_v</i>	"Spring-actuated tumbler" <i>t_v</i>	"Solenoid tumbler" <i>t_v</i>
Sensors								
• Inputs	2	2	2	2	2	2	2	2
• Electronic	✓	✓	✓	✓	✓	✓	✓	✓
• With contacts	✓	✓	✓	✓	✓	✓	✓	✓
• Magnetically operated switch (Reed contacts)	✓	✓	✓	✓	✓	✓	✓	✓
Safety mats	✓	✓	✓	✓	--	--	--	--
Start								
• Auto	1	1	--	--	1	1	--	--
• Monitored	1	1	2	2	1	1	2	2
Cascading input 24 V DC	✓	✓	✓	✓	✓	✓	✓	✓
Key-operated switch	✓	✓	✓	✓	✓	✓	✓	✓
Enabling circuit, floating								
• Stop category 0	2 NO	1 NO	2 NO	1 NO	2 NO	1 NO	1 NO	1 NO
• Stop category 1	--	1 NO	--	1 NO	--	1 NO	1 NO	1 NO
Enabling circuit, electronic								
• Stop category 0	2	1	2	1	2	1	1	1
• Stop category 1	--	1	--	1	--	1	1	1
Signaling outputs								
• Floating	--	--	--	--	--	--	--	--
• Electronic	1	1	1	1	1	1	1	1
Standards	IEC 60204-1, EN ISO 12100, EN ISO 13849-1, IEC 61508	IEC 60204-1, EN ISO 12100, EN ISO 13849-1, IEC 61508	IEC 60204-1, EN ISO 12100, EN ISO 13849-1, IEC 61508	IEC 60204-1, EN ISO 12100, EN ISO 13849-1, IEC 61508	IEC 60204-1, EN ISO 12100, EN ISO 13849-1, IEC 61508	IEC 60204-1, EN ISO 12100, EN ISO 13849-1, IEC 61508	IEC 60204-1, EN ISO 12100, EN ISO 13849-1, IEC 61508	IEC 60204-1, EN ISO 12100, EN ISO 13849-1, IEC 61508
Test certificates								
SIL level max. according to IEC 61508	3	3	3	3	3	3	3	3
Performance level PL according to EN ISO 13849-1	e	e	e	e	e	e	e	e
Probability of a dangerous failure per hour (PFH_d)	6.9 x 10 ⁻⁹ 1/h	6.9 x 10 ⁻⁹ 1/h	6.9 x 10 ⁻⁹ 1/h	6.9 x 10 ⁻⁹ 1/h	6.9 x 10 ⁻⁹ 1/h	6.9 x 10 ⁻⁹ 1/h	6.9 x 10 ⁻⁹ 1/h	6.9 x 10 ⁻⁹ 1/h
Rated control supply voltage 24 V DC	✓	✓	✓	✓	✓	✓	✓	✓

✓ Available
-- Not available

SIRIUS 3TK28

With electronic enabling circuits

Selection and ordering data

PU (UNIT, SET, M) = 1
 PS* = 1 unit
 PG = 41L



3TK2845-1HB40



3TK2845-1HB41



3TK2845-2DB40

Rated control supply voltage U_s	Start Automatic/monitored	OFF-delay t_v	DT	Screw terminals	DT	Spring-type terminals	
V		s		Article No.	Price per PU	Article No.	Price per PU
Multi-function units							
3TK2845 "Automatic and monitored start"							
• 24 DC	1/1	--	C	3TK2845-1HB40	C	3TK2845-2HB40	
3TK2845 t_v "Automatic and monitored start"							
• 24 DC	1/1	0.05 ... 3	C	3TK2845-1HB41	C	3TK2845-2HB41	
	1/1	0.5 ... 30	C	3TK2845-1HB42	C	3TK2845-2HB42	
	1/1	5 ... 300	C	3TK2845-1HB44	C	3TK2845-2HB44	
3TK2845 "Monitored start"							
• 24 DC	--/2	--	C	3TK2845-1DB40	C	3TK2845-2DB40	
3TK2845 t_v "Monitored start"							
• 24 DC	--/2	0.05 ... 3	C	3TK2845-1DB41	C	3TK2845-2DB41	
	--/2	0.5 ... 30	C	3TK2845-1DB42	C	3TK2845-2DB42	
	--/2	5 ... 300	C	3TK2845-1DB44	C	3TK2845-2DB44	
3TK2845 "OK button"							
• 24 DC	1/1	--	C	3TK2845-1EB40	C	3TK2845-2EB40	
3TK2845 t_v "OK button"							
• 24 DC	1/1	0.05 ... 3	C	3TK2845-1EB41	C	3TK2845-2EB41	
	1/1	0.5 ... 30	C	3TK2845-1EB42	C	3TK2845-2EB42	
	1/1	5 ... 300	C	3TK2845-1EB44	C	3TK2845-2EB44	
3TK2845 t_v "Spring-actuated tumbler"							
• 24 DC	--/2	0.05 ... 3	C	3TK2845-1FB41	C	3TK2845-2FB41	
	--/2	0.5 ... 30	C	3TK2845-1FB42	C	3TK2845-2FB42	
	--/2	5 ... 300	C	3TK2845-1FB44	C	3TK2845-2FB44	
3TK2845 t_v "Solenoid tumbler"							
• 24 DC	--/2	0.05 ... 3	C	3TK2845-1GB41	C	3TK2845-2GB41	
	--/2	0.5 ... 30	C	3TK2845-1GB42	C	3TK2845-2GB42	
	--/2	5 ... 300	C	3TK2845-1GB44	C	3TK2845-2GB44	

Note:

For additional 3TK28 safety relays, see Catalog Add-On IC 10 AO · 2016.

SIRIUS 3TK28

With special functions

Overview



SIRIUS 3TK2810 safety relays

3TK2810-0 standstill monitors

The standstill monitor increases safety in hazardous areas. Without a sensor, it detects motor stoppage from the residual magnetization of the rotating motor. When an adjustable threshold value is undershot, it uses its outputs to allow access to hazardous areas, for example by unlocking a protective door.

3TK2810-1 speed monitors

The speed monitor combines two safety functions in one unit by continuously monitoring machines and plants for standstill and speed.

Through simple parameterization and permanent diagnosis on the display, faults can be quickly remedied at any time – often before they cause plant downtimes.

In addition to standstill and speed monitoring, the unit also features an integrated monitoring function of a protective door with spring-type interlocking. Therefore, an additional evaluation unit is not needed.

Benefits

3TK2810-0 standstill monitors

- No additional sensors required
- Signaling of faults with diagnostics display
- Standstill time can be set
- Unit can be used with frequency converters

3TK2810-1 speed monitors

- Menu-prompted, easy parameterization
- Direct diagnosis on the display means shorter downtimes thanks to early fault detection
- Integrated protective door monitoring means greater safety because access to the plant is allowed only in the safe state
- Suitable for all standard sensors, i.e. high flexibility

Technical specifications

Type	Standstill monitors 3TK2810-0	Speed monitors 3TK2810-1
Sensors		
• Inputs	3	4
• Electronic	--	3
• With contacts	--	1
• Without sensors (measuring inputs)	3	--
• Magnetically operated switch (Reed contacts)	--	--
Safety mats	--	--
Start		
• Auto	✓	✓
• Monitored	--	✓
Cascading input 24 V DC	--	--
Key-operated switch	--	--
Enabling circuit, floating		
• Stop category 0	3 NO + 1 NC	2
• Stop category 1	--	--
Enabling circuit, electronic		
• Stop category 0	--	--
• Stop category 1	--	--

✓ Available
-- Not available

Type	Standstill monitors 3TK2810-0	Speed monitors 3TK2810-1
Signaling outputs		
• Floating	1 CO	--
• Electronic	2	2
Standards	IEC 60204-1, EN ISO 12100, EN ISO 13849-1, IEC 61508	IEC 60947-5-1, EN ISO 13849-1, IEC 60204-1, IEC 61508
Test certificates	TÜV, UL, CSA	TÜV, UL, CSA
SIL level max. according to IEC 61508	3	3
Performance level PL according to ISO 13849-1	e	e
Probability of a dangerous failure per hour (PFH_d)	1.5 x 10 ⁻⁸ 1/h	3.38 x 10 ⁻⁹ 1/h
Rated control supply voltage		
• 24 V DC	✓	✓
• 230 V AC	✓	--
• 400 V AC	✓	--
• 120 ... 240 V AC/DC	--	✓

SIRIUS 3TK28

With special functions

Selection and ordering data

PU (UNIT, SET, M) = 1
 PS* = 1 unit
 PG = 41L



3TK2810-0BA01







3TK2810-0GA02

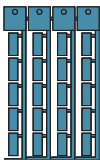

3TK2810-1BA41

Rated control supply voltage U_s	Time	DT	Screw terminals	DT	Spring-type terminals	
V	s		Article No.	Price per PU	Article No.	Price per PU
Standstill monitors						
3TK2810-0						
Standstill time						
• 24 DC	0.2 ... 6	B	3TK2810-0BA01		C	3TK2810-0BA02
• 230 AC	0.2 ... 6	C	3TK2810-0GA01		C	3TK2810-0GA02
• 400 AC	0.2 ... 6	C	3TK2810-0JA01		C	3TK2810-0JA02
Speed monitors						
Release delay time						
3TK2810-1 for NPN/PNP proximity switches and encoders						
• 24 DC	0 ... 999	A	3TK2810-1BA41		A	3TK2810-1BA42
• 120 ... 240 AC/DC	0 ... 999	B	3TK2810-1KA41		B	3TK2810-1KA42
3TK2810-1 for NAMUR proximity switches and encoders						
• 24 DC	0 ... 999	B	3TK2810-1BA41-0AA0		B	3TK2810-1BA42-0AA0
• 120 ... 240 AC/DC	0 ... 999	B	3TK2810-1KA41-0AA0		B	3TK2810-1KA42-0AA0

Selection and ordering data

Use	Version	DT	Article No.	Price per PU	PU (UNIT, SET, M)	PS*	PG
Blank labels							
 3RT1900-1SB20	For 3TK28	Unit labeling plates For SIRIUS devices 20 mm x 7 mm, pastel turquoise	D	3RT1900-1SB20	100	340 units	41B
	For 3TK28	Adhesive labels For SIRIUS devices • 19 mm x 6 mm, pastel turquoise • 19 mm x 6 mm, zinc yellow	C	3RT1900-1SB60	100	3 060 units	41B
			C	3RT1900-1SD60	100	3 060 units	41B
Push-in lugs and covers							
 3RP1903	For 3TK28	Push-in lugs For screw fixing, 2 units are required for each device	B	3RP1903	1	10 units	41H
	For 3TK2826	Sealable covers For securing against unauthorized adjustment of setting knobs	A	3TK2826-0DA00-0HA0	1	5 units	41L
	For 3TK28	Sealing foil For securing against unauthorized adjustment of setting knobs	▶	3TK2820-0AA00	1	1 unit	41L
Adapters and connection cables for speed monitors							
 3TK2810-1A 3TK2810-1B 3TK2810-0A	For 3TK2810-1	Adapters for connecting encoders of type Siemens/Heidenhain • 15-pole • 25-pole	A	3TK2810-1A	1	1 unit	41L
			A	3TK2810-1B	1	1 unit	41L
	For 3TK2810-1	Connection cables For connecting the speed monitor to the 3TK2810-1A or 3TK2810-1B adapter	C	3TK2810-0A	1	1 unit	41L
Tools for opening spring-type terminals							
 3RA29 08-1A	For auxiliary circuit connections	Screwdrivers For all SIRIUS devices with spring-type terminals; 3.0 mm x 0.5 mm, length approx. 200 mm, titanium gray/black, partially insulated	A	Spring-type terminals  3RA2908-1A	1	1 unit	41B

Overview

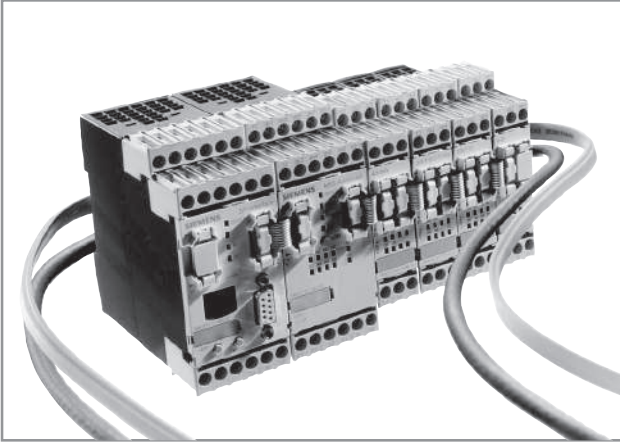

SIRIUS 3RK3 Modular Safety System

The 3RK3 Modular Safety System (MSS) is a freely parameterizable modular safety relay. Depending on the external circuit version, safety-oriented applications up to Performance Level e according to EN ISO 13849-1 or SIL 3 according to IEC 62061 can be realized.

The modular safety relay enables the interconnection of several safety applications.

The comprehensive error and status diagnostics provides the possibility of finding errors in the system and localizing signals from sensors. Plant downtimes can be reduced as the result.

The MSS comprises the following system components:

- Central units
- Expansion modules
- Interface modules
- Diagnostics modules
- Parameterization software
- Accessories

Central unitsMSS Basic

The 3RK3 Basic central unit is used wherever more than three safety functions need to be evaluated and the wiring parameterization of safety relays would involve great cost and effort. It reads in inputs, controls outputs and communicates through an interface module with higher-level control systems. An application's entire safety program is processed in the central unit. The 3RK3 Basic central unit is the lowest expansion level and fully functional on its own, without the optional expansion modules.

MSS Advanced

The 3RK3 Advanced central unit is the consistent expansion of the Basic central unit with the functionality of an AS-i safety monitor. In addition to having a larger volume of project data and scope of functionality, it can be integrated into AS-Interface and therefore makes use of the many different possibilities offered by this bus system. The function can be optionally activated in the central unit.

The service-proven insulation piercing method of AS-Interface enables not only the distributed expansion of the project data volume using safe AS-i outputs, safe AS-i sensors and other MSS Advanced or safety monitors (F cross traffic) but also a highly flexible adaptation of the application, e.g. very fast connection of AS-i outputs, LV HRC command devices, position switches with and without interlocking, or light arrays.

Safety-oriented disconnection using MSS or by distributed means using safe AS-i outputs and the formation of switch-off groups can be implemented very easily. The same applies for any subsequent modifications. They are now easily possible by re-addressing, i.e. re-wiring is no longer necessary.

The AS-i bus is connected directly to the central unit.

MSS ASIsafe

The MSS ASIsafe basic and MSS ASIsafe extended central units are a logical development of the AS-i safety monitors based on the 3RK3 Modular Safety System.

Like MSS Advanced, MSS ASIsafe detects – in a comparable way to the safety monitors – safe sensor technology on the AS-i bus and switches actuators off in a safety-oriented manner via a configurable safety logic. It stands out by virtue of its greater project data volume, wider range of functions and the possibility of increasing the the integrated I/O project data volume by means of expansion modules from the MSS system family. In this case the range of functions, such as the number and type of the logic elements that can be interconnected, is equivalent to that of MSS Advanced.

Expansion modules

With the optional expansion modules, both safety-related and standard, the system is flexibly adapted to the required safety applications.

Interface modules

The DP interface module is used for transferring diagnostics data and device status data to a higher-level PROFIBUS network, e.g. for purposes of visualization via HMI. When using the Basic central unit, 32-bit cyclic data can be exchanged with the control system. If an Advanced/ASIsafe central unit is used, the number is doubled to 64-bit cycle data. The acyclic calling of diagnostics data is possible with both central units.

Diagnostics modules

Faults like a cross-circuit, for instance, are displayed directly on the diagnostic display. The fault is diagnosed directly in plain text by the detailed alarm message. The device is fully functional upon delivery. No programming is required.

Parameterization software

Using the SIRIUS Safety ES graphical parameterization tool it is very easy to create the safety functions as well as their logical links on the PC. You can define disconnection ranges, ON-delays, OFF-delays and other dependent factors, for example.

SIRIUS Safety ES also offers comprehensive functions for diagnostics and commissioning. Documentation of the MSS hardware layout and the parameterized logic is drawn up automatically.

SIRIUS 3RK3 Modular Safety System

General data

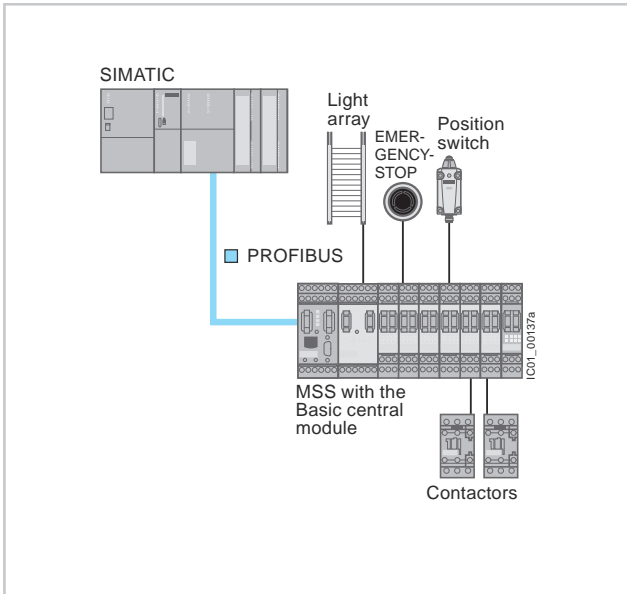

System configuration with the Basic central unit

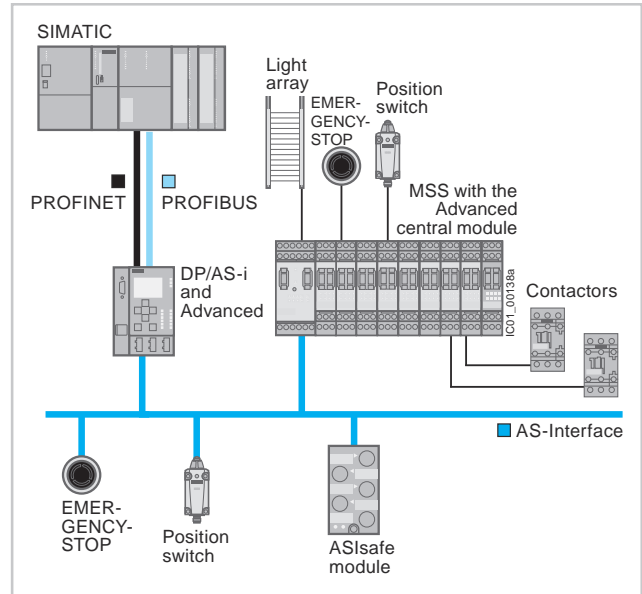

System configuration with the Advanced central unit

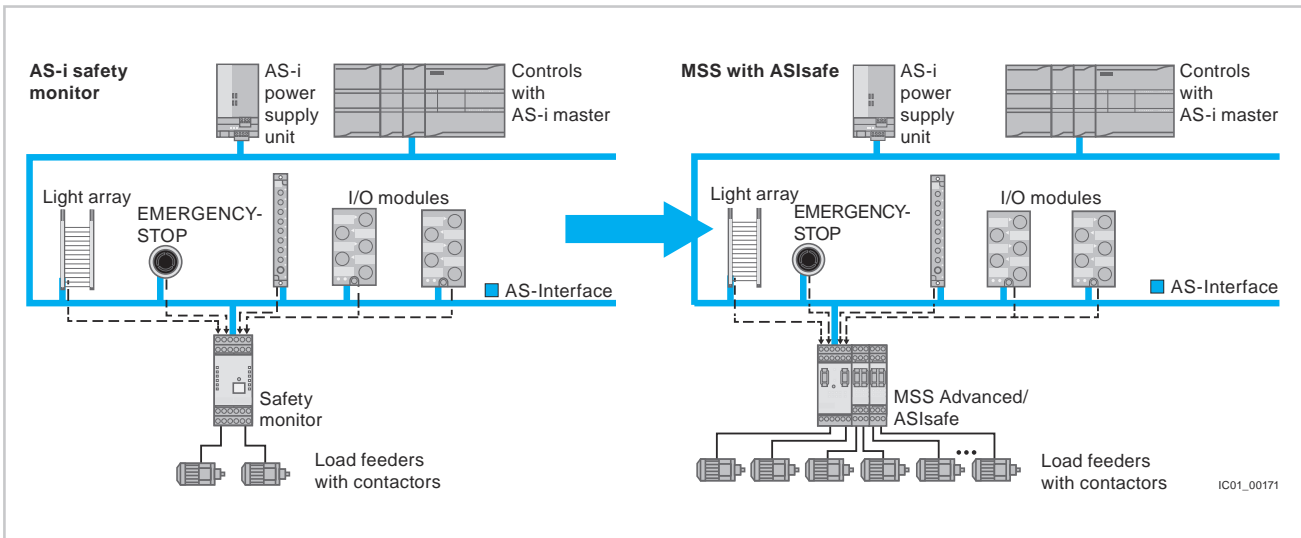

Further development of the system design: from the safety monitor to MSS Advanced/MSS ASIsafe

SIRIUS 3RK3 Modular Safety System

General data

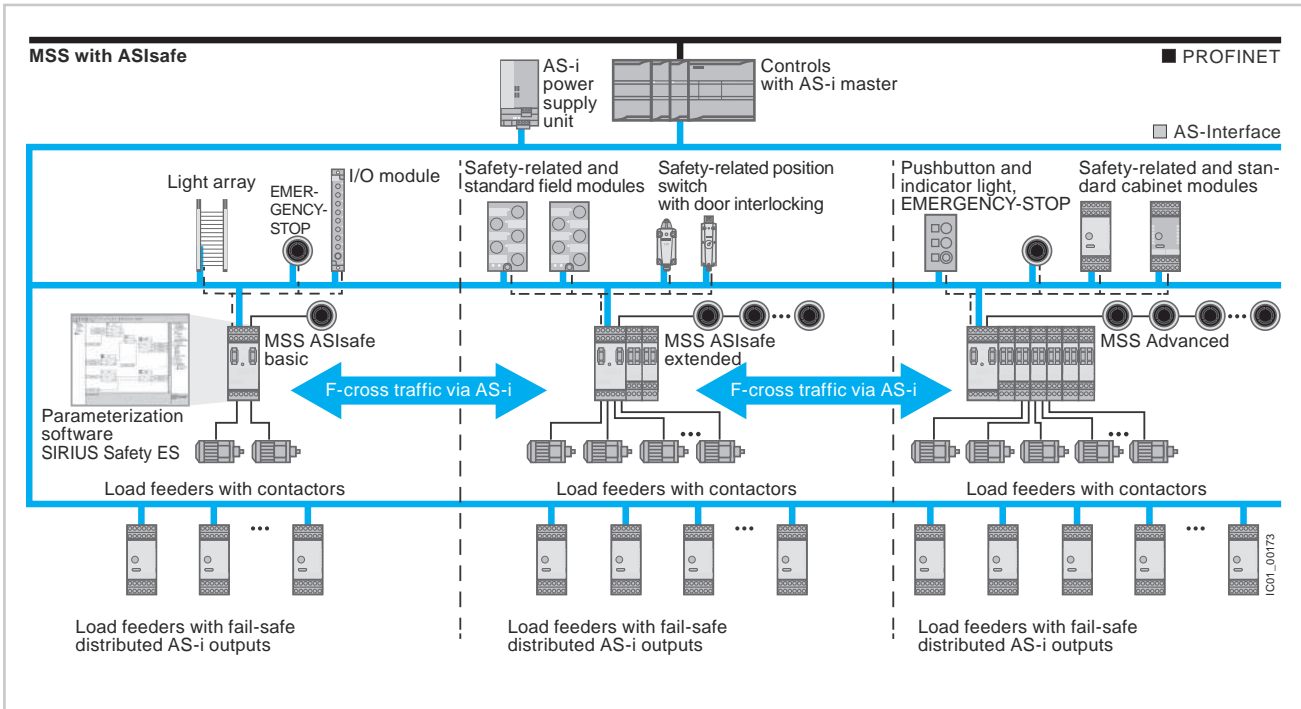

MSS with ASIsafe

Order No. scheme

Digit of the Order No.	1st - 4th	5th	6th	7th	8th	9th	10th	11th	12th	
	□□□□	□	□	□	-	□	□	□	□	
Modular safety system	3 R K 3									
Device type	□									
Device type	□ □									
Connection type	□									
Communications	□ □ □									
Version	□									
Example	3 R K 3	1	1	1	-	1	A	A	1	0

Note:

The Order No. scheme is presented here merely for information purposes and for better understanding of the logic behind the order numbers.

For your orders, please use the order numbers quoted in the catalog in the selection and ordering data.

Benefits

- More functionality and flexibility through freely configurable safety logic
- Suitable for all safety applications thanks to compliance with the highest safety standards in factory automation
- For use all over the world through compliance with all product-relevant, globally established certifications
- Modular hardware configuration
- Parameterization by means of software instead of wiring
- Removable terminals for greater plant availability
- Distributed collection from sensors and disconnection of actuators through AS-Interface
- All SIRIUS Safety ES logic functions are also usable for AS-Interface, e. g. muting, protective door with interlocking
- Up to 12 independent safe switch-off groups on the AS-i bus
- Volume of project data can be greatly increased by means of AS-Interface
- Up to 50 two-channel enabling circuits per system

Communication through PROFIBUS

The 3RK3 Modular Safety System can be connected to PROFIBUS through the DP interface and can exchange data with higher-level control systems.

The MSS supports among other things:

- Baud rates up to 12 Mbit/s
- Automatic baud rate detection
- Cyclic services (DPV0) and acyclic services (DPV1)
- Exchange of 32-bit cyclic data with MSS Basic or 64-bit cyclic data with MSS Advanced/MSS ASIsafe
- Diagnostics using data record invocations

AS-Interface communication

The 3RK3 Modular Safety System can be integrated into AS-Interface with the Advanced and ASIsafe central units.

- MSS can read in up to 31 AS-i sensors
- Up to 12 preprocessed signals per MSS can be placed on the AS-i bus, e.g. for F-cross traffic or for disconnecting safe AS-i outputs
- Safe cross-traffic between MSS Advanced and MSS ASIsafe or with other AS-i safety monitors
- Standard signals, e.g. for acknowledgement, can also be placed on the bus

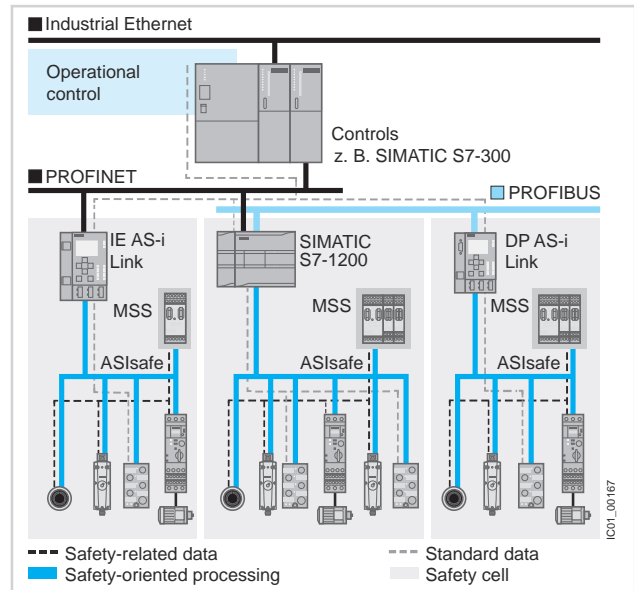

Integration of MSS into AS-Interface as ASIsafe Solution Local

MSS with communication function [see page 13/152 onwards](#).

Accessories [see page 13/154 onwards](#).

For more information on AS-Interface with ASIsafe, [see also Chapter 14 on Industrial Communication](#).

SIRIUS 3RK3 Modular Safety System

Central units

Selection and ordering data

PU (UNIT, SET, M) = 1
 PS* = 1 unit



3RK3 111-1AA10



3RK3 121-1AC00
 3RK3 122-1AC00
 3RK3 131-1AC10

Version	DT	Screw terminals	DT	Spring-type terminals	
		Order No.	Price per PU	Order No.	Price per PU

Central units				
<p>3RK3 Basic</p> <p>Central unit with safety-oriented inputs and outputs</p> <ul style="list-style-type: none"> • 8 non-fail-safe inputs • 1 two-channel relay output • 1 two-channel solid-state output <p>Max. 7 expansion modules can be connected</p> <p><u>Note:</u> Memory module 3RK3 931-0AA00 is included in the scope of supply.</p>	▶	3RK3 111-1AA10	A	3RK3 111-2AA10
<p>3RK3 Advanced</p> <p>Central units for connecting to AS-Interface with safety-oriented inputs and outputs and extended scope of functions</p> <ul style="list-style-type: none"> • 8 non-fail-safe inputs • 1 two-channel relay output • 1 two-channel solid-state output <p>Max. 9 expansion modules can be connected</p> <p><u>Note:</u> Memory module 3RK3 931-0AA00 is included in the scope of supply.</p>	▶	3RK3 131-1AC10	A	3RK3 131-2AC10
<p>3RK3 ASIsafe basic</p> <p>Central units for connecting to AS-Interface with safety-oriented inputs and outputs and extended scope of functions</p> <ul style="list-style-type: none"> • 2 fail-safe inputs • 6 non-fail-safe inputs • 1 two-channel relay output • 1 two-channel solid-state output <p>No expansion modules can be connected</p> <p><u>Note:</u> Memory module 3RK3 931-0AA00 is included in the scope of supply.</p>	A	3RK3 121-1AC00	A	3RK3 121-2AC00
<p>3RK3 ASIsafe extended</p> <p>Central units for connecting to AS-Interface with safety-oriented inputs and outputs and extended scope of functions</p> <ul style="list-style-type: none"> • 4 fail-safe inputs • 4 non-fail-safe inputs • 1 two-channel relay output • 1 two-channel solid-state output <p>Max. 2 expansion modules can be connected</p> <p><u>Note:</u> Memory module 3RK3 931-0AA00 is included in the scope of supply.</p>	A	3RK3 122-1AC00	A	3RK3 122-2AC00

Note:

More information on the Internet at www.siemens.com/sirius-mss.

SIRIUS 3RK3 Modular Safety System

Expansion modules, interface modules, operating & monitoring modules

Selection and ordering data

PU (UNIT, SET, M) = 1
PS* = 1 unit



3RK3 211-1AA10
3RK3 221-1AA10
3RK3 231-1AA10
3RK3 242-1AA10



3RK3 251-1AA10





3RK3 311-1AA10
3RK3 321-1AA10



3RK3 511-1BA10



3RK3 611-3AA00







Version	DT	Screw terminals 	DT	Spring-type terminals 	
		Order No.	Price per PU	Order No.	Price per PU
Expansion modules					
4/8 F-DI Safety-related input modules • 8 inputs	A	3RK3 211-1AA10		A	3RK3 211-2AA10
2/4 F-DI 1/2 F-RO Safety-related input/output modules • 4 inputs • 2 single-channel relay outputs	A	3RK3 221-1AA10		A	3RK3 221-2AA10
2/4 F-DI 2F-DO Safety-related input/output modules • 4 inputs • 2 two-channel solid-state outputs	▶	3RK3 231-1AA10		A	3RK3 231-2AA10
4/8 F-RO Safety-oriented output modules • 8 single-channel relay outputs	A	3RK3 251-1AA10		▶	3RK3 251-2AA10
4 F-DO Safety-oriented output modules • 4 two-channel solid-state outputs	A	3RK3 242-1AA10		▶	3RK3 242-2AA10
8 DI Standard input module • 8 inputs	▶	3RK3 321-1AA10		▶	3RK3 321-2AA10
8 DO Standard output module • 8 solid-state outputs	A	3RK3 311-1AA10		A	3RK3 311-2AA10
Interface modules					
DP interface PROFIBUS DP interface, 12 Mbit/s, RS 485, 32-bit cyclic data exchange with Basic central unit or 64-bit with Advanced central unit, acyclic exchange of diagnostics data	A	3RK3 511-1BA10		A	3RK3 511-2BA10
Operating and monitoring modules					
Diagnostics module	A	3RK3 611-3AA00		--	

Note:

Connection cable required, see page 13/154.

More information on the Internet at www.siemens.com/sirius-mss.

Selection and ordering data

Version	DT	Order No.	Price per PU	PU (UNIT, SET, M)	PS*																		
Connection cables (essential accessory)																							
Connection cables																							
For connection of																							
 3UF7 932-0AA00-0	<table border="1"> <tr> <th>Central units with expansion modules or interface module</th> <th>Diagnostics modules with central unit or interface module</th> </tr> <tr> <td>✓</td> <td>✓</td> </tr> <tr> <td>--</td> <td>✓</td> </tr> <tr> <td>--</td> <td>✓</td> </tr> <tr> <td>--</td> <td>✓</td> </tr> <tr> <td>--</td> <td>✓</td> </tr> <tr> <td>--</td> <td>✓</td> </tr> <tr> <td>--</td> <td>✓</td> </tr> <tr> <td>--</td> <td>✓</td> </tr> </table>	Central units with expansion modules or interface module	Diagnostics modules with central unit or interface module	✓	✓	--	✓	--	✓	--	✓	--	✓	--	✓	--	✓	--	✓	<ul style="list-style-type: none"> • Length 0.025 m (flat) ▶ • Length 0.1 m (flat) ▶ • Length 0.3 m (flat) ▶ • Length 0.5 m (flat) ▶ • Length 0.5 m (round) ▶ • Length 1.0 m (round) ▶ • Length 2.5 m (round) ▶ 	<ul style="list-style-type: none"> ▶ 3UF7 930-0AA00-0 ▶ 3UF7 931-0AA00-0 ▶ 3UF7 935-0AA00-0 ▶ 3UF7 932-0AA00-0 ▶ 3UF7 932-0BA00-0 ▶ 3UF7 937-0BA00-0 ▶ 3UF7 933-0BA00-0 	<ul style="list-style-type: none"> 1 1 1 1 1 1 1 	<ul style="list-style-type: none"> 1 unit 1 unit 1 unit 1 unit 1 unit 1 unit 1 unit
Central units with expansion modules or interface module	Diagnostics modules with central unit or interface module																						
✓	✓																						
--	✓																						
--	✓																						
--	✓																						
--	✓																						
--	✓																						
--	✓																						
--	✓																						
PC cables and adapters																							
PC cables																							
For connecting to the serial interface of a PC/PG, for communication with 3RK3 through the system interface																							
 3UF7 940-0AA00-0		▶	3UF7 940-0AA00-0	1	1 unit																		
USB PC cables																							
For connecting to the USB interface of a PC/PG, for communication with 3RK3 through the system interface, recommended for use in connection with 3RK3																							
		▶	3UF7 941-0AA00-0	1	1 unit																		
USB/serial adapters																							
For connecting the RS 232 PC cable to the USB interface of a PC																							
	B		3UF7 946-0AA00-0	1	1 unit																		
Interface covers																							
Interface covers																							
For system interface																							
 3UF7 950-0AA00-0		▶	3UF7 950-0AA00-0	1	5 units																		
Memory modules																							
Memory modules																							
For backing up the complete parameterization of the 3RK3 Modular Safety System without a PC/PG through the system interface																							
 3RK3 931-0AA00		▶	3RK3 931-0AA00	1	1 unit																		
Door adapters																							
Door adapters																							
For external connection of the system interface, e.g. outside a control cabinet																							
 3UF7 920-0AA00-0			3UF7 920-0AA00-0	1	1 unit																		
Push-in lugs																							
Push-in lugs for screw fixing																							
e.g. on mounting plate, 2 units required per device																							
Can be used for 3RK3																							
 3RP19 03		▶	3RP19 03	1	10 units																		
Manuals																							
Manuals for the 3RK3 Modular Safety System (MSS)																							
• English																							
	C		3ZX1 012-0RK31-1AC1	1	1 unit																		



✓ Available
 -- Not available

SIRIUS 3RK3 Modular Safety System

Accessories

Parameterization, startup and diagnostics software for 3RK3

- Runs under Windows XP Professional (Service Pack 2 or 3), Windows 7 32/64 Bit Professional/Ultimate/Enterprise (Service Pack 1)
- Delivered without PC cable. Please order separately, see page 13/154.

Version	DT	Order No.	Price per PU	PU (UNIT, SET, M)	PS*
SIRIUS Safety ES Basic					
 <p>3ZS1 316-4CC10-0YA5</p>	Floating license for one user Engineering software in limited-function version for diagnostics purposes, software and documentation on CD, 3 languages (German/English/French), communication through the system interface				
	• License key on USB stick, Class A	A	3ZS1 314-4CC10-0YA5	1	1 unit
	• License key download, Class A	▶	3ZS1 314-4CE10-0YB5	1	1 unit
SIRIUS Safety ES Standard					
 <p>3ZS1 316-5CC10-0YA5</p>	Floating license for one user Engineering software, software and documentation on CD, 3 languages (German/English/French), communication through system interface				
	• License key on USB stick, Class A	B	3ZS1 314-5CC10-0YA5	1	1 unit
	• License key download, Class A	▶	3ZS1 314-5CE10-0YB5	1	1 unit
		Powerpack for SIRIUS Safety ES Basic to Standard Floating license for one user, engineering software, license key on USB stick, Class A, 3 languages (German/English/French), communication through the system interface	A	3ZS1 314-5CC10-0YD5	1 1 unit
SIRIUS Safety ES Premium					
 <p>3ZS1 316-6CC10-0YA5</p>	Floating license for one user Engineering software, software and documentation on CD, 3 languages (German/English/French), communication through PROFIBUS or the system interface, online diagnostics via PROFIBUS, creating, importing and exporting macros				
	• License key on USB stick, Class A	▶	3ZS1 314-6CC10-0YA5	1	1 unit
	• License key download, Class A	▶	3ZS1 314-6CE10-0YB5	1	1 unit
		Powerpack for SIRIUS Safety ES Basic to Standard Floating license for one user, engineering software, license key on USB stick, Class A, 3 languages (German/English/French), communication through PROFIBUS or the system interface, online diagnostics via PROFIBUS, creating, importing and exporting macros	A	3ZS1 314-6CC10-0YD5	1 1 unit

Technical specifications

Central units and expansion modules

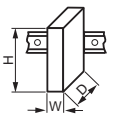
Type	Central units				Expansion modules							
	Basic	Advanced	ASIsafe basic	ASIsafe extended	4/8F-DI	2/4 F-DI 1/2 F-RO	2/4 F-DI 2F-DO	4/8 F-RO	4 F-DO	8 DI	8 DO	
Dimensions (W x H x D)												
												
• Screw terminals	mm	45 x 111 x 124				22.5 x 111 x 124			45 x 111 x 124		22.5 x 111 x 124	
• Spring-type terminals	mm	45 x 113 x 124				22.5 x 113 x 124			45 x 113 x 124		22.5 x 113 x 124	
Device data												
Shock resistance (sine pulse)	g/ms	15/11										
Touch protection according to EN 50274 and IEC 60529		IP20										
Permissible mounting position		Vertical mounting surface (+10°/-10°), deviating mounting positions are permitted for reduced ambient temperature										
Minimum distances		For heat dissipation through convection from the devices 25 mm to the ventilation openings (top and bottom)										
Permissible ambient temperature												
• During operation	°C	-20 ... +60										
• During storage and transport	°C	-40 ... +85										
Number of sensor inputs (single-channel)												
• Fail-safe		--	--	2	4	8	4	4	--	--	--	--
• Not fail-safe		8	8	6	4	--	--	--	--	--	8	8
Number of test outputs		2	2	2	2	2	2	2	--	--	--	--
Number of outputs												
• Relay outputs												
- Single channel		--	--	--	--	--	2	--	8	--	--	--
- Two-channel		1	1	1	1	--	--	--	--	--	--	--
• Solid-state outputs												
- Single channel		--	--	--	--	--	--	--	--	--	--	8
- Two-channel		1	1	1	1	--	--	2	--	4	--	--
Weight	g	300	300	300	300	160	160	160	400	135	125	160
Installation altitude above sea level	m	2 000										
Environmental data												
EMC interference immunity		IEC 60947-5-1										
Vibrations												
• Frequency	Hz	5 ... 500										
• Amplitude	mm	0.75										
Climatic withstand capability		IEC 60068-2-78										
Electrical specifications												
Rated control supply voltage U_s according to IEC 61131-2	V	24 DC 15 % ¹⁾										
Operating range		0.85 ... 1.15 x U_s										
Rated insulation voltage U_i	V	300	300	300	300	50	300	50	300	50	50	50
Rated impulse voltage U_{imp}	kV	4	4	4	4	0,5	4	0,5	4	0,5	0,5	0,5
Total current consumption	mA	185	185	185	185	60	85	85	140	8	78	60
Rated power at U_s	W	4.5	4.5	4.5	4.5	1.5	2	2	3	4.8	1.9	1.5
Utilization categories acc. to IEC 60947-5-1 (relay outputs)												
• AC-15 at 230 V	A	2	2	2	2	--	2	--	2	--	--	--
• DC-13 at 24 V (semiconductor outputs)	A	1	1	1	1	--	1	--	1	--	--	--
• DC-13 at 24 V	A	1.5	1.5	1.5	1.5	--	--	1	--	2	--	0.5
Mechanical endurance During rated operation	Operating cycles (relay)	10 x 10 ⁶	10 x 10 ⁶	10 x 10 ⁶	10 x 10 ⁶	--	10 x 10 ⁶	--	10 x 10 ⁶	--	--	--

¹⁾ Device current supply through a power supply unit acc. to IEC 60536 protection class (SELV or PELV).

SIRIUS 3RK3 Modular Safety System

Technical data

Type	Central units				Expansion modules							
	Basic	Advanced	ASIsafe basic	ASIsafe extended	4/8F-DI	2/4 F-DI 1/2 F-RO	2/4 F-DI 2F-DO	4/8 F-RO	4 F-DO	8 DI	8 DO	
Electrical specifications (cont.)												
Switching frequency z for rated operational current	1/h	1 000	1 000	1 000	1 000	--	1 000	1 000	360	1 000	--	1 000
Conventional thermal current I_{th}	A	2/1.5	2/1.5	2/1.5	2/1.5	--	1	1	3	2	--	0.5
Protection for output contacts												
Fuse links LV HRC Type 3NA, DIAZED Type 5SB, NEOZED Type 5SE												
• Operational class gG	A	4	4	4	4	--	4	--	4	--	--	--
• Operational class quick response	A	6	6	6	6	--	6	--	6	--	--	--
Safety specifications												
Probability of a dangerous failure												
• Per hour (PFH _d)	1/h	5.14 x 10 ⁻⁹	2.8 x 10 ⁻⁹	2.8 x 10 ⁻⁹	2.8 x 10 ⁻⁹	1.89 x 10 ⁻⁹	3.79 x 10 ⁻⁹	2.7 x 10 ⁻⁹	7.15 x 10 ⁻⁹	3.18 x 10 ⁻⁹	--	--
• On demand (PFD)	1/h	1.28 x 10 ⁻⁵	1.7 x 10 ⁻⁴	1.7 x 10 ⁻⁴	1.7 x 10 ⁻⁴	4.29 x 10 ⁻⁶	5.85 x 10 ⁻⁶	8.34 x 10 ⁻⁶	4.36 x 10 ⁻⁵	2.2 x 10 ⁻⁵	--	--
Parameters for cables												
Line resistance		100	100	100	100	100	100	100	--	--	100	--
Cable length from terminal to terminal With Cu 1.5 mm ² and 150 nF/km	m	1 000	1 000	1 000	1 000	1 000	1 000	1 000	--	--	1 000	--
Conductor capacity	nF	330	330	330	330	330	330	330	--	--	330	--

Interface and diagnostics modules

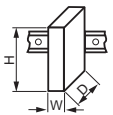
Type	Interface modules		Diagnostics modules	
Dimensions (W x H x D)				
				
• Screw terminals	mm	45 x 111 x 124		96 x 60 x 44
• Spring-type terminals	mm	45 x 113 x 124		--
Device data				
Shock resistance (sine pulse)	g/ms	15/11		
Touch protection according to EN 50274 and IEC 60529		IP20		
Permissible mounting position		Vertical mounting surface (+10°/-10°), deviating mounting positions are permitted for reduced ambient temperature		
Minimum distances		For heat dissipation through convection from the devices 25 mm to the ventilation openings (top and bottom)		
Permissible ambient temperature				
• During operation	°C	-20 ... +60		
• During storage and transport	°C	-40 ... +85		
Weight	g	270		90
Installation altitude above sea level	m	2 000		
Environmental data				
EMC interference immunity		IEC 60947-5-1		
Vibrations				
• Frequency	Hz	5 ... 500		
• Amplitude	mm	0.75		
Climatic withstand capability		IEC 60068-2-78		
Electrical specifications				
Rated control supply voltage U_s according to IEC 61131-2	V	24 DC 15 %	24 DC 15 % via connecting cable to the central unit	
Operating range		0.85 ... 1.15 x U _s		
Rated insulation voltage U_i	V	50		
Rated impulse voltage U_{imp}	kV	0,5		
Total current consumption	mA	--		24
Rated power at U_s	W	--		0.6

Application

The 3RK3 Modular Safety System can be used for all safety-oriented requirements in the manufacturing industry and offers the following safety functions:

	Symbol	MSS Basic	MSS Advanced, MSS ASIsafe
Monitoring functions			
Universal monitoring Evaluation of any binary signals from single-channel and two-channel sensors		--	✓
EMERGENCY-STOP Evaluation of EMERGENCY-STOP devices with positive-opening contacts		✓	✓
Safety shutdown mats Evaluation of safety shutdown mats with NC contacts and/or cross-circuit detection		✓	✓
Protective door monitoring Evaluation of protective door signals and/or protective flap signals		✓	✓
Protective door interlocking mechanism Evaluation of protective doors with interlocking and locking/unlocking of this device		--	✓
Enabling switches Evaluation of OK buttons with NO contact		✓	✓
Two-hand operator controls Evaluation of two-hand operation consoles		✓	✓
ESPE monitoring Evaluation of electro-sensitive protective equipment such as light arrays and laser scanners		✓	✓
Muting Short-time bridging of electro-sensitive protective equipment, 2/4 sensors in parallel, 4 sensors sequentially		--	✓
Operating mode selector switches Evaluation of operating mode selector switches with NO contacts		✓	✓
Monitoring of AS-i (AS-i 2F-DI) Logic element for monitoring of AS-i input slaves		--	✓

✓ Available
-- Not available

	Symbol	MSS Basic	MSS Advanced, MSS ASIsafe
Logic operation functions			
AND		✓	✓
OR		✓	✓
XOR		✓	✓
NAND		✓	✓
NOR		✓	✓
Negation		✓	✓
Flip-flop		✓	✓
Counter functions			
Counter 0 -> 1		✓	✓
Counter 1 -> 0		✓	✓
Counter 0 -> 1/1 -> 0		✓	✓
Timer functions			
With ON-delay		✓	✓
Passing make contact		✓	✓
With OFF-delay		✓	✓
Clock pulsing		✓	✓
Start functions			
Monitored start		✓	✓
Manual start		✓	✓
Output functions			
Standard output		✓	✓
F output		✓	✓
AS-i output function		--	✓
Status functions			
Element status		--	✓

Dimensional drawings

Central module with screw terminals

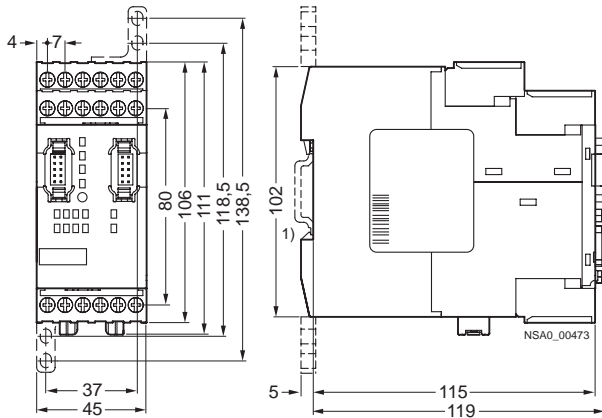

Central module with spring-type terminals

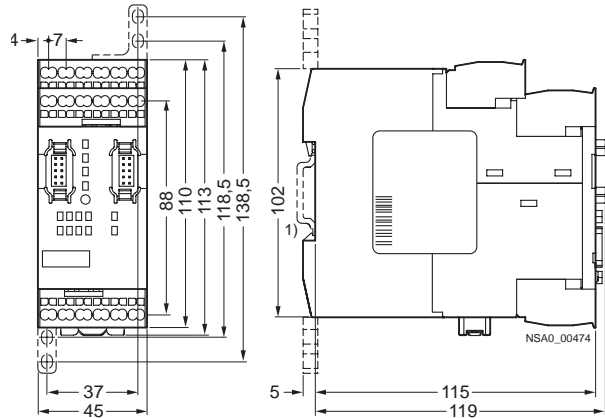

Expansion module with screw terminals

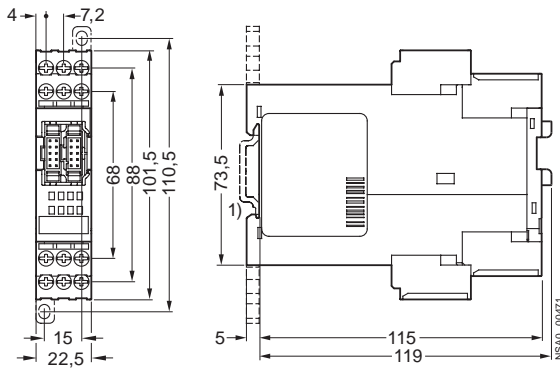

Expansion module with spring-type terminals

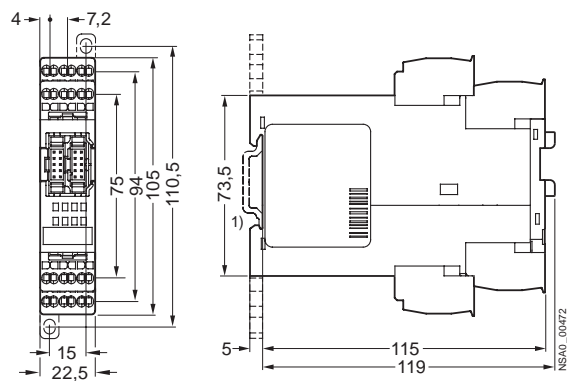

Interface module with screw terminals

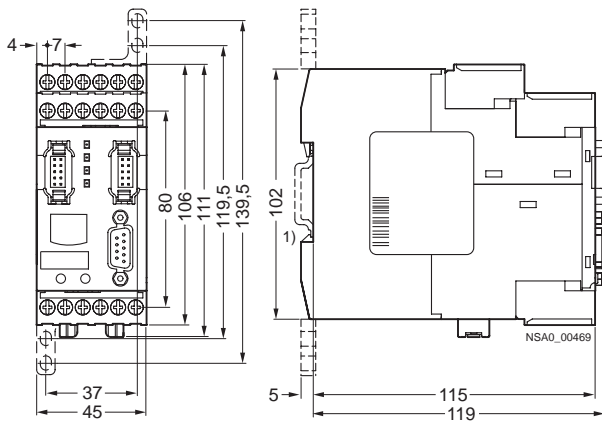

Interface module with spring-type terminals

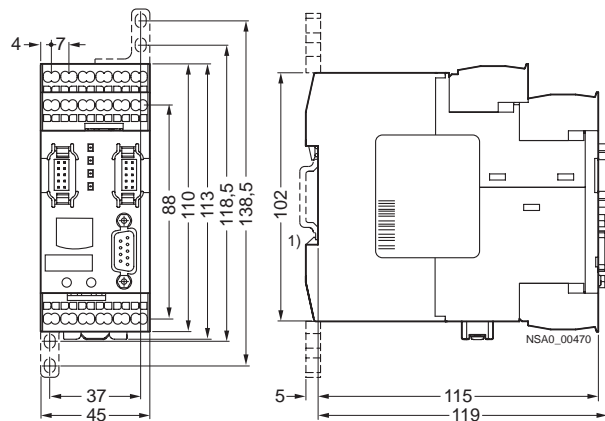

1) For standard mounting rail TH 35 according to EN 60715.