

POWER PRODUCT Switchboards

Contents

Sentron SMP, FCI, FCII Switchboards

Type SMP

Construction Details Features	11-2
Features	11-3
Specification	11-8

Type FCI, FCII

Construction Details Features	11-10
Features	11-11
Specifications	11-12

Modifications and Additions Replacements for Circuit Breakers and Fusible Switches Selection

11-17

Protective Devices

Sentron™ Molded Case Circuit Breakers	11-18
Solid State Sensitrip™ Molded Case Circuit Breakers	11-19
Fusible Switches	11-20
HCP Disconnect Switches	11-21
Metering Data	11-22

Type IPS - Integrated Power Systems Switchboard

Features	11-23
Embedded Micro Metering Module (SEM3)	11-25

Sentron® SMP Switchboards

Construction Details

Construction

Simplified system design.

A typical SMP switchboard consists of a floor mounted, wall supported service section, and a distribution section. The wireway can also be added where required by the local utility or if additional cable termination space is required.

Wireways are modular to allow flexibility.

The wireway is available in 2 depths to suit customer needs. Wireway has split front doors as standard with optional hinged doors. The lug pads are standard NEMA hole pattern and accept up to 5 mechanical lugs or 6 compression lugs.

90°C rated wireway.

The termination temperature for main incoming cables can be sized at 90°C for bussed pull sections.

Service Entrance Sections house a variety of equipment.

▪ Service Entrance Sections.

Service sections can be fed directly from overhead by cable.

Service entrance sections equipped for bottom feed will accept cable from underground directly into the service section.

▪ Utility Metering

In addition to the main device, the service section contains utility metering provisions. "Cold" metering provisions (CT's on the load side of the main device) are furnished. The CT's are provided by the utility company. The compartment will be built to utility company standards, with hinged doors and provisions for utility metering equipment.

▪ User Metering

The service section provides space for the Siemens Digital Meter with remote display, and its associated components.

▪ Main protective device

The MCCB is mounted individually so that it can be located quickly in an emergency. SMP switchboards will accommodate different types of main circuit breakers. Selection depends on the characteristics of your individual electrical system.

Distribution Sections have ample wiring room and front accessibility.

Generous top or bottom gutters have been created by locating the bus-link in the top or bottom of the distribution section, so there's ample room to run cables into the distribution section and make connections.

Standard bolted covers allow complete access to load conductors. Future flexibility comes standard in the Siemens SMP switchboard. The distribution section can accommodate any combination of panel mounted devices, including MCCBs and fusible disconnect switches.

Operating temperatures are in accordance with CSA Standards

Bus bars are available in standard tin-finished aluminum or optional silver-finished copper. Standard bus is sized on the basis of heat rise criteria, in accordance with CSA C22.2 #31. All bus bars are sized to limit heat rise to 65°C above an ambient temperature of 40°C.

Bus-Link Connections are accessible from the front.

The Bus-Link can be bolted from the front of the switchboard. Each bus-link is attached by grade five bolts to assure solid joints between sections, and to maintain full bus ampacity through the joint.

To make installation and servicing of the bus-link easier, all phase and neutral busses are stacked one above the other.

Cable Terminals

Screw mechanical connectors (lugs) are provided as standard equipment.

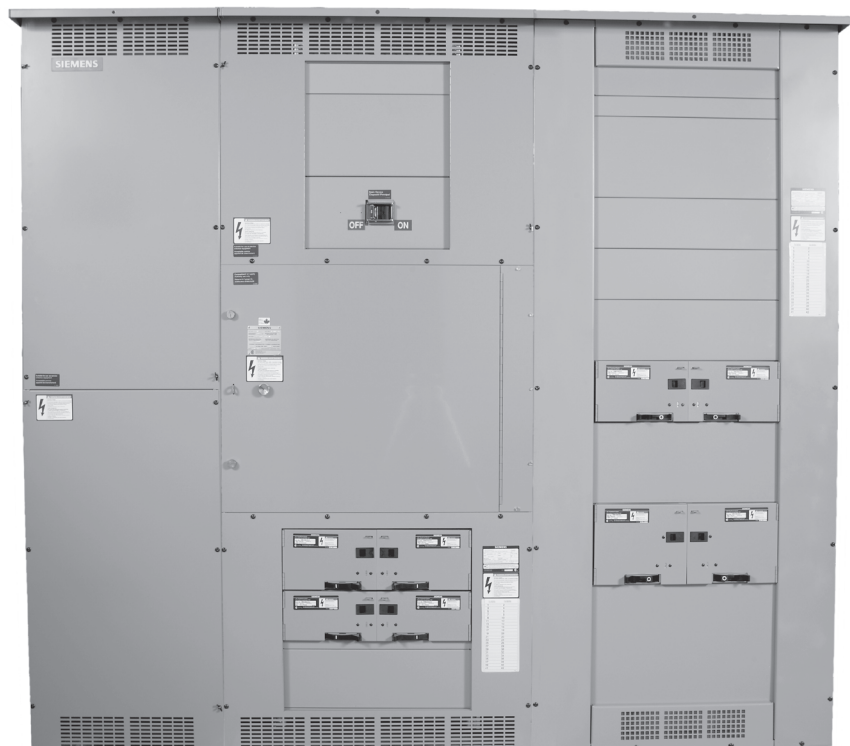

Sentron® SMP Switchboards

Power and Distribution

General

SMP Switchboard Introduction

Whether the design is for a 240V AC, 400 ampere system; a 600V AC, 1200 A ampere system; or something in between, Siemens Sentron Switchboards should be considered. Every aspect of design has been aimed at improving layout convenience, reducing installation costs, and minimizing the impact and cost of system changes. These switchboards provide the space saving construction and service flexibility necessary in systems for light industrial plants, retail strip malls, and commercial buildings.

Service entrance sections of the SMP accepts a wide range of Sentron Molded Case Circuit Breakers as main disconnect devices.

The SMP switchboard is designed for special configurations. It can be equipped with incoming and outgoing cable/conduit connections, supplied with metering and other special features.

The distribution sections of all Sentron Switchboards are designed with improved wiring space and greater accessibility. They're also designed for easier installation and maintenance. Conveniently located bus-link without compromising useful wiring gutter space, and standard bolted gutter covers offer complete access to load conductors. Front accessibility to bus and protective devices makes adding or replacing circuit breakers or switches quick and easy.

SMP Switchboard Features and Ratings

- **Main bus** rated up to 1200 ampere.
- Rear of all sections aligned so that switchboard can be floor mounted and secured against the wall.
- Front connected and front accessible.
- **Main devices** – individually mounted.
Molded Case Breaker: 400-1200 amps.
- **Branch Devices** – panel mounted.
Molded Case Breaker: 15–1200 amps fixed.
Quick-Make Quick-Break Fusible Switch: 30 - 600A

600 Volts AC Maximum
1200 Ampere Mains
1200 Ampere Maximum Branch
CSA Short Circuit Rating –
65,000A IR Maximum

CSA Certified To: CAN/CSA-22.2 No. 31-14

CSA File #LR 153416 (013076)

SMP Specifications (Table 1)

SMP Switchboard	
Enclosure Type	Type 1 Type 2 Optional: Dripshield, Sprinklerproof
Dimensions Main or Distribution Wireway	38" W x 90" H x 12.75" Dp 24" W x 90" H x 12.75" Dp or 25.5" Dp
Volts	600V Max
Amperes	400-1200A
Bus Type	Aluminum (tin plated) Copper (silver finished) optional
Bus Bracing	50 KA 65 KA (optional)
Interrupting Capacity	50 KA 65 KA (optional)
Entry	Cable only (top or bottom)
Main Device	MCCB 400-1200A ▪ 80% Rated ▪ 100% Rated (option)
Branch Devices (Unit Space)	52.5" in Main with Distribution Section, or 22.5" in MUD Section, or 60" in Distribution Section
Metering Devices	Siemens Digital Metering with Remote Display SEM3 Embedded Metering
Other Options	SPD Units Sill Channels (1.5") Lifting Hooks

Main and Distribution Section Dimensions (Table 2)

Switchboard Type	Access	Dimensions - Inches (mm)		
		H	W	D
SMP	Front	90" (2286)	38" (965)	12.75" (324)



① Only available as a Wireway.

Sentron® SMP Switchboards

Power and Distribution

Selection

Protective Devices - Molded Case Circuit Breakers

Standard

Breakers are designed for commercial, industrial, institutional and other heavy duty applications. They are rated up to 600V AC and 250V DC. Their interrupting ratings are higher than normal duty breakers.

High Interrupting

Breakers are designed for heavy duty applications where the interrupting requirements exceed the ratings of heavy duty breakers. They are rated up to 600V AC.

Current Limiting

Molded case breakers incorporate the exclusive I-TE blow-apart interruption principle. They meet the CSA requirements for current-limiting breakers. Current-limiting circuit breakers can limit the let-through I^2t to a value less than the I^2t of one-half cycle wave of the symmetrical prospective current without any fusible elements when operating within their current-limiting range.

Main Breaker Selection (Table 3)

Amperage Rating	Breaker Type	Trip Type	Maximum Interrupting Rating (kA)			Available Trip Values
			240V	480V	600V	
400	JXD6	Thermal Magnetic	65	35	25	200, 225, 250, 300, 350, 400
	JD6		65	35	25	200, 225, 250, 300, 350, 400
	HJD6		100	65	35	200, 225, 250, 300, 350, 400
	HHJD6		200	100	50	200, 225, 250, 300, 350, 400
	CJD6		200	150	100	200, 225, 250, 300, 350, 400
	SJD6	Electronic (Solid State)	65	35	25	200, 300, 400
	SHJD6		100	65	35	200, 300, 400
	SCJD6		200	150	100	200, 300, 400
600	LXD6	Thermal Magnetic	65	35	25	450, 500, 600
	LD6		65	35	25	250, 300, 350, 400, 450, 500, 600
	HLD6		100	65	35	250, 300, 350, 400, 450, 500, 600
	HHLD6		200	100	50	250, 300, 350, 400, 450, 500, 600
	CLD6		200	150	100	450, 500, 600
	SLD6	Electronic (Solid State)	65	35	25	300, 400, 500, 600
	SHLD6		100	65	35	300, 400, 500, 600
	SCLD6		200	150	100	300, 400, 500, 600
800	MXD6	Thermal Magnetic	65	50	25	500, 600, 700, 800
	MD6		65	50	25	500, 600, 700, 800
	HMD6		100	65	50	500, 600, 700, 800
	CMD6		200	100	65	500, 600, 700, 800
	SMD6	Electronic (Solid State)	65	50	25	600, 700, 800
	SHMD6		100	65	50	600, 700, 800
	SCMD6		200	100	65	600, 700, 800
1200	NXD6	Thermal Magnetic	65	50	25	800, 900, 1000, 1200
	ND6		65	50	25	800, 900, 1000, 1200
	HND6		100	65	50	800, 900, 1000, 1200
	CND6		200	100	65	800, 900, 1000, 1200
	SND6	Electronic (Solid State)	65	50	25	800, 1000, 1200
	SHND6		100	65	50	800, 1000, 1200
	SCND6		200	100	65	800, 1000, 1200

Branch Breaker Gutter Dimensions For 38"W Distribution Section (Table 5)

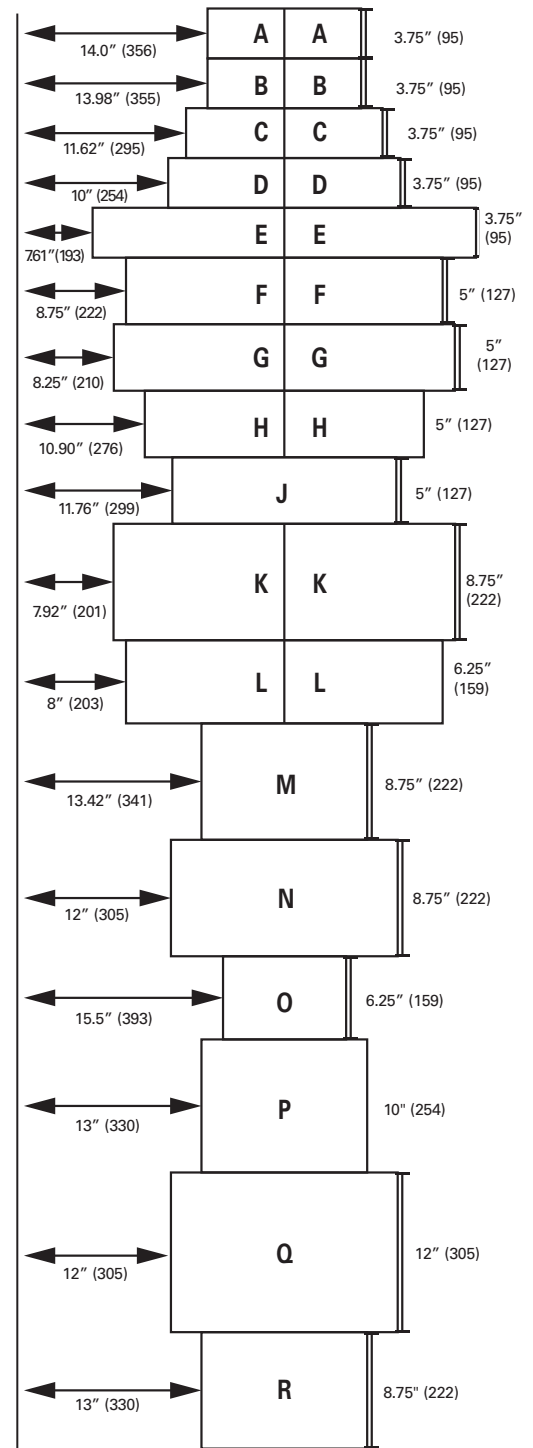

Sentron® SMP Switchboards

Power and Distribution

Selection

Branch Circuit Breaker Selection^① (Table 4)

11 SWITCHBOARDS

Breaker Frame Rating	Trip Type	Breaker Type	Poles	Trip Amperage	Mounting Height Inches (mm)			Max IC Rating (kA)		
					Single	Twin	Gutter ^②	240V	480V	600V
100	Thermal Magnetic	BL	1, 2, 3	15, 20, 25, 30, 40, 50, 60, 70, 80, 90, 100	—	3.75" (95) ^{②③}	A 14" (356)	10	/	/
		BLH	1, 2, 3	15, 20, 25, 30, 40, 50, 60, 70, 80, 90, 100	—	3.75" (95) ^{②③}	A 14" (356)	22	/	/
		HBL	1, 2, 3	15, 20, 25, 30, 40, 50, 60, 70, 80, 90, 100	—	3.75" (95) ^{②③}	A 14" (356)	65	/	/
		BQD6 ^③	1, 2, 3	15, 20, 30, 40, 50, 60, 70	—	3.75" (95) ^{②③}	A 14" (356)	65	/	10
	Ground Fault Circuit Interrupter	BLE (GFCI)	1, 2	15, 20, 30, 40, 50, 60	—	3.75" (95) ^②	A 14" (356)	10	/	/
		BLF (GFCI)	1, 2	15, 20, 30, 40, 50, 60	—	3.75" (95) ^②	A 14" (356)	10	/	/
		BLHF (GFCI)	1, 2	15, 20, 30, 40, 50, 60	—	3.75" (95) ^②	A 14" (356)	22	/	/
	Arc Fault Circuit Interrupter	BAF (AFCI)	1	15, 20	—	3.75" (95) ^②	A 14" (356)	10	/	/
		BAFH (AFCI)	1	15, 20	—	3.75" (95) ^②	A 14" (356)	22	/	/
	125	Thermal Magnetic	ED2	1, 2, 3	15, 20, 30, 40, 50, 60, 70, 80, 90, 100	3.75" (95) ^{②③}	3.75" (95) ^{②③}	D 10" (254)	10	/
ED4			1, 2, 3	15, 20, 30, 40, 50, 60, 70, 80, 90, 100, 110, 125	3.75" (95) ^{②③}	3.75" (95) ^{②③}	D 10" (254)	65	18	/
ED6			1, 2, 3	15, 20, 30, 40, 50, 60, 70, 80, 90, 100, 110, 125	3.75" (95) ^{②③}	3.75" (95) ^{②③}	D 10" (254)	100	18	18
HED4			1, 2, 3	15, 20, 30, 40, 50, 60, 70, 80, 90, 100, 110, 125	3.75" (95) ^{②③}	3.75" (95) ^{②③}	D 10" (254)	100	65	30
CED6			2, 3	15, 20, 30, 40, 50, 60, 70, 80, 90, 100, 110, 125	3.75" (95) ^③	3.75" (95) ^③	E 7.61" (193)	200	200	100
HEB			2, 3	15, 20, 30, 40, 50, 60, 70, 80, 90, 100, 110, 125	—	3.75" (95) ^{②③}	C 11.62 (295)	100	65	25
NGB			1, 2, 3	15, 20, 25, 30, 40, 50, 60, 70, 80, 90, 100, 110, 125	—	3.75" (95) ^{②③}	B 13.98" (355)	100	25	14
NGB2			1, 2, 3	15, 20, 25, 30, 40, 50, 60, 70, 80, 90, 100, 110, 125	—	3.75" (95) ^{②③}	B 13.98" (355)	100	25	14
HGB2			1, 2, 3	15, 20, 25, 30, 40, 50, 60, 70, 80, 90, 100, 110, 125	—	3.75" (95) ^{②③}	B 13.98" (355)	100	35	22
LGB2			1, 2, 3	15, 20, 25, 30, 40, 50, 60, 70, 80, 90, 100, 110, 125	—	3.75" (95) ^{②③}	B 13.98" (355)	100	65	25
150			Electronic (Solid State)	NDG	3	60, 100, 150	—	5" (127)	H 10.9" (276)	65
	LDG	3		60, 100, 150	—	5" (127)	H 10.9" (276)	200	100	18
225	Thermal Magnetic	QJ2	2, 3	60, 70, 80, 90, 100, 110, 125, 150, 175, 200, 225	5" (127)	5" (127)	F 8.75" (222)	10	/	/
		QJH2	2, 3	60, 70, 80, 90, 100, 110, 125, 150, 175, 200, 225	5" (127)	5" (127)	F 8.75" (222)	22	/	/
		QJ2H	2, 3	60, 70, 80, 90, 100, 110, 125, 150, 175, 200, 225	5" (127)	5" (127)	F 8.75" (222)	42	/	/
		QR2	2, 3	100, 110, 125, 150, 175, 200, 225	5" (127)	5" (127)	F 8.75" (222)	10	/	/
		QRH2	2, 3	100, 110, 125, 150, 175, 200, 225	5" (127)	5" (127)	F 8.75" (222)	25	/	/
		HQR2	2, 3	100, 110, 125, 150, 175, 200, 225	5" (127)	5" (127)	F 8.75" (222)	65	/	/
		HQR2H	2, 3	100, 110, 125, 150, 175, 200, 225	5" (127)	5" (127)	F 8.75" (222)	100	/	/
250	Thermal Magnetic	FXD6, FD6	2, 3	70, 80, 90, 100, 110, 125, 150, 175, 200, 225, 250	5" (127)	5" (127)	G 8.25" (210)	65	35	22
		HFD6	2, 3	70, 80, 90, 100, 110, 125, 150, 175, 200, 225, 250	5" (127)	5" (127)	G 8.25" (210)	100	65	25
		CFD6	2, 3	70, 80, 90, 100, 110, 125, 150, 175, 200, 225, 250	—	5" (127)	J 11.76" (299)	200	200	100
	Electronic (Solid State)	NFG	3	100, 150, 250	—	5" (127)	H 10.9" (276)	65	35	18
		LFG	3	100, 150, 250	—	5" (127)	H 10.9" (276)	200	100	25
400	Thermal Magnetic	JXD6, JD6	2, 3	200, 225, 250, 300, 350, 400	8.75" (222)	8.75" (222)	K 7.92" (201)	65	35	25
		HJD6	2, 3	200, 225, 250, 300, 350, 400	8.75" (222)	8.75" (222)	K 7.92" (201)	100	65	35
		HHJD6	2, 3	200, 225, 250, 300, 350, 400	8.75" (222)	8.75" (222)	K 7.92" (201)	200	100	50
		CJD6	2, 3	200, 225, 250, 300, 350, 400	8.75" (222)	—	N 12" (305)	200	150	100
	Electronic (Solid State)	SJD6	3	200, 300, 400	8.75" (222)	—	M 13.42" (341)	65	35	25
		SHJD6	3	200, 300, 400	8.75" (222)	—	M 13.42" (341)	100	65	35
		SCJD6	3	200, 300, 400	8.75" (222)	—	N 12" (305)	200	150	100
		NJG	3	250, 400	6.25" (159)	6.25" (159)	L 8" (203)	65	35	25
		LJG	3	250, 400	6.25" (159)	6.25" (159)	L 8" (203)	200	100	25
600	Thermal Magnetic	LXD6	2, 3	450, 500, 600	8.75" (222)	—	M 13.42" (341)	65	35	25
		LD6	2, 3	250, 300, 350, 400, 450, 500, 600	8.75" (222)	—	M 13.42" (341)	65	35	25
		HLD6	2, 3	250, 300, 350, 400, 450, 500, 600	8.75" (222)	—	M 13.42" (341)	100	65	35
		HHLD6	2, 3	250, 300, 350, 400, 450, 500, 600	8.75" (222)	—	M 13.42" (341)	200	100	50
		CLD6	2, 3	450, 500, 600	8.75" (222)	—	N 12" (305)	200	150	100
	Electronic (Solid State)	SLD6	3	300, 400, 500, 600	8.75" (222)	—	M 13.42" (341)	65	35	25
		SHLD6	3	300, 400, 500, 600	8.75" (222)	—	M 13.42" (341)	100	65	35
		SCLD6	3	300, 400, 500, 600	8.75" (222)	—	N 12" (305)	200	150	100
800	Thermal Magnetic	LMXD6, LMD6	2, 3	500, 600, 700, 800	8.75" (222)	—	R 13" (330)	65	50	25
		HLMXD6, HLMD6	2, 3	500, 600, 700, 800	8.75" (222)	—	R 13" (330)	100	65	50
		MXD6	2, 3	500, 600, 700, 800	10" (254)	—	P 13" (330)	65	50	25
		MD6	2, 3	500, 600, 700, 800	10" (254)	—	P 13" (330)	65	50	25
		HMD6	2, 3	500, 600, 700, 800	10" (254)	—	P 13" (330)	100	65	50
		CMD6	2, 3	500, 600, 700, 800	10" (254)	—	P 13" (330)	200	100	65
	Electronic (Solid State)	SMD6	3	600, 700, 800	10" (254)	—	Q 12" (305)	65	50	25
		SHMD6	3	600, 700, 800	10" (254)	—	Q 12" (305)	100	65	50
		SCMD6	3	600, 700, 800	10" (254)	—	Q 12" (305)	200	100	65
1200	Thermal Magnetic	NXD6	2, 3	800, 900, 1000, 1200	10" (254)	—	P 13" (330)	65	50	25
		ND6	2, 3	800, 900, 1000, 1200	10" (254)	—	P 13" (330)	65	50	25
		HND6	2, 3	800, 900, 1000, 1200	10" (254)	—	P 13" (330)	100	65	50
		CND6	2, 3	800, 900, 1000, 1200	10" (254)	—	P 13" (330)	200	100	65
	Electronic (Solid State)	SND6	3	800, 1000, 1200	10" (254)	—	Q 12" (305)	65	50	25
		SHND6	3	800, 1000, 1200	10" (254)	—	Q 12" (305)	100	65	50
		SCND6	3	800, 1000, 1200	10" (254)	—	Q 12" (305)	200	100	65

① Space includes housing frame plate with blank cover plate. Provision includes all necessary mounting hardware, less circuit breaker, and includes housing frame cover plate with breaker handle opening.

② 1 to 6 poles may be mounted in 3.75" (95) of unit space
 ③ Accessories such as shunt trips on three pole breakers require 6.25" (159) of unit space.
 ④ Ground fault is not available on branch Sensitrip breakers.

⑤ Also 10kA at 600Y/347 Volts.
 ⑥ Refer to Table 5 for layout dimensions.

Sentron® SMP Switchboards

Power and Distribution

Selection

Protective Devices - Fusible Disconnects

Fuse Selection

The Proper Fuse Type for the Application is Selected Using the Following Parameters:

- Voltage Requirements
- Conductor Ampacity
- Horsepower Requirements
- Maximum Available RMS Fault Current
- CSA Fuse Class

Maximum VB HP Ratings (Table 6)③

Amp Rating	Volts			
	3 Phase			Single Phase
	240	480	600	240
30	7.5	15	20	3
60	15	30	50	10
100	30	60	50	15
200	60	125	50	-
400	50	50	50	-
600	50	50	50	-

Branch Switch Connectors (Table 10)④

Switch Ampere Rating	Wire and Cable Range
30	(1) - #14-#4 AWG (Cu or Al)
60	(1) - #14-#4 AWG (Cu or Al)
100	(1) - #10-#1/0 AWG (Cu or Al)
200	(1) - #6 AWG-350kcmil (Cu or Al)
400	(1) - #1/0 AWG-750 MCM OR (2) - #1/0 AWG-250 MCM (Cu or Al)
600	(1) - #1/0 AWG-750 MCM OR (2) - #1/0 AWG-250 MCM (Cu or Al)

Branch Switch Gutter Dimensions For 38W Distribution Section (Table 8)

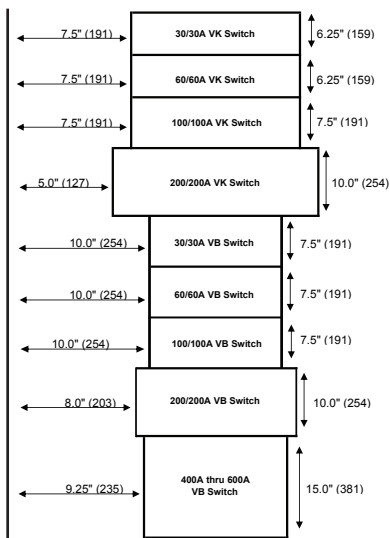

Maximum VK HP Ratings (Table 9)⑤

Amp Rating	Volts			
	3 Phase			Single Phase
	240	480	600	240
30	7.5	15	20	3
60	1.5	30	50	10
100	30	50	75	15
200	60	125	150	15

Gutters (Table 12)

Ampere Rating	End Gutters Minimum - Inches (mm)	Side Gutters Minimum - Inches (mm)
400	12" (305)	7.9" (201)
600	12" (305)	7.9" (201)

Branch Switches 600V Maximum (Table 11)

Rating Ampere	Max Voltage	Fusing	Mounting Height 38"W
30/30A & 60/60A (VK)⑤	600V	Class J, C, R	6.25" (159)
100/100A (VK)⑤	600V	Class J, C, T	7.5" (190)
200/200A (VK)⑤	600V	Class J, C, T	10.0" (254)
30/30A & 60/60A (VB)	600V	Class J	7.5" (190)
100/100A (VB)	600V	Class J	7.5" (190)
200A (VB)	600V	Class R, J, T	10.0" (254)
400A & 600A (VB)	600V	Class J, R, H, T	15.0" (381)

Switch Accessories (Table 13)

Fuse Pullers (VK)	Cat. No.
30 or 60 Amp	FP2
100 Amp	FP3
200 Amp	FP4

CSA Fuse Classes (Table 14)

Class	Amperes	Volts (AC)	Interrupting Ratings	I^2t , Ip (Let-Thru)	Circuits
H	Standard Code	1-600A	250 and 600V or less	10,000A	- Less than 10,000A available
K①	Fast Acting (One time)	1-600A	250 and 600V or less	50,000A	- Feeder circuits
J	Fast Acting and Time Delay	1-600A	600V or less	To 200,000A	Ip and I2t-Low (motor load small %) Feeder circuits Motor circuits
RK1	Fast Acting and Time Delay	1/10-600A	600V or less 250V or less	To 200,000A	I2t-Slightly > J Ip-Slightly > J Feeder circuits Motor circuits
RK5	Fast Acting and Time Delay	1/10-600A	600V or less 250V or less	To 200,000A	I2t- > RK-1 Ip- > RK-1 Feeder circuits Motor circuits
C (FORM II)	Moderate Delay	2-600A	600V or less	To 200,000A	I2t- < RK-5 Ip- < RK-5 Motor circuits
T	Fast Acting	1-600A	300 and 600V or less	To 200,000A	I2t-Low Ip-Low Non-motor loads
L	Fast Acting and Time Delay	601-5000A	600V or less	To 200,000A Ip-Low	I2t-Low motor loads Feeder circuits Motor circuits

① Fuse clips do not prohibit the use of Class H type fuse in switch.

② Refer to Siemens for single phase and DC horsepower requirements.

③ Ratings are based on UL test procedure.

④ Connector range applies to VB Switches only.

⑤ Not suitable for use in distribution space in main section.

Sentron® SMP Switchboards

Power and Distribution

Selection

Special Construction, Additions and Accessories

When required, special constructions or additions to standard Switchboards may be specified for all **factory-assembled** Power and Distribution Switchboards. Listed below are those available for Type SMP Switchboards.

1. Enclosure Type

38" Enclosure Types

Type 1
Type 2
Optional: Dripshield, Sprinklerproof

2. Wireway Options

24"W x 90"H x 12.75" Dp	Hinged Door
	Door Covers
24"W x 90"H x 25.5" Dp	Hinged Door
	Door Covers

3. Painted Finish

Touch-Up Paint (ASA61, Light Grey)
12 oz. aerosol can, Cat. #TUP-61

4. Miscellaneous Accessories

Nameplate - laminated and engraved

5. Bus-Link (One Set Per Panel)

Ampere Rating	Unit Space Occupied in MUD - Inches (mm)
400-1200	Consult Factory

6. Grounding of SMP Switchboard

Non-Insulated Equipment Ground Bus Including Ground Lug
Continuous Solid Copper Ground (optional)

7. Main Bus

Standard Main bus and Neutral bus are tin plated aluminum or silver finished copper (option).

8. Lugs

For Main Device and Neutral
For Main Breakers please see SpeedFax section #6
Neutral - please consult factory

9.SPД Modules

Sentron TPS3 05
100KA
150KA
200KA
250KA
300KA
Options: Surge Counter Remote Monitor

10. Circuit Breaker Accessories

Handle Blocking Device

Blocks handle in either the "ON" or "OFF" position. Available for:

Breaker Type	Cat. Number
BL, BLH, HBL, BQ, BQH, HBQ	ECQL1
All BQD, GB	BQDHBД
All QJ	QJHS1
All QR	HPLQR
All BQD, NGB, NGB2, HGB2, LGB2	BQDHBД
All ED	E2HBL
All FD	FD6HB1
All JD, LD, LMD	JD6HBL
All MD, ND, PD	MN6BL

Padlocking Device — Padlocks in "OFF" position. Available for:

Breaker Type	Cat. Number
BQ, BQH, BL, BLH, HBL	ECQLD3
One Pole BL, BLF, BE, BAF	ECPLD1
Two-Pole BL, BLF, BE	ECPLD2
All QJ	HL9419
All QR	HPLQR
All BQD, NGB, NGB2, HGB2, LGB2	BQDPLD
All ED	ED2HPL
All FD	FD6PL1
All JD, LD, LMD	JD6HPL
All MD, ND, PD, RD	MN6PLD

Handle Extensions - For replacement (one extension shipped with breaker)

Breaker Type	Cat. Number
All MD, ND, PD	EX11

Ground Fault Sensing Relay Kit Equipment Protection (30 mA)

For Use with Breaker Types	Number of Poles	Catalogue Number Description
ED4, ED6, HED4	1, 2, 3	See breaker section of this catalogue.

Shunt Trip on Main or Branch

Description	Cat. Number
BL, BQD6 (branch only) QJ2, QJ2H, QJH2, ED2, ED4, HED4 (branch only) All others through 1200A	See breaker portion of this catalogue

Sentron® SMP Switchboards

Specification

A. Scope

Furnish and install, as shown on the plans, a secondary distribution switchboard, as specified herein, for the system indicated below:

- 120/208V 3-phase 3-wire
 347/600V 4-wire
 600V

B. Configuration

The switchboard enclosure shall be of bolted construction:

- Type 1 indoor.
 Type 1 with dripshield (optional).
 Type 2.

Switchboard shall be bolted together to form one metal enclosed rigid switchboard. Switchboard shall include all protective devices and equipment as listed on drawings with necessary interconnections, instrumentation and control wiring.

All groups of control wires leaving the switchboard shall be provided with terminal blocks with suitable numbering strips. The switchboard shall have space or provisions for future expansion as noted on the plans. Switchboard shall be constructed and certified in accordance with CSA 22.2.31 standards and shall be Siemens type (SMP) or approved equal. Individual sections shall be front accessible, not less than 12.75" (324) deep, and the rear of all sections shall align.

Distribution sections shall be designed to accommodate the intermixing of Molded Case Breakers and Fusible Disconnects in the same distribution interior.

C. Bus Requirements

The bus shall be tin-finished aluminum silver-finished copper (option) of sufficient size to limit the temperature rise to 65°C. The bus shall be braced for 50,000 or 65,000 (option) amperes symmetrical and supported to withstand mechanical forces exerted during short circuit conditions when directly connected to a power source having the indicated available short circuit current.

D. Incoming Service

Overhead or Underground Service: Cable Entry

This section shall be bussed and sealable per local utility requirements.

Screw-type mechanical lugs, compression lugs to terminate, aluminum, copper cable, shall be _____ kcmil, and _____ cables per phase. Main breaker standard aluminum mechanical lugs suitable for aluminum or copper. (No wireway)

E. Metering Service Section

The service section shall be designed for the system parameters indicated in section "A" above. The metering service section shall have a Utility Metering compartment per utility requirements.

User metering as indicated below and as shown on plans.

Main (service) section:

Siemens Digital metering with remote display

- _____ current transformer(s)
 _____ /5 or suitable rating

SEM3 Embedded Metering

Ground fault Protection (3-Phase, 4-Wire):

Furnish and install on the service equipment and/or switchboard a Ground Fault protection system and indication equipment as specified herein and as shown on drawings in accordance with CEC Section 14-102.

All new Ground Fault Protection and Indication equipment shall be factory installed, wired and tested by the switchboard manufacturer.

F. Switchboard SMP Guide Specification

The complete switchboard shall be finished with light grey, ASA-61 paint.

Each switchboard main section shall have a metal nameplate permanently affixed to it, listing the following information:

- Name of manufacturer
- System voltage
- Ampacity
- Type
- Manufacturer's shop order number and date
- Each section of switchboard shall bear a CSA certification mark and a short circuit rating label.

The switchboard shall be per the arrangement below.

F1. Switchboard Type Panel-Mounted, Front Accessible.

Switchboard shall be of Siemens SMP type, or approved equal. Individual sections shall be front accessible, floor mounted rear supported, not less than 12.75" (324) deep, and rear, of all sections shall align. Incoming line termination, main device connection and all bolts used to join current-carrying parts shall be installed so as to permit servicing from the front only so that no rear access is required. The branch devices shall be front removable and panel mounted with line and load side connections front accessible.

G. Main Protective Devices

The main protective device, to be installed in the main device section, shall be as indicated below:

G1. Molded Case Circuit Breaker

Molded case circuit breaker shall be of the quick-make, quick-break, trip-free, (standard) (High Interrupting) (Current Limiting) (solid state Sensitrip III) type.

It shall be _____ frame (3-pole) (240V) (600V) breaker with a trip current rating of:

- 400A, 600A, 800A, 1000A[Ⓞ],
 1200 A[Ⓞ] of an interrupting capacity

of not less than _____ amperes RMS symmetrical at the system voltage. The following accessory options are to be included:

- Shunt trip
 Ground fault relay
 Long time (Sensitrip III only)
 Long time delay (Sensitrip III only)
 Short time (Sensitrip III only)
 Short time delay (Sensitrip III only)
 Integral ground fault (Sensitrip III only)
 Other _____ (list)

H. Branch Protective Devices (Select as necessary)

All molded case circuit breakers, and fusible disconnect units used as a protective device in a branch circuit will meet the requirements of the appropriate paragraph below

H1. Molded Case Circuit Breaker

Molded case circuit breakers shall be of quick-make, quick-break, trip-free (thermal magnetic type) (current limiting) (solid state) with frame, trip and voltage rating, either 2-pole or 3-pole, as indicated on the plans. All breakers shall have an interrupting capacity of not less than _____ amperes RMS symmetrical at the system voltage. All breakers shall be removable from the front of the switchboard without distributing adjacent units. The switchboard shall have space or provisions for future units shown on the plans.

H2. Current Limiting Circuit Breaker

Current limiting circuit breakers shall provide inverse time delay, instantaneous circuit protection, and also limit the let-through I^2t to a value less than I^2t of one-half cycle wave of the symmetrical prospective current without any fusible elements. Breakers shall have an interrupting capacity of not less than _____ ampere RMS symmetrical at the system voltage.

H3. Fusible Disconnect

Fusible disconnects shall be quick-make, quick-break units utilizing the double-break principle of circuit rupturing to minimize arcing and pitting and shall conform to the ratings shown on the plans.

Each disconnect shall have an individual door over the front, equipped with a voidable interlock that prevents the door from being opened when the switch is in the ON position unless the interlock is purposely defeated by activation of the voiding mechanism. All disconnects shall have externally operated handles. Disconnects shall be equipped with Class J (standard), Class R rejection type, Class L (standard), Class T fuse holders as indicated on the plans suitable for application on system with _____ amperes symmetrical available fault current.

[Ⓞ] Ground fault protection required, per CEC section 14-102 when "the current is 0 1000A at 600 volts."

Fault-Current Calculation on Low-Voltage AC Systems

In order to determine the maximum interrupting rate of the circuit breakers in a distribution system it is necessary to calculate the current which could flow under a three-phase bolted short circuit condition. For a three-phase system the maximum available fault current at the secondary side of the transformer can be obtained by use of the formula:

$$I_{sc} = \frac{kVA \times 100}{KV \times \sqrt{3} \times \% Z}$$

I_{sc} = Symmetrical RMS amperes of fault current.

kVA = Kilovolt-ampere rating of transformers.

KV = Secondary voltage in kilovolts.

%Z = Percent impedance of primary line and transformer.

Integrated Equipment Short Circuit Ratings

The term "Integrated Equipment Short Circuit Rating" refers to the application of series connected circuit breakers in a combination that allows some breakers to have lower individual interrupting ratings than the available fault current. This is permitted as long as the series combination has been tested and certified by UL & CSA.

Series ratings must be specified on order at time of entry. For more information on series ratings please consult your local Siemens sales representative.

Normal load and Fault Currents of Three Phase Transformers® (Table 18)

Transformer Rating 3 Phase Kva and impedance % ^①	Maximum Short-Circuit Kva Available from Primary System	208 Volts, 3 Phase			240 Volts, 3 Phase			480 Volts, 3 phase			600 Volts, 3 Phase							
		Rated Load Contin- uous Current, Amps	Short-Circuit Current RMS Symmetrical Amps.		Rated Load Contin- uous Current, Amps	Short-Circuit Current RMS Symmetrical Amps.		Rated Load Contin- uous Current, Amps	Short-Circuit Current RMS Symmetrical Amps.		Rated Load Contin- uous Current, Amps	Short-Circuit Current RMS Symmetrical Amps.						
			Trans- former Alone	50% Motor Load ②		Com- bined	Trans- former Alone ②		100% Motor Load	Com- bined		Trans- former Alone	100% Motor Load ②	Com- bined				
300 5%	50000	834	14900	1700	16600	722	12900	2900	15800	361	6400	1400	7800	289	5200	1200	6400	
	100000		15700		17400		13600		16500		6800		8200			5500		6700
	150000		16000		17700		13900		16800		6900		8300			5600		6800
	250000		16300		18000		14100		17000		7000		8400			5600		6800
	500000		16500		18200		14300		17200		7100		8500			5700		6900
	Unlimited		16700		18400		14400		17300		7200		8600			5800		7000
500 5%	50000	1388	21300	2800	25900	1203	20000	4800	24800	601	10000	2400	12400	481	8000	1900	9900	
	100000		25200		28000		21900		26700		10900		13300			8700		10600
	150000		26000		28800		22500		27300		11300		13700			9000		10900
	250000		26700		29500		23100		27900		11600		14000			9300		11200
	500000		27200		30000		23600		28400		11800		14200			9400		11300
	Unlimited		27800		30600		24100		28900		12000		14400			9600		11500
750 5.75%	50000	2080	28700	4200	32900	1804	24900	7200	32100	902	12400	3600	16000	722	10000	1900	12900	
	100000		32000		36200		27800		35000		13900		17500			11100		14000
	150000		33300		37500		28900		36100		14400		18000			11600		14500
	250000		34400		38600		29800		37000		14900		18500			11900		14800
	500000		35200		39400		30600		37800		15300		18900			12200		15100
	Unlimited		36200		40400		31400		38600		15700		19300			12600		15500
1000 5.75%	50000	2780	35900	5600	41500	2406	31000	9600	40600	1203	15500	4800	20300	962	12400	3900	16300	
	100000		41200		46800		35600		45200		17800		22600			14300		18200
	150000		43300		48900		37500		47100		18700		23500			15000		18900
	250000		45200		50800		39100		48700		19600		24400			15600		19500
	500000		46700		52300		40400		50000		20200		25000			16200		20100
	Unlimited		48300		53900		41800		51400		20900		25700			16700		20600

① Short circuit currents are calculated with impedances and kVA shown in this table.

② Short circuit current contributions are calculated on the basis of motor characteristics that will produce four times normal current. 50% motor load contribution is assumed for 208V and 100% motor load contribution is assumed for 240V, 480V and 600V.

③ This Table has been prepared to list the symmetrical RMS fault current which is available at the secondary terminals of the transformer.

Sentron® FCI, FCII Switchboards

General



Whether the design is for a 240V AC, 400 ampere system; a 600V AC, 6000 ampere system; or something in between, Siemens Sentron Switchboards should be considered. Every aspect of design has been aimed at improving layout convenience, reducing installation costs, and minimizing the impact and cost of system changes. These switchboards provide the rugged construction and service flexibility necessary in systems for industrial plants, hi-rise complexes, hospitals, and commercial buildings, and are built to NEMA and CSA, C22.2 #31 and EEMAC, G8.2 standards (up to 4000A).

90°C rated wireway.

The termination temperature for main incoming cables can be sized at 90°C for bussed pull sections.

CSA Certified to: CAN/CSA-22.2 No. 31-14

CSA File #LR 153416 (013076)

FCI Switchboard

- Main bus rated up to 2000 ampere.
- Branch Devices—panel mounted.
- Rear of all sections aligned so that switchboard can be installed against wall.
- Front connected and front accessible.
- Main devices—individually mounted or panel mounted. Molded Case Breaker: 400-1200 amps fixed.
- Quick-Make Quick-Break Fusible Switch: 800-1200 amps., fixed.
- Bolted Pressure Fusible Switch: 800-2000 amps., fixed.
- Low Voltage Power Circuit Breaker: 400-2000 amps fixed.
- Branch Devices: panel mounted only. Molded Case Breaker: 15-1200 amp., fixed.
- Quick-Make Quick-Break Fusible Switch: 30-1200 amps., fixed.

FCII Switchboard

- Main bus rated up to 6400 ampere.
 - Branch Devices rear connected individually mounted.
 - Front and rear of all sections align. Design for mounting away from wall.
 - Free Standing
 - Rear connected and rear accessible.
 - Main Devices—individually mounted. Molded Case Breaker: 400-1200 amps., fixed.
 - Quick-Make Quick-Break Vacu-Break Fusible Switch: 400-1200 amps., fixed.
 - Bolted Pressure Fusible Switch: 800-4000 amps., fixed.
 - Low Voltage Power Circuit Breaker: 800-5000 amps., fixed or drawout.
 - Branch Devices: individually mounted. Molded Case Breaker: 100-2000 amp., fixed (or plug in).
 - Quick-Make Quick-Break Fusible Switch: 100-1200 amp., fixed.
 - Bolted Pressure Switch: 800-4000 amp., fixed.
 - Low Voltage Power Circuit Breaker: 800-5000 amps., fixed, or drawout.
- * 6000 amps - Consult Sales Office

Sentron® FCI, FCII Switchboards

Construction Details

General

Versatility simplifies system design.

Service Sections

Typical switchboards consist of a service section, and one or more distribution sections. Service sections can be fed directly from overhead by either cable or bus duct.

When fed from underground, a separate pull section is usually added. The service section is then fed from the adjacent pull section.

Low Voltage Power circuit breakers and Vacu-Break Switches equipped for bottom feed will accept cable directly from underground into the service section

Choose bussed or non-bussed pull sections.

With FCI and FCII switchboards, a non-bussed pull section, or a cross-bussed pull section for underground feed can be selected. The unique cross-bussed section permits cable to be run straight from underground to the bus bars at the top of the section.

Non-bussed pull sections have openings for carrying the underground feed cables to the service section bus.

Main Section house a variety of equipment.

Utility Metering

In addition to the main disconnect, the main section usually contains utility metering provisions. "Cold" metering provisions (CT's on the load side of the main disconnect) are normally furnished. When utility metering is required, the CT's provided by the utility company will be mounted in a completely separate compartment. The compartment will be built to utility company standards, with hinged doors and provision for utility metering equipment.

User Metering

The main section often provides space for many user instrument requirements. Ammeters, voltmeters, and their associated selector switches can be mounted in the main section along with the main disconnect. Only if a very large instrument or an unusual number of instruments are required, would a separate section be required.

Main protective devices can be mounted individually so that they can be located quickly in an emergency. FC switchboards will accommodate different types of main protective devices. Selection depends on the characteristics of your individual electrical system.

Distribution Sections have expanded wiring room and exceptional accessibility.

Generous top and bottom gutters have been created by locating through-bus in the rear centre of the distribution section. No obstructions are less than 8" (203) above the floor, and no live bus bars are located less than 10" (254) off the floor. So there's plenty of room to run cables into the distribution section to make connections.

Standard bolted gutter covers give complete access to load conductors. As an option, hinged doors can be furnished where quick access to load connectors is desired.

Heavy channels form a rigid ring at the base and top of each section and heavy gauge structural members are used for the vertical corner posts so there's no encroachment of additional bracing into the top and bottom gutter areas.

To provide additional room for load cable routing where needed, pull box extensions are available in heights of 10 (254), 15 (381), 20 (508), 25 (635) and 30 (762) inches to mount on any standard distribution section.

Top plates on all sections are easily removed in the field for drilling, punching, and cutting conduit entry holes.

Distribution sections are designed with the future in mind.

Because all distribution sections can accommodate any combination of panel-mounted branch devices, including molded case circuit breakers, Vacu-Break® fusible switches, future system modifications are easier to handle without adding switchboard sections.

To make additional distribution sections easier to install when they are necessary the through-bus in each distribution section is extended, and the end is pre-drilled to accept splice plate bolts. To add a section to an existing FCI or FCII switchboard, set the new section flush against the side of the existing distribution section, and bolt together the bus bar splice plates.

Operating temperatures are in accordance with CSA Standard C22.2 #31 and UL Standard 891.

Bus bars are available in standard tin-finished aluminum or optional tin-finished copper. Standard bus is sized on the basis of heat rise criteria, in accordance with CSA C22.2 #31 and UL891. All bus bars are sized to limit heat rise to 65°C above an ambient temperature of 40°C.

Modular, bolted frame construction saves labour.

Modular construction of all service and distribution sections allows the switchboard to be designed into the building, rather than designing the building around the switchboard. FCI and FCII switchboards can even be continued around corners where necessary. Rigid, bolted frames can be shipped individually and moved into the building in sections that are easy to maneuver without special equipment, then quickly assembled in place.

Sentron® FCI, FCII Switchboards

FCI, FCII Switchboards

General

Service sections of the FCI and FCII accept a wide range of Sentron Molded Case Circuit Breakers, Vacu-Break® Fusible Switches, or WL Low Voltage Power Circuit Breakers as main disconnect devices.

The FCII switchboard is designed for special configurations. It can be equipped with incoming and outgoing busway connections, automatic transfer schemes and many other custom engineered applications. The FCII can also be supplied with special metering provisions, current transformers, potential transformers, panelboards and many other special features.

The distribution sections of all Sentron Switchboards are designed with improved wiring space and greater accessibility. They're also designed for easier installation and maintenance. Conveniently located through-bus creates useful wiring gutter space, and standard bolted gutter covers offer complete access to load conductors.

	FCI	FCII
Enclosure Type	Type 1 Type 2 Optional: Dripshield, Gaskets, Sprinklerproof	Type 1 Type 2 Optional: Dripshield, Gaskets, Sprinklerproof
Section Dimensions	38" W x 90" H x 28" Dp 20", 24", 32", 38" W Pull Box	20", 25", 32", 46", 54" W x 70", 90" H x 28", 38", 48", 58", Dp. 20", 24", 32", 38" W Pull Box
Volts	600V Max	600V Max
Amperes	400-2000A	400-5000A
Entry	Cable only	Cable, Duct Hydro Trough
Main Devices	MCCB 400-1200A VB 800-1200A Pringle 800-2000A WL ICCB 800-2000A	MCCB 400-1200A VB 400-1200A Pringle 800-4000A WL ACB 800-5000A (option) WL ICCB 800-5000A
Branch Devices	S5-22.5", 45", 65" CDP-7, P2 2-21" (MUD)	S5-22.5", 30", 45", 65", 75"
Metering Devices	Siemens Digital Metering with Remote Display	Siemens Digital Metering with Remote Display
	SEM3 Embedded Metering	SEM3 Embedded Metering other manufactures Analog VB Meter centres
Relays	Single Phase, GFR3, MGFR, GFR	All Types
Other Options		Transfer switch provisions, Power Transformer Connections, Dist. Transformer Provisions Bus Duct Connections

Distribution Sections

Switch-board Type	Access	Dimensions - Inches (mm)					
		Height		Width		Depth	
		Std.	Opt.	Std.	Opt.	Std.	Opt.
FCI	Rear	90	—	38	—	28 ^①	—
FCII	Rear	90	70	38	32 or 46	38 ^②	28, 48, or 58 ^②

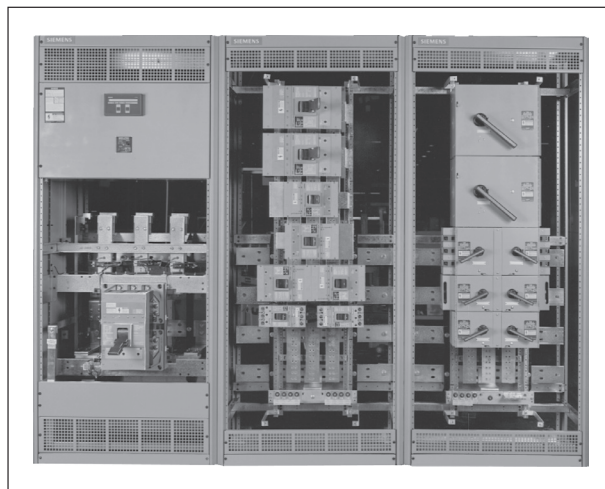

① Distribution section with two high 800 or 1200A Vacu-Break is 28 in. deep.

② Distribution section with two high bolted pressure switch is 38 in. deep minimum.

Sentron® FCI, FCII Switchboards

General/Guide

Even the front, back and side covers of the FCI and FCII are light, easy-to-handle, formed steel pieces that fit flush to the cabinet sides. No heavy, unwieldy flat plate must be removed to gain interior access.

Bus location saves wiring time.

All through-bus to adjoining sections are located in the rear centre of distribution section. This design provides large, unobstructed wiring gutters at the top and bottom of each section. Wiring takes less time, and costs less to install.

Splice plates are accessible from the front.

All splice plates can be bolted and unbolted from the front of the switchboard to make connection of adjacent sections easy. Each splice plate is attached by grade 5 bolts to assure solid joints between sections, and to maintain full bus ampacity through the splice joint.

To make installation and servicing of the splice plates easier, all phase and neutral through-busses are stacked one above the other, eliminating the need to stuff bolts in between bus bars that are stacked one behind the other in the same horizontal plane.

Two types of cable terminals are available.

Screw mechanical connectors (lugs) are provided as standard equipment on all devices. However, compression connectors are available as an option on all main lugs, main bolted pressure switches, main power circuit breakers, and main insulated case circuit breakers.

Sentron® FCI, FCII Switchboards

Specifications

General/Guide

A. Scope

Furnish and install, as shown on the plans, a secondary distribution switchboard, as specified herein, for the system indicated below:

- 120/208V 3-phase 3-wire
- 277/480V 4-wire
- 480V
- 347/600V
- 600V

B. Configuration

The switchboard enclosure shall be:

- Type 1 indoor of a bolted construction design.
- Sprinkler Proof Gasketed
- Type 2 Dripshield

Switchboard shall be of the required number of vertical sections bolted together to form one metal enclosed rigid switchboard. The sides, top and rear shall be covered with removable bolted code gauge steel plates. Switchboard shall include all protective devices and equipment as listed on drawings with necessary interconnections, instrumentation and control wiring. All groups of control wires leaving the switchboard shall be provided with terminal blocks with suitable numbering strips.

The switchboard shall have space or provisions for future expansion as noted on the plans.

Switchboard shall be constructed in accordance with the latest EEMAC G8.2 and CSA 22.2 #31 standards and shall be Siemens type (FCI) (FCII) or approved equal. Individual sections shall be front and rear accessible, not less than 28" deep, and the rear of all sections shall align.

Distribution sections shall be designed to accommodate the intermixing of Molded Case Breakers and fusible devices in the same distribution interior.

C. Bus Requirements

The bus shall be (tin-finished aluminum) (silver-flash copper) of sufficient size to limit the temperature rise to 65°C. The bus shall be braced for (50,000) (75,000) (100,000) (200,000) amperes symmetrical and supported to withstand mechanical forces exerted during short circuit conditions when directly connected to a power source having the indicated available short circuit current.

The through-bus on the end section shall be extended and pre-drilled to allow the addition of future sections with standard splice plates.

Grade 5 bolts will be used at bus joints.

D. Incoming Service

1. Underground Service:

To isolate incoming underground service conductors, an underground cable pull or auxiliary section shall be used. This section shall be of the non-bussed, bussed type and shall be sealable per local utility requirements, screw-type mechanical lugs, compression lugs to terminate, aluminum, copper cable, shall be furnished as detailed on the plans.

2. Overhead Service:

A. Cable Entry

screw-type mechanical lugs
 compression lugs to terminate
 aluminum copper cable shall be furnished as detailed on the plans. Where necessary provide top cable pull box which shall be sealable per local utility requirements.

B. Busway Entry

Switchboard to be fed by Siemens Bus duct copper, aluminum, ___ ampere as detailed on plans, and other sections of the specification. The switchboard manufacturer shall be responsible for coordination, proper phasing and internal bussing to the incoming busway.

C. Transformer Coupling

The switchboard shall be directly connected to the adjacent transformer section, including all necessary bus bars and flexible connectors.

E. Metering Service Section

The service section shall be designed for the system parameters indicated in section "A." The metering service section shall have a metering compartment per utility requirements, user metering as indicated below and as shown on plans.

Main bus:

- Voltmeter with _____ -phase transfer switch
- Ammeter, with _____ -phase transfer switch
- Digital metering
- _____ current transformer(s)
- _____ /5 or suitable rating
- _____ potential transformer(s), of suitable rating.
- SEM3 Embedded Metering (Main Breaker/Main Incoming)

Branch circuits:

- Ammeter(s), with _____ -phase transfer switch
- SEM3 Embedded Metering

Ground fault Protection:

Furnish and install on the service equipment and/or switchboard a Ground Fault protection system and indication equipment as specified herein and as shown on drawings in accordance with The Canadian Electrical Code Section 14-102.

All new Ground Fault Protection and Indication equipment shall be factory installed, wired and tested by the switchboard manufacturer.

F. Switchboards FCI, FCII Guide Specification

The complete switchboard shall be phosphatized and finished with light grey, ASA-61 paint.

Each switchboard section shall have a metal nameplate permanently affixed to it, listing the following information:

- Name of manufacturer
- System voltage
- Ampacity
- Type
- Manufacturer's shop order number and date
- Each section of switchboard shall bear a CSA listing mark and a short circuit rating label.
- The switchboard shall be per the arrangement below (Select 1 of ITEM F)

F1. Switchboard Type Panel-Mounted, Front Accessible.

Switchboard shall be of Siemens FCI type, or approved equal. Individual sections shall be front accessible, not less than 28" deep, and rear of all sections shall align. Incoming line termination, main device connection and all bolts used to join current-carrying parts shall be installed so as to permit servicing from the front only so that no rear access is required. The branch devices shall be front removable and panel mounted with line and load side connections front accessible.

F2. Switchboard Type Panel-Mounted Rear Accessible

Switchboard shall be of Siemens FCII type, or approved equal. Individual sections shall be front and rear accessible, not less than 38" deep, and both the front and rear of all sections shall align. The branch devices shall be front removable and panel mounted with line and load side connections front accessible. The bus and main device connections shall be rear accessible.

F3. Switchboard Type Individually Mounted, Rear Accessible (Fixed mounted devices).

Switchboard shall be of Siemens FCII type, or approved equal. All sections shall align front and rear. All disconnect devices, main and feeders, shall be mounted individually at the front of the switchboard and shall be rear accessible. The load terminals of each feeder device shall be extended by means of insulated bus bars through the bus compartment in to the rear cable compartment.

Optional

- barriers shall be provided between bus and cable compartment.
- barriers shall be provided between vertical sections.
- barriers shall be provided between devices and bus compartment.
- barriers shall be provided between individual devices.

F4. Switchboard Type Individually Mounted Rear Accessible (Drawout Power Circuit Breaker).

Switchboard shall be of Siemens FCII type or approved equal. All sections shall be aligned front and rear. Each vertical section forming part of switchboard lineup shall have one or more individual breakers or instrument compartments, a centralized main bus compartment and a rear cabling compartment. Drawout power circuit breakers shall be individually mounted in their own compartments. Metal barriers shall be provided at the sides and rear of each compartment and a horizontal metal barrier between breakers in the same vertical section. The breaker shall be accessible through a hinged metal door on each breaker compartment.

The drawout mechanism of power circuit breaker shall be such that it can be moved from connect through test to disconnect position without opening the door. In the "connect" position, both the

primary and secondary disconnects are engaged. In the "test" position, the primary disconnect terminals are disengaged; however, the secondary disconnects are maintained to permit the operation of the circuit breaker. In the "disconnect" position, the primary and secondary disconnects are disengaged and separated a safe distance from the corresponding stationary terminals. In the "fully withdrawn" position, both primary and secondary contacts are disconnected and the circuit breaker may be inspected as it can be removed for more complete accessibility.

The load side of each feeder breaker shall have bus bars extending from the rear of the primary disconnect through the bus compartment in to the rear cable compartment.

Optional

- barriers shall be provided between bus and cable compartment.
- barriers shall be provided between vertical sections.
- barriers shall be provided between devices and bus compartment.
- barriers shall be provided between individual devices.

G. Main Protective Devices (Select one of Item G)

The main protective device, to be installed in the main device section, shall be as indicated below:

G1. Molded Case Circuit Breaker

Molded case circuit breaker shall be of the quick-make, quick-break, trip-free, (standard) (High Interrupting) (Current Limiting) (solid state Sensitrip III) type. It shall be _____ frame (2-pole) (3-pole) 600-volt breaker with a trip current rating of:

- | | |
|---------------------------------|---------------------------------|
| <input type="checkbox"/> 400 A | <input type="checkbox"/> 1600 A |
| <input type="checkbox"/> 600 A | <input type="checkbox"/> 2000 A |
| <input type="checkbox"/> 800 A | |
| <input type="checkbox"/> 1000 A | |
| <input type="checkbox"/> 1200 A | |

of an interrupting capacity of not less than _____ amperes RMS symmetrical at the system voltage.

The following accessory features are to be included:

- Shunt trip
- Electrical Operator
- Ground fault relay
- Long time (Sensitrip III only)
- Long time delay (Sensitrip III only)
- Short time (Sensitrip III only)
- Short time delay (Sensitrip III only)
- Integral ground fault (Sensitrip III only)
- Other _____ (list)

G2. Fusible Switch

Fusible switch of the quick-make, quick-break type. It shall be a (2-pole) (3-pole) (240V) (600V) Vacu-Break unit with a continuous current rating of (400) (600) (800) (1200) amperes and with _____ ampere Class _____ fuses, suitable for application on a system with _____ amperes symmetrical available fault current.

G3. Bolted Pressure Switch

Bolted pressure switch of the quick-make, quick-break type. It shall be a (2-pole) (3-pole) (240V) (600V) unit with a continuous current rating of:

- | | |
|---------------------------------|----------------------------------|
| <input type="checkbox"/> 800 A | <input type="checkbox"/> 2500 A |
| <input type="checkbox"/> 1200 A | <input type="checkbox"/> 3000 A |
| <input type="checkbox"/> 1600 A | <input type="checkbox"/> 4000 A |
| <input type="checkbox"/> 2000 A | <input type="checkbox"/> _____ A |

and with _____ ampere Class L fuses suitable for application on a system with _____ amperes symmetrical available fault current.

The following accessory features are to be included:

- Shunt trip
- Ground fault relay
- Other _____ (list)

G4. Insulated Case Circuit Breaker

Insulated case circuit breaker with a stationary frame. Frame size to be _____ ampere 3-pole, 600-volt with a trip current rating of:

- | | |
|---------------------------------|----------------------------------|
| <input type="checkbox"/> 400 A | <input type="checkbox"/> 2000 A |
| <input type="checkbox"/> 600 A | <input type="checkbox"/> 2500 A |
| <input type="checkbox"/> 800 A | <input type="checkbox"/> 3000 A |
| <input type="checkbox"/> 1000 A | <input type="checkbox"/> _____ A |
| <input type="checkbox"/> 1200 A | |
| <input type="checkbox"/> 1600 A | |

It shall be a manually operated breaker with a solid state trip device, and an interrupting capacity of not less than _____ amperes RMS symmetrical at the system voltage.

The following accessory features are to be included:

- Short time delay
- Integral ground fault trip
- Fault trip indicator
- Other _____ (list)

G5. Low Voltage Power Circuit Breaker

Low voltage power circuit breaker with a (stationary) (drawout) frame and a current rating of:

- | | |
|---------------------------------|----------------------------------|
| <input type="checkbox"/> 800 A | <input type="checkbox"/> 3200 A |
| <input type="checkbox"/> 1600 A | <input type="checkbox"/> 4000 A |
| <input type="checkbox"/> 2000 A | <input type="checkbox"/> _____ A |

It shall be (manually) (electrically) operated power circuit breaker with a Electronic Trip Unit and an interrupting capacity of _____ amperes RMS symmetrical at the system voltage.

The following accessory features are to be included:

- Short time delay
- Integral ground fault trip
- Fault trip indicator
- Other _____ (list)

H. Branch Protective Devices (Select as necessary)

All molded case circuit breakers, fusible switches, insulated case circuit breakers, bolted pressure switches, low voltage power circuit breaker, and/or motor starter units used as a protective device in a branch circuit will meet the requirements of the appropriate paragraph below.

H1. Molded Case Circuit Breaker

Molded case circuit breakers shall be of quick-make, quick-break, trip-free (thermal magnetic type) (current limiting) (solid state) with frame, trip and voltage rating, either 2-pole or 3-pole, as indicated on the plans. All breakers shall have an interrupting capacity of not less than _____ amperes RMS symmetrical at the system voltage. All breakers shall be removable from the front of the

switchboard without distributing adjacent units. The switchboard shall have space or provisions for future units shown on the plans.

H2. Current Limiting Circuit Breaker

Current limiting circuit breakers shall provide inverse time delay, instantaneous circuit protection, and also limit the let-through I^2t to a value less than I^2t of one-half cycle wave of the symmetrical prospective current without any fusible elements. Breakers shall have an interrupting capacity of not less than _____ ampere RMS symmetrical at the system voltage.

H3. Fusible Switch

Fusible switches shall be quick-make, quick-break units utilizing the double-break principle of circuit rupturing to minimize arcing and pitting and shall conform to the ratings shown on the plans.

Each switch shall have an individual door over the front, equipped with a voidable interlock that prevents the door from being opened when the switch is in the ON position unless the interlock is purposely defeated by activation of the voiding mechanism. All switches shall have externally operated handles. Switches shall be equipped with (Class R rejection type) fuse holders and Class (J) (R) or (L) fuses of ampere rating and type as indicated on the plans suitable for application on system with _____ amperes symmetrical available fault current.

H4. Bolted Pressure Switch

Each bolted pressure switch shall be the quick-make, quick-break type, equipped with Class L fuses suitable for application on a system with _____ amperes symmetrical available fault current. Ampere rating to be as shown on the plans.

H5. Insulated Case Circuit Breaker

FCII Switchboards only
Each insulated case circuit breaker shall be manually operated with solid state trip device. Frame sizes and trip ratings to be as shown on the plans. All breakers to have an interrupting capacity of not less than _____ amperes symmetrical at the rated voltage.

H6. Low Voltage Power Air Circuit Breaker

FCII Switchboards only
Each low voltage power air circuit breaker shall be (stationary mounted) (drawout mounted) stored energy type, trip free, (manually operated) (electrically operated) with solid-state trip device. Frame sizes and trip ratings to be as shown on the plans. All breakers to have an interrupting capacity of no less than _____ amperes symmetrical at the rated voltage.

Sentron® SMP, FCI, FCI Switchboards

Modifications and Additions Replacements for Circuit Breakers and Fusible Switches^② Selection

Connecting Strap Kits for use with Circuit Breakers in Distribution Sections^{④⑧⑩} (Table 15)

Breaker Type	Catalogue Number	Unit Height	Mounting
BQ, BQH, HB, BL, BLH, HBL	6BL2C ^{②③⑤}	3.75" (95)	Twin
NGB2, HGB2, LGB2	SGB2D	3.75" (95)	Twin
ED2, ED4, ED6, HED4	6E62 ^{①②③}	3.75" (95)	Twin
CED6	6CLE2 ^①	3.75" (95)	Twin
NDG, LDG	SDGD	5" (127)	Twin
QJ2, QJH2, QJ2H	6QJ2 ^①	5" (127)	Twin
QR2, QR2H, HQR2, HQR2H	6QR2 ^{①②}	5" (127)	Twin
FXD6, FD6, HFD6, HHFD6	6F62 ^①	5" (127)	Twin
NFG, LFG	SFGD	5" (127)	Twin
CFD6	6CLF1C ^③	5" (127)	Single
JXD6, JD6, HJD6, HHJD6	6JJ62 ^①	8.75" (222)	Twin
NJG, LJG	SJG1D	6.25" (159)	Single
NJG, LJG	SJG2D	6.25" (159)	Twin
CJD6, SCJD6	6CLJ1C ^⑤	8.75" (222)	Single
LXD6, LD6, HLD6, HLD6, SLD6, SHLD6	6LL61C ^⑤	8.75" (222)	Single
CLD6, SCJD6	6CLL1C ^⑤	8.75" (222)	Single
SCLD6	6SCL61C ^⑤	8.75" (222)	Single
MXD6, MD6, HMD6, CMD6, SHMD6, SCMD6	6M61C ^⑤	10" (254)	Single
NXD6, ND6, HND6, CND6, SHND6, SCND6	6N61C ^⑤	10" (254)	Single

Connecting Strap Kits for use with VB, VK or HCP Switches in Distribution Sections^{④⑧⑩} (Table 16)

Rating Amperes	VB Switch Cat. No.	VK Switch Cat. No.	HCP Switch Cat. No.
30/30	N/A	VK6-57	N/A
60/60	VB6-71	VK6-57	N/A
100/100	N/A	VK6-58	N/A
100	VB6-71	N/A	N/A
200/200	N/A	VK6-72	N/A
200	VB6-71	N/A	N/A
400-600	VB6-150	N/A	N/A
800-1200	N/A	N/A	F6162DCAN

Metering Switch for FCI Metering Switchboards^⑩

Ampere Rating	600V Metering Switch (c/w Meter Socket)	Height-Inches (mm)
30/30	V7E3611JMC7	10" (254)
60/60	V7E3622JMC7	10" (254)
100/100	V7E3633JMC7	10" (254)
200	V7F3604JMC7	17.5" (444.5)

Blank Filler Plates for Distribution Switch or Circuit Breaker^④ (Table 17)

For use with SMP Switchboards.	
Height - Inches (mm)	Catalogue Number
1.25" (32)	6FPB01
2.50" (64)	6FPB02
3.75" (95)	6FPB03
5.00" (127)	6FPB05
10.00" (254)	6FPB10
15.00" (381)	6FPB15

Shunt Trip on Main or Branch

Description	Cat. Number
BL, BQD6 (branch only) QJ2, QJ2H, QJH2, ED2, ED4, HED4 (branch only) All others through 1200A	See breaker portion of this catalogue

Circuit Breaker Accessories

Handle Blocking Device
Blocks handle in either the "ON" or "OFF" position. Available for:

Breaker Type	Cat. Number
BL, BLH, HBL, BQ, BQH, HBO	ECQL1
All BQD, GB	BQDHB
All QJ	QJHS1
All QR	HPLQR
All BQD, NGB, NGB2, HGB2, LGB2	BQDHB
All ED	E2HBL
All FD	FD6HB1
All JD, LD, LMD	JD6HBL
All MD, ND, PD	MN6BL

Padlocking Device – Padlocks in "OFF" position. Available for:

Breaker Type	Cat. Number
BQ, BQH, BL, BLH, HBL	ECQLD3
One Pole BL, BLF, BE, BAF	ECPLD1
Two-Pole BL, BLF, BE	ECPLD2
All QJ	HL9419
All QR	HPLQR
All BQD, NGB, NGB2, HGB2, LGB2	BQDPLD
All ED	ED2HPL
All FD	FD6PL1
All JD, LD, LMD	JD6HPL
All MD, ND, PD, RD	MN6PLD

Handle Extensions - For replacement (one extension shipped with breaker)

Breaker Type	Cat. Number
All MD, ND, PD	EX11

Ground Fault Sensing Relay Kit Equipment Protection (30 mA)

For Use with Breaker Types	Number of Poles	Catalogue Number Description
ED4, ED6, HED4	1, 2, 3	See breaker section of this catalogue.

① These are aluminum connectors. If copper is required please add suffix C.

② 3.75" (95) plate accommodates six 1-pole breakers.

③ 10" (254) plate accommodates eighteen 1-pole breakers.

④ Connector kits also accommodate S5, F2, CDP6 Panelboards, FCRS, FCI and FCI distribution interiors or CDP6/SPP6 Series Panels.

⑤ These connectors are available in copper only.

⑥ Blank (Circuit Breaker or Switch) Cover Plates can also be used in FCI and FCI distribution interiors or CDP6/SPP6 Series Panels.

⑦ Please refer to the respective section in the catalogue for detailed circuit breaker or switch information.

⑧ Mounting kits include connector straps and covers (breakers or switches are not included).

⑨ Refer to Siemens for units equipped with auxiliary switches.

⑩ Connecting strap kits include connecting straps, hardwares, and cover plates for switchboards and power panels. Breakers and switches to be ordered separately.

⑪ Metering switch kits include metering switches, cover plates, connecting straps, and hardware.

⑫ QR filler plates only: 6QR2FK

Sentron® FCI, FCI Switchboards

Protective Devices - Sentron™ Molded Case Circuit Breakers

General

Standard

Breakers are designed for commercial, industrial, institutional and other heavy duty applications. They are rated up to 600V ac and 250V dc. Their interrupting ratings are higher than normal duty breakers.

High Interrupting

Breakers are designed for heavy duty applications where the interrupting requirements exceed the ratings of heavy duty breakers. They are rated up to 600V ac and 250V dc.

Branch Circuit Breakers

Current Limiting

Breakers are molded case breakers that incorporate the exclusive I-TE blow-apart interruption principle. They meet the US-NEC requirements for current-limiting breakers. Current-limiting circuit breakers can limit the let-through I^2t to a value less than the I^2t of one-half cycle wave of the symmetrical prospective current without any fusible elements when operating within their current-limiting range.

Breaker Frame Rating	Trip Type	Breaker Type	Poles	Trip Amperage	Mounting Height Inches (mm)			Max IC Rating (kA)		
					Single	Twin	Gutter®	240V	480V	600V
100	Thermal Magnetic	BL	1, 2, 3	15, 20, 25, 30, 40, 50, 60, 70, 80, 90, 100	—	3.75 (95)②③	14 (356)	10	—	—
		BLH	1, 2, 3	15, 20, 25, 30, 40, 50, 60, 70, 80, 90, 100	—	3.75 (95)②③	14 (356)	22	—	—
		HBL	1, 2, 3	15, 20, 25, 30, 40, 50, 60, 70, 80, 90, 100	—	3.75 (95)②③	14 (356)	65	—	—
		BQD6®	1, 2, 3	15, 20, 30, 40, 50, 60, 70	—	3.75 (95)②③	14 (356)	65	—	10
	Ground Fault Circuit Interrupter	BLE (GFCI)	1, 2	15, 20, 30, 40, 50, 60	—	3.75 (95)②	14 (356)	10	—	—
		BLF (GFCI)	1, 2	15, 20, 30, 40, 50, 60	—	3.75 (95)②	14 (356)	10	—	—
Arc Fault Circuit Interrupter	BLHF (GFCI)	1, 2	15, 20, 30, 40, 50, 60	—	3.75 (95)②	14 (356)	22	—	—	
	BAF (AFCI)	1	15, 20	—	3.75 (95)②	14 (356)	10	—	—	
BAFH (AFCI)	1	15, 20	—	3.75 (95)②	14 (356)	22	—	—		
	125	Thermal Magnetic	ED2	1, 2, 3	15, 20, 30, 40, 50, 60, 70, 80, 90, 100	3.75 (95)②③	3.75 (95)②③	10 (254)	10	—
ED4			1, 2, 3	15, 20, 30, 40, 50, 60, 70, 80, 90, 100, 110, 125	3.75 (95)②③	3.75 (95)②③	10 (254)	65	18	—
ED6			1, 2, 3	15, 20, 30, 40, 50, 60, 70, 80, 90, 100, 110, 125	3.75 (95)②③	3.75 (95)②③	10 (254)	100	18	18
HED4			1, 2, 3	15, 20, 30, 40, 50, 60, 70, 80, 90, 100, 110, 125	3.75 (95)②③	3.75 (95)②③	10 (254)	100	65	30
CED6			2, 3	15, 20, 30, 40, 50, 60, 70, 80, 90, 100, 110, 125	3.75 (95)②③	3.75 (95)③	7.61 (193)	200	200	100
HEB			2, 3	15, 20, 30, 40, 50, 60, 70, 80, 90, 100, 110, 125	—	3.75 (95)②③	11.62 (295)	100	65	25
NGB			1, 2, 3	15, 20, 25, 30, 40, 50, 60, 70, 80, 90, 100, 110, 125	—	3.75 (95)②③	13.98 (355)	100	25	14
NGB2			1, 2, 3	15, 20, 25, 30, 40, 50, 60, 70, 80, 90, 100, 110, 125	—	3.75 (95)②③	13.98 (355)	100	25	14
HGB2			1, 2, 3	15, 20, 25, 30, 40, 50, 60, 70, 80, 90, 100, 110, 125	—	3.75 (95)②③	13.98 (355)	100	35	22
LGB2			1, 2, 3	15, 20, 25, 30, 40, 50, 60, 70, 80, 90, 100, 110, 125	—	3.75 (95)②③	13.98 (355)	100	65	25
150			Electronic (Solid State)	NDG	3	60, 100, 150	—	5 (127)	10.9 (276)	65
	LDG	3		60, 100, 150	—	5 (127)	10.9 (276)	200	100	18
225	Thermal Magnetic	QJ2	2, 3	60, 70, 80, 90, 100, 110, 125, 150, 175, 200, 225	5" (127)	5 (127)	8.75 (222)	10	—	—
		QJH2	2, 3	60, 70, 80, 90, 100, 110, 125, 150, 175, 200, 225	5" (127)	5 (127)	8.75 (222)	22	—	—
		QJ2H	2, 3	60, 70, 80, 90, 100, 110, 125, 150, 175, 200, 225	5" (127)	5 (127)	8.75 (222)	42	—	—
		QR2	2, 3	100, 110, 125, 150, 175, 200, 225	5" (127)	5 (127)	8.75 (222)	10	—	—
		QRH2	2, 3	100, 110, 125, 150, 175, 200, 225	5" (127)	5 (127)	8.75 (222)	25	—	—
		HQR2	2, 3	100, 110, 125, 150, 175, 200, 225	5" (127)	5 (127)	8.75 (222)	65	—	—
		HQR2H	2, 3	100, 110, 125, 150, 175, 200, 225	5" (127)	5 (127)	8.75 (222)	100	—	—
		FXD6, FD6	2, 3	70, 80, 90, 100, 110, 125, 150, 175, 200, 225, 250	5" (127)	5 (127)	8.25 (210)	65	35	22
HFD6	2, 3	70, 80, 90, 100, 110, 125, 150, 175, 200, 225, 250	5" (127)	5 (127)	8.25 (210)	100	65	25		
CFD6	2, 3	70, 80, 90, 100, 110, 125, 150, 175, 200, 225, 250	—	5 (127)	11.76 (299)	200	200	100		
250	Electronic (Solid State)	NFG	3	100, 150, 250	—	5 (127)	10.9 (276)	65	35	18
		LFG	3	100, 150, 250	—	5 (127)	10.9 (276)	200	100	25
400	Thermal Magnetic	JXD6, JD6	2, 3	200, 225, 250, 300, 350, 400	8.75 (222)	8.75 (222)	7.92 (201)	65	35	25
		HJD6	2, 3	200, 225, 250, 300, 350, 400	8.75 (222)	8.75 (222)	7.92 (201)	100	65	35
		HHJD6	2, 3	200, 225, 250, 300, 350, 400	8.75 (222)	8.75 (222)	7.92 (201)	200	100	50
		CJD6	2, 3	200, 225, 250, 300, 350, 400	8.75 (222)	—	12 (305)	200	150	100
	Electronic (Solid State)	SJD6	3	200, 300, 400	8.75 (222)	—	13.42 (341)	65	35	25
		SHJD6	3	200, 300, 400	8.75 (222)	—	13.42 (341)	100	65	35
		SCJD6	3	200, 300, 400	8.75 (222)	—	12 (305)	200	150	100
		NJG	3	250, 400	6.25 (159)	6.25 (159)	8 (203)	65	35	25
LJG	3	250, 400	6.25 (159)	6.25 (159)	8 (203)	200	100	25		
600	Thermal Magnetic	LXD6	2, 3	450, 500, 600	8.75 (222)	—	13.42 (341)	65	35	25
		LD6	2, 3	250, 300, 350, 400, 450, 500, 600	8.75 (222)	—	13.42 (341)	65	35	25
		HLD6	2, 3	250, 300, 350, 400, 450, 500, 600	8.75 (222)	—	13.42 (341)	100	65	35
		HHL6	2, 3	250, 300, 350, 400, 450, 500, 600	8.75 (222)	—	13.42 (341)	200	100	50
	CLD6	2, 3	450, 500, 600	8.75 (222)	—	12 (305)	200	150	100	
	Electronic (Solid State)	SLD6	3	300, 400, 500, 600	8.75 (222)	—	13.42 (341)	65	35	25
SHLD6		3	300, 400, 500, 600	8.75 (222)	—	13.42 (341)	100	65	35	
SCLD6	3	300, 400, 500, 600	8.75 (222)	—	12 (305)	200	150	100		
800	Thermal Magnetic	LMXD6, LMD6	2, 3	500, 600, 700, 800	8.75 (222)	—	13 (330)	65	50	25
		HLMXD6, HLMD6	2, 3	500, 600, 700, 800	8.75 (222)	—	13 (330)	100	65	50
		MXD6	2, 3	500, 600, 700, 800	10 (254)	—	13 (330)	65	50	25
		MD6	2, 3	500, 600, 700, 800	10 (254)	—	13 (330)	65	50	25
		HMD6	2, 3	500, 600, 700, 800	10 (254)	—	13 (330)	100	65	50
		CMD6	2, 3	500, 600, 700, 800	10 (254)	—	13 (330)	200	100	65
	Electronic (Solid State)	SMD6	3	600, 700, 800	10 (254)	—	12 (305)	65	50	25
		SHMD6	3	600, 700, 800	10 (254)	—	12 (305)	100	65	50
		SCMD6-A	3	600, 700, 800	10 (254)	—	12 (305)	200	100	65
		NXD6	2, 3	800, 900, 1000, 1200	10 (254)	—	13 (330)	65	50	25
1200	Thermal Magnetic	ND6	2, 3	800, 900, 1000, 1200	10 (254)	—	13 (330)	65	50	25
		HND6	2, 3	800, 900, 1000, 1200	10 (254)	—	13 (330)	100	65	50
		CND6	2, 3	800, 900, 1000, 1200	10 (254)	—	13 (330)	200	100	65
		SHND6	3	800, 1000, 1200	10 (254)	—	12 (305)	65	50	25
	Electronic (Solid State)	SHND6	3	800, 1000, 1200	10 (254)	—	12 (305)	100	65	50
		SCND6	3	800, 1000, 1200	10 (254)	—	12 (305)	200	100	65

① Space includes housing frame plate with blank cover plate. Provision includes all necessary mounting hardware, less circuit breaker, and includes housing frame cover plate with breaker handle opening.

② 1 to 6 poles may be mounted in 3.75" (95) of unit space

③ Accessories such as shunt trips on three pole breakers require 6.25" (159) of unit space.

④ Ground fault is not available on branch Sensitrip breakers.

⑤ Also 10kA at 600Y/347 Volts.

⑥ Refer to Table 5 for layout dimensions.

Sentron® FCI, FCI Switchboards

Protective Devices - Solid State Sensitrip™ Molded Case Circuit Breakers

General

Digital Electronics Allow Shaping of Time Current Curves

For the ultimate in application flexibility, Sentron Series with Sensitrip electronic tripping incorporate solid state capabilities that allow even more precise control of overload current. These breakers actually accept a programmed time current characteristic curve that will meet any protective requirements.

These circuit breakers offer adjustable settings for such functions as continuous current, instantaneous trip points, short-time delay pickup, ground fault pickups and ground fault time delays. That means superior repeatable accuracy, adjustability and precision.

True RMS sensing, the ability to measure the actual shape of the current waveform, ensures that the Sensitrip III line will perform reliably, time and time again. Sensitrip digital circuit breakers have proven performance in using this ability to bring trip/don't trip margins closer than ever before.

A microcomputer in Sensitrip digital circuit breakers senses true RMS current by sampling the current waveform 41.7 times per cycle. It "reads" this data and compares it to what has been pre-programmed into the circuit breaker's operating logic. Once this data is acquired, the microcomputer informs the circuit breaker when to trip.

The true RMS ability of Sensitrip III helps ensure that nuisance tripping is minimized.

Accuracy of ±5% means a finely tuned electrical protection scheme. Sensitrip III solid state circuit breakers give precise control for a wide variety of application requirements.

Accessories for Sentron Series Molded Case Circuit Breakers

- Alarm Switch: for remote indication and/or pilot device operation when breaker is tripped automatically.
- Shunt Trip (electric open-manual close): for remote tripping of breaker. Includes cut-off switch. Specify Control Voltage.
- Undervoltage Trip: automatically trips breaker when voltage is reduced 35%-70% of coil rating. Specify Control Voltage.
- Auxiliary Switch: 1A and 1B, 2A and 2B, etc.
- Telemand motor operator (electric open and close): F-250 Amp, J-400 Amp, L-600 Amp, M-800 Amp, N-1200 Amp. Operating Voltage: 120V ac.
- Ground fault relay (requires shunt trip).

Sensitrip III

Frame Size (Amps)	Breaker		Sensitrip III Indicator	Suffix Letter	Maximum Interrupting Capacity (Sym, RMS, Amps)		
	Frame	Type			240V ac	480V ac	600V ac
250	SFD6	Standard	9	G, NT, NGT	65,000	35,000	22,000
	SHFD6	Hi-Ic	9	G, NT, NGT	100,000	65,000	25,000
	SCFD6	C.L.	9	G, NT, NGT	200,000	200,000	100,000
400	SJD6	Standard	9	G, NT, NGT	65,000	35,000	25,000
	SHJD6	Hi-Ic	9	G, NT, NGT	100,000	65,000	35,000
	SCJD6	C.L.	9	G, NT, NGT	200,000	150,000	100,000
600	SLD6	Standard	9	G, NT, NGT	65,000	35,000	25,000
	SHLD6	Hi-Ic	9	G, NT, NGT	100,000	65,000	35,000
	SCLD6	C.L.	9	G, NT, NGT	200,000	150,000	100,000
800	SMD6	Standard	9	G, NT, NGT ^①	65,000	50,000	25,000
	SHMD6	Hi-Ic	9	G, NT, NGT ^①	100,000	65,000	50,000
	SCMD6	C.L.	9	G, NT, NGT ^①	200,000	100,000	65,000
1200	SND6	Standard	9	G, NT, NGT ^①	65,000	50,000	25,000
	SHND6	Hi-Ic	9	G, NT, NGT ^①	100,000	65,000	50,000
	SCND6	C.L.	9	G, NT, NGT ^①	200,000	100,000	65,000

Suffix Letter Code	Continuous Current Adjustment (standard)	Long Time Delay (standard)	Adjustable Instantaneous Setting	Short Time Pick-Up	Short Time Delay	Short Time I ² T Pick-Up	Ground Fault Pick-Up	Ground Fault Delay
No Letter	X	X	X	-	-	-	-	-
Letter-G	X	X	X	-	-	-	X	X
Letter-NT	X	X	X ^②	X	X	X	-	-
Letter-NGT	X	X	X ^②	X	X	X	X	X

Frame Size (Amps)	Sensor Rating (In)	Long Time (I _R)		Instantaneous		Short Time		Ground Fault		
		Pick-up I _R = % x I _N	Delay Sec. select 6 x I _R	Pick up x I _N	Pick up x I _R	Delay Sec.		Pick up I _R = % x I _N	Delay Sec. I ² T	
						Stnd	I ² T			
250	150, 250	.20, .35, .50, .60	6, 30	1, 2, 3, 4, 5 ^② , 6, 7, 8, 9, 10	2, 4, 7, 10 ^②	.05	.05	.20, .30, .40, .55, .70	.1	
		.70, .80, .90, 1.00				.10	at 6 x I _R			.2
						.20				.4
400	200, 300, 400	.20, .30, .40, .50	3, 25	1, 2, 3, 4, 5, 6, 7, 8, 9, 10	2, 4, 7, 10	.05	.05	.20, .25, .30, .40, .55, .70	.1	
		.65, .80, .90, 1.00				.10	at 6 x I _R			.2
						.20				.4
600	300, 400, 500, 600	.20, .30, .40, .50	3, 25	1, 2, 3, 4, 5, 6, 7, 8, 9, 10	2, 4, 7, 10	.05	.05	.20, .25, .30, .40, .55, .70	.1	
		.65, .80, .90, 1.00				.10	at 6 x I _R			.2
						.20				.4
800	600, 700, 800	.20, .25, .30, .40	2.2, 4, 7, 12	1, 2, 3, 4, 5, 6, 7, 8, 9, 10	2, 3, 4, 5, 6, 7, 8, 9, 10, off	.05	.18	.20, .25, .30, .40, .55, .70	.1	
		.50, .65, .70, .80, .90, 1.00				.10	.22			.2
						.20	.28			.4
1200	800, 1000, 1200	.20, .25, .30, .40	2.2, 4, 7, 12	1, 2, 3, 4, 5, 6, 7, 8, 9, 10	2, 3, 4, 5, 6, 7, 8, 9, 10, off	.05	.18	.20, .25, .30, .40, .55, .70	.1	
		.50, .65, .70, .80, .90, 1.00				.10	.22			.2
						.20	.28			.4

① For 100% rated circuit breaker, add the suffix "H" to the catalogue number.

② For SFD6, SHFD6 and SCFD6 frames, the instantaneous trip will be fixed.

11 SWITCHBOARDS

Sentron® FCI, FCI Switchboards

Protective Devices - Fusible Switches

General

VK and VB (Vacu-Break) Fusible Switches

All VK and Vacu-Break fusible switches include voidable cover interlock; quick-make, quick-break operation; positive ON-OFF action; padlockable (at ON or OFF) handle design; Vacu-Break arc control (i.e., enclosed arc chamber, double-break magnetic arc blowout); clampmatic pressure spring force on closed contacts; spring-reinforced fuse holders. The VK switch is a true visible contact design.

Accessory devices and modifications available for 250-volt switches (30 amps to 600 amps): Class R and class J rejection type fuse holders are available for all units. For 600-volt switches (30 amps to 600 amps): Class R rejection type fuse holders, Class J fuse holders; (100 amps to 600 amps) Class T fuse holders.

Bolted Pressure Switches

These switches are suitable for use on systems capable of delivering fault current up to 200,000 amps symmetrical RMS when equipped with Class L fuses. All bolted pressure switches include fuse door interlock; quick-make, quick-break operation; bolted pressure force on closed contact; padlockable (in the "open" position only) handle.

Accessories and modifications available: shunt trip (electrical open-manual close). 120V ac standard control voltage: electrical operator (electrical open and close), specify system voltage; ground fault relay (requires shunt trip); blown fuse trip (switch opens when any one fuse blows—requires shunt trip); blown fuse indicating lights; phase failure relay with capacitor trip (detects failure of any one phase and opens switch—requires shunt trip) specify system voltage; auxiliary contacts.

CSA Fuse Classes

Class		Amperes	Volts (AC)	Interrupting Ratings	I _{2t} , I _p (Let-Thru)	Circuits
H	Standard Code	1-600A	250 and 600V or less	10,000A	—	Less than 10,000A available
K ^①	Fast Acting (One time)	1-600A	250 and 600V or less	50,000A	—	Feeder circuits
J	Fast Acting and Time Delay	1-600A	600V or less	To 200,000A	I _p and I _{2t} -Low (motor load small %)	Feeder circuits Motor circuits
RK1	Fast Acting and Time Delay	1/10-600A	600V or less 250V or less	To 200,000A	I _{2t} -Slightly > J I _p -Slightly > J	Feeder circuits Motor circuits
RK5	Fast Acting and Time Delay	1/10-600A	600V or less 250V or less	To 200,000A	I _{2t} - > RK-1 I _p - > RK-1	Feeder circuits Motor circuits
C (FORM II)	Moderate Delay	2-600A	600V or less	To 200,000A	I _{2t} - < RK-5 I _p - < RK-5	Motor circuits
T	Fast Acting	1-600A	300 and 600V or less	To 200,000A	I _{2t} -Low I _p -Low	Non-motor loads
L	Fast Acting and Time Delay	601-5000A	600V or less	To 200,000A I _p -Low	I _{2t} -Low motor loads	Feeder circuits Motor circuits

Branch Switches 600V Maximum

Ampere Rating	Maximum Voltage	Fusing	Mounting Height F2 38" W
30 / 30A	600V	J, C, R	6.25 (159)
60 / 60A	600V	J, C, R	6.25 (159)
100 / 100A	600V	J, C, R, T	7.5 (190)
200A	600V	J, C, R, T	10 (254)
200 / 200A	600V	J, T	10 (254)
400A	600V	J, C, R, T	15 (381)
600A	600V	J, C, R, T	15 (381)

① Refer to Siemens for Form II Class C applications.

Interrupting Ratings of Bolted Pressure Switches

Max. System Voltage	Ampere Rating	Class L Fuse Rating (Amps)	Fuse Interrupting Rating (Sym. RMS Amps)
240 to 600	800	601, 700, 800	200,000
	1200	1000, 1200	
	1600	1500, 1600	
	2000	1800, 2000	
	2500	2500	
3000	3000	3000	200,000
	4000	3500, 4000	

Application Note: Lower rated fuses may be installed within any switch rating i.e.: 2000-amp fuse in 4000-amp switch.

Sentron® FCI, FCI Switchboards

Protective Devices - HCP Switchboard Unit Disconnect Switches

General

Features

- CSA Certified / UL Listed under file number E6849
- 800A-1200A switch design.
- Visible contacts.
- Field installable shunt trip and auxiliary switch accessory kits.
- Installs in existing Siemens switchboards and power panelboards.
- Suitable for use on systems with up to 200,000A available fault current, RMS symmetrical when equipped with Class J or Class L fuses.
- Mixes with other 30A through 600A switches, and 100 through 1200 amp frame breakers.
- Allows 800A and 1200A switches in standard 38" wide distribution sections in either main or branch configurations.
- 16¼" mounting height is the smallest 1200A design in the industry, allowing up to 4 units in one vertical section.
- Field reversible horizontal mounting design for left or right hand cabling.



11 SWITCHBOARDS

3-Pole, Horizontal Mount^①

Catalogue Number	Maximum Ampere Rating	Maximum Voltage Rating	Fuse Class	Dimensions (inches)			Horsepower Rating							
							240V		480V		600V		250V DC	
				H	L	D	Std	Max	Std	Max	Std	Max		
HCP327HT	800	240	T	16.25	17.22	7.38	100	250	—	—	—	—	50	
HCP367H	800	600	L	16.25	17.22	7.38	100	250	200	500	250	500	50	
HCP328HT	1200	240	T	16.25	17.22	7.38	100	250	—	—	—	—	50	
HCP368H	1200	600	L	16.25	17.22	7.38	100	250	200	500	250	500	50	

3-Pole, Vertical Mount

HCP327VT	800	240	T	17.00	16.25	7.38	100	250	—	—	—	—	50
HCP367V	800	600	L	17.00	16.25	7.38	100	250	200	500	250	500	50
HCP328VT	1200	240	T	17.00	16.25	7.38	100	250	—	—	—	—	50
HCP368V	1200	600	L	17.00	16.25	7.38	100	250	200	500	250	500	50

Accessories

Terminal Connectors (one lug per kit)^②

Ampere Rating	Catalogue Number	Connector Wire Range
800A	TA3K500	(3) #1 AWG–500 kcmil (Cu or Al)
800A	TC3K350	(3) #1 AWG–350 kcmil (Cu only)
800-1200A	TA4H500	(4) #1 AWG–500 kcmil (Cu or Al)
800-1200A	TA3H750	(3) 250–750 kcmil (Cu or Al)

T Fuse Adapter Kits

Catalogue Number	Description
TFAK72	800A, 300V AC
TFAK75	800A, 600V AC
TFAK82	1200A, 300V AC

Auxiliary Switch Kits

Contact Ampere Rating	Maximum Voltage		Switch Mounting	Contacts	Catalogue Number
	AC	DC			
15A	480	125	Left Pole	1NO/1NC	A01HCPCL4
15A	480	125	Right Pole	1NO/1NC	A01HCPRP4
10A	240	125	Left Pole	2NO/2NC	A01HCPCL2

Compression Lug Adapter Kit

The use of this kit provides for the mounting of up to four lugs per phase. Each kit accepts lugs with (2) 3/8" diameter mounting holes on 1" centres. One kit per pole line or load is required. Lugs are not provided.

Ampere Rating	Catalogue Number
800–1200A	HCPCLP

Shunt Trip Kit

Control Voltage		Catalogue Number
AC	DC	
120	—	HCPST120
240	—	HCPST240
277	—	HCPST277
480	—	HCPST480
—	48	HCPST48
—	125	HCPST125

Switchboard Connection Strap Kit^①

Switch Ampere Rating	Catalogue Number
800–1200A	F6162DCAN

For inches / millimeters conversion, see Technical Section.

① For horizontal mounting only in either 38" wide min switchboards or S5/F2 power panelboards.

② 3 kits required for 3 phase switch

Sentron® FCI, FCII Switchboards

Metering Data

Selection

User Metering

A full complement of switchboard instruments with appropriate current transformers, potential transformers and selector switches are available in all Siemens switchboards.

The meters and instrument switches are mounted on hinged panels with potential transformers and fuses located behind the door. Current transformers are mounted on the main bus or, in the case of branch feeder metering, at the load terminals of the branch protective device and normally do not require additional unit space.

Siemens Digital Power Meters

The Siemens Digital Power Meters are provided as an option for FCI & FCII switchboards. Please refer to the Power Monitoring Section in this catalogue for more information.

Ammeters and Voltmeters (Analog)

Ammeters are switchboard type with $\pm 1\%$ accuracy, 0 to 6000 amperes maximum. The included instrument switch will provide positions to read each phase and will include an OFF position. Panel type ammeters with $\pm 3\%$ accuracy, 800 ampere maximum, can be furnished for branch feeder metering to conserve panel space.

Voltmeters are switchboard type with $\pm 1\%$ accuracy, 0 to 600V AC. The included instrument switch provides positions to read each phase-to-phase voltage and each phase-to-neutral voltage and has an OFF position.

Current Transformers / Potential Transformers

Potential transformers are recommended wherever the system voltage exceeds 150 volts AC phase-to-neutral to lower voltage levels for instrument switches and meters mounted on the switchboard front panel.

Available CT Ratios — Ampere Rating

100:5	600:5	2500:5
150:5	800:5	3000:5
200:5	1000:5	4000:5
300:5	1200:5	5000:5
400:5	1500:5	6000:5
500:5	2000:5	

Number of CT's and or PT's required for Typical Meters Applied on Selected System Voltages

System	Volts AC	Ammeter		Voltmeter		Wattmeter						Power Factor Meter		Frequency Meter		Synchroscope		
		C/T	P/T	Scale	2 Element		2.5 Element		3 Element		Wattmeter		Varmeter		C/T	P/T	PT	P/T
					C/T	P/T	C/T	P/T	C/T	P/T	C/T	P/T	C/T	P/T				
1Ø3W	120/240	2	–	0-300	2	–	–	–	–	–	2	–	2	–	1	–	–	–
3Ø3W	240	2	–	0-300	2	–	–	–	–	–	2	2	2	2	1	2	–	2
	600	2	2	0-750	2	2	–	–	–	–	2	2	2	2	1	2	1	2
3Ø4W	120/240	3	–	0-300	–	–	3	–	–	–	3	2	3	2	1	2	–	–
	120/208	3	–	0-300	–	–	3	–	3	–	3	–	3	–	1	2	–	–
	347/600	3	3	0-750	–	–	3	2	3	3	3	2	3	2	1	2	1	2

Integrated Power Systems Switchboards

Type IPS

General

Product Description

Siemens integrated power systems (IPS) switchboards integrate multiple pieces of electrical distribution equipment into a single assembly. The design results in reduced installation time, a reduced footprint and reduced labour risk for installation.

The modular design of the IPS switchboard allows it to be combined with standard service entrance or distribution switchboards if needed. Also, the IPS switchboard can be added to an existing switchboard lineup.

IPS switchboards have a wide range of applications and are commonly used in retail stores, offices, health care facilities and retrofits.

Features & Benefits

Features

- All standard FCI, FCII & SMP Switchboard features
- Lighting panelboards
- Distribution transformers
- Half high distribution switchboard chassis
- Individually mounted breakers (cable in & cable out)
- Auxiliary sections for surge devices, ACCESS power monitoring, contactors, relays, time clocks
- Customer equipment, etc.

Integrated Power Systems Switchboard Commonly Mounted Equipment

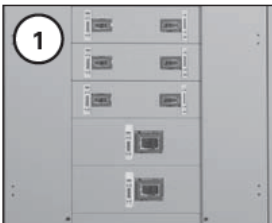

Distribution sections

- Up to 2000A (full height)
- Up to 1200A (half height)

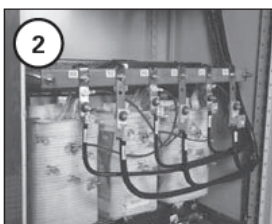

Transformers

- Up to 300kVA (full height)
- Up to 112.5kVA (half height)

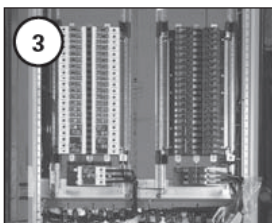

Panelboards

- P1 up to 250A
- P2 up to 600A

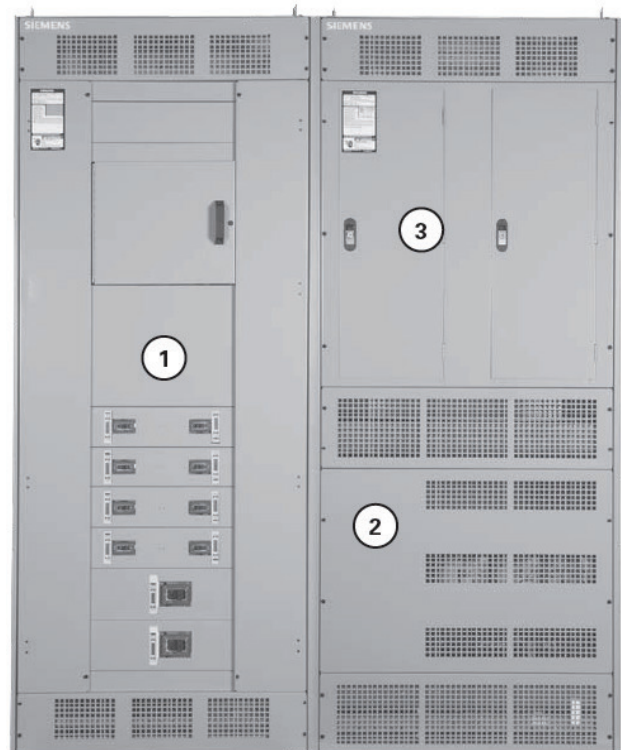

Integrated Power Systems Switchboards

General

Type IPS

Features & Benefits (continued)

Reduced Installation Time

IPS switchboards arrive at a jobsite with the components factory installed and wired. The result is significantly reduced installation time. The realized savings on installation result in lower labour costs which drops directly to the bottom line.

Reduced Space Requirements

By integrating components that are typically individually mounted, the IPS switchboard can reduce the space requirements for typical electrical equipment installation by up to 40%. This smaller footprint frees up valuable square footage that can be utilized by the building owner for other profitable uses.

Reduced Installation Risk.

IPS switchboards are assembled at Siemens manufacturing plants with meticulous attention to details reinforced with strict testing procedures. This focus on quality ensures that problems encountered with traditional installations such as misinterpretation of drawings or field installation errors are eliminated. Utilizing IPS switchboards eliminates risks, enabling projects to come in on time and on budget.

Standards and Certifications

- CSA C22.2 No.31
- Mounted panelboards built to UL67, NEMA PB-1 and CSA C22.2 No. 29
- Other equipment is CSA listed as applicable

Additional Information

For complete application and pricing information contact your local Siemens sales office.

Integrated Power Systems Switchboard Optimized Electrical Room Layout

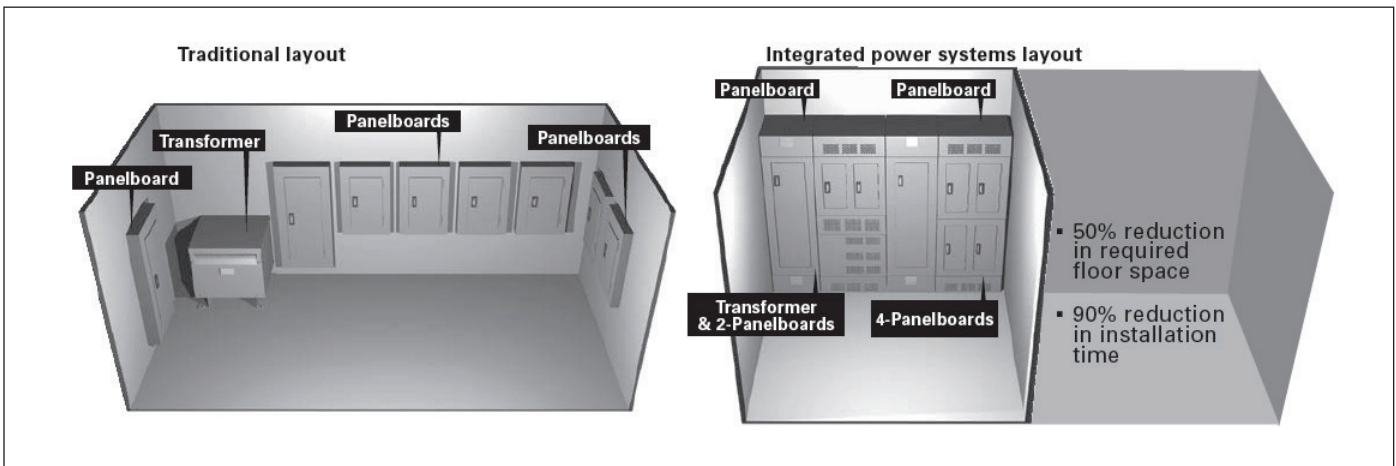

Embedded Micro Metering Module™

General

11 SWITCHBOARDS

SEM3 System configured in Distribution Panels and Switchboards

The information below pertains to panelboard types S5 and switchboard types SMP, FCI, and FCII. SEM3 specifics to S5, SMP, FCI, and FCII are:

SEM3 for use in Siemens Switchboards

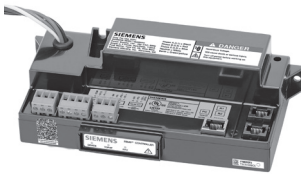

Controller

SEM3 controller is mounted in a low voltage compartment. Each controller can monitor up to 45 circuits. Applications that require monitoring more than 45 circuits will require additional controllers.



Current Transformers (CTs)

Six sizes of CTs are available for use in S5, SMP, FCI and FCII applications: 50, 125, 250, 400, 600, and 1200 amp. All CTs are pre-mounted to a support bracket that attaches to the interior. Each bracket supports a maximum of 3 CTs and is designed for the breaker selected (brackets are not interchangeable between breaker frames). Each CT will be attached to a data module that is placed in the meter racks.

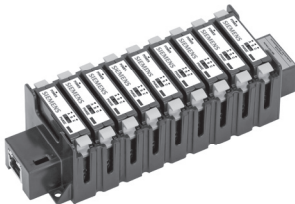

Meter Racks

All meter racks will be installed next to the SEM3 controller in unit space. The 21 space meter rack is used as a default option where possible.

NOTE: Monitoring of 45 circuits will require two 21 position racks and one 3 position rack

Other Considerations

Configuration: Data modules from CTs monitoring a circuit breaker must be mounted adjacent to one another in the meter rack. Any field changes to the factory configuration must take this into account.

Start-up & Commissioning: Siemens can provide these services. Contact your local SIEMENS Sales office for more details.

Notes
