



INSTRUCTION AND INSTALLATION MANUAL

DISTANCE TO COUPLE (DTC) SYSTEM

APRIL 2022

**DOCUMENT NO. SIG-00-21-02
VERSION A.1**

Siemens Mobility, Inc.
One Penn Plaza
Suite 1100
New York, NY 10119-1101
1-800-793-SAFE
www.usa.siemens.com/rail-manuals

Copyright © 2022 Siemens Mobility, Inc.
All Rights Reserved

PRINTED IN THE U.S.A.

PROPRIETARY INFORMATION

The material contained herein constitutes proprietary and confidential information, and is the intellectual property of Siemens Mobility, Inc. (Siemens) protected under United States patent, copyright and/or other laws and international treaty provisions. This information and the software it describes are for authorized use only, and may not be: (i) modified, translated, reverse engineered, decompiled, disassembled or used to create derivative works; (ii) copied or reproduced for any reason other than specific application needs; or (iii) rented, leased, lent, sublicensed, distributed, remarketed, or in any way transferred; without the prior written authorization of Siemens. This proprietary notice and any other associated labels may not be removed.

TRANSLATIONS

The manuals and product information of Siemens Mobility, Inc. are intended to be produced and read in English. Any translation of the manuals and product information are unofficial and can be imprecise and inaccurate in whole or in part. Siemens Mobility, Inc. does not warrant the accuracy, reliability, or timeliness of any information contained in any translation of manual or product information from its original official released version in English and shall not be liable for any losses caused by such reliance on the accuracy, reliability, or timeliness of such information. Any person or entity that relies on translated information does so at his or her own risk.

WARRANTY INFORMATION

Siemens Mobility, Inc. warranty policy is as stated in the current Terms and Conditions of Sale document. Warranty adjustments will not be allowed for products or components which have been subjected to abuse, alteration, improper handling or installation, or which have not been operated in accordance with Seller's instructions. Alteration or removal of any serial number or identification mark voids the warranty.

SALES AND SERVICE LOCATIONS

Technical assistance and sales information on Siemens Mobility, Inc. products may be obtained at the following locations:

SIEMENS MOBILITY, INC.	SIEMENS MOBILITY, INC.
2400 NELSON MILLER PARKWAY	939 S. MAIN STREET
LOUISVILLE, KENTUCKY 40223	MARION, KENTUCKY 42064
TELEPHONE: (502) 618-8800	TELEPHONE: (270) 918-7800
FAX: (502) 618-8810	CUSTOMER SERVICE: (800) 626-2710
SALES & SERVICE: (800) 626-2710	TECHNICAL SUPPORT: (800) 793-7233
WEB SITE: www.usa.siemens.com/rail-manuals	FAX: (270) 918-7830

FCC RULES COMPLIANCE

The equipment covered in this manual has been tested and found to comply with the limits for Class A digital devices, pursuant to part 15 of the FCC Rules. These limits are designed to provide reasonable protection against harmful interference when the equipment is operated in a commercial environment. This equipment generates, uses, and can radiate radio frequency energy and, if not installed and used in accordance with the instruction manual, may cause harmful interference to radio communications. Operation of this equipment in a residential area is likely to cause harmful interference in which case the user will be required to correct the interference at his/her own expense.

DOCUMENT HISTORY

Version	Release Date	Sections Changed	Details of Change
A	Sept 2021		Initial release
A.1	Apr 2022	1.2.2 4.6.2 4.6.7 5.5.3 6.1 6.2 6.5 7.4	Added text concerning configuration. Added configuration note. Added calibration note. Added text concerning secondary system and updated Figure 5-20. Added calibration note. Updated recalibration text in Table 6.1 Updated Figure 6.9. Updated recalibration text in Table 7.13. Added note to Section 7.4.7 and updated Table 7-18.

Table of Contents

PROPRIETARY INFORMATION	ii
TRANSLATIONS	ii
WARRANTY INFORMATION	ii
SALES AND SERVICE LOCATIONS	ii
DOCUMENT HISTORY	iii
NOTES, CAUTIONS, AND WARNINGS	xviii
ELECTROSTATIC DISCHARGE (ESD) PRECAUTIONS	xix
GLOSSARY	xx
SECTION 1 Introduction	1-1
1.1 Order of Content	1-1
1.1.1 Section 1 – Introduction	1-1
1.1.2 Section 2 – Primary Equipment Description	1-1
1.1.3 Section 3 – Auxiliary Equipment Description	1-1
1.1.4 Section 4 – Display Menu Screens	1-1
1.1.5 Section 5 – System Application Programming	1-1
1.1.6 Section 6 – System Calibration and Operational Checks	1-1
1.1.7 Section 7 – Diagnostics and Troubleshooting	1-1
1.1.8 Section 8 – Safety Related Application Conditions	1-1
1.2 Operational Overview	1-2
1.2.1 DTC Track Signal Sensing	1-2
1.2.2 Yard Control Interface	1-3
1.2.3 Unidirectional Application	1-4
1.2.4 Termination Shunts	1-4
1.2.5 Display Module	1-4
1.3 DTC Models	1-5
1.4 System Specifications	1-8
1.4.1 Input Power	1-8
1.5 Track Leads	1-11
1.5.1 Four-Wire Connections	1-11
1.5.2 Track Lead Routing	1-11
1.5.3 Track Lead Length	1-11
1.6 Typical Application Drawings	1-12
SECTION 2 Primary Equipment Description	2-1
2.1 General Physical Description	2-1

2.1.1	Case Assemblies.....	2-1
2.1.2	Motherboard	2-1
2.1.3	Plug-In Track Circuit Modules	2-1
2.1.4	External Wiring Connectors and Wire Size	2-2
2.1.5	Wire Preparation	2-2
2.1.6	Screw-terminal Connector Wire Insertion.....	2-2
2.1.7	Cage-Clamp Connector Wire Insertion.....	2-3
2.2	A80560 DTC Case.....	2-4
2.2.1	DTC Case Modules and Subassembly.....	2-5
2.2.2	Interface Connector to Module Relationship	2-6
2.2.3	External Wiring Connectors.....	2-6
2.3	Plug-in Modules and Subassemblies.....	2-7
2.3.1	CPU Modules, A80903 (CPU III).....	2-7
2.3.2	Track Module, A80418	2-10
2.3.3	Display Module, A80485-1	2-13
2.3.4	External Configuration Device (ECD) A80435.....	2-14
2.3.5	Chassis Identification Chip (CIC).....	2-14
2.3.6	Interface Connector Functions	2-15
2.4	LAN Communications	2-17
SECTION 3 Auxiliary Equipment.....		3-1
3.1	Auxiliary Equipment Covered	3-1
3.2	Bidirectional Simulation Coupler, 62664-mf.....	3-1
3.2.1	Simulated Bidirectional Coupler Configuration	3-2
3.3	Surge Panels, 80026-XX	3-5
3.3.1	Surge Panel Configurations.....	3-5
3.3.2	Surge Panel Nomenclature and Mounting Dimensions.....	3-6
3.3.3	Surge Panel Arresters	3-6
SECTION 4 Display Menu Screens.....		4-1
4.1	Display Module	4-1
4.2	Display Screens.....	4-1
4.2.1	System View Screen	4-2
4.2.2	I/O Screen	4-7
4.2.3	Program View Screen.....	4-8
4.2.4	Diags and Reports Screen	4-10
4.2.5	USB Menus Screen.....	4-14

4.2.6	Atypical Display Module Indications	4-19
4.3	USB File Structure	4-21
4.3.1	Setting up a USB Device for Use	4-21
4.4	Download/Upload Configuration (PAC) Files via USB Device.....	4-23
4.4.1	Download Configuration File to USB Drive.....	4-23
4.4.2	Upload Configuration File to DTC.....	4-24
4.5	Software Updates	4-27
4.5.1	Installing Software Using a USB Drive	4-27
4.5.2	Installing Software on Track Module	4-42
4.5.3	Installing Software on Display Module.....	4-44
4.6	Web User Interface Screens.....	4-45
4.6.1	System View.....	4-48
4.6.2	Configuration	4-53
4.6.3	Calibration and Adjustment	4-56
4.6.4	Status Monitor	4-56
4.6.5	Reports and Logs	4-56
4.6.6	Software Updates.....	4-65
4.6.7	Local User Presence	4-70
4.6.8	WebUI Display / CPU Connecting.....	4-72
4.6.9	Using the Display on a Network	4-74
4.6.10	Using the CPU III on a Network.....	4-75
4.6.11	WebUI Menus Available on CPU III While Display Also in Session	4-76
SECTION 5	Programming	5-1
5.1	Programming Details	5-1
5.2	System Programming	5-2
5.3	Site Programming.....	5-5
5.3.1	ATCS Address.....	5-5
5.3.2	Time	5-6
5.3.3	Location.....	5-6
5.4	Display Programming	5-7
5.4.1	Laptop Ethernet Port	5-8
5.4.2	Ethernet Port 1	5-8
5.4.3	Ethernet Port 2	5-9
5.4.4	DNS.....	5-9
5.4.5	Security	5-9

5.4.6	Set to Defaults.....	5-10
5.5	CP Programming.....	5-11
5.5.1	Laptop Ethernet Port.....	5-11
5.5.2	Router Settings.....	5-13
5.5.3	DTC Interface.....	5-14
5.5.4	Log Setup.....	5-14
5.5.5	Security.....	5-15
5.5.6	Web Server.....	5-15
5.6	Configuration Check Numbers.....	5-16
5.6.1	Configuration Check Number (CCN).....	5-16
5.6.2	Office Configuration Check Number (OCCN).....	5-16
5.6.3	Track and Field Configuration Check Numbers (TCN and FCN).....	5-16
5.7	Office Configuration Editor.....	5-17
SECTION 6	DTC Calibration and System Operational Checks.....	6-1
6.1	Setting up DTC Overview.....	6-1
6.2	DTC Calibration and System Operational Checks.....	6-1
6.2.1	Calibration Required Message.....	6-2
6.2.2	System Programming Requirements.....	6-2
6.2.3	In Service Recalibration Due to Failed Modules.....	6-3
6.2.4	Recalibration Requirements Due to Track Equipment Changes.....	6-5
6.2.5	In Service Recalibration if Shifts in EZ Occur.....	6-5
6.3	DTC Module Calibration.....	6-6
6.4	Approach Distance and Linearization Calibration.....	6-10
6.5	DTC Operational Checks.....	6-13
6.5.1	Connectivity.....	6-13
6.5.2	Distance.....	6-15
6.5.3	Speed.....	6-16
SECTION 7	Diagnostics and TroubleShooting.....	7-1
7.1	CPU III MODULE.....	7-1
7.1.1	CPU Front Panel LEDs.....	7-2
7.2	Track Module.....	7-6
7.2.1	Track LEDs.....	7-7
7.2.2	Track Four-Character Display.....	7-7
7.2.3	Normal Operation.....	7-8
7.3	Display Module.....	7-11

7.3.1	Track and System Diagnostic Windows	7-11
7.3.2	Maintenance Call Output	7-17
7.3.3	Transfer Output	7-17
7.4	Troubleshooting	7-17
7.4.1	Track Recalibration Requirements	7-19
7.4.2	Module Replacement Recalibration Requirements	7-20
7.4.3	Program Changes Procedure Requirements	7-21
7.4.4	Recalibration Due to Track Equipment Changes	7-22
7.4.5	Track Module Diagnostics	7-22
7.4.6	Diagnostics Log	7-27
7.4.7	CPU Module Diagnostics.....	7-27
7.4.8	Troubleshooting Track Problems.....	7-30
7.4.9	Low EX	7-31
7.4.10	High EZ and Low EX History & Calibrated Approach.....	7-31
SECTION 8	Safety Related Application Conditions	8-1
8.1	DTC Hazards.....	8-1

List of Figures

Figure 1-1	Diagram of EZ Level as Car Enters Track.....	1-2
Figure 1-2	Track Wiring	1-4
Figure 1-3	DTC Chassis	1-5
Figure 1-4	DTC Display	1-7
Figure 1-5	Typical Single Track, Unidirectional Application	1-13
Figure 1-6	Typical Single Track, Simulated Bidirectional Operation Application	1-14
Figure 1-7	Recommended Battery Surge Protection Wiring for DTC	1-15
Figure 2-1	Inserting Wires.....	2-3
Figure 2-2	A80560 DTC Case.....	2-4
Figure 2-3	A80560 Case with Modules Installed.....	2-5
Figure 2-4	External Wiring Connectors	2-6
Figure 2-5	CPU III Front Panel	2-8
Figure 2-6	Track Module Front Panel	2-11
Figure 2-7	Display Module	2-13
Figure 2-8	Typical ECD and CIC Locations on Backplane	2-15
Figure 3-1	Bidirectional Simulation Coupler, 62664-MF	3-2
Figure 3-2	4-Wire Connection using Bidirectional Simulation Coupler on DTC Operating in Bidirectional Simulation Mode.....	3-4
Figure 3-3	Bidirectional Simulation Coupler Assembly Mounting Dimensions.....	3-5
Figure 3-4	Typical 80026 Surge Panel Arrester Mounting Position	3-6
Figure 3-5	Wall Mounted Surge Panels, 80026-01 and -02.....	3-8
Figure 3-6	Rack Mounted Surge Panels, 80026-31 and -32.....	3-9
Figure 3-7	Rack Mounted Surge Panels, 80026-34 and -35.....	3-10
Figure 4-1	Display Keypad.....	4-2
Figure 4-2	Display System View Screen.....	4-2
Figure 4-3	Display Keypad Back Key	4-3
Figure 4-4	Display System View showing Diagnostic Messages.....	4-3
Figure 4-5	Train on Approach Icon	4-4
Figure 4-6	Healthy Transfer Status operating on Main	4-4
Figure 4-7	Unhealthy Transfer Status operating on Main	4-4
Figure 4-8	System Track Submenus Buttons	4-4
Figure 4-9	Display Keypad Number 1 & 2 Buttons	4-5
Figure 4-10	System Track Submenus.....	4-5
Figure 4-11	Track Diagnostic Screen.....	4-6

Figure 4-12	Track Options - Calibration	4-6
Figure 4-13	Track Calibration	4-7
Figure 4-14	I/O Screen	4-7
Figure 4-15	Program View Screen.....	4-8
Figure 4-16	Numeric Value Error	4-8
Figure 4-17	Menu Select Panel.....	4-9
Figure 4-18	System Programming Selecting Parameter.....	4-9
Figure 4-19	GCP Programming Editing Numeric Parameter	4-10
Figure 4-20	Diag & Reports Screen.....	4-10
Figure 4-21	Diag Message Screen	4-11
Figure 4-22	Diag Message Detail Screen	4-11
Figure 4-23	Report and Log Selection	4-12
Figure 4-24	Available Reports	4-12
Figure 4-25	Generation Progress	4-13
Figure 4-26	Config Report Sections.....	4-13
Figure 4-27	Available Logs	4-13
Figure 4-28	USB Menu	4-14
Figure 4-29	Software Update Options	4-15
Figure 4-30	Download Configuration Report.....	4-16
Figure 4-31	Download Event Log	4-16
Figure 4-32	Download Event Log Status	4-17
Figure 4-33	Download Event Log Status	4-17
Figure 4-34	Download Diagnostic Log.....	4-18
Figure 4-35	Download All Logs.....	4-19
Figure 4-36	Connection Progress Bar.....	4-20
Figure 4-37	Unlock Warning	4-20
Figure 4-38	VLP in Unconfigured State	4-21
Figure 4-39	Incorrect MCF Loaded.....	4-21
Figure 4-40	Select Download Configuration	4-23
Figure 4-41	Download Progress	4-23
Figure 4-42	PAC File Download Complete	4-24
Figure 4-43	Upload Configuration.....	4-25
Figure 4-44	Unlock Warning Message Window	4-25
Figure 4-45	Save Configuration	4-25
Figure 4-46	Download Configuration	4-26

Figure 4-47	Select PAC File	4-26
Figure 4-48	Uploading Configuration	4-27
Figure 4-49	Save Window.....	4-27
Figure 4-50	Ethernet Menu	4-28
Figure 4-51	DHCP Configuration	4-29
Figure 4-52	CPU-III Update	4-29
Figure 4-53	Change CP MEF.....	4-29
Figure 4-54	Select File Window	4-30
Figure 4-55	WebUI, GCP Login Screen.....	4-31
Figure 4-56	WebUI, GCP Menu.....	4-31
Figure 4-57	Ethernet Menu	4-32
Figure 4-58	DHCP Configuration	4-32
Figure 4-59	Software Update Menu.....	4-33
Figure 4-60	Change MEF	4-33
Figure 4-61	Select File Window	4-33
Figure 4-62	Exit Software	4-34
Figure 4-63	WebUI, GCP Login Screen.....	4-34
Figure 4-64	WebUI, Menu – VLP MEF Select	4-35
Figure 4-65	WebUI, Menu – Upload Status	4-35
Figure 4-66	Ethernet Menu	4-36
Figure 4-67	DHCP Configuration	4-36
Figure 4-68	Software Update Menu.....	4-37
Figure 4-69	Update MCF	4-37
Figure 4-70	Select File Window	4-38
Figure 4-71	Loading Progress Bar.....	4-38
Figure 4-72	Change MCF CRC	4-39
Figure 4-73	Enter MCF CRC for GCP.....	4-39
Figure 4-74	WebUI, GCP Login Screen.....	4-40
Figure 4-75	WebUI, GCP Menu – VLP MCF UNLOCK	4-41
Figure 4-76	WebUI, GCP Menu – Browse	4-41
Figure 4-77	WebUI, GCP Menu – Update Status	4-42
Figure 4-78	Change MEF	4-42
Figure 4-79	Erase MEF.....	4-43
Figure 4-80	Select File Window	4-43
Figure 4-81	MEF Loading	4-44

Figure 4-82	USB Update Window	4-44
Figure 4-83	Select File Window	4-45
Figure 4-84	Unsecure Connection Warning.....	4-46
Figure 4-85	WebUI Login Screen.....	4-47
Figure 4-86	WebUI Tool Bar	4-47
Figure 4-87	System View.....	4-48
Figure 4-88	System View Menus	4-49
Figure 4-89	Track Detail View.....	4-50
Figure 4-90	Selecting Calibration.....	4-50
Figure 4-91	Calibration Not Required	4-51
Figure 4-92	Calibration Required	4-51
Figure 4-93	Diagnostic Message	4-52
Figure 4-94	WebUI: Display Configuration Menu.....	4-53
Figure 4-95	WebUI: CPU III Configuration Menu.....	4-54
Figure 4-96	Display WebUI: System Programming	4-56
Figure 4-97	WebUI: Reports and Logs Menus.....	4-57
Figure 4-98	WebUI: Event Log	4-58
Figure 4-99	WebUI: Event Log Text Filter.....	4-59
Figure 4-100	WebUI: Log Selection Filter	4-59
Figure 4-101	WebUI: Event Log Mode	4-59
Figure 4-102	WebUI: Event Log ADVANCE Mode	4-60
Figure 4-103	WebUI: Event Log TRACE Mode	4-60
Figure 4-104	WebUI: Diagnostic Log.....	4-61
Figure 4-105	WebUI: Configuration Report Progress	4-62
Figure 4-106	WebUI: Configuration Report.....	4-63
Figure 4-107	WebUI: Track Data Settings	4-64
Figure 4-108	WebUI: Track Data Download	4-64
Figure 4-109	WebUI: Software Updates	4-65
Figure 4-110	WebUI: Configuration Download	4-66
Figure 4-111	WebUI: Configuration Upload Messages.....	4-66
Figure 4-112	WebUI: Configuration Upload File Selection	4-67
Figure 4-113	WebUI: Configuration Upload Progress and Final Check.....	4-67
Figure 4-114	WebUI: Module Upload.....	4-68
Figure 4-115	WebUI: Reset VLP.....	4-69
Figure 4-116	WebUI: Reset Upload Display Executive.....	4-69

Figure 4-117	WebUI: Unlock.....	4-70
Figure 4-118	WebUI: Confirm Local User Presence.....	4-71
Figure 4-119	Display: Confirm Local User Presence.....	4-71
Figure 4-120	WebUI Local User Presence Error Messages.....	4-71
Figure 4-121	Display Local User Presence Indicator.....	4-72
Figure 4-122	Display Module Not in Session.....	4-72
Figure 4-123	WebUI when VLP Unconfigured.....	4-73
Figure 4-124	WebUI System View when VLP Unconfigured due to MCF CRC Error.....	4-73
Figure 4-125	WebUI System Diagnostics when VLP is Unconfigured due to MCF CRC Error.....	4-74
Figure 4-126	Finding IP Client Address.....	4-75
Figure 5-1	DTC Configuration.....	5-1
Figure 5-2	System Programming Menu.....	5-2
Figure 5-3	Track 1 Programming Menu.....	5-2
Figure 5-4	WebUI System and Track 1 Programming Menu.....	5-3
Figure 5-5	Site Programming Menu.....	5-5
Figure 5-6	Sin Settings.....	5-5
Figure 5-7	Time Menu.....	5-6
Figure 5-8	Location Settings Menu.....	5-7
Figure 5-9	Display Configuration Menu, Local UI (Left), Web IU (Right).....	5-7
Figure 5-10	Laptop Ethernet Port Status.....	5-8
Figure 5-11	Port 1 Ethernet Port Status.....	5-8
Figure 5-12	DNS.....	5-9
Figure 5-13	Display Security Menu.....	5-10
Figure 5-14	Display Options on WebUI.....	5-10
Figure 5-15	CP Configuration Menu, WebUI.....	5-11
Figure 5-16	Laptop Ethernet Port Status.....	5-11
Figure 5-17	Laptop Ethernet Port IP settings.....	5-12
Figure 5-18	Ethernet Port Status.....	5-13
Figure 5-19	Router Settings.....	5-13
Figure 5-20	DTC Interface.....	5-14
Figure 5-21	Log Verbosity Settings.....	5-14
Figure 5-22	Security.....	5-15
Figure 5-23	Web Server.....	5-15
Figure 5-24	Check Number Screen.....	5-17
Figure 6-1	Two Track Status Screen Display Prior to Calibration.....	6-2

Figure 6-2	Opening the Calibration Window	6-7
Figure 6-3	Calibration Required	6-8
Figure 6-4	Start Calibration	6-8
Figure 6-5	Calibration In Progress and Complete	6-9
Figure 6-6	Add Comment Option	6-9
Figure 6-7	GCP Approach Calibration Window Before and After Approach Calibration	6-11
Figure 6-8	Midpoint Location	6-12
Figure 6-9	Setting Yard System IP Address	6-14
Figure 6-10	ATCS Address on WebUI	6-14
Figure 6-11	Setting ATCS Address on WebUI	6-15
Figure 7-1	CPU III Module	7-1
Figure 7-2	Track Module	7-6
Figure 7-3	Display Module	7-11
Figure 7-4	Example Track Unhealthy Screen	7-12
Figure 7-5	Example Healthy system Screen	7-12
Figure 7-6	Unhealthy Track Module Diagnostics	7-13
Figure 7-7	Track Diagnostic Message Windows	7-13
Figure 7-8	Module Diagnostic Message Windows	7-14
Figure 7-9	MCF Configuration Not Available	7-14
Figure 7-10	Diagnosis Message	7-14
Figure 7-11	Diagnostic Log	7-15
Figure 7-12	CPU Troubleshooting Flow Chart	7-18
Figure 7-13	Trackside Troubleshooting Flowchart	7-18

List of Tables

Table 1-1	Part Number Configuration Chart - CPU.....	1-5
Table 1-2	Part Number Configuration Chart - Track Cards.....	1-6
Table 1-3	Part Number Configuration Chart - Display	1-6
Table 1-4	Module Current	1-8
Table 1-5	Ballast Resistance vs. Approach Length by Frequency, Simulated Bidirectional Applications*	1-10
Table 1-6	Ballast Resistance vs. Approach Length by Frequency, Unidirectional Applications*	1-10
Table 1-7	Maximum Transmit Wire Lengths (Four-Wire Applications)	1-11
Table 1-8	Typical Application Drawings	1-12
Table 2-1	DTC GCP Case Feature Overview	2-1
Table 2-2	Module to Interface Connector Relationship.....	2-6
Table 2-3	External Wiring Connectors	2-7
Table 2-4	CPU User Interface.....	2-8
Table 2-5	Track Frequencies	2-10
Table 2-6	Track Module User Interface	2-12
Table 2-7	CPU Connectors	2-16
Table 2-8	Track 1 Connectors.....	2-17
Table 3-1	Approach Distance Selection Strapping For Bidirectional Simulation Coupler, 62664-MF....	3-3
Table 3-2	Bidirectional Simulation Coupler, 62664-MF.....	3-3
Table 3-3	Wall and Rack Mounted Surge Panels	3-7
Table 5-1	Track Parameters	5-4
Table 5-2	Track Transmit Frequencies	5-5
Table 6-1	Recalibration Requirements Due to Programming Changes	6-4
Table 6-2	Recalibration Requirements Due to Track Equipment Changes	6-5
Table 6-3	GCP Calibration	6-7
Table 6-4	Approach and Linearization Calibration Bypass Procedure.....	6-10
Table 6-5	Approach and Linearization Calibration 1	6-11
Table 6-6	Approach and Linearization Calibration 2	6-12
Table 6-7	Calibrated Value History Form.....	6-13
Table 7-1	Front Panel LED Descriptions.....	7-2
Table 7-2	CPU Four Character Display Normal Start-up Sequence.....	7-3
Table 7-3	CPU Four Character Display Error Codes	7-4
Table 7-4	Setup Menu Display.....	7-5
Table 7-5	Track LEDs	7-7

Table 7-6	Normal Operation	7-8
Table 7-7	Calibration Messages	7-8
Table 7-8	Diagnostics Messages	7-9
Table 7-9	Boot-up Messages	7-10
Table 7-10	Module State During Bootup	7-10
Table 7-11	Software Installation Messages	7-10
Table 7-12	Recalibration Requirements Due to Module/Chassis Replacement	7-20
Table 7-13	Programming Changes Recalibration Requirements	7-21
Table 7-14	Recalibration Requirements Due to Track Equipment Changes	7-22
Table 7-15	Diagnosing Track Module Problems	7-22
Table 7-16	Diagnosing Track Module Problems	7-23
Table 7-17	Diagnosing Track Module Problems	7-25
Table 7-18	Diagnosing CPU Module Problems	7-28

List of Procedures

Procedure 7.1 Rail Bond Tests	7-30
Procedure 7.2 Termination Shunts Tests.....	7-30

NOTES, CAUTIONS, AND WARNINGS

Throughout this manual, notes, cautions, and warnings are frequently used to direct the reader's attention to specific information. Use of the three terms is defined as follows:



WARNING

INDICATES A POTENTIALLY HAZARDOUS SITUATION WHICH, IF NOT AVOIDED, COULD RESULT IN DEATH OR SERIOUS INJURY. WARNINGS ALWAYS TAKE PRECEDENCE OVER NOTES, CAUTIONS, AND ALL OTHER INFORMATION.



CAUTION

REFERS TO PROPER PROCEDURES OR PRACTICES WHICH IF NOT STRICTLY OBSERVED, COULD RESULT IN A POTENTIALLY HAZARDOUS SITUATION AND/OR POSSIBLE DAMAGE TO EQUIPMENT. CAUTIONS TAKE PRECEDENCE OVER NOTES AND ALL OTHER INFORMATION, EXCEPT WARNINGS.

NOTE

NOTE

Generally used to highlight certain information relating to the topic under discussion.

If there are any questions, contact Siemens Mobility, Inc. Application Engineering

ELECTROSTATIC DISCHARGE (ESD) PRECAUTIONS

Static electricity can damage electronic circuitry, particularly low voltage components such as the integrated circuits commonly used throughout the electronics industry. Therefore, procedures have been adopted industry-wide which make it possible to avoid the sometimes invisible damage caused by electrostatic discharge (ESD) during the handling, shipping, and storage of electronic modules and components. Siemens Industry, Inc. has instituted these practices at its manufacturing facility and encourages its customers to adopt them as well to lessen the likelihood of equipment damage in the field due to ESD. Some of the basic protective practices include the following:

- Ground yourself before touching card cages, assemblies, modules, or components.
- Remove power from card cages and assemblies before removing or installing modules.
- Remove circuit boards (modules) from card cages by the ejector lever only. If an ejector lever is not provided, grasp the edge of the circuit board but avoid touching circuit traces or components.
- Handle circuit boards by the edges only.
- Never physically touch circuit board or connector contact fingers or allow these fingers to come in contact with an insulator (e.g., plastic, rubber, etc.).
- When not in use, place circuit boards in approved static-shielding bags, contact fingers first. Remove circuit boards from static-shielding bags by grasping the ejector lever or the edge of the board only. Each bag should include a caution label on the outside indicating static-sensitive contents.
- Cover workbench surfaces used for repair of electronic equipment with static dissipative workbench matting.
- Utilize only anti-static cushioning material in equipment shipping and storage containers.

For information concerning ESD material applications, please contact the Technical Support Staff at 1-800-793-7233. ESD Awareness Classes and additional ESD product information are also available through the Technical Support Staff.

GLOSSARY

TERM	DESCRIPTION
AAR:	<u>Association of American Railroads</u> – An organization that establishes uniformity and standardization among different railroad systems.
AREMA:	<u>American Railroad Equipment Manufacturing Association</u> – An organization that supersedes AAR.
ATCS:	<u>Advanced Train Control System</u> – A set of standards compiled by the AAR for controlling all aspects of train operation.
DTC	<u>Distance to Couple</u>
ECD:	<u>External Configuration Device</u> – A serial EEPROM (Flash Memory) device mounted inside the chassis of the GCP unit. The ECD is used to store site-specific configuration data (MCF, SIN, and configuration parameters) for the CPU.
EX Value	The phase of the received signal, which is the measure of the impedance of the track ballast. This measurement identifies how much current is leaking from one rail to another.
EZ Value	The measure of the received signal level.
GCP	<u>Grade Crossing Predictor. This is the product on which the DTC is based, since the DTC and GCP use common CPU III and Display software, many of the user interfaces will mention GCP.</u>
MEF:	<u>Module Executable File</u> – The executive software running in the CPU or I/O Modules. The user can download the MEF through the Diag port to update the software.
MCF:	<u>Module Configuration File</u> – The GCP application logic file.
SIN:	<u>Site Identification Number</u> – The 12-digit ATCS address for the site. The SIN has the form 7.RRR.LLL.GGG.SS stored in binary coded decimal, with each digit in one nibble. The digit 0 is represented by “A” and 0 is used as a null byte.
Site Location:	The location where GCP unit is installed.
VPI:	<u>Vital Parallel Input</u> – A module input circuit the function of which affects the safety of the crossing operation.
VRO:	<u>Vital Relay Output</u> – A module output circuit the function of which affects the safety of the crossing operation.

SECTION 1 INTRODUCTION

1.0 GENERAL INFORMATION

This manual provides installation information and detailed operating instructions for the Siemens Distance to Couple (DTC) product. The information is essential to proper system operation and problem diagnosis. It is strongly recommended that each system operator/maintainer become familiar with the information provided herein before attempting to program, calibrate, or troubleshoot the DTC system.

1.1 ORDER OF CONTENT

The following headings detail the organization of the material contained in this manual.

1.1.1 Section 1 – Introduction

The Introduction contains a brief overview of system operation, equipment specifications, and typical application drawings.

1.1.2 Section 2 – Primary Equipment Description

This section provides a brief description of the DTC case and plug-in modules, including indicators and controls.

1.1.3 Section 3 – Auxiliary Equipment Description

This section provides a brief description of the auxiliary equipment available for use in conjunction with the DTC system. Also provided are installation and adjustment procedures for this equipment, where applicable.

1.1.4 Section 4 – Display Menu Screens

This section describes the functions and menus available on the display module and the web user interface.

1.1.5 Section 5 – System Application Programming

This section provides step-by-step system programming instructions.

1.1.6 Section 6 – System Calibration and Operational Checks

This section provides step-by-step instructions for system calibration (required following programming) and operational checks to be performed immediately prior to placing the system in operation.

1.1.7 Section 7 – Diagnostics and Troubleshooting

This section includes procedures for utilizing self-diagnostic capabilities of the DTC. Diagnostic message code listings are also provided.

1.1.8 Section 8 – Safety Related Application Conditions

This section includes information relating to safety and compatibility of the DTC system.

1.2 OPERATIONAL OVERVIEW

The Distance to Couple (DTC) product is a microprocessor-controlled system that is deployed to continually monitor track in yard applications, measure the speed and distance of the railroad cars rolling down the track and report this information via an Ethernet interface to the Yard control system. The DTC product is based upon the technology used in the Model 4000 Grade Crossing Predictor (GCP) product.

See SECTION 8 for Safety Related Application Conditions related to Distance to Couple Applications.

1.2.1 DTC Track Signal Sensing

During operation, the DTC applies a constant current AC signal to the track and measures the level of the resulting voltage.

- The voltage level (EZ) varies with approach track impedance, which, in turn, corresponds to the distance of the car from the track feed points.
 - When unoccupied, the approach circuit has maximum impedance.
 - When a railroad car (or locomotive) enters the approach from the track feed-points, the low-resistance shunt created by the car's wheels causes the track circuit impedance to drop to a low value and is indicated by EZ near zero
 - As the car rolls away from the feed-points, the track circuit impedance increases and hence EZ increases.
 - When the car stops, the EZ will stop increasing.
 - If the track is properly calibrated, then when the track is empty will have an EZ value of 100.
 - As the track fills up with cars, the EZ value will decrease in steps as each new car couples to the cars already on the track.
- The EZ value and its rate of change are sensed by the DTC and are used to calculate the speed of the car.

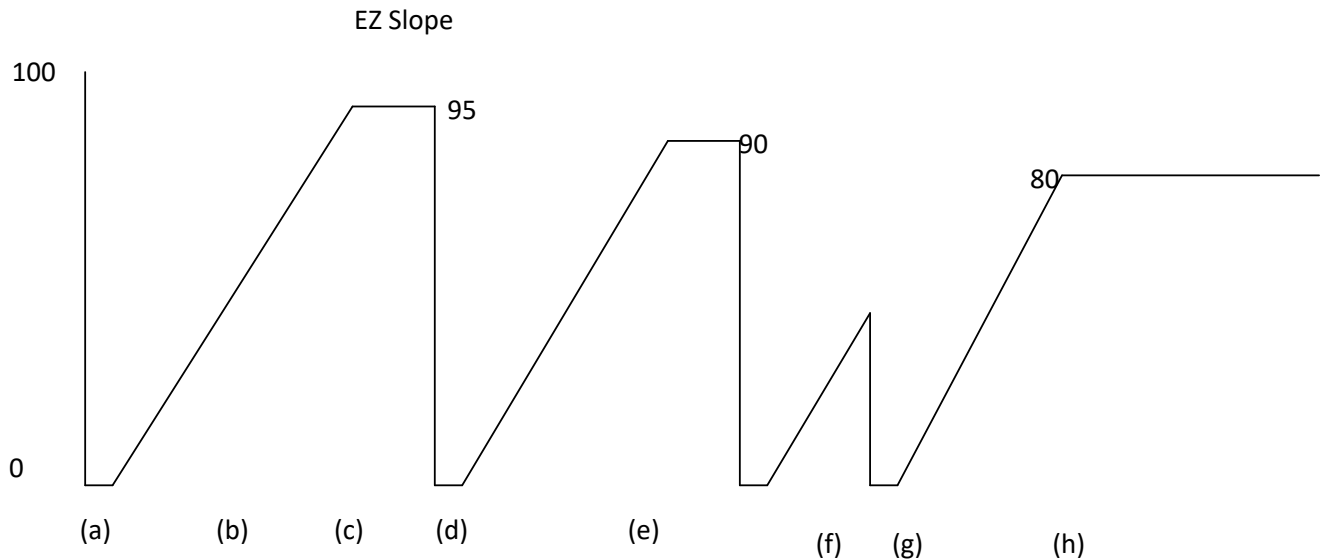

Figure 1-1 Diagram of EZ Level as Car Enters Track

Figure 1-1 shows the following:

- (a) The track is initially empty with EZ at 100. A car enters the approach and EZ drops to 0, EZ stays at 0 until the last wheel of the car crosses the insulated joint at the track circuit feed-points.
- (b) As the car rolls away, EZ increases.

- (c) When the car hits the skate retarder at the end of the track, EZ stops increasing. The EZ will now be less than 100 as car is occupying the track (shown as 95 above).
- (d) When a new car enters, EZ drops to 0 again.
- (e) As the second car rolls away and EZ increases and eventually couple with the 1st car, the final EZ is lower again, shown as 90 above.
- (f) A third car enters and rolls down the track and EZ increases.
- (g) This shows a fourth car entering the track while the 3rd one is still rolling down the track, EZ drops to 0 as the DTC car only see the back of the closest car.
- (h) When both the 3rd and 4th cars couple, the EZ will now have decreased proportionally to the length of these two cars, shown as 80 above.

1.2.2 Yard Control Interface

The DTC will send ATCS messages as UDP frames over the ethernet from the CPU III. The messages are transmitted from the CPU III laptop port. Thus, the laptop port should be connected to the same Ethernet subnet as the Yard control system. The DTC can be configured to send messages to both a primary and secondary Yard control system.

The DTC will send the following information in the ATCS messages for each of the 5 possible track cards used in the system:

- Track card used
- Track card communicating
- Track card health
- Calibration status
- Motion detected – none, inbound, outbound
- Distance to last car (ft)
- Speed of car (ft/sec)
- EX (indication of ballast conditions)

The message format and protocol are described in Siemens document 20S0033. Please contact Siemens Mobility, Inc if this is required.

The DTC will accept ATCS messages from the Yard control system to perform the GCP calibration for a specified track. This feature could be used for instance to re-calibrate the track without having to have someone present in the bungalow at the equipment if the EZ has drifted due to ballast changes. The track card should only be re-calibrated if the track is empty.

If calibration is performed when a car is standing on the track, this will result in cars looking further away than they really are.



WARNING

THE TRACK CARD MUST ONLY BE CALIBRATED WHEN THE TRACK IS EMPTY.

IF CALIBRATION IS PERFORMED WHEN A CAR IS STANDING ON THE TRACK, THIS WILL RESULT IN THE DTC REPORTING CARS AS FURTHER AWAY THAN THEY REALLY ARE.

For example, if under normal conditions the computed approach distance is set to 1000' and EZ is 100 with an empty track, if a car was in the middle of the track, EZ would read 50 and the GCP would report a distance of 500'.

If the track was now recalibrated with the car in the middle of the track, the GCP would read EZ 100 at 500', but interpret this as the full computed approach length of 1000'. When the car was removed, EZ would go to 200 and the GCP would report a distance of 2000'.

1.2.3 Unidirectional Application

The DTC relies on unidirectional operation as shown in Figure 1-2. The track circuit only looks one way from the track wires and thus the feed wires must be placed close to the insulated joints where the cars enter the approach. The track can be configured for simulated bidirectional operation if necessary.

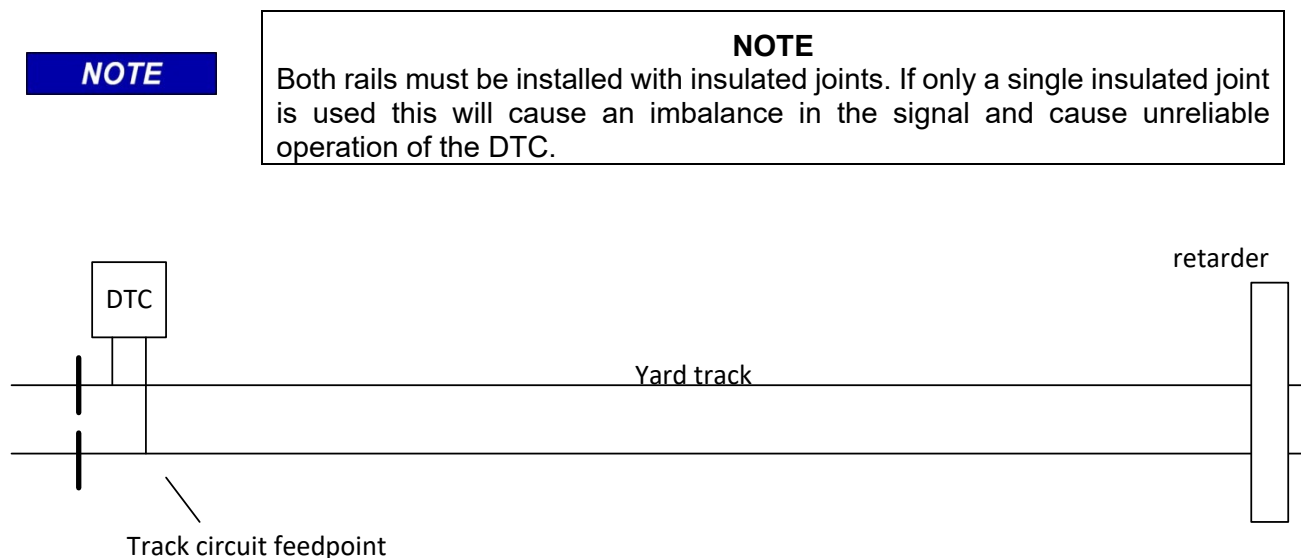

Figure 1-2 Track Wiring

The track can be configured as simulated bidirectional if the track length is too large for the chosen frequency, see Figure 1-6. This requires the use of the 62664-f Bidirectional Simulation Coupler which is adjusted to the proper distance, see section 3.2.

1.2.4 Termination Shunts

In DTC application, a hardware shunt is connected across the rails to terminate the DTC approach circuit. It is not recommended to use the normal narrow or wide band shunts used in GCP applications.

Application parameters are programmable via either the A80485 Display Module Local User Interface (see Section 2.3.3), Display Web User Interface or CPU III Web User Interface and a computer running a compatible web browser (see Section 4.6).

1.3 DTC MODELS

The DTC operates from battery power to ensure continued operation in the event of AC power failure. There is one DTC chassis with optional plug-in modules, this allows options for:

- 1 to 5 DTC track circuits

The following tables show some of the ordering options for the DTC part number.

Table 1-1 Part Number Configuration Chart - CPU

	8XXX-80560-00X0
	Slots for Combination of CPU Cards, B=D39325-01
Dash No.	M1
0	B
1	A80903-2021

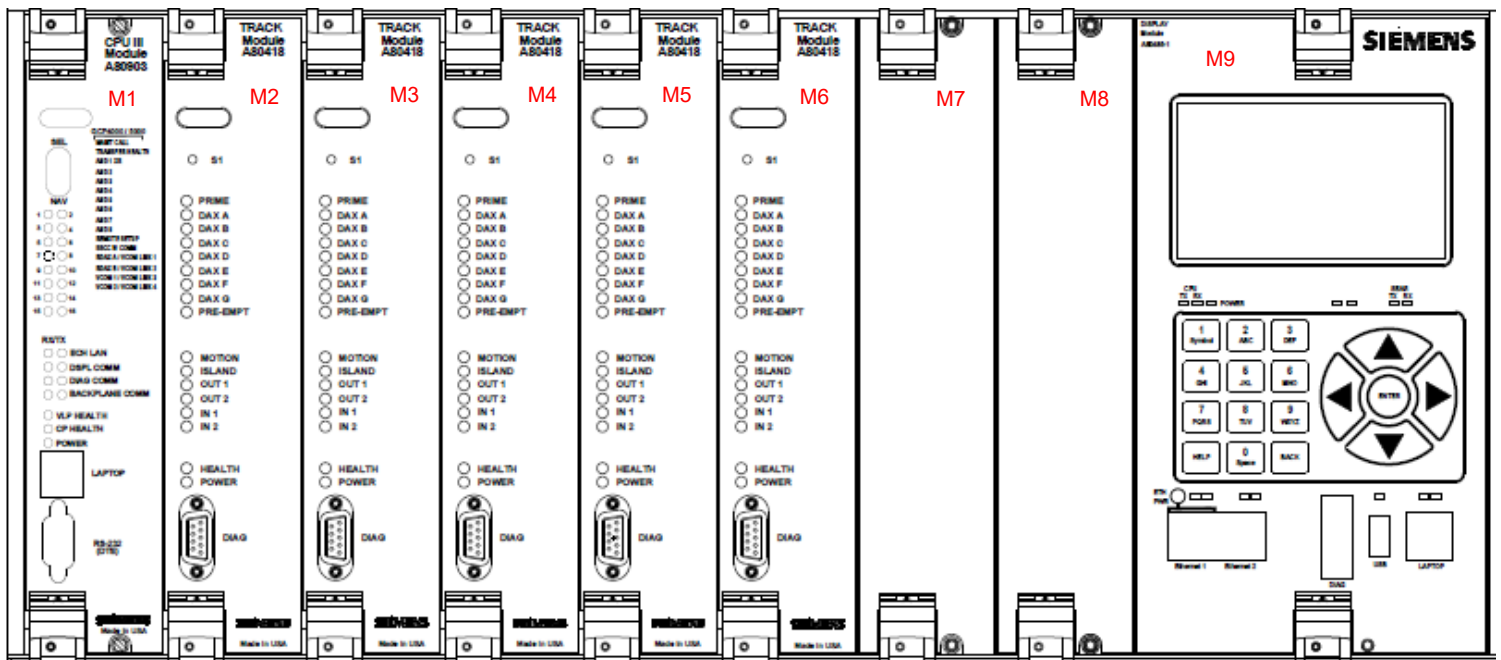

Figure 1-3 DTC Chassis

Table 1-2 Part Number Configuration Chart - Track Cards

Dash No.	8XXX-80560-00X0				
	Combination of Track Cards and Filler Panels T= A80418 B= D39325-01				
	M2	M3	M4	M5	M6
00	-	-	-	-	-
01	T	B	B	B	B
02	T	T	B	B	B
03	T	T	T	B	B
04	T	T	T	T	B
05	T	T	T	T	T

Table 1-3 Part Number Configuration Chart - Display

Dash No.	8XXX-80560-00X0	
	M9 Display B=D39326-01	USB Flash
0	B	W/O
1	A80485-01	W/O
2	A80485-01	WITH

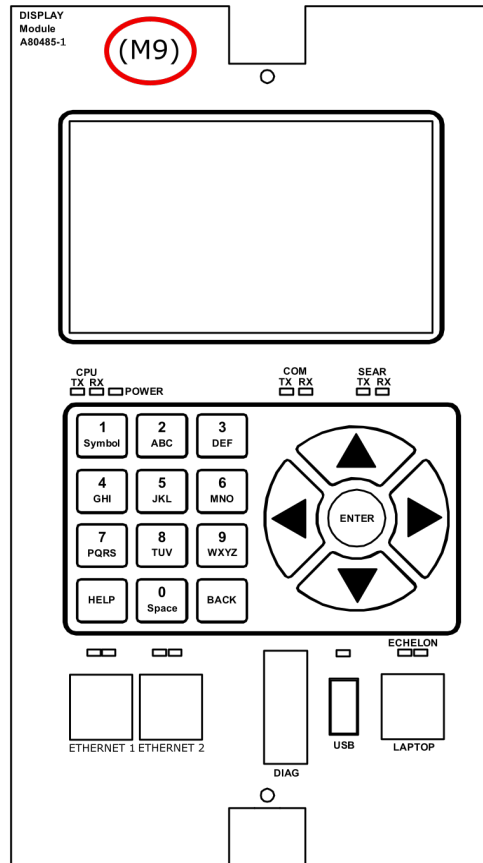

Figure 1-4 DTC Display

1.4 SYSTEM SPECIFICATIONS

1.4.1 Input Power

Battery Voltage

On CPU Connector: 9.0-16.5 VDC

Maximum Ripple: 1.0 V p-p

Table 1-4 Module Current

	CPU Battery Connector @10 V	CPU Battery Connector @13.2 V	CPU Battery Connector @ 16.5 V
CPU III (A80903)	0.74 A	0.62 A	0.55 A
Track	1140 mA @ medium transmit power 1190 mA @ high transmit power *Current increases by 90 mA when one 250 ohm relay output is energized	830 mA @ medium transmit power 870 mA @ high transmit power *Current increases by 50 mA when one 250 ohm relay output is energized	660 mA @ medium transmit power 720 A @ high transmit output *Current increases by 40 mA when one 250 ohm relay output is energized
Minimum Output Current @ medium transmit power:	180 mA	180 mA	180 mA
Minimum Output Current @ high transmit power:	260 mA	260 mA	260 mA
Display	770 mA 740 mA hibernating	660 mA 640 mA hibernating	600 mA 590 mA hibernating
DTC with Full Complement of Modules: CPU III Track (5) Display	4.3 A (Main)	3.3 A (Main)	2.8 A (Main)

DTC Track Frequencies Available:

Siemens Standard Frequencies:

86, 114, 156, 211, 285, 348, 430, 545, 645, 790, and 970 Hz

Offset frequencies:

85.5, 86.5, 87, 113, 113.5, 114.5, 115, 155, 155.5, 156.5, 157, 210, 212, 284, 286, 347, 349, 429, 431, 523, 527, 643, 647, 788, 792, 968, and 972 Hz

Other frequencies:

44, 45, 46, 141, 149, 151, 237, 239, 250, 267, 326, 392, 452, 522, 560, 630, 686, 753, 816, 881, 979, and 999 Hz

Frequency Stability

±0.01 percent

Surge Protection

Built-in secondary surge protection for all connections.

- Requires external arresters and equalizers on track wires as primary surge protection.
 - Surge panels or their electrical equivalent are required.

Mounting

wall, rack, or shelf mounted.

Chassis Dimensions**Width:**

23.2 Inches

(59.0 centimeters)

Depth:

11.2 Inches

(28.4 centimeters)

Height:

19.1 Inches

(48.5 centimeters)

Chassis Weight

Empty	Full Module Complement
19 pounds (8.6 kilograms)	32 pounds (14.5 kilograms)

Module Weight**CPU III (A80903)**

1.25 pounds (0.56 kilograms)

Track (A80418)

1.00 pounds (0.45 kilograms)

Display (A80485-1)

3.88 pounds (1.75 kilograms)

Temperature Range

-40 °F to +160 °F (-40 °C to 70 °C)

Table 1-5 Ballast Resistance vs. Approach Length by Frequency, Simulated Bidirectional Applications*

DTC OPERATING FREQUENCY (HZ)	SIMULATED BIDIRECTIONAL APPROACH DISTANCE IN FEET (METERS)					
	2 OHMS/1,000' (304.8M) DISTRIBUTED BALLAST		4 OHMS/1,000' (304.8M) DISTRIBUTED BALLAST		6 OHMS/1,000' (304.8M) DISTRIBUTED BALLAST	
	MIN	MAX	MIN	MAX	MIN	MAX
86	1,000 (304.8)	5,350 (1,630.7)	1,000 (304.8)	7,950 (2,423.2)	1,000 (304.8)	9,280 (2,362.2)
114	750 (228.6)	4,525 (1,379.2)	750 (228.6)	6,450 (1,966.0)	750 (228.6)	7,448 (2,270.2)
156	600 (182.9)	3,925 (1,196.3)	600 (182.9)	5,550 (1,691.6)	600 (182.9)	6,349 (1,935.2)
211	475 (144.8)	3,350 (1,021.1)	475 (144.8)	4,800 (1,463.0)	475 (144.8)	5,494 (1,674.6)
285	400 (121.9)	2,950 (899.2)	400 (121.9)	4,225 (1,287.8)	400 (121.9)	4,762 (1,451.5)
348	400 (121.9)	2,625 (800.1)	400 (121.9)	3,675 (1,120.1)	400 (121.9)	4,151 (1,265.2)
430	400 (121.9)	2,300 (701.0)	400 (121.9)	3,350 (1,021.1)	400 (121.9)	3,785 (1,153.7)
525	400 (121.9)	2,150 (655.3)	400 (121.9)	3,150 (960.1)	400 (121.9)	3,541 (1,179.3)
645	400 (121.9)	1,950 (594.4)	400 (121.9)	2,800 (853.4)	400 (121.9)	3,175 (967.7)
790	400 (121.9)	1,725 (525.8))	400 (121.9)	2,475 (753.4)	400 (121.9)	2,807 (855.9)
970	400 (121.9)	1,550 (472.4)	400 (121.9)	2,175 (662.9)	400 (121.9)	2,472 (753.5)

Table 1-6 Ballast Resistance vs. Approach Length by Frequency, Unidirectional Applications*

DTC OPERATING FREQUENCY (HZ)	UNIDIRECTIONAL APPROACH DISTANCE IN FEET (METERS)					
	2 OHMS/1,000' (304.8M) DISTRIBUTED BALLAST		4 OHMS/1,000' (304.8M) DISTRIBUTED BALLAST		6 OHMS/1,000' (304.8M) DISTRIBUTED BALLAST	
	MIN	MAX	MIN	MAX	MIN	MAX
86	700 (213.4)	4,375 (1,333.5)	700 (213.4)	6,175 (1,882.1)	700 (213.4)	7,080 (2,158.0)
114	525 (160.0)	3,850 (1,173.5)	525 (160.0)	5,550 (1,691.6)	525 (160.0)	6,360 (1,938.5)
156	420 (128.0)	3,325 (1,013.5)	420 (128.0)	4,875 (1,485.9)	420 (128.0)	5,520 (1,682.5)
211	400 (121.9)	2,750 (838.2)	400 (121.9)	4,100 (1,249.7)	400 (121.9)	4,680 (1,426.5)
285	400 (121.9)	2,250 (686.8)	400 (121.9)	3,500 (1,066.8)	400 (121.9)	3,960 (1,207.0)
348	400 (121.9)	1,925 (586.7)	400 (121.9)	3,025 (922.0)	400 (121.9)	3,420 (1,042.4)
430	400 (121.9)	1,725 (525.8)	400 (121.9)	2,650 (807.7)	400 (121.9)	3,000 (914.4)
525	400 (121.9)	1,500 (457.2)	400 (121.9)	2,275 (693.4)	400 (121.9)	2,580 (786.4)
645	400 (121.9)	1,300 (396.2)	400 (121.9)	1,950 (594.4)	400 (121.9)	2,220 (676.7)
790	400 (121.9)	1,125 (342.9)	400 (121.9)	1,650 (502.9)	400 (121.9)	1,860 (566.9)
970	400 (121.9)	1,050 (320.0)	400 (121.9)	1,550 (472.4)	400 (121.9)	1,710 (521.2)

1.5 TRACK LEADS

1.5.1 Four-Wire Connections

Four track leads (wires) connect the DTC track card to the track.

- Two transmit leads are connected close to the instrument bungalow. The transmitter leads must be as short as possible and not exceed the maximum lengths specified in Table 1-7.
- Two receiver leads are connected to the rails outside of the transmit leads, closer to the termination.
- The check channel wires do not need connecting in the DTC application.
- In DTC track installations, the transmitter leads should be located adjacent to the insulated joints.



CAUTION

THE MAXIMUM TRANSMITTER LEAD LENGTHS SPECIFIED IN Table 1-7 ARE FOR THE TRANSMITTER PAIR OF WIRES MEASURED BETWEEN THE BUNGALOW AND THE RAIL CONNECTIONS.

Table 1-7 Maximum Transmit Wire Lengths (Four-Wire Applications)

STANDARD SIEMENS TRACK FREQUENCY (HZ)	MAXIMUM TRANSMIT LEAD LENGTH IN FEET (METERS)
86	100 (30.5)
114	125 (38.1)
156	150 (45.7)
211	200 (61.0)
285-970	250 (76.2)

1.5.2 Track Lead Routing

The Track wires are routed between the DTC track connectors on the DTC front panel and the Surge Panel and between the Surge Panel and the rails. The leads between the DTC and the Surge Panel must use twisted number 16 AWG to 12 AWG wire. The transmitter and receiver leads between the Surge Panel and the rails must be twisted and have a minimum wire size of number 6 AWG.

1.5.3 Track Lead Length

In general, limit the total track lead length of a 4-wire circuit to 600 feet (182.9 meters), where possible. This includes the actual length of the transmitter and the receiver twisted pairs added together. Twist each pair of wires at least two turns per foot. Track lead length is measured from the bungalow to the rail connections.

1.6 TYPICAL APPLICATION DRAWINGS

The following figures illustrate a variety of typical DTC applications.

Table 1-8 Typical Application Drawings

Figure	Title
Figure 1-5	Typical Single Track, Unidirectional Application
Figure 1-6	Typical Single Track, Simulated Bidirectional Operation Application
Figure 1-7	Recommended Battery Surge Protection Wiring for DTC

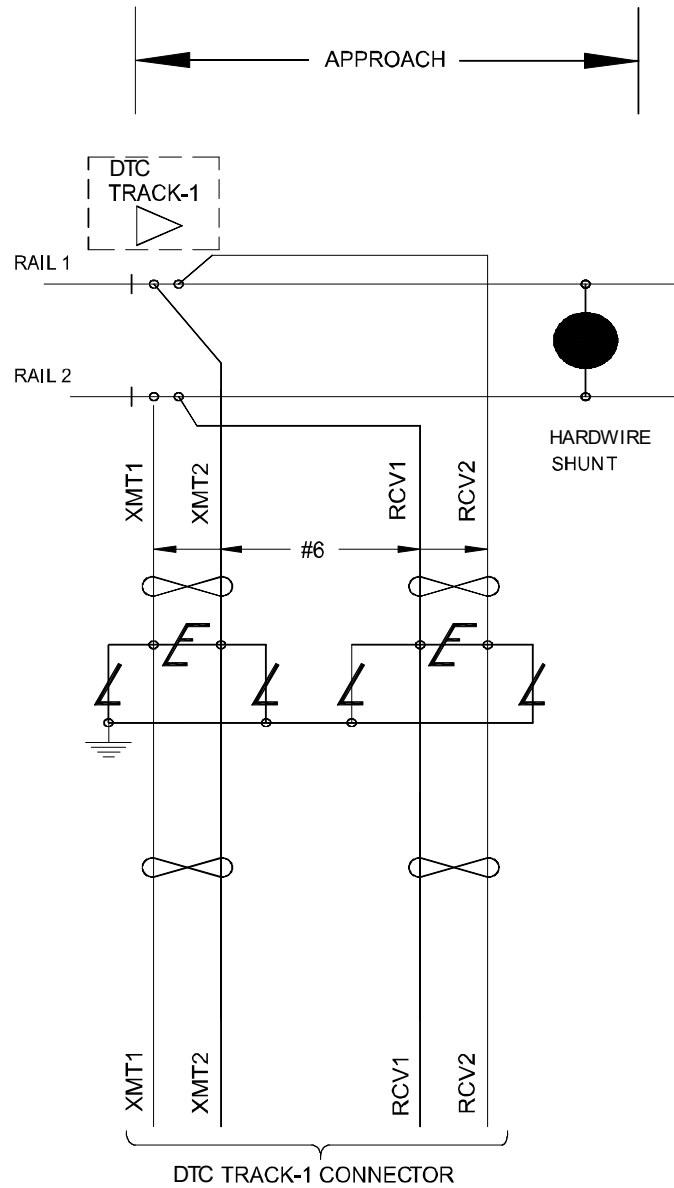

NOTE

1. ALL WIRING #16AWG MINIMUM UNLESS OTHERWISE NOTED. WIRE SIZES SHOWN ARE MINIMUM GAUGE.

LEGEND

- = TWIST TWO TURNS PER FOOT
- = 02270-1X EQUALIZER, H.D.
- = 02585-1X ARRESTER, H.D.
- = UNIDIRECTIONAL DTC

Figure 1-5 Typical Single Track, Unidirectional Application

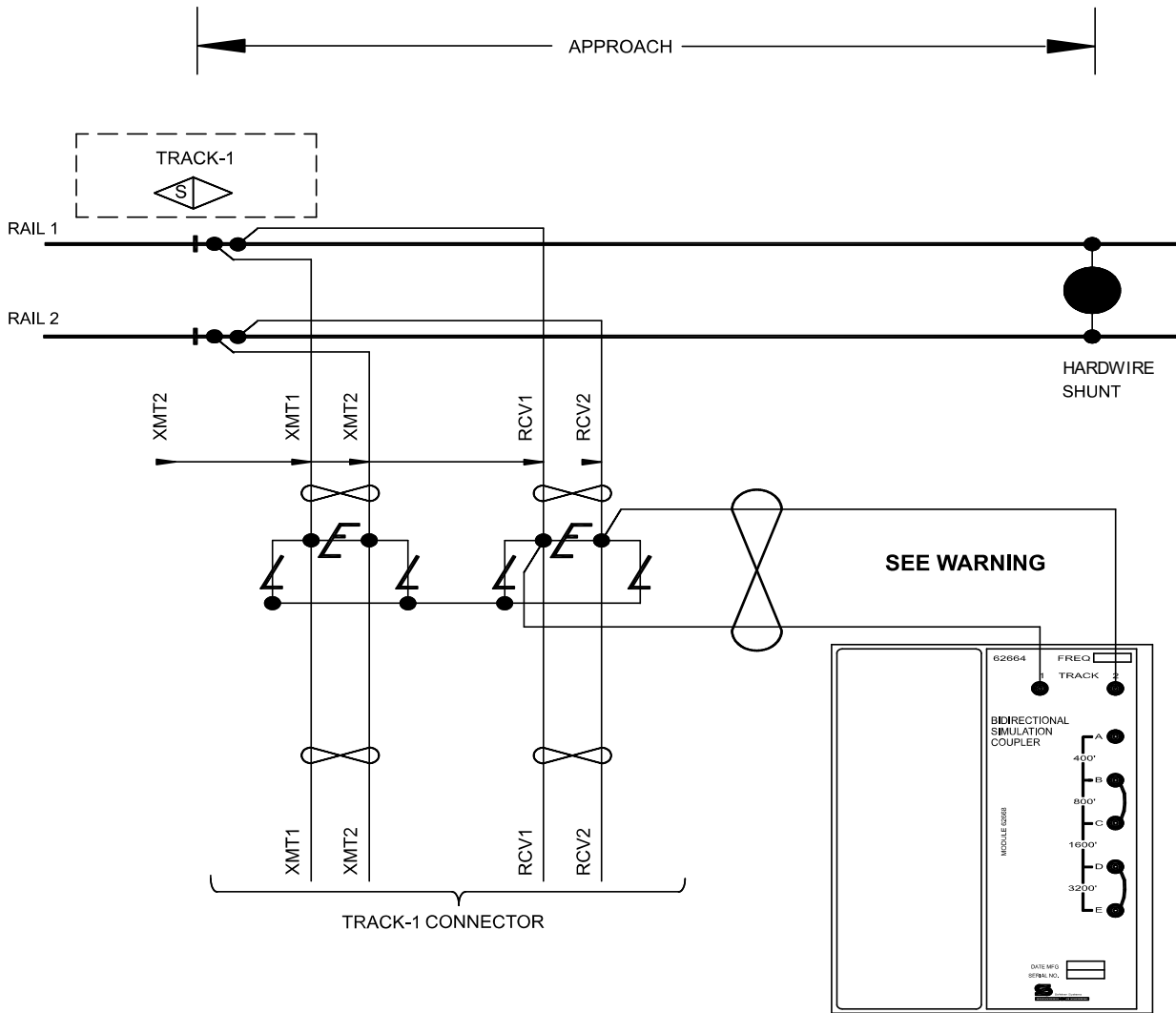

WARNING

FOR FOUR WIRE OPERATION, THE BIDIRECTIONAL SIMULATOR MUST BE WIRED PER PARAGRAPH 3.2

NOTES

1. ALL WIRING #16 AWG MINIMUM UNLESS OTHERWISE NOTED. WIRE SIZES SHOWN ARE MINIMUM GAUGE.

2. BIDIRECTIONAL COUPLERS MUST BE THE SAME FREQUENCY AS THE DTC AND ARE FIELD ADJUSTED TO APPROXIMATE THE DTC APPROACH DISTANCE.

LEGEND

- = TWIST TWO TURNS PER FOOT
- = 02270-1X EQUALIZER, H.D.
- = 02585-1X ARRESTER, H.D.
- = SIMULATED BIDIRECTIONAL DTC

Figure 1-6 Typical Single Track, Simulated Bidirectional Operation Application

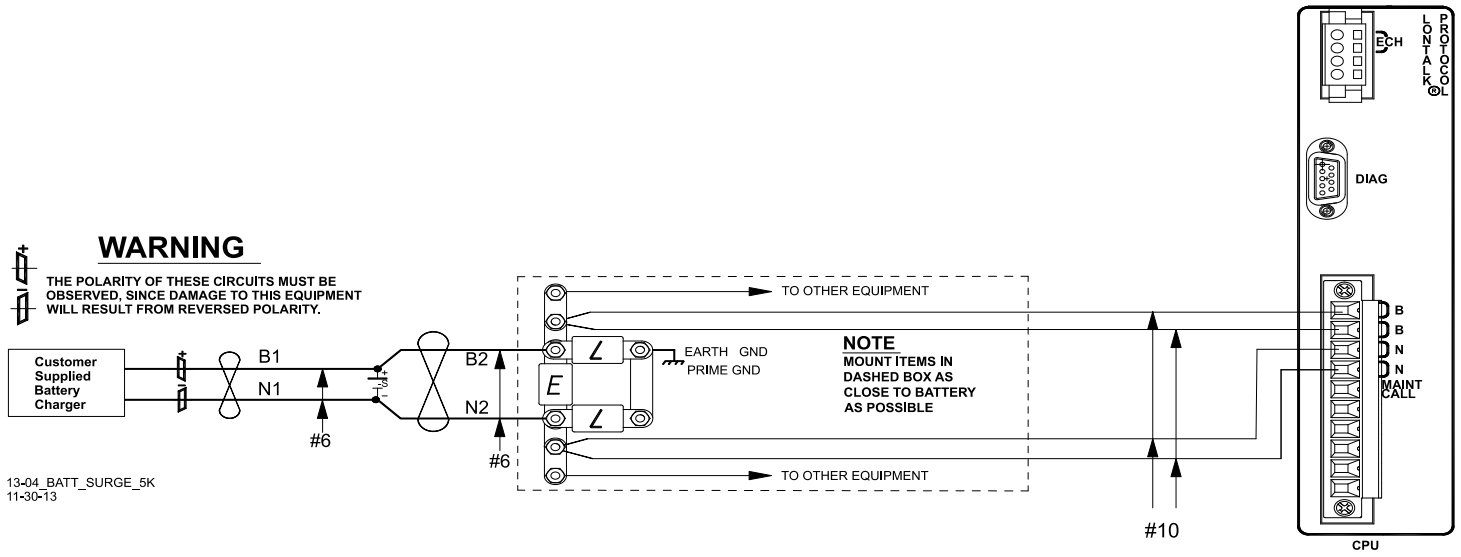

Figure 1-7 Recommended Battery Surge Protection Wiring for DTC

This Page Intentionally Left Blank

SECTION 2 PRIMARY EQUIPMENT DESCRIPTION

2.0 PRIMARY EQUIPMENT DESCRIPTION

This section contains information pertaining to the primary components that make up the DTC.

2.1 GENERAL PHYSICAL DESCRIPTION

Each DTC consists of:

- a case assembly
- a motherboard
- plug-in circuit modules
- plug-in external wiring connectors

2.1.1 Case Assemblies

Each DTC case assembly consists of:

- powder-coated steel case
- backplane-mounted motherboard

Refer to Table 2-1 for key features of each case configuration.

Table 2-1 DTC GCP Case Feature Overview

Case Part No.	Feature	Ref Section
	No. of Track Modules	
A80560	1 to 5 tracks	2.2

2.1.2 Motherboard

The motherboard for each assembly provides:

- DTC unit wiring
- Circuit module connectors
- External Configuration Device Connector(s)
- Chassis Identification Chip socket(s)
- **DIAG** (diagnostic) port connector – not used in DTC applications.
- Interface connectors for external wiring connectors
- Echelon **LONTALK® PROTOCOL** LAN connector
- Ethernet connection

2.1.3 Plug-In Track Circuit Modules

Each DTC track plug-in track circuit module is equipped with:

- Dual 43-pin connector on one edge which plugs into a corresponding edge connector on the motherboard
- Locking ejector levers at the top and bottom of each module to facilitate removal from the case

2.1.4 External Wiring Connectors and Wire Size

All external wiring to a DTC Assembly is by means of plug-in connectors.

The orange cage-clamp connectors for the signal circuits should use 16 to 12 AWG wire.

The orange cage-clamp connector for the LONTALK® LAN (Echelon®) should use communication grade twisted wires of at least 20 AWG. Refer to Echelon manual (COM-00-07-09) for further information.

NOTE

NOTE

Generic spare connectors that are not keyed for specific modules may be ordered. Refer to the catalog for ordering information.

2.1.5 Wire Preparation

Strip insulation from the end of the wire as follows:

Connector Type	Strip Length
Screw terminal	0.28" (7 mm)
Cage clamp	0.32" – 0.35" (8-9 mm)

NOTE

NOTE

Use a stripping tool to accurately set the strip length. The addition of ferrules is not required.

2.1.6 Screw-terminal Connector Wire Insertion

Wires are secured to the screw-terminal connector as follows:

1. Insert the stripped end of a wire into the wire receptor of the connector until it stops
2. Tighten the screw to a torque of 4.5 inch pounds (0.508 Newton meters)

2.1.7 Cage-Clamp Connector Wire Insertion

Wires are secured to the cage-clamp connector as follows:

1. Place a flat bladed screwdriver in the rectangular slot in the connector next to the wire receptor (see figure below)
2. Use a screwdriver blade 0.10 in. wide and 0.020 in. thick (2.5mm x 0.5mm)
3. Lever the wire cage clamp open by pressing straight down on the screwdriver
4. Insert the stripped end of a wire into the fully-open wire receptor until it stops
5. Hold the wire in place and release the screwdriver blade pressure
6. The wire receptor closes on the stripped end of the wire

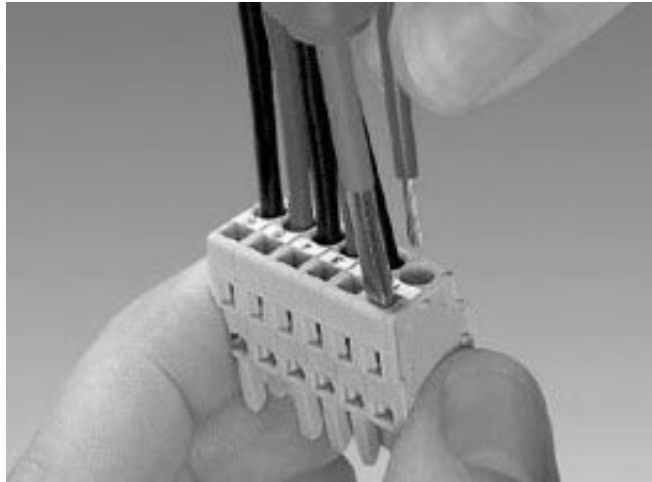

Figure 2-1 Inserting Wires

2.2 A80560 DTC CASE

The DTC Track case is shown in Figure 2-2.

NOTE

NOTE

The module slot allocations shown below the module connectors are assigned for discussion purposes only and do not appear on the actual case assembly.

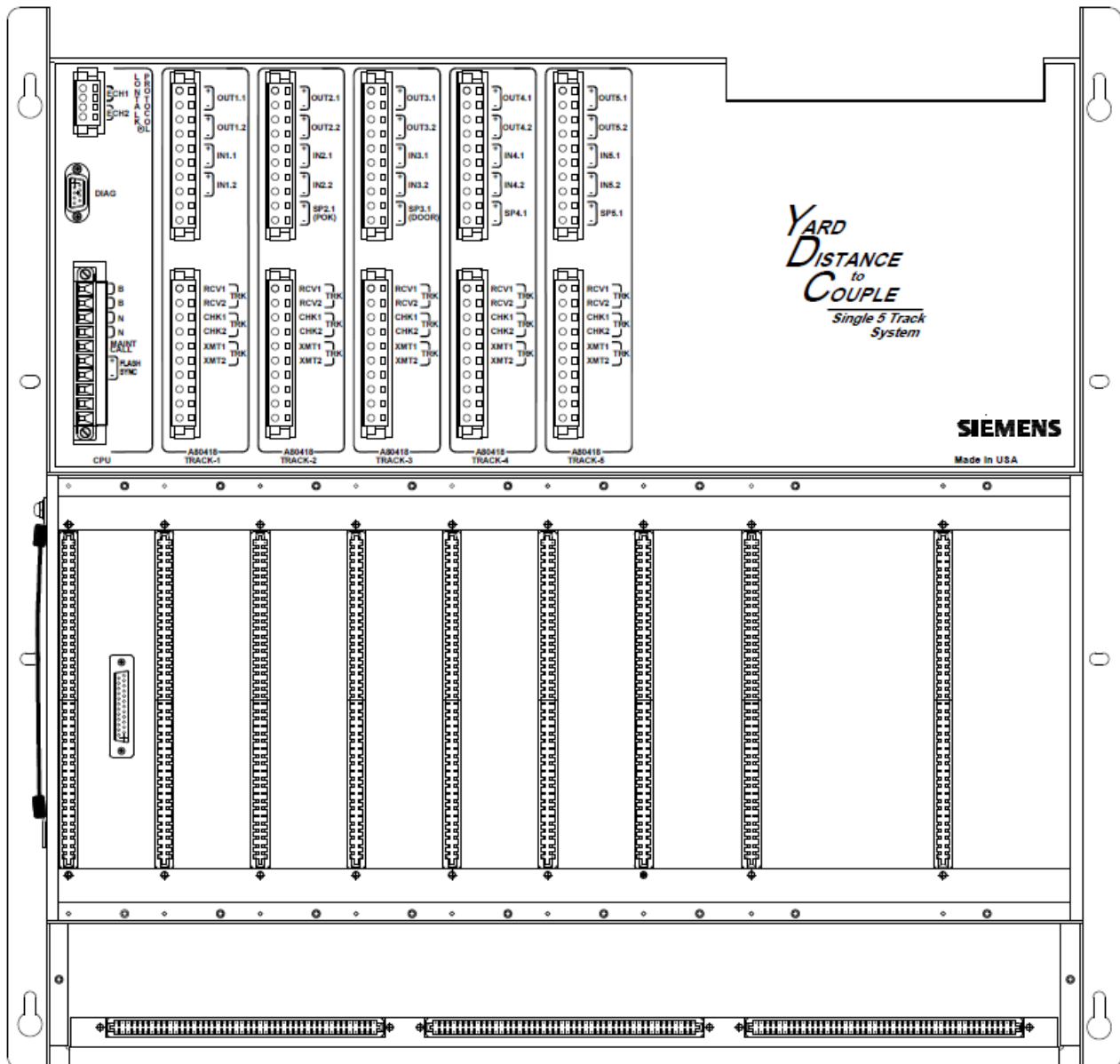

Figure 2-2 A80560 DTC Case

2.2.1 DTC Case Modules and Subassembly

The A80560 case with the following modules installed is shown in Figure 2-3 :

- Central Processor Unit modules in slot positions M1
- Up to five A80418 Track modules in slot positions M2 – M6
- Blank Plates in slots M7 and M8
- A80485 Display Module in slot position M9

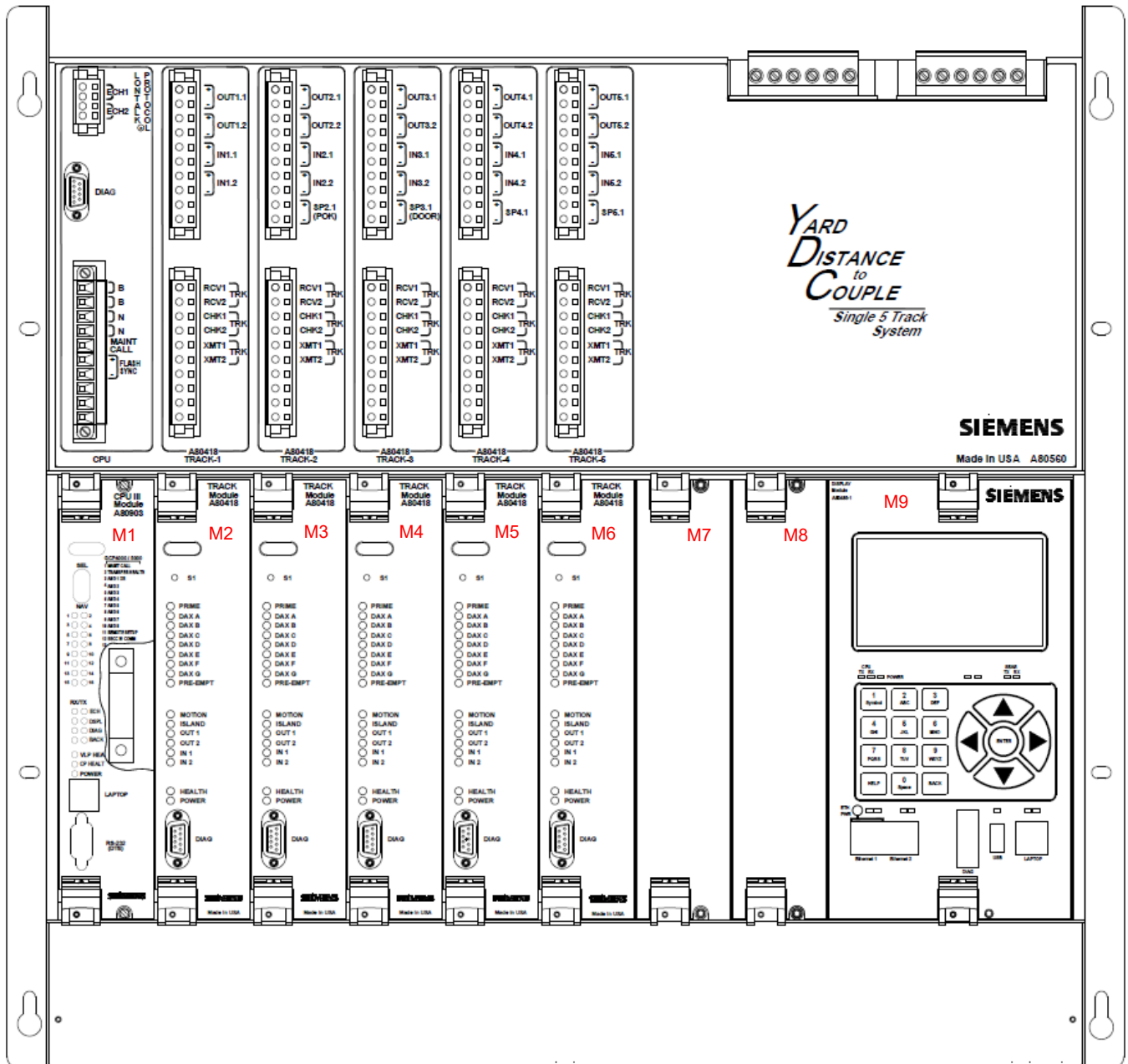

Figure 2-3 A80560 Case with Modules Installed

2.2.2 Interface Connector to Module Relationship

The relationship between the interface connectors and the modules is shown in Table 2-2.

Table 2-2 Module to Interface Connector Relationship

Module	Slot Position	Interface Connector
A80903	M1	CPU
A80418	M2	Track-1
A80418	M3	Track-2
A80418	M4	Track-3
A80418	M5	Track-4
A80418	M6	Track-5
A80485	M9	Display

2.2.3 External Wiring Connectors

The external wiring connectors for the case are shown in Figure 2-4 and described in Table 2-3.

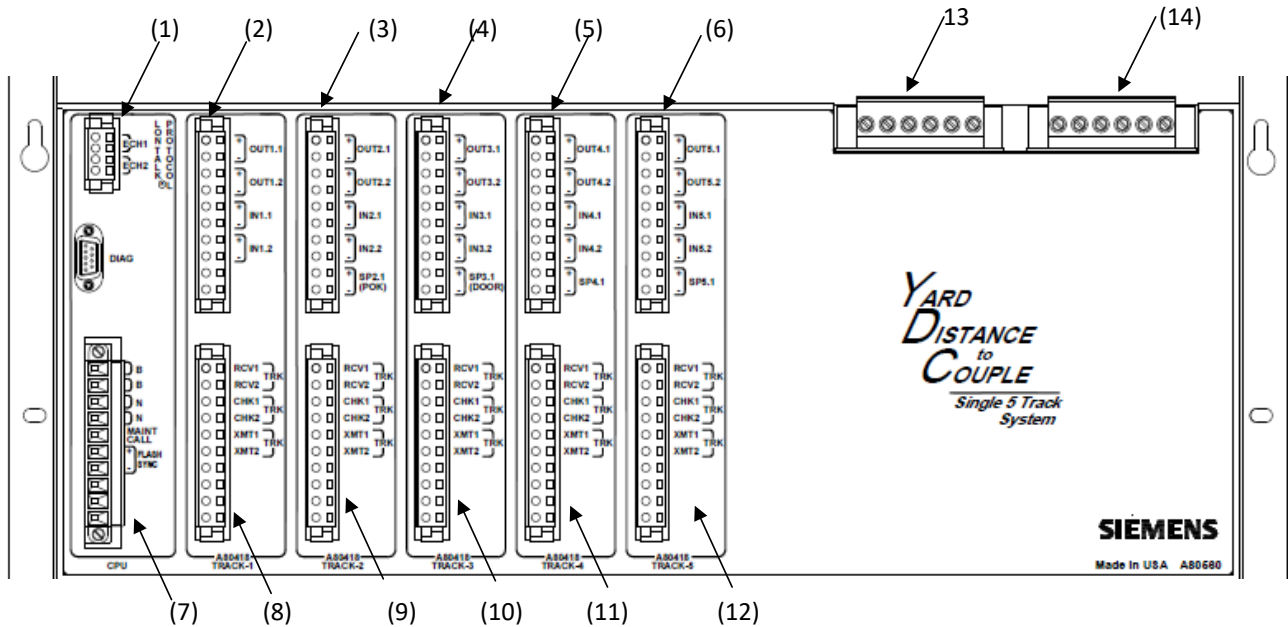

Figure 2-4 External Wiring Connectors

Table 2-3 External Wiring Connectors

Ref No.	Connector Description	Connector Designation	Siemens Part No.
1	4-pin cage clamp, female	LONTALK® PROTOCOL	Z715-09099-0000
2	Keyed 10-pin cage clamp, female	Upper Track-1 – not used in DTC	Z715-02101-0001
3		Upper Track-2 – not used in DTC	Z715-02101-0002
4		Upper Track-3 – not used in DTC	Z715-02101-0003
5		Upper Track-4 – not used in DTC	Z715-02101-0004
6		Upper Track-5 – not used in DTC	Z715-02101-0005
7	Keyed 10-pin cage clamp, female	CPU	Z715-02101-0007
8	Keyed 10-pin cage clamp, female	Lower Track-1	Z715-02101-0008
9	Keyed 10-pin cage clamp, female	Lower Track-2	Z715-02101-0009
10	Keyed 10-pin cage clamp, female	Lower Track-3	Z715-02101-0010
11	Keyed 10-pin cage clamp, female	Lower Track-4	Z715-02101-0011
12	Keyed 10-pin cage clamp, female	Lower Track-5	Z715-02101-0012
13	6-pin screw terminal, male	Not used in DTC	n/a
14	6-pin screw terminal, male	Not used in DTC	n/a

2.3 PLUG-IN MODULES AND SUBASSEMBLIES

2.3.1 CPU Modules, A80903 (CPU III)

The A80903 CPU III module is the central processing unit that:

- provide all logic processing functions for all DTC chassis.
- control Ethernet communications.
- interface with front panel CPU connectors.

2.3.1.1 CPU III Module User Interface

The CPU III front panel is shown in Figure 2-5. The CPU III user interface is described in Table 2-4. (Refer to Section 7 for diagnostics and troubleshooting).

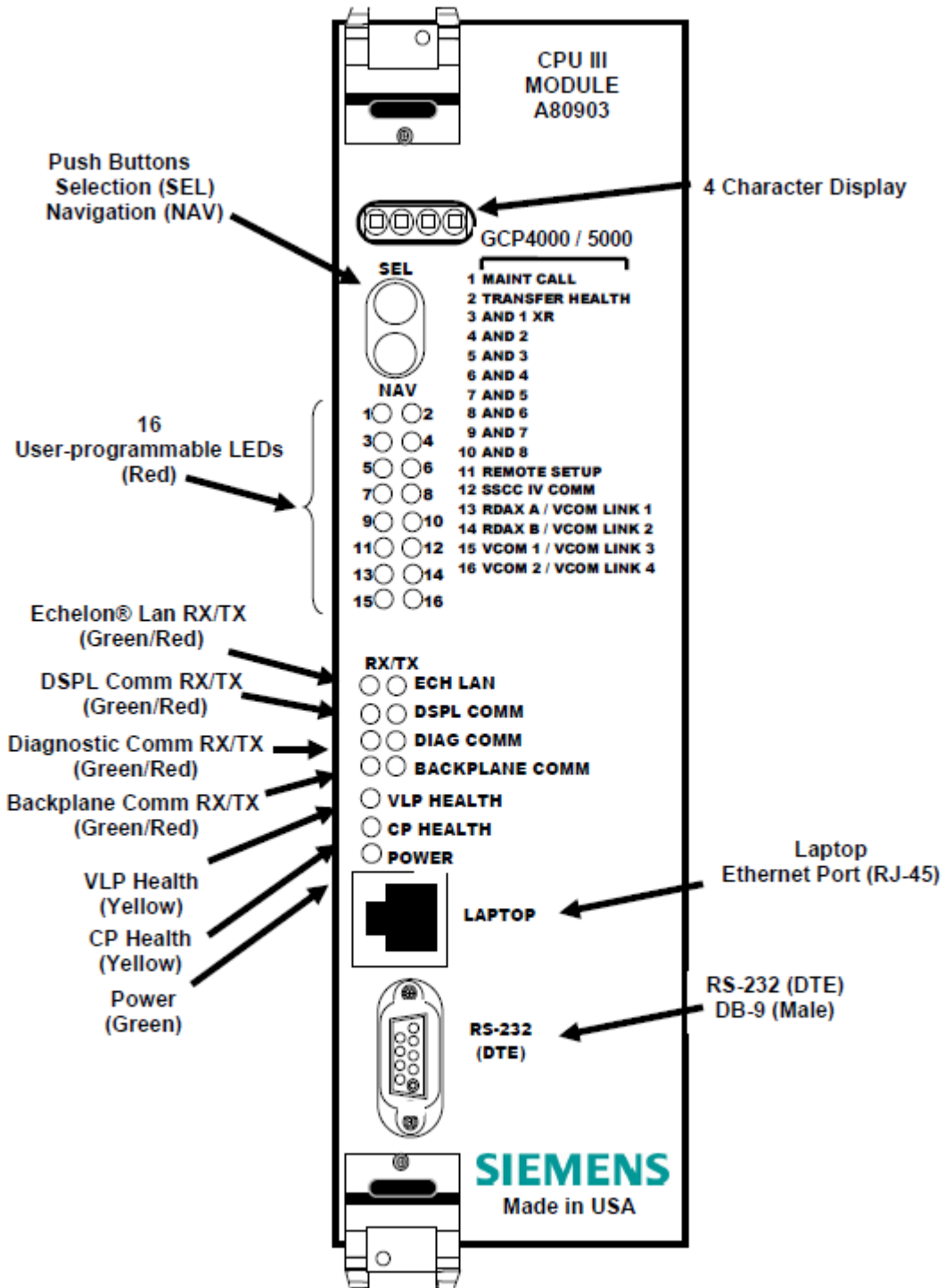

Figure 2-5 CPU III Front Panel

Table 2-4 CPU User Interface

LED		Function	Description
Name	Color		
1 Maint Call	Red	Not used in DTC	
2 Transfer Health	Red		
3 (AND 1 XR)	Red		
4 thru 10 AND 2 to AND 8	Red		
11 Remote Setup	Red		
12 SSCC IV Comm	Red		
13: RDAX A/ VCOM LINK1	Red		
14: RDAX B/ VCOM LINK2	Red		
15: VCOM 1/ VCOM LINK3	Red		
16: VCOM2/ VCOM LINK4	Red		
ECH LAN RX	Grn	Echelon Message Received	Flashes when the CPU is receiving an ATCS message via the Echelon LAN.
ECH LAN TX	Red	Echelon Message Sent	Flashes when the CPU is transmitting an ATCS message via the Echelon LAN.
DSPL COMM RX	Grn	Display Port Message Received	Flashes when the CPU is receiving data from the display module.
DSPL COMM TX	Red	Display Port Message Sent	Flashes when the CPU is sending data to the display module.
DIAG COMM (CP) RX	Grn	Diag Port Message Received	Flashes when the CPU is receiving data from the communications processor diagnostic (DIAG CP) serial port.
DIAG COMM (CP) TX	Red	Diag Port Message Sent	Flashes when the CPU is transmitting data on the communications processor diagnostic (DIAG CP) serial port.
BACK-PLANE COMM RX	Grn	Backplane Message Received	Flashes when the VLP is receiving data from the serial bus.
BACK-PLANE COMM TX	Red	Backplane Message Sent	Flashes when the VLP is sending data onto the serial bus.

VLP HEALTH	Yel	VLP Health Status	Flashes slowly (1Hz) when the CPU VLP is functioning normally.
			Flashes fast (4Hz) when the VLP is unhealthy
CP HEALTH	Yel	CP Health Status	Flashes slowly (1Hz) when the CP is functioning normally.
POWER	Grn	Power Indication	On steadily when power is applied to the module.

2.3.2 Track Module, A80418

The DTC uses the track module with part number 8000-80418-002

The A80418 Track module is used to determine the distance the furthest car is from the track feed points and calculate its speed.

The Track Module frequency can be set to the frequencies listed in Table 2-5.

Vital I/O functions (not used in DTC):

- Two isolated vital inputs.
- Two isolated vital outputs.

Table 2-5 Track Frequencies

Standard Track Frequencies (Hz):	86, 114, 156, 211, 285, 348, 430, 525, 645, 790, 970
Offset Track Frequencies (Hz):	85.5, 86.5, 87, 113, 113.5, 114.5, 115, 155, 155.5, 156.5, 157, 210, 212, 284, 286, 347, 349, 429, 431, 523, 527, 643, 647, 788, 792, 968, 972
Other Track Frequencies (Hz): (for compatibility with other manufacturer’s equipment and for areas where power line interference is a problem)	44, 45, 46, 141, 149, 151, 237, 239, 249, 250, 267, 326, 392, 452, 522, 560, 630, 686, 753, 816, 881, 979, 999

2.3.2.1 Track Module Front Panel

The Track module front panel is shown in Figure 2-6. The user interface is described in Table 2-6.

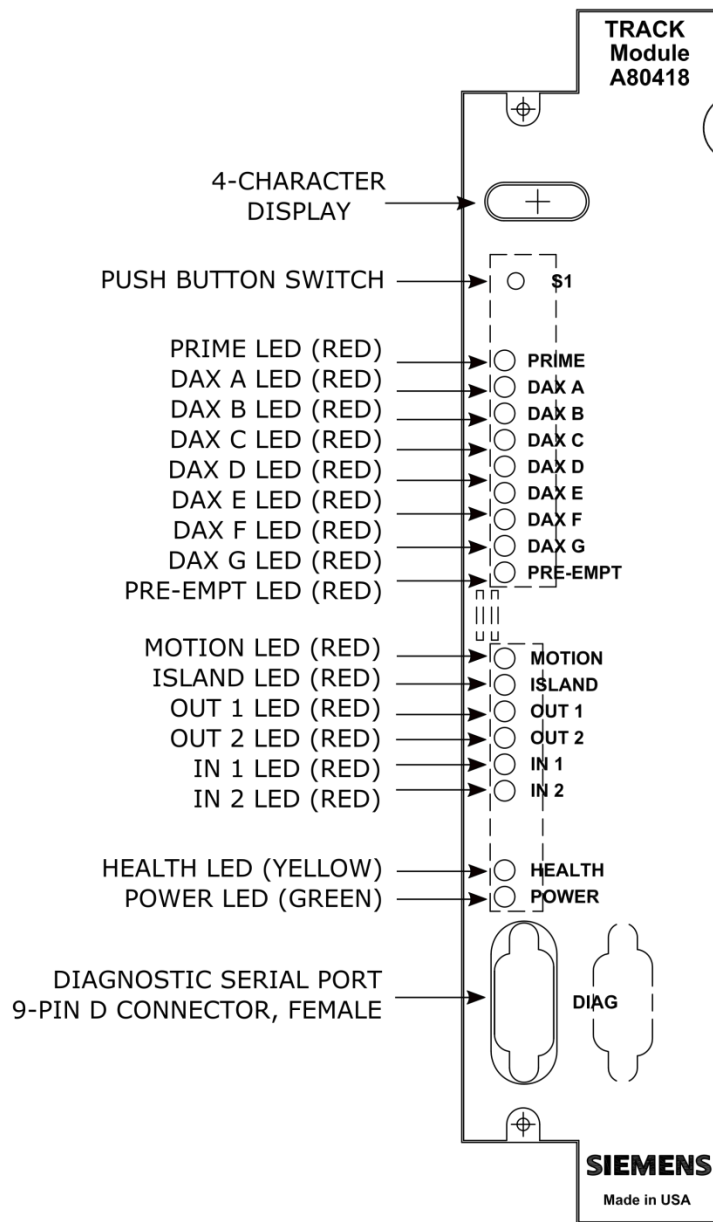

Figure 2-6 Track Module Front Panel

Table 2-6 Track Module User Interface

Component	Function
4-Character Display	Displays module, track status, and diagnostic messages. Refer to: Table 7-6, Normal Messages Table 7-7, Calibration Messages Table 7-8, Diagnostic Messages
S1 Push Button Switch	Freezes scrolling parameters.
PRIME LED (red)	Off – not used in DTC applications
DAX A – DAX G LEDS (red)	Off – not used in DTC applications
PRE-EMPT LED (red)	Off – not used in DTC applications
MOTION LED (red)	not used in DTC applications (may be on or off)
ISLAND LED (red)	Off - not used in DTC applications
OUT 1 LED (red)	Off - not used in DTC applications
OUT 2 LED (red)	Off - not used in DTC applications
IN 1 LED (red)	Off - not used in DTC applications
IN 2 LED (red)	Off - not used in DTC applications
HEALTH LED (yellow)	Slow (1Hz) – module is healthy and communicating with CPU Fast (2Hz) – module is healthy but not communicating with the CPU Very Fast (4Hz) – module is unhealthy and communicating with CPU
POWER LED (green)	LED is on steady when power is applied to the module
DIAG Serial Port	9-pin diagnostic serial port for Track module

2.3.3 Display Module, A80485-1

The A80485-1 display module, Figure 2-7, provides a keypad and display which allows:

- Configuration programming
- Application programming
- Calibration programming
- System diagnostics
- System parameter display
- Track status display

NOTE

NOTE
Refer to Section 7.3, for detailed instructions on the Display module.

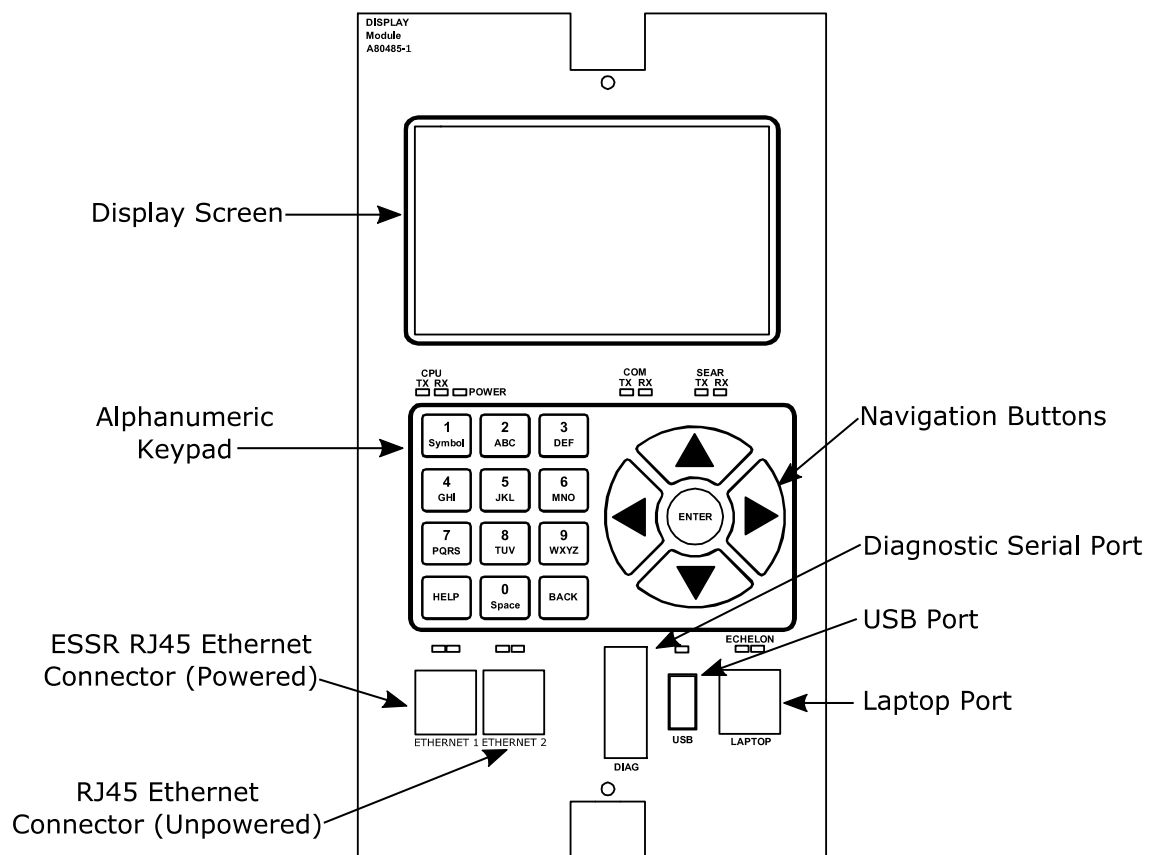

Figure 2-7 Display Module

2.3.4 External Configuration Device (ECD) A80435

The ECD is a factory installed plug-in device on the DTC backplane (see Figure 2-8). The ECD stores the module configuration file (MCF) application program for the product.



WARNING

IF AN ECD IS REPLACED WITH AN ECD CONTAINING A DIFFERENT MCF, THE GCP WILL COPY THE NEW MCF INTO THE FLASH ON THE CPU MODULES AND SET THE SYSTEM BACK TO DEFAULT VALUES.

2.3.5 Chassis Identification Chip (CIC)

The CIC is:

- A non-volatile memory chip.
- Installed adjacent to the ECD on the GCP backplane (see Figure 2-8).



WARNING

IF THE CIC IS REPLACED, THE USER MUST SET THE SYSTEM BACK TO DEFAULTS AND REPROGRAM THE SYSTEM. FAILURE TO DO THIS COULD RESULT IN THE SYSTEM RUNNING WITH THE WRONG CONFIGURATION FOR THE SITE.

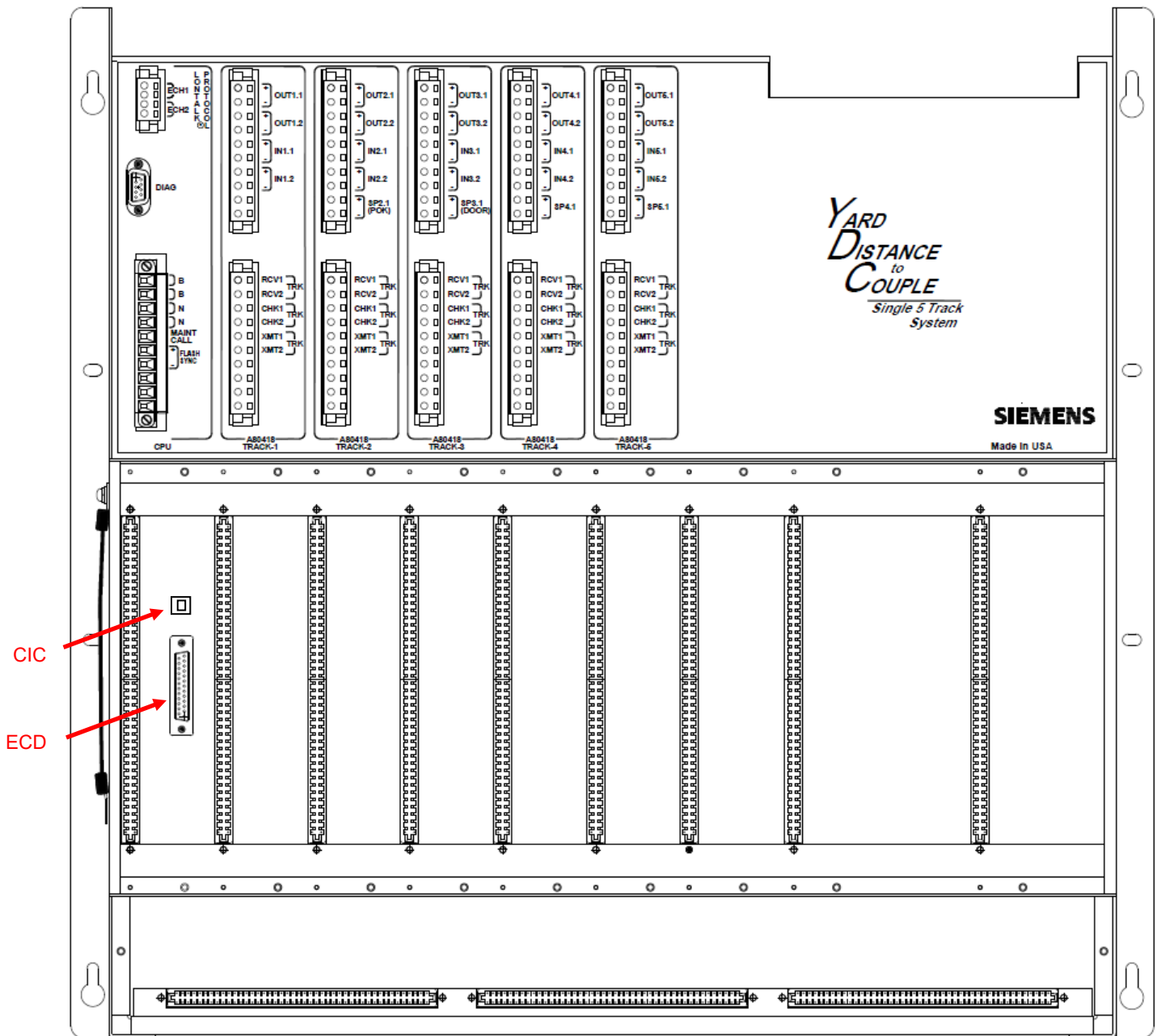

Figure 2-8 Typical ECD and CIC Locations on Backplane

2.3.6 Interface Connector Functions

The DTC interface connector functions are described in Table 2-7.

2.3.6.1 CPU Connectors

Table 2-7 CPU Connectors

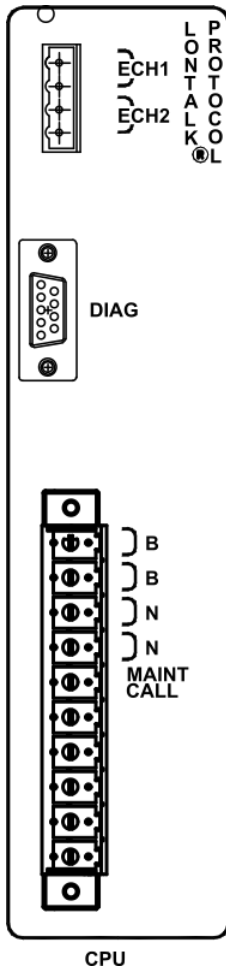

Connector	Pinout	Function
LONTALK® PROTOCOL	ECH1	LAN Twisted pair
	ECH2	LAN Twisted pair
DIAG	2	DT_TX - not used in DTC applications
	3	DT_RX - not used in DTC applications
	5	GROUND - not used in DTC applications
CPU	B	Battery B input to GCP
	N	Battery N input to GCP
	MAINT CALL	Not used in DTC applications

2.3.6.2 Track Connectors

Table 2-8 shows connectors for Track 1. Track 2 through 5 are similarly labeled.

Table 2-8 Track 1 Connectors

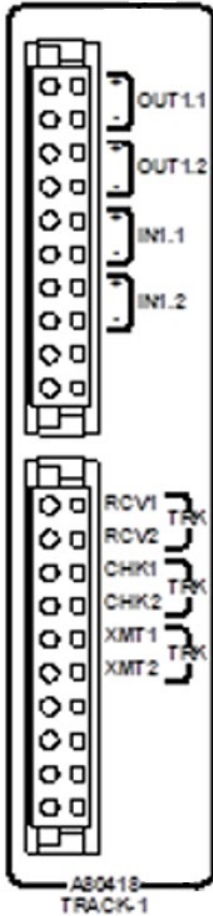

Connector	Pinout*		Function
TRACK-1	+	OUT 1.1	Not used in DTC
	-		
	+	OUT 1.2	Not used in DTC
	-		
	+	IN 1.1	Not used in DTC
	-		
	+	IN 1.2	Not used in DTC
	-		
	+		Not used in DTC
	-		Not used in DTC
		TRK RCV1	Receiver input from track
		TRK RCV2	
		TRK CHK1	Check wires not used in DTC
		TRK CHK2	
	TRK XMT1	Transmit output to track	
	TRK XMT2		

2.4 LAN COMMUNICATIONS

The LONTALK® LAN (Echelon®) is not used on the DTC.

This Page Intentionally Left Blank

SECTION 3 AUXILIARY EQUIPMENT

3.0 GENERAL

The equipment described in this section can be used with the DTC. Where applicable, installation and adjustment information are provided.

3.1 AUXILIARY EQUIPMENT COVERED

The following equipment is covered in this section:

- Bidirectional Simulation Coupler, 62664-Mf
- Surge Panels, 80026-XX

CAUTION

CAUTION

THE DEVICES DESCRIBED HERE MUST BE MOUNTED IN WEATHERPROOF ENCLOSURES UNLESS STATED OTHERWISE.

NOTE

NOTE

Some equipment shown may no longer be available and is displayed for informational purposes only.

3.2 BIDIRECTIONAL SIMULATION COUPLER, 62664-MF

The DTC is normally operated unidirectionally, however a technique referred to as bidirectional simulation can be applied to a unidirectional installation to obtain the operating benefits of a bidirectional application. To configure the track for this mode set the 'Uni/No/Sim-Bidirnl' setting on the tracks GCP Frequency page in the System Settings to 'Sim. Bidirnl', see Figure 5-3.

When the DTC track is set a simulated bidirectional its allows the DTC to use bidirectional rules while connected to a set of non-bypassed insulated joints.

Low ballast resistance effectively reduces approach distances to a greater degree in unidirectional DTC installations than in bidirectional installations.

The 62664 bidirectional simulation coupler must not be used as a termination shunt.

The 62664 plug-in module frequency must be the same as the DTC track frequency.

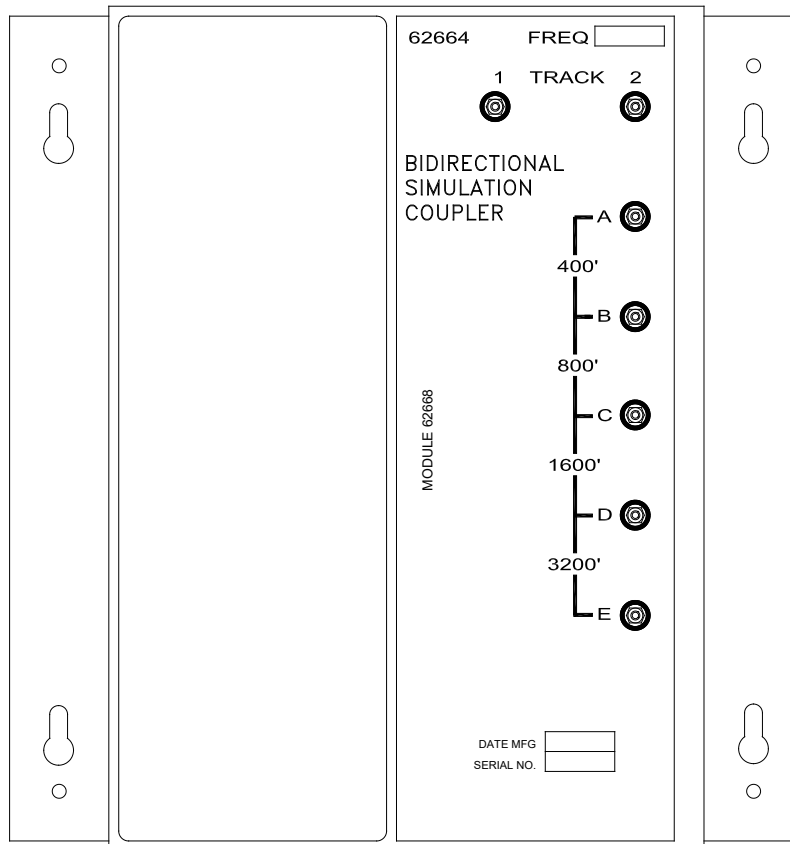

13-04_BIRDN_SIM_CPLR
12-09-13

Figure 3-1 Bidirectional Simulation Coupler, 62664-MF

3.2.1 Simulated Bidirectional Coupler Configuration

The 62664 Bidirectional Simulation Coupler (Figure 3-1) is a convenient, compact, shelf- or backboard-mounted unit containing:

- A narrow-band Shunt of the same frequency as the DTC track module (note that a narrow band needed in the coupler, though the approach should be terminated with a hard wire shunt as described in Section 1.2.4).
- An adjustable inductor (simulated track).

The Bidirectional Simulation Coupler is housed in a brushed aluminum case and consists of:

- A single plug-in type printed circuit board that is available in 12 fixed frequencies.
- Four series-connected, toroid-wound inductors. Each inductor simulates a specific track length and is tapped and connected to the front panel terminals.

The front panel terminals allow simulated approach distances to be selected that closely match the actual track approach:

- Approach distances ranging from 400 to 6,000 feet (122 – 1829 meters) may be selected using terminal shorting straps.
- The available simulated approach distances and the corresponding shorting strap terminal positions for the 62664 are shown in Table 3-1.

Table 3-1 Approach Distance Selection Strapping For Bidirectional Simulation Coupler, 62664-MF

DISTANCE (FT/M)	STRAP TERMINALS	DISTANCE (FT/M)	STRAP TERMINALS
400/122	B-C, C-D, D-E	3,600/1098	B-C, C-D
800/244	A-B, C-D, D-E	4,000/1220	A-B, C-D
1,200/366	C-D, D-E	4,400/1342	C-D
1,600/488	A-B, B-C, D-E	4,800/1464	A-B, B-C
2,000/610	B-C, D-E	5,200/1585	B-C
2,400/732	A-B, D-E	5,600/1707	A-B
2,800/854	D-E	6,000/1829	No Straps
3,200/976	A-B, B-C, C-D		

The bidirectional simulation coupler is connected to the two transmit leads as shown in Figure 3-2. Mounting dimensions for the bidirectional simulation coupler are provided in Figure 3-3. Specifications for the bidirectional simulation coupler are as depicted in Table 3-2.

Table 3-2 Bidirectional Simulation Coupler, 62664-MF

Parameter	Value
Environmental	-40°F to +160°F (-40°C to +71°C)
Dimensions	8.75 inches (22.225 centimeters) high 8.50 inches (21.590 centimeters) wide 9.25 inches (23.495 centimeters) deep
Weight	5 pounds (2.27 kilograms) (approximate)
Adjustment Range	400 to 6,000 feet (122 – 1829 meters)
Loading Effect	Loading effects of the internal narrow-band Shunt are equivalent to that of the 62775 narrow-band Shunt.

NOTE**NOTE**

The adjustment range must be within $\pm 10\%$ of actual approach distance.

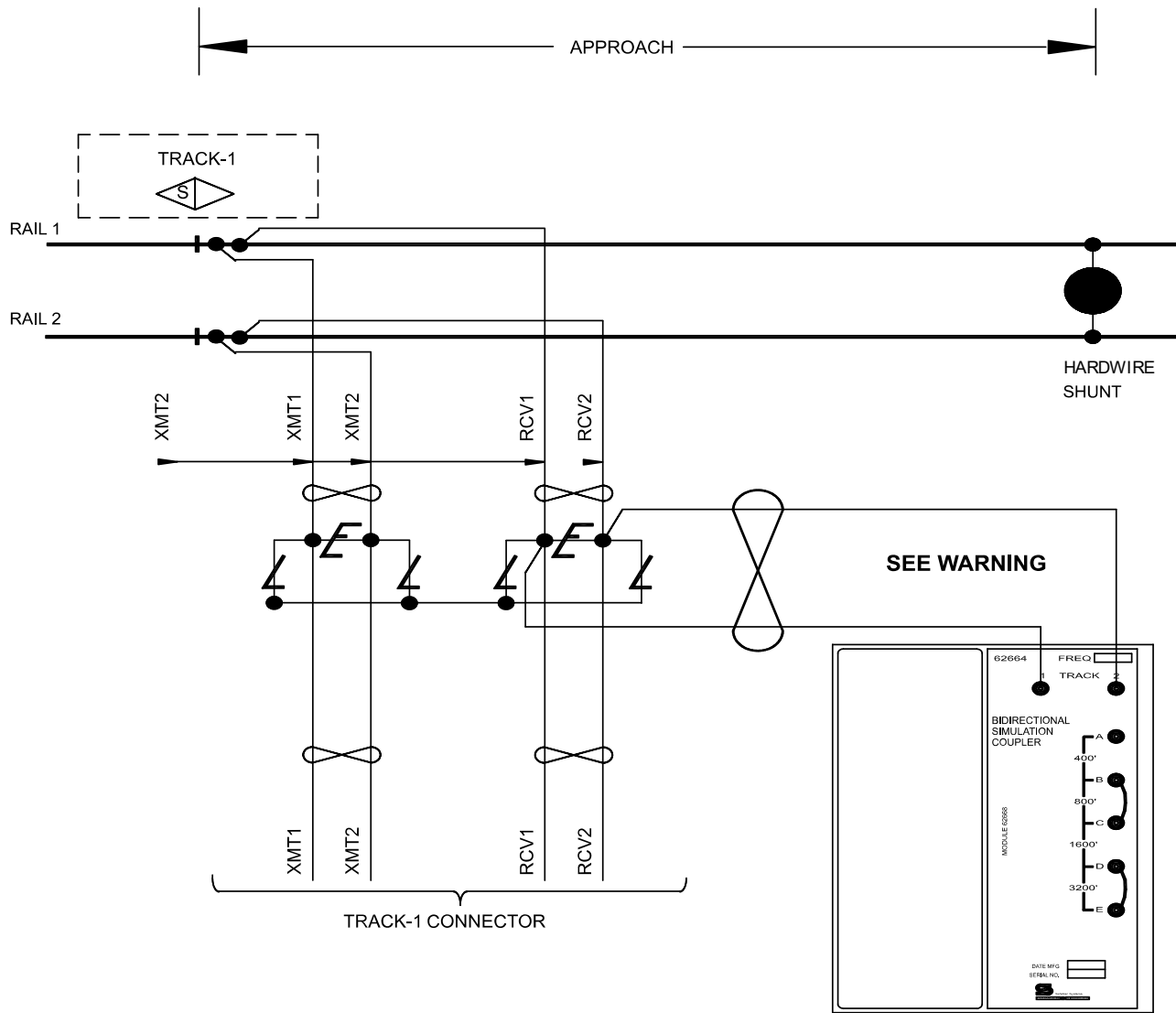

WARNING
FOR FOUR WIRE OPERATION, THE BIDIRECTIONAL SIMULATOR MUST BE WIRED PER PARAGRAPH 3.2

NOTES

1. ALL WIRING #16 AWG MINIMUM UNLESS OTHERWISE NOTED. WIRE SIZES SHOWN ARE MINIMUM GAUGE.

2. BIDIRECTIONAL COUPLERS MUST BE THE SAME FREQUENCY AS THE DTC AND ARE FIELD ADJUSTED TO APPROXIMATE THE DTC APPROACH DISTANCE.

LEGEND

= TWIST TWO TURNS PER FOOT

= 02270-1X EQUALIZER, H.D.

= 02585-1X ARRESTER, H.D.

= SIMULATED BIDIRECTIONAL DTC

Figure 3-2 4-Wire Connection using Bidirectional Simulation Coupler on DTC Operating in Bidirectional Simulation Mode

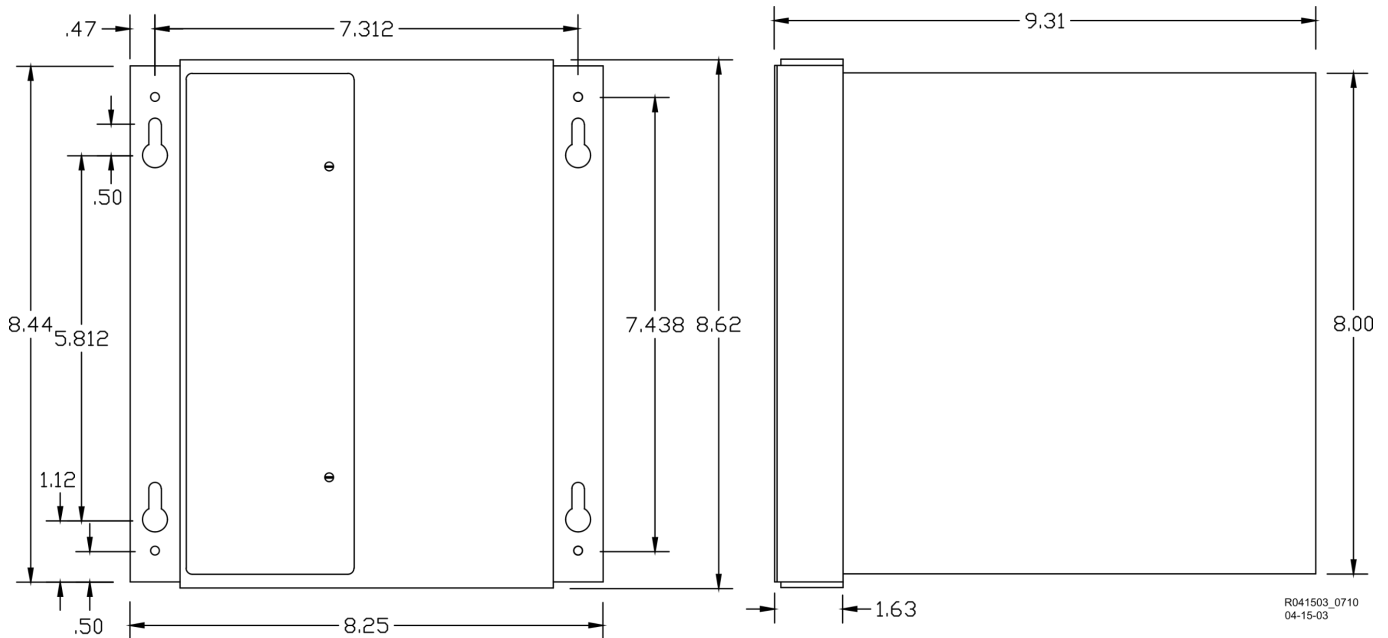

Figure 3-3 Bidirectional Simulation Coupler Assembly Mounting Dimensions

3.3 SURGE PANELS, 80026-XX

The 80026-XX Surge Panels are available in a combination of equalizers and arresters to provide protection for battery and/or track circuits.

WARNING

WARNING

ANY ALTERNATIVE SURGE PROTECTION DEVICE MUST BE ANALYZED TO ENSURE THAT FAILURE MODES OF DEVICE DO NOT COMPROMISE SAFETY OF THE DTC SYSTEM. FOR EXAMPLE, BUT NOT LIMITED TO UNINTENTIONAL EARTH GROUNDS ON CONTROL CIRCUITS OR SHORTS ON TRACK CIRCUITS.

3.3.1 Surge Panel Configurations

Surge Panel units are provided in a variety of configurations to meet specific customer requirements. Wall mounted and rack mounted surge panel applications are listed in Table 3-3.

NOTE

NOTE

For surge protection requirements not listed or for custom designed Surge Panels, contact Siemens Technical Support.

3.3.2 Surge Panel Nomenclature and Mounting Dimensions

Surge panel nomenclature and mounting dimensions are provided on the figures identified in Table 3-3.

3.3.3 Surge Panel Arresters



WARNING
DO NOT MOUNT ARRESTERS WITH ELECTRODES POINTED IN THE DOWN POSITION, TO MINIMIZE THE POTENTIAL OF SHORT CIRCUIT.

A typical Surge Panel arrester is shown in Figure 3-4.

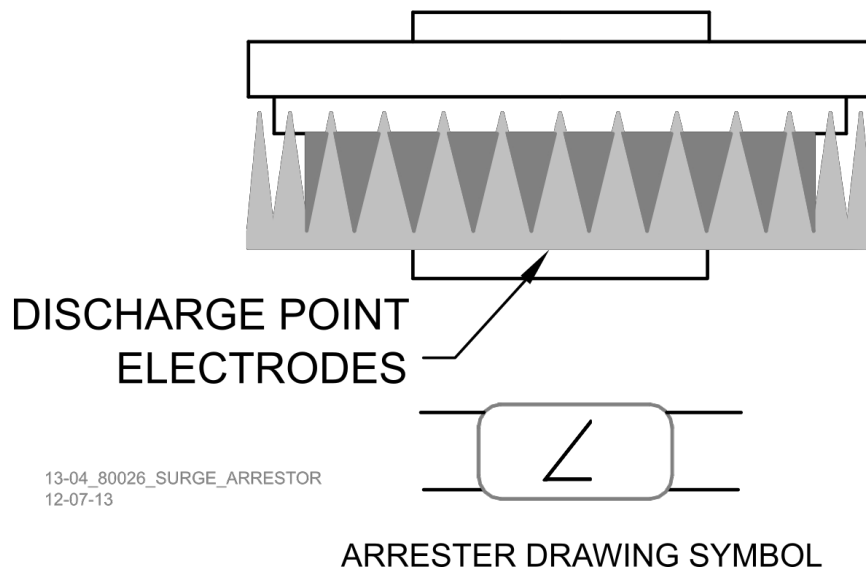

Figure 3-4 Typical 80026 Surge Panel Arrester Mounting Position

Table 3-3 Wall and Rack Mounted Surge Panels

Part No.	Figure	Description	Dimensions	Weight
80026-01	Figure 3-5	Protects 1 battery and 1 track circuit.	Height: 13.5 in (34.29 cm) Width: 5.69 in (14.453 cm) Depth: 3.625 in (9.208 cm)	6 lb. (2.72 kg) (approximate)
80026-02	Figure 3-5	Protects 1 track circuit. Use with -1 panel for subsequent track protection.	Height: 8.75 in (22.23 cm) Width: 5.69 in (14.453 cm) Depth: 3.625 in (9.208 cm)	4 lb. (1.82 kg) (approximate)
80026-31	Figure 3-6	Protects 1 track and 1 battery circuit.	Height: 4.96 in (12.598 cm) Width: 23 in (58.42 cm) Depth: 4.535 in (11.519 cm)	5 lb. (2.26 kg) (approximate)
80026-32	Figure 3-6	Protects 1 track and 1 battery circuit. Use with -31 panel for subsequent track and battery circuit protection.	Height: 4.96 in (12.598 cm) Width: 23 in (58.42 cm) Depth: 4.535 in (11.519 cm)	6 lb. (2.72 kg) (approximate)
80026-34	Figure 3-7	Protects 1 track circuit. Use with -31 panel for subsequent track circuit protection.	Height: 4.96 in (12.598 cm) Width: 23 in (58.42 cm) Depth: 4.535 in (11.519 cm)	6 lb. (2.72 kg) (approximate)
80026-35	Figure 3-7	Protects 2 track circuits.	Height: 4.96 in (12.598 cm) Width: 23 in (58.42 cm) Depth: 4.535 in (11.519 cm)	7 lb. (3.18 kg) (approximate)

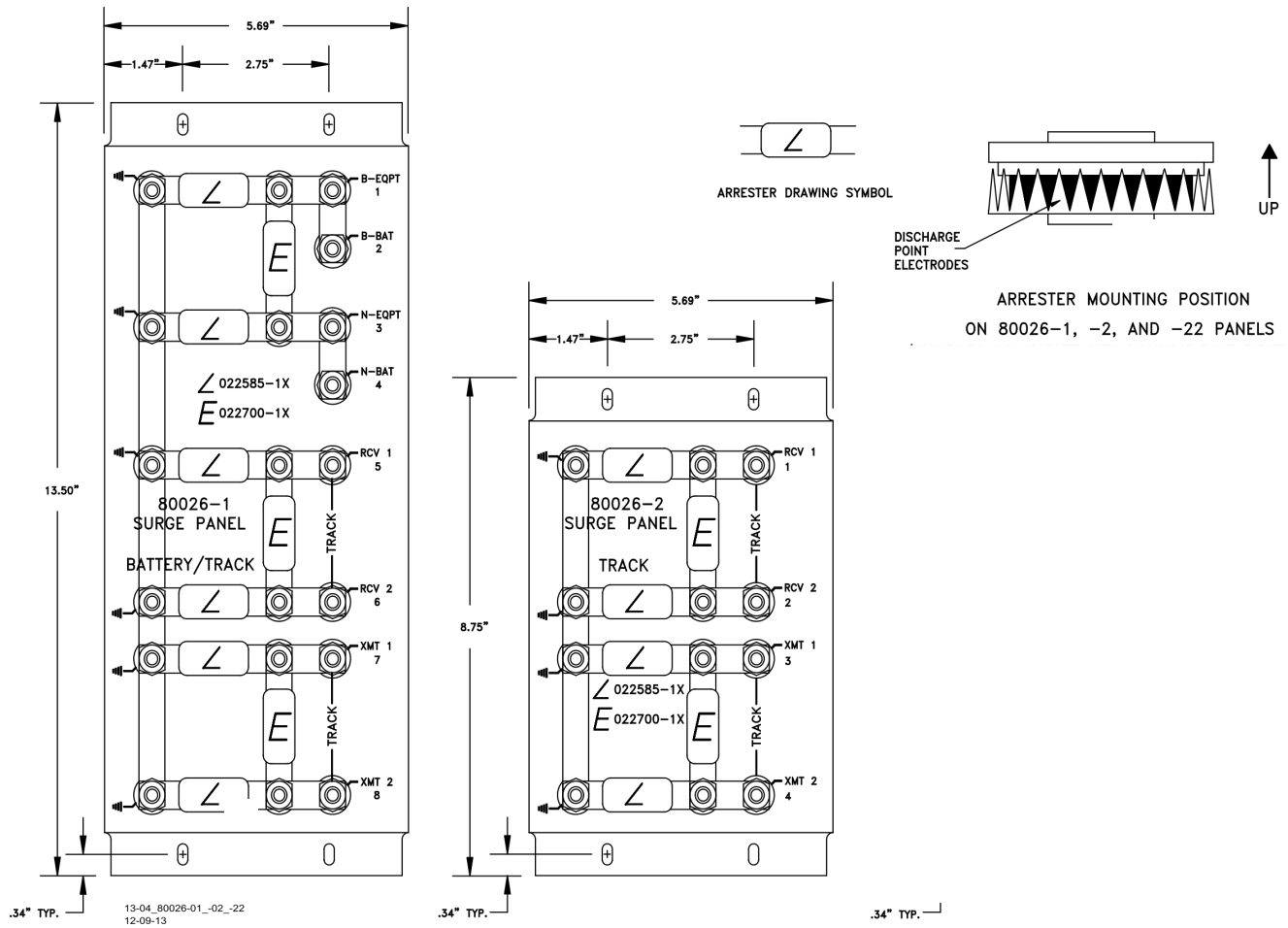
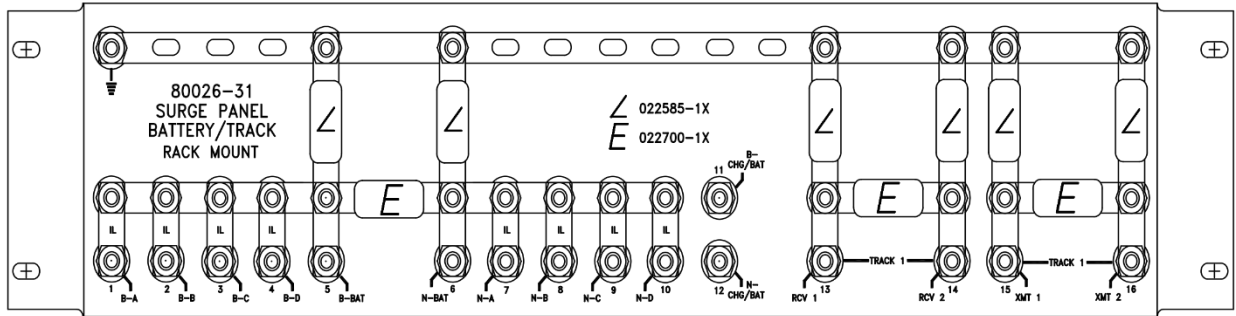
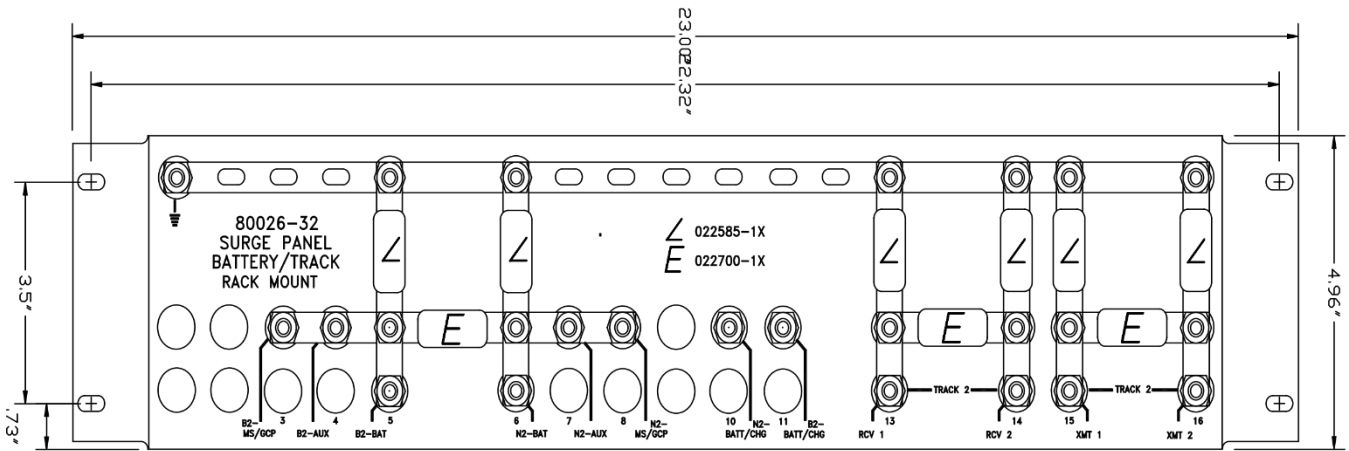

Figure 3-5 Wall Mounted Surge Panels, 80026-01 and -02



NOTE:
DIMENSIONS TYPICAL OF BOTH PANELS



13-04_80026-31_AND_32
12-09-13

Figure 3-6 Rack Mounted Surge Panels, 80026-31 and -32

NOTE:
DIMENSIONS TYPICAL OF BOTH PANELS

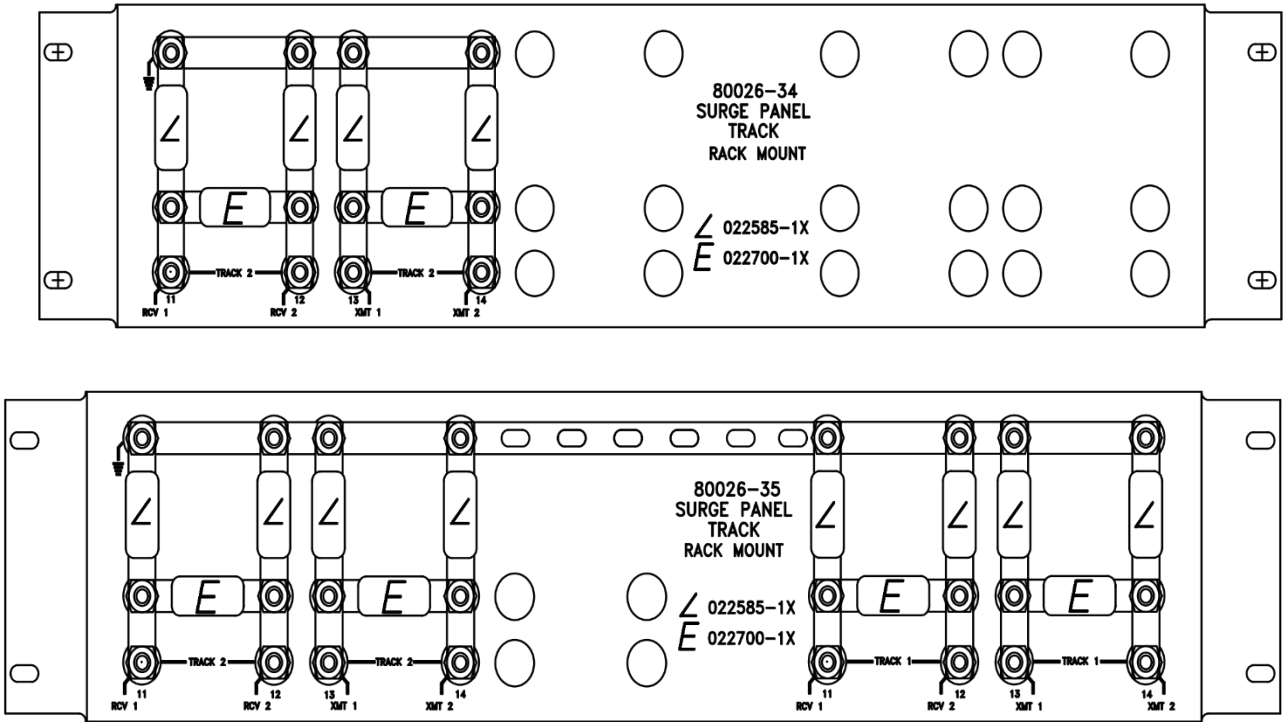

Figure 3-7 Rack Mounted Surge Panels, 80026-34 and -35

SECTION 4 DISPLAY MENU SCREENS

4.0 GENERAL

NOTE**NOTE**

The Display module software used in the DTC is identical to that used in Siemens GCP product line, thus it refers to the DTC as a GCP, and the modules as GCP modules.

4.1 DISPLAY MODULE

The display module provides the user interface that allows:

Status and Diagnostic Monitoring:

- Viewing track status (EZ, EX, speed)

DTC configuration:

- Upload a configuration package (PAC) file to the CPU III from the Display's USB drive, or from the Web User Interface (WebUI),
- Download the configuration package (PAC) file from the CPU III and save it on the Display's USB drive or to the user's PC via the Web User Interface (WebUI).
- Note that the PAC file contains only the System Programming and Site Programming. If the PAC file is used to set or restore the configuration, the Display Programming or CP Programming (such as DTC interface settings) will need to be configured separately.

Software installation to include the following types of software:

- Module Configuration File (MCF) for the CPU III module
- Module Executive Files (MEF) to the CPU III and Track modules
- Non-Vital Executive Files to the Display

Generate, and copy the following reports:

- Configuration (Config) Report

Generate, and copy the following logs

- Event Log
- Diagnostic Log

4.2 DISPLAY SCREENS

The Display portrays five top-level menu screens.

- System View
- IO View
- Program View
- Diags & Reports
- USB Menu (When USB Stick is inserted in slot on Display Module)

To navigate these menu screens:

- Press a number to go to the indicated submenu
- Use the up and down keys to change the highlighted menu, then press **Enter**
- Use the right and left arrows to move from one screen to the next in a cyclical order

Use the **Back** key to go back up to a higher menu. Use the 0 key to move back to the top level Main program menu. Holding the back key for 3s in any screen will navigate back to the top of the menu tree, and then the left and right arrows can be used to get back to the system view.

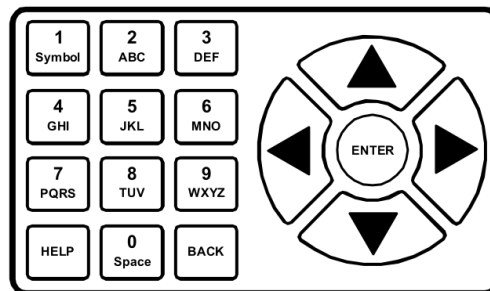

Figure 4-1 Display Keypad

4.2.1 System View Screen

The System View screen provides information regarding the status of:

- Track Data section which shows the status of the used tracks
- Status bar Indication of
 - Main /Standby (only main applicable to DTC)
 - Crossing controller status (SSCC) (not applicable to DTC)
 - XR status (not applicable to DTC)

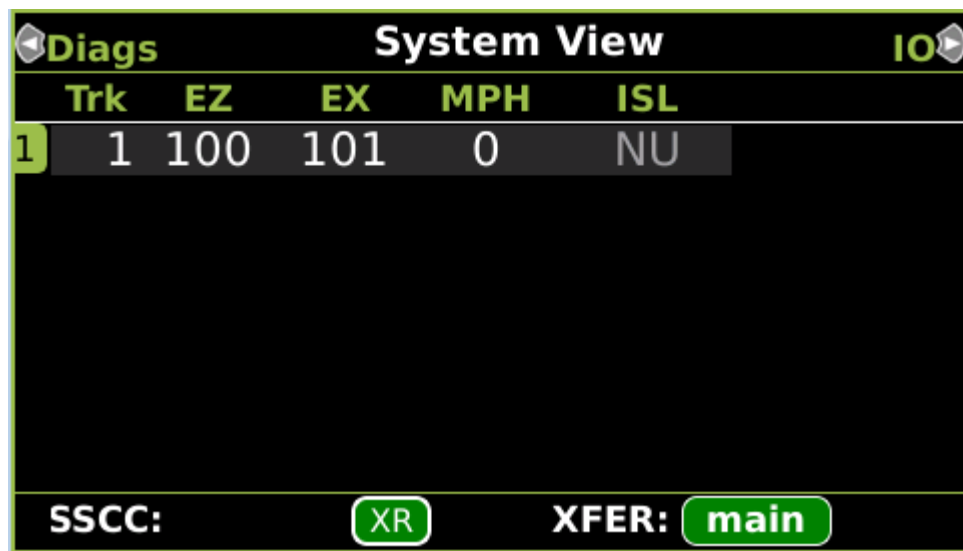

Figure 4-2 Display System View Screen

To return to the System View screen from any other screen in the menu system:

- hold the back key for 3 seconds; this takes the user back to the top level menus.
- press right/left arrow keys until System View displays.

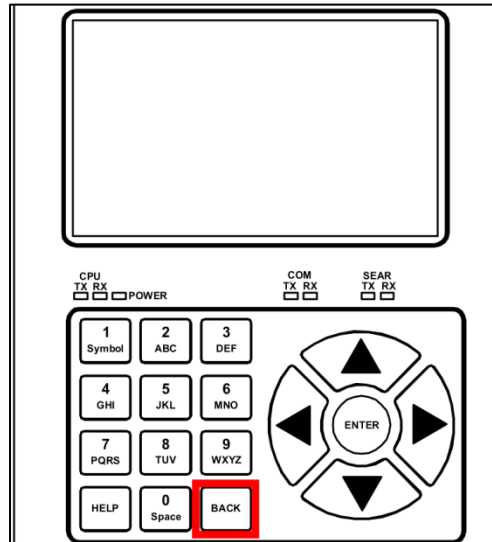

Figure 4-3 Display Keypad Back Key

4.2.1.1 The Track Data Section

The Track Data section provides the following indicators and information (Figure 4-2):

- Track number e.g., 1 – 5

Calibration Status of Track Module (shown as GCP):

- When track module calibration is required, the display shows **GCP Cal Req** under EZ/EX/MPH as shown for track 2 in Figure 4-4

Diags		System View				IO
Trk	EZ	EX	MPH	ISL		
1	100	100	0	NU		
2	GCP	Cal	Req	NU	LockOut	
3	0	0	0	NU		
4	0	0	0	NU		
5	0	0	0	NU		

SSCC: XR XFER: main

Figure 4-4 Display System View showing Diagnostic Messages

A train/car on approach is depicted by a warning triangle with a locomotive in it. This is shown when inbound or outbound motion is detected.

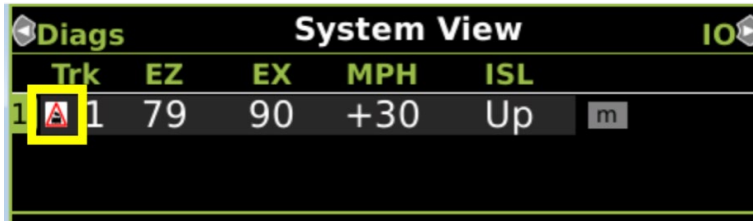

Figure 4-5 Train on Approach Icon

EZ Value – see Trk 1 in Figure 4-5. The EZ is a measure of the distance down the track to the end of the last car. EZ has a value from 0 to 100. 0 means the track is completely full, 100 means the track is empty and the DTC can see to the end of the approach. 50 means the track is half full.

EX Value– see Trk 1 in Figure 4-5. The EX is a measure of the ballast of the track. Values around 100 represent perfect ballast conditions. As the ballast gets worse the EX drops, values around 40 represent very bad ballast.

Train speed measured in MPH – see Trk 1 in Figure 4-5. In the DTC application, outbound cars are shown with a negative speed.

Diagnostic Indication

When there is a diagnostic message available related to the track module, the system view will indicate this with a red triangle to the left of the track number as shown in Figure 4-4.

Xfer Status Section

The Xfer section indicates whether the system is healthy or not. If the icon is green, this shows the system is healthy. Note: XFER main and standby are not relevant to the DTC application. Only the color of the icon has significance.



Figure 4-6 Healthy Transfer Status operating on Main

If the icon is grey, the system is unhealthy. The DTC system does not use a transfer module.



Figure 4-7 Unhealthy Transfer Status operating on Main

The Track Data section has submenus indicated by the green circle and number next to each track shown in the yellow box, in the following figure.

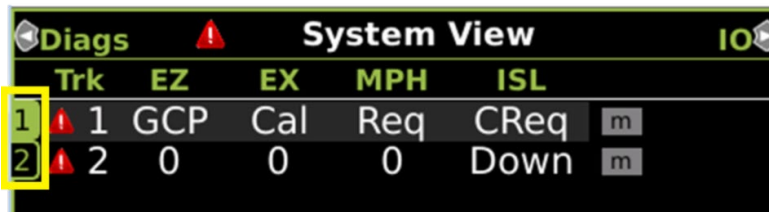

Figure 4-8 System Track Submenus Buttons

Press the 1 on the display keypad to show the track 1 submenu or press 2 for the track 2 submenu as shown for track 1 in Figure 4-10.

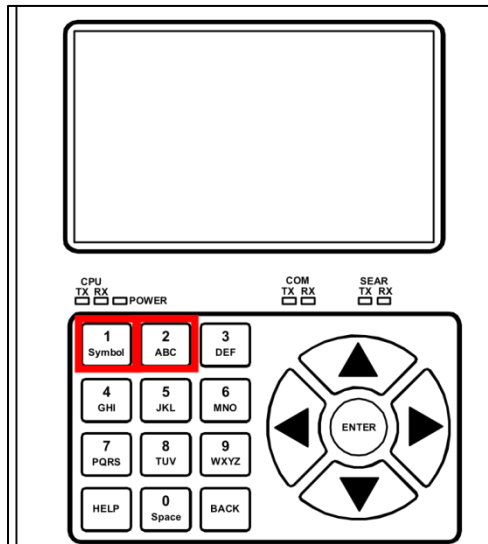

Figure 4-9 Display Keypad Number 1 & 2 Buttons

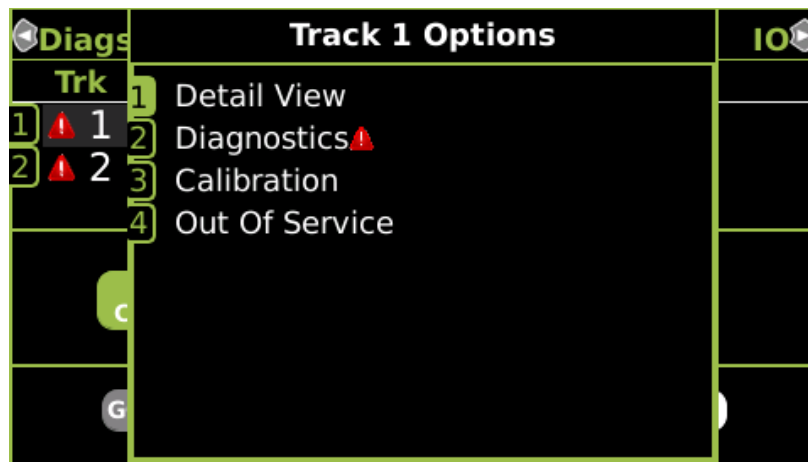

Figure 4-10 System Track Submenus

The individual submenus are discussed in the following sections.

4.2.1.2 Detail View

When **Detail View** is selected from the track submenu, the **Module Details** screen will appear. There is no data on this screen that is needed by the DTC.

4.2.1.3 Diagnostics

Selecting the Diagnostics from the Track Options menu will bring up the Diag screen that shows diagnostic messages specific to this module. More information about a specific diagnostic message can be found by first selecting the message and then pressing the **Enter** button. The diagnostic messages are shown here in real-time so only currently active messages will be seen. See section 4.2.4.1 for more details.

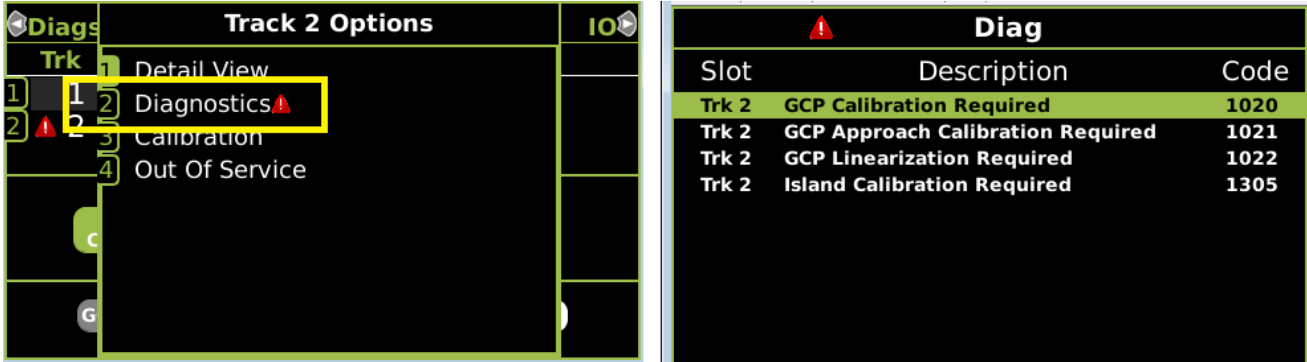

Figure 4-11 Track Diagnostic Screen

4.2.1.4 Calibration

Selecting the Calibration menu from the Track Option will bring up the Calibration screen for the specified module.

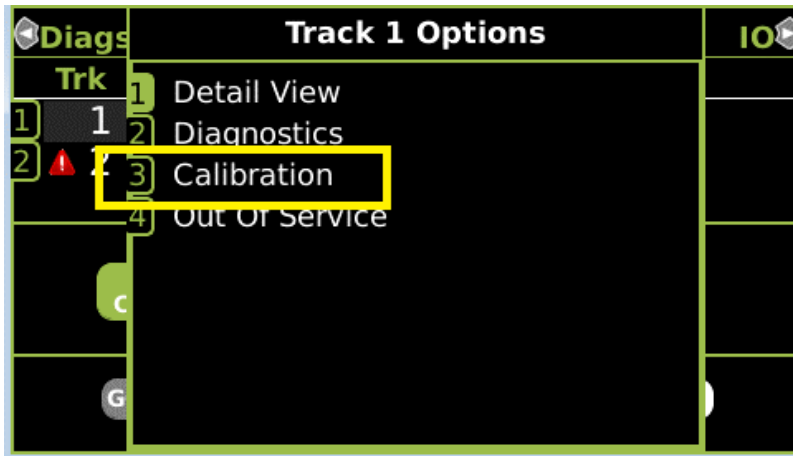

Figure 4-12 Track Options - Calibration

The Calibration screen will show the status of the calibration steps. If calibration is required, the screen shows a red cross and **Calib Req** as shown on the left below. If the calibration has been performed, the screen shows a green check and **Calibrated** as shown on the right below.

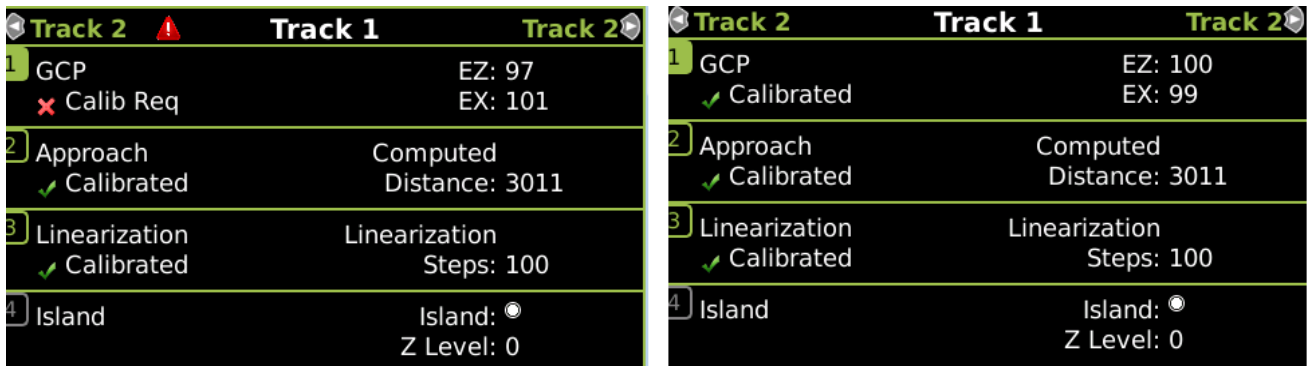

Figure 4-13 Track Calibration

Section 6.3 describes in detail how to perform the Track Module calibration, approach calibration and linearization procedures. The Island is not used in the DTC, so no island calibration is necessary.

4.2.1.5 Out Of Service

The Out of service option is not used in the DTC.

4.2.2 I/O Screen

The I/O View screen provides options for viewing the status of all I/O on the DTC. This screen is not used on the DTC as no I/O is used.

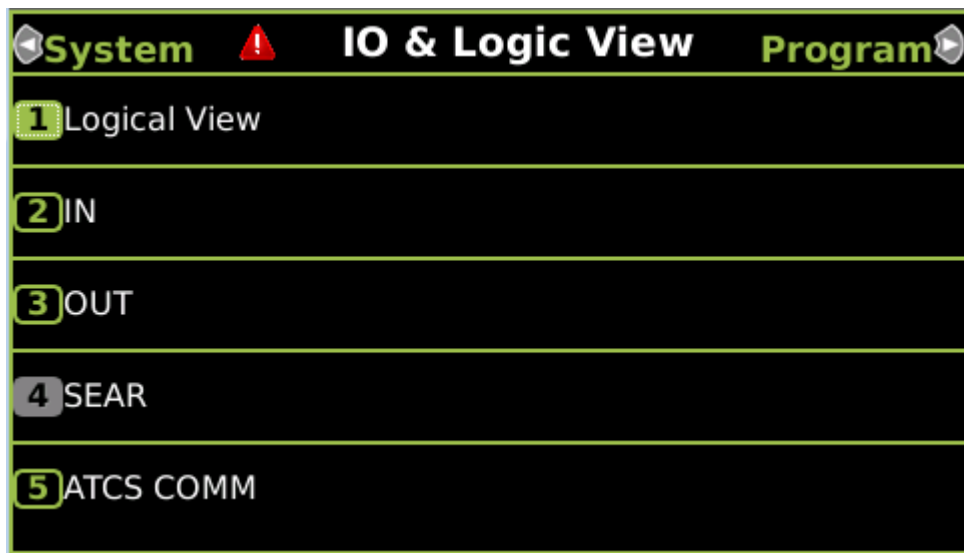

Figure 4-14 I/O Screen

4.2.3 Program View Screen

The Program View screen is where all parameters required for DTC operation are set. There are three main submenus:

- **Display Programming** is used to set non-vital settings related to the operation of the display.
- **SEAR Programming** not used on DTC.
- **GCP Programming** is used to set the parameters that control the operation of the DTC.



Figure 4-15 Program View Screen

The configuration parameters are either:

- Text based – where a text value can be entered using the keypad
- Numeric – where a numerical value is entered
- Enumerated – where a value is chosen from a list

For a numeric value, if any out-of-range value is entered, the display will give a warning and show the valid range.



Figure 4-16 Numeric Value Error

To navigate this menu:

- Press a number to go to the indicated submenu
- Use the up and down keys to change the highlighted menu, then press **Enter**
- Use the right and left arrows to move from one screen to the next in a cyclical order

Use the **Back** key to go back up to a higher menu. Use the 0 key to move back to the top level Main program menu. Holding the back key for 3 seconds in any screen will navigate back to the top of the menu tree, then the left and right arrows can be used to get back to the system view.

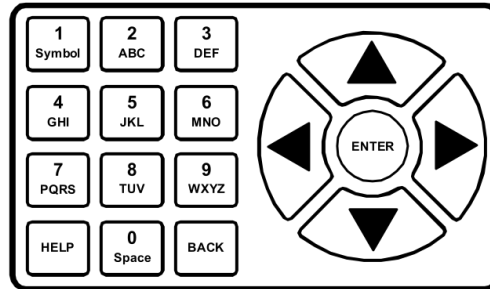

Figure 4-17 Menu Select Panel

When on a screen with parameter values, use the up and down arrows to change which property is selected, then press **Enter** to edit the value.

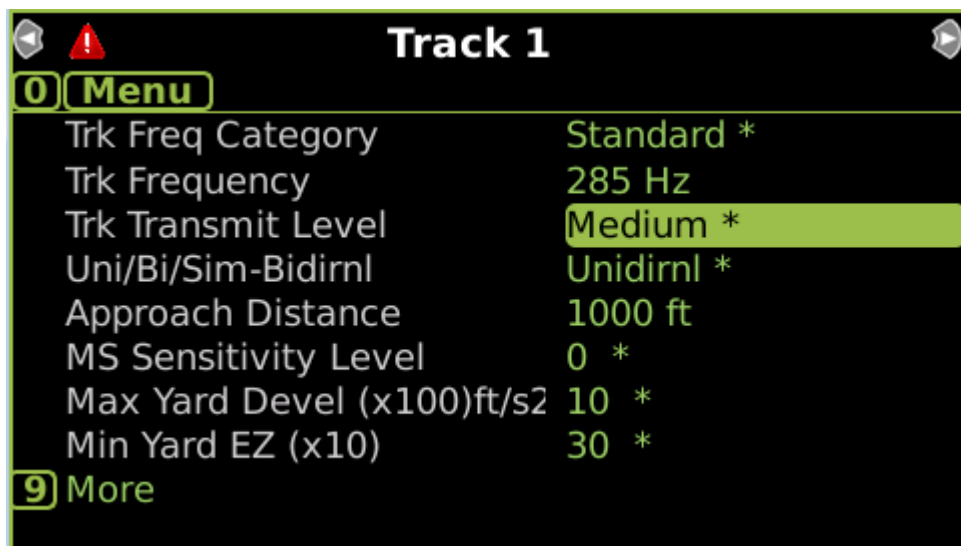

Figure 4-18 System Programming Selecting Parameter

When editing a parameter, use the **Back** button to delete the current value, then retype the value using the numbers on the keypad, or use the up and down keys to increment or decrement the value. Press **Enter** to save the value and return to the previous menu.

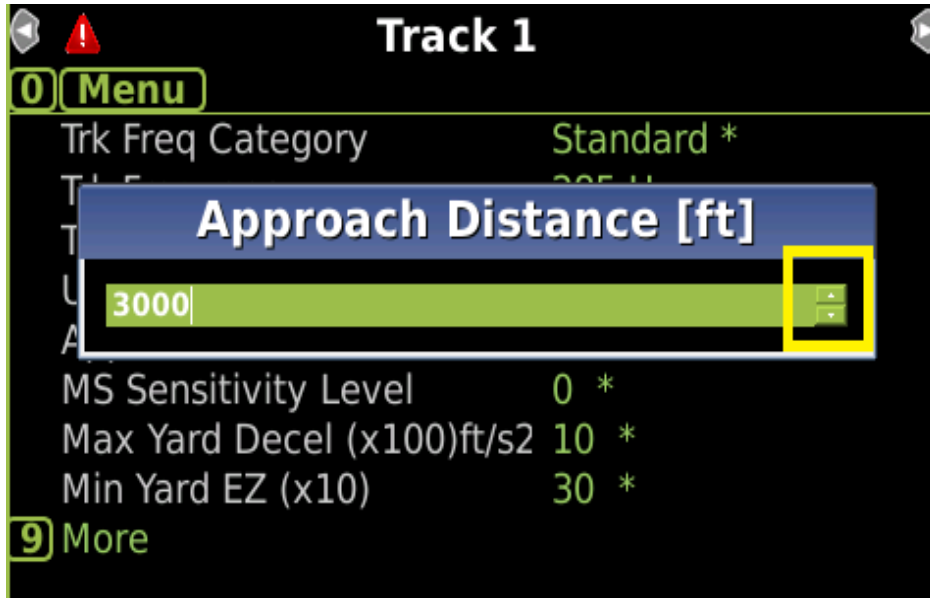

Figure 4-19 GCP Programming Editing Numeric Parameter

For enumerated values, use the up and down keys to select the required value, then press the **Enter** key to save it.

Section 5.2 describes each configuration parameter in detail.

4.2.4 Diags and Reports Screen

The Diags and Reports screen is used to see diagnostic information about the system or view logs.

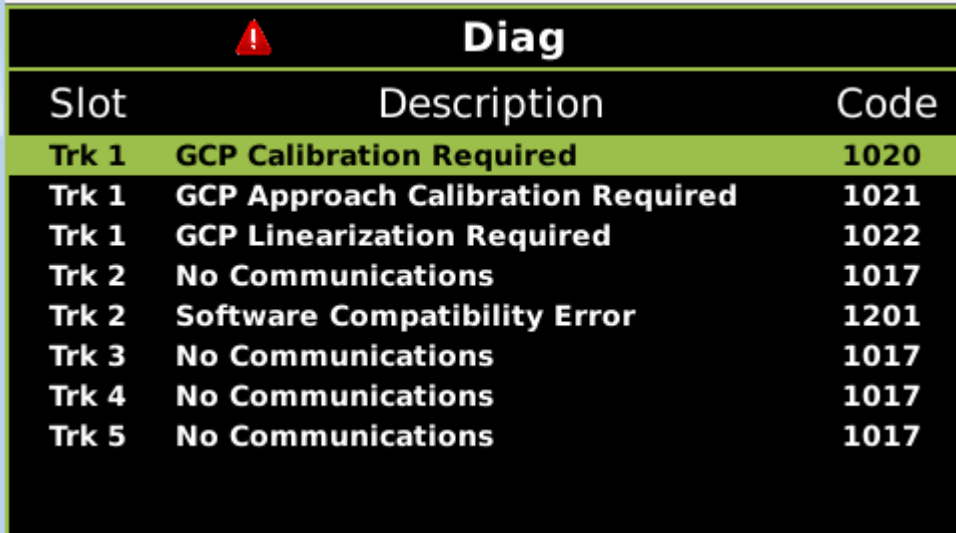

Figure 4-20 Diag & Reports Screen

4.2.4.1 The Diag Screen

The Diag Screen shows all the Diagnostic Messages that are currently being generated by the system; for example, see Figure 4-21.

If the system is healthy the Diag screen will show “No Diag Msgs present!”.



Slot	Description	Code
Trk 1	GCP Calibration Required	1020
Trk 1	GCP Approach Calibration Required	1021
Trk 1	GCP Linearization Required	1022
Trk 2	No Communications	1017
Trk 2	Software Compatibility Error	1201
Trk 3	No Communications	1017
Trk 4	No Communications	1017
Trk 5	No Communications	1017

Figure 4-21 Diag Message Screen

To see further information regarding a specific diagnostic message, use the up and down arrow keys to select the desired message, then press the Enter key. The display will show the potential cause of the problem and suggest remedies to help fix it. Use the up / down keys to scroll up and down and the Back key to go back to the previous menu.

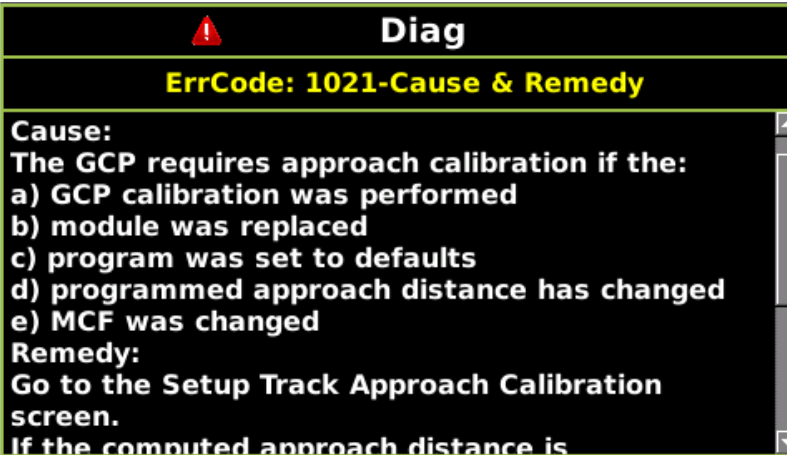

Diag
ErrCode: 1021-Cause & Remedy
Cause: The GCP requires approach calibration if the: a) GCP calibration was performed b) module was replaced c) program was set to defaults d) programmed approach distance has changed e) MCF was changed Remedy: Go to the Setup Track Approach Calibration screen. If the computed approach distance is

Figure 4-22 Diag Message Detail Screen

4.2.4.2 Report and Logs

When the Reports and Logs screen is entered, the user can choose between Reports and Logs.



Figure 4-23 Report and Log Selection

If Reports is selected, the following are available:

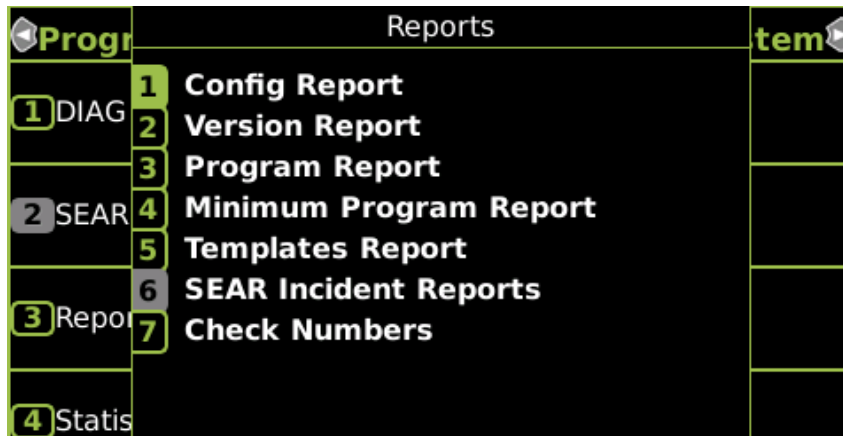

Figure 4-24 Available Reports

Since the DTC has only a few configuration parameters, the Config report is the primary report to be used. This contains configuration settings and version report.

When Config report is selected, the Display shows the report generation progress, then a list of available sections.

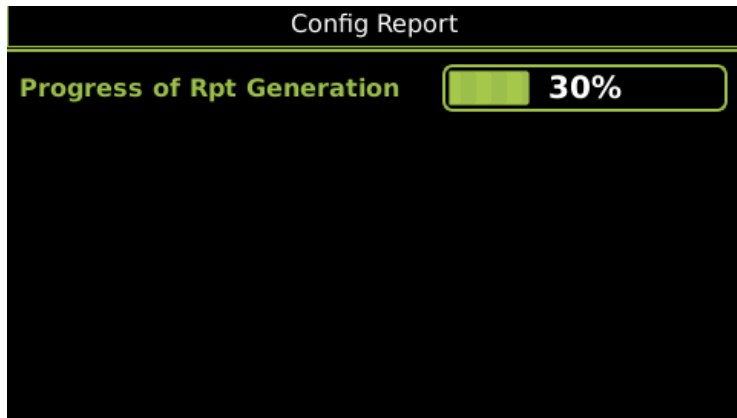

Figure 4-25 Generation Progress

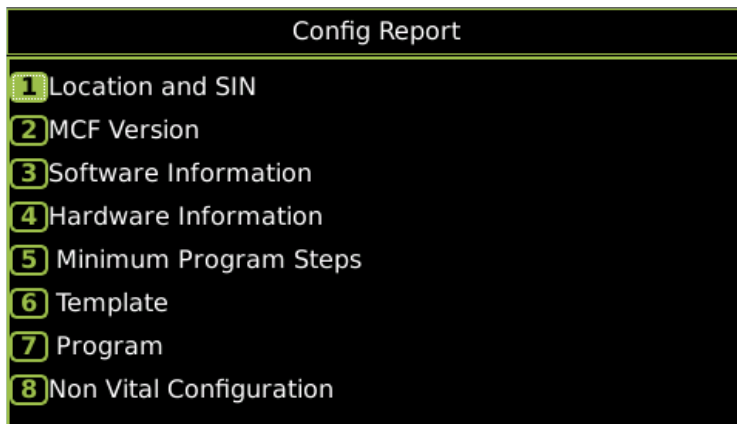

Figure 4-26 Config Report Sections

When Logs is selected, the following list of available logs is show. Only the Event Log is used in the DTC.

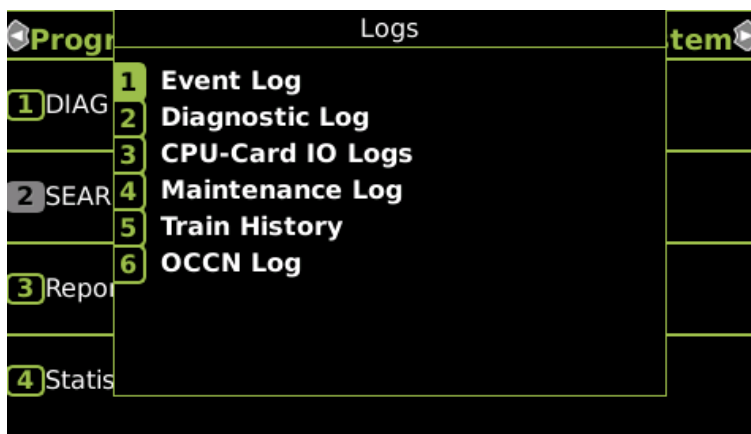

Figure 4-27 Available Logs

4.2.5 USB Menu Screen

When a USB stick is inserted into the Display, the menu shown in Figure 4-28 will appear. This menu can also be accessed by using left arrows from the System View screen, or right arrows from the Diags and Report screen.

The menu allows various reports to be downloaded on to the USB stick, or software uploaded from the USB stick to the DTC system.

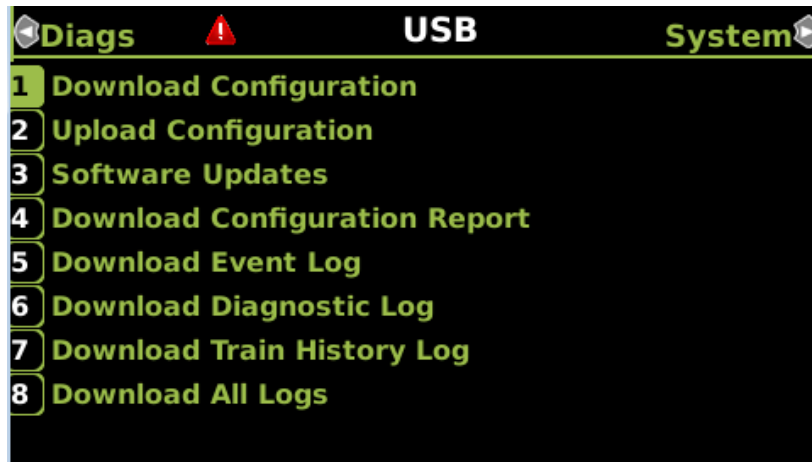

Figure 4-28 USB Menu

4.2.5.1 Download Configuration

This is used to download the configuration file from the DTC. The configuration file is known as the PAC file. The PAC file can be opened offline using the OCE tool (See manual SIG-00-11-15B). The PAC file can be used as a back up to the DTC configuration and can be loaded back into the system using the Upload Configuration step described below.

NOTE

NOTE

The PAC file will only contain the System Programming and Site Programming. If the PAC file is used to restore the configuration, the Display Programming or CP Programming (such as DTC Interface settings) will need to be configured separately.

See Section 4.4.1 for the detailed procedure for downloading a configuration file.

4.2.5.2 Upload Configuration

The Upload Configuration option is used to upload a new configuration file (PAC file) to the DTC. The PAC file can be created using the Windows DT or Web based OCE program.

NOTE

NOTE

The PAC file will only contain the System Programming and Site Programming. The Display Programming or CP Programming (such as DTC Interface settings) will need to be configured on the Display and CPU III modules.

See Section 4.4.2 for the detailed procedure for uploading configuration file.

4.2.5.3 Software Updates

The DTC allows new software to be uploaded to modules from the USB, see Section 4.5.1 for a detailed procedure on uploading new software from a USB.

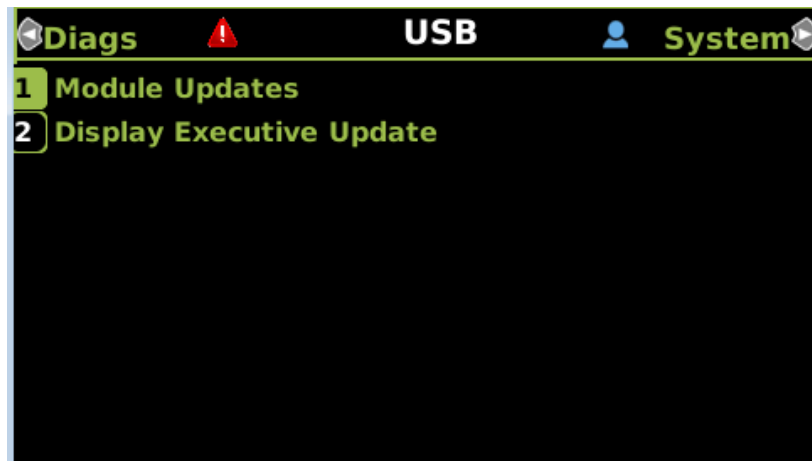

Figure 4-29 Software Update Options

4.2.5.4 Download Configuration Report

Use this option to download a copy of the configuration report for the system. The display will show the status of the download as **In Progress**, **Finalizing** then **Complete** as shown below.

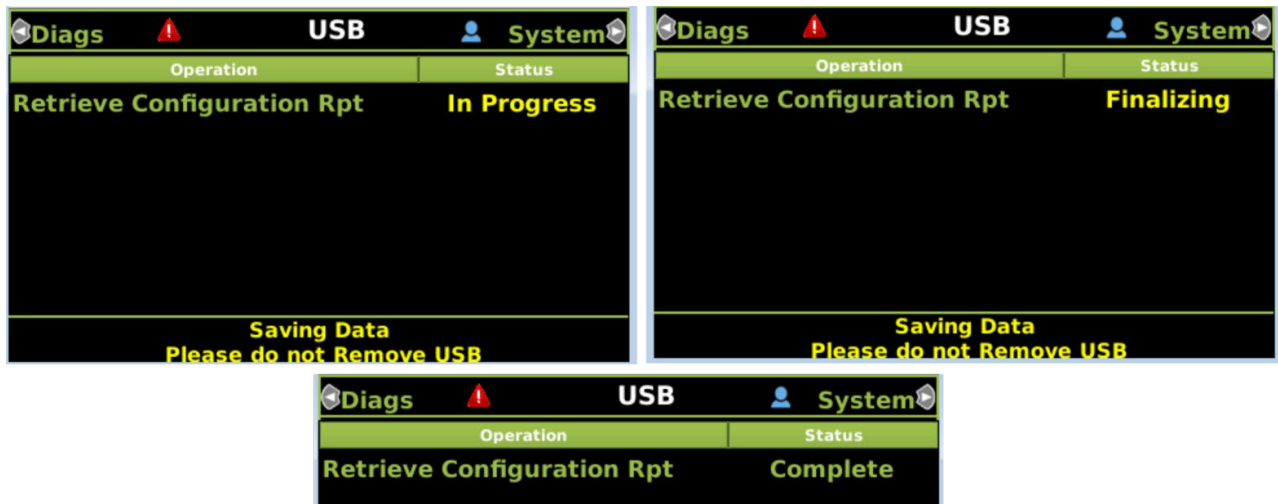

Figure 4-30 Download Configuration Report

The file will be stored on the USB stick in a folder called:
 Safetran\DOT-SITENAME\GCP4000\Reports\yyyymmdd
 With a file name given by: system_report_dd-mm-yyyy.txt

NOTE

NOTE

Due to software commonality issues, the USB Display device utilizes folders titled GCP4000 rather than DTC.

4.2.5.5 Download Event Log

When this is selected, the display will show the options illustrated in the following figure. Select the desired option.



Figure 4-31 Download Event Log

If Option 1 or 2 is chosen, the display will then show the progress of the upload as **In Progress** then **Complete**.

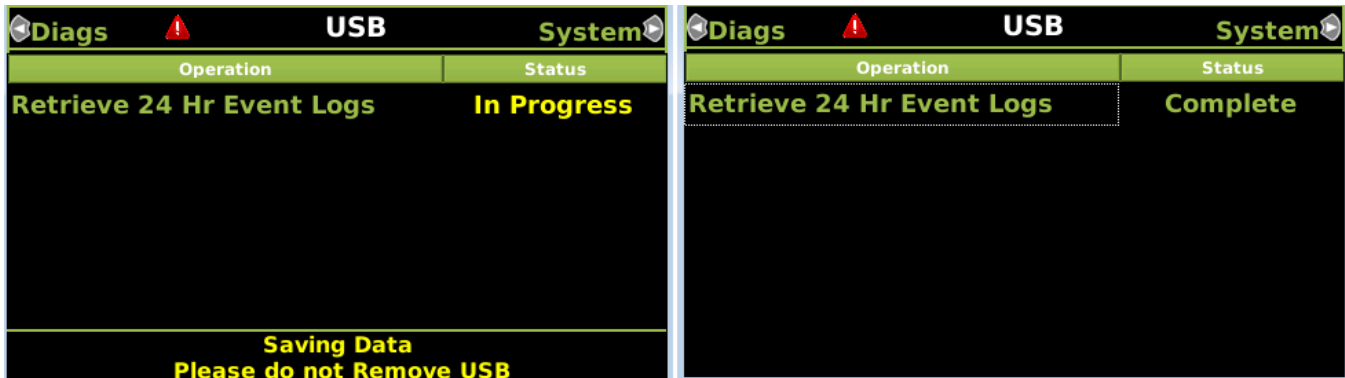

Figure 4-32 Download Event Log Status

If Option 3 is chosen, the display will allow the user to set the start time, date, and end time. Use the left/right/up/down keys to select the required field to edit, then press **Enter**. To select the new time or date, the up/down arrow keys can be used to decrement or increment the field, and the right key used to move to the next field. When the time and date have been selected, navigate to the **Download** button, and select **Enter**. The display will show the download status as above.

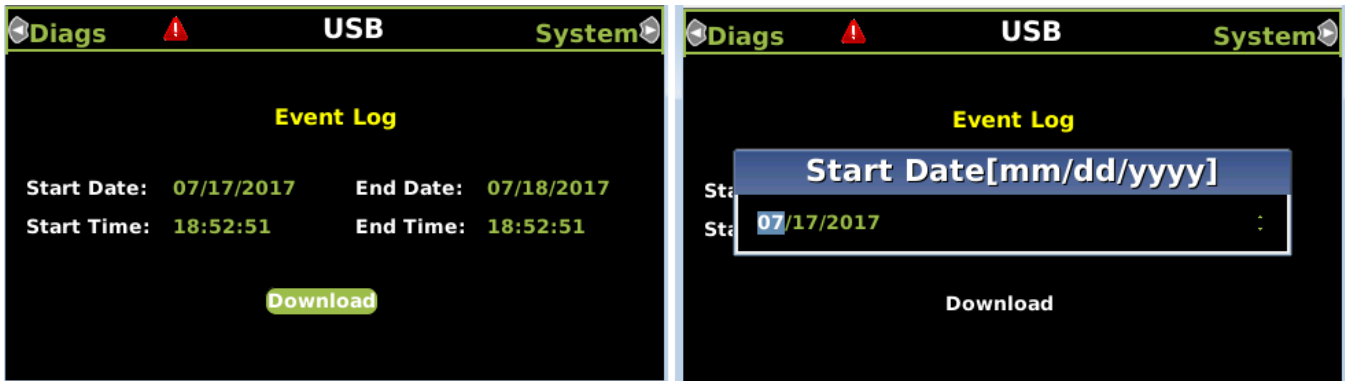

Figure 4-33 Download Event Log Status

The logs are downloaded into a folder on the USB called:

Safetran\DOT-SITENAME\GCP4000\Reports\yyyymmdd

With a file name given by: EvtLog <DOT#>-yyyymmdd to yyyymmdd.txt

4.2.5.6 Download Diagnostic Log

When **Download Diagnostic Log** is selected, the display will show the progress of the download as **in Progress**. It then indicates every 1000 records downloaded, then **Finalizing**, then **Complete**.

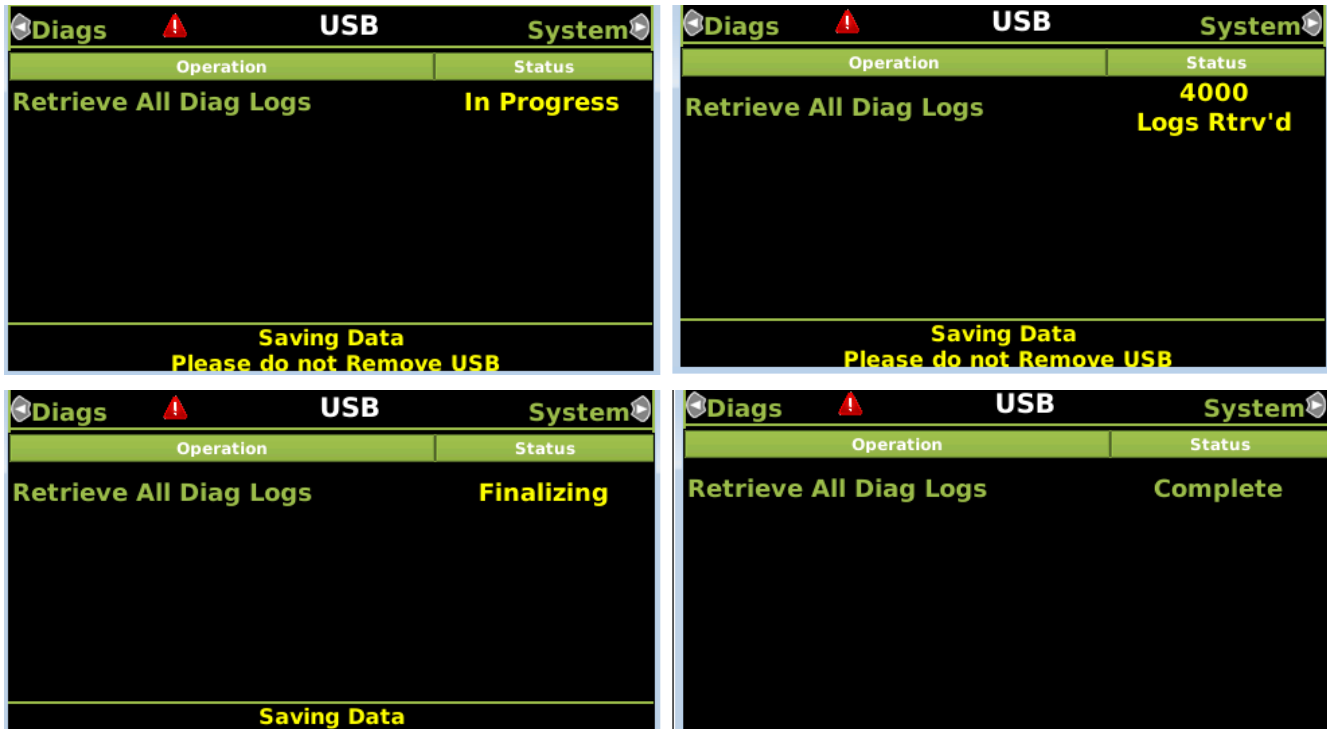

Figure 4-34 Download Diagnostic Log

The diagnostic log will be stored in a folder on the USB called:

Safetran\DOT-SITENAME\GCP4000\Reports\yyyymmdd

With a file name given by: DiagLog-<DOT#>-yyyymmdd to yyyymmdd.txt

4.2.5.7 Download Train History Log

This is not used in the DTC.

4.2.5.8 Download All Logs

This option is used to download all the logs available in the system. The display will show the progress as illustrated in the following figure.

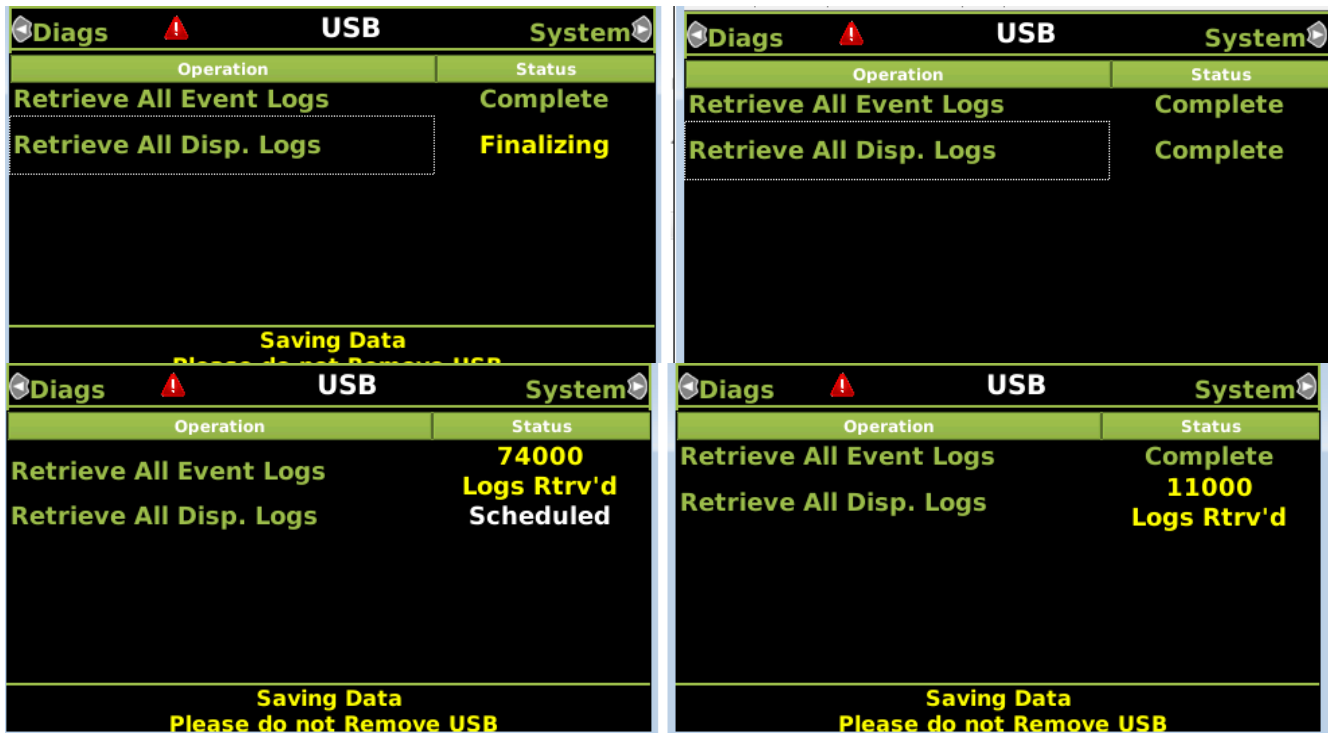

Figure 4-35 Download All Logs

The event and display logs are downloaded and will be stored in a folder on the USB called:
 Safetran\DOT-SITENAME\GCP4000\Reports\yyyymmdd

With a file name given by:

- EvtLog-<DOT#>-yyyymmdd to yyyymmdd.txt
- DispLog-<DOT#>-yyyymmdd to yyyymmdd.txt

NOTE

NOTE

The Display log is primarily for Siemens use.

4.2.6 Atypical Display Module Indications

4.2.6.1 Display Module when Display/CPU Connecting

If the Display module is not in session with the CPU, this is indicated as shown in the figure below on the left. During the connection process, the display will show the progress bar for approximately 30 seconds as shown on the right.

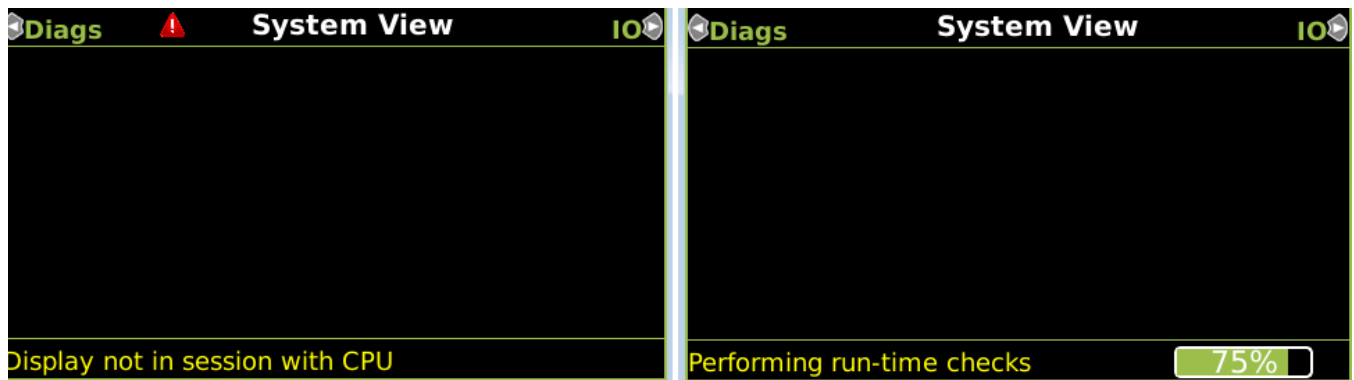

Figure 4-36 Connection Progress Bar

When this is complete, the display will show the Diagnostics screen (if diagnostic messages are present) or it will show the System View.

4.2.6.2 Display when VLP in Edit Mode

When a configuration file is loaded, the display shows the following message:

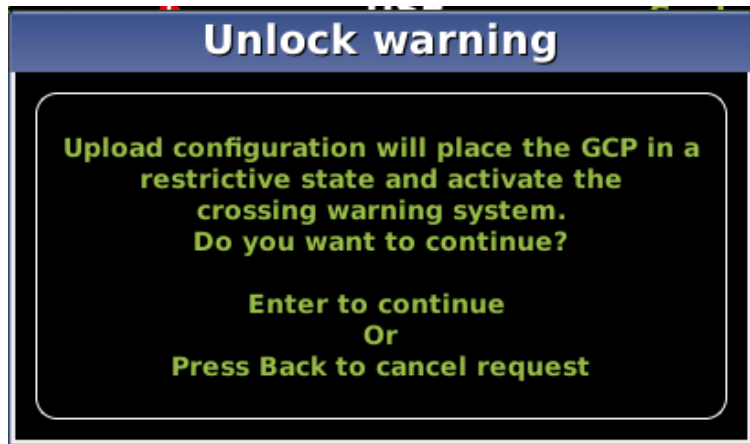

Figure 4-37 Unlock Warning

If the user continues, the VLP is first put into a safe unconfigured state. If the upload process is abandoned without getting to the point where the VLP is reset, the System View will show the message illustrated in the following figure. To get the system out of this state, reset the VLP by selecting the Reset VLP and pressing enter.

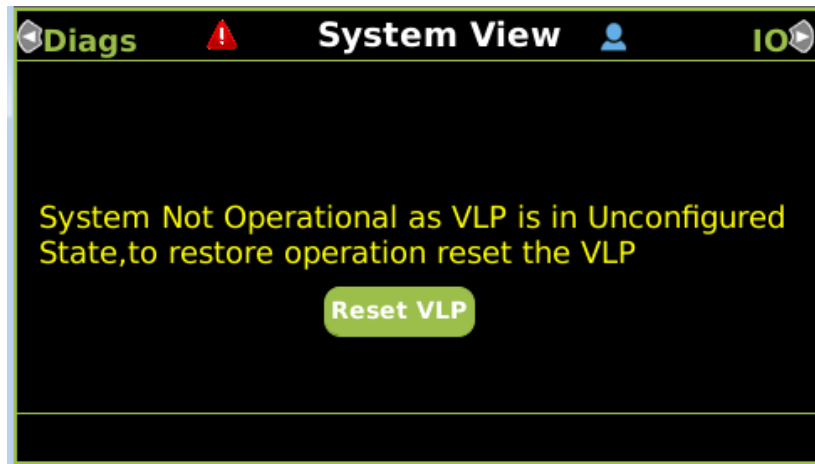

Figure 4-38 VLP in Unconfigured State

4.2.6.3 Display when VLP has Configuration Errors

If an incorrect MCF CRC is entered when loading the MCF, or an invalid MCF is loaded, the System View will show the message illustrated in the following figure. Go to the Diags screen and look at the diagnostic messages present to get more details of the problem.

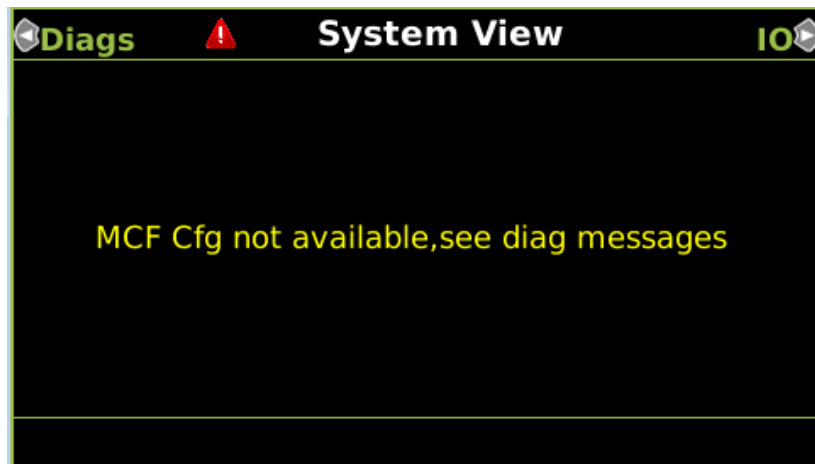

Figure 4-39 Incorrect MCF Loaded

4.3 USB FILE STRUCTURE

4.3.1 Setting up a USB Device for Use

New software issued by Siemens Mobility, Inc. for the DTC is installed via the A80485-1 Display using a USB Device.

NOTE

NOTE

Due to software commonality issues, the USB Display device utilizes folders titled GCP4000 rather than DTC.

Follow railroad specific procedures for installing software in vital signal equipment. Companies may restrict who may install software and what additional documentation and operational checks are required.

When working with transferring files, the following definitions apply:

- Download – The transfer of data from DTC to USB.
- Upload – The transfer of data from USB to DTC.

Future software revisions will be issued with instructions that describe which module the software is to be loaded into. Such software instructions may supersede portions of this manual.

The following DTC file types can be uploaded from a USB drive connected to the Display Module:

- Module Configuration Files (MCF)
- Module Executable Files (MEF)
- Configuration Files (PAC)

4.3.1.1 Creating the USB Device File Structure

Uploading or downloading files between the DTC and the USB Device requires that a specific file structure be created on the USB Device. The system looks for specific file folders to find or place Application, Executive, Configuration or Report files.

The file structure is as follows for downloads:

- SAFETRAN
 - DOT-SITENAME
 - GCP4000
 - CONFIGURATIONS
 - .PAC FILES
 - REPORTS
 - <YYYY><MON>

The file structure is as follows for uploads:

- SAFETRAN
 - GCP4000
 - APPLICATIONS
 - .MCF
 - .PAC
 - EXECUTIVES
 - .MEF
 - .TGZ

PAC files or MCFs to be uploaded should be placed under the GCP4000\Applications. Executive software to be uploaded should be placed under the GCP4000\Executives. Downloaded files are placed under the Safetran\DOT-SITENAME\GCP4000 folder.

NOTE**NOTE**

The following section describes uploading and downloading software and reports from all DTC Modules onto the USB Drive.

4.4 DOWNLOAD/UPLOAD CONFIGURATION (PAC) FILES VIA USB DEVICE

4.4.1 Download Configuration File to USB Drive

Perform the following actions:

1. Insert the USB Drive in the USB slot on the front of the Display.
2. If Maintainer security has been enabled, enter the password. The password is case sensitive. If security is not enabled, proceed to step 3.
3. Select **1) Download Configuration**.

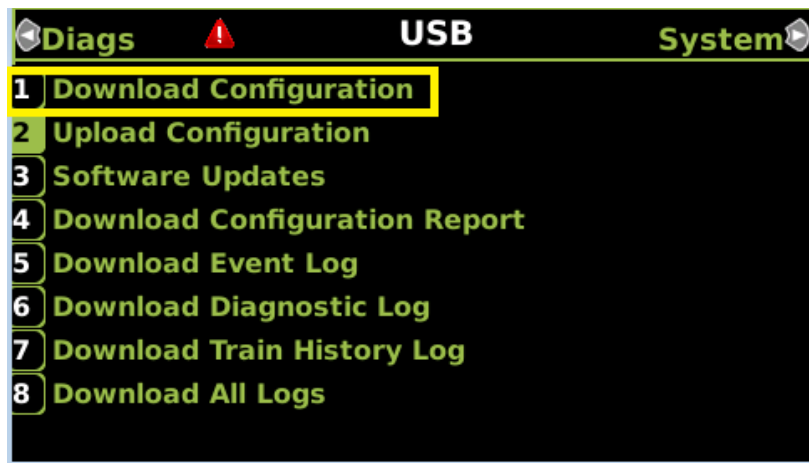

Figure 4-40 Select Download Configuration

4. The Download configuration window opens, stating: **Download PAC File...Please do not Remove USB.**

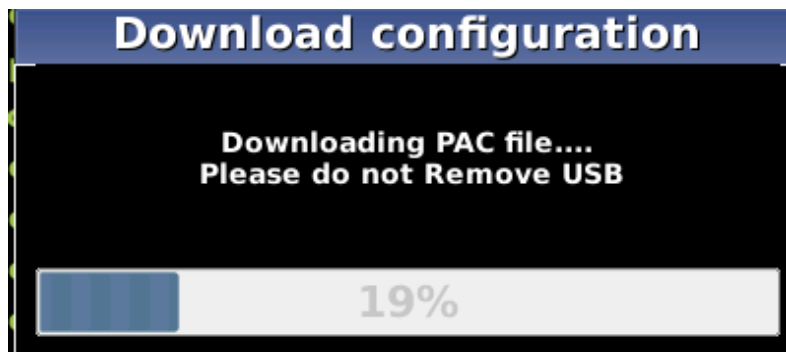

Figure 4-41 Download Progress

- When the file has downloaded from the Display to the USB Drive, the PAC File Download window opens, stating: **Download Completed**. File is saved at (the actual file location on the USB Drive). Press any key to continue.



Figure 4-42 PAC File Download Complete

The PAC file name is created from the combination of the DOT number and date and time, e.g., CONFIG – {DOT#}-PAC-{date}-{time}.PAC.

The downloaded PAC file will be stored on the USB stick under a folder called:
Safetran\DOT-SITENAME\GCP4000\Configurations

CAUTION

CAUTION

WHILE UPLOADING A NEW CONFIGURATION, MEF, OR MCF, THE DTC WILL NOT BE ABLE TO REPORT CAR POSITIONS AND SPEEDS VIA THE ETHERNET.

NOTE

NOTE

Due to software commonality issues, the USB Display device utilizes folders titled GCP4000 rather than DTC.

4.4.2 Upload Configuration File to DTC

The PAC file to be loaded first needs to be put on the USB stick as described in 4.3.1.2 in a folder called:
Safetran\GCP4000\Applications

Perform the following actions:

- Insert USB Drive in USB slot on front of Display.
- If Maintainer security has been enabled, enter the password. The password is case sensitive. If security is not enabled, proceed to step 3.
- Select **2) Upload Configuration**.

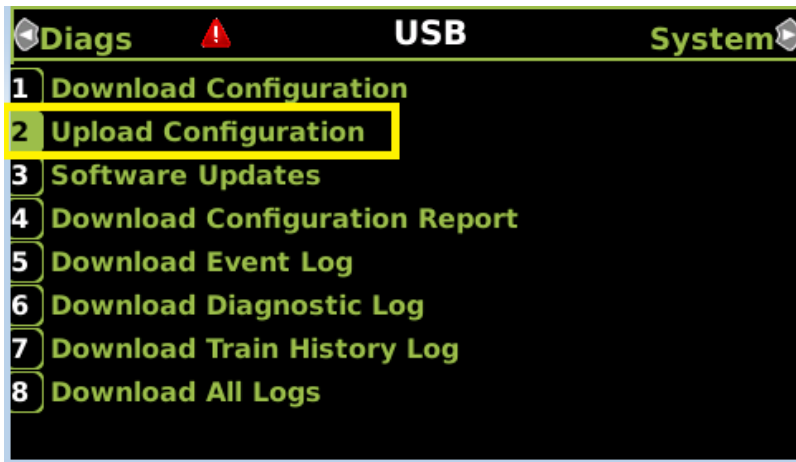

Figure 4-43 Upload Configuration

4. The **Unlock Warning** window opens, displaying the message shown in the figure below.

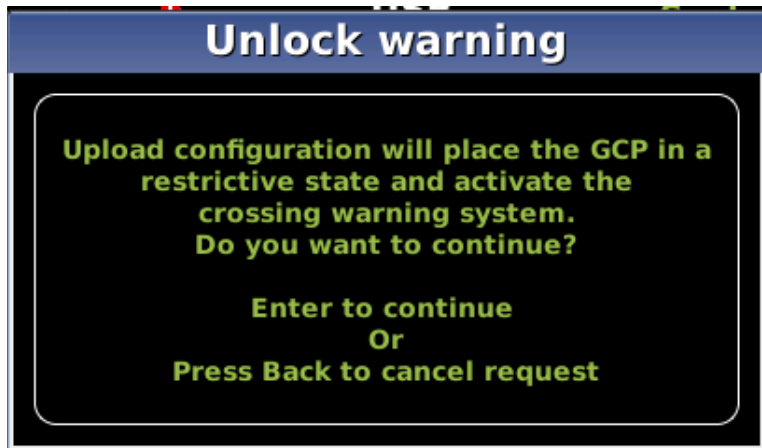

Figure 4-44 Unlock Warning Message Window

5. The Save Configuration window opens, displaying the message shown in the following figure.

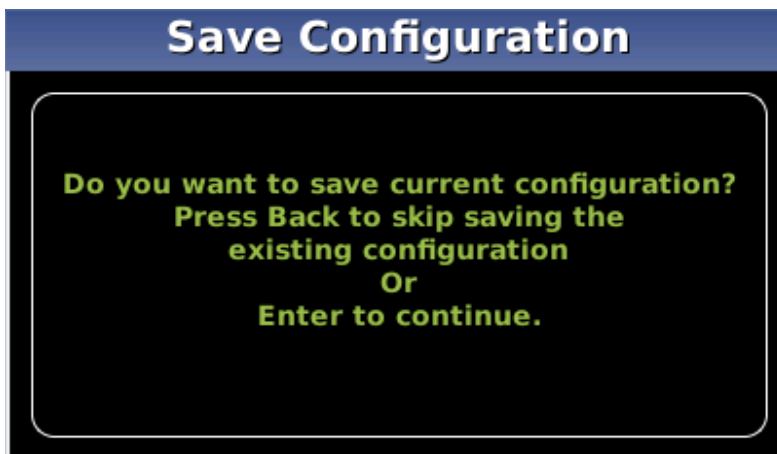

Figure 4-45 Save Configuration

NOTE

NOTE

Selecting the BACK button on the Save Configuration window skips saving the current configuration but does continue with the process of uploading the new configuration.

6. Select **Enter**. The **Download Configuration** window opens, displaying the message shown in the figure below. This may take a few minutes. While the file is downloading, progress will be indicated on the bottom line of the window.

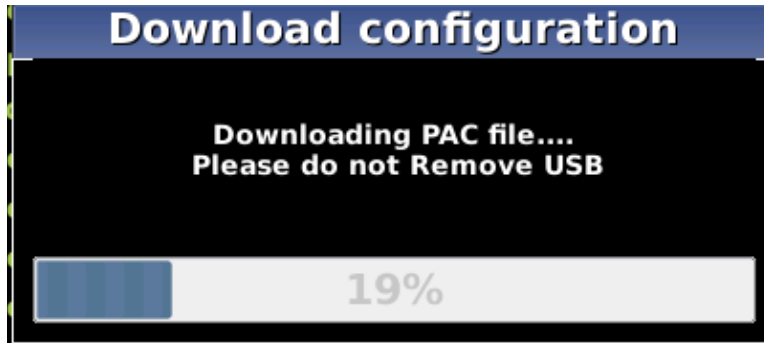

Figure 4-46 Download Configuration

7. When the file has downloaded from the Display to the USB Drive, the **PAC File Download** window opens, stating: **Download Completed. File is saved at (the actual file location on the USB Drive)**. Press any key to continue.
8. The **Select File** window opens. Scroll down to select the correct PAC file to be uploaded. Select **Enter**.

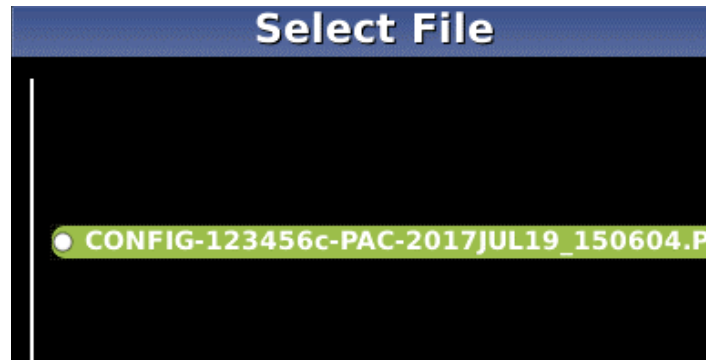

Figure 4-47 Select PAC File

9. The Upload Configuration window opens, stating: **Uploading configuration**.

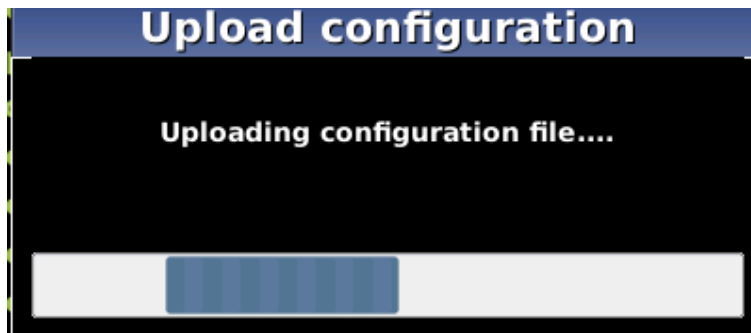

Figure 4-48 Uploading Configuration

10. The **Save** window opens, stating: **Press the SEL or NAV button and then select Enter to save parameters.** The File name, Dot Number, Mile Post, Site Name, SIN, and CCN data then appear.

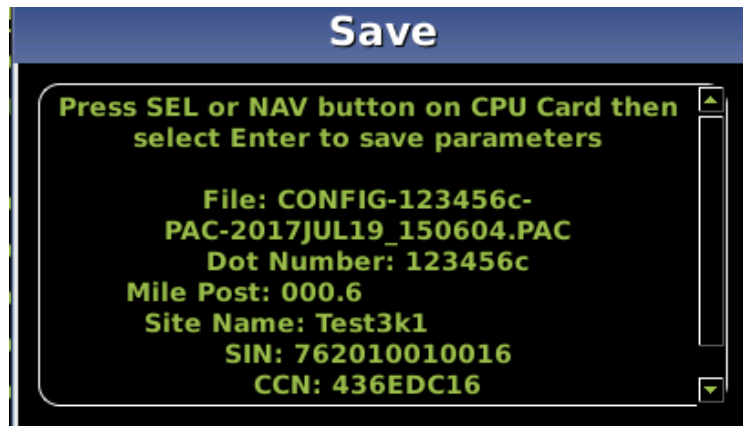

Figure 4-49 Save Window

11. Press the **SEL** or **NAV** buttons on the CPU Card and then select **Enter**.
12. The Upload configuration window opens, stating: **System will now reboot to load the new settings. Press any key to continue.**

NOTE**NOTE**

The display module will reboot as well as the CPU.

4.5 SOFTWARE UPDATES

4.5.1 Installing Software Using a USB Drive

Insert the USB drive in the USB port on the Display Module to automatically open the USB menu.

A USB Detected window opens, stating **USB detected**. Press **Back** to continue or **Enter** for USB Menu. The USB window opens. This menu may be returned to at any time by pressing the **Back** button, providing the USB drive is still inserted in the port.

4.5.1.1 Installing Software on CPU III Module



CAUTION

UPLOADING A NEW CONFIGURATION, MEF, OR MCF WILL PREVENT THE DTC FROM REPORTING CAR POSITION AND SPEED VIA THE ETHERNET.

The examples in this section are used to explain how to install software via a USB and Ethernet cable connecting the Display to the CPU III or via the WebUI using an Ethernet cable to connect directly to the CPU III. The software and version names may not be the same as seen in an actual DTC.

There is no specified order when installing/updating software in the DTC. If replacing the CPU MEFs and the MCF as part of the same upgrade, the order of installation is immaterial. However, the MEFs must be loaded prior to attempting to place the DTC back into operation.

In this example, the following files will be loaded into the indicated modules:

- CPU III Module
 - DIAG (CP) File: GCPNCP3_MEF_1.1.32r.tgz (CPU III CP executive software begins with GCP)
 - VLP File: 9VC72-V3H00_02.010.MEF
 - VLP MCF: – File: GCP3K-01-00.mcf, CRC= 2CF3E617

The files should be copied to the GCP4000/Executive folder of the USB drive if a USB drive is being used instead of the WebUI.

4.5.1.2 Replace CP MEF on CPU III via USB Drive

Perform the following actions:

1. Insert USB Drive in USB slot on front of Display
2. If Maintainer security has been enabled, enter the password. The password is case sensitive. If security is not enabled, proceed to step 3.
3. Connect the Ethernet cable between the Laptop port on the Display and the Laptop port of the CPU III module.
4. You will need to verify that the Display is set up as a Client instead of a Server, to do so, access the Laptop Ethernet Port menu Program View > 3) Display Settings > Laptop Ethernet Port.

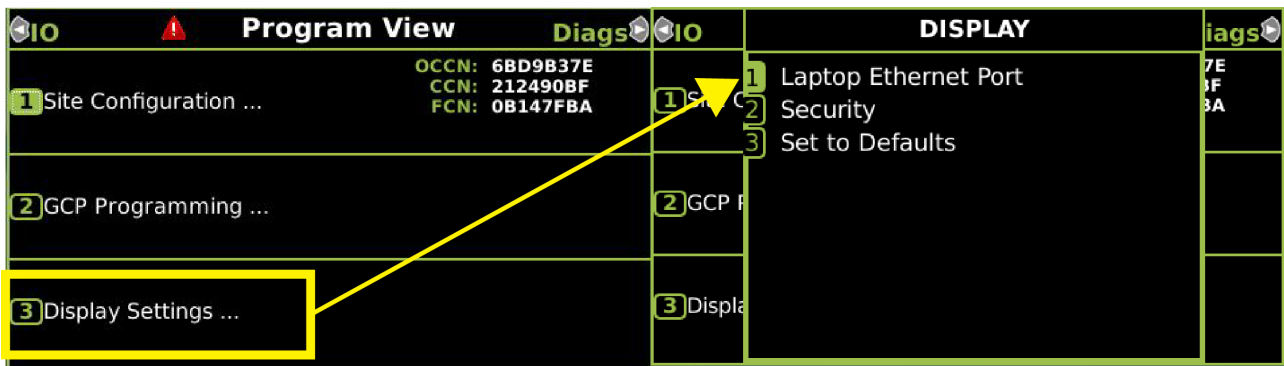

Figure 4-50 Ethernet Menu

5. Select **Client** if Display is configured as Server.

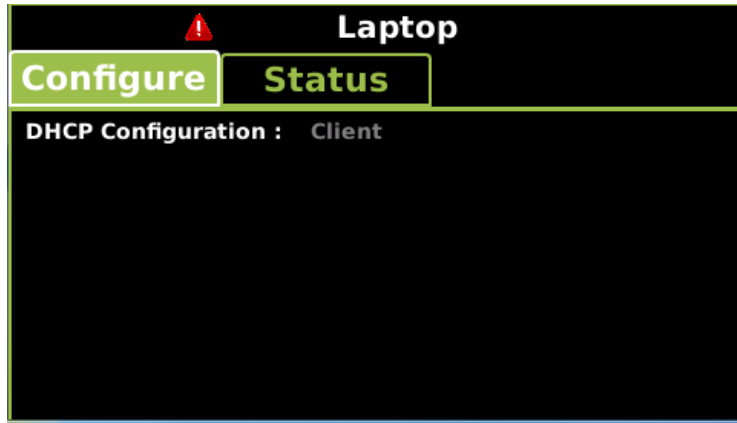

Figure 4-51 DHCP Configuration

6. From the USB menu, select **3) Software Updates > 3) CPU-III Update**

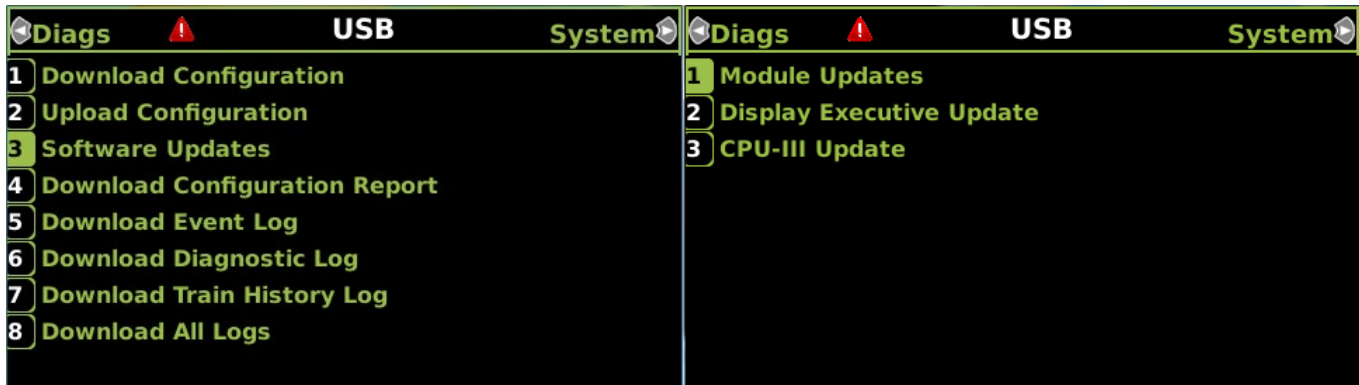

Figure 4-52 CPU-III Update

7. Install an Ethernet cable from the Laptop port on the Display to the Laptop port on the CPU III unit. Verify that the Ethernet cable is well seated on both ends, then press any key.

8. Select **1) Change CP MEF**.

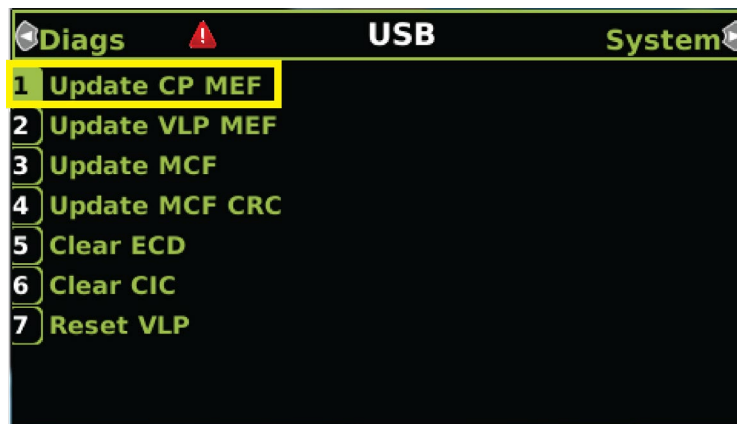

Figure 4-53 Change CP MEF

9. When asked by the Setup program to Erase the MEF, select **1) Yes**.
10. The **Select File** window opens.

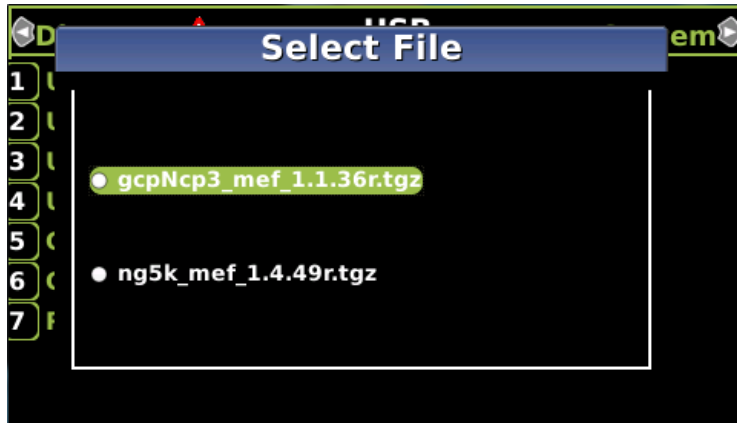

Figure 4-54 Select File Window

11. Scroll down to select the file to be installed, in this example: `gcpNcp3_mef_1.1.36r.tgz`. Press **Enter**.
12. The new MEF begins loading. This may take a few minutes. While the file is uploading, progress will be indicated on the bottom line of the window.
13. When complete, the Display text provides all of the module update options. If a new MCF needs loading, go to step 6 in the next section, otherwise select **0) Exit Setup**.
14. The **Upload to System** window opens and states: **Exit software finished rebooting the module**.
15. Press the Back button. The USB SW Updates menu is shown (as per 4.5.1.2 Step 6).

4.5.1.3 Replace CP MEF on CPU III via WebUI

1. Connect the Ethernet cable from the laptop to the laptop port on the front of the CPU III unit.
2. Obtain the IP address of the DTC CPU III module by pressing the SEL button once, then press the NAV button multiple times until the scrolling IP address text is displayed. Type this address into a compatible web browser with `https://` in front of it.
3. Log in to the WebUI using the appropriate username and password.

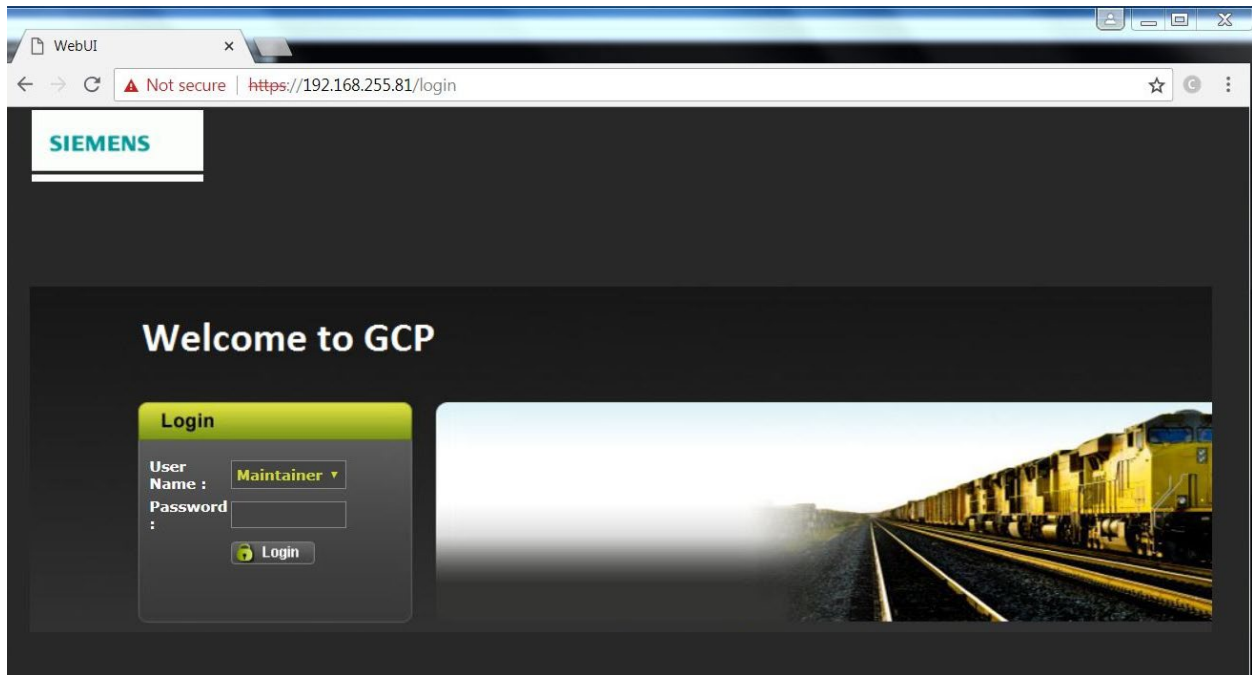

Figure 4-55 WebUI, GCP Login Screen

- From the menu on the left, select **CP MEF**, then click **Unlock**.

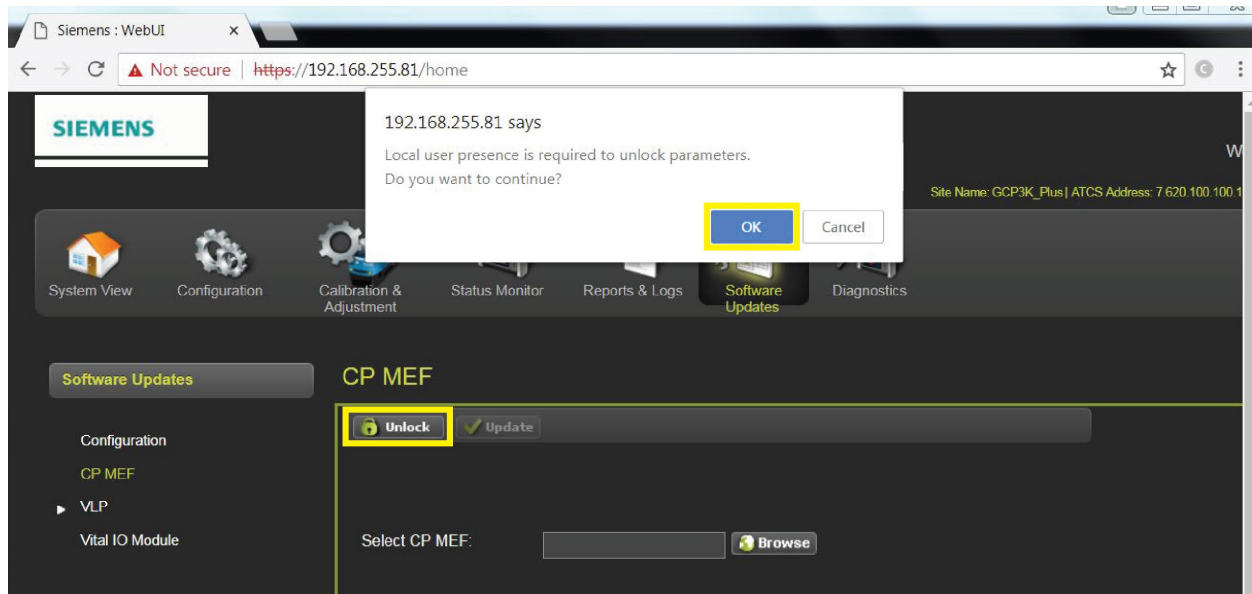

Figure 4-56 WebUI, GCP Menu

- Confirm user presence with the button on the front of the CPU module, click **OK** on the pop-up window, then select **Browse** to locate the desired file.
- Once the correct file is selected, click the **Update** button (located next to the **Unlock** button).
- The uploading status will show until complete. Once complete, the message **MEF file uploaded successfully** will display.

4.5.1.4 Replace VLP MEF on CPU III via USB drive

Perform the following actions:

1. Insert USB Drive in USB slot on front of Display.
2. If Maintainer security has been enabled, enter the password. The password is case sensitive. If security is not enabled, proceed to step 3.
3. Connect an Ethernet cable between the Laptop port on the Display and the Laptop port of the CPU III module.
4. You will need to verify that the Display is set up as a Client instead of a Server, to do so, access the Laptop Ethernet Port menu Program View > 3) Display Settings > Laptop Ethernet Port.

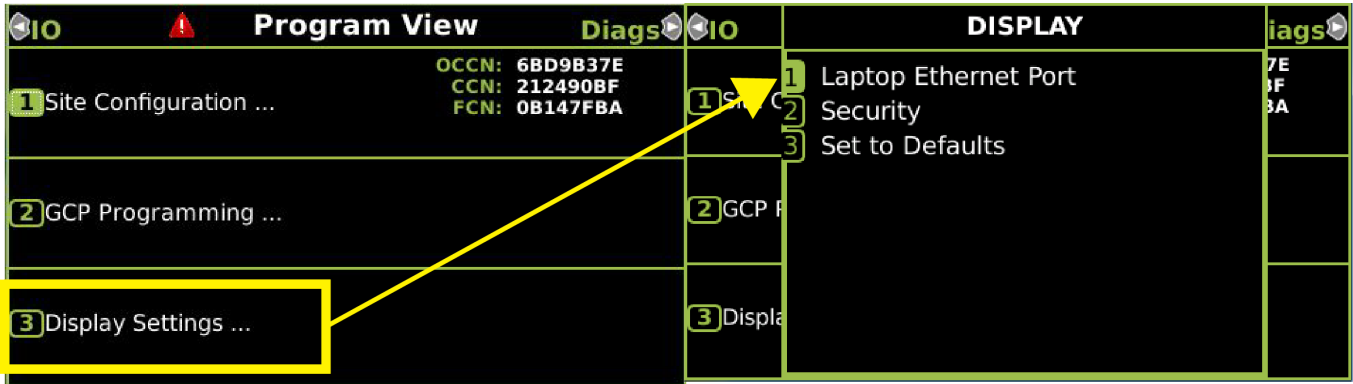

Figure 4-57 Ethernet Menu

5. Select **Client** if Display is configured as Server.

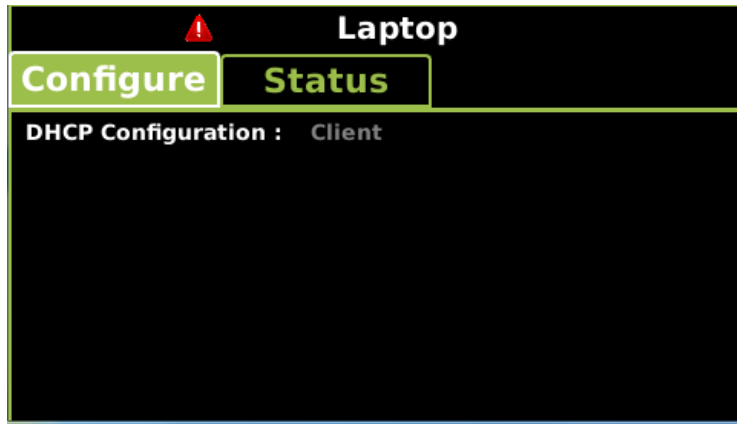

Figure 4-58 DHCP Configuration

6. From the USB menu Select **1) Software Updates > 3) CPU-III Update.**

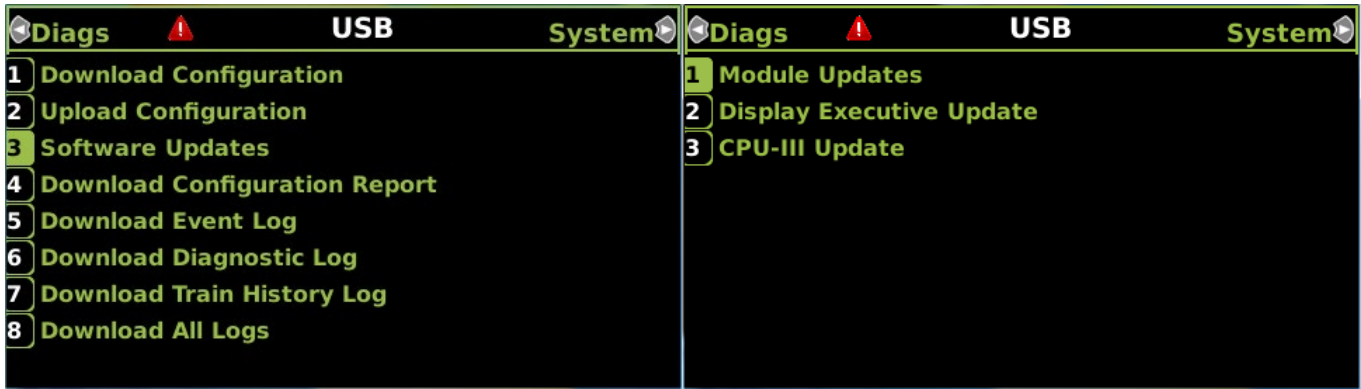

Figure 4-59 Software Update Menu

7. Verify that the Ethernet cable is well seated on both ends.
8. Select **2) Update VLP MEF**.

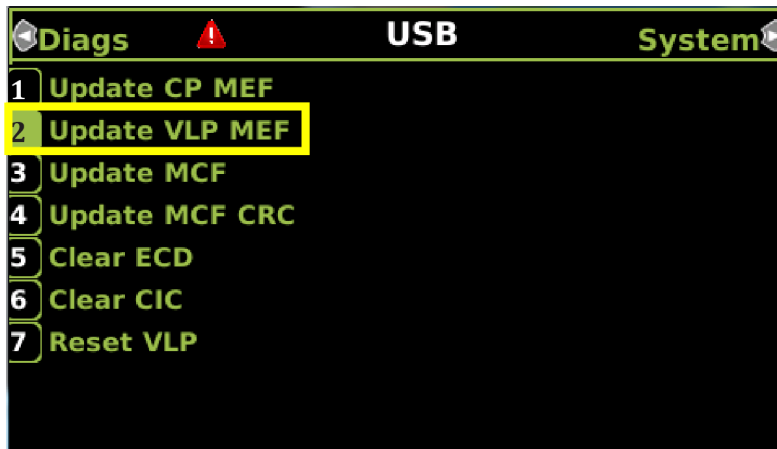

Figure 4-60 Change MEF

9. When asked by the Setup program to Erase the MEF, select **1) Yes**.
10. The **Select File** window opens.

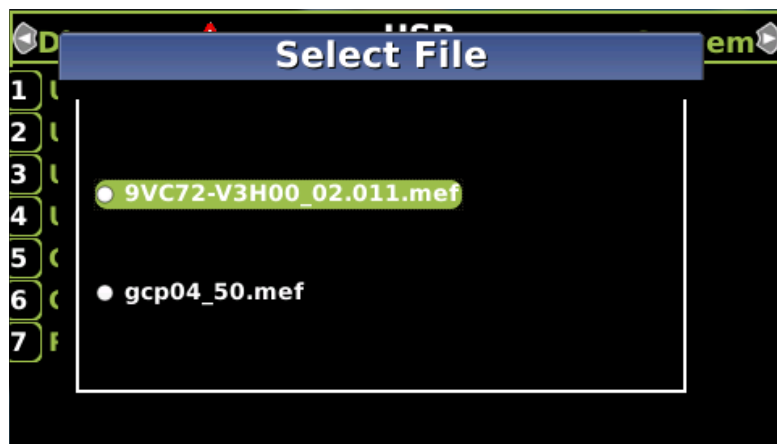

Figure 4-61 Select File Window

11. Scroll down to select the file to be installed, in this example 9VC72-V3H00_02.010. Select **Enter**.

12. The new MEF begins loading. This may take a few minutes. While the file is uploading, progress will be indicated on the bottom line of the window.
13. When complete, the Display text provides all of the module update options. Select **0) Exit Setup**.
14. The Upload to System window opens and states: **Exit software finished rebooting the module.**

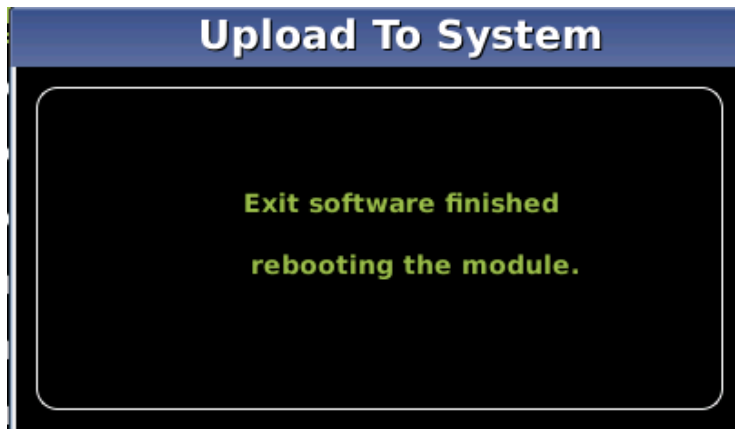

Figure 4-62 Exit Software

15. Press the **Back** button.

4.5.1.5 Replace VLP MEF on CPU III via WebUI

1. Locate the IP address of the DTC unit via the selector buttons on the front of the CPU III unit. Type into a compatible web browser with https:// in front of it.
2. Login to the WebUI using the appropriate Username and Password.

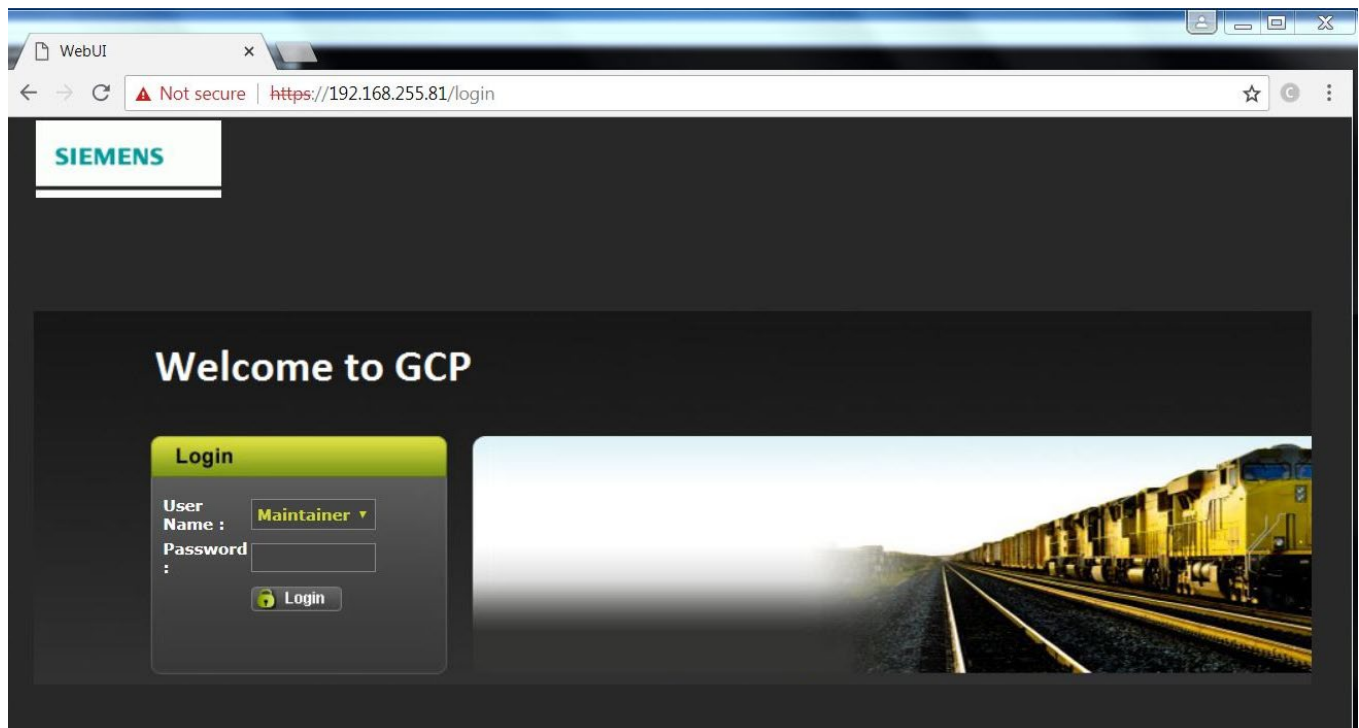

Figure 4-63 WebUI, GCP Login Screen

- From the menu on the left, select **VLP MEF**, then click **Unlock**.

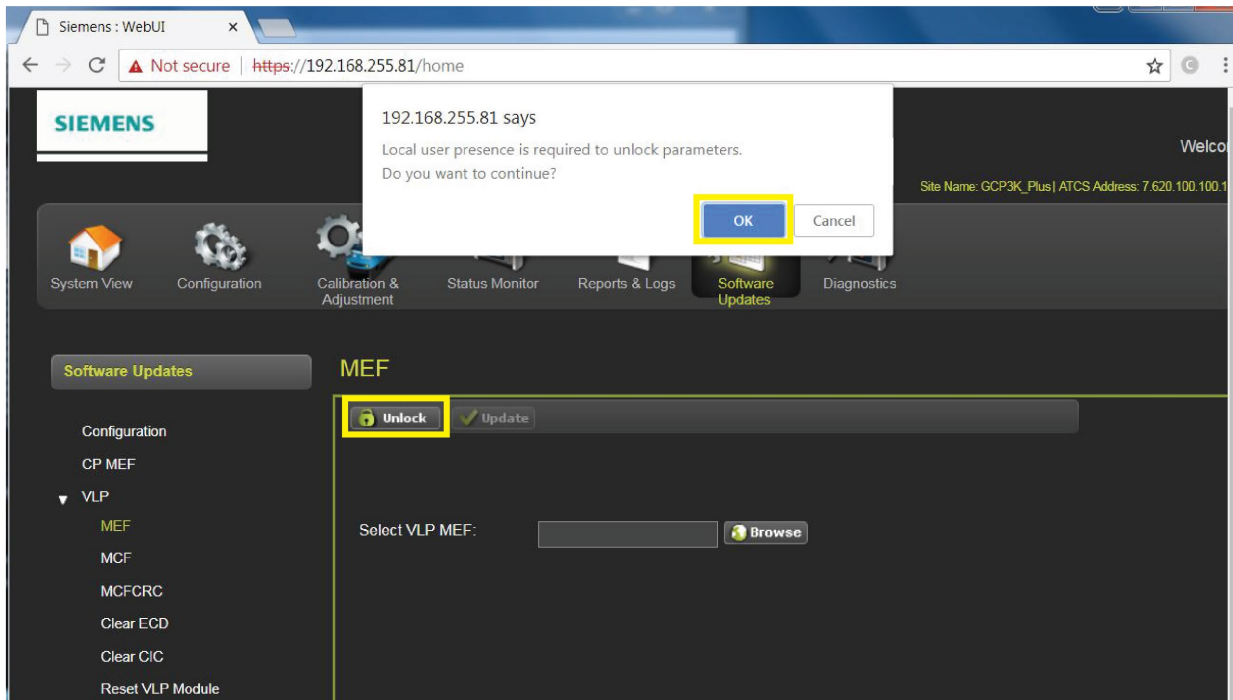

Figure 4-64 WebUI, Menu – VLP MEF Select

- Confirm user presence with the button on the front of the CPU III module, click **OK**, then select **Browse** and locate the desired file.
- Click the **Update** button located next to the **Unlock** button.
- The uploading status will show until complete. Once complete, the message **MEF file uploaded successfully** will display.

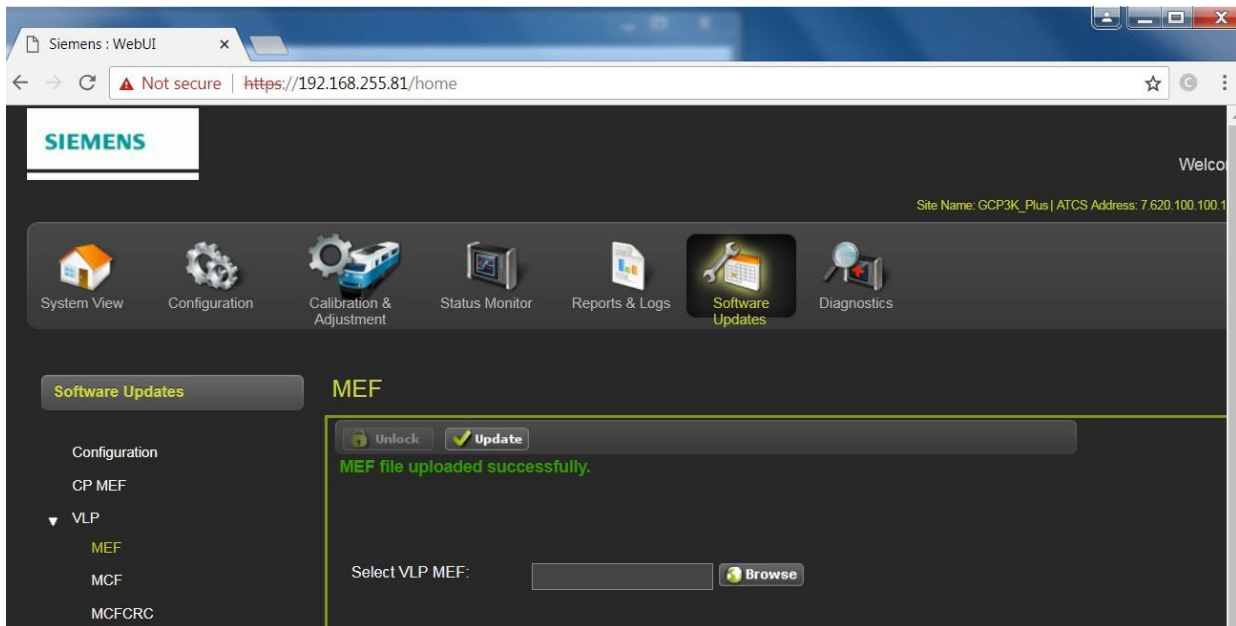

Figure 4-65 WebUI, Menu – Upload Status

4.5.1.6 Change the MCF on CPU III via USB

Perform the following actions:

1. Insert USB Drive in USB slot on front of Display.
2. If Maintainer security has been enabled, enter the password. The password is case sensitive. If security is not enabled, proceed to step 3.
3. Connect an Ethernet cable between the Laptop port on the Display and the Laptop port of the CPU III module.
4. You will need to verify that the Display is set up as a Client instead of a Server, to do so, access the Laptop Ethernet Port menu Program View > 3) Display Settings > Laptop Ethernet Port.

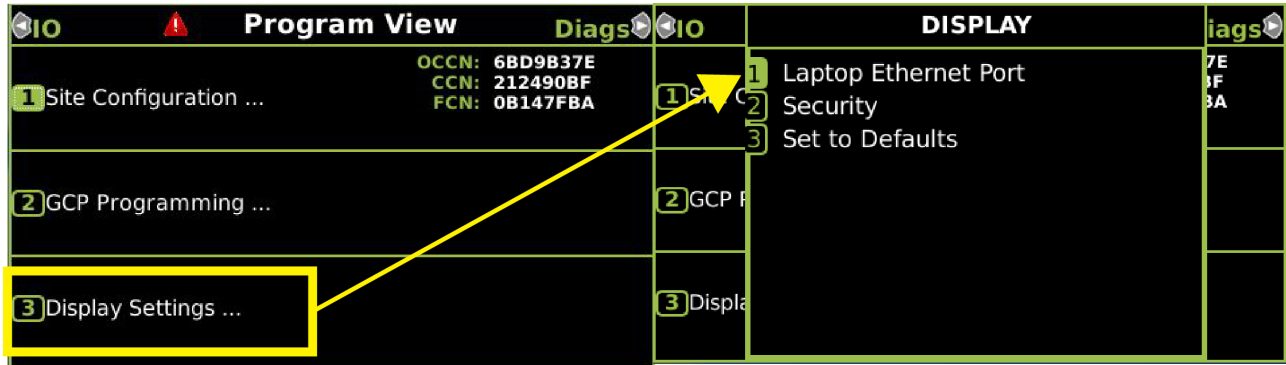

Figure 4-66 Ethernet Menu

5. Select **Client** if Display is configured as Server.

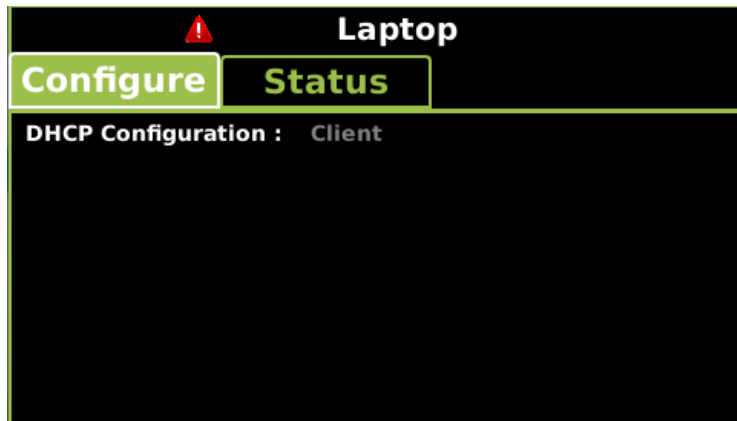

Figure 4-67 DHCP Configuration

6. From the USB menu Select **1) Software Updates > 3) CPU-III Update**.

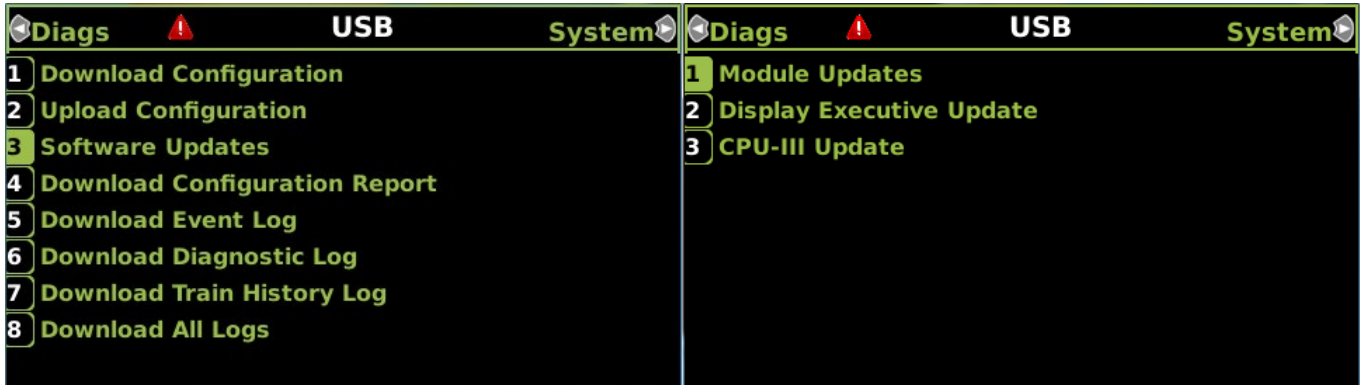

Figure 4-68 Software Update Menu

7. Verify that the Ethernet cable is well seated on both ends.

8. Select **3) Update MCF**.

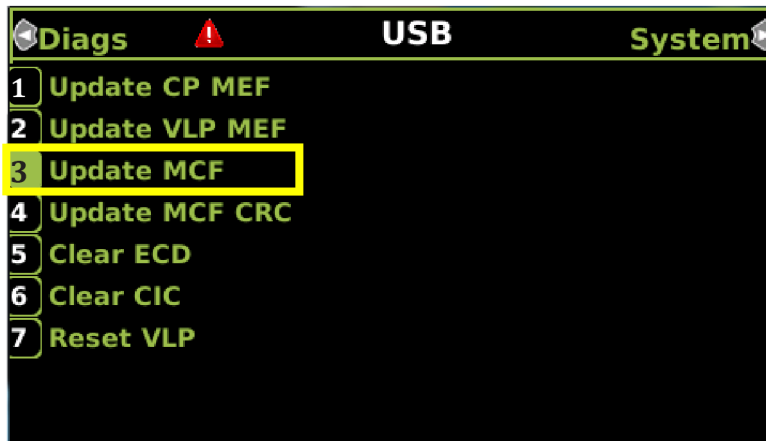

Figure 4-69 Update MCF

9. When asked by the Setup program to Erase the MCF Flash, select **1) Yes**.

10. The **Select File** window opens.

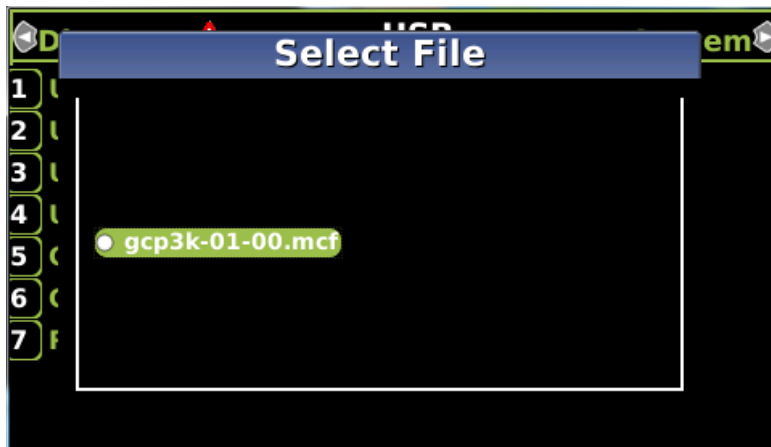

Figure 4-70 Select File Window

11. Scroll down to select the file to be installed, in this example gcp3k-01-00.mcf. Select **Enter**.
12. The new MCF begins loading. This may take a few minutes. While the file is downloading, progress will be indicated on the bottom line of the window.

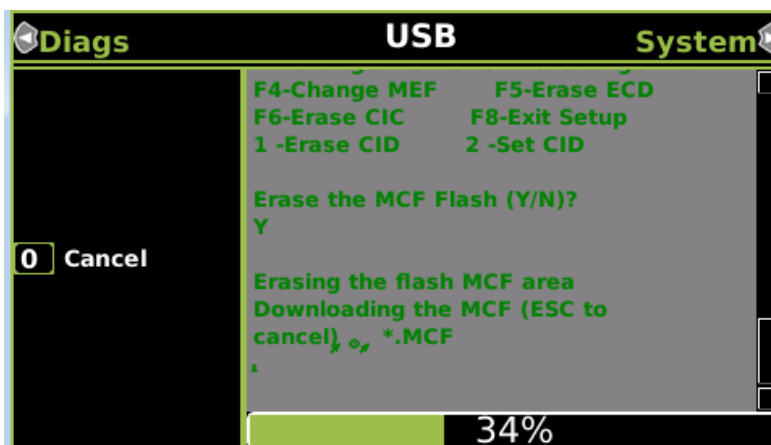

Figure 4-71 Loading Progress Bar

NOTE

NOTE

After the progress bar reaches 100% and stops, the CPU loads a copy of the file to the ECD on the chassis. This will be indicated on the Display screen by the field turning to a grey background and on the 4-character display on the CPU as DOWNLOADING MCF then COPYING MCF TO ECD. Wait until this process completes and the text field has a black background before proceeding, 4-character display shows SETUP.

4.5.1.7 Change the MCFCRC

1. Select 1) Change MCFCRC.

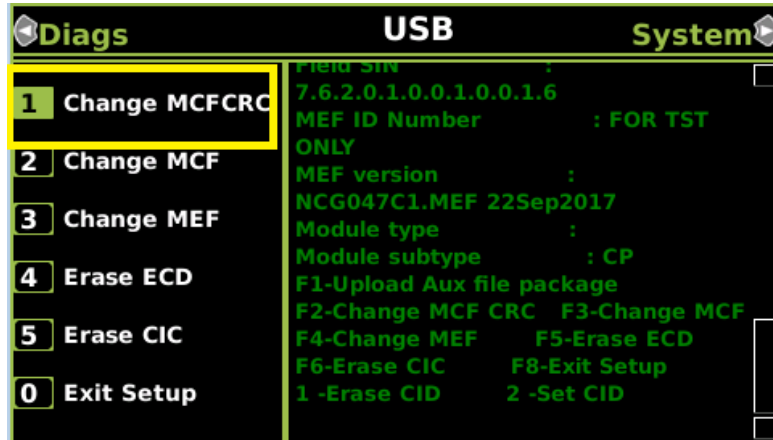

Figure 4-72 Change MCFCRC

2. The Enter MCF CRC for GCP window opens.

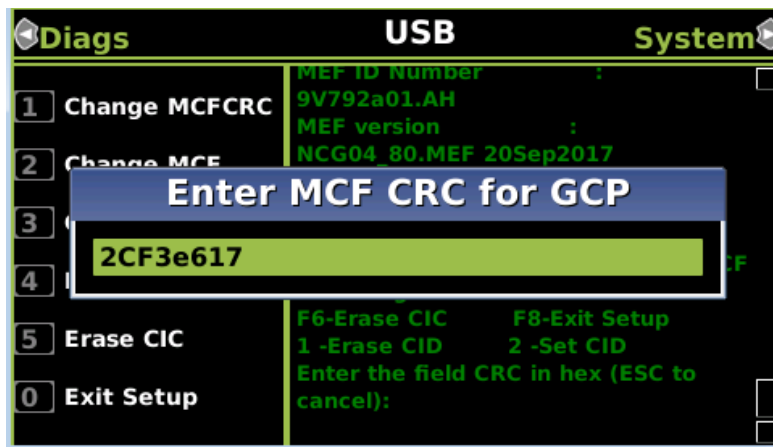

Figure 4-73 Enter MCF CRC for GCP

3. Use the back arrow to clear the number that appears in the window, then use the keypad to enter the CRC issued with the software revision instructions. The CRC will always be 8 characters consisting of 0 through 9 and A through F. Once the number has been entered and verified correct, select **Enter**.
4. When complete, the Display text provides all of the module update options. Select **0) Exit Setup**. The **Upload to System** window opens and states: Exit software finished rebooting the module.
5. Press the Back button. Select 0) Exit View.

4.5.1.8 Change the MCF on CPU III via WebUI

1. Locate the IP address of the DTC unit via the selector buttons on the front of the CPU III unit. Type into a compatible web browser with https:// in front of it.
2. Login to the WebUI using the appropriate Username and Password.

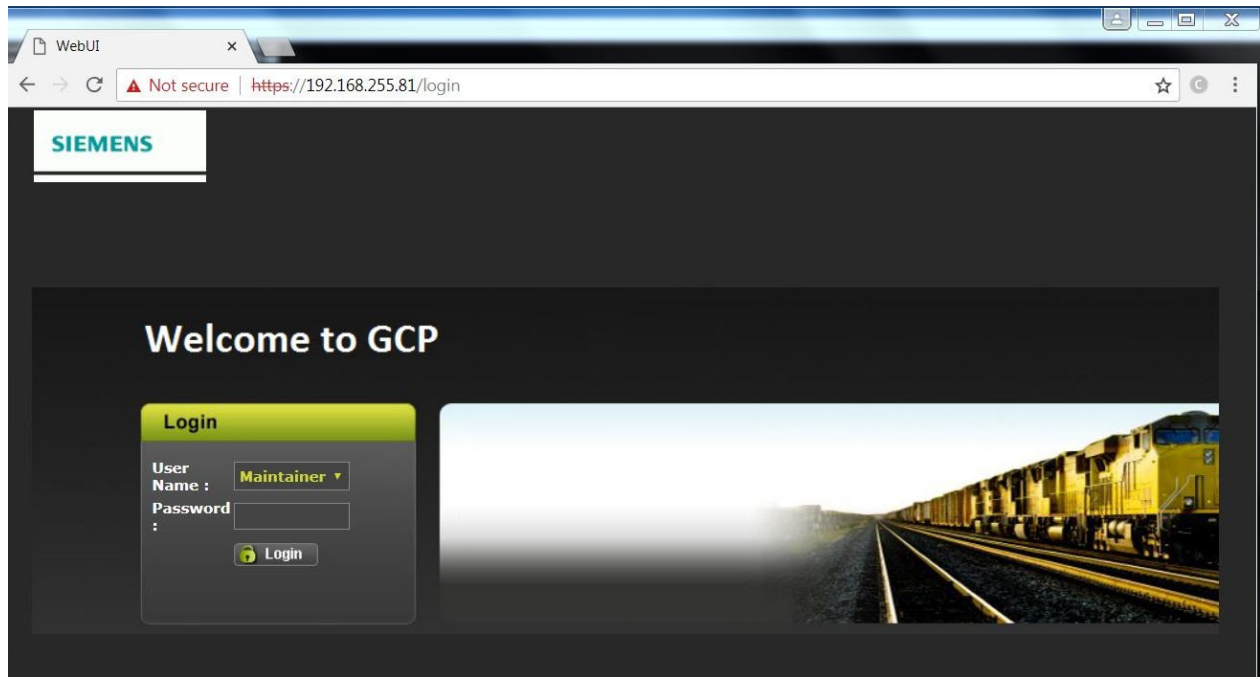

Figure 4-74 WebUI, GCP Login Screen

3. From the menu on the left, select **VLP MCF**, then click **Unlock**.
4. Confirm user presence with the button on the front of the CPU III module, click **OK**, then select **Browse** and locate the desired file.

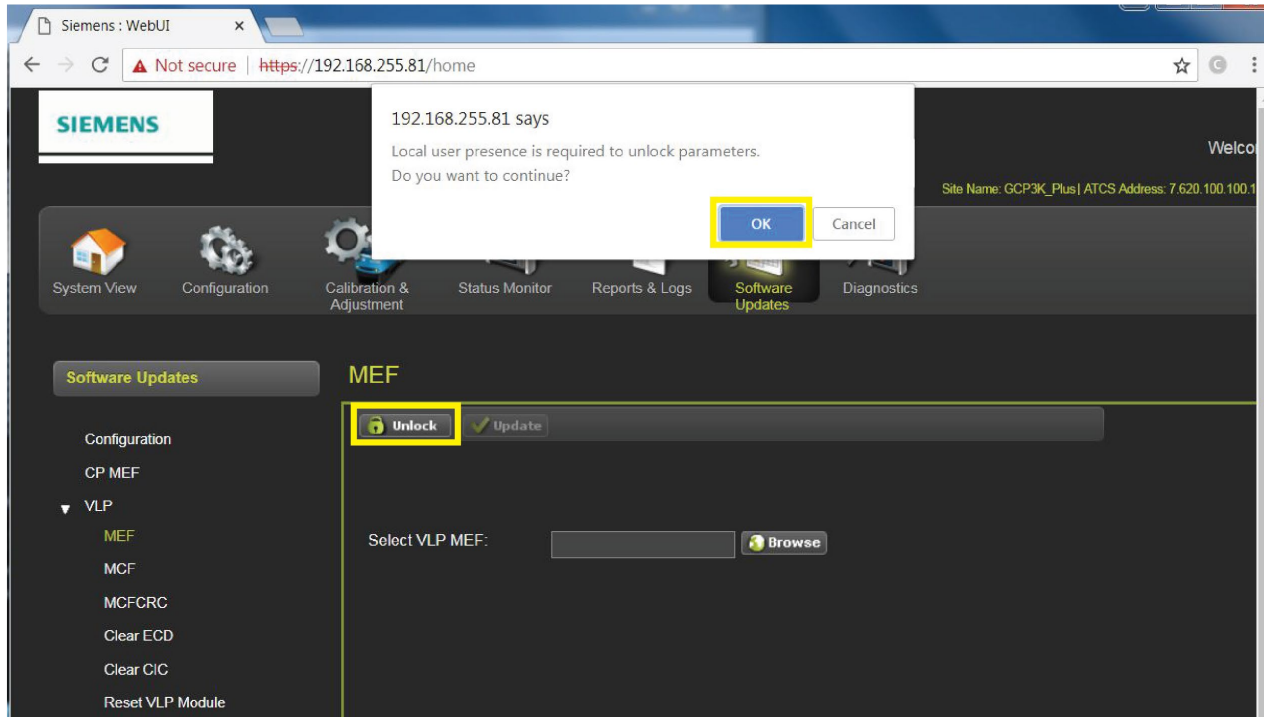

Figure 4-75 WebUI, GCP Menu – VLP MCF UNLOCK

5. Click the **Browse** button and select the correct file. Enter the MCF CRC in the **Enter MCFCRC** field.

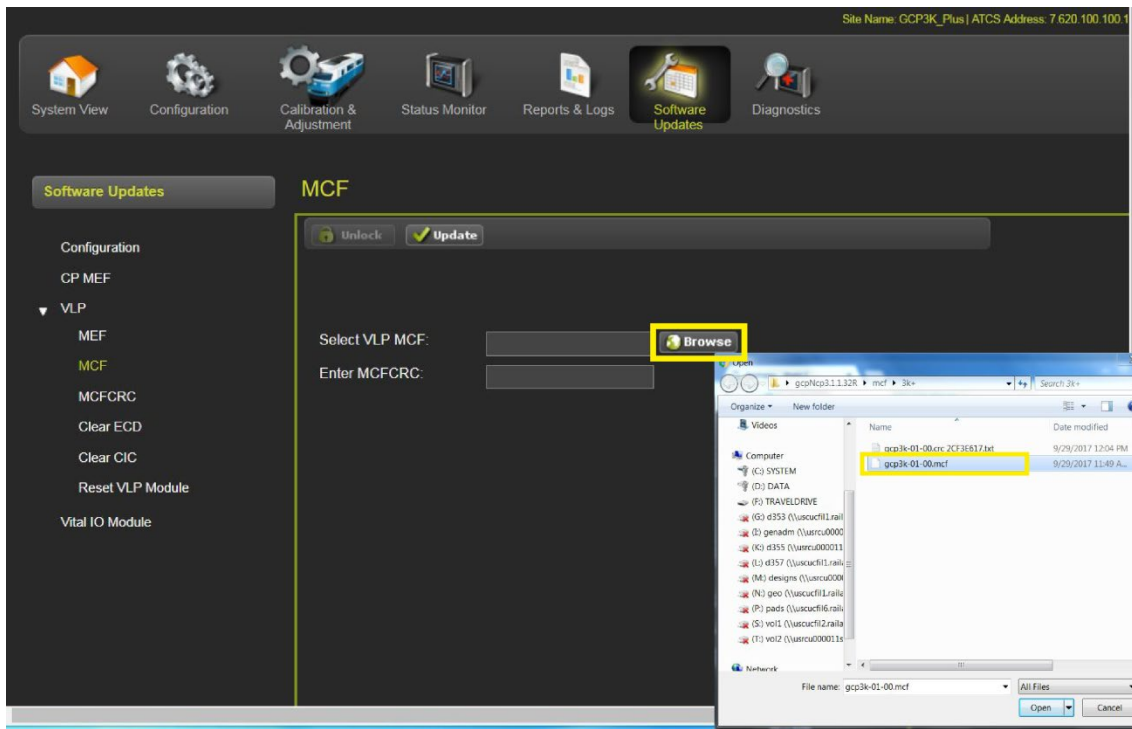

Figure 4-76 WebUI, GCP Menu – Browse

6. Select the **Update** button. Once the file has finished loading the message **MCFCRC uploaded successfully and MCF file uploaded successfully.**



Figure 4-77 WebUI, GCP Menu – Update Status

This completes **Installing Software on the CPU Card.**

4.5.2 Installing Software on Track Module

To install the DTC01_00.mef files on the Track Modules.

Perform the following actions:

1. Insert USB Drive in USB slot on front of Display
2. If Maintainer security has been enabled, enter the password. The password is case sensitive. If security is not enabled, proceed to step 3.
3. Connect the serial cable between the Diag port on the Display and the DIAG port of the Track module to be updated.
4. From the USB menu, select **1) Software Updates > 1) Module Updates.** The Upload to System window opens stating: **Please check the serial cable connection before uploading.**
5. Verify that the serial cable is well seated on both ends, then press any key. The Setup program begins loading.
6. Select **1) Change MEF.**

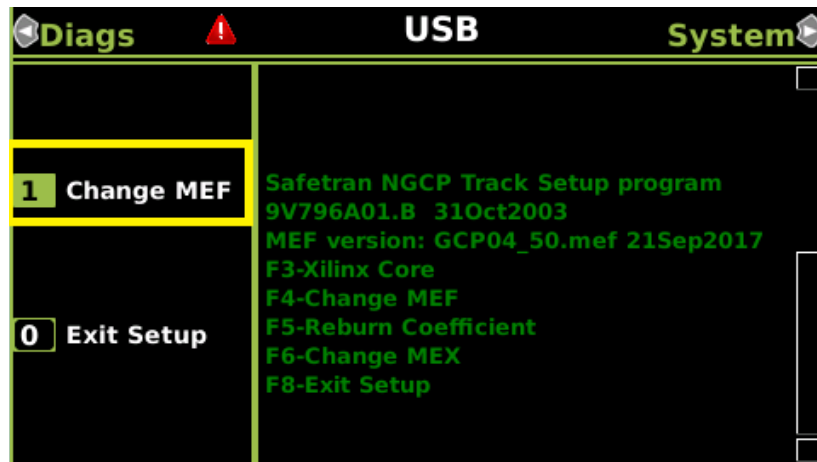

Figure 4-78 Change MEF

NOTE

NOTE

The setup code menu shows more menu options that are available on the left. These options are for Siemens R&D use only and are not available using the Display module.

- When asked by the Setup program to Erase the MEF, select **1) Yes**.

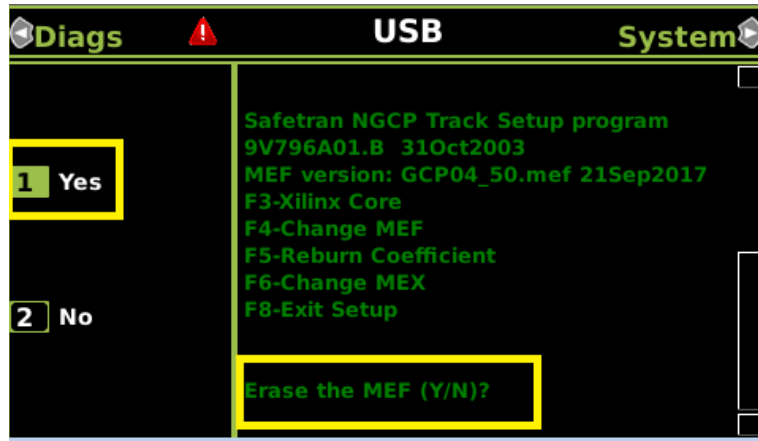

Figure 4-79 Erase MEF

- The **Select File** window opens. Scroll down to select the file to be installed, in this example dtc01_00. Select **Enter**.

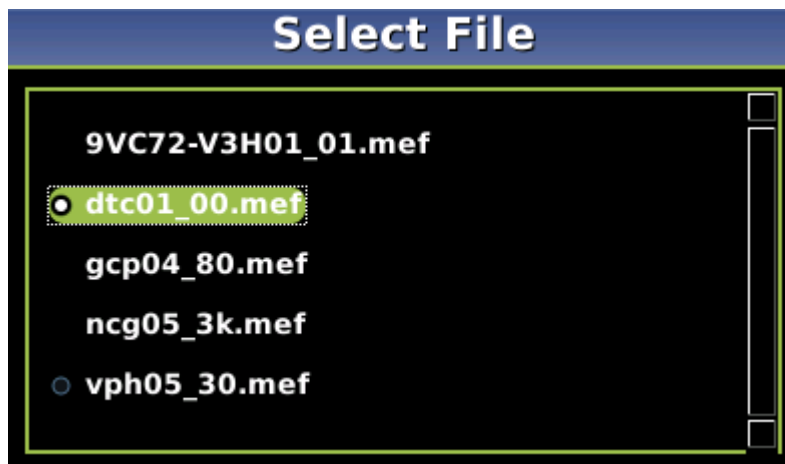

Figure 4-80 Select File Window

9. The new MEF begins loading. This may take a few minutes. While the file is downloading, progress will be indicated on the bottom line of the window.

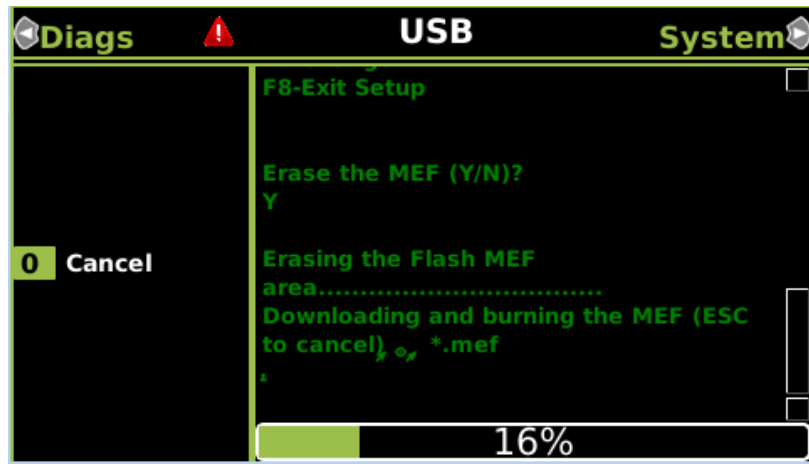

Figure 4-81 MEF Loading

10. When complete, the Display text provides all of the module update options. Select **0) Exit Setup**. The **Upload to System** window opens and states: **Exit software finished rebooting the module**.
11. Press the **Back** button.
12. If there is a second track module, repeat the procedure for the other track modules.

4.5.3 Installing Software on Display Module

To install the Non-Vital MEF files on the A80485-1 Display Module, perform the following actions:

1. Insert USB Drive in USB slot on front of Display.
2. If Maintainer security has been enabled, enter the password. The password is case sensitive. If security is not enabled, proceed to step 3.
3. Select **1) Software Updates > 2) Display Executive Update**.

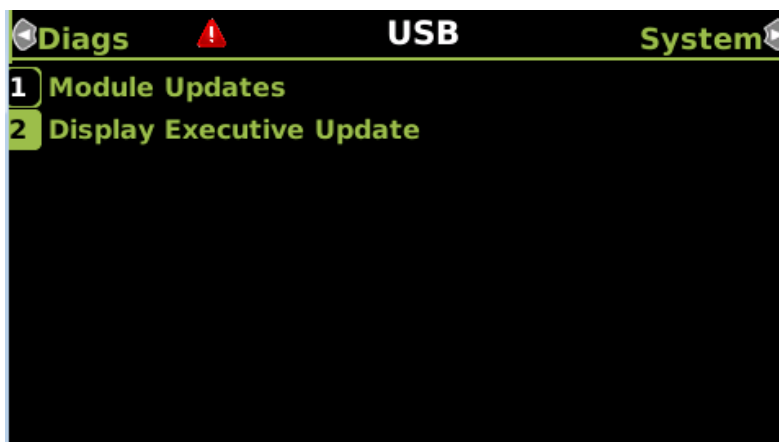

Figure 4-82 USB Update Window

4. The **Select File** window opens. Select the correct file to load, in this example NG5K_MEF_1.4.47R.TGZ. Select **Enter**.

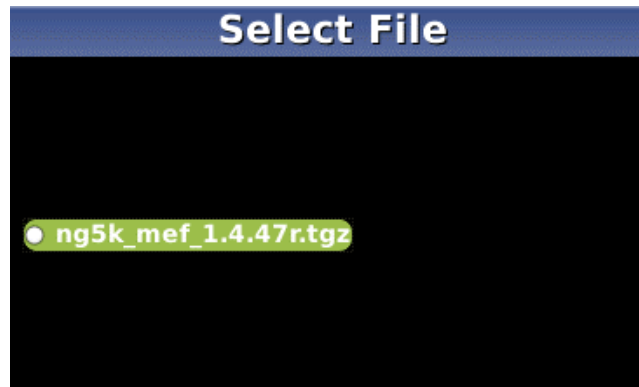

Figure 4-83 Select File Window

5. The Upload NV Executive window opens, stating: **Please wait. Request sent to Executive...** The new MEF begins loading. This may take a few minutes. While the file is downloading, progress will be indicated on the bottom line of the window.
6. When complete, the **Upload to NV Executive** window opens and states: **Uploaded NV Executive. Press Enter to Reboot or Back to Reboot later.**
7. Select **Enter**. The Display reboots.
8. Press the **Back** button. Select **0) Exit View**.

4.6 WEB USER INTERFACE SCREENS

The Display and CPU III modules provide a Web Interface, which enables the user to configure the DTC locally as well as remotely through the Laptop/Ethernet Port (RJ-45) on the front of the Display Module, and the Laptop/Ethernet port on the front of the CPU III module. The Display Laptop Port default protocol is set as DHCP Server. If it is to be connected to a network, it will need to be configured as Clients or fixed IP.

The CPU III will also default to operating as a DHCP Server. In a DTC application the CPU III laptop port is used to connect the DTC to the Yard control system. Thus it will need to be configured with a specific IP address rather than being used in its default mode as a DHCP server. See section 5.5.1 for details on how to set this.



CAUTION

THE DHCP SERVER SETTING ON THE CPU III LAPTOP PORT MUST BE DISABLED BEFORE CONNECTING TO A NETWORK.
FAILURE TO DO THIS MAY RESULT IN NETWORK DISRUPTION.

The default IP address for the Display and CPU III modules from the factory are <https://192.168.255.81>.

The current IP address of the CPU III can be seen on the four-character display. To view the IP address press the Select button once, then press the NAV button multiple times until the scrolling IP address text is displayed.

The WebUI uses the HTTP Secure (https) protocol. The Display and CPU III DHCP Server protocol will assign the laptop an IP address and connect the user to the DTC. The Display and CPU III support the following web browsers:

- IE 10 and 11 or later
- Firefox (version 46.x) or later
- Chrome (version 55.x) or later

Open a web browser and type in the IP address of the Display. The browser may give the following screens regarding the connection.

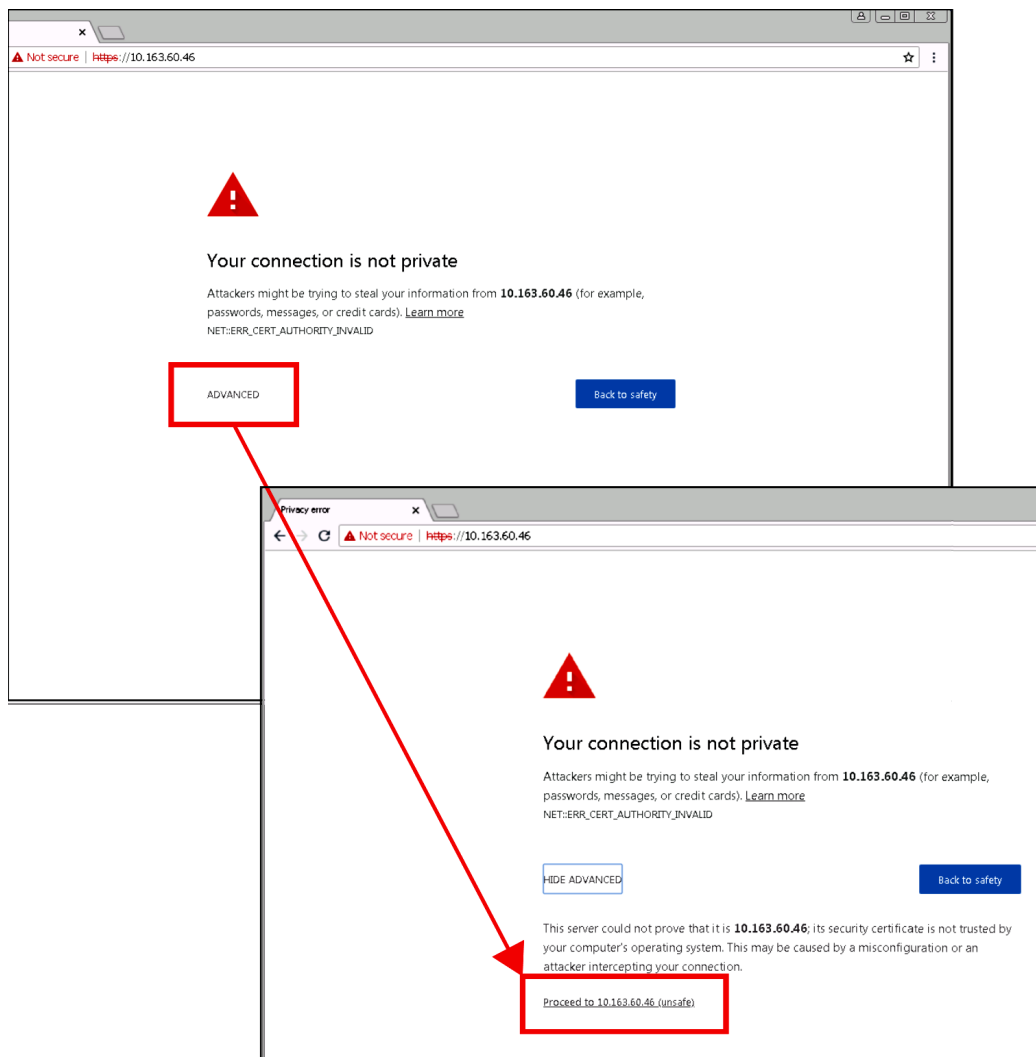

Figure 4-84 Unsecure Connection Warning

Click the **Advanced** option and select the option to proceed to the WebUI.

The WebUI will then appear. Select the username as Maintainer (default). The Admin is for Siemens personnel use only.

The default password is GCP4000 (case sensitive) to open the session. If the security has not been set to enable a maintainer password, this default will allow all regular user functions of the WebUI to be accessed. If a specific maintainer password has been set, enter this. The default GCP4000 may still be used to access the WebUI, but the user will be unable to change GCP Programming parameters.

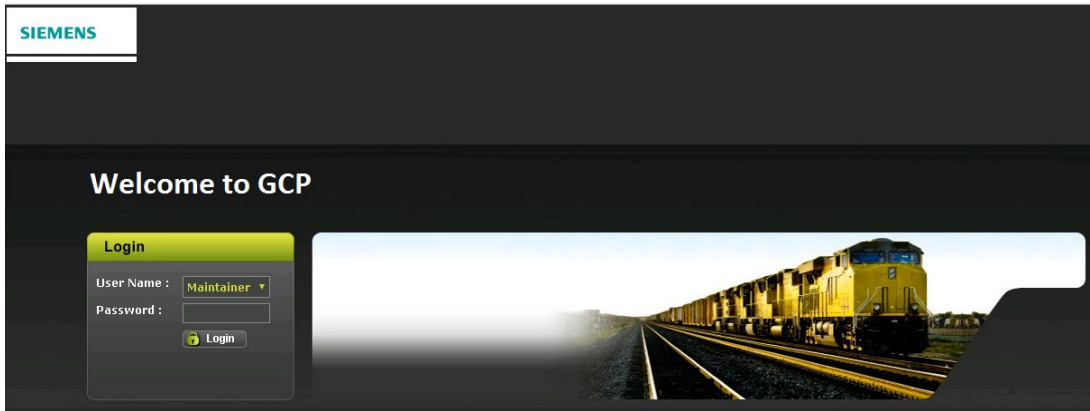

Figure 4-85 WebUI Login Screen

CAUTION

CAUTION

IF THE EQUIPMENT IS TO BE CONNECTED TO A NETWORK, IT WILL BE NECESSARY FOR THE USER TO SET THE ETHERNET PORT AS A CLIENT.
FAILURE TO DO SO WILL CAUSE AN INTERRUPTION OF THE NETWORK SINCE TWO DHCP SERVERS WILL BE INTRODUCED ONTO THE NETWORK.

NOTE

NOTE

The web server has a 1-minute session timeout. If the web browser is closed without selecting **Logout**. The user will not be able to log back in for 1 minute.

See Section 4.6.9 for instructions on using the Display on a network.

The WebUI has buttons at the top which allow the user to select the various functions.

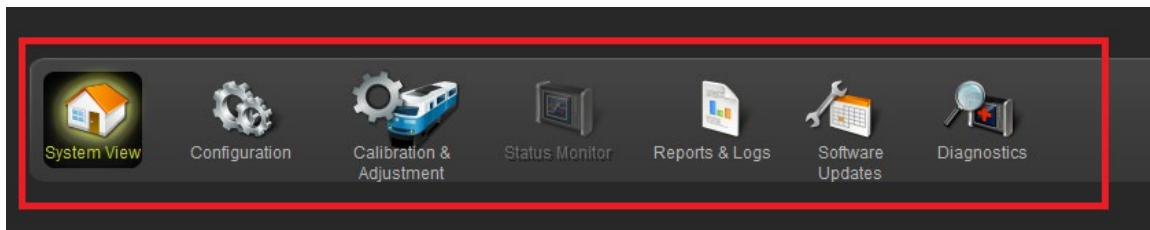

Figure 4-86 WebUI Tool Bar

4.6.1 System View

The System View is the main screen that shows an overview of the DTC status. If there are diagnostic messages present, the System View will show the red exclamation mark in the top right.



Figure 4-87 System View

The System View shows the status of each track module. The same convention as the Display screens is used for the LED icons.

- Green – energized
- Grey – de-energized
- White – function not configured as used in DTC
- Red – unhealthy / failed

If a track module is not fully calibrated, the required calibrations are indicated.

If diagnostic messages are present related to a track module, the system view will show the red diagnostic indicator on that track.

System View also shows other general status indications:

- XFER: This shows whether the system is on Main or Standby (DTC application will always show Main).
 - Green indicates the system is healthy.
 - Grey indicates the system is not healthy.
- SSCC: This shows the crossing controller status. This is not applicable in DTC applications.
- AND: XR: This shows the XR status in crossing application, this is not applicable in DTC applications.

The System View has menus on the left that allow other WebUI screens to be accessed.

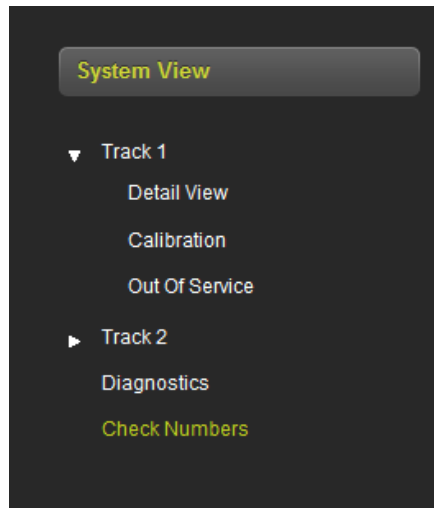

Figure 4-88 System View Menus

4.6.1.1 Track – Detail View

The track detail view shows more detailed information about the track module. This screen is primarily used to see the information shown in Figure 4-89 (highlighted with yellow boxes) as this is not available elsewhere on the WebUI:

- Check EZ – value of EZ on the check wires (not applicable for DTC applications)
- Track Check Number (TCN) and date and time it was last changed.

The track detail screen also shows the user the EZ/EX limits information consisting of:

- the highest EZ value the track has recorded since this screen was last reset and the EX value at that time. The time/date this occurred is shown.
- the lowest EX value the track has recorded since this screen was last reset and the EZ value at that time. The time/date this occurred is shown.

The values can be reset by pressing the **Reset** button.

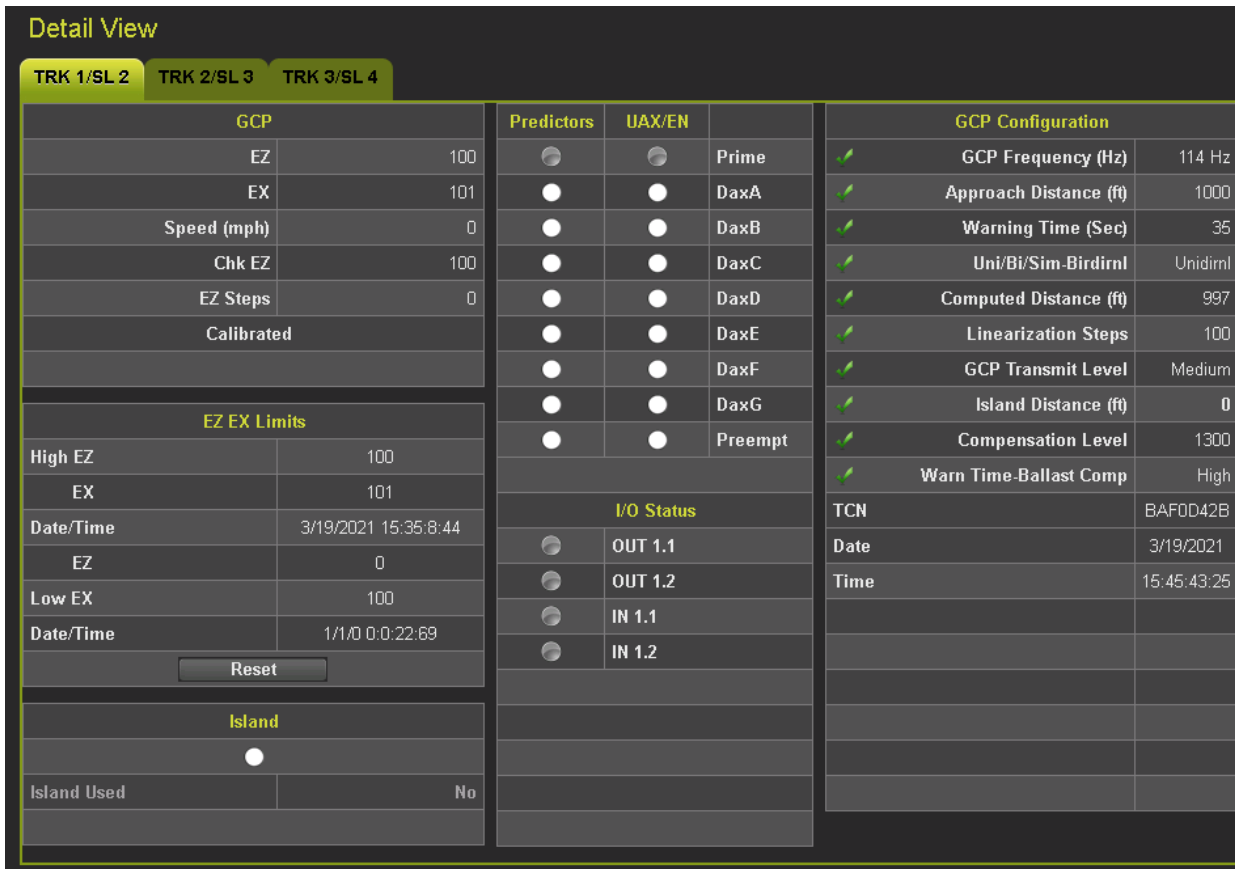

Figure 4-89 Track Detail View

4.6.1.2 Track - Calibration

The calibration screen can be accessed from the **System View Track Calibration** menu or from the **Calibration & Adjustment** icon on the tool bar.

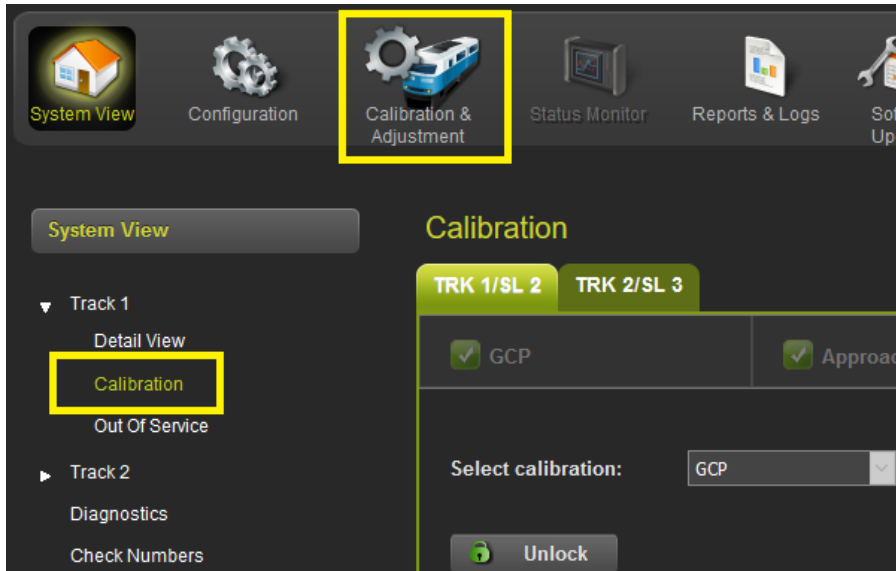

Figure 4-90 Selecting Calibration

The Calibration screen shows the state of the calibration for the specified track. If the calibrations are complete, these are marked with a green check mark as shown in Figure 4-91.

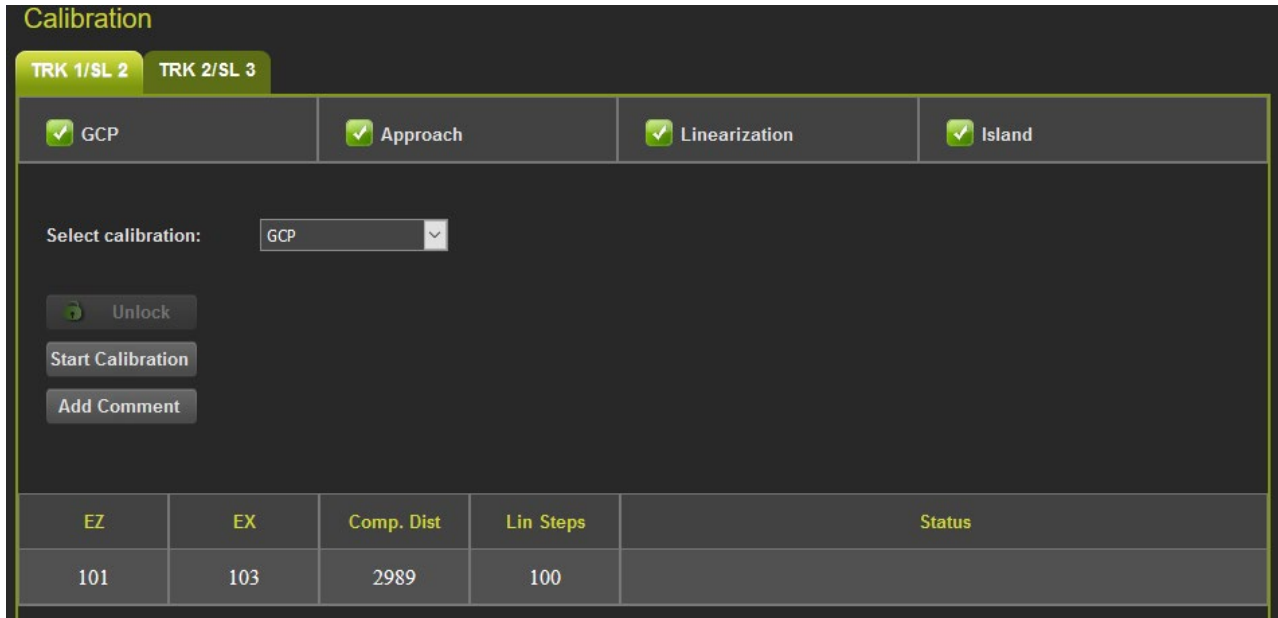

Figure 4-91 Calibration Not Required

If the calibrations are required, these are marked with a red check box as shown in figure below.

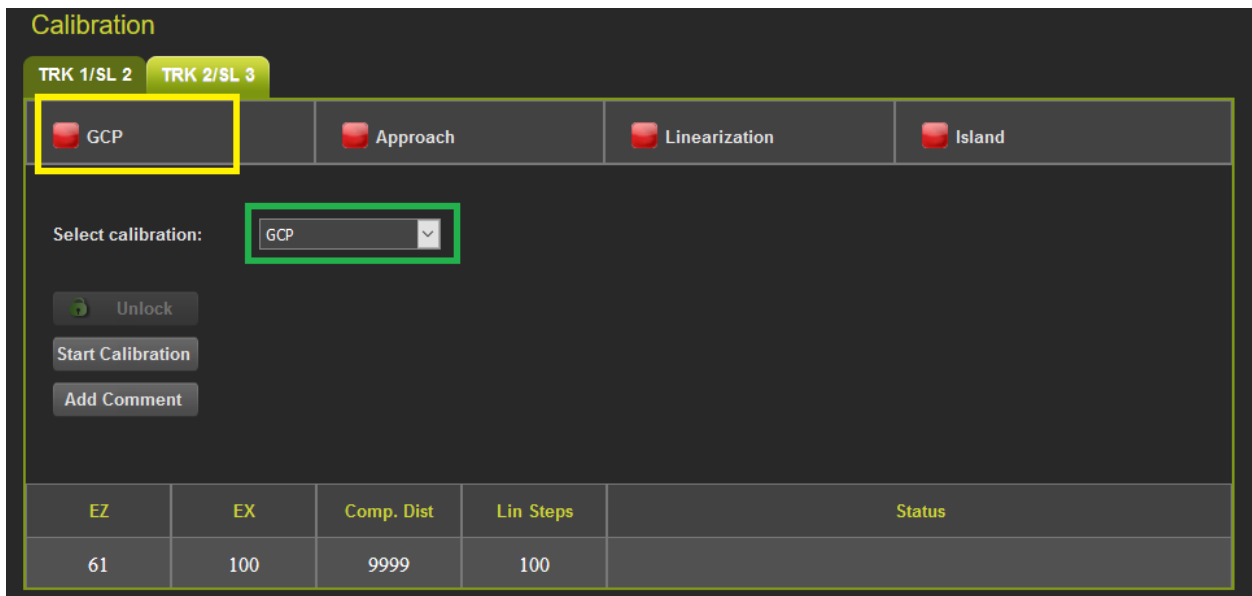

Figure 4-92 Calibration Required

To select which calibration to perform, either click on a specific calibration in the menu bar, for example, GCP shown in the yellow box above, or select the calibration from the drop-down menu shown in green box (Figure 4-92).

The island is not used in the DTC, so no Island calibration is required.

See Section 6.3 for the detailed instructions on performing calibrations.

4.6.1.3 Track – Out-of-Service

Not used in DTC applications.

4.6.1.4 Diagnostics

Selecting the Diagnostics menu from the System view will show the Diagnostics screen. This shows diagnostic messages present in the system. The slot column shows which component this is related to:

- Trk ‘N’ indicates a diagnostic message related to track module ‘N’.
- SYS 1 indicates a system diagnostic message not specific to a track module.

If a specific message is selected, the display will show possible causes of this diagnostic messages and remedies to help fix it.

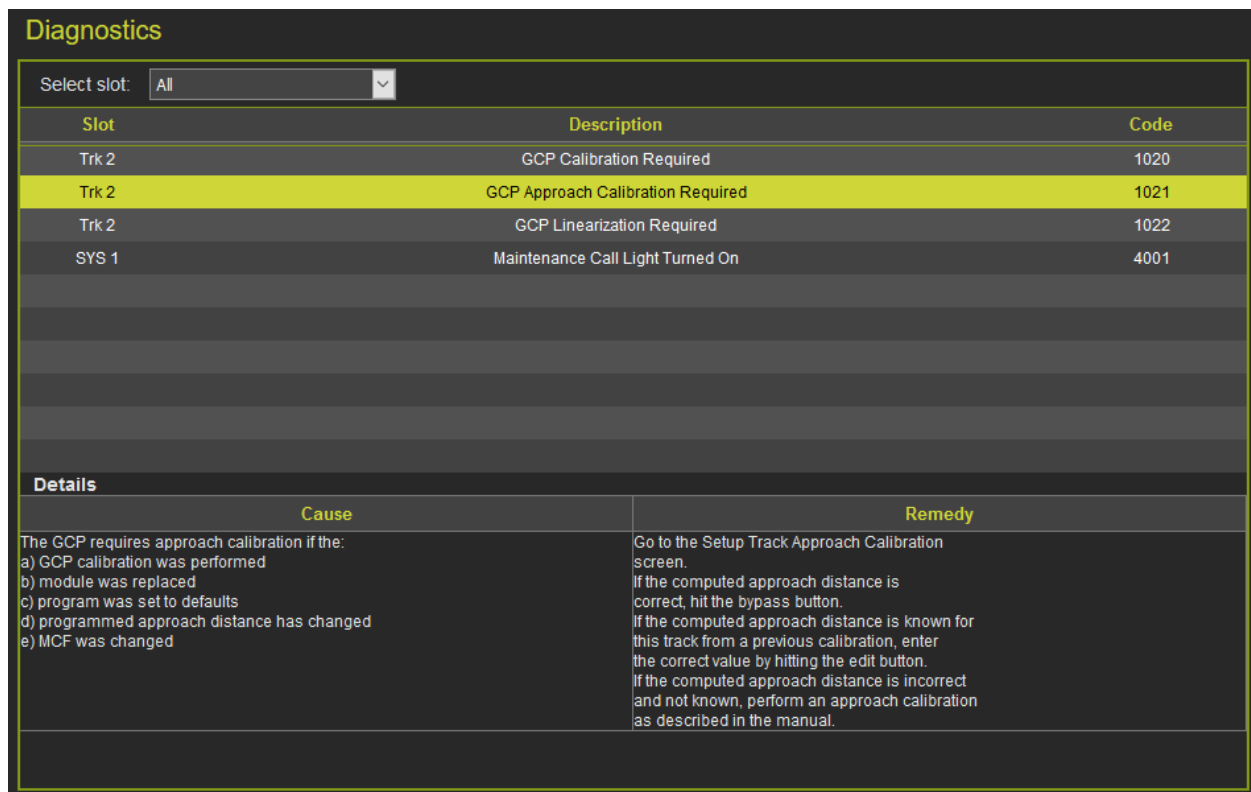

Figure 4-93 Diagnostic Message

4.6.1.5 Check Numbers

The check numbers screen will show the following check numbers:

- MCF Name – the name/version of the MCF
- MCF CRC – the CRC of the MCF that is running
- CCN - Configuration Check number, a check number that covers every configuration parameter that is part of the GCP programming and can be used to check whether anything in the vital programming has been changed.
- OCCN – Office Configuration Check number, used to verify configuration settings prescribed by design office are correct
- FCN – Field Check number: a check number that changes when changes are made to the calibration of the GCP. The check number will change whenever a GCP, approach or linearization is performed.

In general, the only check number needed in the DTC application is the MCF CRC. OCCN and FCNs are not required in DTC applications.

4.6.2 Configuration

When the configuration icon on the tool bar is selected, the WebUI will show the menu illustrated in the following figures. Figure 4-94 shows the WebUI Display Configuration menu and Figure 4-95 shows the WebUI CPU III Configuration menu.

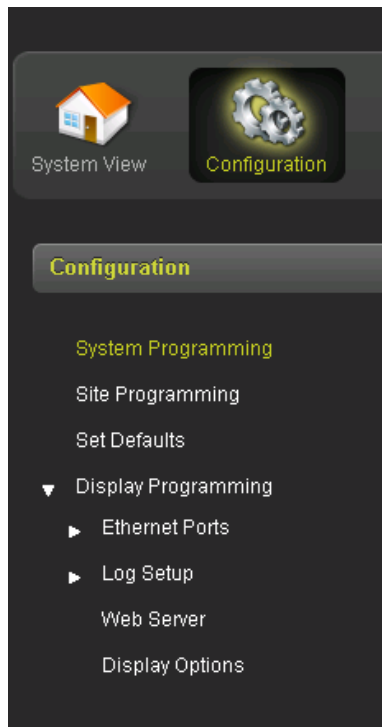

Figure 4-94 WebUI: Display Configuration Menu

NOTE

NOTE
The configuration parameters can be changed using the CPU III WebUI without requiring local user presence.

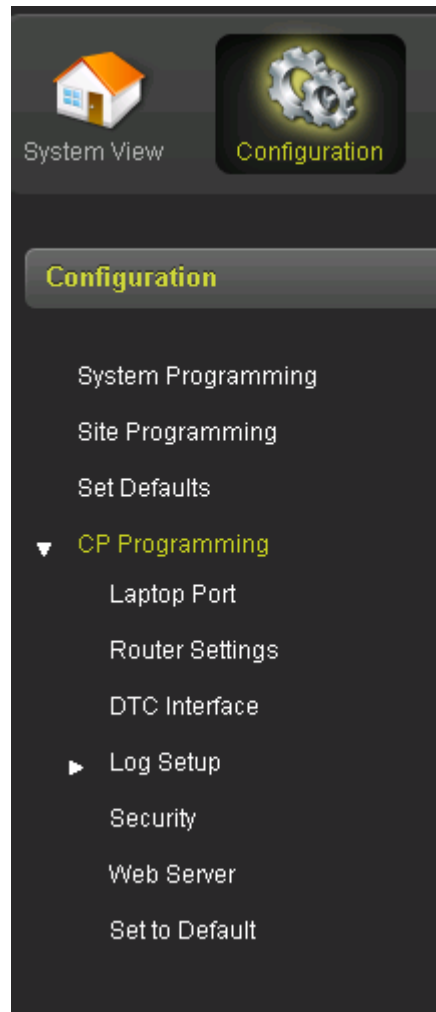

Figure 4-95 WebUI: CPU III Configuration Menu

- **System Programming** is used to set the DTC parameters that control the operation and the track.
- **Site Programming** is used to set up the non-vital site information, for example, ATCS Site Id, Time, and location parameters (site name, milepost, DOT number).
- **Set Defaults** is used to set the System Programming parameters back to defaults. The Site and Display Programming are unaffected.
- **Display Programming** is used to set non-vital settings related to the operation of the display.
- **CP Programming** is used to set non-vital settings related to the operation of the CPU III.

NOTE**NOTE**

The CP Programming parameters cannot be set via the Display Module, and they do not appear on the configuration report from the Display Module. They must be set on the CP module WebUI.

To obtain the CP Programming parameters, download the configuration report from the CPU III.

In DTC application the user will need to use the CPU III WebUI to set the following, see section 5.5 for details:

- a) CPU III laptop IP address
- b) DTC IP address.

Section 5.0 discusses the programming options in detail.

4.6.2.1 System Programming

This screen is used to set parameters that affect the operation of the DTC.

To edit the parameters, first unlock and confirm local user presence (see Section 4.6.7). The fields will now be editable.

NOTE**NOTE**

If the Security Enabled is set to Maintainer, the correct Maintainer password has to be entered in the WebUI in order to edit parameters. If the default password is used, the DTC programming parameter will remain locked.

To edit a field, either select from the drop-down list, or enter a numerical value as appropriate.

Multiple fields on this page can be changed before saving. After the required fields are changed, press **Save** to implement the changes. If there are unsaved changes and a new screen is selected, the WebUI will prompt the user to save or discard the changes.

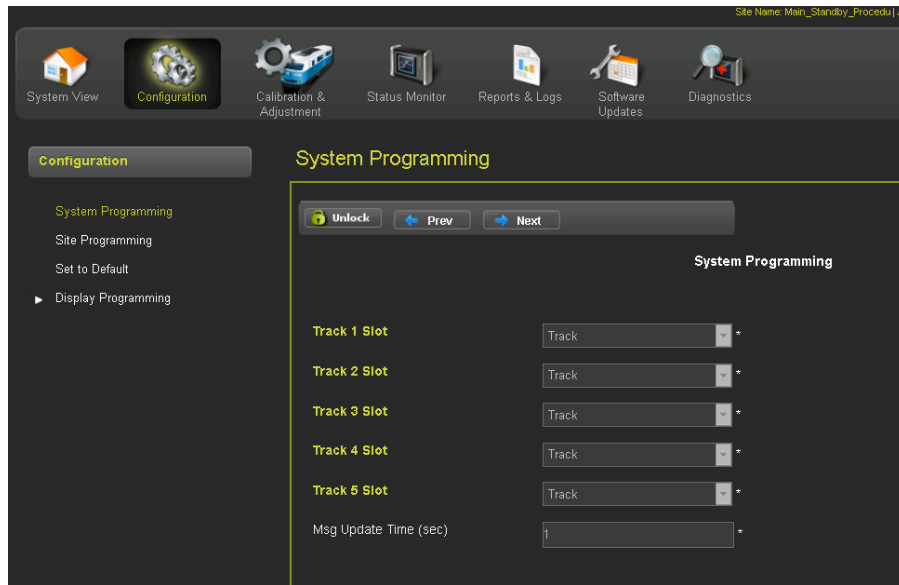

Figure 4-96 Display WebUI: System Programming

4.6.3 Calibration and Adjustment

This icon will bring up the same calibration page as the **Track Calibration** menu described in Section 4.6.1.2. See that section for details.

4.6.4 Status Monitor

The Status monitor screens are not used in the DTC application.

4.6.5 Reports and Logs

Selecting the **Reports and Logs** icon will result the WebUI showing the following menu selections.

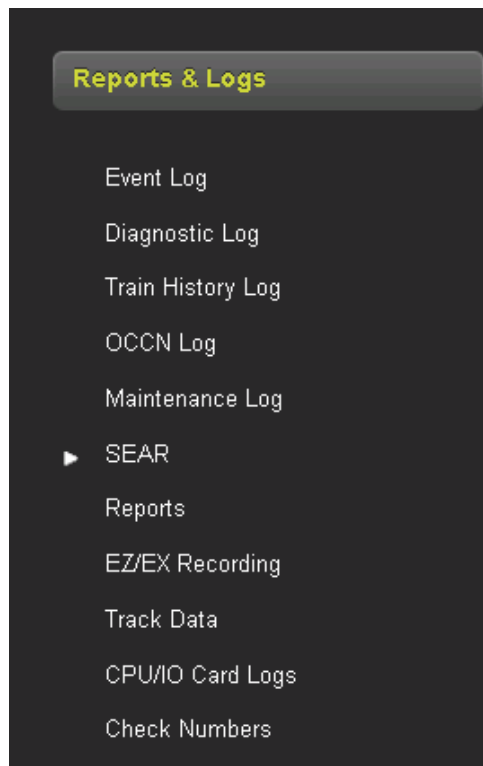

Figure 4-97 WebUI: Reports and Logs Menu

The WebUI will also display the last events in event log when the Reports and Logs are first entered.

4.6.5.1 Event Log

The display contains an event log. The events in here are generated by the CPU and sent to the display where they are time stamped and added to the log.

The WebUI event log page allows the user to page through the event, download all or part of the log, or turn on a real time trace so new events get displayed as they are logged.

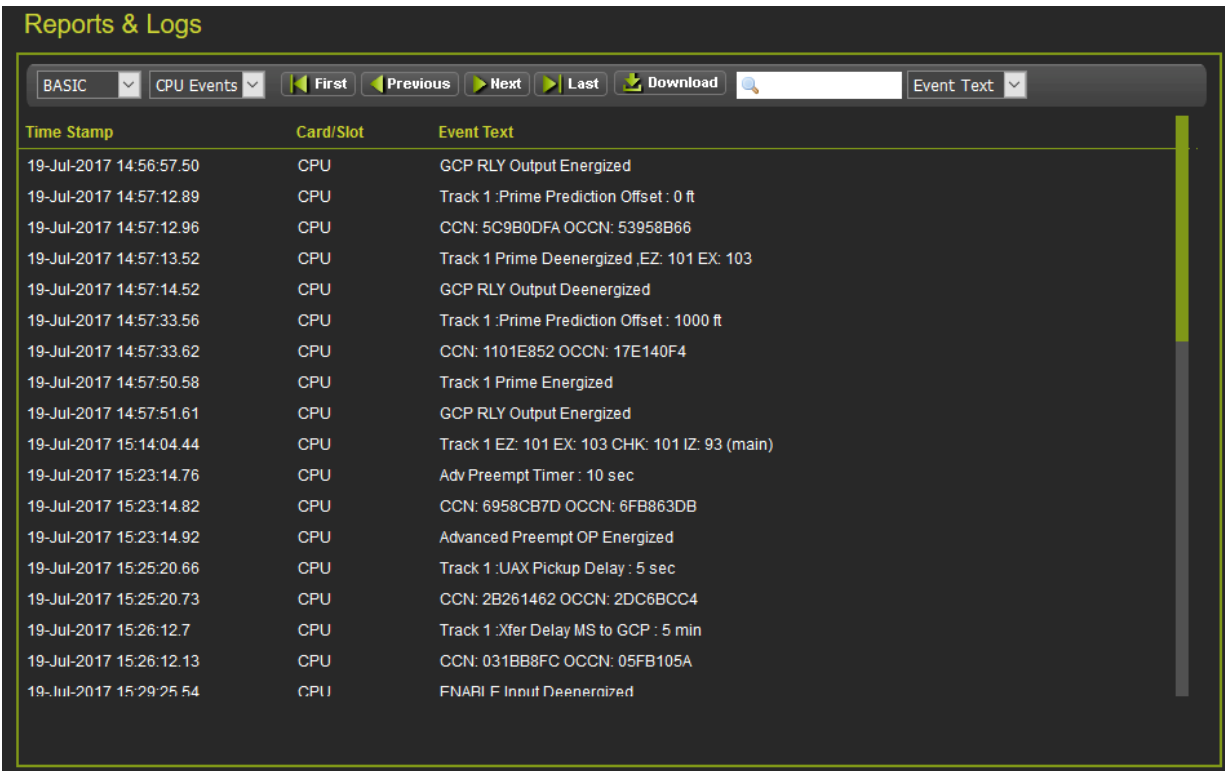

Figure 4-98 WebUI: Event Log

Use the buttons as follows:

- First – show the oldest page of events in the log
- Last – show the newest page of events in the log
- Previous – move back a page in the log
- Next – move forward a page in the log

50 events are shown per page. Use the scroll bar on the right to see all the events on the page.

The Download button provides the following selections:

- Displayed – download the current page displayed
- Last 24 hours – downloads the events that occurred in the last 24hrs
- All – downloads the whole event log

The screen provides a filter box so events that match the entered text are the only shown. Enter the text to be filtered, then press enter.

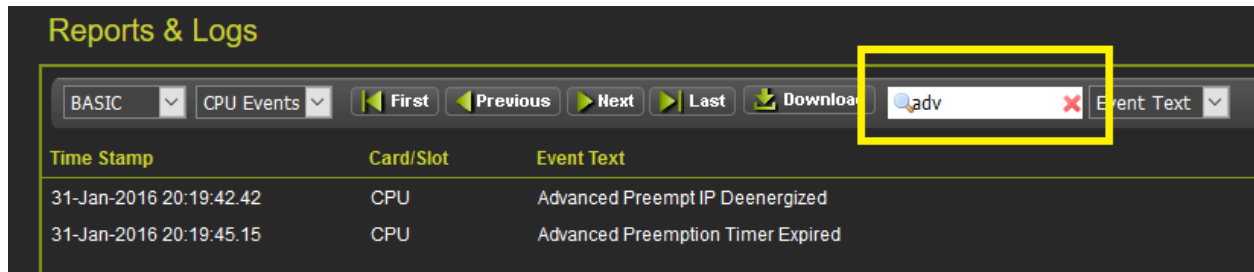

Figure 4-99 WebUI: Event Log Text Filter

To clear the filter, either delete the text in the box and press **Enter** or press the red **X**.

The events log contains both the CPU events and also the Diagnostic events. To see the Diagnostic events, either change the log filter to Diagnostic, or select the Diagnostic Log menu item from the left menus.

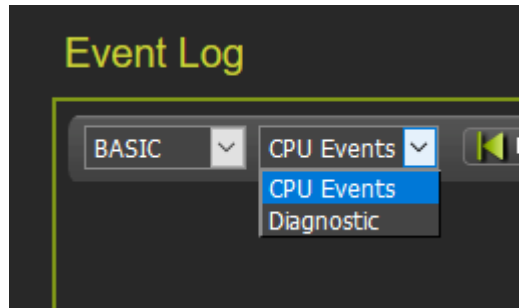

Figure 4-100 WebUI: Log Selection Filter

The first drop-down menu on the Event Log page allows the selections shown in the following figure with **BASIC** as the default.

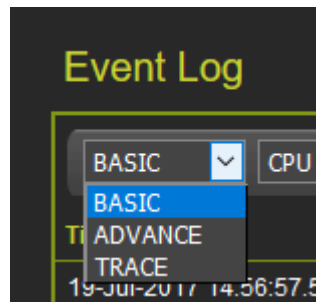

Figure 4-101 WebUI: Event Log Mode

If **ADVANCE** is selected, the WebUI allows the user to choose a range of dates to view. Enter the required date range. The **First** button will now show events from the start date and time. The **Last** button will now show events up to the selected end date and time. The **Download** button now has the option to download a selected range.

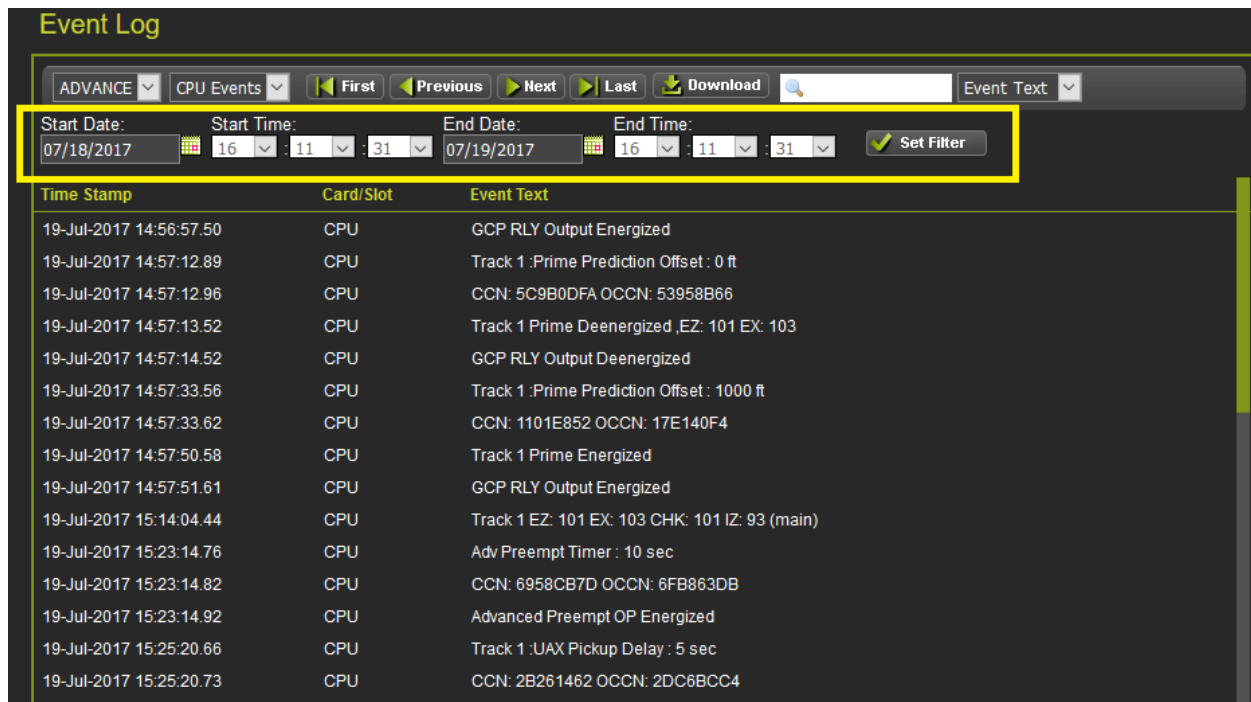

Figure 4-102 WebUI: Event Log ADVANCE Mode

If **TRACE** is selected, the WebUI will go into Trace mode and add events to a text buffer as they are received in real time. To pause the trace, press the **Stop** button. To restart tracing, press the **Start** again. To clear the trace buffer, press the **Clear** button. Press the back button to exit **TRACE** mode and return to the **BASIC** mode.

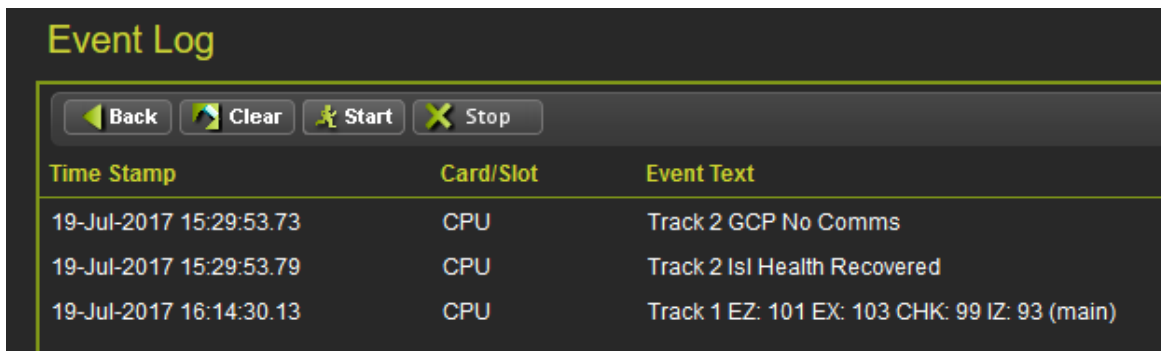

Figure 4-103 WebUI: Event Log TRACE Mode

4.6.5.2 Diagnostic Log

The Diagnostic log contains entries for whenever a diagnostic message is generated or cleared. The events in here are generated by the CPU and sent to the display where they are time stamped and added to the log.

The WebUI diagnostic log page allows the user to page through the events, download all or part of the log, or turn on a real time trace so new events get display as they are logged.

Time Stamp	Card/Slot	Event Text
19-Jul-2017 15:30:08.25	DIAG	Trk_2: GCP Stabilizing -CLEARED
19-Jul-2017 15:30:03.43	DIAG	Trk_2: Island Stabilizing -CLEARED
19-Jul-2017 15:29:58.63	DIAG	Trk_2: No Communications -CLEARED
19-Jul-2017 15:29:54.3	DIAG	Trk_2: No Communications
19-Jul-2017 15:29:54.11	DIAG	Trk_2: Receiver Error 1 -CLEARED
19-Jul-2017 15:29:53.88	DIAG	Trk_2: No Communications -CLEARED
19-Jul-2017 15:29:53.80	DIAG	Trk_2: Island Stabilizing
19-Jul-2017 15:29:53.76	DIAG	Trk_2: Island Calibration Required
19-Jul-2017 15:29:53.72	DIAG	Trk_2: GCP Stabilizing
19-Jul-2017 15:29:53.68	DIAG	Trk_2: Receiver Error 1
19-Jul-2017 15:29:53.64	DIAG	Trk_2: GCP Linearization Required
19-Jul-2017 15:29:53.60	DIAG	Trk_2: GCP Calibration Required
19-Jul-2017 15:29:53.55	DIAG	Trk_2: GCP Approach Calibration Required
19-Jul-2017 15:29:28.72	DIAG	RIO_1: No Communications -CLEARED
19-Jul-2017 13:37:55.10	DIAG	Trk_1: GCP Stabilizing -CLEARED
19-Jul-2017 13:37:50.16	DIAG	Trk_1: Island Stabilizing -CLEARED
19-Jul-2017 13:37:40.22	DIAG	Trk_1: Track Hardware Error -CLEARED
19-Jul-2017 13:37:40.18	DIAG	Trk_1: Island Stabilizing

Figure 4-104 WebUI: Diagnostic Log

The menu bar allows navigation of the log and downloading is the same as for the Event Log. See the Event Log Section 4.2.5.5 for details.

4.6.5.3 Train History Log

The train history log is not used in the DTC application.

4.6.5.4 OCCN Log

This log shows a history of parameter changes which change the Office Configuration Check Number (OCCN).

4.6.5.5 Maintenance Log

This log shows a history of configuration changes or calibrations performed.

4.6.5.6 SEAR

The SEAR is not used in the DTC application.

4.6.5.7 Reports

The Report tab allows the user to select either the:

- Configuration Report - contains all the information in the other reports.
- Program Report – contains CRCs, System and Site Programming values (not Display programming)
- Min Program Steps – contains a list of all the parameters changed from their default values
- Template Report – not used in DTC application
- Version Report - contains hardware and software version of modules

Configuration Menu will bring up the screen shown in the following figure. Press the **Create** button to create the report.

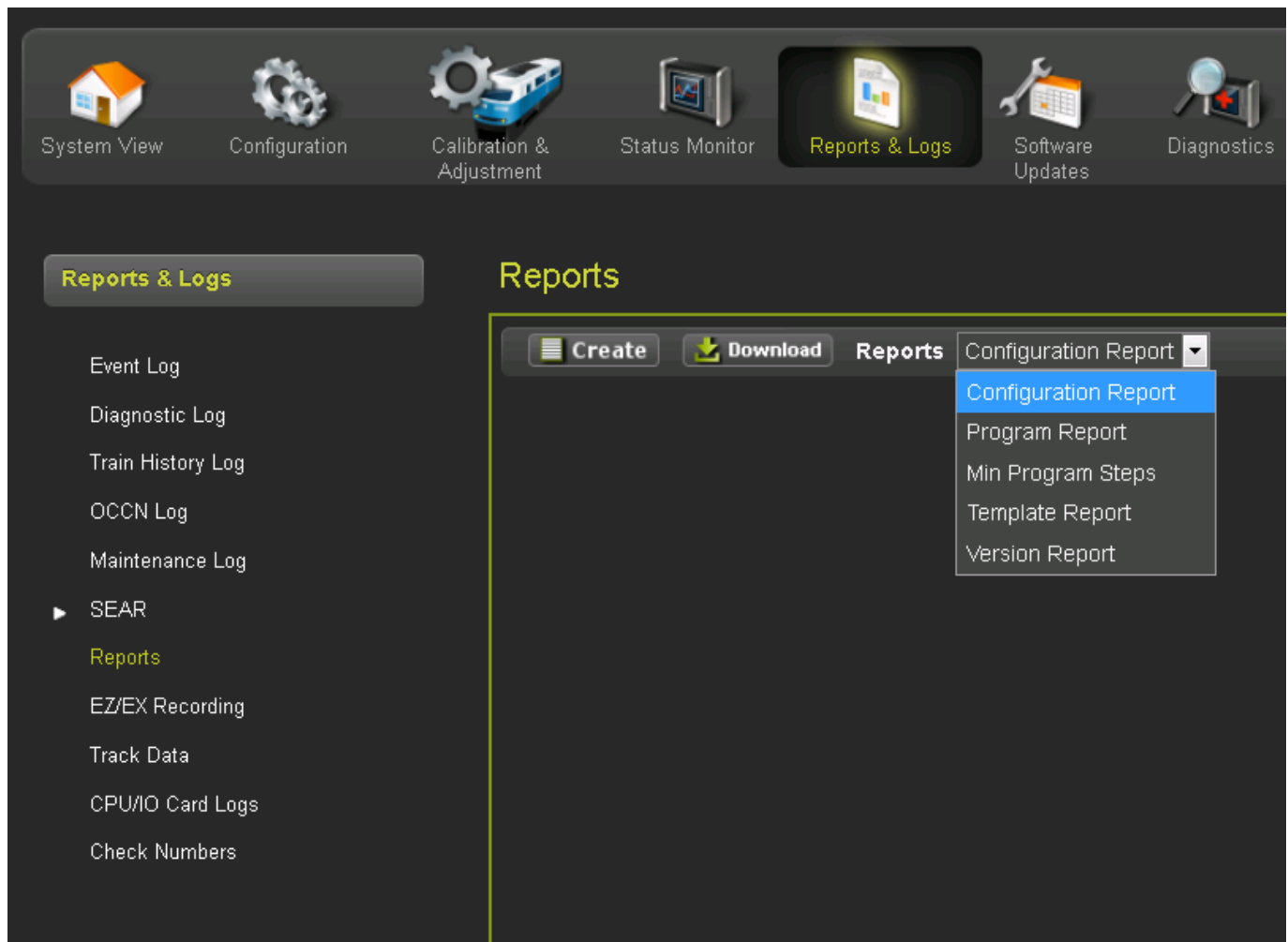

Figure 4-105 WebUI: Configuration Report Progress

After the report has been created, it will show up as illustrated in Figure 4-106. Use the scroll bars to navigate it. Select the download button to save the report to the PC or open it in a separate file.

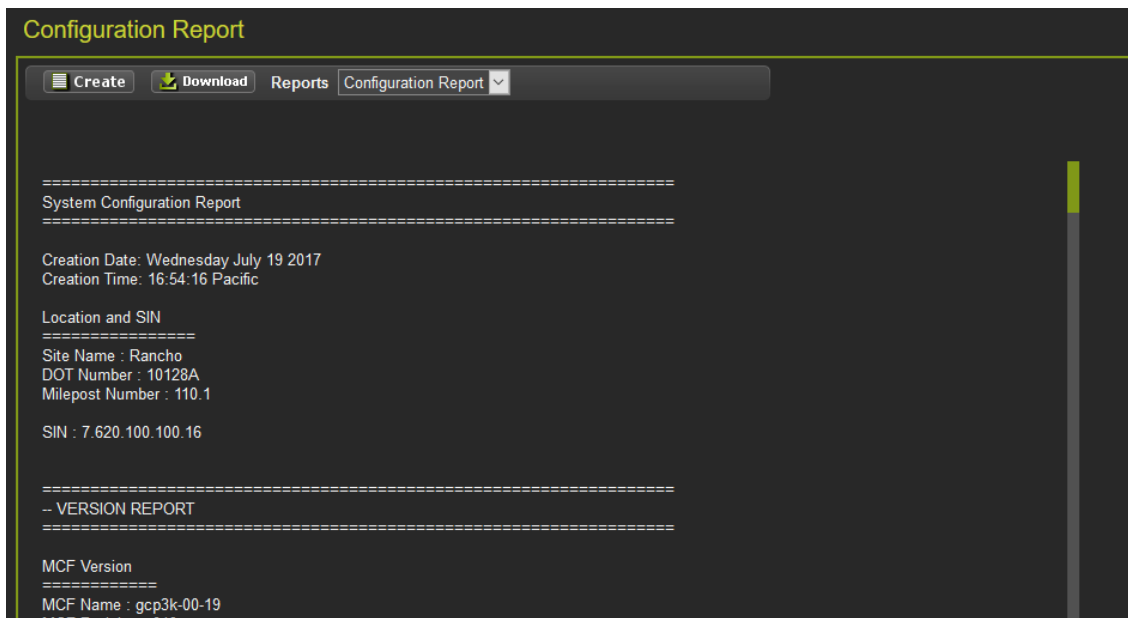

Figure 4-106 WebUI: Configuration Report

NOTE

NOTE

The Configuration Report downloaded from the Display Module does not contain the CP Programming parameters. To obtain these, download the configuration report from the CPU III.

4.6.5.8 EZ/EX Recording

Not used in DTC applications.

4.6.5.9 Track Data

This menu allows detail track status information to be saved and downloaded. If the DTC is used in combination with the Siemens Track Information Monitor application, the track data should be enabled in the Settings menu as shown in Figure 4-107.

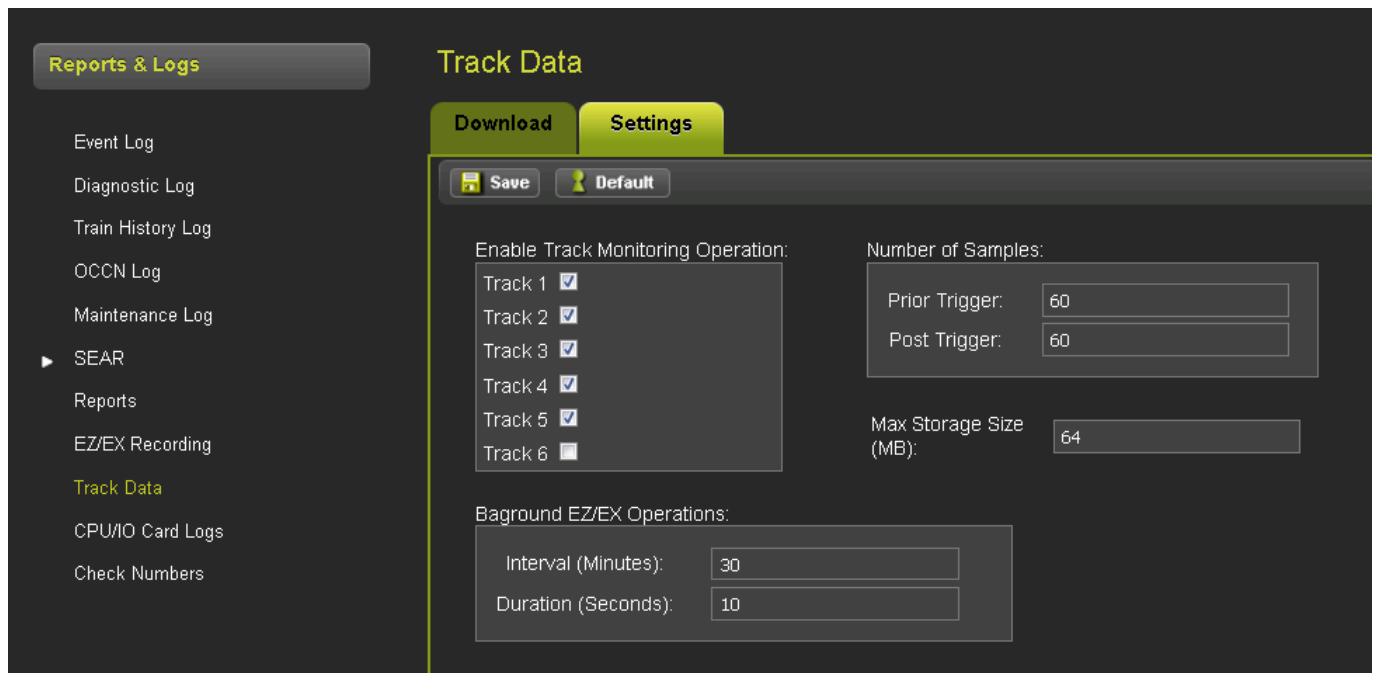

Figure 4-107 WebUI: Track Data Settings

When a DTC is first connected to the STIM application, any existing track data files should be cleared out by selecting all the used tracks in the Select Tracks box, then selecting Delete as shown in Figure 4-108.

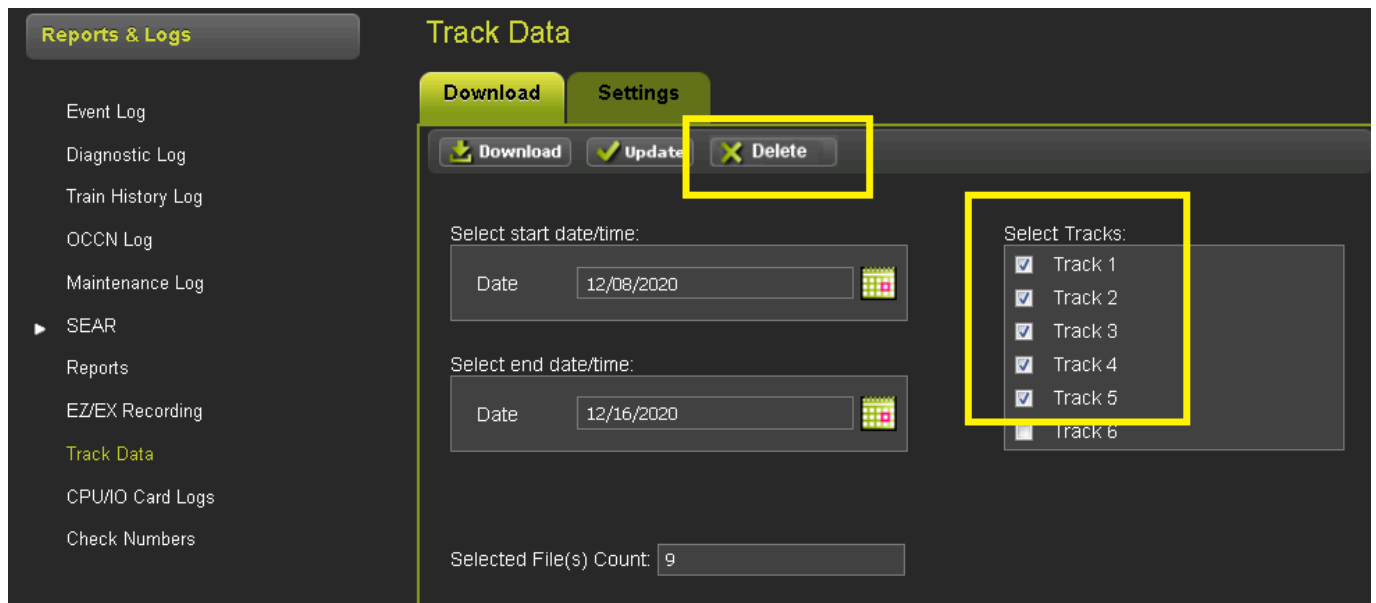

Figure 4-108 WebUI: Track Data Download

4.6.5.10 CPU / IO Card Logs

This allows the logs from the CPU and I/O cards to be accessed. This should not be necessary in the DTC application.

4.6.5.11 Check Numbers

This menu provides an alternative way to see the check number from the System View menu. The check numbers shown here are the same as described in Section 4.6.1.5.

4.6.6 Software Updates

When the software updates icon is selected, the WebUI will show the menu options illustrated in the following figure. The screen will open with the **Configuration** options.

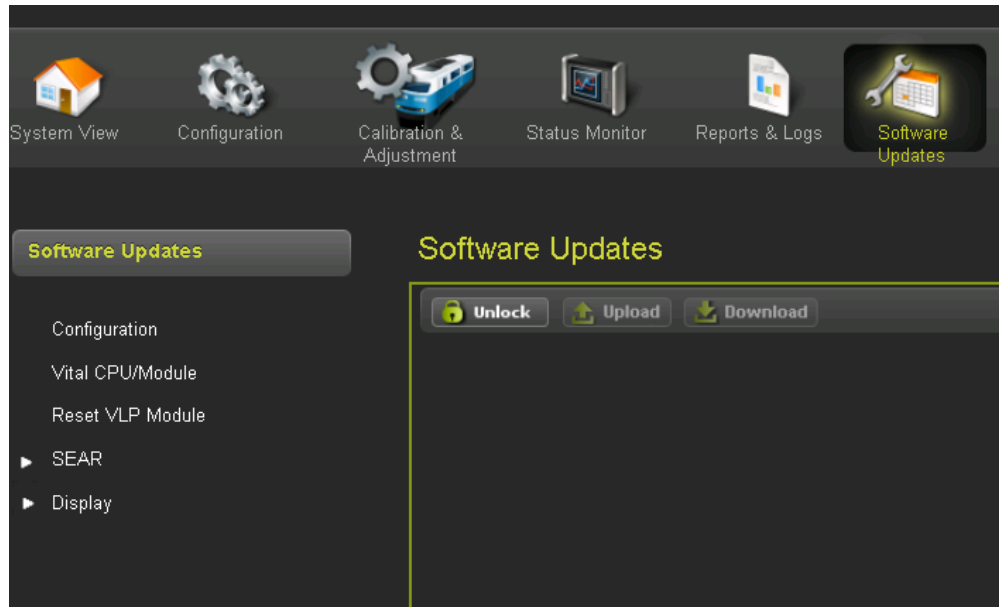

Figure 4-109 WebUI: Software Updates

4.6.6.1 Configuration

This menu is used to download the configuration file (PAC file) from the DTC or to upload a new one. The configuration file is known as the PAC file. The PAC file can be opened offline using the OCE tool (See manual SIG-00-11-15). The PAC file can be used as a back up to the DTC configuration and loaded back into the system using the Upload Configuration step described below.

First, unlock the screen if needed. To download the configuration, select the download button. The WebUI will start to download the file and show the progress as in Figure 4-110 below. Occasionally, the download may fail. If this happens, select the download again.

Once the download is complete, the WebUI will ask to **Save** or open the file (exact format of this depends on browser used). Select to save the file, as the file is in binary format and cannot be opened using standard Windows software. The PAC file name is created from the combination of the DOT number and date - e.g., CONFIG-{DOT number}-PAC-{date}...{time}.

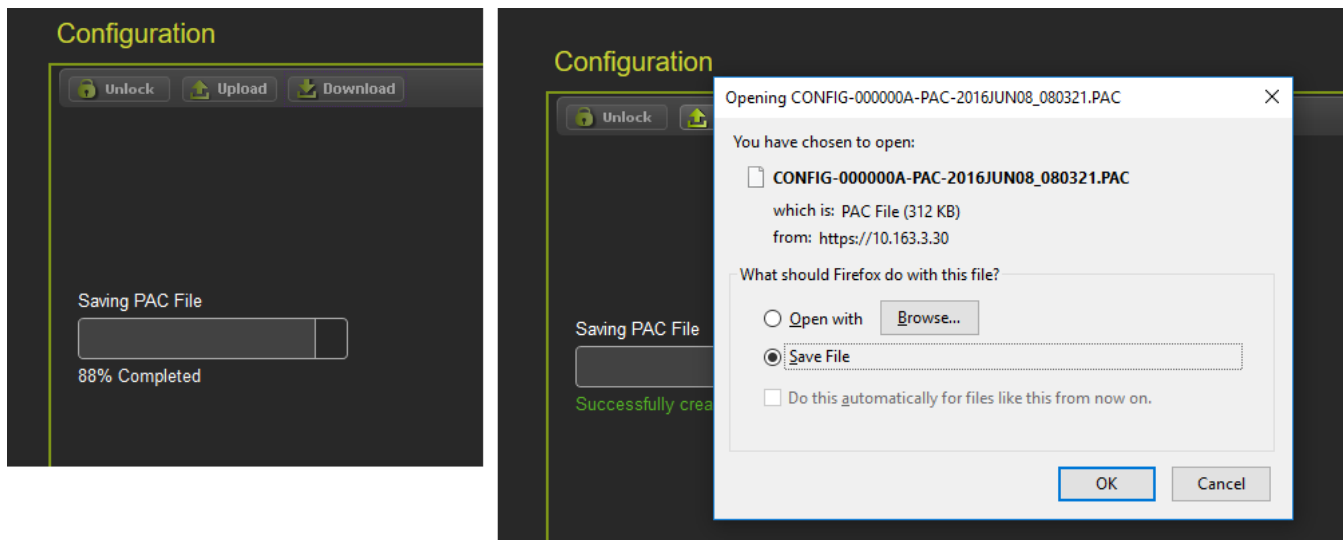

Figure 4-110 WebUI: Configuration Download

To upload a new configuration file, select the **Upload** button. The WebUI will show the warning message illustrated in the figure above on the left. If **Yes** is selected, the WebUI will ask to save the current configuration first. Select the desired option.

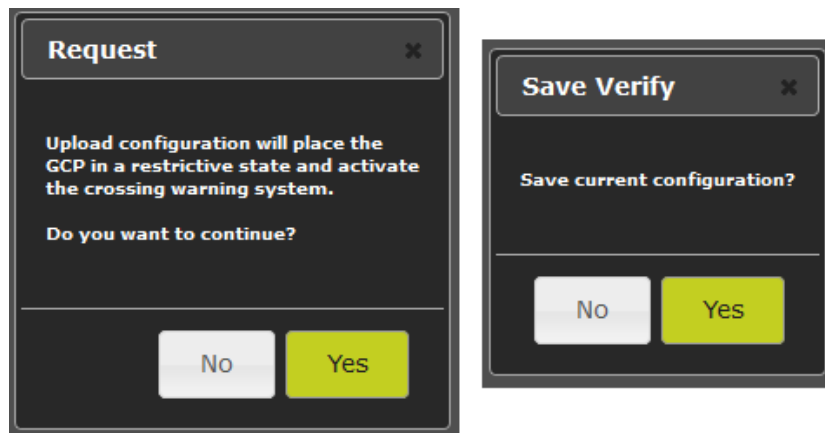

Figure 4-111 WebUI: Configuration Upload Messages



WARNING

UPLOADING A NEW CONFIGURATION WILL PUT THE DTC INTO A RESTRICTIVE STATE WHICH WILL PREVENT IT SENDING THE POSITION AND SPEED OF CARS TO THE ETHERNET.

If **Yes** is selected, the WebUI will download the current configuration as shown in the figure below. If **No** is selected, the message below is shown immediately. Select the configuration file to be loaded.

NOTE

NOTE

The DTC must be running the same MCF that the PAC file was created for. If the PAC file is created for a different MCF, the WebUI will reject the upload.

Once the file has been selected, the WebUI will ask for confirmation.

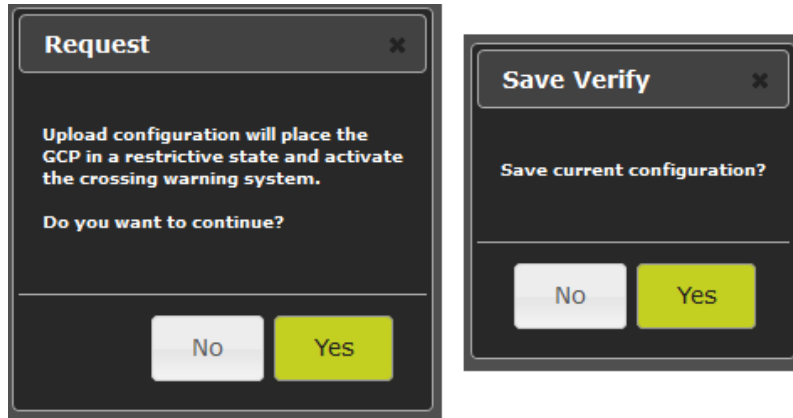

Figure 4-112 WebUI: Configuration Upload File Selection

If the user decides not to continue the upload process, select **No**. At this point, the CPU is in a restrictive state and the crossing will be active. The old configuration has not been lost at this point. To get the CPU back into its previous operational state, reset the VLP module (see Section 4.6.6.3).

If the user wants to continue and load the selected PAC file, press **Yes**. The WebUI will show the progress (Figure 4-113, left) then give the message shown in Figure 4-113 on the right, which gives one final confirmation to continue. At this stage, the user has to prove there is someone in the field at this location by having them press a pushbutton on the CPU module. Once a button has been pressed, select **Yes** to continue. The configuration will now be updated in the CPU and the CPU will reboot; this will cause the display to temporarily lose the session with the CPU.

If the upload is cancelled at the stage above and the user wants to put the CPU back into an operational state, the VLP will need to be rebooted as described previously.



Figure 4-113 WebUI: Configuration Upload Progress and Final Check

4.6.6.2 Vital CPU/Module

NOTE

NOTE
In order to load new software into a track module (A80418), a serial cable with null modem needs to be connected between the serial port on the front of the display and the DIAG port on the module whose software is to be updated.

NOTE

NOTE
In order to load new software into a track module (A80418) from the CPU III, a serial cable needs to be connected between the serial port on the front of the CPU III and the DIAG port on the module whose software is to be updated. To update software on the CPU III itself, an Ethernet cable can be plugged directly into the module itself and the WebUI used, or if the unit is on the network, the IP address of the CPU III can be used to login remotely.

To update the software on the Track module, select the Vital CPU / Module option. To update software on the CPU III, reference Section 4.5.1.1. Unlock the screen as per section 4.6.7 then select the **Install Software** button.

The WebUI will ask the user to confirm that there is a serial cable connected between the display and module to be uploaded. If the cable is connected, press **OK** to continue.



Figure 4-114 WebUI: Module Upload

The display module will then transfer the load setup code to the module to be updated and provide a menu of options.

See Section 4.2.5.3 for full instructions on loading module software.

See Sections 4.5.1.3 and 4.5.1.5 for uploading software via the WebUI onto the CPU III.

4.6.6.3 Reset VLP Module

This menu is used to reset the VLP module. This may be necessary if an attempt has been made to load a new configuration as described in section 4.6.2 and the process cancelled before complete. Unlock the screen as described in section 4.6.7, then press the **Reset VLP** button and the WebUI will ask for confirmation first.

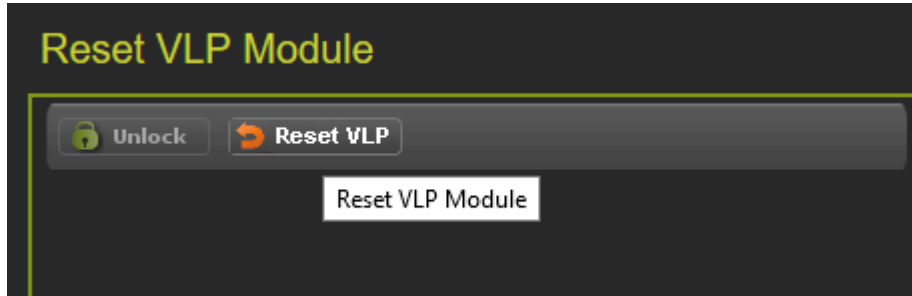

Figure 4-115 WebUI: Reset VLP

4.6.6.4 Display

To update the software on the display, select the Display / Executive option, use the browse button to select the correct .tgz file for the display, then press **Upload**.

NOTE

NOTE

This menu is only available on the Display module and will not appear when the WebUI is used with the CPU III.

The Display executive can be recognized as it will have a name of the format ng5k_mef_x.y.z.zr.tgz.

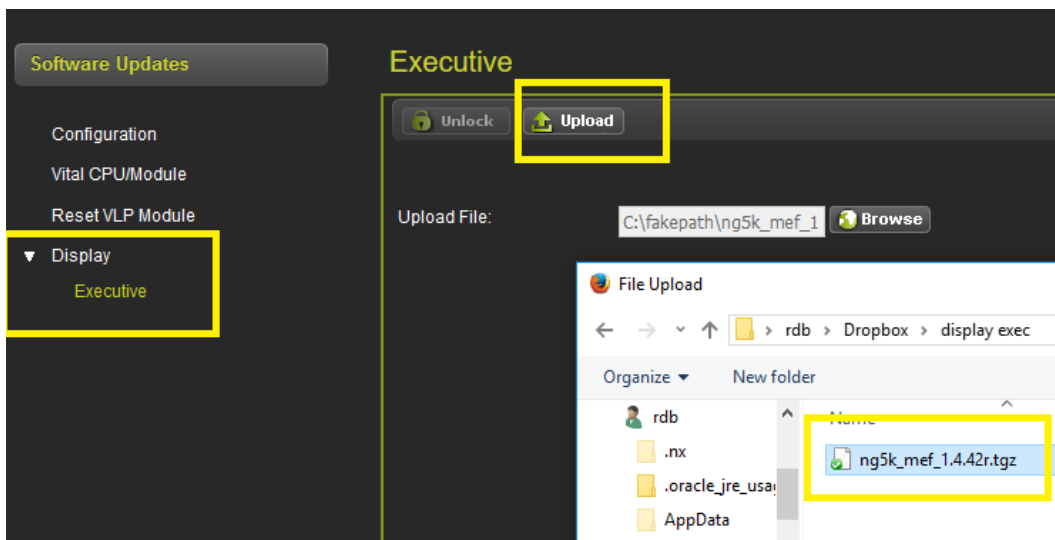

Figure 4-116 WebUI: Reset Upload Display Executive



CAUTION

ENSURE THAT THE FILE SELECTED IS ACTUALLY FOR THE DISPLAY (NAME HAS FORMAT ng5k_mef_x.y.zzr.tgz).
LOADING THE TGZ FILE FOR A DIFFERENT PRODUCT MAY CAUSE THE DISPLAY TO GET LOCKED UP.

4.6.7 Local User Presence

Since the WebUI may be used to connect to the DTC remotely, it is necessary to confirm that someone is present at the location before certain operations such as changing GCP programming or re-calibration can be performed.



NOTE

When using the CPU III, WebUI calibration can be performed without the need to confirm local user presence.

To enable the GCP programming or Calibration, first unlock the screen from the WebUI by pressing the **Unlock** button.

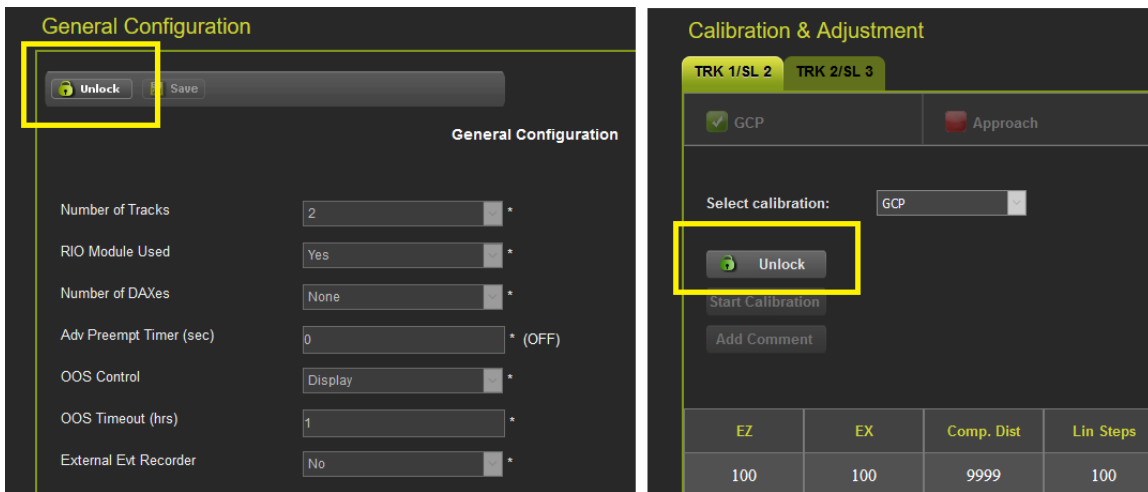

Figure 4-117 WebUI: Unlock

The WebUI will show the message below on the left, asking for confirmation to continue. Select **OK** and the WebUI will show the message below on the right.

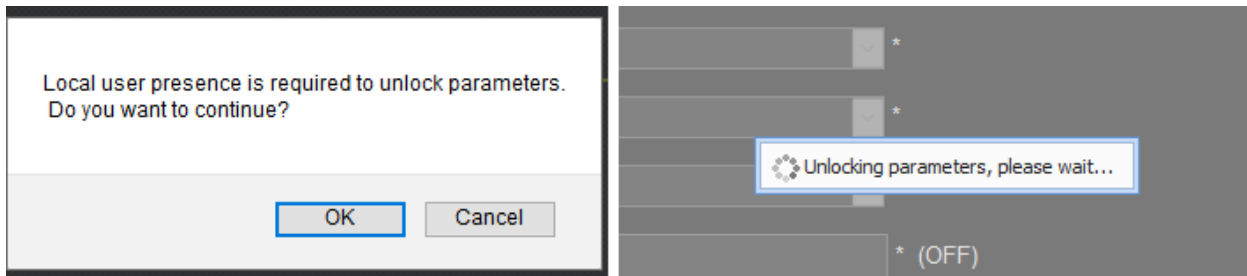

Figure 4-118 WebUI: Confirm Local User Presence

At this point, the display module will show the message in the following figure to the user in the field. The user in the field will press **Enter** to confirm that the remote user may continue, or the local user may deny the remote user editing access by pressing the back key.

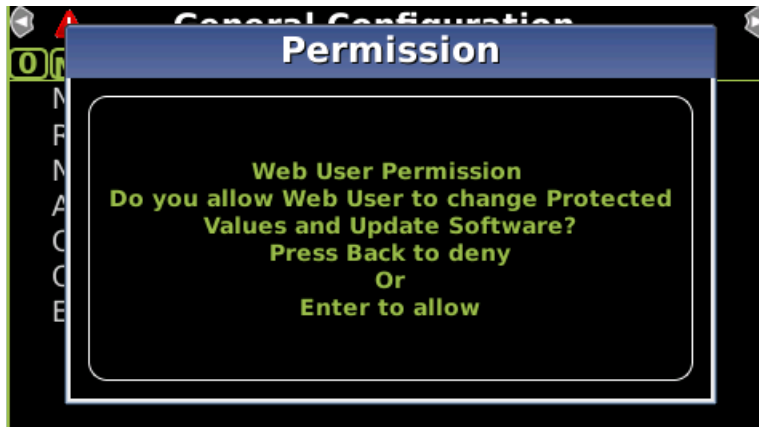

Figure 4-119 Display: Confirm Local User Presence

If the local user denies access to the remote user, the WebUI will show the **Failed** message in the figure below on the left. If there is no confirmation by the local user, the WebUI will show the timeout message in the figure below on the right.

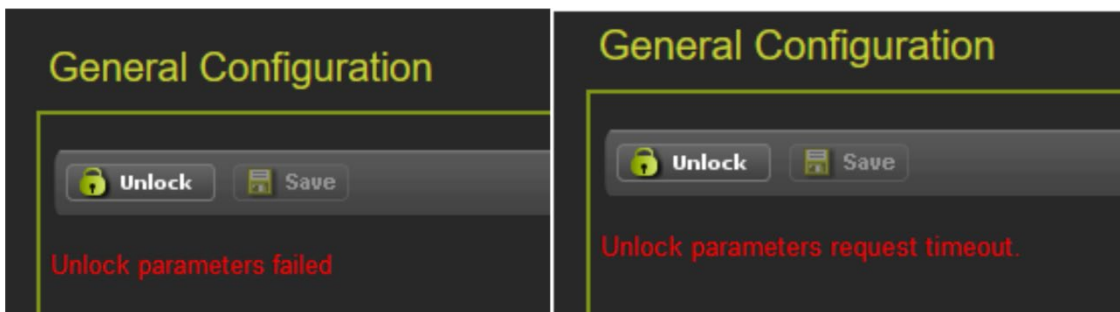

Figure 4-120 WebUI Local User Presence Error Messages

The local user can check when a remote user still has editing permissions, as the program and calibration screens will show the blue user icon as shown in the yellow box below.

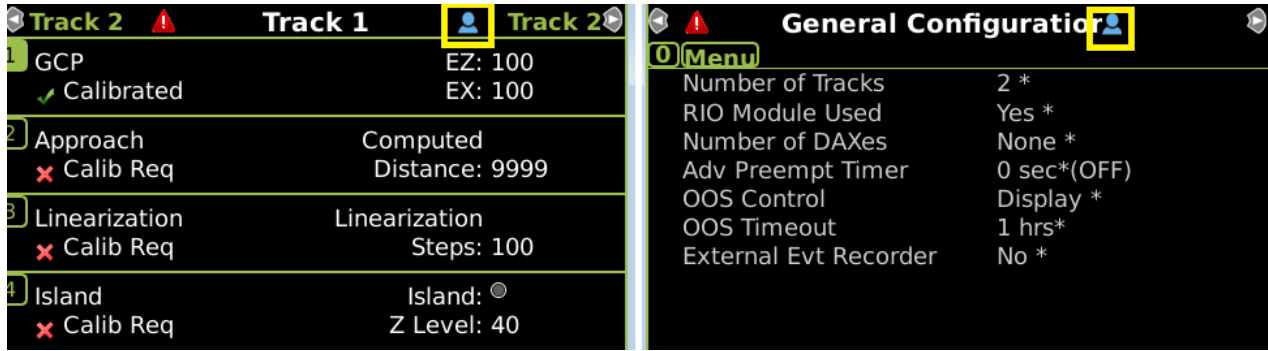

Figure 4-121 Display Local User Presence Indicator

4.6.8 WebUI Display / CPU Connecting

If the Display module is not in session with the CPU, it will be indicated with just a red exclamation point as illustrated in the top pane below. During the connection process, the display will show the icon in the second pane below (boxed in yellow). The last pane indicates Creating Real Time Database.

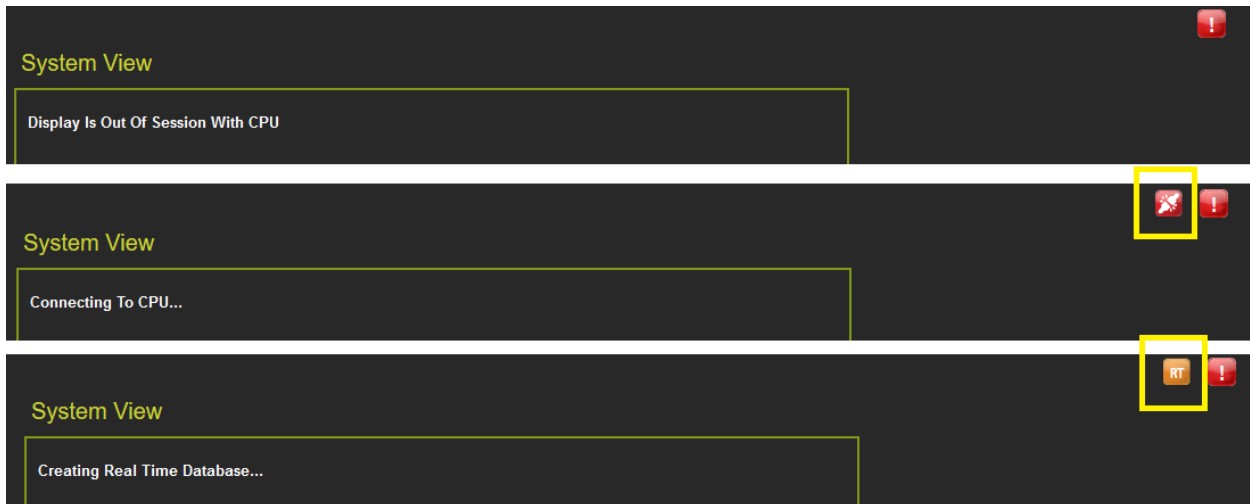

Figure 4-122 Display Module Not in Session

When this is complete, the display will show the Diagnostics screen (if Diagnostic messages are present) or it will show the System View.

If the VLP is in the unconfigured state, for example, the user has started the upload configuration process, but not gone through the final step of rebooting the VLP, then the WebUI System View will show an indication of this at the bottom of the screen as shown below.

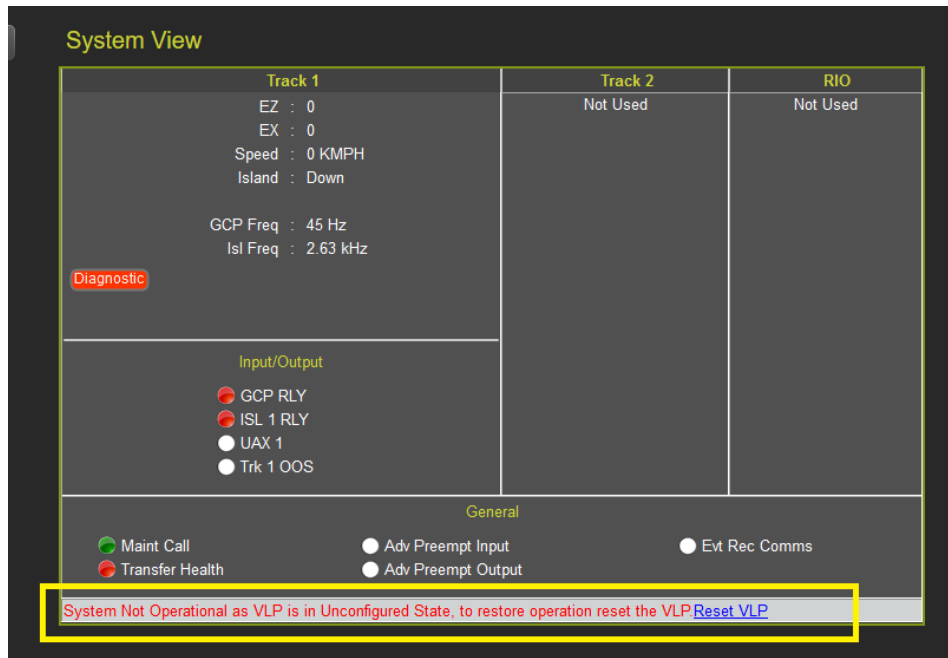

Figure 4-123 WebUI when VLP Unconfigured

If the system is in an unconfigured state for a different reason, for example, the MCF CRC is incorrect, the System View will show the message in the following figure:

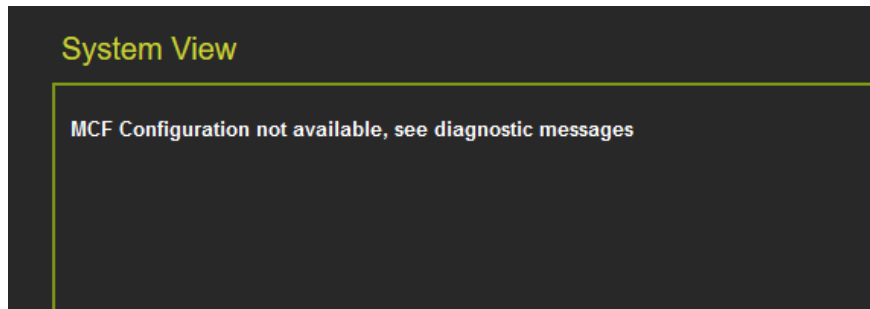

Figure 4-124 WebUI System View when VLP Unconfigured due to MCF CRC Error

At this point, check the diagnostic messages to see what the problem is. Examples are shown in Figure 4-125.

Slot	Description	Code
Trk 1	No Communications	1017
VLP2	MCF CRC incorrect	3004
VLP2	VLP Unconfigured	3018
SEAR	Incompatible SEAR / MCF Combination	6002

Details	
Cause	Remedy

Figure 4-125 WebUI System Diagnostics when VLP is Unconfigured due to MCF CRC Error

4.6.9 Using the Display on a Network

If the equipment is to be connected to a network, it will be necessary for the user to set the Ethernet port as a Client. Failure to do so will cause an interruption of the network since two DHCP servers will be introduced onto the network. In the client mode, the network will assign an IP address to the Display.

To find the assigned IP Address:

- go to the Display module Program View and select the Display Settings.
- select the Laptop Ethernet Port option.
- select the Status tab.
- record the IP address (this is the Ethernet address that has been assigned to the display by the network).

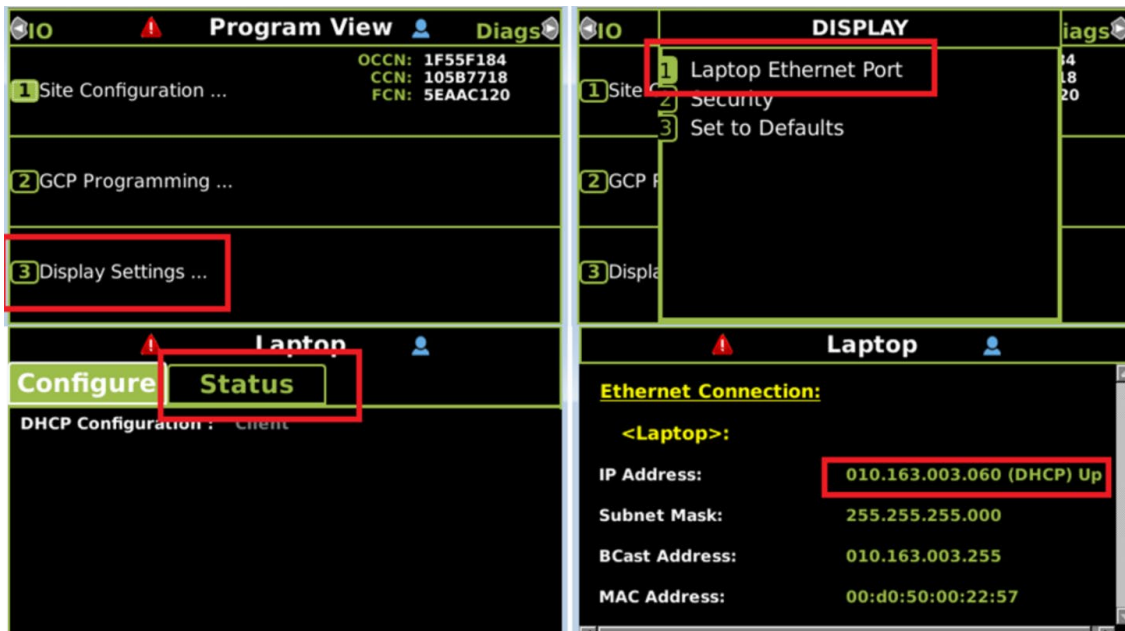

Figure 4-126 Finding IP Client Address

Enter the IP address shown on the display on your web browser to connect to the Display. When connecting to a network, a notice that the connection is not secure may appear as shown in Figure 4-84. Click on the **Advanced** button and a new screen will pop up. Click on the **Add Exception** button to bring up another screen. Click on the **Confirm Security Exception** which will allow the connection to continue. Checking the **Permanently Store This Exception** box will remember this setting.

Once the password has been entered, the WebUI will open with the System View screen, provided there are no Diagnostic messages present in the system. In the event there are Diagnostic messages present, the Diagnostic page will appear instead of the System View. (See Section 4.6.1.4 for Diagnostic Screen details).

4.6.10 Using the CPU III on a Network

In a DTC application the CPU III laptop port is used to connect the DTC to the Yard control system. Thus it will need to be configured with a specific IP address rather than being used in its default mode as a DHCP server.



CAUTION

THE DHCP SERVER SETTING ON THE CPU III LAPTOP PORT MUST BE DISABLED BEFORE CONNECTING TO A NETWORK.
FAILURE TO DO THIS MAY RESULT IN NETWORK DISRUPTION.

For details on how to change this, see section 5.5.1.

4.6.11 WebUI Menus Available on CPU III While Display Also in Session

If a user connects to the CPU III via the WebUI while the Display is in session, some features in the CPU III WebUI are disabled. Use the Display Web or Local User interfaces if changes are required:

- The Configuration / Site Information cannot be edited from the CPU III WebUI.
- The Software Update / Configuration screen will not allow a new PAC file to be uploaded.

SECTION 5 PROGRAMMING

5.0 GENERAL

5.1 PROGRAMMING DETAILS

The figures used to illustrate the DTC programming in this section will be taken from the local user interface of the display. The WebUI will show equivalent screens. This section will focus on the programming parameters themselves, rather than how to use the keypad and display or WebUI, see Section 4.0 for instructions on using these.

NOTE

NOTE

Refer to the Railroad Installation Drawing or the Installation Plans for the exact parameters to be entered when programming the DTC.

The DTC programming on the WebUI and Local appears as show in Figure 5-1.

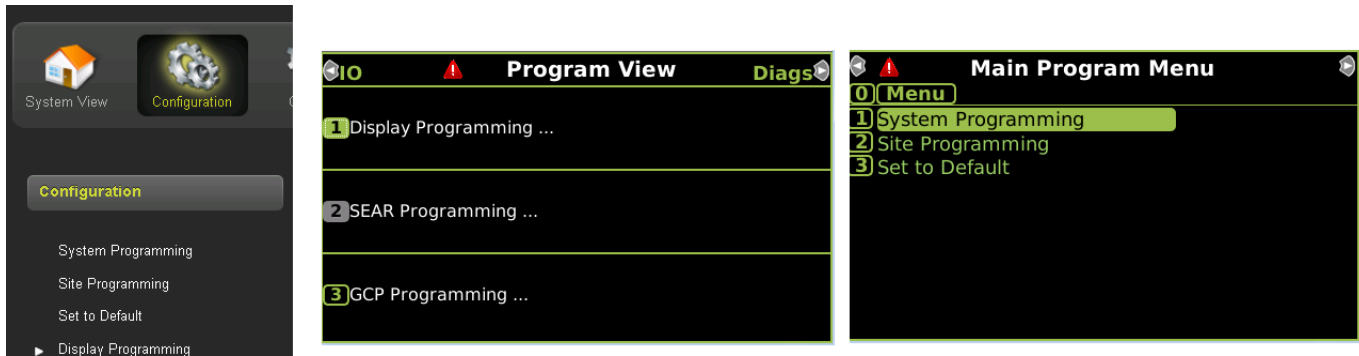

Figure 5-1 DTC Configuration

The GCP Programming menu on the Local UI corresponds has sub menus which include System Programming, Site Programming and Set to Default as seen on the WebUI. The SEAR Programming is not used in the DTC.

5.2 SYSTEM PROGRAMMING

The system programming screen allows the user to select which tracks are used in the DTC. This menu is common to both the Display and the CP WebUI.

Default is all slots have a track card.

The screen also allows the user to configure the message update rate of the status messages sent from the DTC to yard control equipment over the Ethernet. Range 1-10 seconds, Default 1 second.

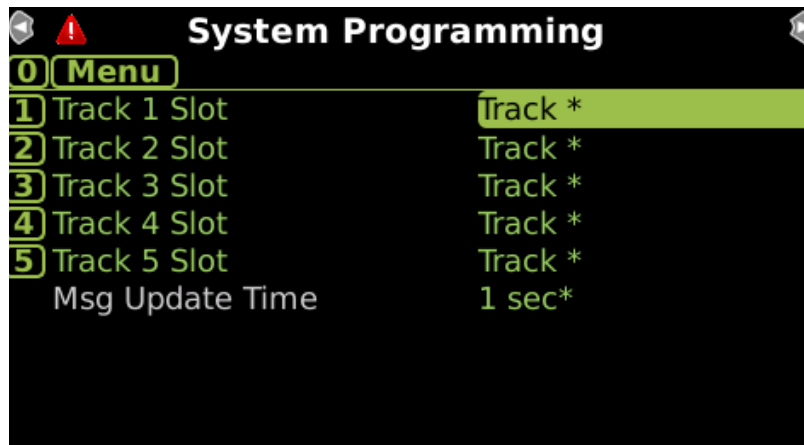

Figure 5-2 System Programming Menu

After the System programming, there are menus that allow the configuration parameters for each track to be programmed. On the Local UI, these take two screens appear as shown in Figure 5-3.

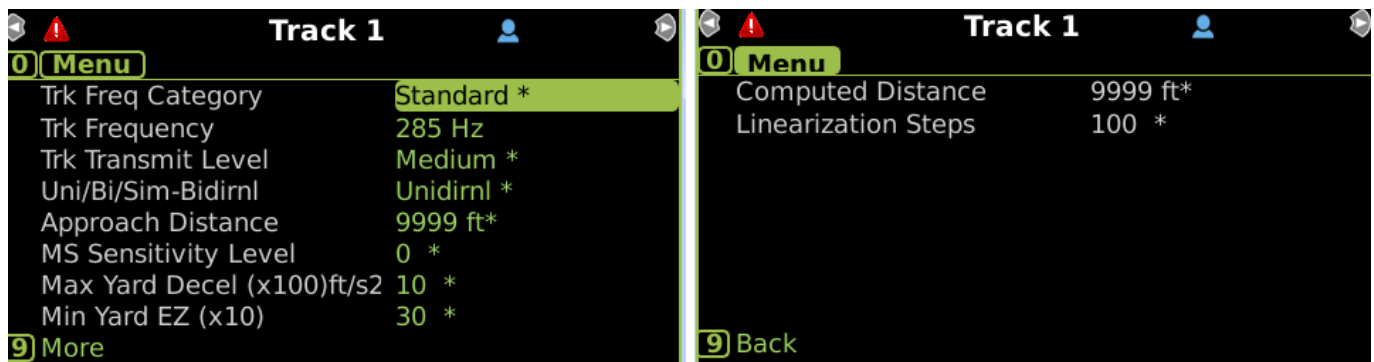

Figure 5-3 Track 1 Programming Menu

On the WebUI, the system programming appears as shown in Figure 5-4.

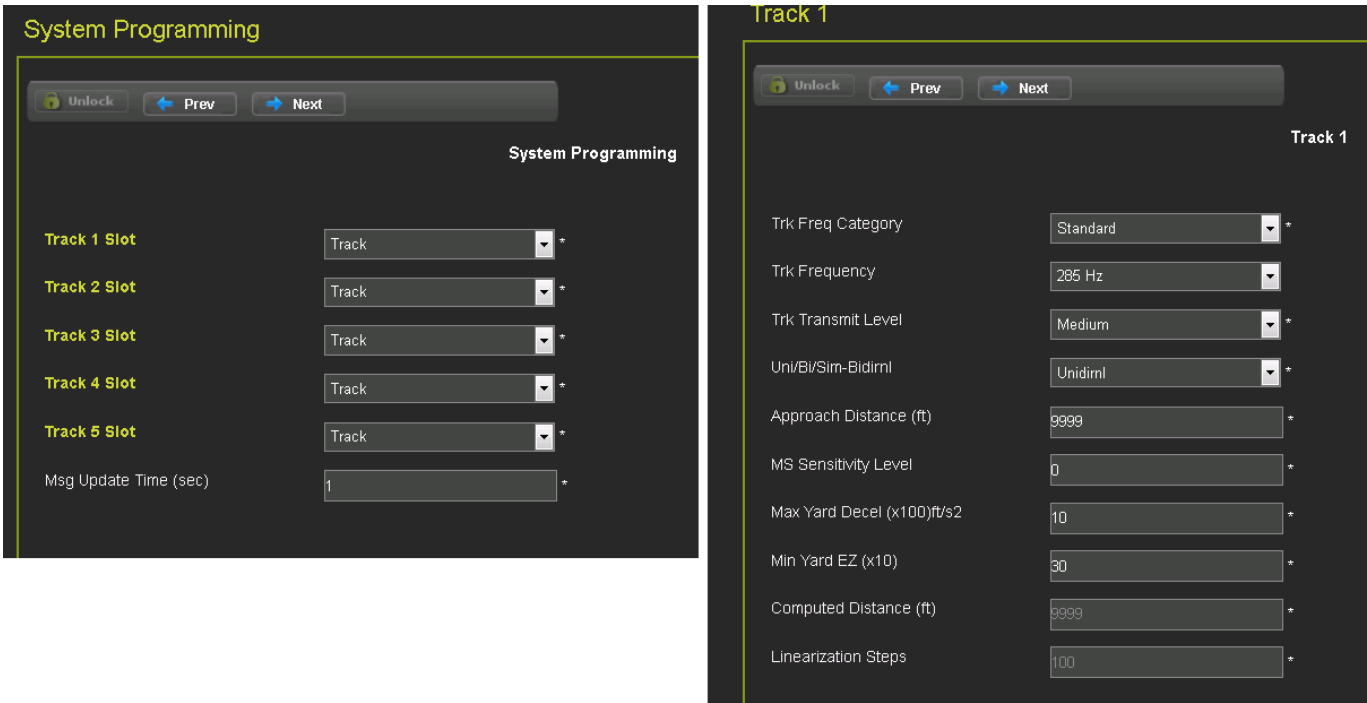

Figure 5-4 WebUI System and Track 1 Programming Menu

Table 5-1 Track Parameters

Parameter	Values	Default	Description
Trk Freq Category	Standard, Offset, Other	Standard	Used to select range of track frequencies
Trk Frequency	See Table 5-2	Not Set	Used to set the transmit frequency
Trk Transmit Level	Medium, High	Medium	Track transmit level
Uni/Bi/Sim_Bidir1	UniDirnl, Sim. Bidirnl	UniDirnl	Sim. Bidirnl can be used to extend distance a specific transmit frequency can be used for, this requires use of a dummy load at the track connections.
Approach Distance (ft)	1 .. 9999	9999	Distance from track wires to hard wire shunt
MS Sensitivity level	0 .. 100	0	Used to control motion sensitivity. Leave at 0 unless instructed by Siemens
Max Yard Decel (x100) ft/s ²	5 .. 50	10	Used in algorithm to calculate smoothed speed. A measure of maximum deceleration allowed from one reading to the next Leave at 10 unless instructed by Siemens
Min Yard EZ (x10)	10 .. 100	30	Used in algorithm to calculate smoothed speed. EZ value at which DTC starts to calculate smoothed speed. Leave at 30 unless instructed by Siemens
Computed Distance (ft)	1 .. 9999	9999	Value calculated for track length when approach calibration is performed. This is read only on this screen. It can be modified from Calibration Screens.
Linearization Steps	68 .. 132	100	Linearization value calculated when linearization calibration is performed. This is read only on this screen. It can be modified from Calibration Screens.

Table 5-2 Track Transmit Frequencies

Standard Frequencies	Offset Frequencies	Other Frequencies
86, 114, 156, 211, 285, 348, 430, 525, 645, 790, 970	85.5, 86.5, 87, 113, 113.5, 14.5, 115, 155, 155.5, 157, 210, 212, 284, 286, 347, 349, 429, 431, 523, 527, 643, 647, 788, 792, 968, 972	44, 45, 46, 141, 149, 151, 237, 239, 249, 250, 267, 326, 392, 452, 522, 560, 630, 686, 753, 816, 881, 979, 999

5.3 SITE PROGRAMMING

This menu is used to set non-vital information, such as the location information and ATCS address (also known as the SIN – Site Information Number).

This menu is common to both the Display and the CP WebUI.



Figure 5-5 Site Programming Menu

5.3.1 ATCS Address

Selecting [1] ATCS Site ID displays the following menu. Enter the unique ATCS address for the DTC in this menu. Each DTC must have a unique address so that the Yard control system knows which DTC the messages are coming from.

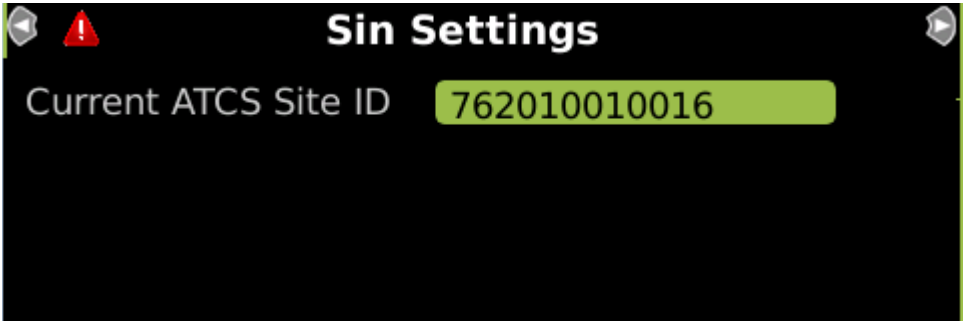

Figure 5-6 Sin Settings

ATCS Site ID:

The ATCS Address of the DTC has the format 7.RRR.LLL.GGG.SS

The ATCS Address is used if the DTC is used to communicate with the Yard control system.

Set the RRR using the ATCS – Railroad parameter, range 0-999, default 620

Set the LLL using the ATCS – Line parameter, range 0-999, default 100

Set the GGG using the ATCS – Group parameter, range 0-999, default 100

Set the SS each DTC to have a unique SS, range 3-90, default 16

5.3.2 Time

Selecting [2] Time will bring up the following menu, enter the current date, time, and time zone.

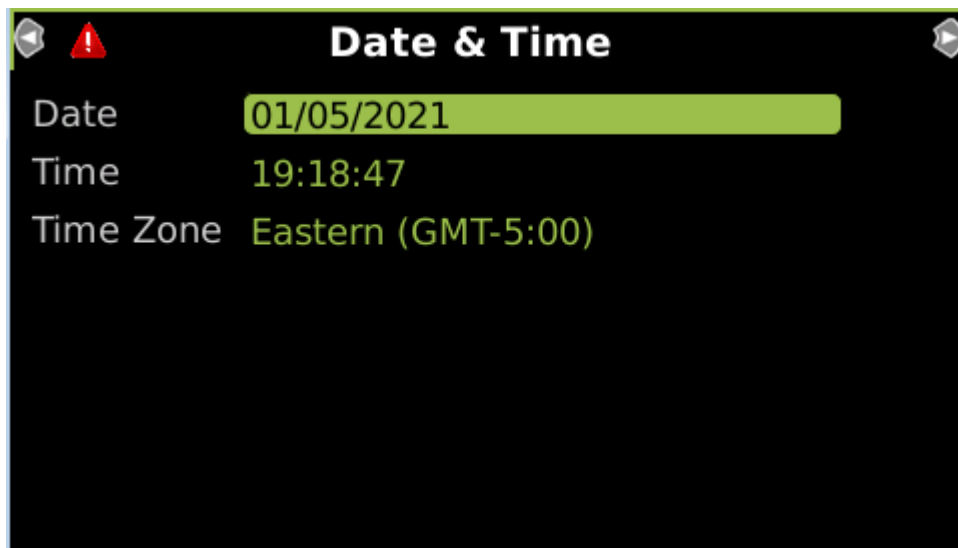

Figure 5-7 Time Menu

5.3.3 Location

As the DTC is not used at crossings, the DOT can be left at default. Fill in the Milepost Number if it is applicable. The Site Name can be entered to identify the DTC equipment.

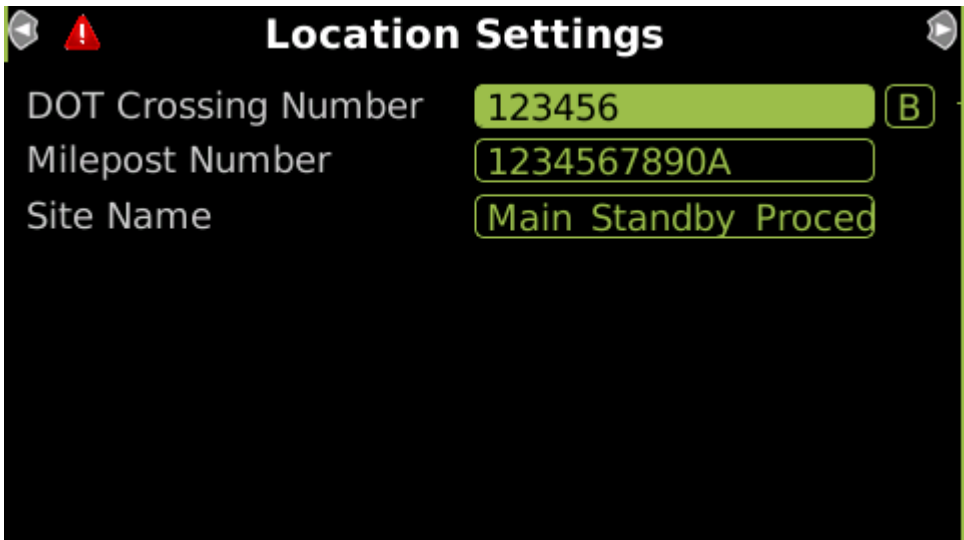

Figure 5-8 Location Settings Menu

Site Name: 0-25 characters

DOT Number: Department of Transportation (DOT) Number, if required, 0-7 characters

Milepost: 0-11 characters

5.4 DISPLAY PROGRAMMING

This menu is used to set non-vital parameters used by the display. This menu is not present on the CPU WebUI.

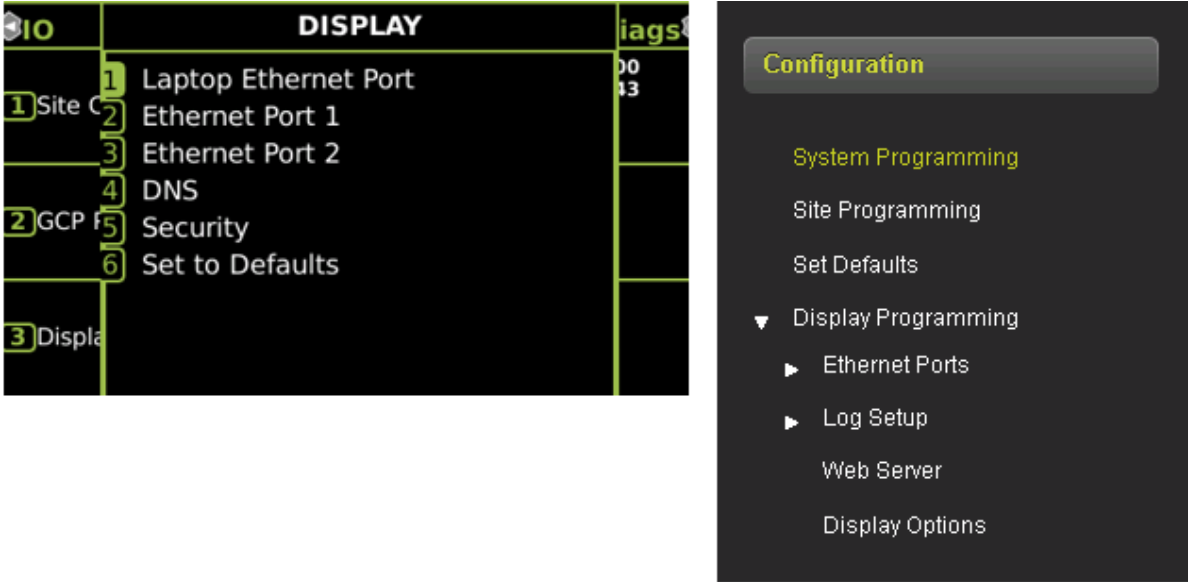

Figure 5-9 Display Configuration Menu, Local UI (Left), Web IU (Right)

5.4.1 Laptop Ethernet Port

This menu allows the user to select between Disabled, DHCP Server or DHCP Client mode. The default setting is as a DHCP Server with IP Address 192.168.255.81. This screen also allows the user to check the status of the connection.

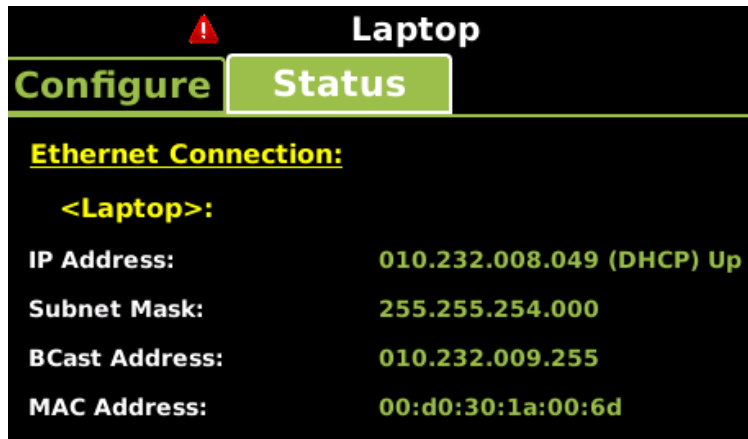

Figure 5-10 Laptop Ethernet Port Status

5.4.2 Ethernet Port 1

This menu allows the user to select options for Ethernet Port 1. The user can choose between Disabled and DHCP Client mode. When Disabled, the port has the fixed IP address as default, as shown in the following figure. This screen also allows the user to check the status of the connection.

NOTE

NOTE

For Ethernet Ports 1 and 2, use the appropriate RJ45 connections on the Display Module.

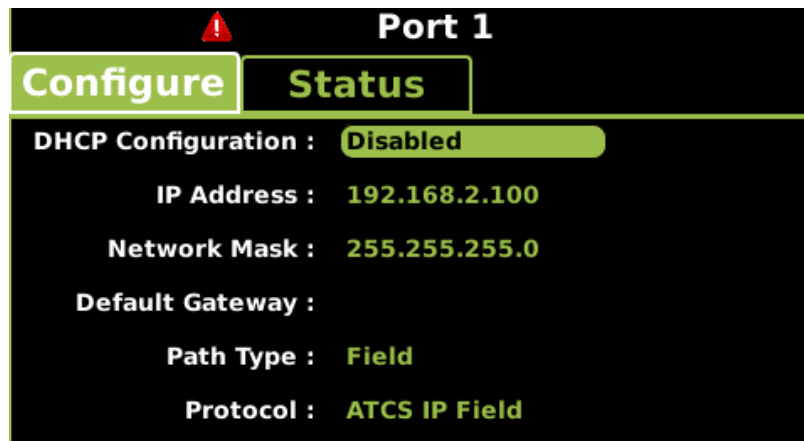

Figure 5-11 Port 1 Ethernet Port Status

5.4.3 Ethernet Port 2

This menu allows the user to select options for Ethernet Port 2. The user can choose between Disabled and DHCP Client mode. When Disabled, the port has the fixed IP address as default, as shown in the previous figure for Ethernet Port 1. This screen also allows the user to check the status of the connection.

5.4.4 DNS

The DNS menu allows the user to provide a DNS address for the server.

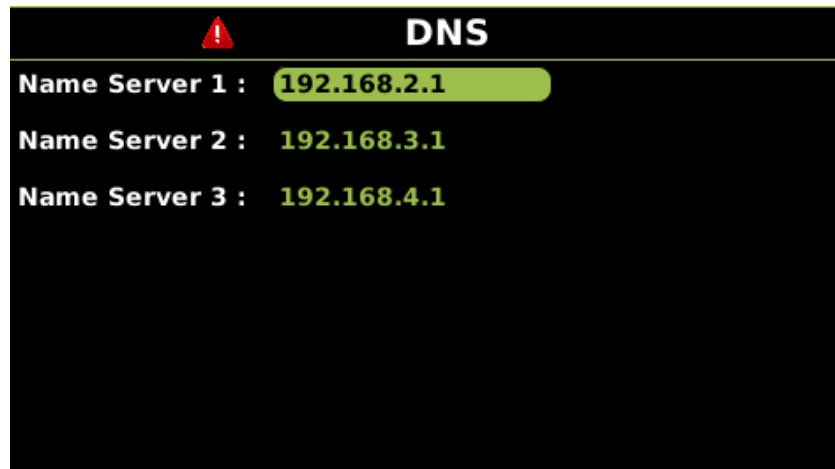

Figure 5-12 DNS

5.4.5 Security

The security page allows the user to enable or disable the Maintainer password protection using the **Security Enabled** field. This defaults to **None**. When the **Security Enabled** is set to Maintainer, the Maintainer Password field appears, and the user can type in the required password.

On returning to this screen, the password cannot be edited unless the correct password is entered. See Section 4.6 for details.

If security has been enabled, the user will need to enter this password on the local user interface in order to be able to edit DTC MCF parameters. Also, the user will need to log into the WebUI with this password in order to be able to edit DTC MCF parameters. The user can still log into the WebUI using the default GCP4000 password, but the configuration will be read only.

Session Inactivity Timeout can be set to between 5 to 60 minutes, the default is 20 minutes. This is used to timeout the WebUI if there is no activity on the GCP for the configured time.

NOTE

NOTE

If a maintainer or supervisor password is enabled and the password has been forgotten, contact Siemens for a temporary password.

5.4.6 Set to Defaults.

This menu is used to set the Display parameters back to defaults. The parameters under GCP Programming are unaffected.



Figure 5-13 Display Security Menu

The Display Configuration Menus are also available under the Display Settings tab on the WebUI as show in Figure 5-14. The WebUI allows the user to configure the ATCS router settings, these are not used in DTC applications

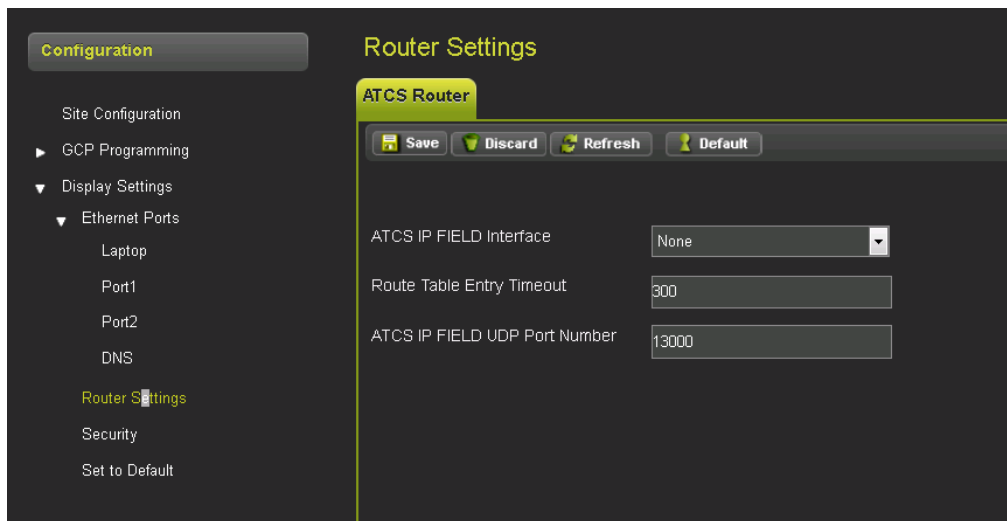

Figure 5-14 Display Options on WebUI

5.5 CP PROGRAMMING

This menu is only present on the CPU III WebUI.

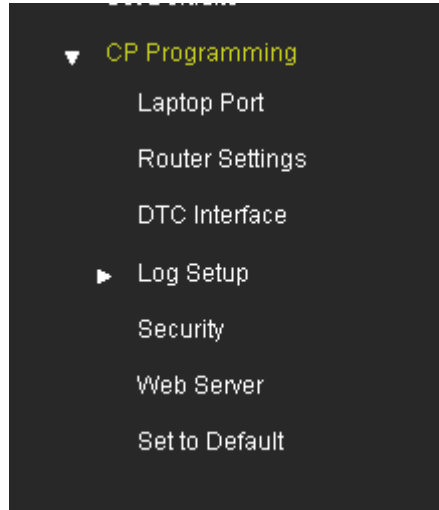

Figure 5-15 CP Configuration Menu, WebUI

5.5.1 Laptop Ethernet Port

This menu allows the user to select between Disabled, DHCP Server, or DHCP Client mode. The default setting is as a DHCP Server with IP Address 192.168.255.81. This screen also allows the user to check the status of the connection.

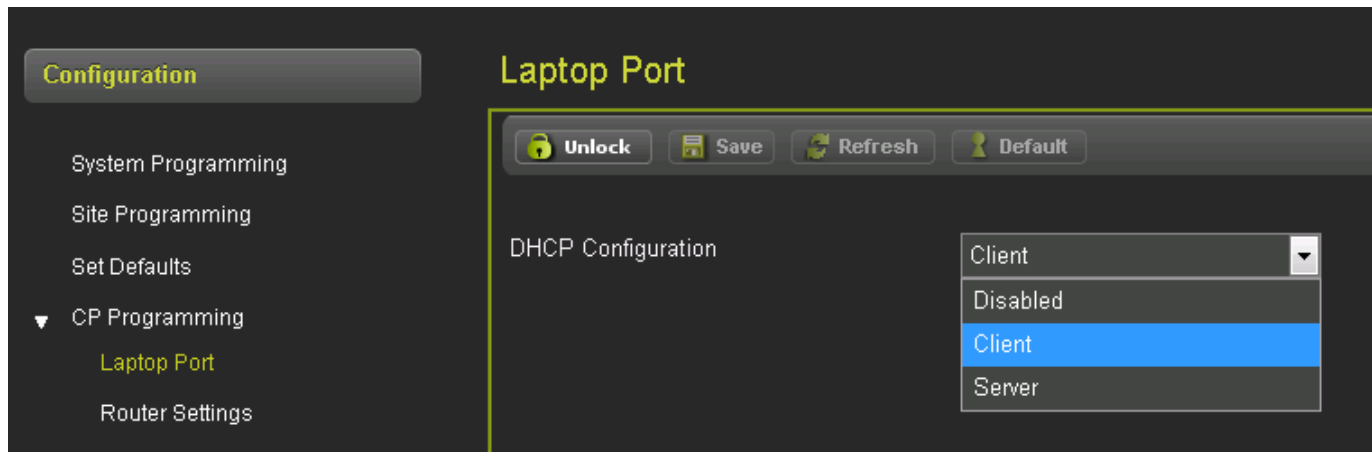

Figure 5-16 Laptop Ethernet Port Status

In DTC applications the CPU III laptop port is used to connect the DTC to the Yard control system. Thus it will need to be configured with a specific IP address rather than being used in its default mode as a DHCP server.

CAUTION

CAUTION

THE DHCP SERVER SETTING ON THE CPU III LAPTOP PORT MUST BE DISABLED BEFORE CONNECTING TO A NETWORK.

FAILURE TO DO THIS MAY RESULT IN NETWORK DISRUPTION.

To do this select the Disabled option and enter the required IP address as shown in Figure 5-17. Note that the IP address shown below is an example only.

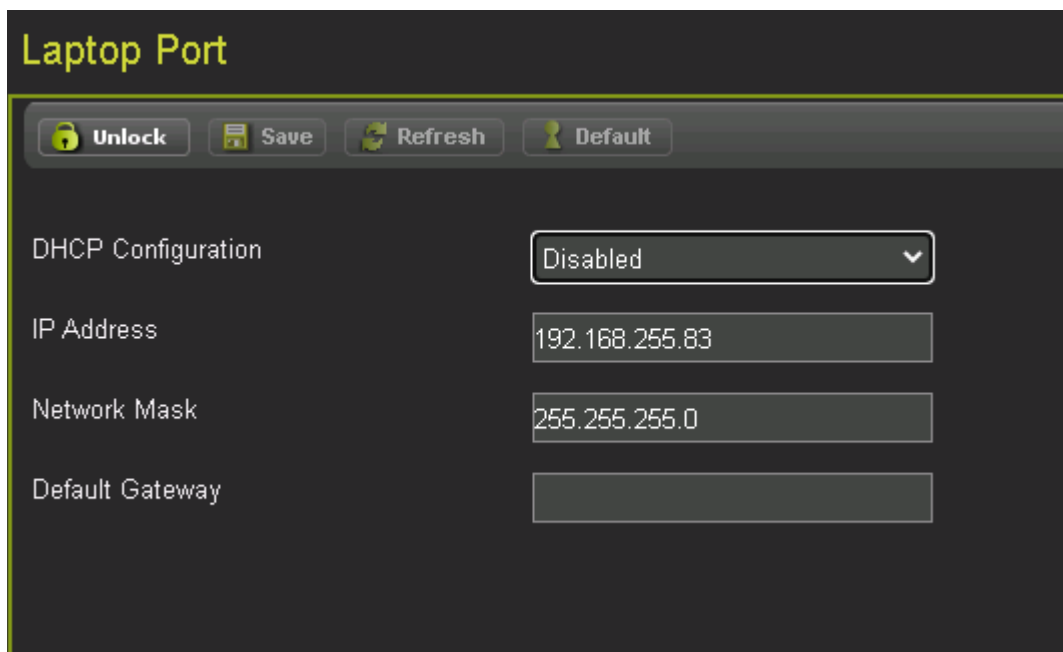

Figure 5-17 Laptop Ethernet Port IP settings

The Status of the ethernet can be seen under the Status message.

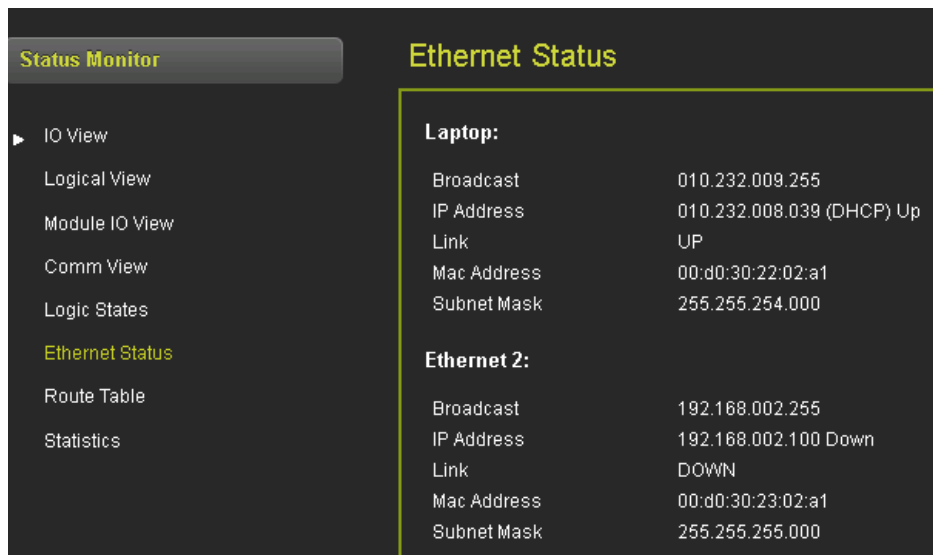

Figure 5-18 Ethernet Port Status

5.5.2 Router Settings

Router settings are not used in DTC applications.

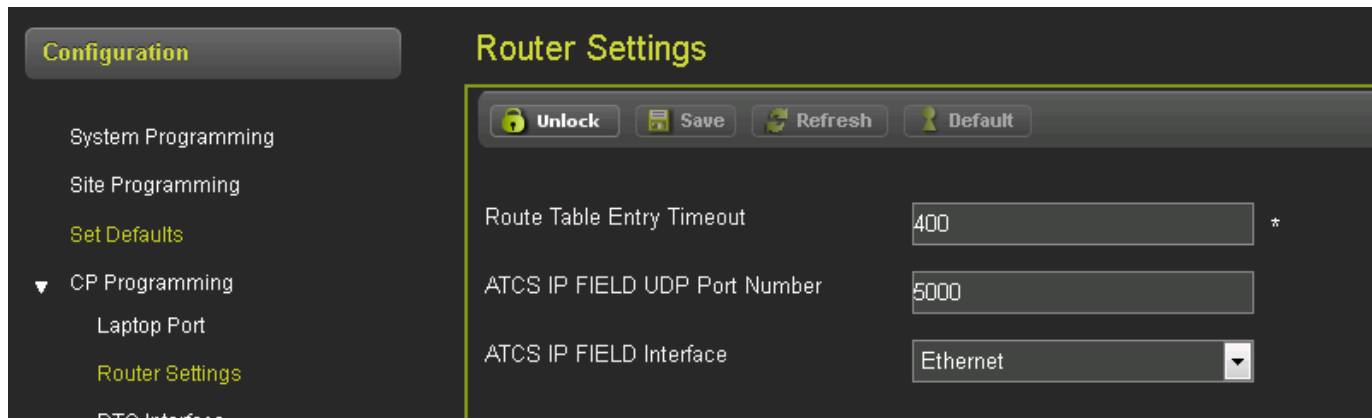

Figure 5-19 Router Settings

5.5.3 DTC Interface

For DTC applications, this screen is used to set the IP address and port of the Yard control system. The user can select to send messages to a backup yard control system. To do this, enable the Secondary Address and enter the IP Address and Port Number of the secondary system.

Note that both main and secondary IP addresses need to be on the same Ethernet subnet.

When the secondary is enabled, the DTC will send identical messages to both IP addresses.

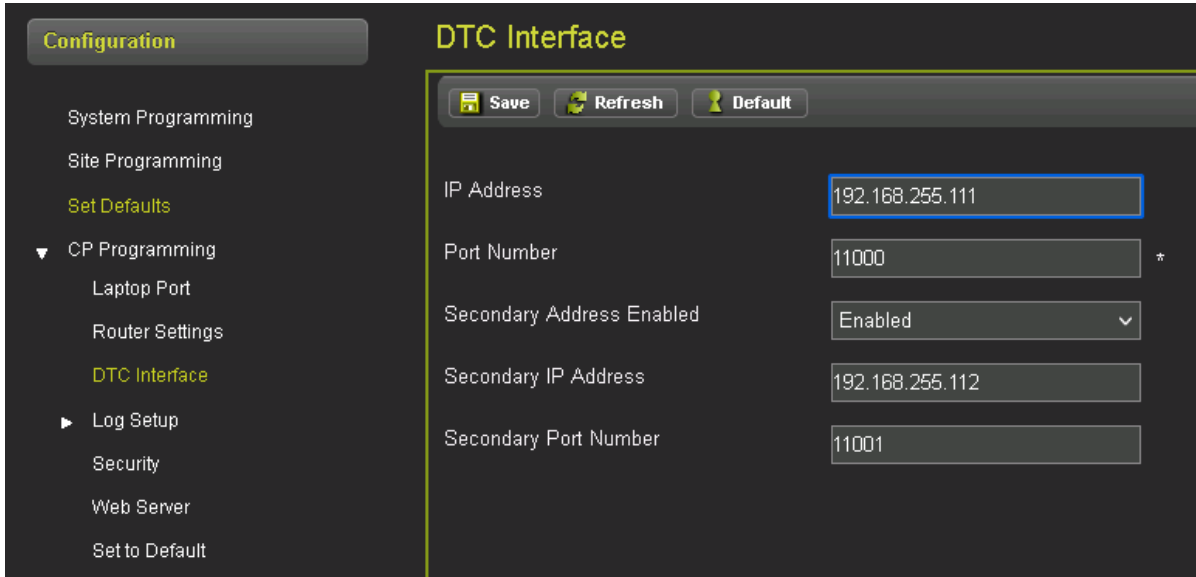

Figure 5-20 DTC Interface

5.5.4 Log Setup

This screen is used to set various diagnostic levels. These values should not be changed unless specifically instructed to by Siemens personnel.

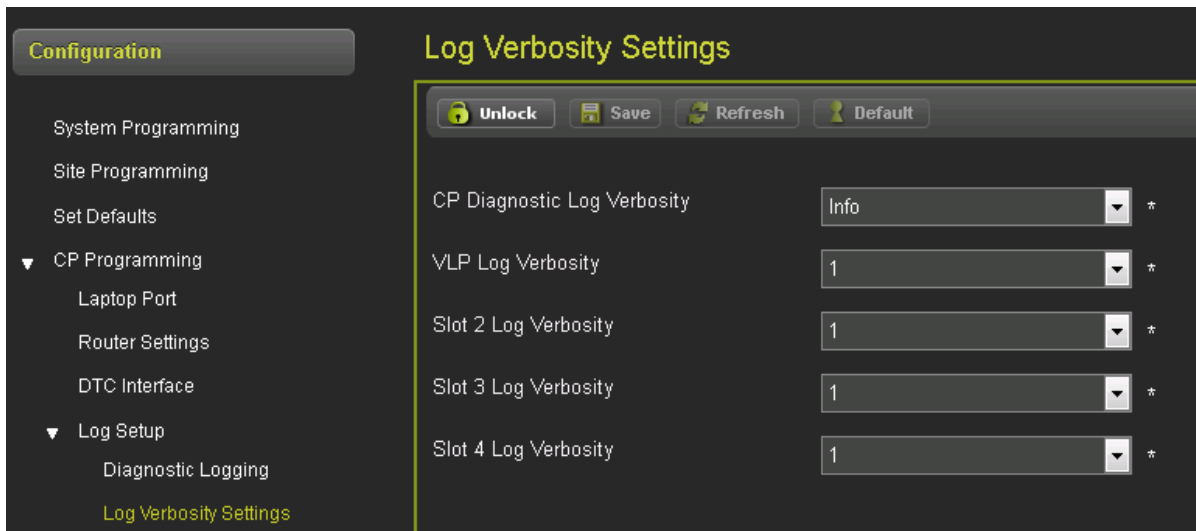

Figure 5-21 Log Verbosity Settings

5.5.5 Security

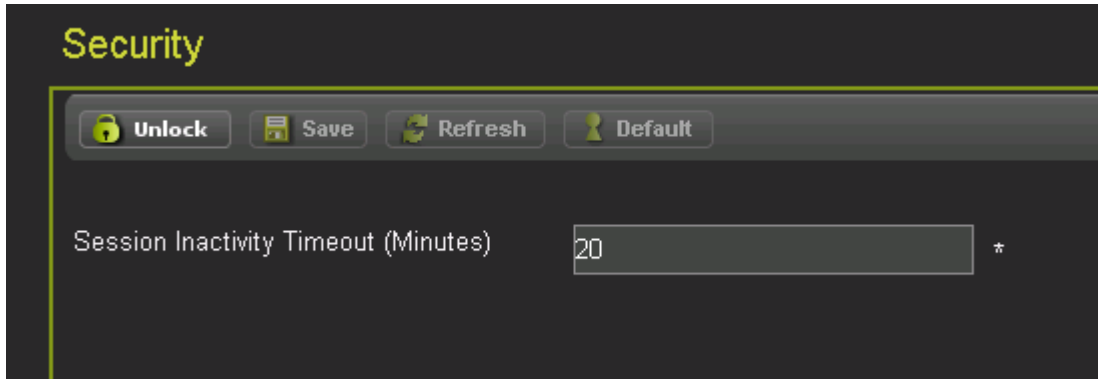

Figure 5-22 Security

Session Inactivity Timeout: 5 to 60 mins, the default is 20 mins. This is used to timeout the WebUI if there is no activity on the DTC for the configured time.

5.5.6 Web Server

This allows the user to choose between secure (https) and non-secure (http) mode.

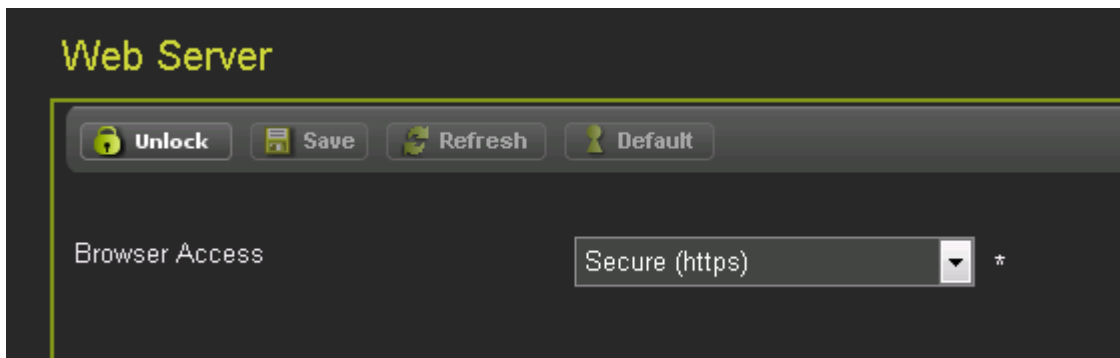

Figure 5-23 Web Server

Set to Defaults. This used to set the CP parameters back to defaults. The parameters under System Programming are unaffected.

5.6 CONFIGURATION CHECK NUMBERS

The software used in the DTC generate various 32-bit Cyclical Redundancy Check (CRC) numbers which can be used to determine whether the configuration matches the office plans or whether the configuration or calibration have has changed since the previous value was recorded.

The four check numbers are:

- CCN – Configuration Check Number
- OCCN – Office Configuration Check Number
- TCN – Track Configuration Check Number
- FCN – Field Configuration Check Number

In general, none of these need be used in the DTC application.

5.6.1 Configuration Check Number (CCN)

This value is the check number that covers:

- a) The MCF CRC
- b) The ATCS Address of the CPU
- c) The DTC Programming parameters

If this check number is recorded after the system is installed and commissioned, it can be used to check that there have been no changes in the DTC Programming.

5.6.2 Office Configuration Check Number (OCCN)

This value is the check number that covers:

- a) The MCF CRC
- b) The ATCS Address of the CPU
- c) Selected DTC Programming parameters designated as being included in the OCCN

This check number is generally used to check that the configuration supplied by the design office matches that programmed into the GCP. The parameters that are included in the OCCN are ones that typically can be specified by the office, ones which may need adjustment in the field are not included, for example, parameters which specify an EZ level.

5.6.3 Track and Field Configuration Check Numbers (TCN and FCN)

This Track Check Number is a value that will change every time the track module is calibrated (GCP, Approach, Linearization). Each Track module has its own TCN. The main and standby track modules have different TCNs.

The Field Configuration Check Number (FCN) is a value composed of the TCNs for both track modules. The main and standby sides have different check numbers.

This field check number can be used by the maintainer to check whether any calibrations have been performed since they last visited the site. If the maintainer finds the FCN is different from the value they last recorded, they can look at the track detail screen at the track check numbers and find when the date and time they were last changed.

The Display module will show both Main and Standby TCNs and FCNs.

The TCN and FCN will show a value of 0 if the track card is not fully configured and calibrated and in session with the CPU (for the powered side).

If a parameter is changed which causes the DTC to require calibration, then the TCN will show zero. When the DTC is then fully calibrated its value will be non-zero.

NOTE**NOTE**

If a parameter that affects the TCN is changed so that calibration is required, but is then changed back to its original value, the DTC will no longer require calibration.

The TCN is updated to a new value, as the TCN is recalculated when the DTC goes from an uncalibrated to a calibrated state.

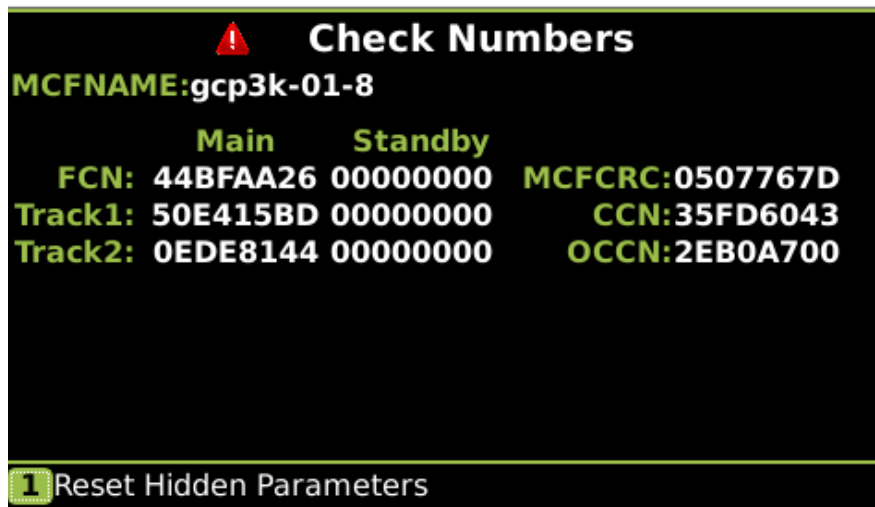

Figure 5-24 Check Number Screen

5.7 OFFICE CONFIGURATION EDITOR

Since there are very few programming steps necessary for the DTC, the Office Configuration Editor is not necessary for the DTC application. The programming steps necessary can be marked up on the drawings. However, the OCE (or Windows DT) can be used to create a PAC file contain the System Programming and Site Programming settings. It cannot, however, be used to set the Display or CP Programming Sections. These need to be configured separately on the actual units via the Display or CPU user interfaces.

NOTE**NOTE**

The OCE does not support setting the Display or CP Programming Sections of the DTC application.

This Page Intentionally Left Blank

SECTION 6 DTC CALIBRATION AND SYSTEM OPERATIONAL CHECKS

6.0 GENERAL

This section details the programming methods and procedures for the DTC.

6.1 SETTING UP DTC OVERVIEW

The minimal steps to setting up the DTC once it has been installed are as follows.

From the Display Local UI or WebUI or CPU III WebUI perform the following:

- a) If less than 5 track modules are used in the DTC, disable the unused tracks from the System programming screen.
- b) Program the Trk frequency for each track card.
- c) Program Approach Distance for each track card.
- d) Program any other system programming changes (unusual).
- e) Set the Site Name in the Site Programming / Location page.
- f) From the CPU WebUI Configuration / CP programming / DTC interface page, set the IP address and port number for the Yard control system and for the secondary system, if used.
- g) For each track:
 - a. Ensure the track has no cars on it, perform the GCP calibration from the Display or CPU.
 - b. Assuming that the track is terminated with a hardwire shunt, perform the Approach Calibration from the Display or CPU III.
 - c. Accurately locate the 50% mark on the track and place a hard wire shunt, perform the Linearization Calibration from the Display or CPU III. Remove the shunt.

NOTE**NOTE**

The DTC can be calibrated from the CPU III WebUI without requiring confirmation of local user presence.

6.2 DTC CALIBRATION AND SYSTEM OPERATIONAL CHECKS

The DTC Calibration consists of DTC calibration and system checkout. DTC calibration is divided into the following automated procedures:

- GCP calibration (GCP CAL)
- Approach distance calibration (APP CAL)
- Approach linearization (LIN CAL)

6.2.1 Calibration Required Message

The Display System View Screen, Figure 6-1, shows the calibration status for each track by showing the highest level of calibration required. In this example, Track 2 requires GCP Calibration, then subsequent Approach and Linearization. GCP Calibration has been performed on Track 1. The next calibration required is Approach.

Trk	EZ	EX	MPH	ISL
1	App	Cal	Req	NU
2	GCP	Cal	Req	NU
3	0	0	0	NU
4	0	0	0	NU
5	0	0	0	NU

SSCC: XR XFER: main

Figure 6-1 Two Track Status Screen Display Prior to Calibration

6.2.2 System Programming Requirements

Before calibration, the DTC must be programmed using the procedures provided in Section 5.0.

- If the system was previously programmed, verify that system programming corresponds to the railroad application instructions for the applicable tracks.
- System programming is done only once.



WARNING

THE TRACK CARD MUST ONLY BE CALIBRATED WHEN THE TRACK IS EMPTY.

IF CALIBRATION IS PERFORMED WHEN A CAR IS STANDING ON THE TRACK, THIS WILL RESULT IN THE DTC REPORTING CARS AS FURTHER AWAY THAN THEY REALLY ARE.

6.2.3 In Service Recalibration Due to Failed Modules

The following in-service modules may be replaced without recalibration of the DTC:

- CPU, A80903
- Display Module, A80485

In-service Track Module recalibration may be required due to:

- Failed module replacement
- Program changes
- Track equipment changes

In general, new software executives for the Track Modules are backwards compatible with prior software, so if the track module executive software is updated on a module it will not require any recalibration. In the rare event that recalibration is necessary, the track module will show GCP CAL on its four-character display and the Display module will show GCP CAL.

6.2.3.1 In Service Recalibration Requirements Due to Failed Track Module Replacement

Recalibration must be performed for the associated track when a failed A80418 Track Module is replaced.

- Only the GCP (GCP CAL) must be completed.
- The GCP Approach distance (GCP APP) and GCP Linearization (GCP LIN) procedures may be bypassed by selecting the BYPASS button.
- Previous approach distance and linearization values remain unchanged, eliminating the need for additional track shunt placement.

NOTE**NOTE**

It is not necessary to remove power from the DTC case before removing or installing modules.

6.2.3.2 Recalibration Requirements Due to Program Changes

The DTC program changes that required track recalibration are indicated in Table 6-1. Recalibration is required if **Yes** is included in the corresponding column. For example, if the number of tracks in the installation is increased, perform the following calibration procedures for the added tracks only:

- Setup for calibration
- Setup for approach distance
- Linearization

Table 6-1 Recalibration Requirements Due to Programming Changes

Program Changes	Calibration Required			Reprogramming Required	Notes
	GCP CAL	GCP APP	GCP LIN		
Increased Number of Tracks	Yes ¹	Yes ¹	Yes ¹	Yes ¹	1. For added tracks only. 2. For tracks with new GCP frequencies. 3. For changed tracks only.
Trk Frequency Change	Yes ²	Yes ²	Yes ²	No	
Application changed from: Unidirectional to Sim Bidirectional, Sim Bidirectional to Unidirectional					
Transmit Level Changed From: Medium to High or High to Medium	Yes ³	Yes ³	Yes ³	No	4. For all tracks. 5. Complete re-programming required. 6. Can be bypassed. 7. In general DTC calibration is not required when software is updated. However, in some cases due to the nature of the change, it may be necessary to force a recalibration, in this case the module will show that calibration is required after the new software has been loaded. Approach and Linearization can be bypassed after GCP calibration has been performed.
Approach distance Changed					
Set to Default selected (and track parameters listed above changed from original settings)	Yes ⁴	Yes ⁴	Yes ⁴	Yes ⁵	
Track MEF Changed	No ⁷	No ⁶	No ⁶	No	
Other MEFs Changed	No	No	No	No	
System MCF Changed	Yes	Yes	Yes	Yes	

6.2.4 Recalibration Requirements Due to Track Equipment Changes

Changes made to the existing track equipment that require track recalibration are shown in Table 6-2. Recalibration is required if **Yes** is included in the corresponding column. For example, when existing termination shunts in an installation are moved to a different location, the approach distance entered in the Program menu for that track must be changed to reflect the new approach distance. The GCP, Calibration, Approach distance and Linearization procedures must be performed.

NOTE

NOTE

Approach distance in the Program menu must be changed to reflect the new approach distance prior to start of track calibration.

Table 6-2 Recalibration Requirements Due to Track Equipment Changes

Track Equipment Changes	Calibration Required			Notes
	GCP CAL	GCP APP	GCP LIN	
Hardwire Termination Shunt Changed	Yes ¹	No	No	1. For changed tracks only 2. Requires bypass
Hardwire Termination Shunt Moved to New Location	Yes ¹	Yes ¹	Yes ¹	
DTC Track Wire(s) Replaced	Yes ¹	No ²	No ²	

6.2.5 In Service Recalibration if Shifts in EZ Occur

In order for the DTC to report an accurate distance to couple to the Yard control system, EZ must be maintained close to 100 when the track is empty. When the GCP and Approach calibration is completed the DTC will equate an EZ value of 100 with the programmed length of the track. Thus, if EZ drifts, this will result in an error in the reports car positions.

In this case, recalibration using only the **GCP CAL** procedure may be used along with the following **BYPASS** procedures for **GCP APP** and **GCP LIN**.

- The **BYPASS** procedure accepts the current values for the computed approach and linearization steps and removes the **APP CAL** and **LIN CAL** notifications from the System View.
- This eliminates placing hardwire shunts on the track as required by the calibration procedure.
- Once **GCP CAL** is completed, bypass the approach calibration by first selecting **GCP APP** and then **BYPASS**.
- Do not select **START**.
- Bypass the linearization calibration by first selecting **GCP LIN** and then **BYPASS**.
- Do not select **START**.

WARNING

WARNING

USE THE BYPASS PROCEDURE ONLY IF THE CURRENT COMPUTED APPROACH DISTANCE AND LINEARIZATION VALUES ARE KNOWN TO BE CORRECT.

DO NOT RECALIBRATE IF AN IN-SERVICE TRACK SUDDENLY HAS A LARGE JUMP IN EZ OR HIGH SIGNAL ERROR. THE CAUSE MAY BE A TRACK, BOND, OR SHUNT RELATED PROBLEM WHICH MUST BE INVESTIGATED AND CORRECTED BEFORE CONSIDERING RECALIBRATION.

WARNING

WARNING

BEFORE STARTING CALIBRATION, ENSURE THAT:

- **TRACK BONDING IS GOOD.**
- **ALL TERMINATION SHUNTS ARE INSTALLED.**
- **NO CAR IS PRESENT ON THE TRACK BEING CALIBRATED.**

NOTE

NOTE

The Display prevents the BYPASS procedure being performed if the GCP Calibration was completed because of a programming value change.

6.3 DTC MODULE CALIBRATION

When possible, all DTC Calibration procedures should be done when ballast is dry. If calibration is done when ballast is wet, recalibration may be required later when the ballast is dry.

NOTE

NOTE

The Display System View shows GCP CAL for each track parameter requiring calibration.

The following provides the procedure for recalibration from the Display Module. The messaging protocol used between the Yard control system and the DTC also provides a method for remote calibration from the Yard control system. For initial installation, the calibration must be done from the field, and all checked performed. The Yard control system may be used for subsequent DTC calibration if EZ has drifted from 100 when the track is empty.

Table 6-3 GCP Calibration

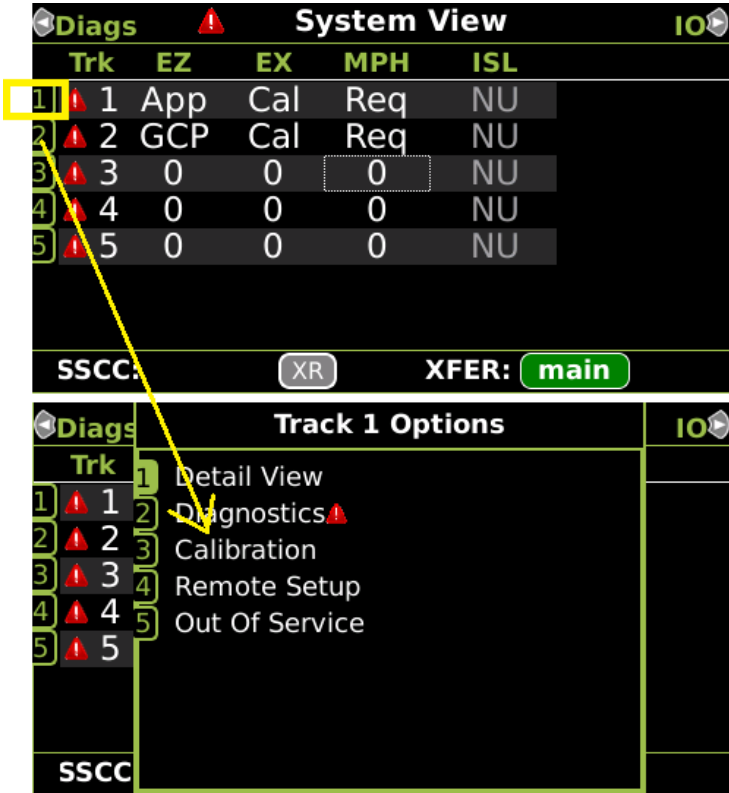
<p>Step 1</p>	<p>From the System View menu, select the track to calibrate, i.e., entering trk number on the keypad. The menu only shows enabled tracks.</p>
<div style="text-align: center;">  </div> <p style="text-align: center;">Figure 6-2 Opening the Calibration Window</p>	
<p>Step 2</p>	<p>From the Track Options menu, select 3) Calibration (See above). The Track “N” Window appears, depicting the Calibration status of:</p> <ol style="list-style-type: none"> 1) GCP, along with EZ and EX values 2) Approach, along with Computed Distance 3) Linearization, along with Linearization Steps <p>If Calib Req appears on any of the above lines, calibration is required (see Figure 6-3).</p>

Track 2	Track 1	Track 2
1 GCP ✗ Calib Req		EZ: 109 EX: 105
2 Approach ✗ Calib Req		Computed Distance: 9999
3 Linearization ✗ Calib Req		Linearization Steps: 100
4 Island ✗ Calib Req		Island: ● Z Level: 250

Figure 6-3 Calibration Required

Step 3

Select 1) **GCP**.
 The Track “N” GCP Calibration Window opens, listing 1) **Start Calibration** and 2) **Add Comment**.
Select 1) Start Calibration. The display depicts **Initiating, In Progress** messages during calibration.
 If calibration is successful:
Passed, Please Wait appears in the window.
 EZ should be 98 to 102 and the 1) **GCP** line has a green check next to **Calibrated**.
 If calibration is not successful, the display shows a **Failed** message.

Track	Track 1 GCP Calibration	ck 2
1 GCP ✗ Ca	1 Start Calibration 2 Add Comment	
2 Appro ✗ Ca		
3 Linea ✗ Ca		
4 Island ✗ Ca		

Figure 6-4 Start Calibration

Track 2	Track 1	Track 2	Track 2	Track 1	Track 2
1 GCP ✗ In Progress...	EZ: 109 EX: 105		1 GCP ✓ Calibrated	EZ: 101 EX: 105	
2 Approach ✗ Calib Req	Computed Distance: 9999		2 Approach ✗ In Progress...	Computed Distance: 2977	
3 Linearization ✗ Calib Req	Linearization Steps: 100		3 Linearization ✗ Calib Req	Linearization Steps: 100	
4 Island ✗ Calib Req	Island: ● Z Level: 250		4 Island ✗ Calib Req	Island: ● Z Level: 250	

Figure 6-5 Calibration In Progress and Complete

Step 4 To record the date and time stamped reason for the recalibration and store it in the log, select the **1) GCP** button and then the **2) Add Comment** button. Type any notes on the reason for recalibration and select **Enter** to save the entry. The Comment Entry window closes, and the display returns to the **GCP Calibration** window as shown in Figure 6-6.

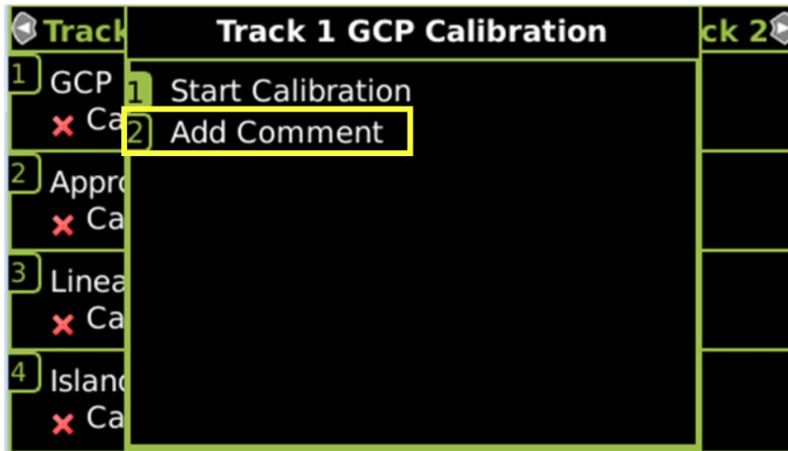

Figure 6-6 Add Comment Option

This completes the DTC Calibration. Proceed to Section 6.4, Approach Distance and Linearization Calibration.

6.4 APPROACH DISTANCE AND LINEARIZATION CALIBRATION

NOTE

NOTE

1. The setup for approach distance and setup for linearization procedures are combined into a single procedure to simplify track-shunting requirements.
 - a. The combined procedure calculates a modified approach distance based on actual approach distance (distance to the termination shunt from the track wires) plus the electrical characteristics of the termination shunt and any simulated track impedance placed in series with the shunt.
 - b. This procedure is essential to improving determination of speed and distance of railroad cars.
2. The linearization procedure compensates for lumped loads in the DTC approach that can affect the linearity of EZ over the length of the approach as a train approaches the feedwires.
 - a. The linearization is essential to improving determination of speed and distance of railroad cars.

WARNING

WARNING

1. **THE APPROACH AND LINEARIZATION PROCEDURES REQUIRE THE RECORDING OF THE COMPUTED APPROACH DISTANCES IN FEET (NOT THE EZ VALUE).**
2. **WHEN EDITING THE COMPUTED APPROACH DISTANCES, ENTER THE VALUE IN FEET (NOT THE EZ VALUE).**
3. **FAILURE TO ENTER DISTANCES IN FEET MAY RESULT IN SHORTER WARNING TIMES THAN INTENDED.**

Table 6-4 Approach and Linearization Calibration Bypass Procedure

Step 1	Once GCP Calibration is completed, bypass the approach calibration by first selecting 2) Approach . After the Track “N” Approach Calibration Window opens, select 3) Bypass . Do not select 1) Start Calibration .
Step 2	Bypass the linearization calibration by first selecting 3) Linearization . After the Track “N” Linearization Calibration Window opens, select 3) Bypass . Do not select 1) Start Calibration .

NOTE

NOTE

Calibration Distance and Linearization Steps values are site historical data and must be recorded as specified in Table 6-5 and Table 6-7 in this manual and on the History Card.

Table 6-5 Approach and Linearization Calibration 1

Step 1	Record the EZ and EX values for the track (before installing the hardwire shunt) in the Step 1 column (Calibrated Values) on the CALIBRATION VALUES HISTORY form (Table 6-7). If the approach is terminated by a hardwire shunt, go to step 2. If not then temporarily place a hardwire shunt across the termination shunt.
Step 2	Record the EZ and EX values for the track in the First Approach, Step 2 column on the CALIBRATION VALUES HISTORY form (Table 6-7).
Step 3	Select the 2) Approach . The Track “N” Approach Calibration Window opens, listing 1) Start Calibration, 2) Edit, 3) Bypass and 4) Add Comment .
Step 4	Select 1) Start Calibration . The display reports Initiating , then In Progress during the calibration. If calibration is successful: <ul style="list-style-type: none"> • Passed, Please Wait appears in the window, followed by Calibrated. • The Computed Distance value appears and the 2) Approach line has a green check next to Calibrated. If calibration is not successful, the display shows a Failed message.

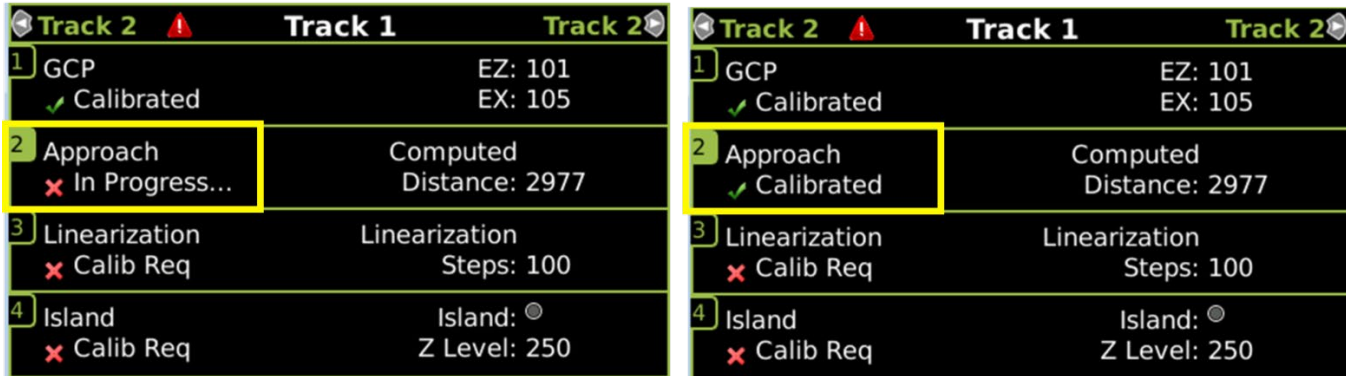

Figure 6-7 GCP Approach Calibration Window Before and After Approach Calibration

Step 5	Record the computed approach distance in feet for the track in First Approach, Step 5 column (Comp Dist) on CALIBRATION VALUES HISTORY form (Table 6-7).
Step 6	If a hardware was temporarily applied in step 1 then remove it. Accurately (within 1%) locate the midpoint of the longest approach and place a hardwire shunt to that point on the rails (see Figure 6-8).
Step 7	Select 3) Linearization . The Track “N” Linearization Calibration Window opens, listing 1) Start Calibration, 2) Edit, 3) Bypass and 4) Add Comment .

<p>Step 8</p>	<p>Select 1) Start Calibration. The display reports Initiating, then In Progress during the calibration.</p> <p>If calibration is successful:</p> <ul style="list-style-type: none"> • Passed, Please Wait appears in the window, followed by Calibrated. • The Linearization Steps value appears and the 3) Linearization line has a green check next to Calibrated. <p>If calibration is not successful, the display shows a Failed message.</p>
<p>Step 9</p>	<p>Record the linearization step value for the track in the First Approach, Step 9 column (Linearization Steps) on the CALIBRATION VALUES HISTORY form (Table 6-7).</p> <p>The value should be between 68 and 132. If not, refer to Troubleshooting, found in Section 7.4</p>
<p>Step 10</p>	<p>Verify that the computed approach distance in feet (Comp Dist, Step 5) and the linearization steps (Linearization Steps, Step 9) values recorded on the CALIBRATION VALUES HISTORY form (Table 6-7) are the same as the values displayed on the Track “N” window.</p>
<p>Step 11</p>	<p>Remove the temporary hardwire shunt that was just applied from the track.</p>

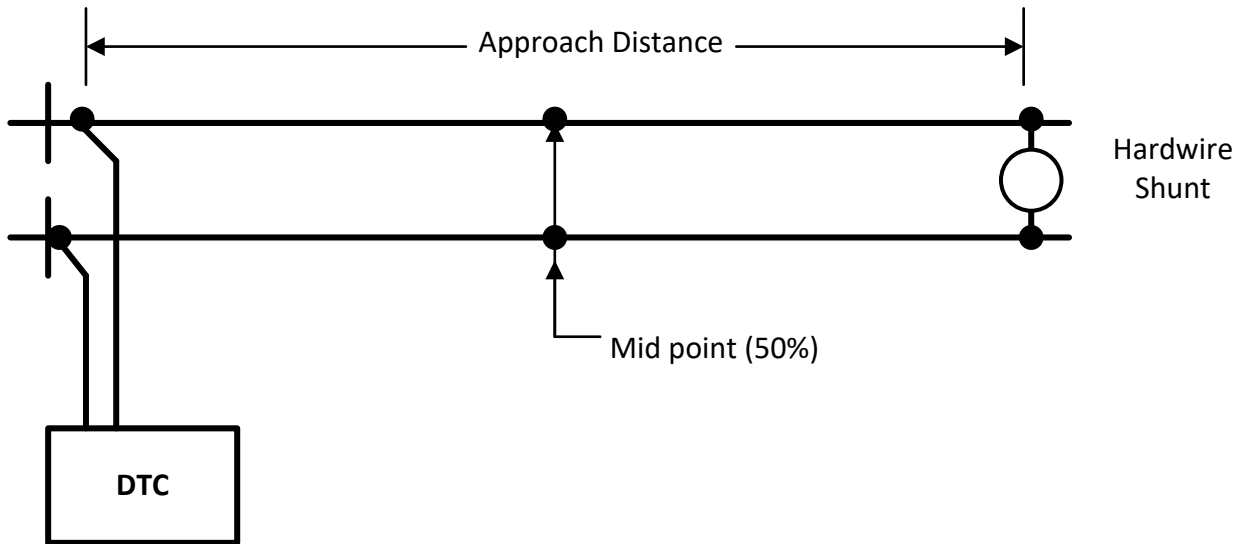

Figure 6-8 Midpoint Location

Table 6-6 Approach and Linearization Calibration 2

<p>Step 12</p>	<p>To record the reason for the Calibration and store it in the event log, select 3) Linearization and then 4) Add Comment.</p> <ul style="list-style-type: none"> • Type any notes about the calibration and select Enter to save the entry.
-----------------------	---

Table 6-7 Calibrated Value History Form

1										CALIBRATION VALUES HISTORY FORM (APPROACH AND LINEARIZATION CALIBRATION)									
GCP#: _____										Date of Calibration: _____ Name: _____									
Location Information: _____																			
CALIBRATION VALUES HISTORY																			
Calibrated Values (Step 1)		First Approach E/W () N/S						Second Approach E/W () N/S											
		Hardwire Across Term. Shunt (Step 2)		Computed Approach Distance (Comp Dist) (Step 5)		Linearization Step Value (Linearization Steps) (Step 9)		Hardwire Across Term. Shunt (Step 14)		Computed Approach Distance (Comp Dist) (Step 17)		Linearization Step Value (Linearization Steps) (Step 21)							
		EZ	EX	EZ	EX			EZ	EX										
Track 1																			
Track 2																			
Track 3																			
Track 4																			
Track 5																			

This completes Approach and Linearization Calibration.

6.5 DTC OPERATIONAL CHECKS

6.5.1 Connectivity

Ensure that the Laptop port on the CPU III is connected to the same Ethernet LAN as the Yard control system.

Ensure that the IP address and port number of the Yard control system have been set on the CPU III configuration page under the CP programming/ DTC interface tab. This step has to be done from the CPU III WebUI and cannot be done via the Display Module.

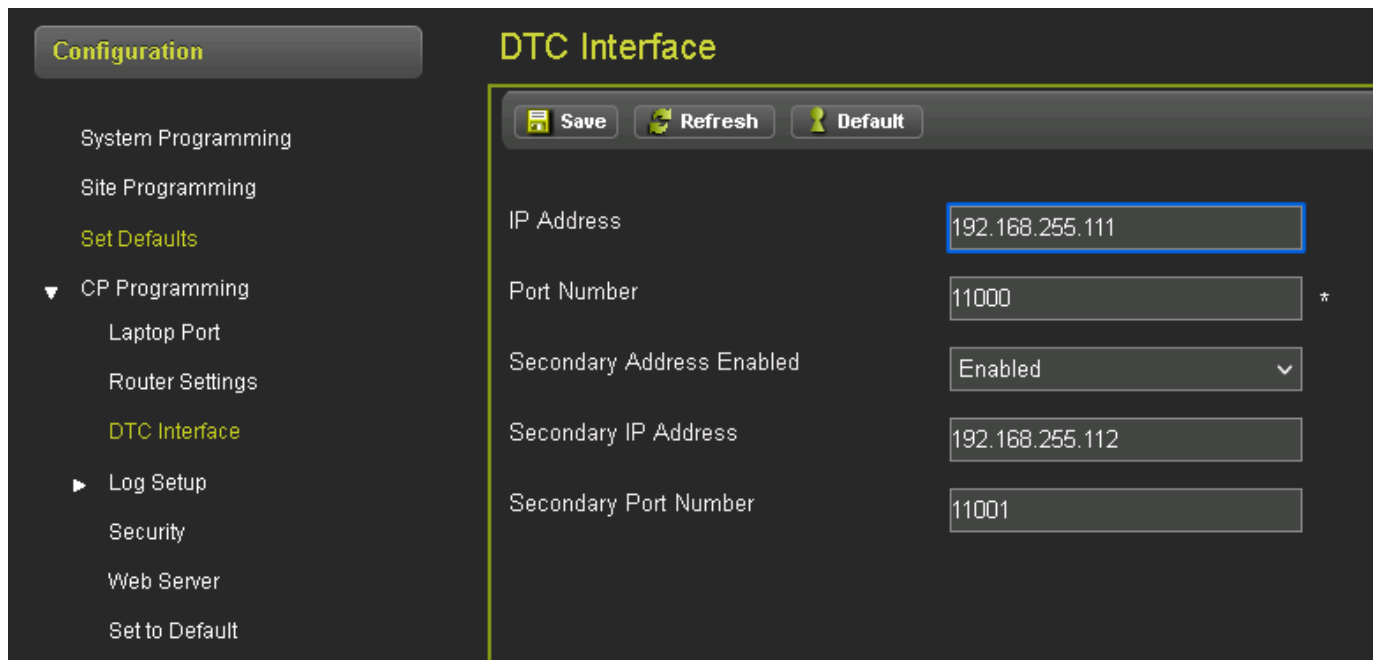

Figure 6-9 Setting Yard System IP Address

Ensure that the ATCS address of the DTC matches that programmed for this DTC in the Yard control system. This can be seen in the top right of the WebUI.



Figure 6-10 ATCS Address on WebUI

If this is not correct, if a Display Module is present, the ATCS address must be reconfigured using the Display Module interfaces. If no display is present, the CPU III WebUI can be used. This can be done from the Display local user interface as described in section 5.3.1 or from the WebUI on the Configuration / Site Programming / ATCS site ID menu.

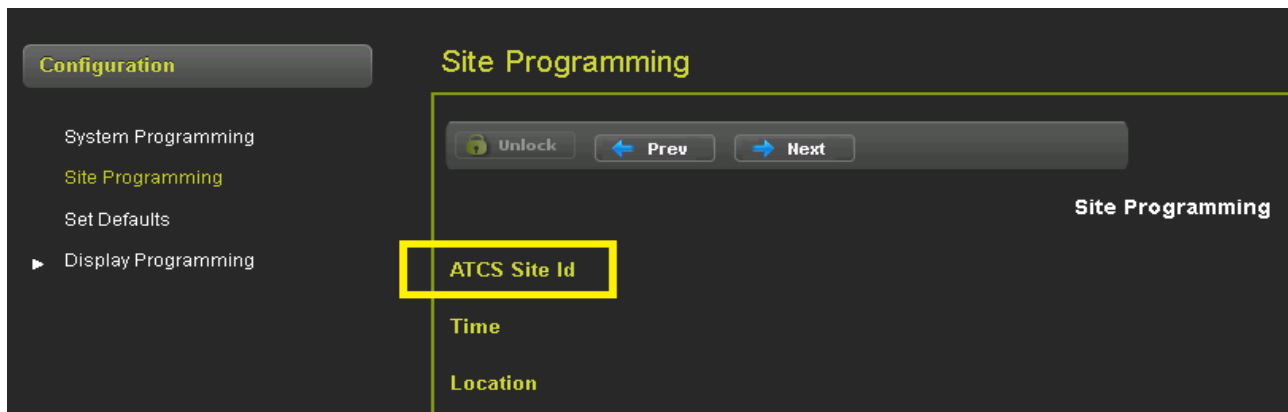

Figure 6-11 Setting ATCS Address on WebUI

The DTC will send UDP messages containing the ATCS yard status message out of its laptop port. The CPU III does not need to hear any messages from the Yard control system to start broadcasting these messages.

Check to ensure that the Yard control system is receiving these messages.

6.5.2 Distance

After the track has been programmed and the GCP calibration, approach calibration and linearization steps have been done, perform the following checks:

1. Remove the hardwire shunt, so only the hardwire termination shunt at the end of the approach is present and check:
 - a. that the track is reporting an EZ of 100 +/-1. If EZ is out of this range reperform the GCP Calibration step on this track.
 - b. that the Yard control system reports the track being unoccupied to a distance equal to the track length. If EZ is in range but the distance is incorrect, check that the correct approach distance has been programmed for this track.
2. Place a hardwire shunt across the track wires and check:
 - a. that the track is reporting an EZ of 0 +/-1. If this check fails check the track wiring, surge protection, track cables and rail connections for high resistance. Also make sure that track wire lengths are within specifications.
 - b. that the Yard control system reports the DTC track as being 100% occupied.
3. Place a hardwire shunt 25% of the way down the track and check:
 - a. that the track is reporting an EZ of 25 +/-2.
 - b. that the Yard control system reports the DTC track being occupied to a distance of 25% x configured track approach distance.
4. Place a hardwire shunt 50% of the way down the track and check:
 - a. that the track is reporting an EZ of 50 +/-2.
 - b. that the Yard control system reports the DTC track being occupied to a distance of 50% x configured track approach distance.
5. Place a hardwire shunt 75% of the way down the track and check:
 - a. that the track is reporting an EZ of 75 +/-2.
 - b. that the Yard control system reports the DTC track being occupied to a distance of 75% x configured track approach distance.

If the EZ in steps 2..5 are not within tolerance, reperform the approach and linearization calibration steps for the specific DTC track. If this still fails, check there are no high resistance bonds in the approach.

Note the DTC can still operate with tolerances greater than this, however the position reported to the Yard control system will give a percentage error at these points as given by this formula:

- Error at 25% : $(EZ \text{ reading} - 25)/25$, so if the measured EZ was 28 when a shunt was placed 25% down the approach, the error in position is $3/25 = 8\%$
- Error at 50% : $(EZ \text{ reading} - 50)/50$
- Error at 75% : $(EZ \text{ reading} - 75)/75$

6.5.3 Speed

To verify that the DTC is reporting the correct speed measure some car speeds using a radar gun and check they are within an acceptable tolerance of the speeds reported by the DTC to the Yard control system.

SECTION 7 DIAGNOSTICS AND TROUBLESHOOTING

7.0 GENERAL

This section describes how to diagnose and troubleshoot the DTC.

7.1 CPU III MODULE

The CPU III module, Figure 7-1, includes LEDs and a 4-character display.

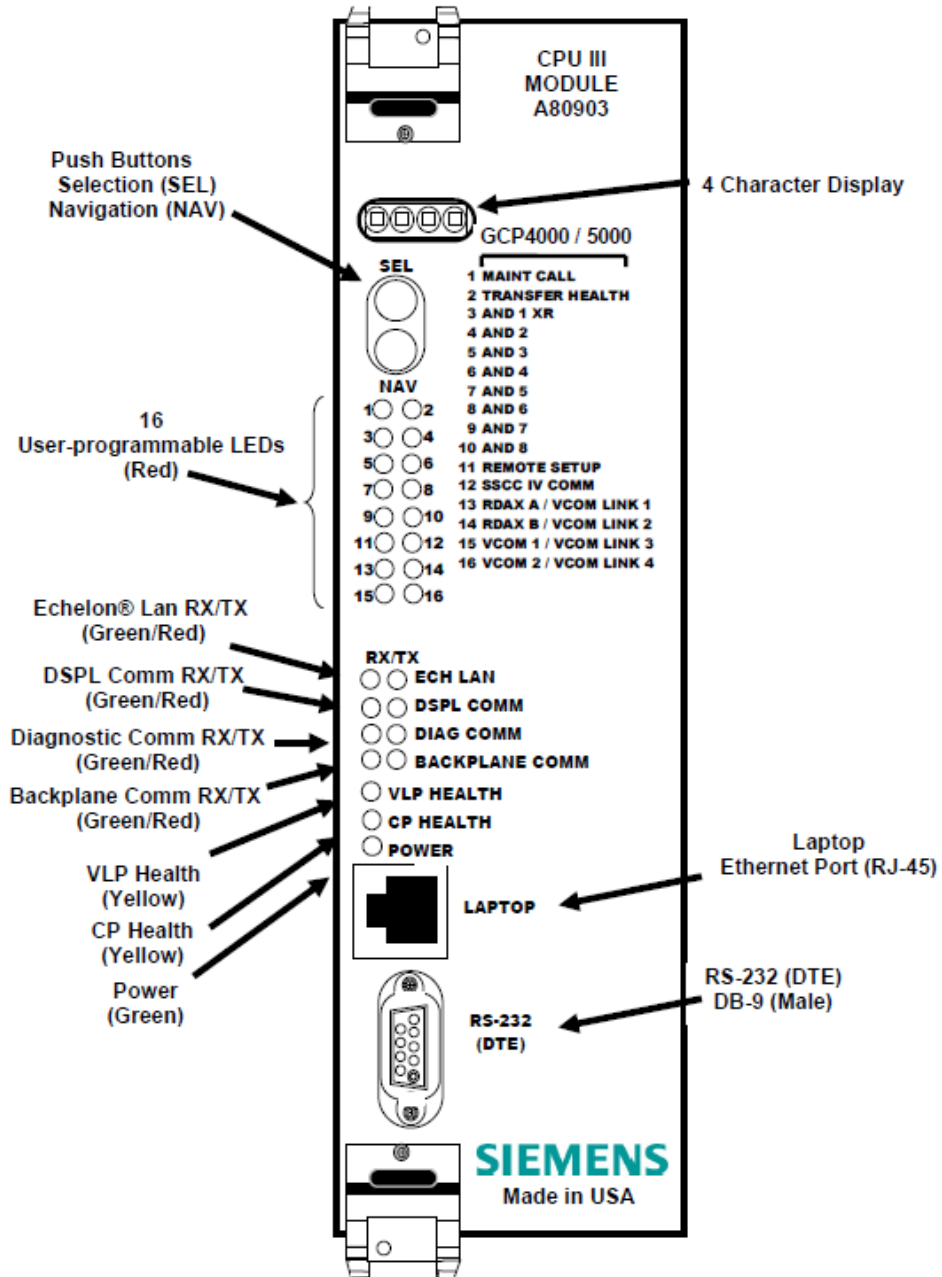

Figure 7-1 CPU III Module

7.1.1 CPU Front Panel LEDs

Table 7-1 Front Panel LED Descriptions

Component	Function		
4-Character Display	Displays alphanumeric representation of currently selected function menu item.		
Select Push Button (SEL)	Used to select menu item displayed on 4-Character Display.		
Navigate Push Button (NAV)	Used to select an available function menu.		
16 MCF Defined LEDs	Color	Function	Indication
1 (MAINT CALL)	Red	Not used in DTC	n/a
2 (TRANSFER HEALTH)	Red	Transfer Output	On – system healthy Off – system unhealthy
3 (AND 1 XR)	Red	Not used in DTC	Off
4 (AND 2)	Red	Not used in DTC	Off
5 (AND 3)	Red	Not used in DTC	Off
6 (AND 4)	Red	Not used in DTC	Off
7 (AND 5)	Red	Not used in DTC	Off
8 (AND 6)	Red	Not used in DTC	Off
9 (AND 7)	Red	Not used in DTC	Off
10 (AND 8)	Red	Not used in DTC	Off
11 (REMOTE SETUP)	Red	Not used in DTC	Off
12 (SSCC IV COMM)	Red	Not used in DTC	Off
13 (VITAL COMM LINK 1)	Red	Not used in DTC	Off
14 (VITAL COMM LINK 2)	Red	Not used in DTC	Off
15 (VITAL COMM LINK 3)	Red	Not used in DTC	Off
16 (VITAL COMM LINK 4)	Red	Not used in DTC	Off
ECH LAN LEDs	TX flashes red when the CPU is transmitting an ATCS message via the LONTALK® LAN. Not used in DTC		
	RX flashes green when the CPU is receiving an ATCS message via the LONTALK® LAN. Not used in DTC		
DSPL COMM LEDs	TX flashes red when the CPU is transmitting data to the Display Panel.		
	RX flashes green when the CPU is receiving data from the Display Panel.		
DIAG COMM (CP) LEDs	TX flashes red when the CPU is transmitting data on the communications processor diagnostic (DIAG CP) serial port.		
	RX flashes green when the CPU is receiving data from the communications processor diagnostic (DIAG CP) serial port.		
BACKPLANE COMM LEDs	TX flashes red when the Vital Logic Processor (VLP) is sending data onto the serial bus.		
	RX flashes green when the Vital Logic Processor (VLP) is receiving data from the serial bus.		
VLP HEALTH LED	Flashes yellow to indicate that the Vital Logic Processor is functioning normally.		
CP HEALTH LED	Flashes yellow to indicate that the Communications Processor is functioning normally.		

Component	Function
POWER LED	Lights green to indicate that power is applied to the CPU module.
RS-232(DTE) (CPU III only)	9-pin diagnostic serial port for Communications Processor used to load software onto I/O modules
Laptop Port (CPU III only)	RJ45 Ethernet port for connection to web browser

7.1.1.1 CPU 4 Character Display

The four character display on the CPU shows the current state of the CPU. The meanings of the display's indications are described in Table 7-2.

Table 7-2 CPU Four Character Display Normal Start-up Sequence

Indication	Mode	Meaning	System State
BOOT	Steady	Boot code running	No communication to I/O modules. Crossing is activated.
INIT	Steady	CPU is initializing	No communication to I/O modules. Crossing is activated.
LMCF	Steady	CPU is loading MCF	No communication to I/O modules. Crossing is activated.
ICHK	Steady	CPU is performing initialization checks	No communication to I/O modules. Crossing is activated.
ERR: INIT	Scrolling	CP is up, VLP completing initialization	No communication to I/O modules. Crossing is activated.
CP: 9VC93-A01.F 1.1.61 VLP: V3Hxx_xx.MEF	Scrolling	CP and VLP software. Press the select button then the NAV button to see these during operation.	CPU is healthy
IP Address (CPU III Only)	Scrolling	Press Select button, the press NAV button to toggle between MCF version CP software version, VLP software version, and IP address.	CPU is healthy
DTC-xx-xx.MCF	Scrolling	MCF name scrolls when VLP is healthy	CPU is healthy

Table 7-3 CPU Four Character Display Error Codes

Indication	Mode	Meaning	System State
ERR: INIT	Scrolling	VLP is not in session with CP	No communication to I/O modules. DTC unhealthy
ERR: CRC	Scrolling	An incorrect MCF CRC has been entered	No communication to I/O modules. DTC unhealthy
ERR: UCFG	Scrolling	VLP is configured, see other diagnostic messages for reason	No communication to I/O modules. DTC unhealthy
ERR: MCF	Scrolling	There is no valid MCF loaded	No communication to I/O modules. DTC unhealthy
ERR: DIN	Scrolling	Incompatible Display module software is being used, or the Windows DT software is being used. The Windows DT software is not compatible with the DTC.	CPU is healthy
ERR: CRPT	Scrolling	Configuration parameters are corrupt. Reload the configuration	No communication to I/O modules. DTC unhealthy
ERR: DFT	Scrolling	Configuration parameters have been set to defaults	CPU is healthy Crossing is activated
RST:USER	Scrolling	User has requested to reset the CP	
EFLA 1% TO 100% DONE	Steady	EFLA indicates CPU is erasing its flash memory % - indicates CPU is copying MCF from ECD into flash memory DONE – indicates MCF has been copied	No communication to I/O modules. DTC unhealthy

7.1.1.2 Setup Menu Display

The CPU III has two processors:

- Communication processor (CP)
- Vital Logic Processor (VLP).
- When new software is installed into the CP, the VLP continues running without interruption until the CP setup is complete.

Table 7-4 Setup Menu Display

Indication	Mode	Meaning
DOWNLOADING SETUP	Scrolling	The setup program is being downloaded into the CP.
SETUP	Scrolling	The CP is in setup mode, i.e., MCF, MCF CRC, or CP MEF is being changed.
WAIT	Steady	CP is erasing flash memory.
WAITING FOR MEF	Scrolling	CP is waiting for a new MEF.
DOWNLOADING MEF	Scrolling	A new MEF is being downloaded into the CP.
WAITING FOR MCF	Scrolling	CP is waiting for a new MCF.
DOWNLOADING MCF	Scrolling	A new MCF is being downloaded into the CP.
DONE	Steady	Setup mode is ending.
BOOT	Steady	The CP is rebooting.

7.2 TRACK MODULE

The Track module, Figure 7-2, includes LEDs and a four-character display.

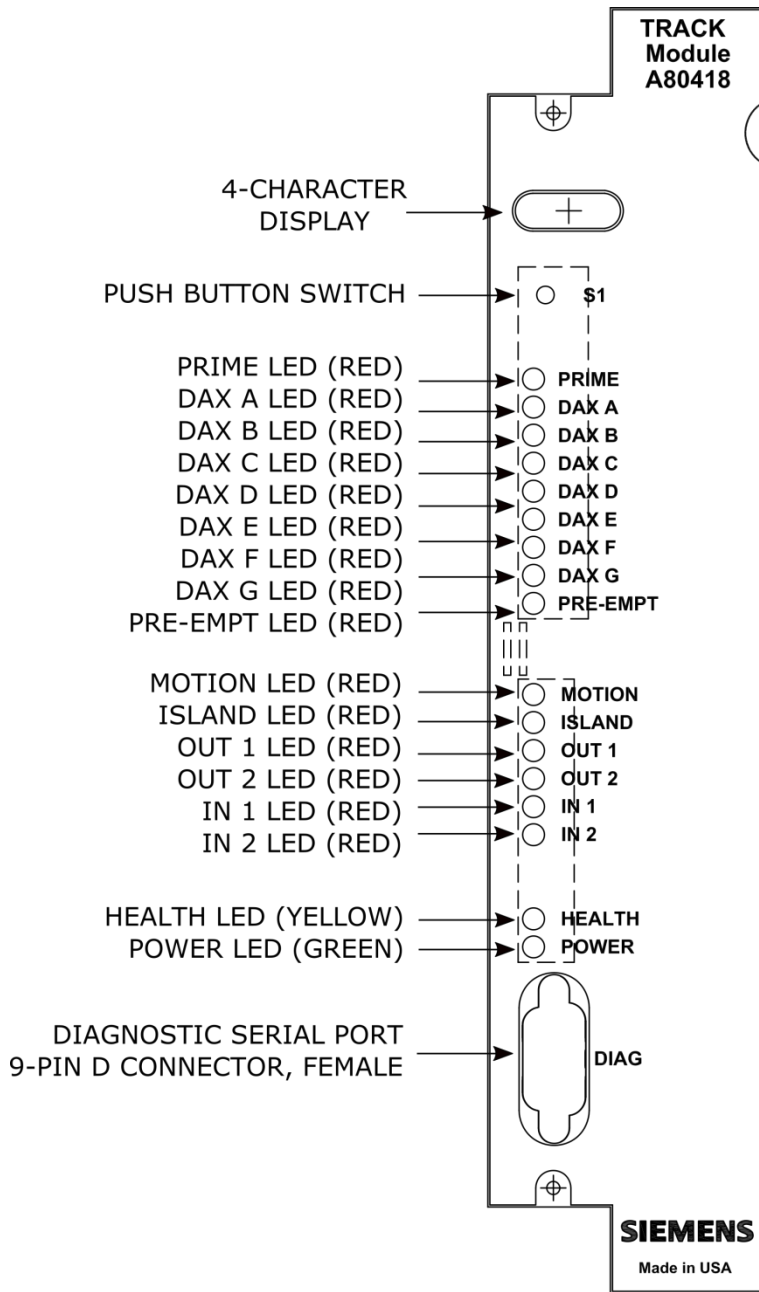

Figure 7-2 Track Module

7.2.1 Track LEDs

The track module LEDs are described in Table 7-5.

NOTE

NOTE

The track module is common with GCP400, MS4000 and GCP5000 systems. Most functions are not applicable when used in the DTC.

Table 7-5 Track LEDs

LED Name	Color	Description
PRIME	Red	Off – Not used in DTC application
DAX A-G	Red	Off – Not used in DTC application
PREEMPT	Red	Off – Not used in DTC application
MOTION	Red	On – track module has not detected inbound motion Off – track module has detected inbound motion Not useful in DTC application as cars have outbound motion
ISLAND	Red	Off – Not used in DTC application
OUT 1	Red	Off – Not used in DTC application
OUT 2	Red	Off – Not used in DTC application
IN 1	Red	Off – Not used in DTC application
IN 2	Red	Off – Not used in DTC application
HEALTH	Yellow	Slow (1Hz) – module is healthy and communicating with CPU Fast (2Hz) – module is not communicating with CPU Very Fast (4Hz) – module is unhealthy and communicating with CPU
POWER	Green	LED is on steady when power is applied to the module

7.2.2 Track Four-Character Display

The four-character display on the Track Module shows the current module function.

The information can be broken into five categories:

- Normal Operation
- Calibration
- Diagnostics
- Boot up
- Software Installation

7.2.3 Normal Operation

The messages that appear during normal operation are shown in Table 7-6. The display will show each message for a second then move to the next one.

NOTE

NOTE

Pressing the S1 button on the track module will stop the display rotating around the different values so that one particular value can be seen. Press the S1 button again to scroll round the different values.

Table 7-6 Normal Operation

Indication	Mode	Meaning	Module State
Znnn e.g., Z100	Steady	“nnn” indicates the EZ value.	Performing train predictions
Xnnn e.g., X093	Steady	“nnn” indicates the EX value.	Performing train predictions

7.2.3.1 Calibration

The messages that appear during calibration are shown in Table 7-7.

Table 7-7 Calibration Messages

Indication	Mode	Meaning	Module State
GCAL	Blinks on and off	GCP Calibration in progress	All predictors de-energized
GAPP	Blinks on and off	GCP Approach in progress	All predictors de-energized
GLIN	Blinks on and off	GCP Linearization in progress	All predictors energized

7.2.3.2 Diagnostics

When the Track Module is unhealthy or requires calibration, a 4-character diagnostic code is shown on its display.

- If more than one diagnostic code is present, the module scrolls around the list of messages.
- The possible diagnostic codes are shown in Table 7-8.

Table 7-8 Diagnostics Messages

Indication	Meaning	Module State
GAPP	GCP Approach Calibration is required	All predictors de-energized
GCAL	GCP Calibration is required	All predictors de-energized
GFRQ	GCP frequency not set	All predictors de-energized
GHWR	GCP hardware error	All predictors de-energized
GLIN	GCP Linearization Calibration is required	All predictors are energized
GRCV	GCP receiver error	All predictors are de-energized
GSLV	GCP slaving error	No effect on predictors
GSTB	GCP is stabilizing after transmitter has been turned on	All predictors are de-energized
GXMT	GCP transmitter error	All predictors are de-energized
GNOS	GCP noise error. Too much noise on track to predict correctly	All predictors are de-energized
HIEZ	High EZ (>115) detected on main or check wires	All predictors are de-energized
LWEX	Low EX detected Low EX Adjustment is usually 39	All predictors are de-energized
RECV (RECOVERY)	The GCP is running a 30 second recovery time-out after an error has cleared	All predictors are de-energized
RXEX	The receive wire phase is incorrect	All predictors de-energized
UCFG	Track module is unconfigured	All predictors de-energized Island de-energized Outputs de-energized Inputs de-energized
VOER	Output hardware failure detected Output is commanded on but is detected as off	Failed output(s) de-energized

7.2.3.3 Boot Up

The messages that can appear during boot-up are shown in Table 7-9.

Table 7-9 Boot-up Messages

Indication	Mode	Meaning	Module State
BOOT	Steady	The module is rebooting	All predictors, islands, inputs, and outputs are de-energized
INIT	Steady	The module is performing its initialization	All predictors, islands, inputs, and outputs are de-energized

The normal sequence of messages that may be seen on boot-up of a healthy track module that is fully calibrated is shown in Table 7-10.

Table 7-10 Module State During Bootup

Indication	Module State
BOOT	Rebooting
INIT	Initializing
GHWR	Checking hardware
UCFG	The module is un-configured and awaiting its configuration from the CPU
GSTB and ISTB	The GCP and Island are stabilizing
Znnn / Xnnn	Alternating EZ/EX/Island Z values indicate the module is healthy

7.2.3.4 Software Installation

When new software is installed, the message shown in Table 7-11 normally displays while the software is being downloaded.

Table 7-11 Software Installation Messages

Indication	Mode	Meaning
BOOT	Steady	The setup program is being downloaded into the CP The module is in setup mode The module is having a new MEF download

7.3 DISPLAY MODULE

The A80485 display module, Figure 7-3, provides a keypad and display which allows:

- configuration programming
- application programming
- calibration programming
- system diagnostics
- system parameter display
- track status display

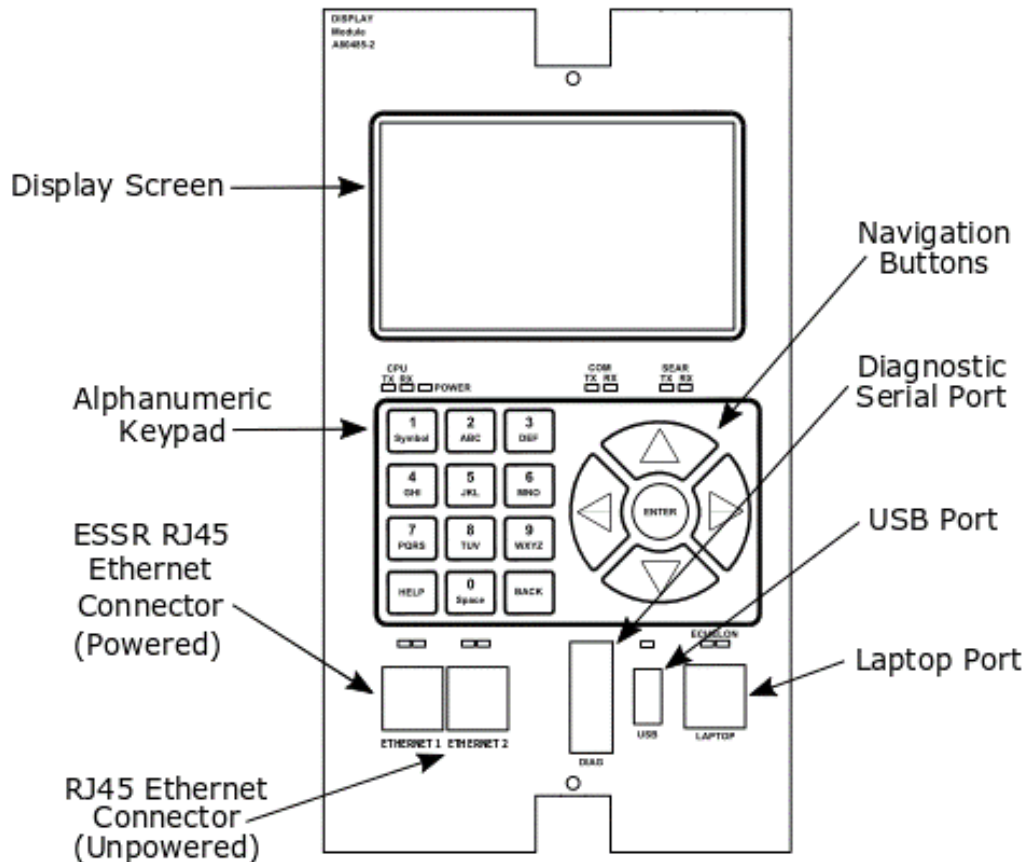

Figure 7-3 Display Module

7.3.1 Track and System Diagnostic Windows

The display immediately shows the health of the system.

7.3.1.1 Unhealthy Track Condition

If any track is unhealthy, the corresponding track status shows a red triangle indicating a diagnostic message is present. When GCP calibration is required, the display shows **GCP Cal Req** under EZ/EX/MPH as shown for Track 2 below.

Trk	EZ	EX	MPH	ISL
1	100	100	0	NU
2	GCP	Cal	Req	NU

Figure 7-4 Example Track Unhealthy Screen

7.3.1.1.1 Healthy Track Condition

If all track modules are healthy, the track status will show no red triangles and will show the EZ, EX, and speed. The XFER status will show a green icon.

The XR is not used in DTC application so will always show grey.

Diags		System View				IO
Trk	EZ	EX	MPH	ISL		
1	100	100	0	NU		
2	100	99	0	NU		

SSCC: XR XFER: Main

Figure 7-5 Example Healthy system Screen

7.3.1.1.2 Unhealthy Track Module

When a Track Module is unhealthy, the red diagnostic triangle indication is present. Select the track number on the keypad for the module and then the Diagnostics option (2). This will bring up the diagnostics messages.

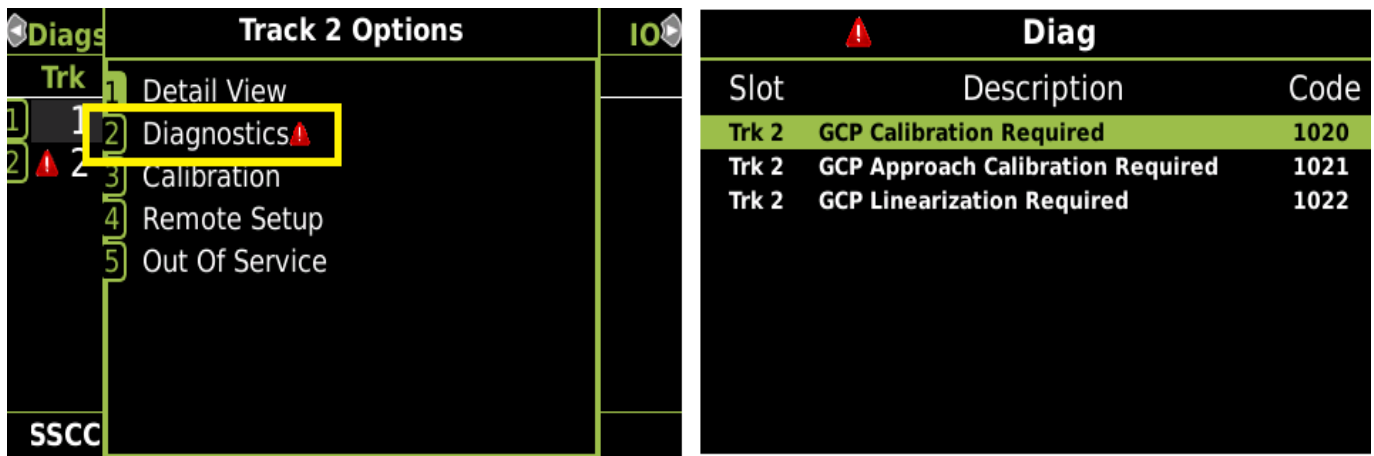

Figure 7-6 Unhealthy Track Module Diagnostics

To see further information regarding a specific diagnostic message, use the up and down arrow keys to select the desired message, then press the enter key. The display will show the potential cause of the problem and suggest remedies to help fix it. Use the up / down keys to scroll up and down, and the back key to go back to the previous menu.

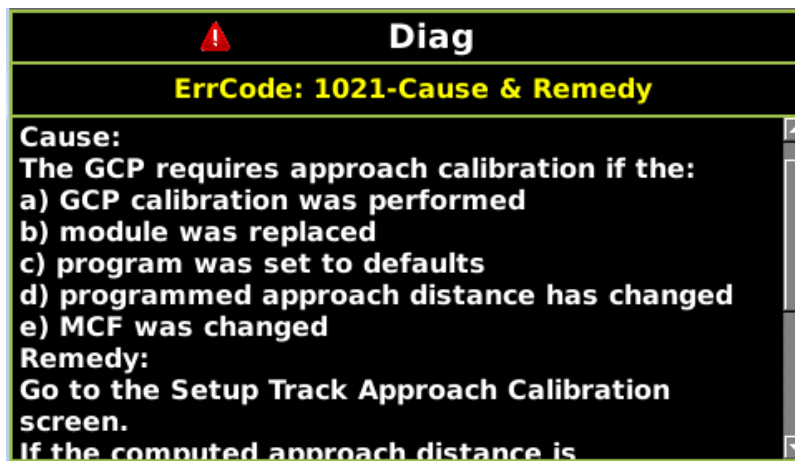

Figure 7-7 Track Diagnostic Message Windows

Some diagnostic messages appear after the initial problem has been eliminated and the GCP is recovering.

An example is:

- GCP recovering

A Track Module is considered unhealthy during its recovery period and predictors on the module remain de-energized.

To see the diagnostic messages for the whole system, select the right arrow to go to the "Diag & Reports" screen, then select **1) DIAG** to see the "Diag" screen.

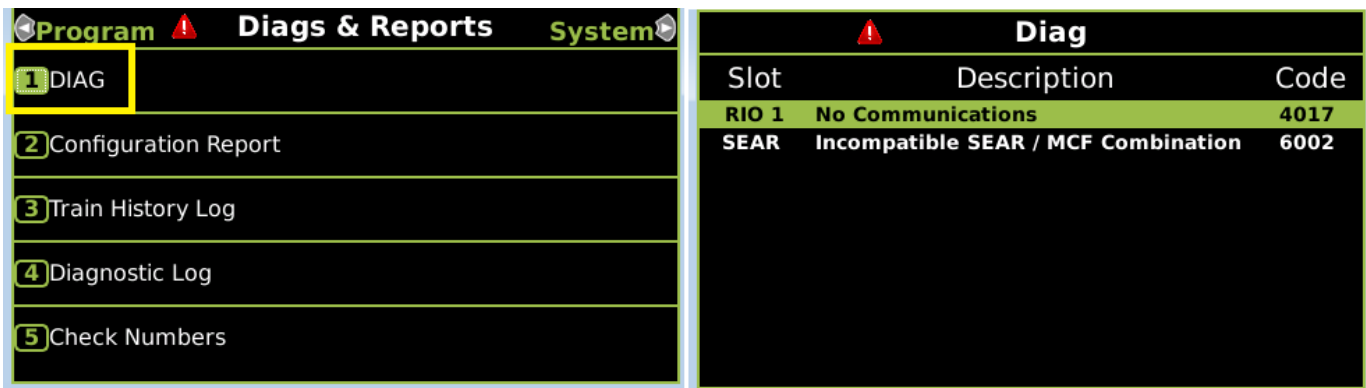

Figure 7-8 Module Diagnostic Message Windows

In some situations, the System View on the Display may show a message indicating that the MCF configuration is not available.

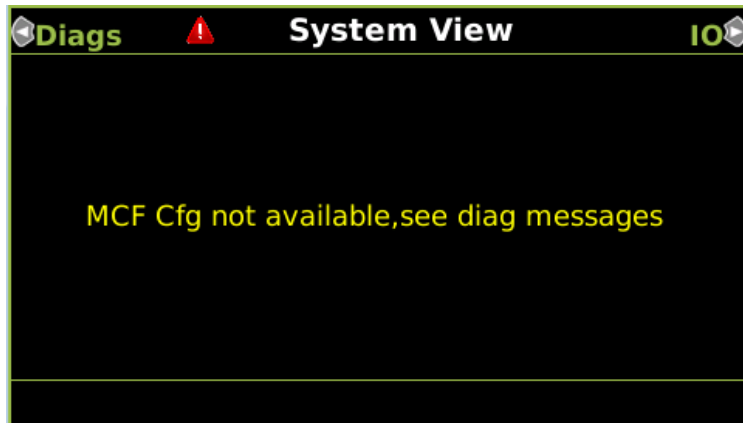

Figure 7-9 MCF Configuration Not Available

This will typically be due to not having the MCF or MCF CRC loaded properly. Check the “Diag” message for more information. A message such as “MCF CRC incorrect” may be present.

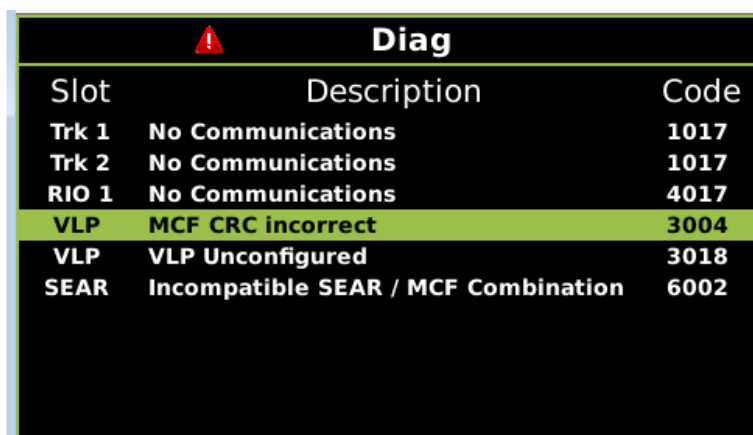

Figure 7-10 Diagnosis Message

7.3.1.2 Diagnostic Log

The Track Diagnostic and Diagnostic View windows show diagnostics messages that are currently present in the system. The DTC provides a time-stamped log of diagnostic message. This log will show when a diagnostic message was first present and then when it cleared.

To see previous diagnostic messages that may have appeared but were subsequently cleared, select the **Diagnostic Log** entry (4) from the “Diags & Reports” screen as shown in Figure 7-11.

The diagnostic log resides in the Display Module. The events in the diagnostic log are date and time stamped to indicate when the event occurred.

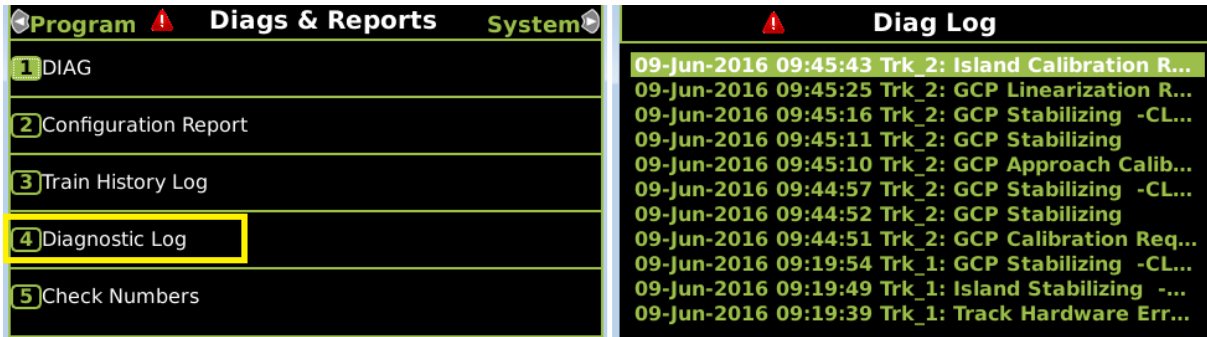

Figure 7-11 Diagnostic Log

7.3.1.3 Event Log

The Event log resides in the Display Module. The events in the Event log are date and time stamped to indicate when the event occurred. The Event log provides detailed information about each car detected.

The information provided includes:

- EZ levels
- EX levels
- Distance recordings
- Speed recordings

An event log of a typical train move is shown in the following example.

Example Event Log

BEE7	19-Mar-2021	11:42:44.00	CPU3	DTC1	CPU:VLP	STAT	Track 3	Train Present		
0E8F	19-Mar-2021	11:42:44.00	CPU3	DTC1	CPU:VLP	STAT	Track 3	EZ:1	EX: 96	CHK: 2
A046	19-Mar-2021	11:42:46.19	CPU3	DTC1	CPU:VLP	STAT	Track 3	EZ: 4	EX: 96	Dist 36 Spd: 7.00 ft/sec
6BA0	19-Mar-2021	11:42:48.98	CPU3	DTC1	CPU:VLP	STAT	Track 3	EZ: 7	EX: 96	Dist 58 Spd: 8.01 ft/sec
911D	19-Mar-2021	11:42:51.78	CPU3	DTC1	CPU:VLP	STAT	Track 3	EZ: 10	EX: 96	Dist 81 Spd: 8.01 ft/sec
86F3	19-Mar-2021	11:42:54.97	CPU3	DTC1	CPU:VLP	STAT	Track 3	EZ: 13	EX: 96	Dist 107 Spd: 8.00 ft/sec
8E4F	19-Mar-2021	11:42:57.77	CPU3	DTC1	CPU:VLP	STAT	Track 3	EZ: 16	EX: 96	Dist 128 Spd: 8.00 ft/sec
871F	19-Mar-2021	11:43:00.38	CPU3	DTC1	CPU:VLP	STAT	Track 3	EZ: 19	EX: 96	Dist 151 Spd: 8.00 ft/sec
7D20	19-Mar-2021	11:43:03.17	CPU3	DTC1	CPU:VLP	STAT	Track 3	EZ: 22	EX: 96	Dist 171 Spd: 8.00 ft/sec
E822	19-Mar-2021	11:43:05.97	CPU3	DTC1	CPU:VLP	STAT	Track 3	EZ: 25	EX: 96	Dist 195 Spd: 8.00 ft/sec
8E38	19-Mar-2021	11:43:08.56	CPU3	DTC1	CPU:VLP	STAT	Track 3	EZ: 28	EX: 96	Dist 215 Spd: 7.09 ft/sec
288C	19-Mar-2021	11:43:11.75	CPU3	DTC1	CPU:VLP	STAT	Track 3	EZ: 31	EX: 96	Dist 240 Spd: 7.09 ft/sec
1E40	19-Mar-2021	11:43:14.55	CPU3	DTC1	CPU:VLP	STAT	Track 3	EZ: 34	EX: 96	Dist 264 Spd: 7.09 ft/sec
65CF	19-Mar-2021	11:43:17.34	CPU3	DTC1	CPU:VLP	STAT	Track 3	EZ: 37	EX: 96	Dist 284 Spd: 7.08 ft/sec
342F	19-Mar-2021	11:43:19.93	CPU3	DTC1	CPU:VLP	STAT	Track 3	EZ: 40	EX: 96	Dist 306 Spd: 7.09 ft/sec
AAFA	19-Mar-2021	11:43:23.13	CPU3	DTC1	CPU:VLP	STAT	Track 3	EZ: 43	EX: 96	Dist 332 Spd: 7.09 ft/sec
F5F7	19-Mar-2021	11:43:25.92	CPU3	DTC1	CPU:VLP	STAT	Track 3	EZ: 46	EX: 96	Dist 354 Spd: 7.08 ft/sec
D6EA	19-Mar-2021	11:43:28.74	CPU3	DTC1	CPU:VLP	STAT	Track 3	EZ: 49	EX: 96	Dist 373 Spd: 7.08 ft/sec
4474	19-Mar-2021	11:43:31.91	CPU3	DTC1	CPU:VLP	STAT	Track 3	EZ: 52	EX: 96	Dist 399 Spd: 7.08 ft/sec
53BA	19-Mar-2021	11:43:34.71	CPU3	DTC1	CPU:VLP	STAT	Track 3	EZ: 55	EX: 96	Dist 422 Spd: 7.08 ft/sec
EEB4	19-Mar-2021	11:43:37.30	CPU3	DTC1	CPU:VLP	STAT	Track 3	EZ: 58	EX: 96	Dist 440 Spd: 7.07 ft/sec
C78C	19-Mar-2021	11:43:40.49	CPU3	DTC1	CPU:VLP	STAT	Track 3	EZ: 61	EX: 96	Dist 465 Spd: 7.07 ft/sec
4A5E	19-Mar-2021	11:43:43.29	CPU3	DTC1	CPU:VLP	STAT	Track 3	EZ: 64	EX: 96	Dist 490 Spd: 7.07 ft/sec
8C35	19-Mar-2021	11:43:46.49	CPU3	DTC1	CPU:VLP	STAT	Track 3	EZ: 67	EX: 96	Dist 515 Spd: 7.07 ft/sec
A0FE	19-Mar-2021	11:43:49.29	CPU3	DTC1	CPU:VLP	STAT	Track 3	EZ: 70	EX: 96	Dist 530 Spd: 7.05 ft/sec
59F2	19-Mar-2021	11:43:51.88	CPU3	DTC1	CPU:VLP	STAT	Track 3	EZ: 73	EX: 96	Dist 557 Spd: 7.07 ft/sec
D92D	19-Mar-2021	11:43:55.07	CPU3	DTC1	CPU:VLP	STAT	Track 3	EZ: 76	EX: 96	Dist 580 Spd: 7.05 ft/sec
1528	19-Mar-2021	11:43:58.27	CPU3	DTC1	CPU:VLP	STAT	Track 3	EZ: 79	EX: 96	Dist 603 Spd: 7.04 ft/sec
1246	19-Mar-2021	11:44:01.47	CPU3	DTC1	CPU:VLP	STAT	Track 3	EZ: 82	EX: 96	Dist 626 Spd: 7.03 ft/sec
A7F9	19-Mar-2021	11:44:04.66	CPU3	DTC1	CPU:VLP	STAT	Track 3	EZ: 85	EX: 96	Dist 647 Spd: 7.01 ft/sec
A859	19-Mar-2021	11:44:07.85	CPU3	DTC1	CPU:VLP	STAT	Track 3	EZ: 88	EX: 96	Dist 668 Spd: 6.09 ft/sec
70CD	19-Mar-2021	11:44:11.05	CPU3	DTC1	CPU:VLP	STAT	Track 3	EZ: 91	EX: 96	Dist 688 Spd: 6.06 ft/sec
4ABB	19-Mar-2021	11:44:14.64	CPU3	DTC1	CPU:VLP	STAT	Track 3	EZ: 94	EX: 96	Dist 711 Spd: 6.02 ft/sec
95B7	19-Mar-2021	11:44:18.44	CPU3	DTC1	CPU:VLP	STAT	Track 3	EZ: 97	EX: 96	Dist 735 Spd: 6.01 ft/sec
E067	19-Mar-2021	11:44:22.44	CPU3	DTC1	CPU:VLP	STAT	Track 3	EZ: 100	EX: 96	Dist 756 Spd: 5.07 ft/sec
6D43	19-Mar-2021	11:45:07.15	CPU3	DTC1	CPU:VLP	STAT	Track 3	No Train Present		

This log contains the following information:

- A train (car) is detected in the approach at 11:42:44.
- The car rolls away from the track wire feed points and the log shows the increasing EZ, the distance in feet, and the speed.
- The last event of the train move shows no train present at 11:45:07, no outbound train movement is seen.

7.3.2 Maintenance Call Output

(LED #1 on CPU Module)

The maintenance call output itself is not used in DTC applications, however the LED indicating its state (CPU LED #1) may be useful in troubleshooting. When the DTC system is healthy, the maintenance call output LED #1 is On. The LED will go off when:

- CPU unhealthy (e.g., MCF CRC incorrect).
- Track card unhealthy.
- CPU not in communication with a track module that is meant to be present.
- Track card requires calibration.

7.3.3 Transfer Output

(LED #2 on CPU Module)

In the DTC, there is no transfer module as this is not a redundant system. Transfer output is used as another indication of the health of the system and will behave the same as the maintenance call output.

7.4 TROUBLESHOOTING

On the Display:

- A red triangle appears on the track status line if a diagnostic message is present.

On the individual modules:

- Health LEDs on all modules (CPU, Track, RIO are flashing slowly (1HZ).
- Transfer Module display is not counting down.
- Power LEDs on all modules are on and steady.

On the CPU Module:

- CPU LED 1 and 2 are on, indicating all expected modules are healthy
- CPU LED 1 and 2 are off, indicating one or more modules are unhealthy

If the system has detected a problem, use the System Diag screen or the Track Diagnostics to locate the problem.

Refer to the Trackside Troubleshooting Flow Chart, Figure 7-13, to assist in system and track problem diagnosis.

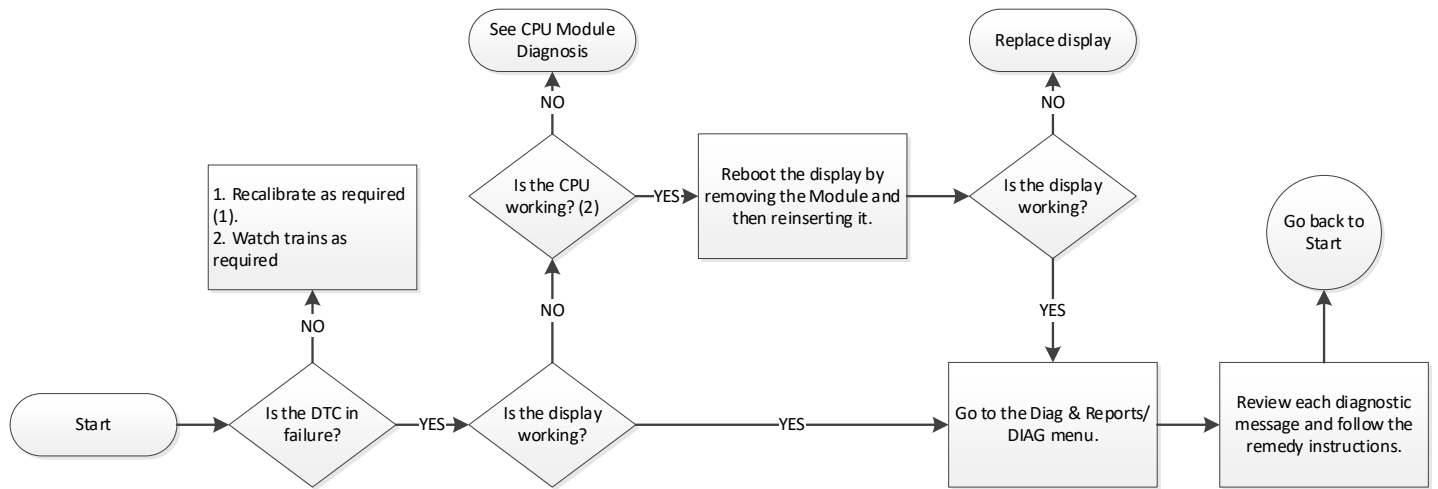

Notes:
 1. See Module Recalibration Requirements
 2. On the CPU Module, check that CP HEALTH and VLP HEALTH LEDs are flashing at 1 Hz rate.

Figure 7-12 CPU Troubleshooting Flow Chart

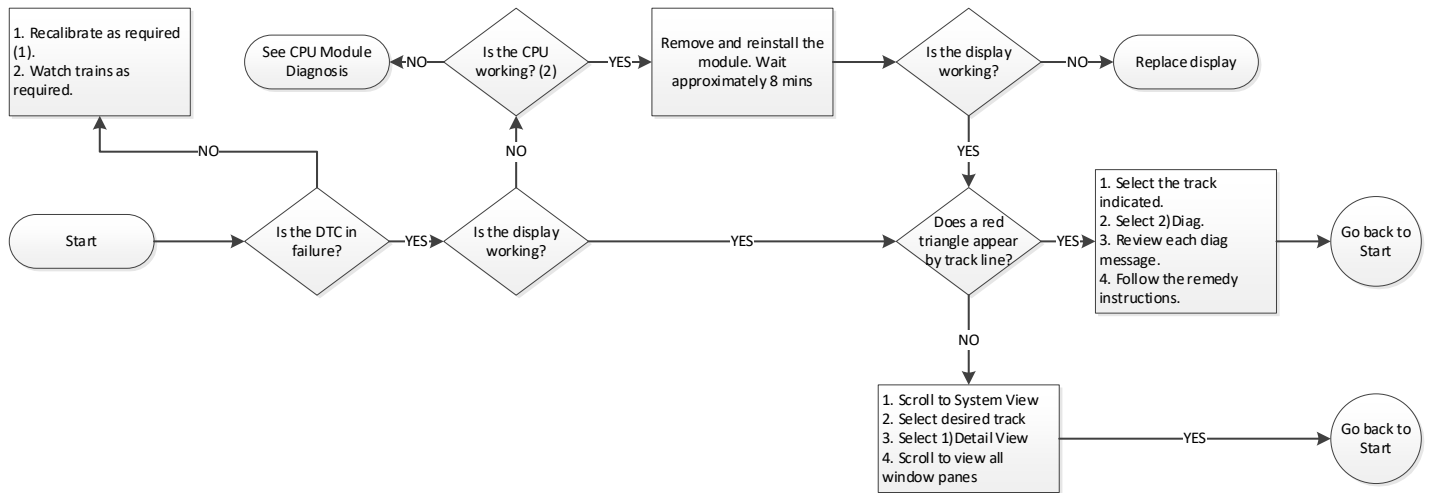

Notes:
 1. See Module Recalibration Requirements Tables.
 2. On the CPU Module, check that CP Health and VLP HEALTH LEDs are flashing at 1 Hz rate.

Figure 7-13 Trackside Troubleshooting Flowchart

7.4.1 Track Recalibration Requirements

The Track Module calibration requirements for new installations and GCP modules already in service can be determined by observing the following:

- Track Module Four-Character display shows one of the following indications:
 - GCAL
 - GAPP
 - GLIN
- System View screen on the Display Module shows one of the following indications:
 - GCP Cal Req
 - App Cal Req
 - Lin Cal Req

WARNING**WARNING**

RECALIBRATION OF AN IN-SERVICE TRACK MODULE SHOULD BE DONE ONLY:

- **WHEN A FAILED TRACK MODULE IS REPLACED.**
- **AFTER TRACK, BOND, COUPLER OR SHUNT RELATED PROBLEMS ARE INVESTIGATED AND CORRECTED.**

NOTE**NOTE**

Removal of power from the DTC case is not required before removing or installing modules.

NOTE**NOTE**

If the CPU Module MCF is changed, complete programming and recalibration is required.

7.4.2 Module Replacement Recalibration Requirements

The recalibration requirements due to the replacement of a module are shown in Table 7-12.

Table 7-12 Recalibration Requirements Due to Module/Chassis Replacement

Module/Assembly Replacement		Calibration Required			Reprogramming Required	Notes
		GCP CAL	GCP APP	GCP LIN		
A80903	CPU	No	No	No	No	1. For track with changed A80418 2. May be bypassed using BYPASS button instead of the START button in calibration procedure 3. Plug-in located on chassis behind CPU Module. Requires same MCF as previously in use.
A40418	Track	Yes ¹	Yes/No ²	Yes/No ²	No	
A80485	Display	No	No	No	No	
A80438-2	ECD ³	No	No	No	Yes	
N/A	Chassis	Yes	Yes	Yes	Yes	

7.4.3 Program Changes Procedure Requirements

The DTC System program changes that require track recalibration are indicated in Table 7-13.

Table 7-13 Programming Changes Recalibration Requirements

Program Changes	Calibration Required			Reprogramming Required	Notes
	GCP CAL	GCP APP	GCP LIN		
Increased Number of Tracks	Yes ¹	Yes ¹	Yes ¹	Yes ¹	1. For added tracks only 2. For tracks with new frequencies 3. For changed tracks only 4. For all tracks 5. Complete re-programming required 6. Calibration is only required after a set to default if the GCPs are subsequently programmed to a different frequency than previously set. 7. Can be bypassed. 8. In general DTC calibration is not required when software is updated. However, in some cases due to the nature of the change, it may be necessary to force a recalibration, in this case the module will show that calibration is required after the new software has been loaded. Approach and Linearization can be bypassed after GCP calibration has been performed.
Track Frequency Change	Yes ²	Yes ²	Yes ²	No	
Application changed from: Unidirectional to Sim Bidirectional or Sim Bidirectional to Unidirectional	Yes ³	Yes ³	Yes ³	No	
Transmit Level Changed from Medium to High or High to Medium					
Approach Length Changed					
Set to Default Selected ⁶	Yes ⁴	Yes ⁴	Yes ⁴	Yes ⁵	
Track MEF Changed	No ⁸	No ⁷	No ⁷	No	
Other MEFs Changed	No	No	No	No	
System MCF Changed	Yes	Yes	Yes	Yes	

7.4.4 Recalibration Due to Track Equipment Changes

Changes made to the existing track equipment that require track recalibration are shown in Table 7-14.

NOTE	NOTE
	Approach length in Program menu must be changed to reflect the new approach length prior to start of track calibration.

Table 7-14 Recalibration Requirements Due to Track Equipment Changes

Program Changes	Calibration Required			Notes
	GCP CAL	GCP APP	GCP LIN	
Hardwire Termination Shunt Changed	Yes	No	No	1. For changed tracks only 2. Calibration can be bypassed
Hardwire Termination Shunt Moved to New Location	Yes ¹	Yes ¹	Yes ¹	
DTC Track Wire(s) Replaced	Yes ¹	No ²	No ²	

7.4.5 Track Module Diagnostics

Table 7-15 may be used as an aid in diagnosis of Track Module Problems.

Table 7-15 Diagnosing Track Module Problems

Display		Description	Cause	Remedy
Panel	Diag			
RECV	GCP Recovering (Diag1000)	30 sec. recovery time-out	Clearing of system error	Wait
GSTB	GCP Stabilizing (Diag1001)	20 sec. stabilization period prior to start of normal operation.	System startup	Wait

Table 7-16 Diagnosing Track Module Problems

Display		Description	Cause	Remedy
Panel	Diag			
LWEX	Low EX (Diag1003)	Low track ballast resistance detected.	Salted crossing	Use a lower GCP frequency.
			Poor drainage at crossing	Temporarily shorten the approach (see WARNING)
			Mud or other contaminants within ballast	Verify EX Adjust (see Table 7-8).
			Low ballast	Determine cause of low ballast and compensate
			Broken rail	Repair broken rail
			Low ballast and high resistance bond	Repair high resistance bond
			Low ballast and defective insulated joint coupler	Replace defective insulated joint coupler
RXEX	Receive Wire EX Error (Diag1005)	Transmit and receive wires are out of phase Generally observed at cutover	The receive and transmit wires are connected to the wrong rail (mis-phased)	Change the track wire connection so that: <ul style="list-style-type: none"> • T1 & R1 are connected to rail 1 • T2 & R2 are connected to rail 2
GMXT	Transmitter Error (Diag1011)	Transmitter cannot maintain a constant current	All installation: <ul style="list-style-type: none"> • High resistance or open transmit track wire • High resistance or open track wire rail connection 	Locate and repair open transmit wires or high resistance transmit wires connections.
			Unidirectional installations only: <ul style="list-style-type: none"> • Open termination • Open coupler • Open bond 	Locate and repair: <ul style="list-style-type: none"> • Open termination • Open coupler • Open bond
GNOS	GCP Noise Error (Diag1205)	Too much noise on track to predict properly	The track signal received by the track module is too noisy and saturating the hardware	a) Check for sources of noise b) If none found, replace the track module

Display		Description	Cause	Remedy
Panel	Diag			
GFRQ	No GCP Frequency Selected (Diag1012)	No track frequency set	MS/GCP Operation has been programmed as ON, but no GCP frequency has been selected	Select a GCP frequency from the GCP: track n program menu
GRCV	Receiver Error (Diag1014) Or (Diag1015)	Track Module internal receiver channels differ	Unacceptable difference between the redundant receivers on the Track is detected	Replace Track Module
UCFG	No Communications (Diag1017)	No communication to a Track Module.	Track Module is not communicating with the CPU.	Verify that a module is appropriate slot
				Replace the module if the Track Module is continuously rebooting. <ul style="list-style-type: none"> • BOOT displays on four-character display at one minute (approximate) intervals. If the Track Module is not continuously rebooting determine if UCFC is shown on the module's display. <ul style="list-style-type: none"> • If only this module displays UCFG, replace it • If all Track Modules display UCFG replace the CPU Module.

Table 7-17 Diagnosing Track Module Problems

Display		Description	Cause	Remedy
Panel	Diag			
GHWR	Track Hardware Error (Diag1019)	Track Hardware Error	This occurs when the Track Module detects that its hardware is not operating correctly	Replace the module
GCAL	GCP Calibration Required (Diag1020)	GCP Calibration Required	<p>The Track Module is uncalibrated. A Track Module reverts to its uncalibrated state when the:</p> <ul style="list-style-type: none"> • Track Module is replaced • MCF software is changed • Template is set to default, or a new template is selected • Track Frequency is changed • Approach distance is changed • Transmit level is changed • Directional (bi/uni) mode is changed 	Access the appropriate Calibration Select Window and calibrate the GCP as described in Table 6-3.
GAPP	GCP Approach Calibration Required (Diag1021)	GCP Approach Calibration Required	<p>Approach is uncalibrated An approach reverts to its uncalibrated state when the:</p> <ul style="list-style-type: none"> • GCP is recalibrated • Track Module is replaced • Template is set to default or new template is selected • Programmed approach distance is changed • MCF is changed 	<p>Access the appropriate GCP Calibration Window</p> <ul style="list-style-type: none"> • If the computed approach distance is correct, select the BYPASS button • If the computed approach distance is known for this track from a previous calibration, enter the correct value by selecting the EDIT button. • If the computed approach distance is incorrect and is unknown, perform the approach calibration as described in Table 6-5.

Display		Description	Cause	Remedy
Panel	Diag			
GLIN	GCP Linearization Required (Diag1022)	GCP Linearization Calibration Required	<p>Linearization is uncalibrated Linearization reverts to its uncalibrated state when the:</p> <ul style="list-style-type: none"> • GCP is recalibrated • Track Module is replaced • Template is set to default or a new template is selected • Programmed approach distance is changed • MCF is changed 	<p>Go to the Setup Track Linearization Screen.</p> <ul style="list-style-type: none"> • If the linearization value is correct, select the BYPASS button. • If the linearization value is known for this track from a previous calibration, enter the correct value by selecting the EDIT button. • If the linearization value is incorrect or not known perform a linearization calibration as described in Table 6-6.
GSWR	Software Compatibility Error (Diag1201)	Software is incompatible between Track Card MEF and CPU MCF	The software (MEF) in the Track Card is incompatible with the MCF running in the CPU	Install: Latest track Module MEF Latest MCF
GXMT	Transmitter Error (Diag1011)	Transmitter cannot maintain a constant current	<p>All installations:</p> <ul style="list-style-type: none"> • High resistance or open transmit track wire • High resistance or open track wire rail connection 	Locate and repair open transmit wires or high resistance transmit wires con
			<p>Unidirectional installations only:</p> <ul style="list-style-type: none"> • Open termination • Open coupler • Open bond 	Locate and repair: <ul style="list-style-type: none"> • Open termination • Open coupler • Open bond
RECV	GCP Recovering (Diag1000)	30 sec recovery time-out	Clearing of system error	Wait

7.4.6 Diagnostics Log

The diagnostic log provides a time and date stamp of all previous errors. Scroll to “Diags & Reports”, select **3) Reports** and **Logs > 2) Logs > then Diagnostic Log**. Use the scrolling arrows to scroll to the Start Date, then select **Enter**. Select the date by using the arrows to select the **Start Date** and then the **Start Time**. Finally, select **Show Diagnostic Log**.

- Can be used to provide important information for intermittent track or equipment problems.
- Log is stored in the Display Module.
- Captures events only while the Display Module is connected to the GCP.
- Can be cleared by maintainer after being reviewed.

Refer to the Trackside Troubleshooting Flow Chart (Figure 7-13) to assist in system and track problem diagnosis.

7.4.7 CPU Module Diagnostics

Use Table 7-18 to aid in the diagnosis of CPU Module Problems. The normal sequence of messages seen on the four character display when a CPU III is booting up is shown below:

CPU3 > Boot > Init > E087 > ICHK > CP MEF > VLP MEF > GCP 5k MCF

If a CPU III is inserted into a system that does not have the MCF loaded, it will need to load the MCF from the ECD, in this case the boot up message sequence is shown below:

CPU3 > Boot > Init > E087 > ICHK > CRC UCFG > NRBT > Loading MCF > Burning MCF > DONE > Boot > IP : Laptop > Init > ICHK > CP MEF > VLP ME > GCP 5k MCF

Note the E087 may or may not be present in the sequence above.

NOTE

NOTE

If the CPU III has been unpowered for more than a week, and is then inserted into a system, the boot up sequence may show the following:
CPU3 > Boot > Init > E087 > ICHK > CRC.. UCFG.. ERR ..ECD

In this case, leave the CPU III installed in the system with power on for 1 minute, then remove the CPU III module and reinsert it. It should boot up normally displaying one of the first two sequences shown above.

Table 7-18 Diagnosing CPU Module Problems

Display		Description	Cause	Remedy
Panel	Diag			
CAP	MCF Capability Error (Diag3016)	The CPU is not capable of running this MCF	Usually occurs when using a recent MCF on an old CPU	Purchase a CPU with a higher capability or obtain an MCF requiring lower capability CPU
CCN	CCN Incorrect (Diag3021)	The CCN is incorrect for the configuration	After loading a configuration file, the CCN is incorrect	Reload the configuration file and repower the CPU card. If error continues, perform Set to Default and reprogram the unit.
CIC	CIC Access Error (Diag3022)	CPU unable to access data stored in CIC	If CIC access error is on MAIN CPU	<ol style="list-style-type: none"> 1. Replace CPU with a different CPU running the same software versions. 2. If error clears, original CPU is bad; replace bad card. 3. If error does not clear, CIC is bad; replace CIC or DTC chassis.
CRC	MCF CRC incorrect (Diag3004)	The MCF CRC is incorrect for the current MCF	MCF CRC entered is incorrect (Diag 3004)	Reload MCF CRC
			MCF is corrupt (Diag 3003)	Reload MCF
			The executive (MEF) file is corrupt (Diag 3014)	Reload the MEF
CRPT	MCF Checksum Incorrect (Diag3003)	The MCF did not load correctly	The MCF is corrupt	Reload MCF
DFT	Default Values set (Diag3001)	Operating parameters have been set to default	New MCF has been loaded	Set the operating parameter
DFT	Vital Cfg Parm set to default (Diag3002)	Vital Cfg parameters have been set to default	New MCF has been loaded or UCN changed	Set the Vital Cfg parameters to the required values
DFT	Configuration set to default (Diag3017)	Configuration set to default	The configuration parameters have been set back to default due to either: <ul style="list-style-type: none"> • MCF change • Template change • User setting default 	Wait. The error will clear itself.
INIT	No VLP Comms (Diag3020)	The VLP/CP LED on the CPU card does not light	The VLP is rebooting or is in its Initial State and performing its initial checks. This may occur after a VLP reset, or after changing templates.	Wait for a minute for the VLP to power up. If the VLP does not power up, check to see if it is continuously rebooting by checking the VLP Health LED.

Display		Description	Cause	Remedy
Panel	Diag			
MCF	MCF Checks failed (Diag3005)	Verification of MCF data failed	The MCF is invalid	Obtain and load a valid MCF.
MCF	MCF Compatibility incorrect (Diag3013)	MCF and MEF are incompatible	The installed MCF is incompatible with the MEF software	Obtain compatible MCF or MEF software.
MOD	Module Type Error (Diag3006)	The MEF software is incompatible with the module hardware	The MEF is incompatible with this hardware	Reload a valid MEF for this hardware.
UCFG	VLP Unconfigured (Diag3018)	VLP is unconfigured and not communicating with I/O modules	Usually due to: <ul style="list-style-type: none"> • Incorrect MCF CRC • MCF not loaded • MCF not stored in ECD (ECD replaced) 	Check other diagnostic message for exact cause.

7.4.8 Troubleshooting Track Problems

The following sections describe how to find and correct common track problems.

7.4.8.1 Rail Bonds

High resistance bonds can be located as described in Procedure 7.1.

NOTE

NOTE

The EZ value must be above 15 for the bond test to be used.
 The EZ value must be greater than 15 for Procedure 7.1 to work.

Procedure 7.1 Rail Bond Tests

Step 1	Record the EX value with no shunt: _____
Step 2	Place a hardwire shunt at the 50% point of the approach.
Step 3	Record the EX value: _____
Step 4	<p>Note the difference in EX values recorded in steps 1 and 3.</p> <ul style="list-style-type: none"> EX always increases as a shunt is placed closer to the crossing. Whether the shunt is a train or hardwire, EX must increase. If the EX value recorded in step 3 is greater than the EX value in step 1, the bad bond is between the hardwire and the termination. If the EX value recorded in step 3 is lower than the EX value in step 1, the bad bond is between the hardwire and the crossing.
Step 5	<p>Continue placing the hardwire shunt closer or farther away from the starting point based on the value noted in step 4.</p> <ul style="list-style-type: none"> Where EX increases in value, the last bond passed in the defective bond.

7.4.8.2 Termination Shunts

Termination shunts can be tested as described in Procedure 7.2.

Procedure 7.2 Termination Shunts Tests

Step 1	Record the EZ value: _____
Step 2	Install a hardwire shunt across the termination.
Step 3	<p>Record the change in EZ: _____</p> <ul style="list-style-type: none"> If termination is hardwired, no EZ change should occur.

7.4.9 Low EX

A Low EX condition exists when EX is below 39.

7.4.9.1 At New Installations

If a Low EX condition is occurring at a cutover of a new installation, check the following:

- Defective bonds
- Missing battery choke in approaches
- Defective gauge rods or switch rods
- Open termination shunt

7.4.10 High EZ and Low EX History & Calibrated Approach

Review of the high EZ and low EX history (HEZ LEX) and the Computed Approach distance for a track can assist in troubleshooting efforts. The HEZ and LEX values are useful in determining when the EZ was high and when the EX was low.

To review the information:

- From the System View screen, select the number of the Track to review.
- When the Track “N” Options window opens, select 1) Detail View. The Module Details window opens.
- Press the Left Arrow once to view the screen showing the HEZ LEX. Record the HEZ value (_____) and the LEX value (_____).
- Press the Left Arrow three times more to view the screen showing the Computed Distance. Record the Computed Distance (_____).

The maintainer may reset the HEZ LEX information after review.

This Page Intentionally Left Blank

SECTION 8 SAFETY RELATED APPLICATION CONDITIONS

8.0 COMPATIBILITY

The hardware used in the DTC is common to the following systems: GCP 4000, GGP 5000, GCP3000+, and MS4000.

The DTC track module is designed to be incompatible with operation in a grade crossing system. If a track module containing the DTC specific software is put into one of these systems, it will cause the system to enter a restrictive mode (activate crossing). The track module will then show VERS on its display.

The DTC MCF is incompatible with use in a grade crossing system. It does not have the ability to set outputs to non-restrictive states or communicate with SSCC3i modules.

The CPU III software is compatible with both DTC and grade crossing applications, so the CPU III module may be used interchangeably in both types of system.

The Display software is compatible with both DTC and grade crossing applications, so the Display module may be used interchangeably in both types of system.

8.1 DTC HAZARDS

A hazard of the yard application is that the Yard control system sends cars in at too high a speed, which results in them coupling too fast and cause damage to the car's contents or the cars themselves.

The DTC system can cause this hazard if it reports a Distance that is too high, or a speed that is too low to the Yard control system.

The DTC provides a non-vital indication of speed. This measurement of speed can be adversely influenced by noise or poor shunting. Though the GCP attempts to correct for these, this cannot be guaranteed. The Yard control system should provide mitigations to this by performing reasonableness checks on the reported distance and car speed.

Changes in ballast conditions may cause the DTC to report a higher or lower distance to the end of the last car, though this is unlikely to change more than 10%.

This Page Intentionally Left Blank