

SIEMENS

DRY TYPE TRANSFORMERS

NOTES:

1. ALL UNITS ARE UL LISTED AND ARE DESIGNED IN ACCORDANCE WITH ANSI C89.2 AND NEMA ST-20 STANDARDS.
2. THESE TRANSFORMERS UTILIZE A UL RECOGNIZED 220°C INSULATION SYSTEM, TEMPERATURE RISE AS INDICATED IN THE TABLE.
3. TRANSFORMERS ARE DRY TYPE, CLASS AA, VENTILATED ENCLOSURE FOR INDOOR USE. OPTIONAL WEATHER KITS ARE AVAILABLE FOR ADAPTING THE UNIT FOR 3R USE WITHOUT VOIDING THE UL LABEL.
4. FOR LIFTING OTHER THAN WITH FORK TRUCK, REMOVE TOP COVER AND USE CORE CLAMPS FOR 112.5KVA & UP.
5. PAINT COLOR IS ANSI #61 GRAY.
6. FULL WIDTH COPPER ELECTROSTATIC SHIELD (OPTIONAL).
7. 6' REQUIRED CLEARANCE FROM THE WALLS.
8. HV/LV TERMINALS ARE TOP FRONT TERMINATED.

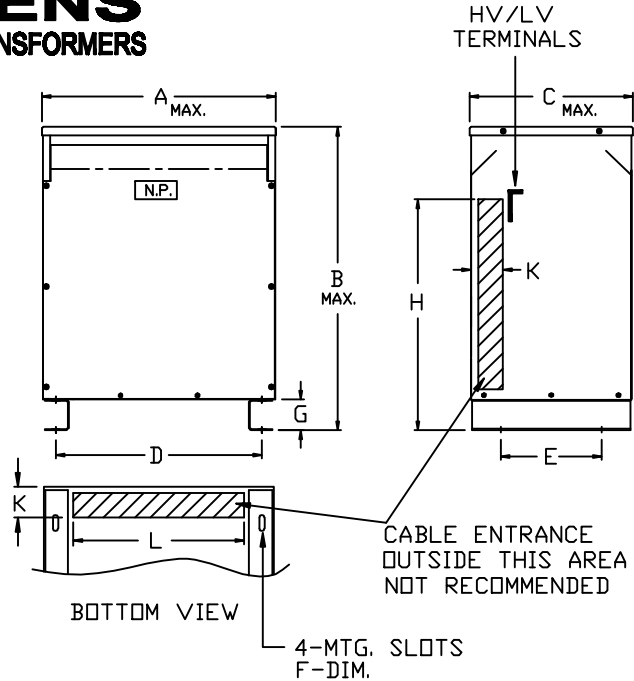

KVA	TEMP. RISE °C	NET WT. LBS.	DIMENSIONS IN INCHES									
			A	B	C	D	E	F	G	H	K	L
15	80	310	22.00	25.00	17.00	17.38	13.00	.56 x 1.13	3.00	13.00	3.00	15.00
30	80	425	25.00	28.00	18.50	20.75	14.50	.56 x 1.13	3.00	16.00	3.00	17.00
45	80	635	27.00	32.00	21.00	23.50	16.00	.56 x 1.13	3.00	18.00	3.00	20.00
75	80	850	29.00	38.00	23.00	25.50	18.00	.56 x 1.13	3.00	20.00	3.00	22.00
112.5	80	1035	33.00	42.00	26.00	29.50	21.00	.56 x 1.13	3.00	23.00	4.00	25.50
150	80	1350	35.00	46.00	30.00	31.50	25.00	.56 x 1.13	3.00	32.00	5.00	27.50
225	80	1675	35.00	52.00	30.00	31.50	25.00	.56 x 1.13	3.00	32.00	5.00	27.50
300	80	2150	48.00	60.00	33.00	42.00	27.00	.56 x 1.13	4.00	36.00	5.00	34.00
500	80	3150	52.00	72.00	40.00	34.00	42.00	.56 x 1.13	4.00	50.00	5.00	32.00
750	80	← N/A →										
1000	80	← N/A →										

KVA	QTY.	CATALOG NO.	VOLTAGE		TAPS	DRAWING
			PRIMARY	SECONDARY		
						<input type="checkbox"/> APPROVAL
						<input type="checkbox"/> RECORD
						<input type="checkbox"/> OTHER

CUST.	DWN. BY:	Siemens Industry, Inc.
	DATE:	
JOB	CHK. BY:	GENERAL PURPOSE TRANSFORMERS THREE-PHASE, 600 VOLTS CLASS, 60 HZ. K-FACTOR (1) RATED - ALUMINUM - TP1
P.O.	DATE:	
TIE	APVD. BY:	
S.O.	DATE:	DWG. NO. J-103
		REV. E DATE 08/09/10