



Room thermostats with LCD RDD100..

for heating systems

- Room temperature control
- Comfort, Economy and Protection mode
- 2-position control with On/Off control output
- Adjustable commissioning and control parameters
- Mains-powered AC 230 V (RDD100) or battery-powered DC 3 V (RDD100.1)

Use

The RDD100.. is used to control the room temperature in heating systems.

Typical applications:

- Apartments
- Commercial spaces
- Schools

For the control of the following pieces of equipment:

- Thermal valves or zone valves
- Gas or oil boilers
- Fans
- Pumps

Functions

- Room temperature control via built-in sensor
- Selection of operating mode with operating mode touchkey
- Display of current room temperature or setpoint in °C or °F
- Touchkey lock (manually)
- Setpoint lock
- Reloading factory settings for commissioning and control parameters

Temperature control

The RDD100.. acquires the room temperature with its built-in sensor and maintains the setpoint by delivering control commands. The switching differential is 1 K.

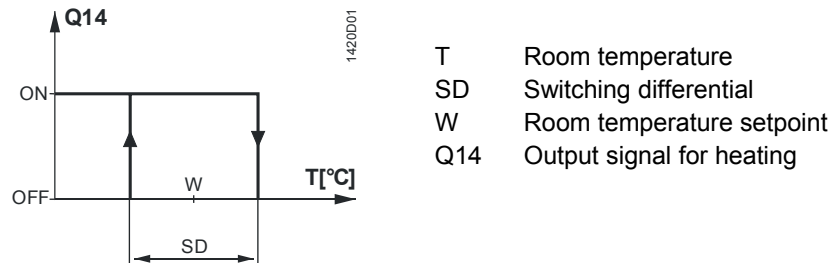

Type summary

Product No.	Stock No.	Features
RDD100	S55770-T275	Mains-powered AC 230 V
RDD100.1	S55770-T276	Battery-powered DC 3 V







Ordering

- When ordering, please indicate product No./stock No. and description
- Example:

Product No.	Stock No.	Description
RDD100	S55770-T275	Room thermostat

- Valve actuators must be ordered separately

Equipment combinations

Description		Product No.	Data Sheet
Electromotoric actuator		SFA21..	4863
Electrothermal actuator (for radiator valves)		STA23..	4884
Electrothermal actuator (for small valves 2.5 mm)		STP23..	4884
Damper actuator		GDB..	4634
Damper actuator		GSD..	4603
Damper actuator		GQD..	4604
Rotary damper actuator		GXD..	4622

Mechanical design

The room thermostat consists of 2 parts:

- Plastic housing which accommodates the electronics, the operating elements, and the room temperature sensor
- Mounting plate with screw terminals

The housing engages in the mounting plate and is secured with a screw.



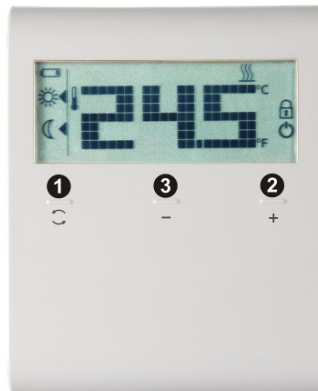





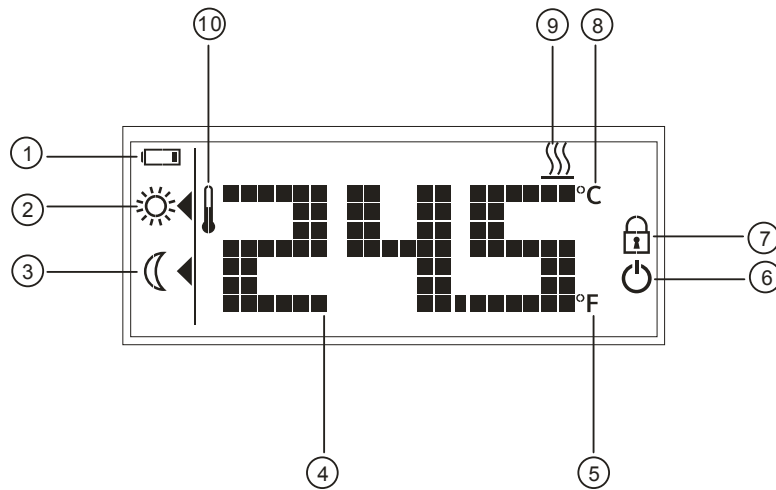

Operation and settings



- 1) Operating mode touchkey
- 2) Touchkey for increasing a value
- 3) Touchkey for decreasing a value

Display



#	Symbol	Description	#	Symbol	Description
1		Indicating that batteries need to be replaced (only with battery-powered version)	6		Protection mode (protection mode icon can be enabled via parameter settings).
2		Comfort mode	7		Touchkey lock activated
3		Economy mode	8		Room temperature in degrees Celsius
4		Display of room temperature, setpoint, etc.	9		Heating On
5		Room temperature in degrees Fahrenheit	10		Current room temperature

Mounting and installation notes

Do not mount the thermostat in niches or bookshelves, not behind curtains, not above or near heat sources, and not exposed to direct solar radiation. Mount about 1.5 m above the floor.

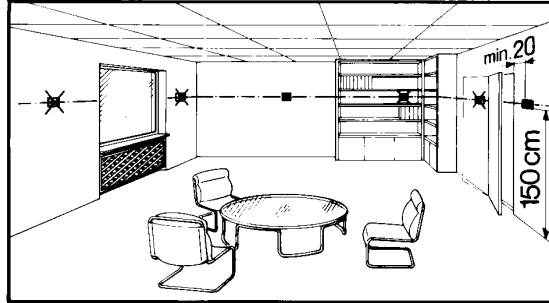

Mounting



- Mount the thermostat in a clean and dry location without direct air flow from heating/cooling equipment, and not exposed to drip or splash water

Wiring



See Mounting Instructions M1420 enclosed with the thermostat.

- Ensure that wiring, fusing and earthing comply with local regulations
- Correctly size the cables to the thermostat and the valve actuators
- Use only valve actuators rated for AC 24...230 V
- The AC 230 V mains supply line must have an external fuse or circuit breaker with a rated current of no more than 10 A
- Disconnect from power supply before removing the unit from its mounting plate

Commissioning notes

Commissioning

After power is applied, the thermostat carries out a reset during which all LCD segments flash, indicating that the reset was made correctly. After the reset, the thermostat is ready for commissioning by qualified HVAC personnel.

The control parameters of the thermostat can be set to ensure optimum performance of the entire system. Please refer to Operating Instructions CB1B1420, section "Do you want to change parameters?".

Sensor calibration

If the temperature on the display does not agree with the room temperature effectively measured, the temperature sensor can be recalibrated. For that purpose, adjust parameter P04.

Setpoint and setpoint lock

We recommend to review the setpoint range and setpoint lock (for public areas) using parameters P05...P08 and change them as needed to achieve maximum comfort and energy savings.

Touchpad scanning rate

Since the thermostat uses touch technology and to minimize battery power consumption, a parameter P21 (adjustable from 0.25 to 1.5 seconds) is implemented for the user to adjust. This function is only valid for the battery-powered version and the default value is 1 second.

This means that when, for a certain time, the user does not touch the touchpad, the unit operates in power saving mode and the touchpad is running at a scanning rate of 1 second.

(From the calculation – assuming 4 operations per day on the thermostat, the estimated 1-second scanning rate results in a battery life of 1 year. If the user increases the scanning rate, the batteries' life is extended.)

Change of batteries (only with battery-powered version)

If the battery symbol  appears, the batteries are almost exhausted and should be replaced. Use alkaline batteries type AAA.

Operating notes

The RDD100.. provides Comfort, Economy and Protection mode. The difference between Comfort and Economy mode is only the room temperature setpoint. The changeover between Comfort, Economy and Protection mode is made by pressing touchkey .

Comfort mode

When Comfort mode is activated, symbol  appears on the display. The setpoint (20 °C) can be readjusted by pressing touchkeys + and –.

Economy mode

When Economy mode is activated, symbol  appears on the display. The setpoint (16 °C) can be readjusted by pressing touchkeys + and –.

Protection mode

If the temperature falls below 5 °C, the unit automatically activates the heating output. The symbol  appears only, if the icon is enabled via parameter settings.

Maintenance notes

The thermostats are maintenance-free.

Disposal



In terms of disposal, the room thermostats are classified as electronic scrap conforming to the European Directive 2011/65/EU (WEEE) and must not be disposed of as unsorted domestic waste. The relevant national legal regulations must be complied with and the units must be disposed of via the appropriate channels. Local and currently valid legislation must be observed.

Technical data



Power supply

Operating voltage



- RDD100 at L - N AC 230 V +10/-15%
- RDD100.1 DC 3 V (2 x 1.5 V alkaline batteries AAA)

Frequency (RDD100) 50 Hz

Power consumption (RDD100) 4 VA

For battery life (RDD100.1), see below (alkaline batteries type AAA).

Battery life calculation is based on the touchpad scanning rate during idle time (assuming a user presses 4 touchkeys per day):

	Scanning rate 0.25 s	196 days battery life
	Scanning rate 0.50 s	278 days battery life
	Scanning rate 1.00 s	353 days battery life
	Scanning rate 1.50 s	388 days battery life
Control inputs	Control input Q11-Nx (Com)	
	Rating RDD100	(AC 24...230 V) max. 5(2) A min. 8 mA
Control outputs	Rating RDD100.1	(AC 24...230 V) max. 5(2) A min. 8 mA
	Control output Q12-Nx (NC contact)	
	Rating RDD100	(AC 24...230 V) max. 5(2) A min. 8 mA
	Rating RDD100.1	(AC 24...230 V) max. 5(2) A min. 8 mA
Function data	Control output Q14-Nx (NO contact)	
	Rating RDD100	(AC 24...230 V) max. 5(2) A min. 8 mA
	Rating RDD100.1	(AC 24...230 V) max. 5(2) A min. 8 mA
	Switching differential SD	1 K
	Comfort mode	20 °C (5...35 °C)
	Economy mode	16 °C (5...35 °C)
	Built-in room temperature sensor	
	Setpoint setting range	5...35 °C (Comfort/Economy mode)
	Accuracy at 25 °C	< ±0.5 K
	Temperature calibration range	±3.0 K
	Resolution of settings and displays	
	Setpoints	0.5 °C
	Temperature value displays	0.5 °C
Environmental conditions	Operation	As per IEC 60721-3-3
	Climatic conditions	Class 3K5
	Temperature	0...50 °C
	Humidity	<95% r.h.
	Transport	As per IEC 60721-3-2
	Climatic conditions	Class 2K3
	Temperature	-25...60 °C
	Humidity	<95% r.h.
	Mechanical conditions	Class 2M2
	Storage	As per IEC 60721-3-1
	Climatic conditions	Class 1K3
	Temperature	-25...60 °C
	Humidity	<95% r.h.
Norms and standards	CE conformity to	
	EMC directive	2004/108/EC
	Low voltage directive	2006/95/ EC
	 C-Tick conformity to	
	EMC emission standard	AS/NSZ 4251.1:1999
	 RoHS (Restriction of Hazardous Substances)	2011/65/EU
	Product standards	
	Automatic electrical controls for household and similar use	General requirements EN 60730-1 Particular requirements for temperature sensing controls EN 60730-2-9
	Electromagnetic compatibility	
	Emissions	EN 61000-6-3
	Immunity	EN 61000-6-2
	Safety class	II as per EN 60730-1, EN 60730-2-9
	Pollution class	II as per EN 60730
	Degree of protection of housing	IP30 as per EN 60529

General

Connection terminals for	Solid wires or prepared stranded wires 2 x 1.5 mm ² or 1 x 2.5 mm ² (min. 0.5 mm ²)
Weight	0.134 kg
Color of housing front	RAL9003

Connection diagrams

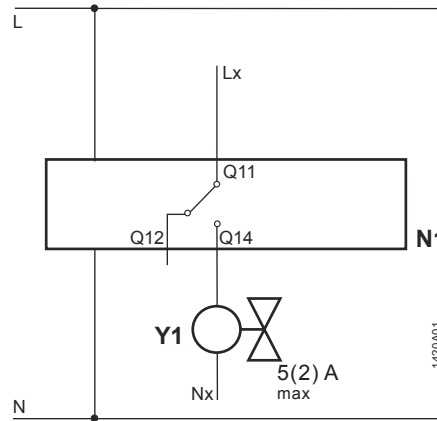

RDD100

- N1 Room thermostat
- Y1 Valve actuator
- L Live, AC 230 V
- N Neutral conductor, AC 230 V

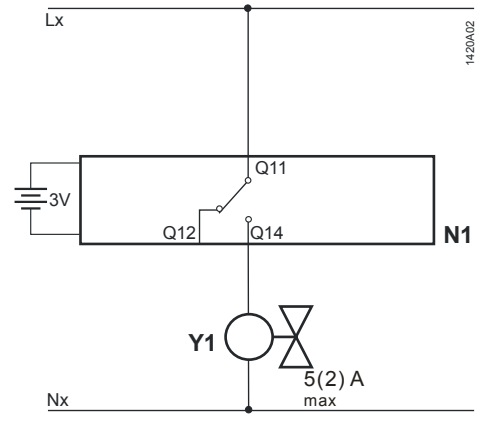

RDD100.1

- Lx Live, AC 24...230 V
- Q11, Q12 NC contact (for NO valves)
- Q11, Q14 NO contact (for NC valves)
- Nx Neutral conductor, AC 24...230 V

Application examples

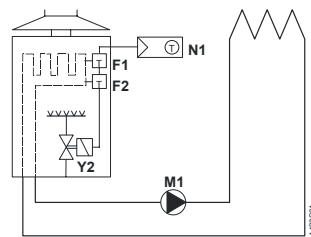

Room thermostat with direct control of a gas-fired wall-hung boiler

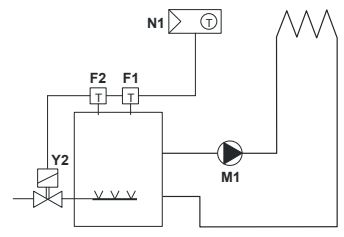

Room thermostat with direct control of a gas-fired floor-standing boiler

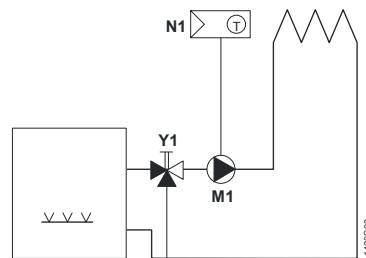

Room thermostat with direct control of a

heating circuit pump (precontrol by manual mixing valve)

F1	Thermal reset limit thermostat	N1	RDD100.. room thermostat
F2	Safety limit thermostat	Y1	Mixing valve with manual adjustment
M1	Circulating pump	Y2	Magnetic valve

Dimensions

All dimensions in mm

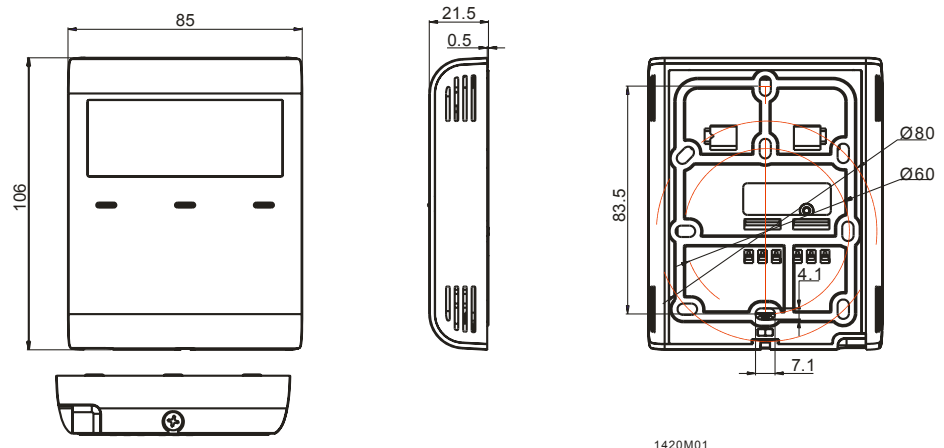

Remarks

Heating:

Because of the unavoidable self heating effects of the electrical current, any loads of more than 3 Amperes connected to the unit can influence the control behavior and temperature accuracy in a negative way.