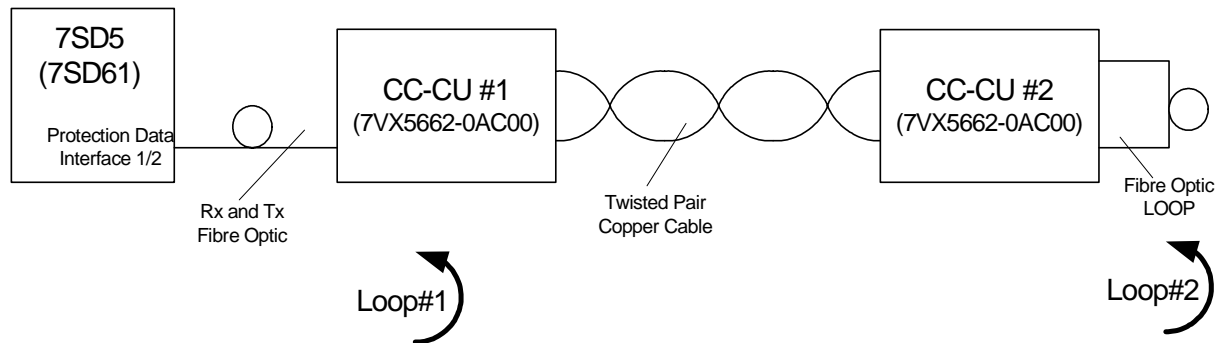

**Commissioning of the Protection Interface with Communication Converter Copper****Scope: Commissioning of the 7SD5 (7SD61)  
Protection Data Interface with  
Communication Converter Copper****Description:**

The figure above shows the 7SD5 (7SD61) with Protection Data Interface (PDI) \ Protection Interface (PI) for communication between the two line ends. During commissioning of both Protection Data Interface 1 and 2 the indicated loops may be used to check the data connections. The Protection Data Interface communication is tested with so called 'LOOP Tests'. During the loop tests the 7SD5 sends a telegram and expects reception of the same telegram. If an error occurs during the transmission the sent and received telegrams are not equal.

Loop1 tests the fibre optic between the 7SD5 and the CC-CU. Loop1 is implemented by a jumper setting in the CC-CU.

Loop2 is done by a 'short circuit' of the fibre optic at the second CC-CU. Loop2 includes the whole transmission line.

**Preconditions for running the Loop test:**

Before you run the loop tests both CC-CU must establish communication via the transmission link, this can be observed at the LED's of the converters (please refer to manual).

**Setting up the 'Hardware Test'**

Connect a normal DIGSI- Cable from your PC to the 7SD5 and start the COMMUNICATIONTEST.EXE – Program. The following window pops up.

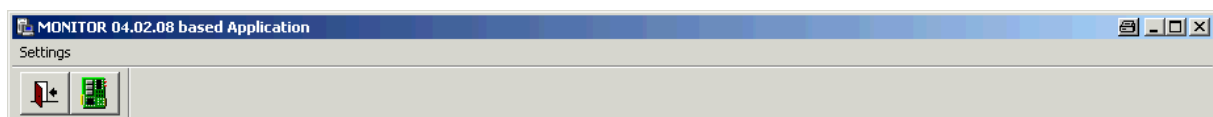

**Commissioning of the Protection Interface with Communication Converter Copper**

The COMMUNICATIONTEST.EXE – Program needs to communicate with the relay. Choose under ,Settings' → ,Serial Connection' the connected PC COM Port.

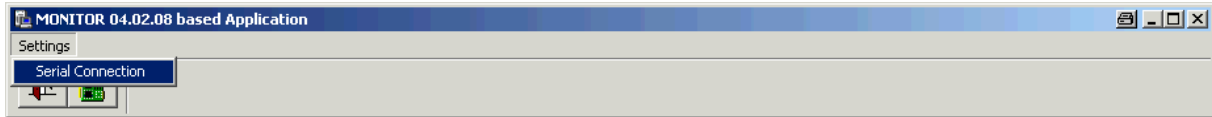

To start the Monitor Program press the ,Printed Circuit Board Button' (2<sup>nd</sup> Button from the left).

After a few second the device makes a RESET and the following window pop up on the PC screen.

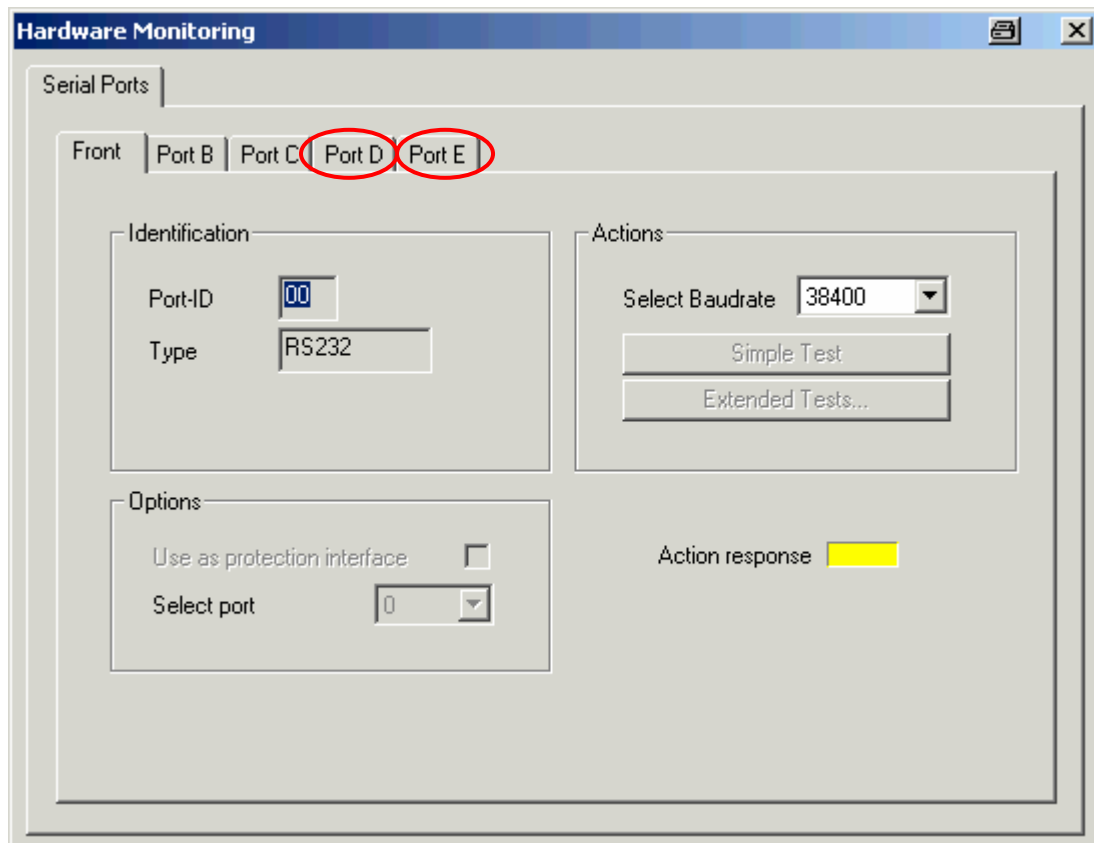

The Protection Data Interface is located at PORT D and PORT E at the 7SD5. For the 7SD610 it is always Port D. Choose the PORT you like to test.

**Commissioning of the Protection Interface with Communication Converter Copper**

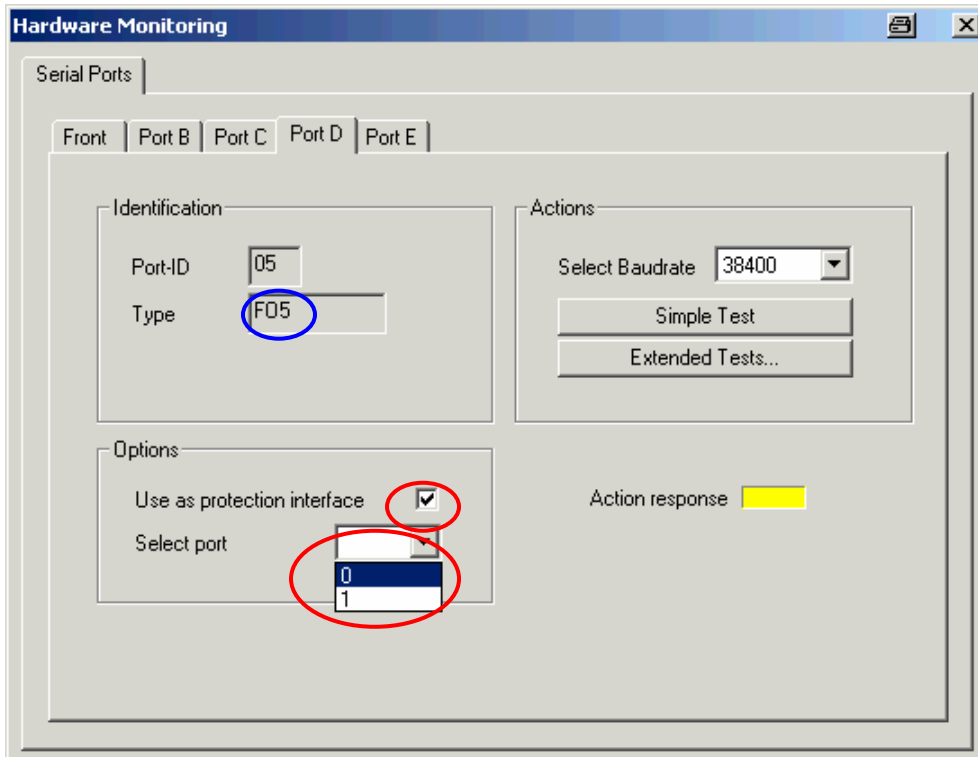

In the given test example the Protection Data Interface is located at relay Port D (F05). To run the LOOP Test you have to initialise the Protection Data Interface by clicking a ,check' at the 'Use as protection interface' and choosing a number (0 or 1, either will do) in the drop down menu.

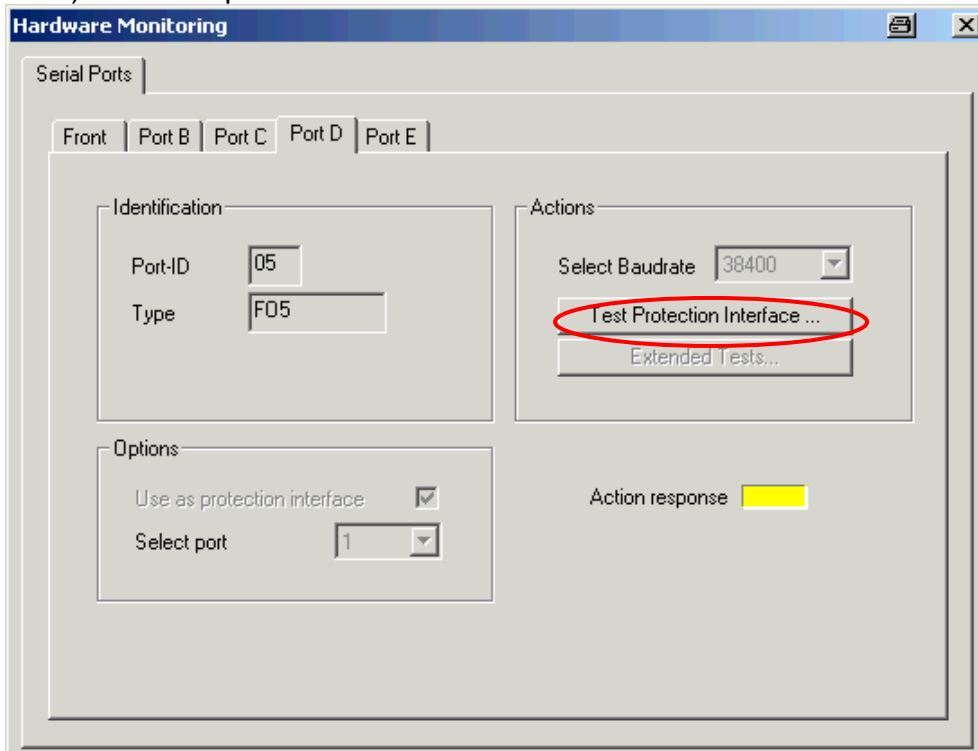

To start the test press the button 'Test Protection Interface'.The following figure shows the settings.

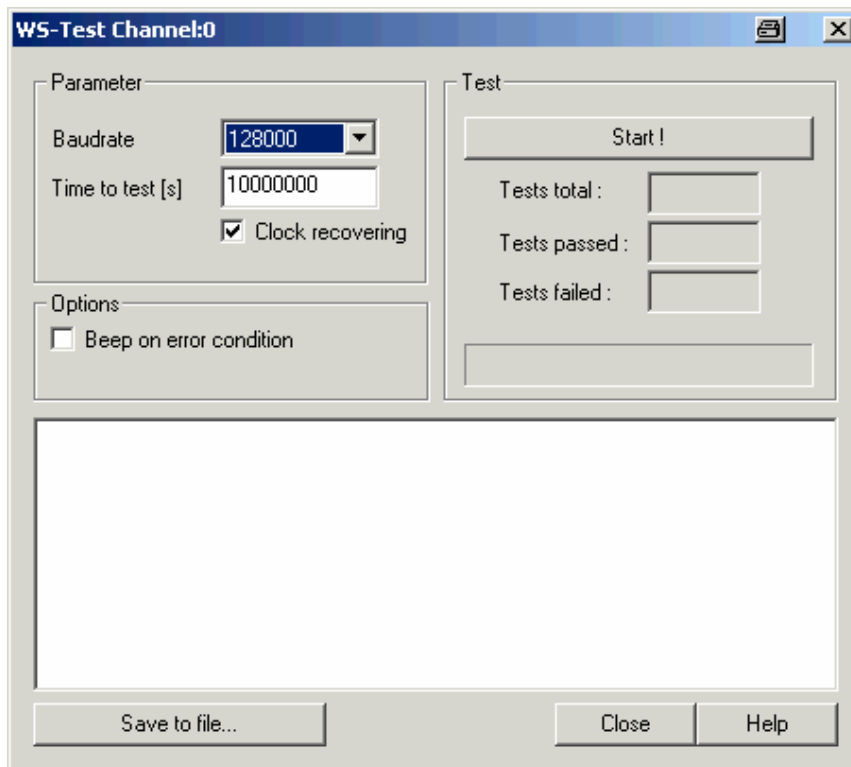
**Commissioning of the Protection Interface with Communication Converter Copper**

In this window some setting can be applied:

<i>Baudrate:</i>	Communication speed) for the CC-CU it is fixed to 128000
<i>Time to test [s]:</i>	Duration of the test in seconds
<i>Clock recovering:</i>	Activation of the clock recovering of the F05 – Module. For LOOP 1 test switch it off For LOOP 2 test switch it on (as shown)
<i>Beep:</i>	To have an acoustic alarm if an error occurs

**Commissioning of the Protection Interface with Communication Converter Copper**

By pressing the ,*Start*' button the relay starts to send telegrams with different content. After the parameterized time the relay stops automatically. The test can be interrupted by pressing the ,*Stop*' button

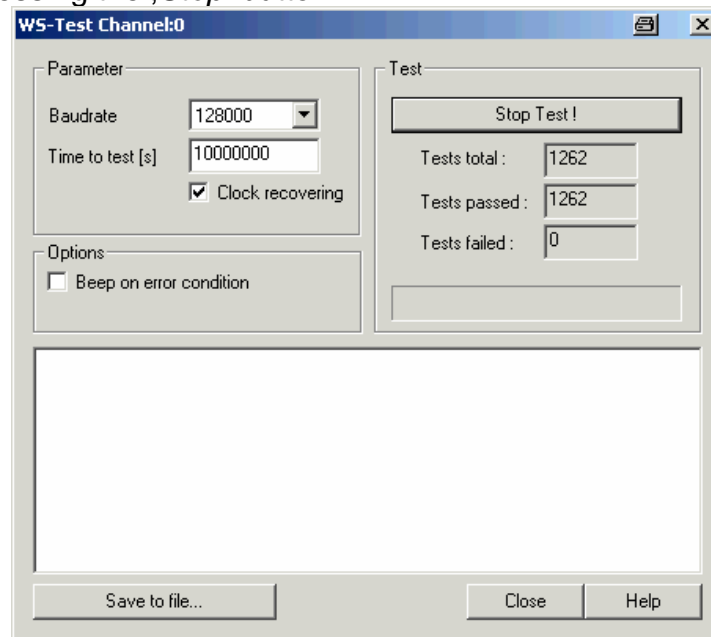

In this mode the relay expects a LOOP condition so the relay can compare the received telegram with the sent telegram.

In the box Test total / passed / failed the relay counts the total sent telegrams / the telegrams with no error and the telegrams with errors.

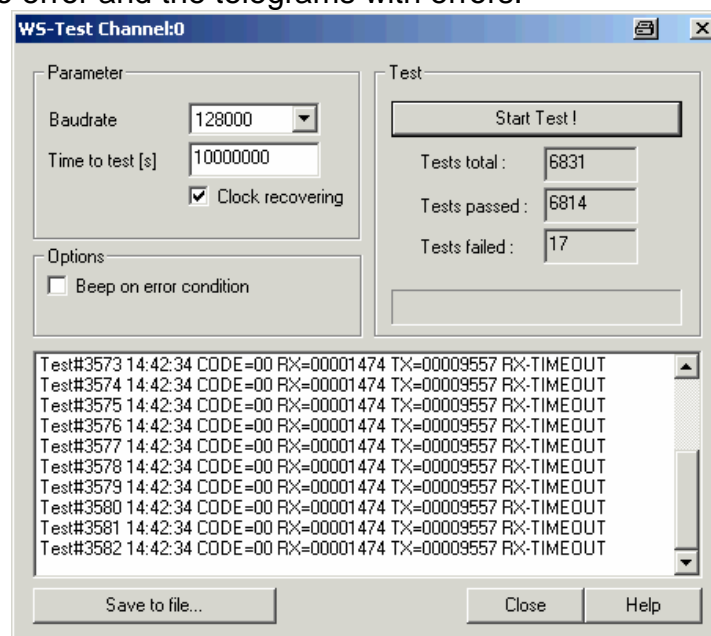

After pressing the '*Start*' button again the relay starts with a new test.

To get the relay back in its normal operation close the Monitor Program and switch the relay off and on again.

---

**Commissioning of the Protection Interface with Communication Converter Copper****Good and bad connection for the PDI / PI communication via the Communication converter Copper**

In general during the loop test no error telegram should be observed. The maximal acceptable error rate for the loop test is 1 to 2 telegrams within 2 minutes at an minimal observing time of 20 min. If during the first 5 minutes no telegram error is observed, the test can be successfully stopped.