

## contents

### Self Protected Motor Starters per UL 508 Type E 3RA6



**3RA61 / 3RA62 up to 32 A for mounting rail, surface, comb busbar, infeed system** Page

**Selection and ordering data**

- Direct start, Reversing duty 4/7
- Accessories 4/9-4/13



**3RA64 / 3RA65 up to 32 A for mounting rail, surface, comb busbar, infeed system** Page

**Selection and ordering data**

- Direct start, Reversing duty 4/8
- Accessories 4/9-4/13

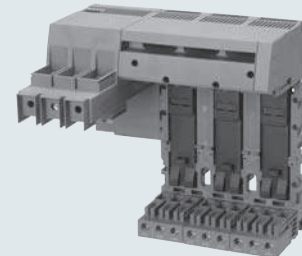

**3RA68 up to 100 A for 3RA6 direct and reversing starters** Page

**Selection and ordering data**

- Infeed Components 4/16-4/19
- Accessories 4/20-4/21

### Combination starters & starters for group installation 3RA1/3RA2



**3RA1/3RA2 up to 100 A for mounting rail and Fast Bus busbar systems** Page

**Selection and ordering data**

- Direct start 4/36-4/39
- Accessories 4/44-4/52

Technical data 4/53-4/58  
 Installation guidelines 4/59-4/68  
 Circuit diagrams 4/68  
 Dimension drawings 4/69-4/72

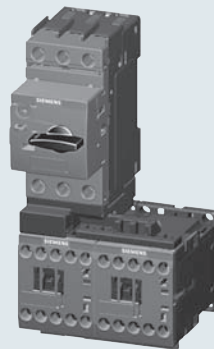

**3RA11/3RA22 up to 100 A for mounting rail and Fast Bus busbar systems** Page

**Selection and ordering data**

- Reversing duty 4/40-4/43
- Accessories 4/44-4/52

Technical data 4/53-4/58  
 Installation guidelines 4/59-4/68  
 Circuit diagrams 4/68  
 Dimension drawings 4/69-4/72

# SIRIUS 3RA6 Compact Starters

## General data

### Overview

#### 3RA6 fuseless compact starters and infeed system for 3RA6



3RA62 reversing starter

#### Integrated functionality

The SIRIUS 3RA6 compact starters are a generation of innovative load feeders with the integrated functionality of a motor starter protector, contactor and electronic overload relay. In addition, various functions of optional mountable accessories (e.g. auxiliary switches, surge suppressors) are already integrated in the SIRIUS compact starter.

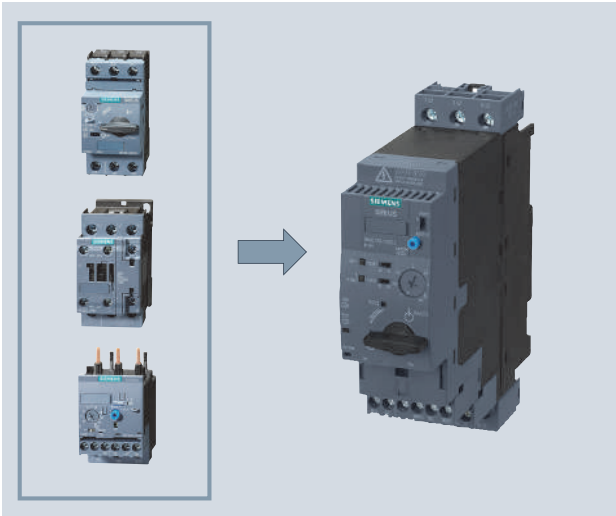

3RA6 compact starters with the integrated functionality of a motor starter protector, contactor and electronic overload relay.

#### Applications

The SIRIUS compact starters can be used wherever standard three-phase motors up to 32 A (20 HP/460 V) are directly started.

The compact starters are not suitable for the protection of DC loads.

Approvals according to IEC, UL, CSA and CCC standards have been issued for the compact starters.

#### Low variance of devices

Thanks to wide setting ranges for the rated current and wide voltage ranges, the equipment variance is greatly reduced compared to conventional load feeders.

#### Very high operational reliability

The high short-circuit breaking capacity and defined shut-down when the end of service life is reached means that the SIRIUS compact starter achieves a very high level of operational reliability that would otherwise have only been possible with considerable additional outlay. This sets it apart from devices with similar functionality.

#### Safe disconnection

The auxiliary switches (NC contacts) of the 3RA6 compact starters are designed as mirror contacts. This enables their use for safe disconnection - e.g. EMERGENCY STOP up to SIL 1 (IEC 62061) or PL c (ISO 13849-1) or, if used in conjunction with an additional infeed contactor, up to SIL 3 (IEC 62061) or PL e (ISO 13849-1).

#### Communications integration through AS-Interface

To enable communications integration through AS-Interface there is an AS-i add-on module available in several versions for mounting instead of the control circuit terminals on the SIRIUS compact starter.

The design of the AS-i add-on module permits a group of up to 62 feeders with a total of four cables to be connected to the control system. This reduces wiring work considerably compared to the parallel wiring method.

#### Communications integration using IO-Link

Up to 4 compact starters in IO-Link version (reversing and direct-on-line starters) can be connected together and conveniently linked to the IO-Link master through a standardized IO-Link connection. The SIRIUS 4SI electronic modules are used e.g. as IO-Link masters for connection to the SIMATIC ET 200S distributed I/O system.

The IO-Link connection enables a high density of information in the local range.

Details of the communications integration using IO-Link, see [Chapter 14 Communications](#).

The diagnostics data of the process collected by the 3RA6 compact starter, e.g. short circuit, end of service life, limit position etc., are not only indicated on the compact starter itself but also transmitted to the higher-level control system through IO-Link.

Thanks to the optionally available operator panel, which can be installed in the control cabinet door, it is easy to control the 3RA6 compact starters with IO-Link from the control cabinet door.

#### Permanent wiring / easy replacement

Using the SIRIUS infeed system for 3RA6 (see page 4/16) it is possible to carry out the wiring in advance without a compact starter needing to be connected.

A compact starter is very easily replaced simply by pulling it out of the device without disconnecting the wiring.

Even with screw connections or mounting on a standard mounting rail there is no need to disconnect any wiring (on account of the removable main and control circuit terminals) in order to replace a compact starter.

#### Consistent solution from the infeed to the motor feeder

The SIRIUS infeed system for 3RA6 with integrated PE bar is offered as a user-friendly possibility of feeding in summation currents up to 100 A with a maximum conductor cross-section of 2/0 AWG and connecting the motor cable directly without additional intermediate terminals.

#### Screw and spring-type terminals

The SIRIUS compact starters and the infeed system for 3RA6 are available with screw and spring-type terminals.

## SIRIUS 3RA6 Compact Starters

## General data

To comply with the clearance and creepage distances demanded according to UL 508 there are the following infeed possibilities:

Type of infeed	Feeder terminal (according to UL 508, type E)	Type
Conventional wiring	Terminal block for "Self-Protected Combination Motor Controller (Type E)"	<b>3RV29 28-1H</b>
Three-phase busbars	Three-phase infeed terminal for constructing "Type E Starters", UL 508	<b>3RV29 25-5EB</b>
Infeed systems for 3RA6	Infeed on left, 50/70 mm <sup>2</sup> , screw terminal with 3 sockets, outgoing terminal with screw/spring-type connections, including PE bar	<b>3RA68 13-8AB</b> (screw terminals), <b>3RA68 13-8AC</b> (spring-type terminals)

**SIRIUS 3RA6 compact starters**

The SIRIUS 3RA6 compact starters are universal motor starters according to IEC/EN 60947-6-2. As control and protective switching devices (CPS) they can connect, convey and disconnect the thermal, dynamic and electrical loads from short-circuit currents up to  $I_{cs} = 53$  kA, i.e. they are essentially weld-free. They combine the functions of a motor starter protectors, a contactor and a solid-state overload relay in a single enclosure and can be used wherever standard induction motors up to 32 A (up to approx. 20 HP at 480 V AC) are started directly. Available versions are the direct-on-line starters with 45 mm width and the reversing starters with 90 mm width.

The reversing starter version comes with not only an internal electrical interlock but also with a mechanical interlock to prevent simultaneous actuation of both directions of rotation.

3RA6 compact starters are supplied in 5 current setting ranges. The 3RA61 and 3RA62 have 2 control voltage ranges (AC/DC), the 3RA64 and 3RA65 have one control voltage range (DC):

Current setting range	At 460 V AC for induction motors Standard output P HP	Rated control supply voltage for	
		3RA61, 3RA62 compact starters	3RA64, 3RA65 compact starters for IO-Link
A	HP	V AC/DC	V DC
0.1 ... 0.4	0.12	24	24
0.32 ... 1.25	0.43 ... 1.68	110 ... 240	
1 ... 4	1.34 ... 5.36		
3 ... 12	4.02 ... 16.1		
8 ... 32	10.7 ... 42.9		

Note:

The 3RA1 motor starters can be used as motor starters > 32 A up to 100 A.

The SENTRON 3VL circuit breakers and the SIRIUS 3RT contactors can be used for motor starters > 100 A.

Operating conditions

The SIRIUS 3RA6 compact starters are suitable for use in nearly all climates. They are intended for use in enclosed rooms in which no severe operating conditions (such as dust, caustic vapors, hazardous gases) prevail. Suitable covers must be provided for installation in dusty and damp locations.

The SIRIUS compact starters are generally designed to degree of protection IP20. The permissible ambient temperature during operation is -20 to +60 °C.

The maximum short-circuit current based on UL testing is 30 kA up to 12 A and 15 kA for the 8 ... 32 A versions at 480 V.

Note:

More technical specifications can be found in the system manual at

[www.siemens.com/compactstarter](http://www.siemens.com/compactstarter)

Overload tripping times

The overload tripping time can be set on the device to less than 10 s (CLASS 10) and less than 20 s (CLASS 20 for heavy starting). As the breaker mechanism still remains closed after an overload, resetting is possible by either local manual reset or autotrip after 3 minutes cooling time.

With autoreset there is no need to open the control cabinet.

Diagnostics options

The compact starter provides the following diagnostics options on site:

- With LEDs
  - Connection to the control voltage
  - Position of the main contacts
- With mechanical indication
  - Tripping due to overload
  - Tripping due to short-circuit
  - Tripping due to malfunction (end of service life reached because of worn switching contacts or a worn switching mechanism or faults in the control electronics)

These states can also be evaluated in the higher-level control system:

- With conventional wiring using the integrated auxiliary and signaling switches of the compact starter
- With AS-Interface or IO-Link in even greater detail using the respective communication interface

Four complement variants for 3RA6 compact starters

- For standard mounting rail or screw mounting: basic version including 1 pair of main circuit terminals and 1 pair of control circuit terminals
- For standard mounting rail or screw mounting when using the AS-i add-on module: comes without control circuit terminals because the AS-i add-on module is attached in lieu of them
- For use with the infeed system for 3RA6: without main circuit terminals because they are supplied with the infeed system and the expansion modules
- For use with the infeed system for 3RA6 and AS-i add-on module: without main or control circuit terminals as they are not needed
- The control circuit terminals are always required by the compact starters for IO-Link; the main circuit terminals depend on the use of the infeed system.

Additional components of the 3RA6

The two control circuit terminals on the 3RA61/3RA62 allow access to signalling contacts for overload (1 CO) and short-circuit / malfunction (1 NO). Furthermore, the 3RA61 has two auxiliary contacts (1 NO + 1 NC) for indicating the position of the main contacts, while the 3RA62 has one auxiliary contact (1 NO) per direction of rotation per main contact.

# 3RA6 Compact Starters

## Overview

### Function

#### Trip units

The SIRIUS 3RA6 compact starters are equipped with the following trip units:

- Inverse-time delayed solid-state overload release
- Instantaneous electronic trip unit (electromagnetic short-circuit release)

The overload releases can be adjusted in accordance with the load current.

The electronic trip units are permanently set to a value 13 times the maximum rated current of the 4 A, 12 A and 32 A starter and thus enable trouble-free starting of motors.

#### Trip classes

The trip classes of electronically delayed trip units are based on the tripping time ( $t_A$ ) at 7.2 times the set current in the cold state (excerpt from IEC 60947-4):

CLASS 10:  $4s < t_A < 10s$

CLASS 20:  $6s < t_A < 20s$  (for heavy starting)

The compact starter must trip within this time.

#### Disconnection due to malfunction

The following malfunctions can be detected:

- End of service life
  - Worn switching contacts (for electrical endurance see "Technical data")
  - Worn switching mechanisms (for mechanical endurance see "Technical data")
- Faults in the control electronics

#### Short-circuit protection

If a short-circuit occurs, the short-circuit releases of the SIRIUS 3RA6 compact starters isolate the faulty motor starter from the network and thus prevent further damage. The short-circuit releases are factory-set to 14 times the value of the maximum rated current  $I_n$  of the device.

The SIRIUS compact starters have a short-circuit breaking capacity up to 30 kA at a voltage of 480 V AC.

#### Overload relay function

In the event of an overload, the compact starter switches off without the breaker mechanism being opened.

The overload trip can be signaled to the higher-level control system through an integrated signal switch.

The overload signal can be reset automatically or by means of a manual reset.

#### Control through AS-Interface

For control through AS-Interface, the AS-i add-on module is mounted instead of the two control circuit terminals on the SIRIUS 3RA6 compact starters (direct-on-line starters and reversing starters).

The AS-i auxiliary voltage and the AS-i data line are installed on the AS-i add-on module easily and quickly without tools by means of two plug-in connector blocks with insulation displacement connection.

The AS-i add-on module is equipped with the latest A/B technology and has an addressing socket onboard.

An addressing unit is required and can be ordered for addressing the AS-i add-on module.

Bit assignment (see below) is similar to that for the SIRIUS motor starters, which means that the same programming can be used here.

DI 0.0 ready
DI 0.1 motor on
DI 0.2 group fault
DI 0.3 group warning

DO 0.0 motor on or motor clockwise
DO 0.1 motor counterclockwise

A 24 V DC PELV power supply unit according to EN 61140 safety class III is required for the auxiliary voltage.

The AS-i data line is supplied with voltage by means of a 30 V DC AS-i power supply unit and is controlled by means of the AS-i master.

The AS-i add-on modules are available in the following five versions:

- AS-i add-on module for compact starters
- AS-i add-on module for compact starters with two local inputs for safe disconnection of the "clockwise rotation" or "counterclockwise rotation" outputs
- AS-i add-on module with two free external inputs
- AS-i add-on module with two free external outputs
- AS-i add-on module with one free external input and output

The AS-i add-on module can only be used with compact starters with a control voltage of 24 V AC/DC.

#### Integrated auxiliary switches

The control circuit terminals of the SIRIUS 3RA6 compact starters have the following connections:

- A1/A2 for the control voltage for 3RA61, A1/A2 and B1/B2 for the control voltage for 3RA62
- "Overload" signal switch
- "Fault" signal switch, e. g. "short-circuit"
- Internal auxiliary switch for position of the main contacts (in case of direct-on-line starters: 1 NO + 1 NC with mirror contact to the main contact; in case of reversing starters: 2 NO)

# 3RA6 Compact Starters

## Overview

### Design

#### Mounting

The 3RA6 compact starters can be mounted in 4 ways:

1) By snapping onto a TH 35 standard mounting rail

The SIRIUS compact starters can be snapped onto a standard mounting rail according to EN 60715 with a width of 35 mm.

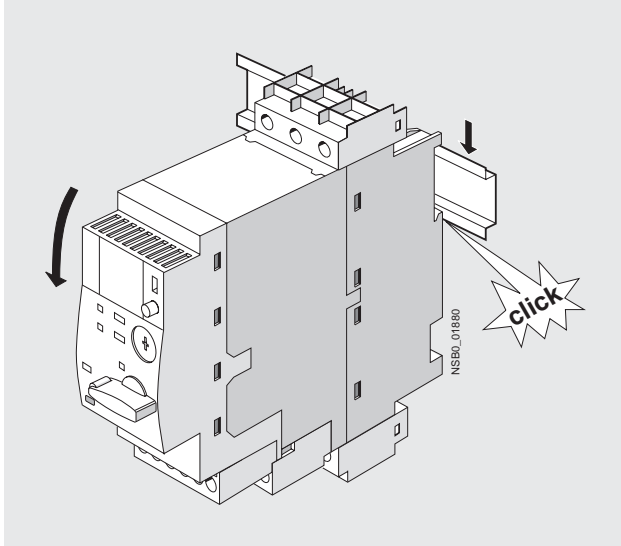

2) By screw fixing to a flat surface

The SIRIUS compact starters are suitable for screw fixing to a flat surface. One set of 3RA69 40-0A adapters for screw connection (including push-in lugs) is required per direct-on-line starter, two sets are required per reversing starter.

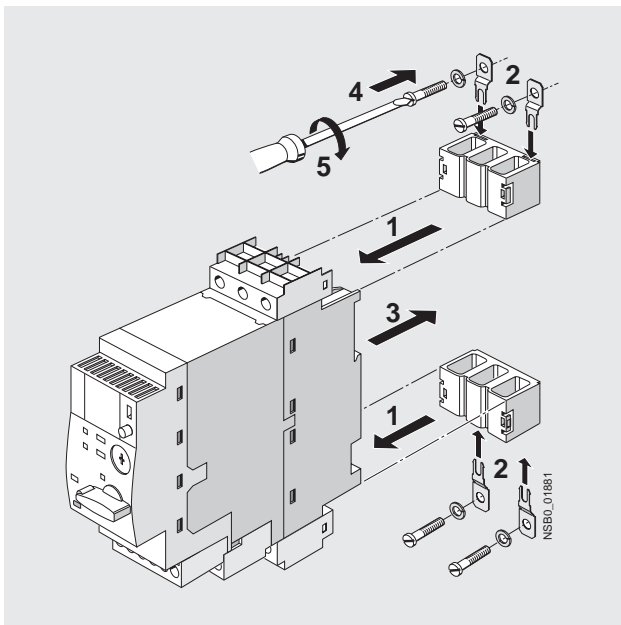

1 ... 5: order of mounting steps

3) By integrating in the infeed system for 3RA6

The SIRIUS compact starters can be assembled with the infeed system for 3RA6 (see "Infeed system for 3RA6").

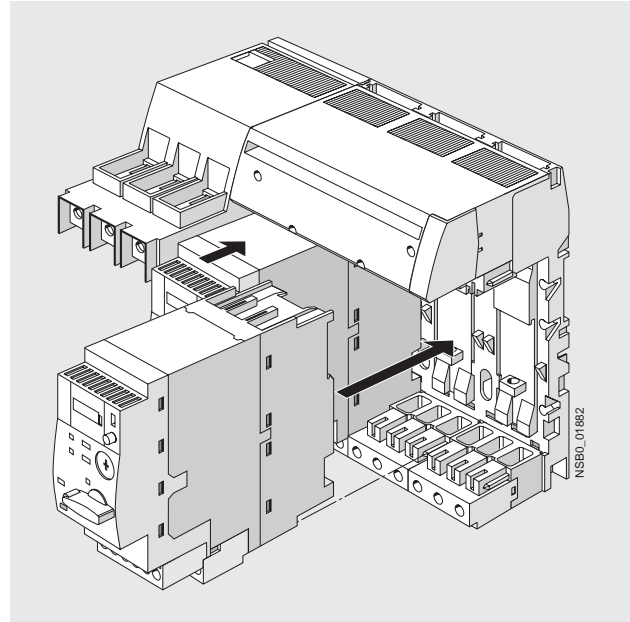

4) By using the 8US busbar adapter for Fast Bus systems with 60 mm busbar center-to-center clearance

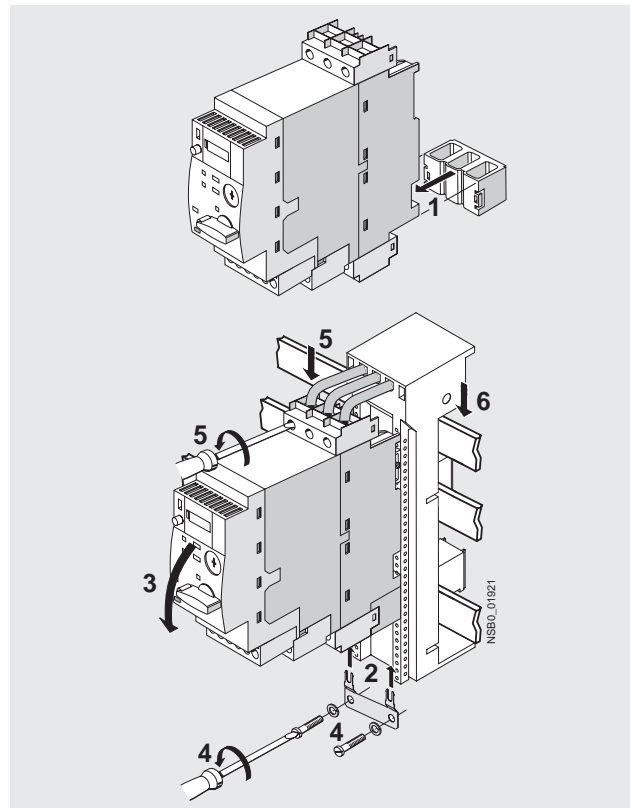

1 ... 6: order of mounting steps

## 3RA6 Compact Starters

## Overview

4a) By using an additional device holder in the case of reversing starters

When the 8US busbar adapter is used on Fast Bus systems with 60 mm busbar center-to-center clearance, a device holder is needed in addition for a reversing starter on account of its double width.

The reversing starter is mounted in the same way as the direct-on-line starter on the busbar adapter. Then the device holder is snapped on alongside the busbar adapter.

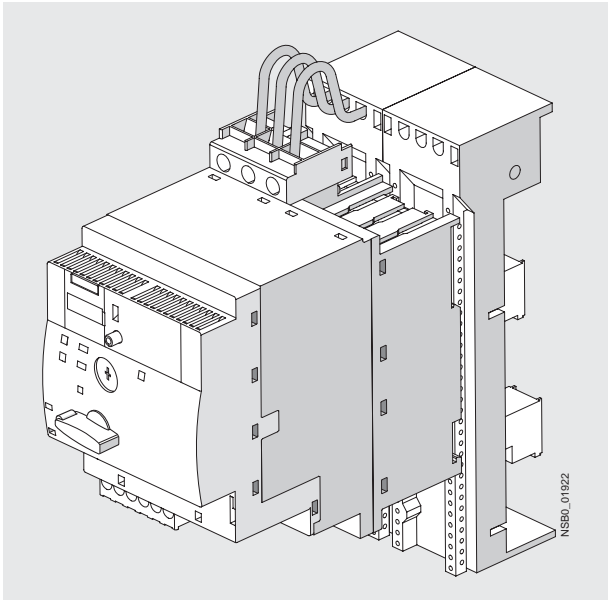
**Mounting regulations**

The module can be installed horizontally or vertically. For the different installations attention must be paid however to limit values for protective separation according to IEC/EN 60947-2 of the compact starters (for details see the "Technical specifications").

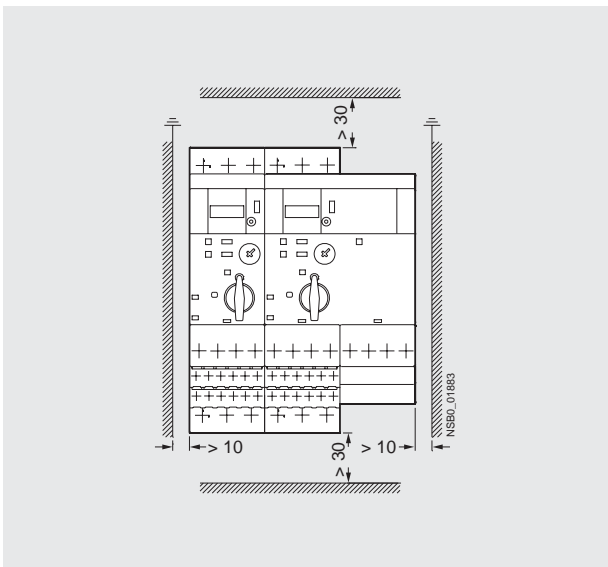

The following distances must be observed when mounting the compact starters:

- Lateral clearance to grounded components: 10 mm
- Arcing space at top and bottom: 30 mm



# SIRIUS 3RA6 Compact Starters

3RA61, 3RA62 compact starters; 3RA61 direct-on-line starters

## Selection and ordering data



3RA61 20-1CB32



3RA61 20-2EB32

Width 45 mm  
One set of 3RA69  
40-0A adapters  
is required for  
screw fixing.



3RA62 50-1CP32



3RA62 50-1CP32

Width 90 mm  
One set of  
3RA69  
40-0A adapters  
is required for  
screw fixing.

Standard induction motor at 600 V AC <sup>1)</sup> Standard output <i>P</i>	Setting range for solid-state overload release	Order No.	Order No.
HP	A		
<b>For use with the infeed system for 3RA6 and with the AS-i add-on module or as a replacement device, without main and control circuit terminals</b>			
--	0.1 ... 0.4	3RA6□□0-0A □32	—
1/2	0.32 ... 1.25	3RA6□□0-0B □32	—
3	1 ... 4	3RA6□□0-0C □32	—
10	3 ... 12	3RA6□□0-0D □32	—
30	8 ... 32	3RA6□□0-0E □32	—
		<b>Screw terminals<sup>2)</sup></b>	<b>Spring-type terminals</b>
<b>For standard mounting rail or screw mounting, including 1 pair of main circuit terminals and 1 pair of control circuit terminals</b>			
--	0.1 ... 0.4	3RA6□□0-1A □32	3RA6□□0-2A □32
1/2	0.32 ... 1.25	3RA6□□0-1B □32	3RA6□□0-2B □32
3	1 ... 4	3RA6□□0-1C □32	3RA6□□0-2C □32
10	3 ... 12	3RA6□□0-1D □32	3RA6□□0-2D □32
30	8 ... 32	3RA6□□0-1E □32	3RA6□□0-2E □32
<b>For use in the infeed system for 3RA6, without main circuit terminals, with 1 pair of control circuit terminals</b>			
--	0.1 ... 0.4	3RA6□□0-1A □33	3RA6□□0-2A □33
1/2	0.32 ... 1.25	3RA6□□0-1B □33	3RA6□□0-2B □33
3	1 ... 4	3RA6□□0-1C □33	3RA6□□0-2C □33
10	3 ... 12	3RA6□□0-1D □33	3RA6□□0-2D □33
30	8 ... 32	3RA6□□0-1E □33	3RA6□□0-2E □33
<b>For standard mounting rail or screw mounting when using the AS-i add-on module with 1 pair of main circuit terminals, without control circuit terminals</b>			
--	0.1 ... 0.4	3RA6□□0-1A □34	3RA6□□0-2A □34
1/2	0.32 ... 1.25	3RA6□□0-1B □34	3RA6□□0-2B □34
3	1 ... 4	3RA6□□0-1C □34	3RA6□□0-2C □34
10	3 ... 12	3RA6□□0-1D □34	3RA6□□0-2D □34
30	8 ... 32	3RA6□□0-1E □34	3RA6□□0-2E □34
		12 25 B P	12 25 B P

**Order No. supplements for rated control supply voltage**

- Direct-on-line starter
- Reversing duty starter
- 24 V AC/DC (for combining with AS-I add-on module)
- 110 ... 240 V AC/DC

<sup>1)</sup> Selection depends on the motor full load amps. Horse Power ratings provided for reference only.

<sup>2)</sup> A set of 3RA69 40-0A adapters is required for screw mounting.

## SIRIUS 3RA6 Compact Starters

3RA64, 3RA65 compact starters for IO-Link

## Selection and ordering data



3RA64 with 3RA69 11-1A

- **Direct-on-line starters**

- Rated control supply voltage 24 V DC
- Width 45 mm
- One set of 3RA69 40-0A adapters is required for screw fixing

Standard induction motor at 600 V AC Standard output P HP <sup>1)</sup>	Setting range for solid-state overload release A	Screw terminals Order No.	Spring-type terminals Order No.
<b>For standard mounting rail or screw mounting, including 1 pair of main circuit terminals and 1 pair of control circuit terminals</b>			
--	0.1 ... 0.4	<b>3RA64 00-1AB42</b>	<b>3RA64 00-2AB42</b>
1/2	0.32 ... 1.25	<b>3RA64 00-1BB42</b>	<b>3RA64 00-2BB42</b>
3	1 ... 4	<b>3RA64 00-1CB42</b>	<b>3RA64 00-2CB42</b>
10	3 ... 12	<b>3RA64 00-1DB42</b>	<b>3RA64 00-2DB42</b>
30	8 ... 32	<b>3RA64 00-1EB42</b>	<b>3RA64 00-2EB42</b>
<b>For use in the infeed system for 3RA6, without main circuit terminals, with 1 pair of control circuit terminals</b>			
--	0.1 ... 0.4	<b>3RA64 00-1AB43</b>	<b>3RA64 00-2AB43</b>
1/2	0.32 ... 1.25	<b>3RA64 00-1BB43</b>	<b>3RA64 00-2BB43</b>
3	1 ... 4	<b>3RA64 00-1CB43</b>	<b>3RA64 00-2CB43</b>
10	3 ... 12	<b>3RA64 00-1DB43</b>	<b>3RA64 00-2DB43</b>
30	8 ... 32	<b>3RA64 00-1EB43</b>	<b>3RA64 00-2EB43</b>



3RA65 with 3RA69 11-1A

- **Reversing starters**

- Rated control supply voltage 24 V DC
- Width 90 mm
- One set of 3RA69 40-0A adapters is required for screw fixing

<b>For standard mounting rail or screw mounting, including 1 pair of main circuit terminals and 1 pair of control circuit terminals</b>			
--	0.1 ... 0.4	<b>3RA65 00-1AB42</b>	<b>3RA65 00-2AB42</b>
1/2	0.32 ... 1.25	<b>3RA65 00-1BB42</b>	<b>3RA65 00-2BB42</b>
3	1 ... 4	<b>3RA65 00-1CB42</b>	<b>3RA65 00-2CB42</b>
10	3 ... 12	<b>3RA65 00-1DB42</b>	<b>3RA65 00-2DB42</b>
30	8 ... 32	<b>3RA65 00-1EB42</b>	<b>3RA65 00-2EB42</b>
<b>For use in the infeed system for 3RA6, without main circuit terminals, with 1 pair of control circuit terminals</b>			
--	0.1 ... 0.4	<b>3RA65 00-1AB43</b>	<b>3RA65 00-2AB43</b>
1/2	0.32 ... 1.25	<b>3RA65 00-1BB43</b>	<b>3RA65 00-2BB43</b>
3	1 ... 4	<b>3RA65 00-1CB43</b>	<b>3RA65 00-2CB43</b>
10	3 ... 12	<b>3RA65 00-1DB43</b>	<b>3RA65 00-2DB43</b>
30	8 ... 32	<b>3RA65 00-1EB43</b>	<b>3RA65 00-2EB43</b>

1) Selection depends on the motor full load amps. Horse power ratings provided for reference only.



# SIRIUS 3RA6 Compact Starters

## Accessories

### Overview

#### Accessories for SIRIUS 3RA6 compact starters

The following accessories are available for the 3RA6 compact starters:

- AS-i add-on module: [see AS-Interface Add-On Modules for 3RA6, page 4/14](#)
- External auxiliary switch blocks: Snap-on auxiliary switch as versions 2 NO, 2 NC and 1 NO +1 NC with screw or spring-type connections; the contacts of the auxiliary switch block open and close jointly with the main contacts of the compact starter. The NC contacts are designed as mirror contacts.
- Control kit: aid for manually closing the main contacts in order to evaluate the wiring and motor direction under conditions of short-circuit protection
- Adapter for screw mounting the compact starter, including push-in lugs
- Main circuit terminals: Available in screw and spring-type terminals
- Main circuit terminals for mixed connection method: With the main circuit terminal for the mixed connection method it is also possible in the main circuit to change over from the screw connection method on the incoming side to the spring-type connection method on the outgoing side. This enables for example the side-by-side mounting of several compact starters and their cost-effective connection using the three-phase busbars on the infeed side. The motors are then directly connected by the quick and reliably contacting spring-type connection method.

#### Accessories for UL applications

The terminal block for "Self-Protected Combination Motor Controller", type E is available for complying with the clearance and creepage distances according to UL 508.

#### Accessories for infeed using three-phase busbar systems

The three-phase busbars can be used as an easy, time-saving and clearly arranged means of feeding SIRIUS 3RA6 compact starters with screw connection. Motor starter protectors size S00 and S0 can also be integrated.

The busbars are suitable for between 2 and 5 devices. However, any kind of extension up to a maximum summation current of 63 A is possible by clamping the terminals of an additional busbar (rotated by 180°) underneath the terminals of the respective last motor circuit protector.

A connecting piece is required for the combination with motor starter protector size S00. S00 and S0 motor starter protectors of the 3RV2 series do not require the additional connecting piece. The motor starter protectors are supplied by appropriate feeder terminals. Special feeder terminals are required for constructing "Type E Starters" according to UL/CSA.

The three-phase busbar systems are finger-safe but empty connection terminals must be fitted with covers. They are designed for any short-circuit stress which can occur at the output side of connected SIRIUS 3RA6 compact starters or motor starter protectors.

#### 8US Fast Bus busbar adapters for 60 mm systems

The compact starters are mounted directly with the aid of busbar adapters on the Fast Bus busbar systems with 60 mm center-to-center clearance in order to save space and to reduce infeed times and costs. These starters are suitable for copper busbars with a width from 12 to 30 mm. The busbars can be 4 to 5 mm or 10 mm thick.

The 8US Fast Bus busbar system can be loaded with a maximum summation current of 630A.

The "reversing starter" version requires a device holder along side the busbar adapter for lateral mounting.

The compact starters are snapped onto the adapter and connected on the line side. This prepared unit is then plugged directly onto the busbar system, and is thus connected both mechanically and electrically at the same time.

For more accessories such as incoming and outgoing terminals, flat copper profiles etc., [see Section 5 "Fastbus Busbar Systems"](#).

#### Accessories for operation with closed control cabinet doors

Door-coupling rotary operating mechanisms for standard and emergency-stop applications are available for operating the compact starter with closed control cabinet doors.

#### Accessories for SIRIUS 3RA6 compact starters in IO-Link version







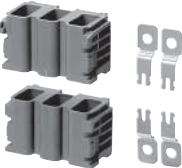

The following accessories are available specifically for the 3RA64, 3RA65 compact starters:

- The 4SI SIRIUS solid-state module as IO-Link master allows for the simple and economical connection of SIRIUS controls with IO-Link (e.g up to four groups of 4 compact starters) to the multifunctional SIMATIC ET 200S distributed I/O system.
- Additional connection cables for side-by-side mounting of up to 4 compact starters
- Operator panel for local control and diagnostics of up to 4 compact starters coupled to each other

# SIRIUS 3RA6 Compact Starters

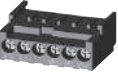
## Accessories

### Selection and ordering data

Version	Order No.	Std. pack qty.	Weight approx. kg
<b>Accessories for 3RA6 compact starters</b>			
 3RA69 50-0A <b>Control kits</b> For mechanical actuation of the compact starter	<b>3RA69 50-0A</b>	1 unit	0.004
 3RA69 40-0A <b>Adapters for screw mounting the compact starter</b> (set including push-in lugs) Direct-on-line starters require 1 set, reversing starters 2 sets.	<b>3RA69 40-0A</b>	1 unit	0.152
<b>Screw terminals</b> 			
 3RA69 11-1A <b>Auxiliary switch blocks for compact starters</b> <ul style="list-style-type: none"> <li>• 2 NO</li> <li>• 2 NC</li> <li>• 1 NO +1 NC</li> </ul> (these auxiliary contacts are positively driven.)	<b>3RA69 11-1A</b> <b>3RA69 12-1A</b> <b>3RA69 13-1A</b>	1 unit 1 unit 1 unit	0.018 0.018 0.018
 3RA69 20-1A <b>Main circuit terminals</b> (line and load side)	<b>3RA69 20-1A</b>	1 unit	0.038
 3RA69 20-1B <b>Control circuit terminals</b> <ul style="list-style-type: none"> <li>• For 3RA61</li> <li>• For 3RA62</li> </ul>	<b>3RA69 20-1B</b> <b>3RA69 20-1C</b>	1 unit 1 unit	0.042 0.042
<b>Spring-type terminals</b> 			
 3RA69 11-2A <b>Auxiliary switch blocks for compact starters</b> <ul style="list-style-type: none"> <li>• 2 NO</li> <li>• 2 NC</li> <li>• 1 NO +1 NC</li> </ul> (these auxiliary contacts are positively driven.)	<b>3RA69 11-2A</b> <b>3RA69 12-2A</b> <b>3RA69 13-2A</b>	1 unit 1 unit 1 unit	0.018 0.018 0.018
 3RA69 20-2A <b>Main circuit terminals</b> (line and load side)	<b>3RA69 20-2A</b>	1 unit	0.049
 3RA69 20-2B <b>Control circuit terminals</b> <ul style="list-style-type: none"> <li>• For 3RA61</li> <li>• For 3RA62</li> </ul>	<b>3RA69 20-2B</b> <b>3RA69 20-2C</b>	1 unit 1 unit	0.036 0.036

4 COMBINATION STARTERS

# SIRIUS 3RA6 Compact Starters

## Accessories

4 COMBINATION STARTERS

### Accessories for 3RA6 compact starters (continued)



3RA69 20-3A

Version	Order No.	Std. pack qty.	Weight approx. kg
---------	-----------	----------------	-------------------

<b>Main circuit terminals for mixed connection method</b> One set comprises: • 1 joint block on the line side for the screw connection method • 1 joint block on the motor side for the spring-type connection method	<b>3RA69 20-3A</b>	1 unit	0.044
--	--------------------	--------	-------

### Accessories specifically for 3RA64, 3RA65 compact starters with IO-Link



3RA69 31-0A



3RA69 35-0A



3RK1 005-0LB00-0AA0

Version	Order No.	Std. pack qty.	Weight approx. kg
---------	-----------	----------------	-------------------

<b>Additional connection cables (flat) for side-by-side mounting of up to 4 compact starters</b> • 10-pole - 8 mm <sup>1)</sup> - 200 mm <sup>1)</sup> • 14-pole - 8 mm <sup>2)</sup> - 200 mm	<b>3RA69 32-0A</b> <b>3RA69 33-0B</b>	5 units 5 units	0.007 0.012
<b>Operator panels</b> - 1 operator panel - 1 enabling module - 1 interface cover - 1 fixing terminal	<b>3RA69 31-0A</b> <b>3RA69 33-0C</b> <b>3RA69 35-0A</b>	5 units 5 units 1 unit	0.007 0.014 0.052
<b>Enabling block</b>	<b>3RA69 36-0A</b>	1 unit	0.002
<b>Blanking covers</b>	<b>3RA69 36-0B</b>	5 units	0.001
<b>Connection cable (round) for connecting the operator panel</b> 10-pole, 2000 mm	<b>3RA69 33-0A</b>	1 unit	0.114
<b>SIRIUS 4SI solid-state modules</b> IO-Link master for connection of up to 4 SIRIUS controls (max. 16 in groups of 4) with IO-Link (3-wire connection) to SIMATIC ET 200S, width 15 mm, supports firmware update (STEP 7 V5.4 SP5 and higher) Can be used with the following terminal modules: • TM-E15S26-A1 (screw terminals) • TM-E15C26-A1 (spring-type terminals) • TM-E15N26-A1 (Fast Connect)	<b>3RK1 005-0LB00-0AA0</b>	1 unit	0.057

<sup>1)</sup> 10-pole connection cables are required for EMERGENCY-STOP group concepts.

<sup>2)</sup> Is included in the scope of supply of the SIRIUS 3RA6 compact starter in IO-Link version.

Version	Order No.	Std. pack qty.	Weight approx. kg
---------	-----------	----------------	-------------------

### Terminal blocks and phase barriers for "Self-Protected Combination Motor Controllers (Type E)" according to UL 508



3RV29 28-1H

*Note:*  
UL 508 demands 1-inch clearance and 2-inch creepage distance on the line side for "Combination Motor Controller Type E". The following terminal blocks or phase barriers must be used in 3RV20 motor starter protectors.

The terminal blocks or phase barriers cannot be used in combination with the 3RV19 .5 three-phase busbars.

For construction with three-phase busbars, see "Busbar accessories".

<b>Terminal blocks type E</b> For extended clearance and creepage distances (1 and 2 inch)	S00, S0	<b>3RV29 28-1H</b>	1 unit	0.065
---	---------	--------------------	--------	-------

# SIRIUS 3RA6 Compact Starters

## Accessories

4  
COMBINATION  
STARTERS

	Modular spacing mm	Number of motor starter protectors that can be connected			Rated current $I_n$ at 690 V A	For motor starter protectors Size	Order No.	Std. pack qty.	Weight approx.
		Without lateral accessories	With lateral auxiliary switch	With auxiliary release					
<b>Three-phase busbars<sup>1)</sup></b>									
 3RV1915-1AB	45 <sup>3)</sup>	2	--	--	63	S00, S0 <sup>2)</sup>	<b>3RV1915-1AB</b> <b>3RV1915-1BB</b> <b>3RV1915-1CB</b> <b>3RV1915-1DB</b>	1 unit	0.044
		3	--	--	63	S00, S0 <sup>2)</sup>			
		4	--	--	63	S00, S0 <sup>2)</sup>			
		5	--	--	63	S00, S0 <sup>2)</sup>			
 3RV1915-1BB	55 <sup>4)</sup>	--	2	--	63	S00, S0 <sup>2)</sup>	<b>3RV1915-2AB</b> <b>3RV1915-2BB</b> <b>3RV1915-2CB</b> <b>3RV1915-2DB</b>	1 unit	0.071
		--	3	--	63	S00, S0 <sup>2)</sup>			
		--	4	--	63	S00, S0 <sup>2)</sup>			
 3RV1915-1CB	63 <sup>5)</sup>	--	5	--	63	S00, S0 <sup>2)</sup>	<b>3RV1915-3A</b> <b>3RV1915-3B</b> <b>3RV1915-3C</b>	1 unit	0.099
		2	--	--	108	S2			
		3	--	--	108	S2			
 3RV1915-1DB	75 <sup>5)</sup>	--	--	2	63	S00, S0 <sup>2)</sup>	<b>3RV1915-3AB</b> <b>3RV1915-3CB</b>	1 unit	0.124
		--	--	4	63	S00, S0 <sup>2)</sup>			
		--	2	2	108	S2			
		--	3	3	108	S2			
		--	4	4	108	S2			

1) Not suitable for 3RV21 motor starter protectors for motor protection with overload relay function and for 3RV27 and 3RV28 circuit breakers according to UL 489/CSA C22.2 No. 5.

2) Approved for motor starter protectors size S0 with  $I_n \leq 32$  A.

3) For 3RV2 motor starter protectors without accessories mounted on the side.

4) For 3RV2 motor starter protectors with auxiliary switches with 1 NO + 1 NC, 2 NO and 2 NC mounted on the left (9 mm wide).

5) For 3RV2 motor starter protectors with mounted accessories (18 mm wide). Auxiliary switches with 2 NO + 2 NC or signaling switch (mounted on the left) or with auxiliary release (mounted on the right).

Conductor cross-section Solid or stranded mm <sup>2</sup>	Finely stranded with end sleeve mm <sup>2</sup>	AWG cables, solid or stranded AWG	Tightening torque Nm	For motor starter protectors/circuit breakers Size	Order No.	Weight approx.
---	--	--------------------------------------	-------------------------	---	-----------	----------------

<b>Three-phase infeed terminals</b>						
 3RV2925-5AB	<b>Connection from top</b>					
	2.5 ... 25	2.5 ... 16	10 ... 4	3 ... 4	S00, S0	<b>3RV2925-5AB</b> <b>3RV2935-5A</b>
	2 x (2.5 ... 50) <sup>1)</sup>	2 x (2.5 ... 35) <sup>1)</sup>	2 x (10 ... 1/0) <sup>1)</sup>	4 ... 6	S2 <b>NEW</b>	
1 x (2.5 ... 70) <sup>1)</sup>	1 x (2.5 ... 50) <sup>1)</sup>	1 x (10 ... 2/0) <sup>1)</sup>				
 3RV2935-5A	<b>Connection from below</b>					
	This terminal is connected in place of a switch, please take the space requirement into account.					
 3RV2915-5B	2.5 ... 25	2.5 ... 16	10 ... 4	Input: 4, Output: 2 ... 2.5	S00, S0	<b>3RV2915-5B</b>

<b>Three-phase infeed terminals for constructing "Type E Starters"</b>						
 3RV2925-5EB	<b>Connection from top</b>					
	2.5 ... 25	2.5 ... 16	10 ... 4	3 ... 4	S00, S0	<b>3RV2925-5EB</b> <b>3RV2935-5E</b>
	2 x (2.5 ... 50) <sup>1)</sup>	2 x (2.5 ... 35) <sup>1)</sup>	2 x (10 ... 1/0) <sup>1)</sup>	4 ... 6	S2 <b>NEW</b>	
1 x (2.5 ... 70) <sup>1)</sup>	1 x (2.5 ... 50) <sup>1)</sup>	1 x (10 ... 2/0) <sup>1)</sup>				
 3RV2935-5E						

1) If two different conductor cross-sections are connected to one clamping point, both cross-sections must be in the range specified.

# SIRIUS 3RA6 Compact Starters

## Accessories

Version	Order No.	Std. pack qty.	Weight approx.
---------	-----------	----------------	----------------

### 8US Fast Bus busbar adapters for 60 mm systems



8US12 11-1NS10

For flat copper profiles according to DIN 46433  
Width: 12 ... 30 mm  
Thickness: 4 ... 5 mm or 10 mm

8US12 11-1NS10

1 unit

0.337

### Device holders for lateral mounting along side the Fast Bus busbar adapter for 60 mm systems



8US12 50-1AA10

Required in addition to the busbar adapter for mounting a reversing starter

8US12 50-1AA10

1 unit

0.239

Version	Color of handle	Version of extension shaft	Order No.	Std. pack qty.	Weight approx.
---------	-----------------	----------------------------	-----------	----------------	----------------

### Door-coupling rotary operating mechanisms for operating the compact starter with closed control cabinet doors



3RV29 26-0B

The door-coupling rotary operating mechanisms consist of a knob, a coupling driver and an extension shaft of 130/330 mm in length (6 mm x 6 mm). The door-coupling rotary operating mechanisms are designed to degree of protection IP65. The door interlocking prevents accidental opening of the control cabinet door in the ON position of the motor starter protector. The OFF position can be locked with up to 3 padlocks.

**Door-coupling rotary operating mechanisms**

Black

130

3RV29 26-0B

1 unit

0.111

**EMERGENCY-STOP door-coupling rotary operating mechanisms**

Red/  
Yellow

130

3RV29 26-0C

1 unit

0.110

Version	Order No.	Std. pack qty.	Weight approx.
---------	-----------	----------------	----------------

### Tools for opening spring-type terminals by hand



3RA29 08-1A

#### Screwdrivers

for all SIRIUS devices with spring-type terminals  
Length approx. 200 mm,  
3.0 mm x 0.5 mm,  
titanium gray/black,  
partially insulated

#### Spring-type terminals



3RA29 08-1A

1 unit

0.045

### Blank labels

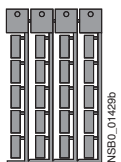

3RT19 00-1SB20

#### Unit labeling plates<sup>1)</sup>

for SIRIUS devices  
20 mm x 7 mm,  
titanium gray

3RT19 00-1SB20

340 units

0.200

<sup>1)</sup> PC labeling system for individual inscription of unit labeling plates available from: Murrplastik Systems, Inc. [www.murrplastik.com](http://www.murrplastik.com).

# SIRIUS 3RA6 Compact Starters

## Add-on modules for AS-Interface

### Overview

Various AS-i add-on modules are available for communication of the 3RA6 compact starter with the control system using AS-Interface:

- Standard version
- With two local inputs
- With two free external inputs
- With one free external input and one free external output
- With two free external outputs
- For local control

The AS-i add-on modules can be combined only in connection with compact starters with a rated control supply voltage of 24 V AC/DC.

#### AS-i add-on module for communications controlling

With this new module it is also possible for the connected compact starter to be operated directly using simple switches, i.e. without recourse to AS-i Communication, if required.

##### "Automatic" mode

NC contacts can be connected to the inputs Y2 and Y4 through the local terminals on the AS-i add-on module. If the "+" connections are connected simultaneously to both local inputs, the AS-i add-on module will be in "Automatic" mode, i.e. it will communicate with the control system through AS-Interface.

##### Local control

Opening the two inputs Y2 and Y4 will result in the direct disconnection of the compact starter. Operation through AS-i Communication is ended and the compact starter can now be switched on and off directly using NO contacts (one NO contact per direction of rotation on the reversing starter).

"LED AUX Power" must light up green, the 24 V DC supply must be connected and the AS-i control supply voltage must no longer be applied.

##### Resetting to "Automatic" mode

Simultaneous application of a "1" signal at the local inputs. The availability bit DI 0 is switched to a "1" signal.

If AS-i Communication is reset, the motor is first switched off and then on again when requested by the control system.

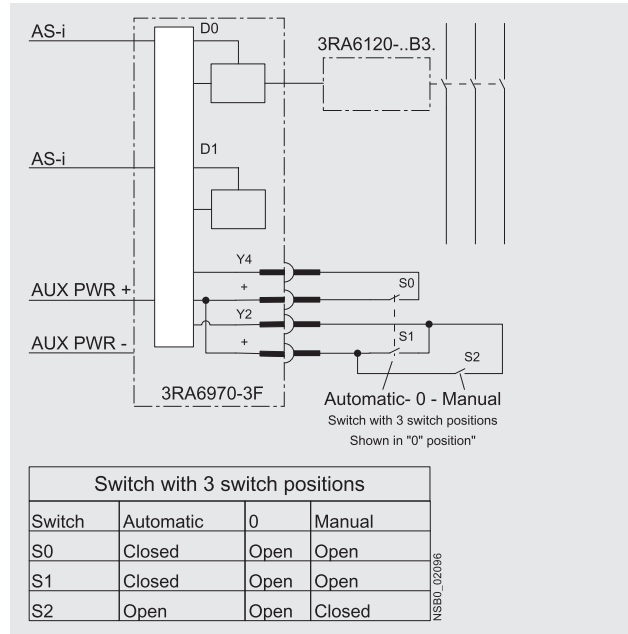

Circuit diagram example for operating a 3RA61 20 direct-on-line starter using an AS-i add-on module for on-site controller

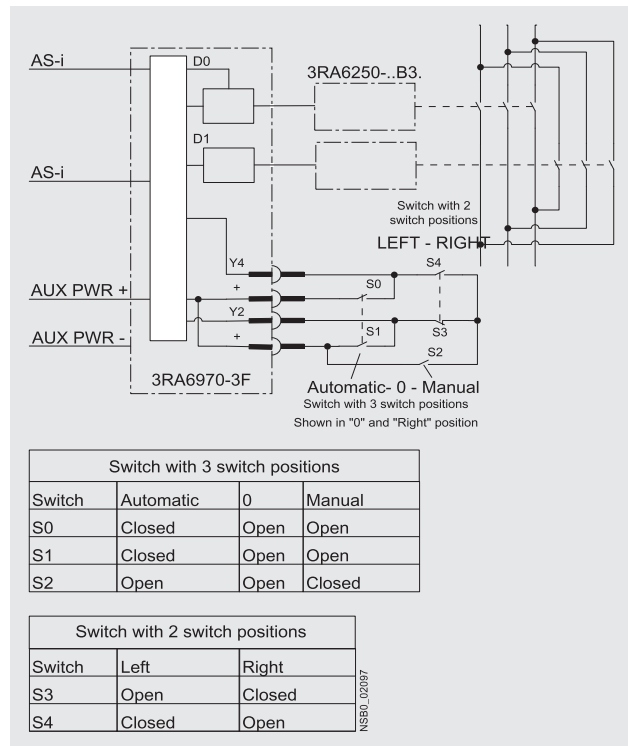

Circuit diagram example for operating a 3RA62 50 reversing starter using an AS-i add-on module for on-site controller



## SIRIUS 3RA6 Compact Starters

## Add-on modules for AS-Interface

## Selection and ordering data

Version	Order No.	Std. pack qty.	Weight approx. kg
<b>AS-i add-on modules</b>			
 <p>3RA69 70-3A</p>	<b>Standard version</b> For communication of the compact starter with the control system using AS-Interface	3RA69 70-3A	1 unit 0.045
	<b>With two local inputs</b> For safe disconnection through local safety relays, e.g. cable-operated switches	3RA69 70-3B	1 unit 0.045
	<b>With two free external inputs</b> Replaces the digital standard inputs "Motor On" and "Group warning"	3RA69 70-3C	1 unit 0.045
 <p>3RA69 70-3B to -3F</p>	<b>With one free external input and one free external output</b> Replaces the digital standard input "Group warning"	3RA69 70-3D	1 unit 0.045
	<b>With two free external outputs</b> Only for direct-on-line starters, replaces the digital standard output "Motor left"	3RA69 70-3E	1 unit 0.045
	<b>For local control</b> Control of the compact starter optionally using AS-Interface or local switches	3RA69 70-3F	1 unit 0.045
<b>Spare parts for AS-i add-on modules</b>			
	<b>Connectors for data and auxiliary supply cable</b> with 2 insulation displacement terminations for standard litz wires 2 x 0.5 ... 0.75 mm <sup>2</sup> <ul style="list-style-type: none"> <li>• Flat, yellow, extender</li> <li>• Flat, black, extender</li> </ul>	3RK1901-0NA00 3RK1901-0PA00	5 units 5 units
<b>Accessories for AS-i add-on modules</b>			
 <p>3RK1904-2AB02</p>	<b>AS-Interface addressing unit V 3.0</b> <ul style="list-style-type: none"> <li>• For AS-Interface modules and sensors and actuators with integrated AS-Interface in accordance with AS-i Specification V3.0</li> <li>• For setting the AS-i address of standard slaves, and slaves with extended addressing mode (A/B slaves)</li> <li>• With input/output test function and many other commissioning functions</li> <li>• Battery operation with 4 batteries type AA (IEC LR6, NEDA 15)</li> <li>• Scope of supply:               <ul style="list-style-type: none"> <li>- Addressing unit with 4 batteries</li> <li>- Addressing cable, with M12 plug to addressing plug (hollow plug), length 1.5m</li> </ul> </li> </ul>	3RK1904-2AB02	1 unit 0.540

# 3RA6 Compact Starters

Infeed systems for 3RA6 – up to 100 A

## Overview

The infeed system for 3RA6 compact starters enables far less wiring in the main circuit and, thanks to the easy exchangeability of the compact starters, reduces the usual downtimes for maintenance work during the plant's operating phase.

The infeed system provides the possibility of completely prewiring the main circuit without a compact starter needing to be connected at the same time. As the result of the removable terminals in the main circuit, compact starters can be integrated in an infeed system in an easy manner (without the use of tools).

In addition, the integrated PE bar means it is optionally possible to connect the motor cable directly to the infeed system without additional intermediate terminals. The infeed system for 3RA6 compact starters is designed for summation currents up to 100 A with a conductor cross-section of max. 2/0 AWG on the feeder terminal block.

The infeed system can be mounted on a standard mounting rail or flat surfaces.

4  
COMBINATION  
STARTERS

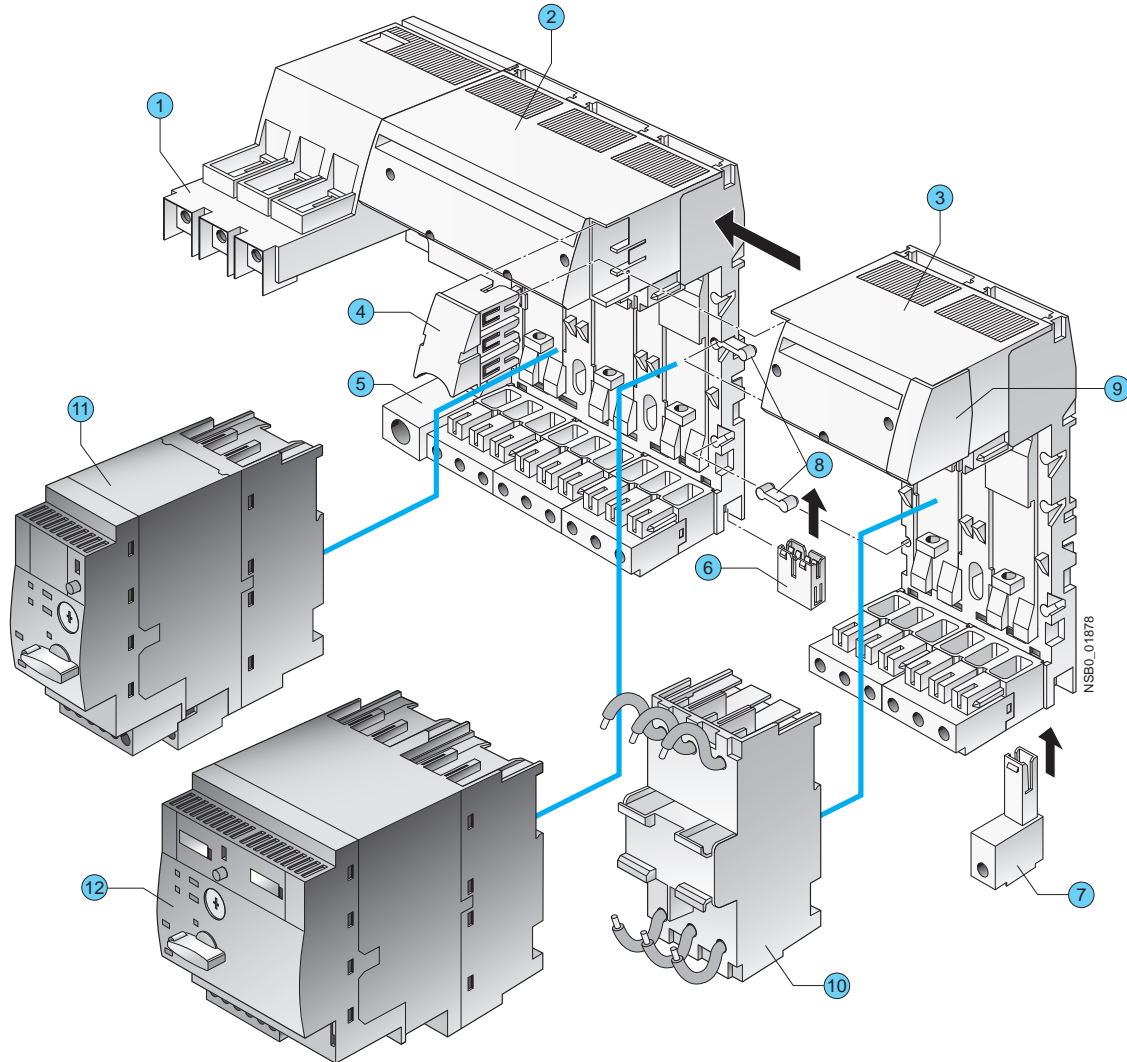

- |                                 |   |
|---------------------------------|---|
| 1 Feeder terminal               | 7 PE tap-off  |
| 2 Three-socket expansion module | 8 Connecting plates   |
| 3 Two-socket expansion module   | 9 End cover   |
| 4 Expansion plug                | 10 45 mm adapter for SIRIUS motor starter protector size S0 |
| 5 PE infeed                     | 11 3RA61 direct-on-line starter                             |
| 6 PE expansion plug             | 12 3RA62 reversing starter                                  |

Infeed system for 3RA6 compact starters

# SIRIUS 3RA6 Compact Starters

## Infeed systems for 3RA6 – up to 100 A

### 1 Infeed

The 3-phase infeed is available as an infeed with screw connection (4-2 AWG up to 63 A or 0-2/0 AWG up to 100 A) and an infeed with spring-type connection (4-2 AWG up to 63 A).

The infeed with spring-type terminal can be attached to the left side, as well as the right side, of an expansion module.

The screw terminal infeeds are permanently fitted to the left side of a 3-socket expansion module.

The infeeds with screw connection enable connection of the main conductors (L1, L2, L3) either from above or from below.

The infeeds with screw connection come packaged with 1 end cover, while the infeed with spring-type connection comes packaged with 2 end covers.

### 2 Three-socket expansion modules

The expansion module with 3 sockets for compact starters is available with screw connection and with spring-type connection.

Expansion modules enable the infeed system to be expanded and can be connected to each other in any number up to a maximum length of 1.2 meters.

Two expansion modules are held together with the help of 2 connecting plates and 1 expansion plug. These assembly parts are included in the scope of supply of the respective expansion module.

When the infeed system for 3RA6 compact starters is used, the compact starters (plug-in modules) are easily mounted and removed even when live.

Optional possibilities:

- PE connection on motor starter side
- Outfeed for external auxiliary devices
- Connection to 3RV29 infeed system
- Integration of SIRIUS 3RV1 and 3RV2 motor starter protectors size S0 up to 25 A (using 3RA68 90-0BA adapter)

### 3 Two-socket expansion modules

If only 2 instead of 3 additional sockets are required, then the 2-socket expansion module is the right choice. It has the same functionality as the 3-socket expansion module.

### 4 Expansion plug

Two expansion modules can be connected together using the expansion plug. Flexible expansion of the infeed system is thus possible.

### 5 PE infeeds

This module enables a PE cable to be connected.

The PE infeed can be ordered with screw connection and spring-type connection (2 AWG) and can be fitted on the right or left to the expansion block.

### 6 PE expansion plug

The PE expansion plug is inserted from below and enables two PE bars to be connected.

### 7 PE tap-off

The PE tap-off is available with screw connection and spring-type connection (10-8 AWG). It is snapped into the infeed system from below.

### 8 Connecting plates

Two connecting plates are used to hold together 2 adjacent expansion modules.

### 9 End covers

On the last expansion module of a row, the slot provided for the expansion plug can be covered by inserting the end cover.

### 10 45 mm adapters for SIRIUS 3RV motor starter protectors

SIRIUS 3RV1 and 3RV2 motor starter protectors size S0 with screw connection can be fitted to the adapter, enabling them to be plugged into the infeed system.

### Terminal blocks

Using the terminal block, three phase power can be fed out of the infeed system; this means that single-phase, two-phase and three-phase components can also be integrated in the system.

If the end cover is removed, the terminal block can be inserted into an expansion module.

### Expansion plug for SIRIUS 3RV29 infeed systems

If the end cover is removed, the expansion plug for the SIRIUS 3RV29 infeed system can be inserted into an expansion module. It connects the infeed system for 3RA6 compact starters with the SIRIUS 3RV29 infeed system.

### Maximum rated operational current

The following maximum rated operational currents apply for the components of the infeed system for 3RA6:

Component	Maximum rated operational current A
Infeed with screw connection 0-2/0 AWG	100
Infeed with screw connection 4-2 AWG	63
Infeed with spring-type connection 4-2 AWG	63
Expansion plugs	63

When several expansion modules are mounted side by side, the maximum rated operational current from the 2nd expansion module to the end of the row is 63 A.

### Proposal for upstream short-circuit protection devices

The following short-circuit data apply for the components of the infeed system for 3RA6 compact starters:

Conductor cross-section AWG	Inscriptions	Proposal for upstream short-circuit protection device
<b>Short-circuit protection for infeed block (4-2 AWG) with screw connection</b>		
14-2	$I_{d, \max} = 19 \text{ kA}$ , $I^2t = 440 \text{ kA}^2\text{s}$	<b>3RV10 41-4JA10</b>
<b>Short-circuit protection for infeed block (0-2/0 AWG) with screw connection</b>		
14-2/0	$I_{d, \max} = \text{approx. } 22 \text{ kA}$	<b>3RV10 41-4MA10</b>
<b>Short-circuit protection for infeed block with spring-type connection</b>		
12	$I_{d, \max} = 9.5 \text{ kA}$ , $I^2t = 85 \text{ kA}^2\text{s}$	<b>3RV10 21-4DA10</b>
10	$I_{d, \max} = 12.5 \text{ kA}$ , $I^2t = 140 \text{ kA}^2\text{s}$	<b>3RV10 31-4EA10</b>
8	$I_{d, \max} = 15 \text{ kA}$ , $I^2t = 180 \text{ kA}^2\text{s}$	<b>3RV10 31-4HA10</b>
6-4	$I_{d, \max} = 19 \text{ kA}$ , $I^2t = 440 \text{ kA}^2\text{s}$	<b>3RV10 41-4JA10</b>
<b>Short-circuit protection for terminal block</b>		
16	$I_{d, \max} = 7.5 \text{ kA}$	<b>5SY...</b> 1)
14	$I_{d, \max} = 9.5 \text{ kA}$	
12	$I_{d, \max} = 9.5 \text{ kA}$	
10	$I_{d, \max} = 12.5 \text{ kA}$	

1) To prevent the possibility of short-circuits, the cables on the terminal block must be installed so that they are short-circuit proof according to EN 60439-1 Section 7.5.5.1.2.

# SIRIUS 3RA6 Compact Starters

Infeed systems for 3RA6 – up to 100 A

## Selection and ordering data

Version	Order No.	Weight approx. kg
---------	-----------	-------------------

### Three-phase infeeds and expansion modules

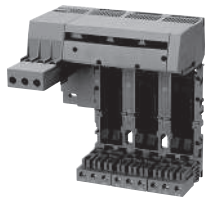



3RA68 12-8AB

**Infeeds with screw connection 4-2 AWG left**

**Infeed with screw connection** with permanently fitted **3-socket expansion module with screw or spring-type terminals on the outgoing side and integrated PE bar**

Expansion module with 3 sockets for 3 direct-on-line starters or 1 direct-on-line starter and 1 reversing starter

- Screw terminals on outgoing side 
- Spring-type terminals on outgoing side 

**Screw terminals** 

<b>3RA68 12-8AB</b>	0.957
<b>3RA68 12-8AC</b>	0.990

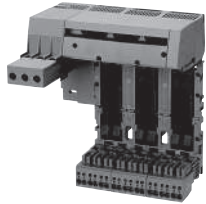

3RA68 12-8AC

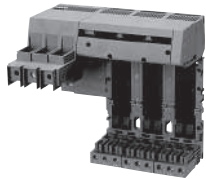



3RA68 13-8AB

**Infeeds with screw connection 0-2/0 AWG left**

**Infeed with screw connection** with permanently fitted **3-socket expansion module with screw or spring-type terminals** on the outgoing side and integrated PE bar

Expansion module with 3 sockets for 3 direct-on-line starters or 1 direct-on-line starter and 1 reversing starter, suitable for UL duty according to UL 508 Type E

- Screw terminals on outgoing side 
- Spring-type terminals on outgoing side 

**Screw terminals** 

<b>3RA68 13-8AB</b>	1.146
<b>3RA68 13-8AC</b>	1.179

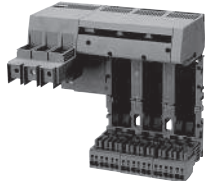

3RA68 13-8AC



3RA68 30-5AC

**Infeeds with spring-type connection 4-2 AWG left or right**

Up to 63 A

**Spring-type terminals** 

<b>3RA68 30-5AC</b>	0.283
---------------------	-------

# SIRIUS 3RA6 Compact Starters

Infeed systems for 3RA6

Version	Order No.	Weight approx. kg
---------	-----------	-------------------

## Expansion modules

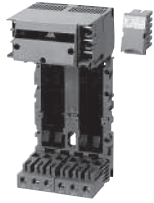

3RA68 22-0AB

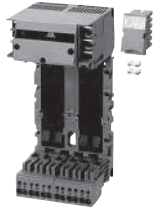

3RA68 22-0AC

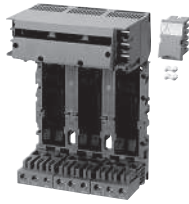

3RA68 23-0AB

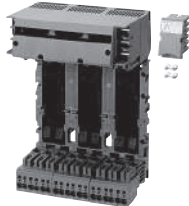

3RA68 23-0AC

### Two-socket expansion modules

**With screw or spring-type terminals** and integrated PE bar with 2 sockets for 2 direct-on-line starters or 1 reversing starter  
Expansion plug and 2 connecting plates are included in the scope of supply.

- Screw terminals

Screw terminals 

**3RA68 22-0AB**

0.505

- Spring-type terminals

Spring-type terminals 

**3RA68 22-0AC**

0.527

### Three-socket expansion modules

**With screw or spring-type terminals** and integrated PE bar with 3 sockets for 3 direct-on-line starters or 1 direct-on-line starter and 1 reversing starter  
Expansion plug and 2 connecting plates are included in the scope of supply.

- Screw terminals

Screw terminals 

**3RA68 23-0AB**

0.717

- Spring-type terminals

Spring-type terminals 

**3RA68 23-0AC**

0.750

# SIRIUS 3RA6 Compact Starters

## Infeed systems for 3RA6

### Accessories

Version	Order No.	Weight approx. kg
---------	-----------	-------------------

#### Accessories for 3RA6 infeed systems

##### PE infeeds 4-2 AWG



3RA68 60-6AB

- Screw terminals

##### Screw terminals



3RA68 60-6AB

0.060



3RA68 60-5AC

- Spring-type terminals

##### Spring-type terminals



3RA68 60-5AC

0.070

##### PE tap-offs 10-8 AWG



3RA68 70-4AB

- Screw terminals

##### Screw terminals



3RA68 70-4AB

0.019



3RA68 70-3AC

- Spring-type terminals

##### Spring-type terminals



3RA68 70-3AC

0.017

##### Expansion plugs

##### PE expansion plugs



3RA68 90-0EA

3RA68 90-0EA

0.008

##### Expansion plugs

between 2 expansion modules  
Is included in the scope of supply of the expansion modules.



3RA68 90-1AB

3RA68 90-1AB

0.029

##### Expansion plugs for SIRIUS 3RV19/29 infeed system

Connects infeed system for 3RA6 to 3RV29 infeed systems



3RA68 90-1AA

3RA68 90-1AA

0.079



# SIRIUS 3RA6 Compact Starters

## Infeed systems for 3RA6

Version	Order No.	Weight approx.
<b>Accessories for infeed systems for 3RA6 (continued)</b>		
 <p>3RA6890-0BA</p>	<p><b>45 mm adapters</b>                      For SIRIUS 3RV1.2 and 3RV2.2 motor starter protectors. Size S0 up to 25 A</p> <ul style="list-style-type: none"> <li>Screw terminals (conductor cross-section AWG 10)</li> </ul>	<p><b>Screw terminals</b> </p> <p><b>3RA6890-0BA</b> 0.152</p>
 <p>3RA6880-2AB</p>	<p><b>Terminal covers for infeeds with screw connection</b>  <b>IP20 terminal covers for infeeds with screw connection 25/35 mm<sup>2</sup> (3RA6812-8AB/AC)</b>                      (2 units per pack)</p>	<p><b>3RA6880-2AB</b></p>
 <p>3RA6880-3AB</p>	<p><b>IP20 terminal covers for infeeds with screw connection 50/70 mm<sup>2</sup> (3RA6813-8AB/AC)</b>                      (2 units per pack)</p>	<p><b>3RA6880-3AB</b></p>
 <p>3RV2917-5D</p>	<p><b>Terminal blocks</b>                      For integration of single-phase, 2-phase and 3-phase external components</p> <ul style="list-style-type: none"> <li>Spring-type terminals</li> </ul>	<p><b>Spring-type terminals</b> </p> <p><b>3RV2917-5D</b> .050</p>
<b>Tools for opening spring-type terminals</b>		
 <p>3RA2908-1A</p>	<p><b>Screwdrivers</b>                      For all SIRIUS devices with spring-type terminals</p> <p>Length approx. 200 mm, 3.0 mm x 0.5 mm, titanium gray/black, partially insulated</p>	<p><b>Spring-type terminals</b> </p> <p><b>3RA2908-1A</b> .045</p>
<b>System Manual "SIRIUS Compact Starters and Accessories"</b>		
<p>The system manual can be downloaded free of charge in PDF format from the Internet, see <a href="http://support.automation.siemens.com/WWW/view/en/27136554/133300">http://support.automation.siemens.com/WWW/view/en/27136554/133300</a></p>		



## SIRIUS 3RA6 Compact Starters

## General data

Type		3RA61	3RA62	3RA64	3RA65
Size		S0			
Number of poles		3			
<b>General technical specifications (continued)</b>					
<b>Protective separation</b>	Acc. to IEC 60947-2				
<b>Control circuit to auxiliary circuit</b>					
• Horizontal standard mounting rail		V	Up to 400		
• Other mounting position		V	Up to 250		
<b>Auxiliary circuit to auxiliary circuit</b>					
• Horizontal standard mounting rail		V	Up to 400		
• Other mounting position		V	Up to 250		
<b>Main circuit to auxiliary circuit</b>					
• Any mounting position		V	Up to 400		
<b>EMC interference immunity</b>	Acc. to IEC/EN 60947-1		Corresponds to degree of severity 3		
<b>Conductor-related interference</b>	BURST acc. to IEC/EN 61000-4-4				
• In the main circuit		kV	4	4	
• In the auxiliary circuit		kV	3	2	
<b>Conductor-related interference</b>	SURGE acc. to IEC/EN 61000-4-5				
• In the main circuit					
- Conductor - Ground		kV	4	2	
- Conductor - Conductor		kV	2	1	
• In the auxiliary circuit					
- Conductor - Ground		kV	2	0.5 <sup>1)</sup>	
- Conductor - Conductor		kV	1	0.5 <sup>1)</sup>	
<b>Auxiliary switches</b>					
• Integrated					
- Position of the main contacts			1 NO + 1 NC	2 NO	1 NO + 1 NC
- Overload/short-circuit signal			1 CO/1 NO		2 NO
• Expandable					
- Position of the main contacts			2 NO, 2 NC, 1 NO + 1 NC		
<b>Surge suppressors</b>			Integrated (Varistor)		
<b>Pollution degree</b>			3		
<b>Depth from standard mounting rail</b>	mm	160			
<b>Electromagnetic operating mechanism</b>					
<b>Control voltage</b>		V	24 AC/DC	24 DC	
		V	110 ... 240 AC/DC	--	
<b>Frequency</b>	At AC	Hz	50/60 (±5%)		
<b>Primary operating range</b>			0.7 ... 1.25 $U_s$		0.85 ... 1.2 $U_s$
<b>No-load switching frequency</b>		1/h	3600		
<b>Make-time</b>		ms	max. 70		Max. 70 + IO-Link communication
<b>Break-time</b>		ms	max. 120		Max. 120 + IO-Link communication

<sup>1)</sup> To maintain maximum interference immunity in a harsh electromagnetic environment, additional overvoltage protection should be provided in the control supply current circuit. A suitable choice is for example the Dehn Blitzductor BVT AD 24 V, Art. No. 918 402 or an equivalent protective element.

Manufacturer: DEHN+SÖHNE GmbH+Co. KG, Hans-Dehn-Straße, 1, Postfach 1640, D-92306 Neumarkt

## SIRIUS 3RA6 Compact Starters

## General data

Type	3RA61 20-□B3., 3RA62 50-□B3. □ = A, B, C or D Rated operational current ≤12 A				3RA61 20-.EB3., 3RA62 50-.EB3. Rated operational current 32 A				
Rated control supply voltage	V	24 AC		24 DC		24 AC		24 DC	
Inrush peak current	A	0.59		0.47		0.59		0.47	
Hold current	A	0.13		0.12		0.17		0.14	
Closed	W	2.8		2.9		3.5		3.1	
Operating times, typical									
• On	ms	<160		<140		<160		<140	
• Off	ms	<35		<35		<30		<30	
Type	3RA61 20-□E3., 3RA62 50-□P3. □ = A, B, C or D Rated operational current ≤12 A				3RA61 20-.EE3., 3RA62 50-.EE3. Rated operational current 32 A				
Rated control supply voltage	V	110 AC	240 AC	110 DC	240 DC	110 AC	240 AC	110 DC	240 DC
Inrush peak current	A	0.24	0.40	0.17	0.29	0.24	0.40	0.17	0.29
Hold current	A	0.06	0.08	0.03	0.02	0.06	0.07	0.04	0.03
Closed	W	3.8	6	3.1	5.1	3.7	5.2	3.4	5.8
Operating times, typical									
• On	ms	<160	<140	<150	<140	<160	<140	<150	<140
• Off	ms	<50	<80	<50	<70	<40	<60	<40	<60
Type	3RA64 00-□B4., 3RA65 00-□B4. □ = A, B, C or D Rated operational current ≤12A				3RA64 00-.EB4., 3RA65 00-.EB4. Rated operational current 32 A				
Rated control supply voltage	V	24 DC				24 DC			
Inrush peak current	A	0.39				0.53			
Hold current	A	0.13				0.15			
Closed	W	2.9				3.4			
Operating times, typical <sup>1)</sup>									
• On	ms	<140				<140			
• Off	ms	<35				<30			

## SIRIUS 3RA6 Compact Starters

## General data

Type		3RA61	3RA62	3RA64	3RA65
Size		<b>S0</b>			
Number of poles		<b>3</b>			
<b>Electromagnetic operating mechanism (continued)</b>					
Switching capacity at 480 V	kA	30 (up to 12 A) 15 (8 ... 32 A)			
Switching capacity at 600 V	kA	10 (up to 12 A) 5 (8 ... 32 A)			
Line protection	At 10 kA At 50 kA	AWG AWG	14 12		
Shock resistance					
• Breaker mechanism OFF		<i>g</i>	25		
• Breaker mechanism ON		<i>g</i>	15		
<b>Normal switching duty</b>					
Making capacity			12 x $I_n$		
Breaking capacity			10 x $I_n$		
Switching capacity dependent on rated current	Up to 12 A Up to 32 A	HP HP	7 1/2 20		
Endurance in operating cycles					
• Electrical endurance	At $I_e = 0.9 \times I_n$ and 400 V		3 ... 10 000 000	2 x 3 ... 10 000 000	3 000 000 2 x 1 500 000
<b>Control circuit</b>					
Rated operational voltage					
• External auxiliary switch block		V	400/690		
• Internal auxiliary switch		V	400/690		
• Short-circuit signaling switch		V	400		
• Overload signaling switch		V	400		
Switching capacity					
• External auxiliary switch block					
	<b>AC-15</b>				
	• At $U_e = 230$ V	A	6		
	• At $U_e = 400$ V	A	3		
	• At $U_e = 289/500$ V	A	2		
	• At $U_e = 400/690$ V	A	1		
	<b>DC-13</b>				
	• At $U_e = 24$ V	A	6		
	• At $U_e = 60$ V	A	0.9		
	• At $U_e = 125$ V	A	0.55		
	• At $U_e = 250$ V	A	0.27		
• Internal auxiliary switch					
	<b>AC-15</b>				
	• At $U_e = 230$ V	A	6		
	• At $U_e = 400$ V	A	3		
	• At $U_e = 289/500$ V	A	2		
	• At $U_e = 400/690$ V	A	1		
	<b>DC-13</b>				
	• At $U_e = 24$ V	A	10		
	• At $U_e = 60$ V	A	2		
	• At $U_e = 125$ V	A	1		
	• At $U_e = 250$ V	A	0.27		
	• At $U_e = 480$ V	A	0.1		
• Signaling switch					
	<b>AC-15</b>				
	• At $U_e = 230$ V	A	3		
	• At $U_e = 400$ V	A	1		
	<b>DC-13</b>				
	• At $U_e = 24$ V	A	2		
	• At $U_e = 250$ V	A	0.11		

## General data





Type			3RA61	3RA62	3RA64	3RA65
Size			S0			
Number of poles			3			
<b>External auxiliary switch block, internal auxiliary switch</b>						
<b>Endurance in operating cycles</b>						
• Mechanical endurance			10 000 000		3 000 000	
• Electrical endurance	<b>AC-15, 230 V</b>		200 000			
	• At 6 A		500 000			
	• At 3 A		2 000 000			
	• At 1 A		10 000 000			
	• At 0,3 A					
	<b>DC-13, 24 V</b>		300 00			
	• At 6 A		100 000			
	• At 3 A		2 000 000			
	• At 0,5 A		10 000 000			
	• At 0,2 A					
	<b>DC-13, 110 V</b>		40 000			
	• At 1 A		100 000			
	• At 0,55 A		300 000			
	• At 0,3 A		2 000 000			
	• At 0,1 A		10 000 000			
	• At 0,04 A					
	<b>DC-13, 220 V</b>		110 000			
	• At 0,3 A		650 000			
	• At 0,1 A		2 000 000			
	• At 0,05 A		10 000 000			
	• At 0,018 A					
<b>Contact stability</b>	At 17 V and 5 mA	Operating cycles	1 incorrect switching operation per 100 000 000			
<b>Short-circuit protection</b>						
• Short-circuit current $I_K \leq 1.1$ kA	Fuse links operational class gG - NEOZED Type 5SE - DIAZED Type 5SB - LV HRC Type 3NA	A	10			
• Short-circuit current $I_K < 400$ A	Miniature circuit breaker up to 230 V with C characteristic	A	10			
<b>Signaling switches</b>						
<b>Endurance in operating cycles</b>						
• Mechanical endurance			20000			
• Electrical endurance AC-15	At 230 V and 3 A		6050			
<b>Contact stability</b>	At 17 V and 5 mA	Operating cycles	1 incorrect switching operation per 100 000 000			
<b>Short-circuit protection</b>						
• Short-circuit current $I_K \leq 1.1$ kA	Fuse links operational class gG - NEOZED Type 5SE - DIAZED Type 5SB - LV HRC Type 3NA	A	6			
• Short-circuit current $I_K < 400$ A	Miniature circuit breaker up to 230 V with C characteristic	A	6			
<b>Overload</b> (short-circuit current $I_K \leq 1.1$ kA)	Fuse links operational class gG - NEOZED Type 5SE - DIAZED Type 5SB - LV HRC Type 3NA	A	4			











## SIRIUS 3RA6 Compact Starters

3RA6 – up to 32 A

## Technical data

Connection type		Screw connection		Spring-type connection	
					
Max. rated current $I_{max}$		12 A	32 A	12 A	32 A
<b>Conductor cross-sections of main circuit terminals</b>					
Tools		Posidrive size 2		(3.5 x 0.5) mm, 8WA2 803	
Prescribed tightening torque		NM 2 ... 2.5		--	
<b>Minimum/maximum conductor cross-sections</b>					
• Solid	mm <sup>2</sup>	2 x (1.5 ... 2.5)	2 x (2.5 ... 6)	2 x (1.5 ... 6)	2 x (2.5 ... 6)
	mm <sup>2</sup>	2 x (2.5 ... 6)	Max. 1 x 10	Max. 1 x 10	Max. 1 x 10
	mm <sup>2</sup>	Max. 1 x 10			
• Finely stranded without ferrule	mm <sup>2</sup>	--	--	2 x (1.5 ... 6)	2 x (2.5 ... 6)
• Finely stranded with ferrule	mm <sup>2</sup>	2 x (1.5 ... 2.5)	2 x (2.5 ... 6)	2 x (1.5 ... 6)	2 x (2.5 ... 6)
	mm <sup>2</sup>	2 x (2.5 ... 6)			
• AWG cables	AWG	2 x (16 ... 14)	2 x (14 ... 10)	2 x (16 ... 10)	2 x (14 ... 10)
	AWG	2 x (14 ... 10)	1 x 8	1 x 8	1 x 8
	AWG				
	AWG	1 x 8			

Connection type		Screw connection		Spring-type connection	
					
<b>Conductor cross-sections of control circuit terminals</b>					
Tools		Posidrive size 2		(3.0 x 0.5) mm, DIN ISO 2380-1A	
Prescribed tightening torque		NM 0.8 ... 1.2		--	
<b>Minimum/maximum conductor cross-sections</b>					
• Solid	mm <sup>2</sup>	1 x (0.5 ... 4)		2 x (0.25 ... 1.5)	
	mm <sup>2</sup>	2 x (0.5 ... 2.5)			
• Finely stranded without ferrule	mm <sup>2</sup>	--		2 x (0.25 ... 1.5)	
• Finely stranded with ferrule	mm <sup>2</sup>	1 x (0.5 ... 2.5)		2 x (0.25 ... 1.5)	
	mm <sup>2</sup>	2 x (0.5 ... 1.5)			
• AWG cables	AWG	2 x (20 ... 14)		2 x (24 ... 16)	

Connection type		Screw connection		Spring-type connection	
					
<b>Conductor cross-sections of the auxiliary switch for compact starters</b>					
Order No.		3RA69 1.-1A		3RA69 1.-2A	
Tools		Posidrive size 2		(2.5 x 0.4) mm, 8WA2 807	
Prescribed tightening torque		NM 0.8 ... 1.2		--	
<b>Conductor cross-sections</b>					
• Solid	mm <sup>2</sup>	2 x (0.5 ... 1.5)		2 x (0.25 ... 2.5)	
	mm <sup>2</sup>	2 x (0.75 ... 2.5)			
	mm <sup>2</sup>	2 x (1 ... 4)			
• Finely stranded without ferrule	mm <sup>2</sup>	--		2 x (0.25 ... 2.5)	
• Finely stranded with ferrule	mm <sup>2</sup>	2 x (0.5 ... 1.5)		2 x (0.25 ... 1.5)	
	mm <sup>2</sup>	2 x (0.75 ... 2.5)			
• AWG cables	AWG	2 x (20 ... 16)		2 x (24 ... 14)	
	AWG	2 x (18 ... 14)			
	AWG	1 x 12			

## SIRIUS 3RA6 Compact Starters

3RA6 – up to 32A

## Technical data

Order No.	3RA6970-3A, 3RA6970-3B, 3RA6970-3C, 3RA6970-3D, 3RA6970-3E
-----------	--

## General data of the AS-i add-on module

<b>Permissible ambient temperature</b>			
• Storage	Acc. to IEC/EN 60721-3-1	°C	-25 ... +70
• Transport	Acc. to IEC/EN 60721-3-2	°C	-25 ... +70
<b>Degree of protection</b>	Acc. to IEC/EN 60947-1		IP20
<b>EMC interference immunity</b>	Acc. to EN 50295		
<b>Conductor-related interference</b>	BURST acc. to IEC/EN 61000-4-4	kV	1/2
<b>Electrostatic discharge</b>	Acc. to IEC/EN 61000-4-2	kV	6/8
<b>Field-related interference</b>	Acc. to IEC/EN 61000-4-3	V/m	10 (80 MHz ... 2.7 GHz)
<b>Maximum pick-up current</b>		mA	400
<b>Maximum hold current</b>		mA	200
<b>Power consumption, max.</b>		mA	30
<b>IO code</b>			7
<b>ID code</b>			A
<b>ID2 code</b>			E

Order No.	3RA6970-3B, 3RA6970-3C, 3RA6970-3D, 3RA6970-3E
Connection type	 Screw connection

## Conductor cross-sections of the AS-i add-on module

<b>Tools</b>		Posidrive size 1
<b>Prescribed tightening torque</b>	NM	0.5 ... 0.6
<b>Conductor cross-sections</b>		
• Solid	mm <sup>2</sup>	1 x (0.5 ... 2.5) 2 x (0.5 ... 1.0)
• Finely stranded with ferrule	mm <sup>2</sup>	1 x (0.5 ... 2.5) 2 x (0.5 ... 1.0)
• AWG cables	AWG	1 x (20 ... 12)

## SIRIUS 3RA6 Compact Starters

Infeed systems for 3RA6 – up to 100 A

**Technical data**

Type		3RA6.	
<b>General data</b>			
<b>Max. rated operational current</b>			
• Infeed with screw connection 0-2/0 AWG	A	100	
• Infeed with screw connection 4-2 AWG	A	63	
• Infeed with spring-type connection 10-3 AWG	A	63	
• Expansion plug	A	63	
<b>Permissible ambient temperature</b>			
• During operation	°C	-20 ... +60 (over +40 current reduction is required)	
- Permissible rated current at control cabinet inside temperature: +40 °C	%	100	
+60 °C	%	80	
• During storage/transport	°C	-55 ... +80	
<b>Relative air humidity</b>			
		% 10 ... 90	
<b>Installation altitude</b>			
		m Up to 2000 above sea level without restriction	
<b>Rated operational voltage <math>U_e</math></b>			
		V 690 AC	
<b>Rated frequency</b>			
		Hz 50/60	
<b>Shock resistance</b>			
		$a = 60 \text{ m/s}^2 = 6g$ with 10 ms; for every 3 shocks in all axes	
<b>Vibratory load</b>			
		$f = 1 \dots 6 \text{ Hz}$ ; $d = 15 \text{ mm}$ 10 cycles $f = 150 \text{ Hz}$ ; $a = 2 g$	
<b>Degree of protection</b>		Acc. to IEC 60947-1	IP20 (IP 00 terminal compartment)
<b>Touch protection</b>		Acc. to EN 50274	Finger-safe
<b>Degree of pollution</b>		3	
<b>Short-circuit protection for infeed with screw connection 4-2 AWG and infeed with screw connection 0-2/0 AWG</b>			
	$I_{d,max}$	kA	< 21
	$I^2t$	kA <sup>2</sup> s	530
			Recommendation for upstream short-circuit protection device 3RV1041-4JA10 3RV1041-4MA10 LV HRC gL/gG 3NA3, 315 A
<b>Short-circuit protection for infeed with spring-type connection</b>			
• Conductor cross-section 12 AWG	$I_{d,max}$	kA	< 9.5
	$I^2t$	kA <sup>2</sup> s	85
• Conductor cross-section 10 AWG	$I_{d,max}$	kA	< 12.5
	$I^2t$	kA <sup>2</sup> s	140
• Conductor cross-section 8 AWG	$I_{d,max}$	kA	< 15
	$I^2t$	kA <sup>2</sup> s	180
• Conductor cross-section 6-4 AWG	$I_{d,max}$	kA	< 19
	$I^2t$	kA <sup>2</sup> s	440
			Recommendation for upstream short-circuit protection device 3RV2021-4DA10 3RV1031-4EA10 3RV1031-4HA10 3RV1041-4JA10
<b>Short-circuit protection for terminal block</b>			
• Conductor cross-section 16 AWG	$I_{d,max}$	kA	7.5
• Conductor cross-section 14 AWG	$I_{d,max}$	kA	9.5
• Conductor cross-section 12 AWG	$I_{d,max}$	kA	9.5
• Conductor cross-section 10 AWG	$I_{d,max}$	kA	12.5
			Recommendation for upstream short-circuit protection device 5SY... <sup>1)</sup>

<sup>1)</sup> To prevent the possibility of short-circuits, the cables on the terminal block must be installed so that they are short-circuit resistant according to EN 60439-1 Section 7.5.5.1.2.

Type		3RV29.	
<b>Connection type</b>		<input type="radio"/> Spring-type connection <input type="checkbox"/>	
<b>Conductor cross-sections of terminal block</b>			
<b>Order No.</b>		3RV29 17-5D	
<b>Conductor cross-sections</b>			
• Solid	mm <sup>2</sup>	1.5 ... 6	
• Finely stranded with ferrule	mm <sup>2</sup>	1.5 ... 4	
• Finely stranded without ferrule	mm <sup>2</sup>	1.5 ... 6	
• AWG cables, solid or stranded	AWG	15 ... 10	

# SIRIUS 3RA6 Compact Starters

Infeed systems for 3RA6 – up to 100 A

COMBINATION STARTERS 4

## Technical data

<b>Type</b>	<b>3RA6.</b>				
<b>Connection type</b>	<b>Screw connection</b>				
<b>Conductor cross-sections of infeed with screw connection 16-2 AWG (L1, L2, L3)<sup>1)</sup> and PE infeed 2 AWG<sup>2)</sup></b>					
<b>Order No.</b>	<b>3RA68 12-8AB, 3RA68 12-8AC, 3RA68 60-6AB</b>				
<b>Tools</b>	Posidrive size 2				
<b>Specified tightening torque</b>	NM	3 ... 4.5			
<b>Conductor cross-sections</b>					
• Solid	mm <sup>2</sup>	2.6 ... 16	2.6 ... 16	max. 2 x 16	
• Stranded	mm <sup>2</sup>	2.5 ... 35	2.5 ... 35	max. 2 x 25	
• Finely stranded with ferrule	mm <sup>2</sup>	2.5 ... 25	2.5 ... 25	max. 2 x 16	
• Finely stranded without ferrule	mm <sup>2</sup>	2.5 ... 25	2.5 ... 25	max. 2 x 16	
• AWG cables	AWG	12 ... 2	12 ... 2	max. 2 x (16 ... 2)	
<b>Connection type</b>	<b>Screw connection</b>				
<b>Conductor cross-sections of infeed with screw connection 10-2/0 AWG (L1, L2, L3)<sup>1)</sup></b>					
<b>Order No.</b>	<b>3RA68 13-8AB, 3RA68 13-8AC</b>				
<b>Tools</b>	SW	4			
<b>Specified tightening torque</b>	NM	6 ... 8			
<b>Conductor cross-sections</b>					
• Solid	mm <sup>2</sup>	2.5 ... 16	2.5 ... 16	max. 2 x 16	
• Stranded	mm <sup>2</sup>	4 ... 70	10 ... 70	max. 2 x 50	
• Finely stranded with ferrule	mm <sup>2</sup>	2.5 ... 35	2.5 ... 50	max. 2 x 35	
• Finely stranded without ferrule	mm <sup>2</sup>	4 ... 50	10 ... 50	max. 2 x 35	
• AWG cables	AWG	10 ... 2/0	10 ... 2/0	max. 2 x (10 ... 1/0)	
<b>Connection type</b>	<b>Spring-type connection</b>				
<b>Conductor cross-sections of infeed with spring-type connection 10-3 AWG (L1, L2, L3)<sup>1)</sup> and PE infeed 3 AWG</b>					
<b>Order No.</b>	<b>3RA68 30-5AC, 3RA68 60-5AC</b>				
<b>Tools</b>	8WA2 806 mm	5.5 x 0.8			
<b>Conductor cross-sections</b>					
• Solid	mm <sup>2</sup>	4 ... 16			
• Stranded	mm <sup>2</sup>	4 ... 35			
• Finely stranded with ferrule	mm <sup>2</sup>	4 ... 25			
• Finely stranded without ferrule	mm <sup>2</sup>	6 ... 25			
• AWG cables	AWG	10 ... 3			
<b>Connection type</b>	<b>Screw connection</b>		<b>Spring-type connection</b>		
<b>Conductor cross-sections of infeed with screw connection 4-2 AWG (T1, T2, T3)<sup>2)</sup>, infeed with screw connection 0-2/0 AWG (T1, T2, T3)<sup>2)</sup> 2-socket and 3-socket expansion modules (T1, T2, T3)<sup>2)</sup> and PE tap-off 10-8 AWG</b>					
<b>Order No.</b>	<b>3RA68 12-8AB, 3RA68 13-8AB, 3RA68 22-0AB, 3RA68 23-0AB, 3RA68 70-4AB</b>		<b>3RA68 12-8AC, 3RA68 13-8AC, 3RA68 22-0AC, 3RA68 23-0AC, 3RA68 70-3AC</b>		
<b>Tools</b>	Posidrive size 2		(3.5 x 0.5) mm, 8WA2 803		
<b>Specified tightening torque</b>	NM	2 ... 2.5		--	
<b>Maximum rated current</b>	A	<b>12</b>	<b>32</b>	<b>12</b>	<b>32</b>
<b>Conductor cross-sections</b>					
• Solid	mm <sup>2</sup>	2 x (1 ... 2.5)	2 x (2.5 ... 6)	2 x (1.5 ... 6)	2 x (2.5 ... 6)
	mm <sup>2</sup>	2 x (2.5 ... 6)	max. 1 x 10	max. 1 x 10	max. 1 x 10
	mm <sup>2</sup>	max. 1 x 10	max. 1 x 10	max. 1 x 10	max. 1 x 10
• Finely stranded with ferrule	mm <sup>2</sup>	--	--	2 x (1.5 ... 6)	2 x (2.5 ... 6)
• Finely stranded without ferrule	mm <sup>2</sup>	2 x (1 ... 2.5)	2 x (2.5 ... 6)	2 x (1.5 ... 6)	2 x (2.5 ... 6)
	mm <sup>2</sup>	2 x (2.5 ... 6)			
• AWG cables	AWG	2 x (16 ... 14)	2 x (14 ... 10)	2 x (16 ... 10)	2 x (14 ... 10)
	AWG	2 x (14 ... 10)			
	AWG	1 x 8	1 x 8	1 x 8	1 x 8

<sup>1)</sup> L1, L2, L3 main conductors on input side.

<sup>2)</sup> T1, T2, T3 main conductors on output side.

# SIRIUS 3RA6 Compact Starters

3RA6 – up to 32 A

## Dimensional drawings

Direct-on-line starters and reversing starters

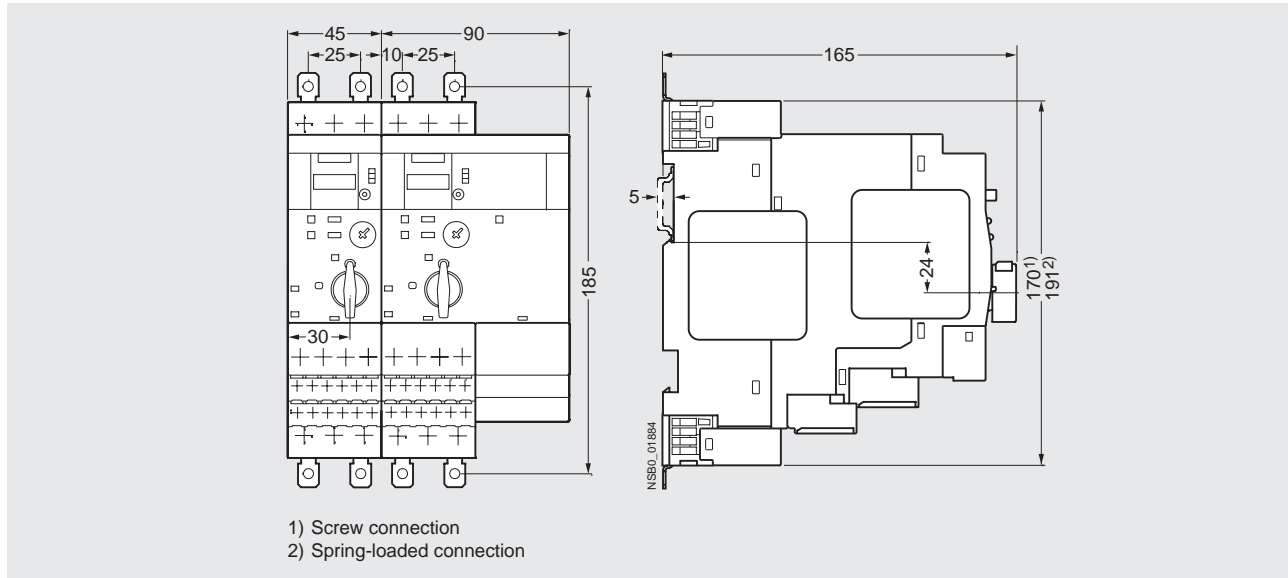

4 COMBINATION STARTERS

## Schematics

3RA61 direct-on-line starters

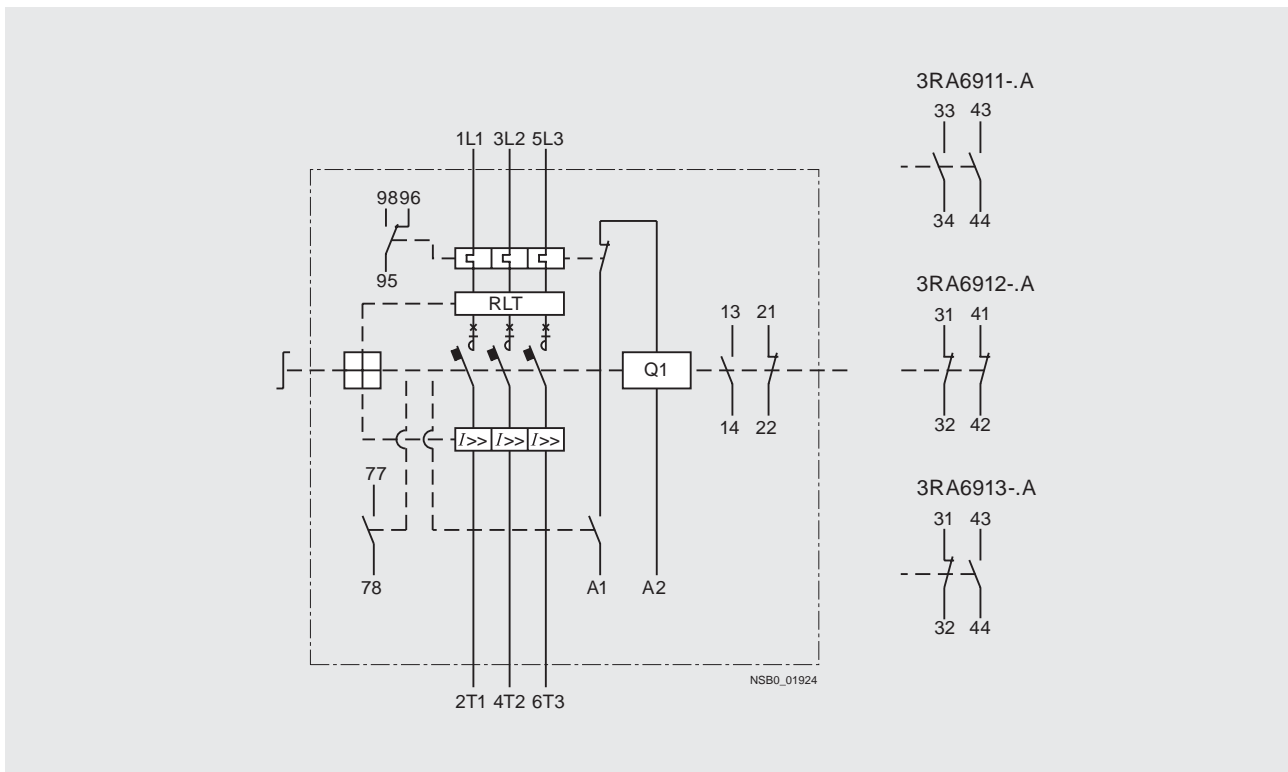

Schematic for 3RA61 direct-on-line starters (main circuit)

# SIRIUS 3RA6 Compact Starters

3RA6 – up to 32 A

## Dimensional drawings

### 3RA62 reversing starters

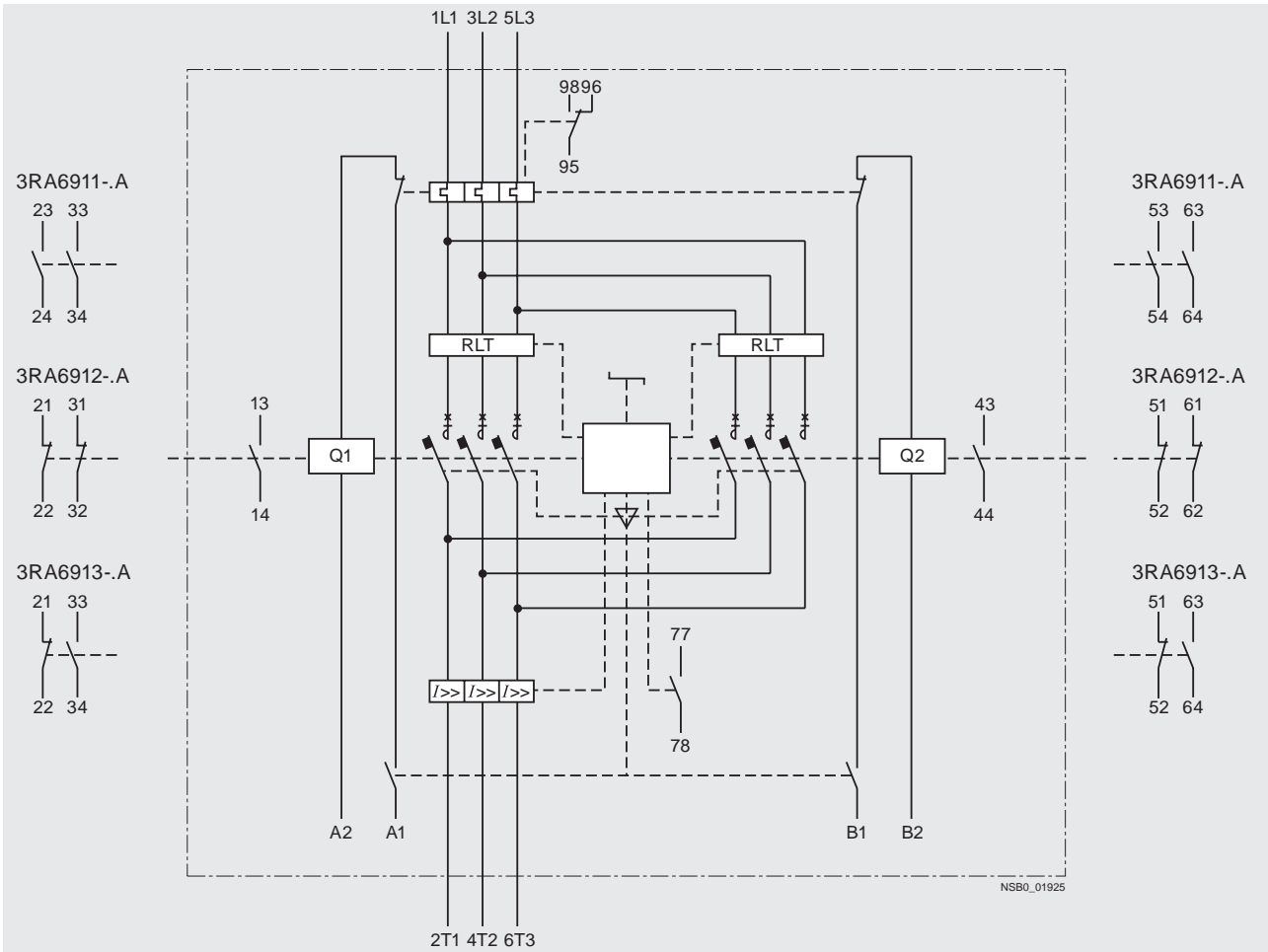

Schematic for 3RA62 reversing starters (main circuit)

# SIRIUS 3RA6 Compact Starters

Infeed systems for 3RA6 – up to 100 A

## Dimensional drawings

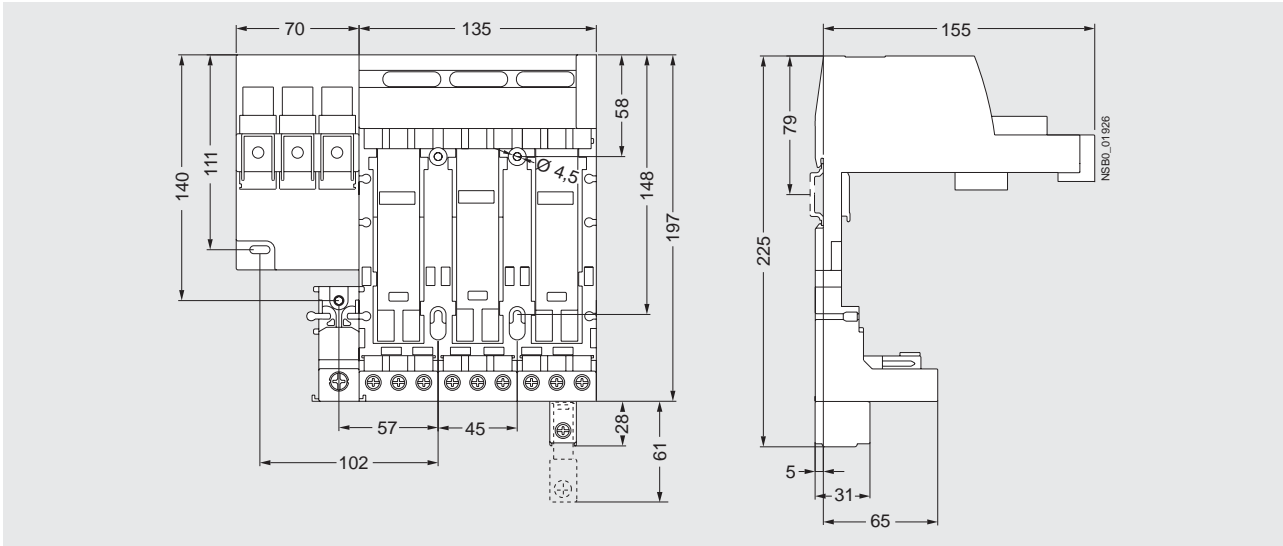

Infeed with screw connection 0-2/0 AWG on left with fixed 3-socket expansion module with outgoing screw terminals

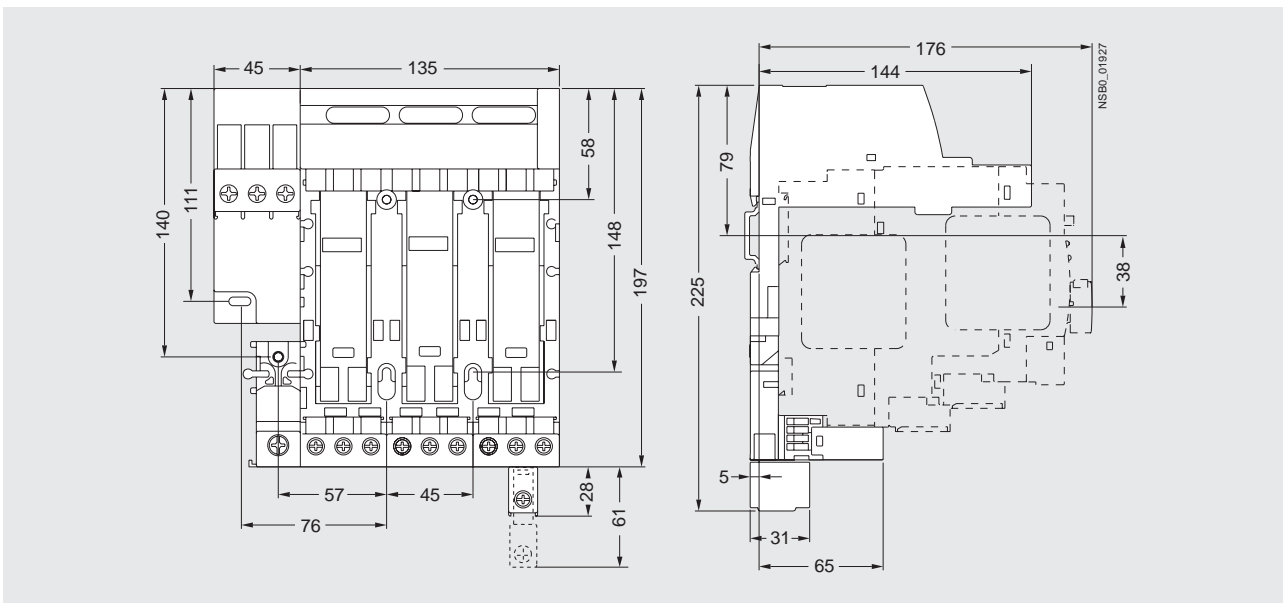

Infeed with screw connection 4-2 AWG on left with fixed 3-socket expansion module with outgoing screw terminals



# SIRIUS 3RA6 Compact Starters

Infeed systems for 3RA6 – up to 100 A

4  
COMBINATION  
STARTERS

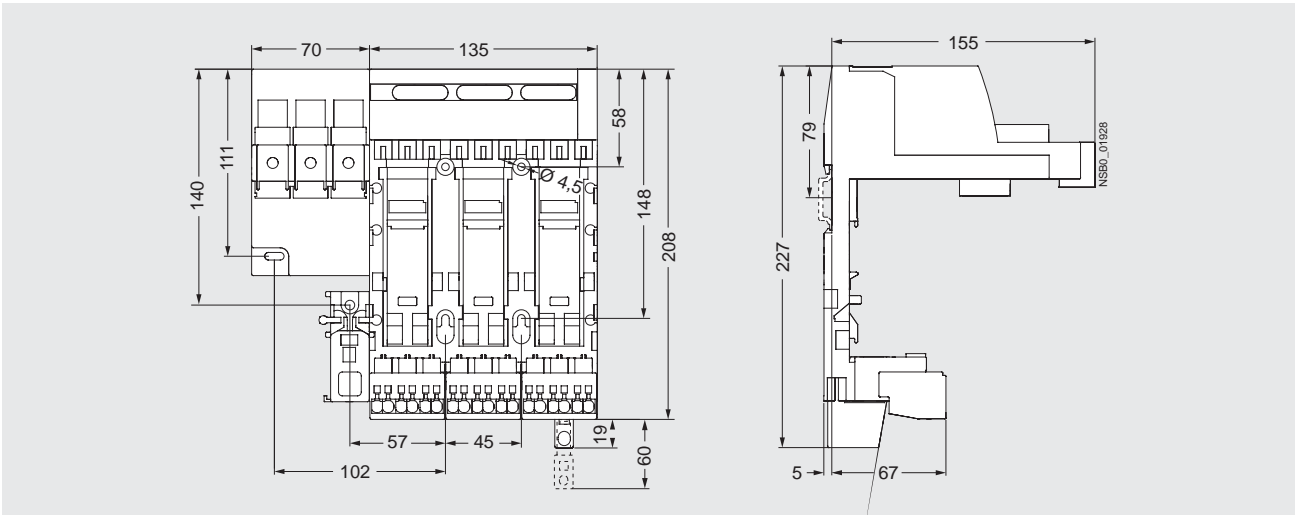

Infeed with screw connection 0-2/0 AWG on left with fixed 3-socket expansion module with outgoing spring-type terminals

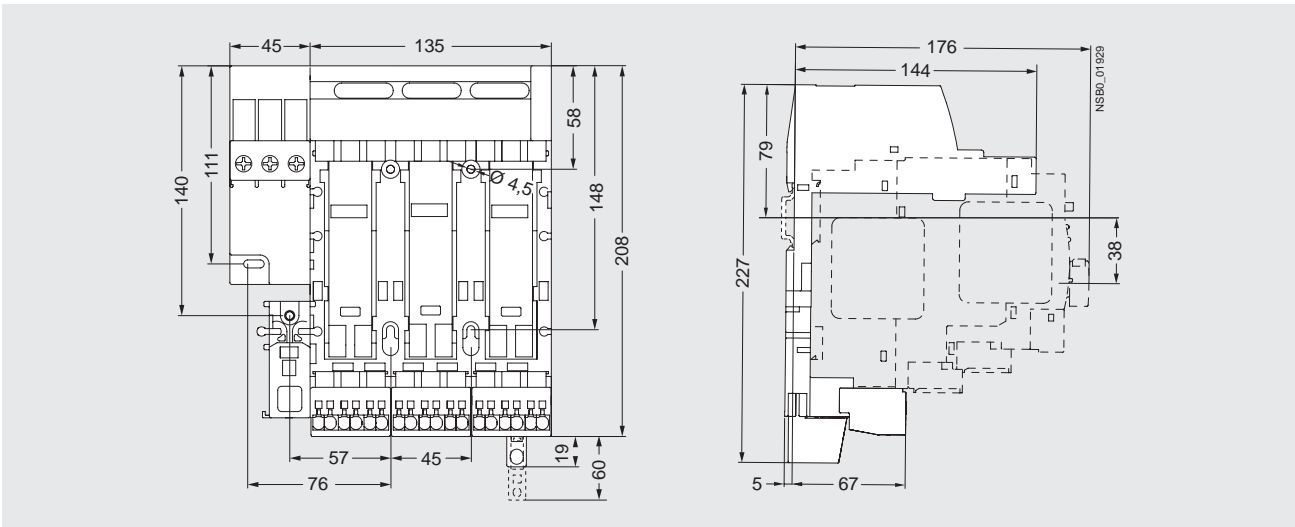

Infeed with screw connection 4-2 AWG on left with fixed 3-socket expansion module with outgoing spring-type terminals

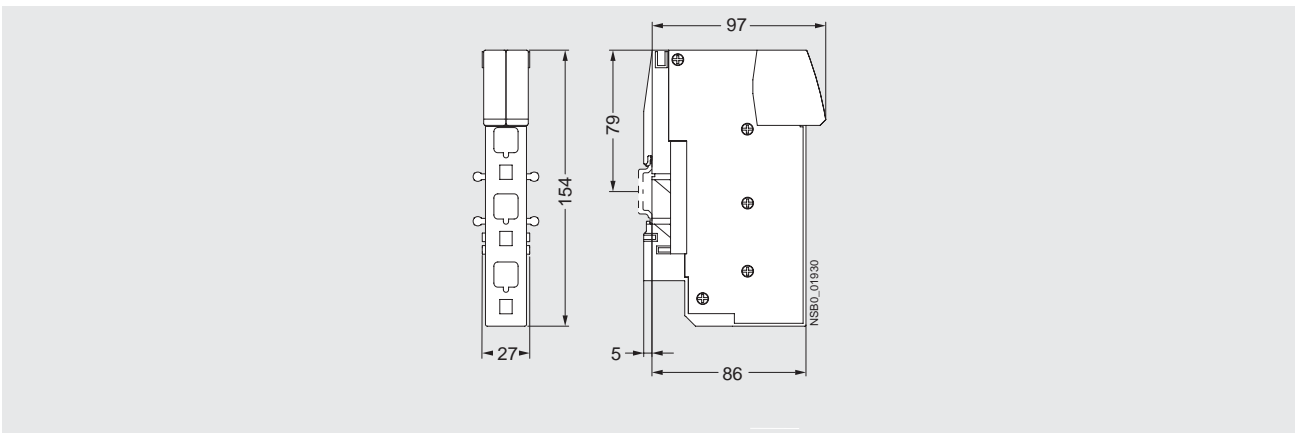

Infeed with spring-type terminals

# SIRIUS 3RA6 Compact Starters

Infeed systems for 3RA6 – up to 100 A

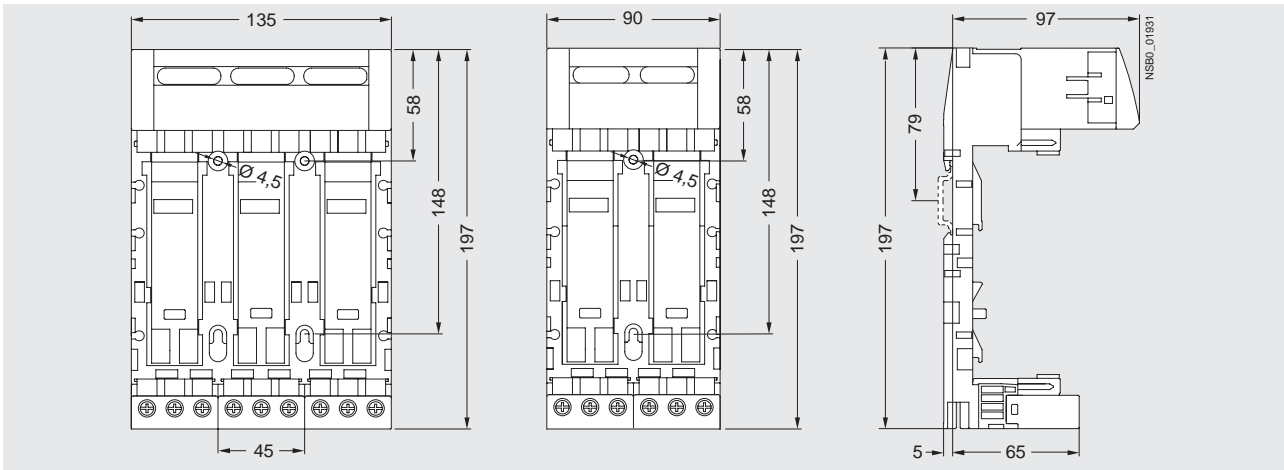

3-socket expansion module and 2-socket expansion module with outgoing screw terminals

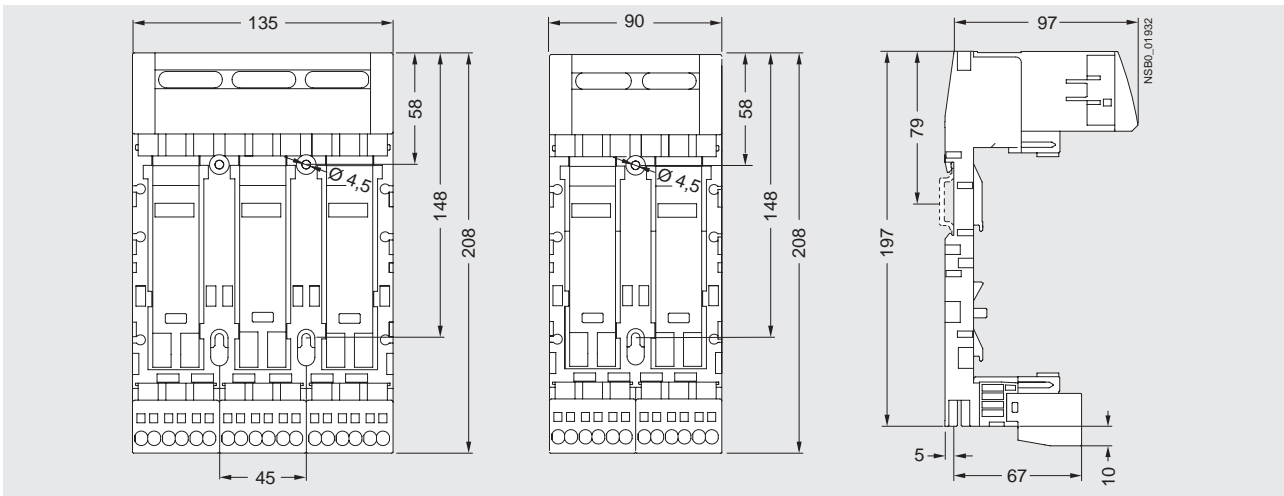

3-socket expansion module and 2-socket expansion module with outgoing spring-type terminals

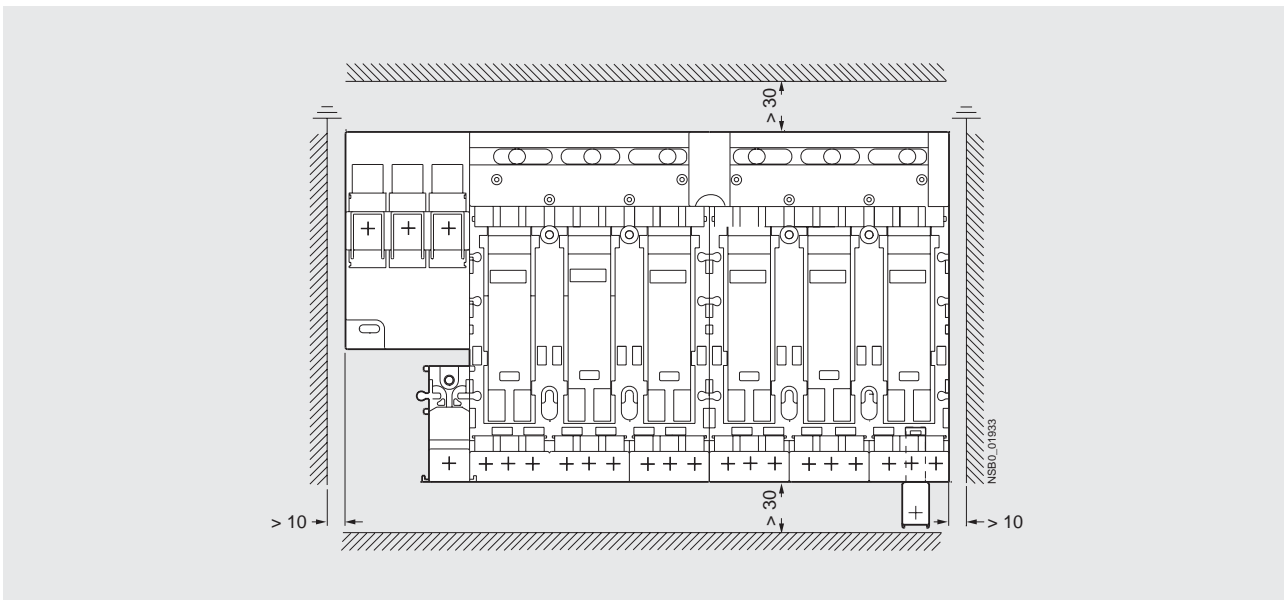

Minimum clearances to adjacent components when using infeed system for 3RA6



# 3RA2 Starters

Non-Reversing, AC Coil – up to 22 A

## Selection and ordering data

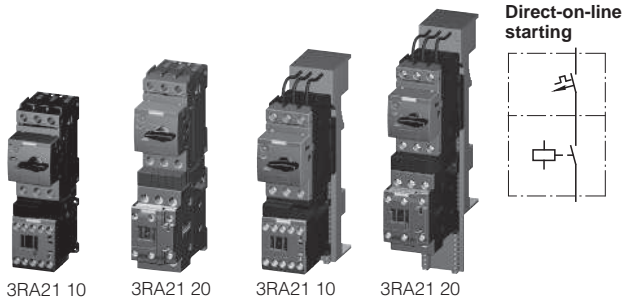

**Rated control supply voltage 50/60 Hz 110/120 V AC  
With screw connections**

- The motor starter protector and contactor are mechanically and electrically connected by means of the link module.
- Auxiliary switches<sup>1)</sup> on the motor starter protector and the contactor can be easily fitted due to the modular system.
- Integrated auxiliary switches:
  - Contactor size S00: 1 NO;
  - Contactor size S0: 1 NO + 1 NC

### Combination Starter, UL508 Type F

All size S00 and S0 devices can be applied as Combination Starters with the addition of either of these line side connectors: 3RV29 28-1H, 3RV29 25-5EB or 3RV29 28-1K.

Size	UL Data		SCCR at 480 V	FLA setting range inverse-time delayed overload release	Consisting of the following single devices			Assembled starter		Weight approx. kg
	Single-phase HP ratings	Three-phase <sup>2)</sup> HP ratings			Motor starter protector	+ Contactor	+ Link module + Busbar adapter <sup>3)</sup>	Screw terminals	Order No.	
	115 V	230 V	200 V	230 V	460 V	575 V	kA	A		

Selection depends on motor full load amps													
							3RV20	3RT20	3RA				
<b>S00</b>	--	--	--	--	--	--	65	0.11...0.16	11-0AA10	15-1AK61	1921-1DA00	<b>3RA21 1□-0A□15-1AK6</b>	0.575
	--	--	--	--	--	--	65	0.14...0.2	11-0BA10		+ 8US1251-5DS10	<b>3RA21 1□-0B□15-1AK6</b>	0.575
	--	--	--	--	--	--	65	0.18...0.25	11-0CA10			<b>3RA21 1□-0C□15-1AK6</b>	0.575
	--	--	--	--	--	--	65	0.22...0.32	11-0DA10			<b>3RA21 1□-0D□15-1AK6</b>	0.575
	--	--	--	--	--	--	65	0.28...0.4	11-0EA10			<b>3RA21 1□-0E□15-1AK6</b>	0.575
	--	--	--	--	--	--	65	0.35...0.5	11-0FA10			<b>3RA21 1□-0F□15-1AK6</b>	0.575
	--	--	--	--	--	--	65	0.45...0.63	11-0GA10			<b>3RA21 1□-0G□15-1AK6</b>	0.575
	--	--	--	--	--	--	65	0.55...0.8	11-0HA10			<b>3RA21 1□-0H□15-1AK6</b>	0.575
	--	--	--	--	--	1/2	65	0.7... 1	11-0JA10			<b>3RA21 1□-0J□15-1AK6</b>	0.575
	--	--	--	--	1/2	1/2	65	0.9... 1.25	11-0KA10			<b>3RA21 1□-0K□15-1AK6</b>	0.575
	--	1/10	--	--	3/4	3/4	65	1.1... 1.6	11-1AA10			<b>3RA21 1□-1A□15-1AK6</b>	0.575
	--	1/8	--	--	3/4	1	65	1.4... 2	11-1BA10			<b>3RA21 1□-1B□15-1AK6</b>	0.575
	--	1/6	1/2	1/2	1	1 1/2	65	1.8... 2.5	11-1CA10			<b>3RA21 1□-1C□15-1AK6</b>	0.575
	1/10	1/4	1/2	3/4	1 1/2	2	65	2.2... 3.2	11-1DA10			<b>3RA21 1□-1D□15-1AK6</b>	0.575
	1/8	1/3	3/4	3/4	2	3	65	2.8... 4	11-1EA10			<b>3RA21 1□-1E□15-1AK6</b>	0.575
	1/6	1/2	1	1	3	3	65	3.5... 5	11-1FA10			<b>3RA21 1□-1F□15-1AK6</b>	0.575
1/4	1/2	1	1 1/2	3	5	65	4.5... 6.3	11-1GA10			<b>3RA21 1□-1G□15-1AK6</b>	0.575	
1/3	1	2	2	5	5	65	5.5... 8	11-1HA10	16-1AK61		<b>3RA21 1□-1H□16-1AK6</b>	0.575	
1/2	1 1/2	2	3	5	7 1/2	65	7... 10	11-1JA10			<b>3RA21 1□-1J□16-1AK6</b>	0.575	
1/2	2	3	3	7 1/2	10	65	9... 12	11-1KA10	17-1AK61		<b>3RA21 1□-1K□17-1AK6</b>	0.575	
1	2	3	5	10	--	65	11... 16	11-4AA10	18-1AK61		<b>3RA21 1□-4A□18-1AK6</b>	0.575	
<b>S0</b>	1/6	1/2	1	1	3	65	3.5... 5	11-1FA10	24-1AK60	2921-1AA00	<b>3RA21 2□-1F□24-0AK6</b>	0.761	
	1/4	1/2	1	1 1/2	3	65	4.5... 6.3	11-1GA10		+ 8US1251-5NT10	<b>3RA21 2□-1G□24-0AK6</b>	0.761	
	1/3	1	2	2	5	65	5.5... 8	11-1HA10			<b>3RA21 2□-1H□24-0AK6</b>	0.761	
	1/2	1 1/2	2	3	5	7 1/2	65	7... 10	11-1JA10		<b>3RA21 2□-1J□24-0AK6</b>	0.761	
	1/2	2	3	3	7 1/2	10	65	9... 12.5	11-1KA10		<b>3RA21 2□-1K□24-0AK6</b>	0.761	
	1	2	3	5	10	--	65	11... 16	21-4AA10	26-1AK60	<b>3RA21 2□-4A□26-0AK6</b>	0.761	
	1 1/2	3	5	5	10	--	65	14... 20	21-4BA10		<b>3RA21 2□-4B□26-0AK6</b>	0.761	
	1 1/2	3	5	7 1/2	15	--	50	17... 22	21-4CA10	27-1AK60	<b>3RA21 2□-4C□27-0AK6</b>	0.761	
	2	3	5	7 1/2	15	--	50	20... 25	21-4DA10		<b>3RA21 2□-4D□27-0AK6</b>	0.761	
	2	5	7 1/2	10	20	--	50	27... 32	21-4EA10		<b>3RA21 2□-4E□27-0AK6</b>	0.761	

### Order No. supplement for:

- Standard DIN rail or screw mounting with no additional auxiliaries
- Standard DIN rail or screw mounting with 1 SPDT NO/NC MSP auxiliary (S00 frame contactor has 1NO auxiliary and S0 frame contactor has 1NO/1NC auxiliary)
- With Fast Bus adaptor and no additional auxiliaries
- With Fast Bus adaptor and 1 SPDT NO/NC MSP auxiliary (S00 frame contactor has 1NO auxiliary and S0 frame contactor has 1NO/1NC auxiliary)

0	A
5	A
0	D
5	D

1) For auxiliary switches see Accessories page 4/44.

2) Selection depends on the motor full load amps. HP ratings for reference only.

3) Used only for mounting starter on 8US Fast Bus busbar systems.

# 3RA2

Non-Reversing, AC and DC Coil – up to 100 A

## Selection and ordering data



### Direct-on-line starting

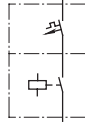

### For 35 mm standard mounting rail or screw mounting

- The motor starter protector and contactor are mechanically and electrically connected by means of the link module.
- Auxiliary switches<sup>1)</sup> on the motor starter protector and the contactor can be easily fitted due to the modular system.
- Integrated auxiliary switches:
  - Contactor size S2: 1 NO & 1 NC
  - Contactor size S3: 1 NO & 1 NC

### Combination Starter, UL508 Type F

- Size S2 devices can be applied as Combination Starters. For versions of 50A or higher, the addition of a 3RV2938-1K line side phase barrier is required.
- Size S3 devices can be applied as Combination Starters with the addition of a 3RT2946-4GA07 line side terminal kit

Single-Phase HP Ratings		Three-Phase <sup>2)</sup> HP ratings				SCCR at 480Y/277V kA	FLA setting range Inverse-time delayed overload release	Starter Order No.	Size	Consisting of the following individual devices		
115V	230V	200V	230V	460V	575V					Motor starter protector	+ Contactor	+ Link module + Adapter for standard mounting rail <sup>3)</sup>
<b>110VAC 50Hz / 120VAC 60 Hz</b>												
3	7.5	10	15	30	<b>40</b>	65	22... 32	<b>3RA21 3□-4EA35-□AK6</b>	<b>S2</b>	3RV20 31-4EA10	3RT2035-1AK60	3RA2931-1AA00 + 3RA2932-1AA00 (must be ordered separately)
3	10	15	15	40	<b>50</b>	65	28... 36	<b>3RA21 3□-4PA36-□AK6</b>	3RT2036-1AK60			
3	10	15	15	40	<b>50</b>	65	32... 40	<b>3RA21 3□-4UA36-□AK6</b>				
3	10	15	15	40	<b>50</b>	65	35... 45	<b>3RA21 3□-4VA36-□AK6</b>	3RT2037-1AK60			
5	10	20	20	50	<b>50</b>	65	42... 52	<b>3RA21 3□-4WA37-□AK6</b>				
5	15	20	25	50	<b>60</b>	20	49... 59	<b>3RA21 3□-4XA38-□AK6</b>	3RT2038-1AK60			
5	15	20	25	50	<b>60</b>	20	54... 65	<b>3RA21 3□-4JA38-□AK6</b>				
7.5	15	25	30	60	<b>60</b>	65	28... 40	<b>3RA21 4□-4FB45-□AK6</b>	<b>S3</b>	3RV20 41-4FA10	3RA1941-1AA00 + 3RA2942-1AA00	
7.5	15	25	30	60	<b>60</b>	65	36... 50	<b>3RA21 4□-4HB45-□AK6</b>	3RT2045-1AK60			
7.5	15	25	30	60	<b>60</b>	65	45... 63	<b>3RA21 4□-4JB45-□AK6</b>				
10	20	30	30	75	<b>75</b>	65	57... 75	<b>3RA21 4□-4KB46-□AK6</b>	3RT2046-1AK60			
10	20	30	30	75	<b>75</b>	65	65... 84	<b>3RA21 4□-4RB46-□AK6</b>				
10	20	30	30	75	-	65	75... 93	<b>3RA21 4□-4YB46-□AK6</b>	3RT2047-1AK60			
10	20	30	40	75	-	65	80...100	<b>3RA21 4□-4MB47-□AK6</b>				

<b>24V UC</b>												
3	7.5	10	15	30	<b>40</b>	65	22... 32	<b>3RA21 3□-4EA35-□NB3</b>	<b>S2</b>	3RV20 31-4EA10	3RT2035-1NB30	3RA2931-1AA00 + 3RA2932-1AA00 (must be ordered separately)
3	10	15	15	40	<b>50</b>	65	28... 36	<b>3RA21 3□-4PA36-□NB3</b>	3RT2036-1NB30			
3	10	15	15	40	<b>50</b>	65	32... 40	<b>3RA21 3□-4UA36-□NB3</b>				
3	10	15	15	40	<b>50</b>	65	35... 45	<b>3RA21 3□-4VA36-□NB3</b>	3RT2037-1NB30			
5	10	20	20	50	<b>50</b>	65	42... 52	<b>3RA21 3□-4WA37-□NB3</b>				
5	15	20	25	50	<b>60</b>	20	49... 59	<b>3RA21 3□-4XA38-□NB3</b>	3RT2038-1NB30			
5	15	20	25	50	<b>60</b>	20	54... 65	<b>3RA21 3□-4JA38-□NB3</b>				
7.5	15	25	30	60	<b>60</b>	65	28... 40	<b>3RA21 4□-4FB45-□NB3</b>	<b>S3</b>	3RV20 41-4FA10	3RA1941-1BA00 + 3RA2942-1AA00	
7.5	15	25	30	60	<b>60</b>	65	36... 50	<b>3RA21 4□-4HB45-□NB3</b>	3RT2045-1NB30			
7.5	15	25	30	60	<b>60</b>	65	45... 63	<b>3RA21 4□-4JB45-□NB3</b>				
10	20	30	30	75	<b>75</b>	65	57... 75	<b>3RA21 4□-4KB46-□NB3</b>	3RT2046-1NB30			
10	20	30	30	75	<b>75</b>	65	65... 84	<b>3RA21 4□-4RB46-□NB3</b>				
10	20	30	30	75	-	65	70... 90	<b>3RA21 4□-4YB46-□NB3</b>	3RT2047-1NB30			
10	20	30	40	75	-	65	80...100	<b>3RA21 4□-4MB47-□NB3</b>				

### Order No. supplement for:

- Standard DIN rail or screw mounting with no additional auxiliaries **0** **0**
- Standard DIN rail or screw mounting with 1 SPDT NO/NC MSP auxiliary (S2 frame contactor has 1NO/1NC integrated auxiliary) **5** **0 (S2)**
- (S3 frame contactor has 1NO top mounted auxiliary) **5** **1 (S3)**

- 1) For auxiliary switches, see accessories page 4/44.
- 2) Selection depends on motor full load amps. Horsepower ratings for reference only.
- 3) Adapters for standard mounting rail are included for all S3 starters and optional to be ordered as accessories for S2 non-reversing starters.

### Note:

In the S2 frame, for 100kA SCCR versions, replace the prefix 3RA213x with 3RA215x. Rating exceptions would be the 59A and 65A versions having a 30kA SCCR at 480Y/277V. For UL 508 type E/F, order 3RV2938-1K Phase Barrier for field installation on all versions.

# 3RA2

Non-Reversing, DC Coil – up to 22 A

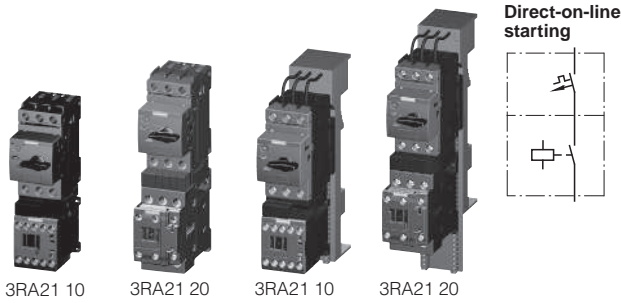

**Rated control supply voltage 24 V DC**  
**With screw connections**

- The motor starter protector and contactor are mechanically and electrically connected by means of the link module.
- Auxiliary switches<sup>1)</sup> on the motor starter protector and the contactor can be easily fitted due to the modular system.
- Integrated auxiliary switches:
  - Contactor size S00: 1 NO;
  - Contactor size S0: 1 NO + 1 NC

**Combination Starter, UL508 Type F**

All size S00 and S0 devices can be applied as Combination Starters with the addition of either of these line side connectors: 3RV29 28-1H, 3RV29 25-5EB or 3RV29 28-1K.

Size	UL Data		SCCR at 480 V	FLA setting range inverse-time delayed overload release	Consisting of the following single devices			Assembled starter		Weight approx. kg
	Single-phase HP ratings	Three-phase <sup>2)</sup> HP ratings			Motor starter protector	+ Contactor	+ Link module + Busbar adapter <sup>3)</sup>	Screw terminals	Order No.	
	115 V	230 V	200 V	230 V	460 V	575 V	kA	A		

**Selection depends on motor full load amps**

											3RV20	3RT20	3RA		
<b>S00</b>	--	--	--	--	--	--	65	0.11...0.16	11-0AA10	15-1BB41	1921-1DA00	<b>3RA21</b> 1□-0A□15-1BB4	0.630		
	--	--	--	--	--	--	65	0.14...0.2	11-0BA10		+ 8US1251-5DS10	<b>3RA21</b> 1□-0B□15-1BB4	0.630		
	--	--	--	--	--	--	65	0.18...0.25	11-0CA10			<b>3RA21</b> 1□-0C□15-1BB4	0.630		
	--	--	--	--	--	--	65	0.22...0.32	11-0DA10			<b>3RA21</b> 1□-0D□15-1BB4	0.630		
	--	--	--	--	--	--	65	0.28...0.4	11-0EA10			<b>3RA21</b> 1□-0E□15-1BB4	0.630		
	--	--	--	--	--	--	65	0.35...0.5	11-0FA10			<b>3RA21</b> 1□-0F□15-1BB4	0.630		
	--	--	--	--	--	--	65	0.45...0.63	11-0GA10			<b>3RA21</b> 1□-0G□15-1BB4	0.630		
	--	--	--	--	--	--	65	0.55...0.8	11-0HA10			<b>3RA21</b> 1□-0H□15-1BB4	0.630		
	--	--	--	--	--	1/2	65	0.7... 1	11-0JA10			<b>3RA21</b> 1□-0J□15-1BB4	0.630		
	--	--	--	--	1/2	65	0.9... 1.25	11-0KA10				<b>3RA21</b> 1□-0K□15-1BB4	0.630		
	1/10	--	--	3/4	3/4	3/4	65	1.1... 1.6	11-1AA10			<b>3RA21</b> 1□-1A□15-1BB4	0.630		
	1/8	1/8	--	3/4	3/4	1	65	1.4... 2	11-1BA10			<b>3RA21</b> 1□-1B□15-1BB4	0.630		
	1/6	1/6	1/2	1/2	1	1	65	1.8... 2.5	11-1CA10			<b>3RA21</b> 1□-1C□15-1BB4	0.630		
	1/10	1/4	1/2	3/4	1 1/2	2	65	2.2... 3.2	11-1DA10			<b>3RA21</b> 1□-1D□15-1BB4	0.630		
	1/8	1/3	3/4	3/4	2	3	65	2.8... 4	11-1EA10			<b>3RA21</b> 1□-1E□15-1BB4	0.630		
	1/6	1/2	1	1	3	3	65	3.5... 5	11-1FA10			<b>3RA21</b> 1□-1F□15-1BB4	0.630		
	1/4	1/2	1	1 1/2	3	5	65	4.5... 6.3	11-1GA10			<b>3RA21</b> 1□-1G□15-1BB4	0.630		
	1/3	1	2	2	5	5	65	5.5... 8	11-1HA10	16-1BB41		<b>3RA21</b> 1□-1H□16-1BB4	0.630		
	1/2	1 1/2	2	3	5	7 1/2	65	7... 10	11-1JA10			<b>3RA21</b> 1□-1J□16-1BB4	0.630		
	1/2	2	3	3	7 1/2	10	65	9... 12	11-1KA10	17-1BB41		<b>3RA21</b> 1□-1K□17-1BB4	0.630		
	1	2	3	5	10	--	65	11...16	11-4AA10	18-1BB41		<b>3RA21</b> 1□-4A□18-1BB4	0.630		
<b>S0</b>	1/6	1/2	1	1	3	3	65	3.5... 5	11-1FA10	24-1BB40	2921-1BA00	<b>3RA21</b> 2□-1F□24-0BB4	0.948		
	1/4	1/2	1	1 1/2	3	5	65	4.5... 6.3	11-1GA10		+ 8US1251-5NT10	<b>3RA21</b> 2□-1G□24-0BB4	0.948		
	1/3	1	2	2	5	5	65	5.5... 8	11-1HA10			<b>3RA21</b> 2□-1H□24-0BB4	0.948		
	1/2	1 1/2	2	3	5	7 1/2	65	7... 10	11-1JA10			<b>3RA21</b> 2□-1J□24-0BB4	0.948		
	1/2	2	3	3	7 1/2	10	65	9... 12.5	11-1KA10			<b>3RA21</b> 2□-1K□24-0BB4	0.948		
	1	2	3	5	10	--	65	11... 16	21-4AA10	26-1BB40		<b>3RA21</b> 2□-4A□26-0BB4	0.948		
	1 1/2	3	5	5	10	--	65	14... 20	21-4BA10			<b>3RA21</b> 2□-4B□26-0BB4	0.948		
	1 1/2	3	5	7 1/2	15	--	50	17... 22	21-4CA10	27-1BB40		<b>3RA21</b> 2□-4C□27-0BB4	0.948		
	2	3	5	7 1/2	15	--	50	20... 25	21-4DA10			<b>3RA21</b> 2□-4D□27-0BB4	0.948		
	2	5	7 1/2	10	20	--	50	27... 32	21-4EA10			<b>3RA21</b> 2□-4E□27-0BB4	0.948		

**Order No. supplement for:**

- Standard DIN rail or screw mounting with no additional auxiliaries
- Standard DIN rail or screw mounting with 1 SPDT NO/NC MSP auxiliary (S00 frame contactor has 1NO auxiliary and S0 frame contactor has 1NO/1NC auxiliary)
- With Fast Bus adaptor and no additional auxiliaries
- With Fast Bus adaptor and 1 SPDT NO/NC MSP auxiliary (S00 frame contactor has 1NO auxiliary and S0 frame contactor has 1NO/1NC auxiliary)

0	A
5	A
0	D
5	D

1) For auxiliary switches, see Accessories page 4/44.  
 2) Selection depends on the concrete motor full load amps. HP ratings for reference only.  
 3) Use only for mounting starter on 8US Fast Bus busbar systems.

# 3RA2 Starters

Non-Reversing Fast Bus® – AC and DC Coil

## Selection and ordering data



### Direct-on-line starting

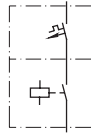

### For 60mm Fast Bus busbar systems

- The motor starter protector and contactor are mechanically and electrically connected by means of the link module.
- Auxiliary switches<sup>1)</sup> on the motor starter protector and the contactor can be easily fitted due to the modular system.
- Integrated auxiliary switches:
  - Contactor size S2: 1 NO & 1 NC
  - Contactor size S3: 1 NO & 1 NC

### Combination Starter, UL508 Type F

- Size S2 devices can be applied as Combination Starters. For versions of 50A or higher, the addition of a 3RV2938-1K line side phase barrier is required.
- Size S3 devices can be applied as Combination Starters with the addition of a 3RT1946-4GA07 line side terminal kit

Single-Phase HP Ratings		Three-Phase <sup>2)</sup> HP ratings				SCCR at 480Y/277V kA	FLA setting range Inverse-time delayed overload release	Starter Order No.	Size	Consisting of the following individual devices			
115V	230V	200V	230V	460V	575V				Motor starter protector	+ Contactor	+ Link module + Adapter for standard mounting rail <sup>3)</sup>		
<b>110VAC 50Hz / 120 VAC 60Hz</b>													
3	7.5	10	15	30	<b>40</b>	65	22... 32	<b>3RA21 3□-4ED35-□AK6</b>	<b>S2</b>	3RV20 31-4EA10	3RT2035-1AK60	3RA2931-1AA00 + 8US1261-6MT10	
3	10	15	15	40	<b>50</b>	65	28... 36	<b>3RA21 3□-4PD36-□AK6</b>		3RV20 31-4PA10	3RT2036-1AK60		
3	10	15	15	40	<b>50</b>	65	32... 40	<b>3RA21 3□-4UD36-□AK6</b>		3RV20 31-4UA10			
3	10	15	15	40	<b>50</b>	65	35... 45	<b>3RA21 3□-4VD36-□AK6</b>		3RV20 31-4VA10	3RT2037-1AK60		
5	10	20	20	50	<b>50</b>	65	42... 52	<b>3RA21 3□-4WD37-□AK6</b>		3RV20 31-4WA10			
5	15	20	25	50	<b>60</b>	20	49... 59	<b>3RA21 3□-4XD38-□AK6</b>		3RV20 31-4XA10	3RT2038-1AK60		
5	15	20	25	50	<b>60</b>	20	54... 65	<b>3RA21 3□-4JD38-□AK6</b>		3RV20 31-4JA10			
7.5	15	25	30	60	<b>60</b>	65	28... 40	<b>3RA21 4□-4FD45-□AK6</b>	<b>S3</b>	3RV20 41-4FA10	3RT2045-1AK60	3RA1941-1AA00 + 8US1211-4TR00	
7.5	15	25	30	60	<b>60</b>	65	36... 50	<b>3RA21 4□-4HD45-□AK6</b>		3RV20 41-4HA10			
7.5	15	25	30	60	<b>60</b>	65	45... 63	<b>3RA21 4□-4JD45-□AK6</b>		3RV20 41-4JA10	3RT2046-1AK60		
10	20	30	30	75	<b>75</b>	65	57... 75	<b>3RA21 4□-4KD46-□AK6</b>		3RV20 41-4KA10			
10	20	30	30	75	<b>75</b>	65	65... 84	<b>3RA21 4□-4RD46-□AK6</b>		3RV20 41-4RA10	3RT2047-1AK60		
10	20	30	30	75	-	65	75... 93	<b>3RA21 4□-4YD46-□AK6</b>		3RV20 41-4YA10			
10	20	30	40	75	-	65	80...100	<b>3RA21 4□-4MD47-□AK6</b>		3RV20 41-4MA10			

<b>24V UC</b>													
3	7.5	10	15	30	<b>40</b>	65	22... 32	<b>3RA21 3□-4ED35-□NB3</b>	<b>S2</b>	3RV20 31-4EA10	3RT2035-1NB30	3RA2931-1AA00 + 8US1261-6MT10	
3	10	15	15	40	<b>50</b>	65	28... 36	<b>3RA21 3□-4PD35-□NB3</b>		3RV20 31-4PA10	3RT2036-1NB30		
3	10	15	15	40	<b>50</b>	65	32... 40	<b>3RA21 3□-4UD35-□NB3</b>		3RV20 31-4UA10			
3	10	15	15	40	<b>50</b>	65	35... 45	<b>3RA21 3□-4VD36-□NB3</b>		3RV20 31-4VA10	3RT2037-1NB30		
5	10	20	20	50	<b>50</b>	65	42... 52	<b>3RA21 3□-4WD36-□NB3</b>		3RV20 31-4WA10			
5	15	20	25	50	<b>60</b>	20	49... 59	<b>3RA21 3□-4XD37-□NB3</b>		3RV20 31-4XA10	3RT2038-1NB30		
5	15	20	25	50	<b>60</b>	20	54... 65	<b>3RA21 3□-4JD37-□NB3</b>		3RV20 31-4JA10			
7.5	15	25	30	60	<b>60</b>	65	28... 40	<b>3RA21 4□-4FD44-□NB3</b>	<b>S3</b>	3RV20 41-4FA10	3RT2045-1NB30	3RA1941-1BA00 + 8US1211-4TR00	
7.5	15	25	30	60	<b>60</b>	65	36... 50	<b>3RA21 4□-4HD44-□NB3</b>		3RV20 41-4HA10			
7.5	15	25	30	60	<b>60</b>	65	45... 63	<b>3RA21 4□-4JD44-□NB3</b>		3RV20 41-4JA10	3RT2046-1NB30		
10	20	30	30	75	<b>75</b>	65	57... 75	<b>3RA21 4□-4KD45-□NB3</b>		3RV20 41-4KA10			
10	20	30	30	75	<b>75</b>	65	65... 84	<b>3RA21 4□-4RD45-□NB3</b>		3RV20 41-4RA10	3RT2047-1NB30		
10	20	30	30	75	-	65	75... 93	<b>3RA21 4□-4YD46-□NB3</b>		3RV20 41-4YA10			
10	20	30	40	75	-	65	80...100	<b>3RA21 4□-4MD46-□NB3</b>		3RV20 41-4MA10			

### Order No. supplement for:

- Standard DIN rail or screw mounting with no additional auxiliaries **0 0**
- Standard DIN rail or screw mounting with 1 SPDT NO/NC MSP auxiliary (S2 frame contactor has 1NO/1NC integrated auxiliary) (S3 frame contactor has 1NO top mounted auxiliary) **5 0 (S2)**  
**5 1 (S3)**

1) For auxiliary switches, see Accessories page 4/44.  
2) Selection depends on motor full load amps. Horsepower ratings for reference only.

### Note:

In the S2 frame, for 100kA SCCR versions, replace the prefix 3RA213x with 3RA215x. Rating exceptions would be the 59A and 65A versions having a 30kA SCCR at 480Y/277V. For UL 508 type E/F, order 3RV2938-1K Phase Barrier for field installation on all versions.



# 3RA2 Starters

Reversing, AC Coil – up to 22 A

## Selection and ordering data

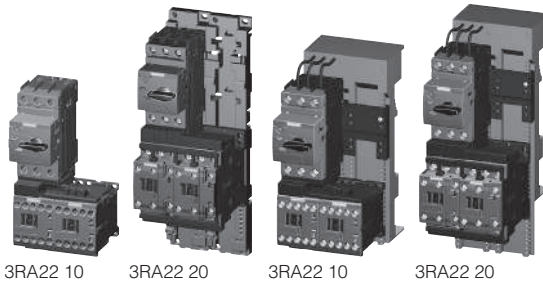

Reversing duty

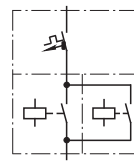

### Rated control supply voltage 50/60 Hz 110/120 V AC With screw connections

- The motor starter protector and contactor are mechanically and electrically connected by means of the link module.
- Auxiliary switches<sup>1)</sup> on the motor starter protector and the contactor can be easily fitted due to the modular system.
- With the contactor S0, an integrated NO contact is available for free use.

### Combination Starter, UL508 Type F

All size S00 and S0 devices can be applied as Combination Starters with the addition of either of these line side connectors: 3RV29 28-1H, 3RV29 25-5EB or 3RV29 28-1K.

Size	UL Data		SCCR at 480 V	FLA setting range inverse-time delayed overload release	Consisting of the following single devices			Assembled starter	Weight approx.
	Single-phase HP ratings	Three-phase <sup>2)</sup> HP ratings			Motor starter protector	+ 2 contactors	+ Link module + Assembly kit RH/RS <sup>3)</sup>		
	115 V	230 V	200 V	230 V	460 V	575 V			
								Order No.	kg

### Selection depends on motor full load amps

							3RV20	3RT20	3RA				
<b>S00</b>	--	--	--	--	--	--	65	0.11...0.16	11-0AA10	15-1AK62	1921-1DA00	<b>3RA22 10-0A</b> □15-2AK6	0.824
	--	--	--	--	--	--	65	0.14...0.2	11-0BA10		+ 2913-2AA1 <sup>4)</sup>	<b>3RA22 10-0B</b> □15-2AK6	0.824
	--	--	--	--	--	--	65	0.18...0.25	11-0CA10		+ 2913-1DB1 (RS)	<b>3RA22 10-0C</b> □15-2AK6	0.824
	--	--	--	--	--	--	65	0.22...0.32	11-0DA10			<b>3RA22 10-0D</b> □15-2AK6	0.824
	--	--	--	--	--	--	65	0.28...0.4	11-0EA10			<b>3RA22 10-0E</b> □15-2AK6	0.824
	--	--	--	--	--	--	65	0.35...0.5	11-0FA10			<b>3RA22 10-0F</b> □15-2AK6	0.824
	--	--	--	--	--	--	65	0.45...0.63	11-0GA10			<b>3RA22 10-0G</b> □15-2AK6	0.824
	--	--	--	--	--	--	65	0.55...0.8	11-0HA10			<b>3RA22 10-0H</b> □15-2AK6	0.824
	--	--	--	--	--	1/2	65	0.7... 1	11-0JA10			<b>3RA22 10-0J</b> □15-2AK6	0.824
	--	--	--	1/2	1/2	1/2	65	0.9... 1.25	11-0KA10			<b>3RA22 10-0K</b> □15-2AK6	0.824
	--	1/10	--	--	3/4	3/4	65	1.1... 1.6	11-1AA10			<b>3RA22 10-1A</b> □15-2AK6	0.824
	--	1/8	--	--	3/4	3/4	65	1.4... 2	11-1BA10			<b>3RA22 10-1B</b> □15-2AK6	0.824
	--	1/6	1/2	1/2	1	1	65	1.8... 2.5	11-1CA10			<b>3RA22 10-1C</b> □15-2AK6	0.824
	1/10	1/4	1/2	3/4	1 1/2	2	65	2.2... 3.2	11-1DA10			<b>3RA22 10-1D</b> □15-2AK6	0.824
	1/8	1/3	3/4	3/4	2	3	65	2.8... 4	11-1EA10			<b>3RA22 10-1E</b> □15-2AK6	0.824
	1/6	1/2	1	1	3	3	65	3.5... 5	11-1FA10			<b>3RA22 10-1F</b> □15-2AK6	0.824
	1/4	1/2	1	1 1/2	3	5	65	4.5... 6.3	11-1GA10			<b>3RA22 10-1G</b> □15-2AK6	0.824
	1/3	1	2	2	5	5	65	5.5... 8	11-1HA10	16-1AK62		<b>3RA22 10-1H</b> □16-2AK6	0.824
	1/2	1 1/2	2	3	5	7 1/2	65	7... 10	11-1JA10			<b>3RA22 10-1J</b> □16-2AK6	0.824
	1/2	2	3	3	7 1/2	10	65	9... 12	11-1KA10	17-1AK62		<b>3RA22 10-1K</b> □17-2AK6	0.824
	1	2	3	5	10	--	65	11...16	11-4AA10	18-1AK62		<b>3RA22 10-4A</b> □18-2AK6	0.824
<b>S0</b>	1/6	1/2	1	1	3	3	65	3.5... 5	11-1FA10	24-1AK60	2921-1AA00	<b>3RA22 20-1F</b> □24-0AK6	1.434
	1/4	1/2	1	1 1/2	3	5	65	4.5... 6.3	11-1GA10		+ 2923-1BB1 (RH)	<b>3RA22 20-1G</b> □24-0AK6	1.434
	1/3	1	2	2	5	5	65	5.5... 8	11-1HA10		+ 2923-1DB1 (RS)	<b>3RA22 20-1H</b> □24-0AK6	1.434
	1/2	1 1/2	2	3	5	7 1/2	65	7... 10	11-1JA10			<b>3RA22 20-1J</b> □24-0AK6	1.434
	1/2	2	3	3	7 1/2	10	65	9... 12.5	11-1KA10			<b>3RA22 20-1K</b> □24-0AK6	1.434
	1	2	3	5	10	--	65	11... 16	21-4AA10	26-1AK60		<b>3RA22 20-4A</b> □26-0AK6	1.434
	1 1/2	3	5	5	10	--	65	14... 20	21-4BA10			<b>3RA22 20-4B</b> □26-0AK6	1.434
	1 1/2	3	5	7 1/2	15	--	50	17... 22	21-4CA10	27-1AK60		<b>3RA22 20-4C</b> □27-0AK6	1.434
	2	3	5	7 1/2	15	--	50	20... 25	21-4DA10			<b>3RA22 20-4D</b> □27-0AK6	1.434
	2	5	7 1/2	10	20	--	50	27... 32	21-4EA10			<b>3RA22 20-4E</b> □27-0AK6	1.434

Add. weight

### Order No. supplement for mounting onto standard mounting rail or screw fixing

- Without standard mounting rail adapter for size S00<sup>4)</sup>
  - With 2 standard mounting rail adapters for size S0
- Screw fixing with 2 push-in lugs each per motor starter is possible

### Order No. supplement for mounting onto Fastbus 60mm busbar system

With 8US Fast Bus busbar adapter

for size S00  
for size S0

1  
2

A  
B

1  
2

D  
D

0.486  
0.293

- 1) For push-in lugs and auxiliary switches, see [Accessories](#) on pages 4/44 and 4/52.
- 2) Selection depends on the motor full load amps. HP ratings for reference only.
- 3) According to ordering option:  
RH = assembly kit for reversing duty with standard rail mounting adapter in size S0.  
RS = assembly kit for reversing duty with 8US Fast Bus busbar mounting.
- 4) With standard rail mounting or screw fixing, the 3RA29 13-2AA1 wiring kit is required for size S00.



# 3RA2

Reversing, AC Coil – up to 100 A

### Selection and ordering data

3RA12 40



### Reversing duty

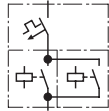

### For 35 mm standard mounting rail or screw mounting

- All starters are suitable for use in Group Installation applications per NEC 430-53 (c)
- Motor starter protector and contactor are linked electrically and mechanically by means of a link module and adapter plate
- Starter includes both electrical and mechanical interlocks
- Auxiliary switches <sup>1)</sup> can be added easily to the MSP and the contactor

### Combination Starter, UL508 Type F

- Size S2 devices can be applied as Combination Starters. For versions of 50A or higher, the addition of a 3RV2938-1K line side phase barrier is required.
- Size S3 devices can be applied as Combination Starters with the addition of a 3RT1946-4GA07 line side terminal kit
- SCCR: 65kA at 480V

Single-Phase HP Ratings		Three-Phase <sup>2)</sup> HP ratings				FLA setting range	Starter Order No.	Size	Consisting of the following individual devices			
115V	230V	200V	230V	460V	575V	Inverse-time delayed overload			Motor starter protector	+ 2 Contactors	+ Link module + assembly kit RH <sup>3)</sup>	
<b>110VAC 50Hz / 120VAC 60Hz</b>												
3	7.5	10	15	30	<b>40</b>	22 ... 32	<b>For customer assembly</b>	<b>S2</b>	3RV20 31-4EA10	3RT2035-1AK60	3RA2931-1AA00 + 3RA2933-1BB1	
3	10	15	15	40	<b>50</b>	28 ... 36			3RV20 31-4PA10	3RT2036-1AK60		
3	10	15	15	40	<b>50</b>	32 ... 40			3RV20 31-4UA10			
3	10	15	15	40	<b>50</b>	35 ... 45			3RV20 31-4VA10			
5	10	20	20	50	<b>50</b>	42 ... 52			3RV20 31-4WA10			3RT2037-1AK60
5	15	20	25	50	<b>60</b>	49 ... 59			3RV20 31-4XA10	3RT2038-1AK60		
5	15	20	25	50	<b>60</b>	54 ... 65	3RV20 31-4JA10					
7.5	15	25	30	60	<b>60</b>	28 ... 40	<b>For customer assembly</b>	<b>S3</b>	3RV20 41-4FA10	3RT2045-1AK60	3RA1941-1AA00 + 3RA1943-1B <sup>4)</sup>	
7.5	15	25	30	60	<b>60</b>	36 ... 50			3RV20 41-4HA10			
7.5	15	25	30	60	<b>60</b>	45 ... 63			3RV20 41-4JA10			
10	20	30	30	75	<b>75</b>	57 ... 75			3RV20 41-4KA10			
10	20	30	30	75	<b>75</b>	65 ... 84			3RV20 41-4RA10			3RT2046-1AK60
10	20	30	30	75	-	75 ... 93			3RV20 41-4YA10			
10	20	30	40	75	-	80 ... 100	3RV20 41-4MA10	3RT2047-1AK60				
<b>24VDC</b>												
3	7.5	10	15	30	<b>40</b>	22... 32	<b>For customer assembly</b>	<b>S2</b>	3RV20 31-4EA10	3RT2035-1NB30	3RA2931-1AA00 + 3RA2933-1BB1	
3	10	15	15	40	<b>50</b>	28... 36			3RV20 31-4PA10	3RT2036-1NB30		
3	10	15	15	40	<b>50</b>	32... 40			3RV20 31-4UA10			
3	10	15	15	40	<b>50</b>	35... 45			3RV20 31-4VA10			
5	10	20	20	50	<b>50</b>	42... 52			3RV20 31-4WA10			3RT2037-1NB30
5	15	20	25	50	<b>60</b>	49... 59			3RV20 31-4XA10	3RT2038-1NB30		
5	15	20	25	50	<b>60</b>	54... 65	3RV20 31-4JA10					
7.5	15	25	30	60	<b>60</b>	28 ... 40	<b>For customer assembly</b>	<b>S3</b>	3RV20 41-4FA10	3RT2045-1NB30	3RA1941-1BA00 + 3RA1943-1B <sup>4)</sup>	
7.5	15	25	30	60	<b>60</b>	36 ... 50			3RV20 41-4HA10			
7.5	15	25	30	60	<b>60</b>	45 ... 63			3RV20 41-4JA10			
10	20	30	30	75	<b>75</b>	57 ... 75			3RV20 41-4KA10			
10	20	30	30	75	<b>75</b>	65 ... 84			3RV20 41-4RA10			3RT2046-1NB30
10	20	30	30	75	-	75 ... 93			3RV20 41-4YA10			
10	20	30	40	75	-	80 ... 100	3RV20 41-4MA10	3RT2047-1NB30				

RH = Reversing duty for rail mounting.

1) For auxiliary switches, see [Accessories page 4/44](#).

2) Selection depends on motor full load amps. Horse power ratings for reference only.

3) Adapters for standard mounting rail are also suitable for screw mounting.

4) Mechanical interlock must be ordered separately; see [Accessories page 4/50](#)

4 COMBINATION STARTERS



# 3RA2

## Reversing Fast Bus<sup>®</sup>, AC and DC Coil – up to 100 A

### Selection and ordering data

Representative image of assembled starter

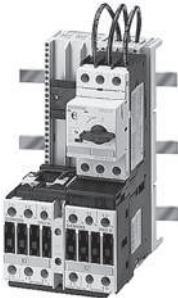

### Reversing duty

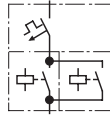

### For 60 mm Fast Bus busbar systems

- All starters are suitable for use in Group Installation applications per NEC 430-53 (c)
- Motor starter protector and contactor are linked electrically and mechanically by means of a link module and mounted on a Fast-bus Shoe
- Starter includes both electrical and mechanical interlocks
- Auxiliary switches<sup>1)</sup> can be added easily to the MSP and the contactor
- Size S3 is kit form only - assembly required

### Combination Starter, UL508 Type F

- Size S2 devices can be applied as Combination Starters
- Size S3 devices can be applied as Combination Starters with the addition of a 3RT2946-4GA07 line side terminal kit
- SCCR: 65kA at 480V

Single-Phase HP Ratings							Three-Phase <sup>2)</sup> HP ratings		FLA setting range Inverse-time delayed overload release	Starter Order No.	Size	Consisting of the following individual devices		
115V	230V	200V	230V	460V	575V	A	Motor starter protector	+ Contactor				+ Link module + Adapter shoe for Fastbus		
<b>110VAC 50Hz / 120VAC 60Hz</b>														
3	7.5	10	15	30	<b>40</b>	22... 32	For customer assembly	22... 32	S2	3RV20 31-4EA10	3RT2035-1AK60	3RA2931-1AA00 + 3RA2933-1DB1		
3	10	15	15	40	<b>50</b>	28... 36				3RV20 31-4PA10	3RT2036-1AK60			
3	10	15	15	40	<b>50</b>	32... 40				3RV20 31-4UA10				
3	10	15	15	40	<b>50</b>	35... 45				3RV20 31-4VA10	3RT2037-1AK60			
5	10	20	20	50	<b>50</b>	42... 52				3RV20 31-4WA10				
5	15	20	25	50	<b>60</b>	49... 59				3RV20 31-4XA10	3RT2038-1AK60			
5	15	20	25	50	<b>60</b>	54... 65	3RV20 31-4JA10							
7.5	15	25	30	60	<b>60</b>	28... 40	For customer assembly	S3	3RV20 41-4FA10	3RT2045-1AK60	3RA1941-1AA00 + 3RA1943-2A <sup>3)</sup>			
7.5	15	25	30	60	<b>60</b>	36... 50			3RV20 41-4HA10					
7.5	15	25	30	60	<b>60</b>	32... 40			3RV20 41-4JA10					
10	20	30	30	75	<b>75</b>	57... 75			3RV20 41-4KA10					
10	20	30	30	75	<b>75</b>	42... 52			3RV20 41-4RA10			3RT2046-1AK60		
10	20	30	30	75	-	75... 93			3RV20 41-4YA10					
10	20	30	40	75	-	80...100	3RV20 41-4MA10	3RT2047-1AK60						
<b>24VDC</b>														
3	7.5	10	15	30	<b>40</b>	22... 32	For customer assembly	22... 32	S2	3RV20 31-4EA10	3RT2035-1NB30	3RA2931-1AA00 + 3RA2933-1DB1		
3	10	15	15	40	<b>50</b>	28... 36				3RV20 31-4PA10	3RT2036-1NB30			
3	10	15	15	40	<b>50</b>	32... 40				3RV20 31-4UA10				
3	10	15	15	40	<b>50</b>	35... 45				3RV20 31-4VA10	3RT2037-1NB30			
5	10	20	20	50	<b>50</b>	42... 52				3RV20 31-4WA10				
5	15	20	25	50	<b>60</b>	49... 59				3RV20 31-4XA10	3RT2038-1NB30			
5	15	20	25	50	<b>60</b>	54... 65	3RV20 31-4JA10							
7.5	15	25	30	60	<b>60</b>	28... 40	For customer assembly	S3	3RV20 41-4FA10	3RT2045-1NB30	3RA1941-1BA00 + 3RA 1943-2A <sup>3)</sup>			
7.5	15	25	30	60	<b>60</b>	36... 50			3RV20 41-4HA10					
7.5	15	25	30	60	<b>60</b>	45... 63			3RV20 41-4JA10					
10	20	30	30	75	<b>75</b>	57... 75			3RV20 41-4KA10					
10	20	30	30	75	<b>75</b>	65... 84			3RV20 41-4RA10			3RT2046-1NB30		
10	20	30	30	75	-	75... 93			3RV20 41-4YA10					
10	20	30	40	75	-	80...100	3RV20 41-4MA10	3RT2047-1NB30						

RH = Reversing duty for rail mounting.

1) For auxiliary switches, see Accessories page 4/44.

2) Selection depends on motor full load amps. Horsepower ratings for reference only.

3) Mechanical interlock must be ordered separately; see Accessories page 4/50.

# 3RA2 Accessories

## Auxiliary switches

### Overview

The accessories listed here are parts and add-ons for the 3RA2 direct-on-line and reversing starters as well as components for the customer assembly of motor starters

### Selection and ordering data

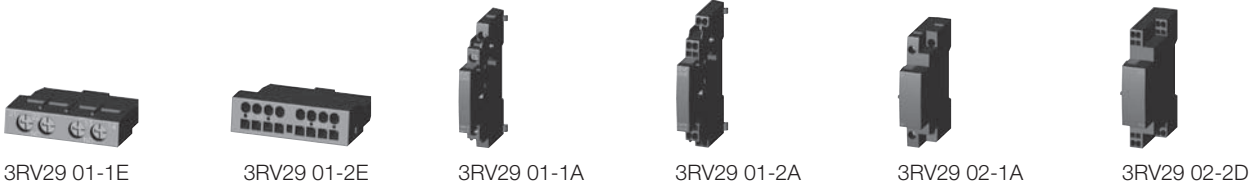

	For MSPs	Screw Terminals	Weight approx.	Spring-type Terminals	Weight approx.
Size	Order No.	kg	Order No.	kg	

### Auxiliary switches for motor starter protectors <sup>1</sup>

#### Transverse auxiliary switches

For front mounting

	For MSPs	Screw Terminals	Weight approx.	Spring-type Terminals	Weight approx.
	Size	Order No.	kg	Order No.	kg
1 CO	S00 ... S3	<b>3RV29 01-1D</b>	0.014	—	—
1 NO + 1 NC	S00 ... S3	<b>3RV29 01-1E</b>	0.016	<b>3RV29 01-2E</b>	0.016

#### Lateral auxiliary switches

Mountable on the left

	For MSPs	Screw Terminals	Weight approx.	Spring-type Terminals	Weight approx.
	Size	Order No.	kg	Order No.	kg
1 NO + 1 NC	S00 ... S3	<b>3RV29 01-1A</b>	0.036	<b>3RV29 01-2A</b>	0.035

<sup>1</sup> One transverse auxiliary switch and one lateral auxiliary switch can be attached per motor starter protector. When the lateral auxiliary switch with 2 NO + 2 NC is used, a transverse auxiliary switch is not allowed.

Rated control supply voltage Us				For MSPs	Screw Terminals	Weight approx.	Spring-type Terminals	Weight approx.
AC 50 Hz	AC 60 Hz	AC 50/60 Hz 100% ON period <sup>1</sup>	AC/DC 50/60 Hz, DC 5s ON period <sup>2</sup>	Size	Order No.	kg	Order No.	kg
V	V	V	V					

### Auxiliary releases for motor starter protectors <sup>3</sup>

#### Undervoltage releases

	For MSPs	Screw Terminals	Weight approx.	Spring-type Terminals	Weight approx.
	Size	Order No.	kg	Order No.	kg
415      480      —      —	S00 ... S3	<b>3RV29 02-1AV1</b>	0.117	—	—

#### Shunt releases

	For MSPs	Screw Terminals	Weight approx.	Spring-type Terminals	Weight approx.
	Size	Order No.	kg	Order No.	kg
—      —      20...24      20...70	S00 ... S3	<b>3RV29 02-1DB0</b>	0.119	<b>3RV29 02-2DB0</b>	0.115
—      —      90...110      70...190		<b>3RV29 02-1DF0</b>	0.119	<b>3RV29 02-2DF0</b>	0.115

<sup>1</sup> The voltage range is valid for 100% (infinite) ON period. The response voltage lies at 0.9 of the lower limit of the voltage range.







<sup>2</sup> The voltage range is valid for 5s ON period at AC 50 Hz/60 Hz and DC. The response voltage lies at 0.85 of the lower limit of the voltage range.

<sup>3</sup> One auxiliary release can be mounted on the right per motor starter protector (does not apply to 3RV21 motor starter protectors with overload reset function).

# 3RA2 Accessories

## Auxiliary switches, terminals

### Selection and ordering data

	For Conductors Size	Version	Screw Terminals Order No.	Weight approx. kg	Spring-type Terminals Order No.	Weight approx. kg
<b>Auxiliary switch blocks for snapping on the front for contactors</b>						
<b>Cable entry from below</b>  3RH29 11-1BA10   3RH29 11-1MA20	S00 ... S3	1-pole 1 NC	<b>3RH29 11-1BA10</b>	0.020	—	
	S00 ... S3	1-pole 1 NO	<b>3RH29 11-1BA01</b>	0.020	—	
	S00 ... S3	2-pole 1 NO + 1 NC	<b>3RH29 11-1MA11</b>	0.050	—	
	S00 ... S3	2-pole 2 NO	<b>3RH29 11-1MA20</b>	0.050	—	
<b>Cable entry from two sides</b>  3RH29 11-1FA22	S00 ... S3	4-pole 2 NO + 2 NC	<b>3RH29 11-1FA22</b>	0.060	<b>3RH29 11-2FA22</b>	0.049
	S00	2-pole 1 NO + 1 NC	<b>3RH29 11-1DA11</b>	0.039	<b>3RH29 11-2DA11</b>	0.050
	S00	2-pole 2 NC	<b>3RH29 11-1DA02</b>	0.039	<b>3RH29 11-2DA02</b>	0.050
	S0 ... S3	2-pole 1 NO + 1 NC	<b>3RH29 21-1DA11</b>	0.039	<b>3RH29 21-2DA11</b>	0.050
	S0 ... S3	2-pole 2 NC	<b>3RH29 21-1DA02</b>	0.041	<b>3RH29 21-2DA02</b>	0.050
	S0 ... S3	2-pole 2 NO	<b>3RH29 21-1DA20</b>	0.041	<b>3RH29 21-2DA20</b>	0.050
<b>Laterally mountable auxiliary switch blocks for contactors</b>						
 3RH29 11-1DA11	S00	2 NC	<b>3RH29 11-1DA02</b>	0.020	<b>3RH29 11-2DA02</b>	0.050
	S00	1 NO + 1 NC	<b>3RH29 11-1DA11</b>	0.040	<b>3RH29 11-2DA11</b>	0.050
	S00	1 NO	<b>3RH29 11-1DA20</b>	0.040	<b>3RH29 11-2DA20</b>	0.050
	S0 ... S3	2 NC	<b>3RH29 21-1DA02</b>	0.050	<b>3RH29 21-2DA02</b>	0.050
	S0 ... S3	1 NO + 1 NC	<b>3RH29 21-1DA11</b>	0.050	<b>3RH29 21-2DA11</b>	0.050
	S0 ... S3	2 NO	<b>3RH29 21-1DA20</b>	0.050	<b>3RH29 21-2DA20</b>	0.050
<b>Connection modules for contactors with screw terminals</b>						
<b>Adaptors for contactors</b>  3RT19 26-4RD01	Ambient temperature $T_{u \max} = 60 \text{ }^\circ\text{C}$					
	S00	Rated operational current $I_e$ at AC-3/400 V: 20A	<b>3RT19 16-4RD01</b>	0.020	—	
	S0	Rated operational current $I_e$ at AC-3/400 V: 25A	<b>3RT19 26-4RD01</b>	0.020	—	
<b>Plugs for contactors</b>  3RT19 00-4RE01	S00, S0		<b>3RT19 00-4RE01</b>	0.025	—	

# 3RA2 Accessories

## Terminals

### Selection and ordering data

For Conductors Size	Version	Screw Terminals	Weight approx. kg
		⊕	
		Order No.	

### Auxillary switch blocks for snapping on the front for contactors



3RV29 28-1H

Note: UL 508 demands for "Combination Motor Controller Type E" 1" air gaps and 2" creepage distances at lineside. The following terminal blocks must be used in S3 MSP's 3RV10. The S2 MSP 3RV10 conforms with stipulated air gaps and creepage distances without terminal block. Terminal blocks are not required for use according to CSA. With size S0 these terminal blocks cannot be used in combination with 3-phase busbars 3RV19.5. This also applies to size S3 in combination with transverse auxiliary switches.

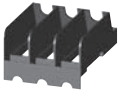

3RV29 28-1K

**Terminal block type E**  
for extended air/creepage distance (1" and 2")

S00, S0	<b>3RV29 28-1H</b>	0.120
S00, S0	<b>3RV29 28-1K</b>	0.120
S2	<b>3RV29 38-1K</b>	0.120
S3	<b>3RT29 46-4GA07</b>	0.120



3RT19 46-4GA07

# 3RA2 Accessories

## Surge suppressors

### Selection and ordering data

For Conductors Size	Version	Rated control supply voltage $U_s$		Surge Suppressors Order No.	Weight approx. kg
		AC V	DC V		

### Auxiliary switch blocks for snapping on the front for contactors

#### Size S00 — For plugging onto the front side of the contactors with and without auxiliary switch blocks

	3RT2.1	Varistors	24 ... 48 AC	24 ... 70 DC	<b>3RT29 16-1BB00</b>	0.010
			48 ... 127 AC	70 ... 150 DC	<b>3RT29 16-1BC00</b>	0.010
	3RT2.1	RC elements	24 ... 48 AC	24 ... 70 DC	<b>3RT29 16-1CB00</b>	0.010
			48 ... 127 AC	70 ... 150 DC	<b>3RT29 16-1CC00</b>	0.010
	3RT2.1	Noise suppression		12 ... 250 DC	<b>3RT29 16-1DG00</b>	0.010
3RT2.1	Diode assemblies (diode and Zener diode) for DC operation and short break times		12 ... 250 DC	<b>3RT29 16-1EH00</b>	0.010	

3RT29 16-1EH00

#### Size S0 — For plugging onto the front side of the contactors (prior to mounting of the auxiliary switch block)

	3RT2.2	Varistors	24 ... 48 AC	24 ... 70 DC	<b>3RT29 26-1BB00</b>	0.010
			48 ... 127 AC	70 ... 150 DC	<b>3RT29 26-1BC00</b>	0.010
	3RT2.2	RC elements	24 ... 48 AC	24 ... 70 DC	<b>3RT29 26-1CB00</b>	0.010
			48 ... 127 AC	70 ... 150 DC	<b>3RT29 26-1CC00</b>	0.010
3RT2.2	Diode assemblies for DC operation and short break times		24 DC 30 ... 250 DC	<b>3RT29 26-1ER00</b> <b>3RT29 26-1ES00</b>	0.010 0.010	

3RT29 26-1BB00

#### Sizes S2

	3RT2.3	Varistors	24 ... 48 AC	24 ... 70 DC	<b>3RT29 36-1BB00</b>	0.010
			127 ... 240 AC	150 ... 250 DC	<b>3RT29 36-1BD00</b>	0.010
			48 ... 127 AC	70 ... 150 DC	<b>3RT29 36-1BC00</b>	0.010
3RT2.3	RC elements	24 ... 48 AC	24 ... 70 DC	<b>3RT29 36-1CB00</b>	0.010	
		127 ... 240 AC	150 ... 250 DC	<b>3RT29 36-1CD00</b>	0.010	
		48 ... 127 AC	70 ... 150 DC	<b>3RT29 36-1CC00</b>	0.010	

3RT2936-1B.00

	3RT2.3	Diode assemblies	--	24 DC	<b>3RT29 36-1ER00</b>	0.010
			--	30 ... 250 DC	<b>3RT29 36-1ES00</b>	0.010

3RT2936-1E.00

#### Sizes S3

	3RT20 4.	Varistors	24 ... 48 AC	24 ... 70 DC	<b>3RT29 36-1BB00</b>	0.025
			48 ... 127 AC	70 ... 150 DC	<b>3RT29 36-1BC00</b>	0.025
	3RT20 4.	RC elements	24 ... 48 AC	24 ... 70 DC	<b>3RT29 36-1CB00</b>	0.040
			48 ... 127 AC	70 ... 150 DC	<b>3RT29 36-1CC00</b>	0.040
	3RT20 4.	Diode assemblies for DC operation and short break times, can be plugged in at bottom		24 DC 30 ... 250 DC	<b>3RT29 36-1ER00</b> <b>3RT29 36-1ES00</b>	0.025 0.025

3RT2936-1CC00

For additional surge suppression, [see page 2/73](#)



# 3RA2 Accessories

## Surge suppressors, link modules

### Selection and ordering data

	For MSP Size	For contactors	Actuating voltage of contactor	Screw Terminals Order No.	Pack Qty.	Weight approx. kg
--	--------------	----------------	--------------------------------	---------------------------	-----------	-------------------

#### Auxiliary switch blocks for snapping on the front for contactors

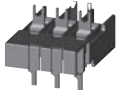

3RA29 11-2AA00

Electrical and mechanical link between motor starter protector and contactor

Single-unit packaging	S00, S0	S00	AC and DC	<b>3RA19 21-1DA00</b>		
	S00, S0	S0	AC	<b>3RA29 21-1AA00</b>	1 unit	0.055
	S00, S0	S0	DC	<b>3RA29 21-1BA00</b>	1 unit	0.068
	S2	S2	AC and DC	<b>3RA29 31-1AA00</b>	1 unit	0.104
	S3	S3	AC and DC	<b>3RA19 41-1AA00</b>	1 unit	0.090
Multi-unit packaging	S00, S0	S00	AC and DC	<b>3RA19 21-1D</b>	10 unit	0.021
	S00, S0	S0	AC	<b>3RA29 21-1A</b>	10 unit	0.001
	S00, S0	S0	DC	<b>3RA29 21-1B</b>	10 unit	0.001
	S2	S2	AC and DC	<b>3RA29 31-1A</b>	5 unit	0.104
	S3	S3	AC and DC	<b>3RA19 41-1A</b>	5 unit	0.073

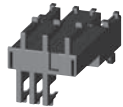

3RA29 11-2AA00

Electrical and mechanical link between motor starter protector and contactor

	For MSP Size	For contactors	Actuating voltage of contactor	Spring-type Terminals Order No.	Pack Qty.	Weight approx. kg
Single-unit packaging	S00	S00	AC and DC	<b>3RA29 11-2AA00</b>		
	S0	S0	AC <sup>1)</sup> and DC	<b>3RA29 21-2AA00</b>	1 unit	0.040
Multi-unit packaging	S00	S00	AC and DC	<b>3RA29 11-2A</b>	10 unit	0.400
	S0	S0	AC <sup>1)</sup> and DC	<b>3RA29 21-2A</b>	10 unit	0.770

#### Hybrid link modules from motor starter protector to contactor

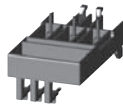

3RA29 11-2FA00

For mechanical and electrical connection between motor starter protector with screw terminals and contactor with spring-type terminals

Single-unit packaging	S00	S00	AC and DC	<b>3RA29 11-2FA00</b>	1 unit	0.029
	S0	S0	AC <sup>1)</sup> and DC	<b>3RA29 21-2FA00</b>	1 unit	0.056
Multi-unit packaging	S00	S00	AC and DC	<b>3RA29 11-2F</b>	10 unit	0.290
	S0	S0	AC <sup>1)</sup> and DC	<b>3RA29 21-2F</b>	10 unit	0.560

	For MSPs Size	For soft starters Size	Screw Terminals Order No.	Pack Qty.	Weight approx. kg
--	---------------	------------------------	---------------------------	-----------	-------------------

#### Link modules from motor starter protector to soft starters

Electrical and mechanical link between motor starter protector and soft starter

Single-unit packaging	S00/S0		S00/S0	<b>3RA29 21-1BA00</b>	1 unit	0.001
	S00/S0		S00/S0	<b>3RA29 21-1B</b>	10 unit	0.001

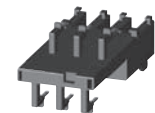

3RA29 11-2GA00

Electrical and mechanical link between motor starter protector and soft starter







	For MSPs Size	For soft starters Size	Screw Terminals Order No.	Pack Qty.	Weight approx. kg
Single-unit packaging	S00	S00	<b>3RA29 11-2GA00</b>	1 unit	0.038
	S0	S0	<b>3RA29 21-2GA00</b>	1 unit	0.072
Multi-unit packaging	S00	S00	<b>3RA29 11-2G</b>	10 unit	0.380
	S0	S0	<b>3RA29 21-2G</b>	10 unit	0.720

<sup>1)</sup> A spacer for height compensation on AC contactors with spring-type terminals, size S0 is optionally available, see page 4/52.

# 3RA2 Accessories

## Mounting kits for Fast Bus







### Accessories

	For Conductors Size	Version	Screw Terminals  Order No.	Pack Qty.	Weight approx. kg
<b>Wiring kits for contactors</b>					
 <p>3RA29 23-2AA1</p>	<b>Reversing</b>				
	S00	Electrical and mechanical connection for reversing contactors, optionally with integrated electrical and mechanical interlock	<b>3RA29 13-2AA1</b>	1 unit	0.001
	S0		<b>3RA29 23-2AA1</b>	1 unit	0.001
	S2	The kit contains: 2 connecting pins for 2 contactors, wiring modules on the top and bottom • for main and auxiliary circuits	<b>3RA29 33-2AA1</b>	1 unit	0.120
 <p>3RA29 23-2BB1</p>	<b>Wye-delta starting</b>				
	S00	Electrical and mechanical link for three contactors of same size	<b>3RA29 13-2BB1</b>	1 unit	0.001
	S0		<b>3RA29 23-2BB1</b>	1 unit	0.001
	S2-S2-S0		<b>3RA29 33-2C</b>	1 unit	0.070
	S2-S2-S2		<b>29RA2933-2BB1</b>	1 unit	0.160
<b>Spring-type Terminals </b>					
 <p>3RA29 23-2AA2</p>	<b>Reversing Duty</b>				
	S00	Electrical and mechanical connection for reversing contactors, optionally with integrated electrical and mechanical interlock	<b>3RA29 13-2AA2</b>	1 unit	0.001
	S0		<b>3RA29 23-2AA2</b>	1 unit	0.001
	S2	The kit contains: 2 connecting pins for 2 contactors, wiring modules on the top and bottom • for main circuits only	<b>3RA29 33-2AA2</b>	1 unit	0.001
	<b>Wye-delta starting</b>				
	S00	Electrical and mechanical link for three contactors of same size	<b>3RA29 13-2BB2</b>	1 unit	0.001
	S0		<b>3RA29 23-2BB2</b>	1 unit	0.001
	S2-S2-S0		<b>3RA29 33-2C</b>	1 unit	0.001
	S2-S2-S2		<b>3RA29 33-2BB2</b>	1 unit	0.001
<b>Screw Terminals </b>					
<b>Wiring kits for contactors</b>					
 <p>3RA29 16-1A</p>	<b>Reversing</b>				
	S00	Switches 2 contactors in series	<b>3RA29 16-1A</b>	1 unit	0.001
	S0		<b>3RA29 26-1A</b>	1 unit	0.001
	S2		<b>3RA29 36-1A</b>	1 unit	0.001

# 3RA2 Accessories

## Mounting kits for Fast Bus

### Accessories

	For Conductors Size	For MSPs Size	Version	Screw Terminals Order No.	⊕	Pack Qty.	Weight approx. kg
<b>Mechanical interlocks</b>							
	S2/S3	--	For reversing contactors, laterally mounted, no electrical connections (each contactor has 1NO/1NC auxiliaries)	<b>3RA29 34-2B</b>			0.010
3RA29 34-2B							
<b>Terminals for contactor coil</b>							
	S3	--	For A1 and A2 of reversing contactors (includes 2 x A1 and 1 x A2)	<b>3RA19 23-3B</b>			0.020
3RA19 23-3B							
<b>Standard mounting rail adaptors</b>							
			For mechanical fixing of motor start protector and contactor; for snapping onto standard mounting rail or for screw fixing.				
	S00, S0	S00, S0	Single-unit packaging	<b>3RA29 22-1AA00</b>		1 unit	0.001
	S2	S2		<b>3RA19 31-1AA00</b>		1 unit	0.020
	S3	S3		<b>3RA19 41-1AA00</b>		1 unit	0.250
	S00, S0	S00, S0	Multi-unit packaging	<b>3RA29 22-1A</b>		5 units	0.001
3RA29 22-1AA00							
<b>Side modules for standard mounting rail adaptors</b>							
	S00 ...S3	S00 ...S3	For standard mounting rail adaptors 10 mm wide, 96 mm long, for widening standard mounting rail adaptors when using lateral auxiliary switches, For size S00 to S2: 2 units required. For size S3: 3 units required	<b>3RA19 02-1B</b>		10 units	0.009
3RA19 02-1B							
<b>RH assembly kits for reversing duty and standard rail mounting</b>							
			RH assembly kits for screw terminals				
	S0	S0	Comprising: • Wiring kits	<b>3RA29 23-1BB1</b>		1 unit	0.001
	S2	S2	• 2 standard mounting rail adaptors	<b>3RA29 33-1BB1</b>		1 unit	0.560
	S3	S3	• 2 connecting wedges	<b>3RA29 43-1BB1</b>		1 unit	0.810
	Link modules may be ordered separately.						
			RH assembly kits for spring-type terminals	<b>Spring-type Terminals</b>			
	S0	S0	Comprising: • Wiring kits	<b>3RA29 23-1BB2</b>		1 unit	0.001
	• 2 standard mounting rail adaptors						
	• 2 connecting wedges						
	• Spacers						
	Link modules may be ordered separately.						
3RA29 23-1BB1							

# 3RA2 Accessories

## Busbar adapters

4 COMBINATION STARTERS

For motor starter protector Size	For contactors Size	Version	Order No.	Std. pack qty.	Weight approx. kg
-------------------------------------	------------------------	---------	-----------	----------------	----------------------

### Busbar adapters for 60 mm systems

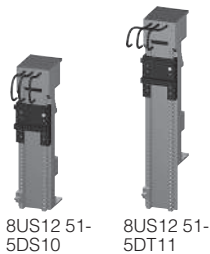

For flat copper profiles according to DIN 46433  
Width: 12 mm and 30 mm Thickness: 5 mm and 10 mm  
also for T and double-T special profiles

#### For motor starter protectors and contactors with screw terminals

S00	S00	Rated current 16 A, 45 mm wide, 200 mm long
S0	S0	Rated current 32 A, 45 mm wide, 260 mm long
S2	S2	Up to 65A, 55mm wide, 260mm long

#### Screw terminals



<b>8US12 51-5DS10</b>	1 unit	0.183
<b>8US12 51-5NT10</b>	1 unit	0.183
<b>8US12 61-6MT10</b>	1 unit	0.572

#### For motor starter protectors and contactors with spring-type terminals

S00	S00	Rated current 16 A, 45 mm wide, 260 mm long
S0	S0	Rated current 32 A, 45 mm wide, 260 mm long

#### Spring-type terminals



<b>8US12 51-5DT11</b>	1 unit	0.183
<b>8US12 51-5NT11</b>	1 unit	0.183

### Device holders for lateral mounting onto busbar adapters for 60 mm system

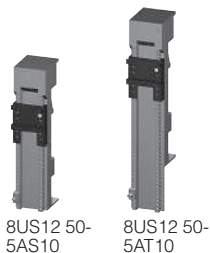

S00, S0	S00, S0	Up to 25 A, 45 mm wide, 200 mm long
S0	S0	Up to 40 A, 45 mm wide, 260 mm long
S2	S2	Up to 65A, 118mm wide, 260mm long (includes 8US1261-6MT10 adapter)

<b>8US12 50-5AS10</b>	1 unit	0.183
<b>8US12 50-5AT10</b>	1 unit	0.183
<b>8US12 11-6MT10</b>	1 unit	0.873

### Side modules for widening busbar adapters

--	--	Including connecting wedges, for widening busbar adapters or device holders, 9 mm wide, 200 mm long
----	----	---

<b>8US19 98-2BJ10</b>	1 unit	0.023
-----------------------	--------	-------

### Spacers for fixing the motor starter onto the busbar adapter

--	S00, S0	(1 pack = 100 units)
----	---------	----------------------

<b>8US19 98-1BA10</b>	1 pack	0.183
-----------------------	--------	-------

### Vibration and shock kits for high vibration and shock loads

--	S00, S0	
----	---------	--

<b>8US19 98-1CA10</b>	1 unit	0.183
-----------------------	--------	-------

### RS assembly kits for reversing duty for 60 mm busbar systems



3RA29 23-1DB1 only Busbar adapter pictured

#### RS assembly kits for screw terminals

S00, S0	S00	Comprising: • Wiring kits • Busbar adapters • Device holders • 2 connecting wedges • Side modules  Link modules must be ordered separately.
S0	S0	
S00	S0	
S2	S2	

#### Screw terminals



<b>3RA29 13-1DB1</b>	1 unit	0.001
<b>3RA29 23-1DB1</b>	1 unit	0.001
<b>3RA29 23-1EB1</b>	1 unit	0.001
<b>3RA29 33-1DB1</b>	1 unit	1.235



3RA29 23-1DB2 only Busbar adapter pictured

#### RS assembly kits for spring-type terminals

S00	S00	Comprising: • Wiring kits • Busbar adapters • Device holders • 2 connecting wedges • Spacers • Side modules  Link modules must be ordered separately.
S0	S0	

#### Spring-type terminals



<b>3RA29 13-1DB2</b>	1 unit	0.001
<b>3RA29 23-1DB2</b>	1 unit	0.001

# 3RA2 Accessories

## Connecting wedges, spaces, and tools

For motor starter protector Size	For contactors Size	Version	Order No.	Std. pack qty.	Weight approx. kg
-------------------------------------	------------------------	---------	-----------	----------------	----------------------

### Connecting wedges



8US19 98-1AA00

For mechanical linking of busbar adapters and device holders or of standard mounting rail adapters (2 units per combination required)

**8US19 98-1AA00** 100 units 0.100

### Spacers



3RA29 11-1CA00

For height compensation on AC contactors size S0 with spring-type terminals

S0 S0 **Single-unit packaging**  
S0 S0 **Multi-unit packaging**

### Spring-type terminals

**3RA29 11-1CA00** 1 unit 0.001  
**3RA29 11-1C** 5 units 0.001

Version	Order No.	Std. pack qty.	Weight approx. kg
---------	-----------	----------------	----------------------

### Tools for opening spring-type terminals by hand



3RA29 08-1A

**Screwdrivers**  
for all SIRIUS devices with spring-type terminals  
Length approx. 200 mm,  
3.0 mm x 0.5 mm,  
titanium gray/black,  
partially insulated

### Spring-type terminals

**3RA29 08-1A** 1 unit 0.045

### Blank labels

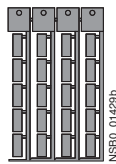

3RT19 00-1SB20

**Unit labeling plates<sup>1)</sup>**  
for SIRIUS devices  
20 mm x 7 mm,  
pastel turquoise

**3RT29 00-1SB20** 340 units 0.200

<sup>1)</sup> PC labeling system for individual inscription of unit labeling plates available from: murrplastik Systems, Inc. [www.murrplastik.com](http://www.murrplastik.com)

### Selection and ordering data

For MSPs Size	For Conductors Size	Version	Order No.	Std. Pack Qty.	Weight approx. kg
------------------	------------------------	---------	-----------	----------------	----------------------

### Push-in lugs for screw fixing



3RV29 28-0B

S00 -- For screwing the motor starter protector onto mounting plates; for each motor starter protector, 2 units are required.

**3RV29 28-0B** 10 units 0.100

Components for IEC types of coordination 1 and 2 at AC 500 V

Technical data

Three-phase standard motor <sup>1)</sup> 4-pole at AC 500 V		Setting range Inverse-time delayed overload release	Motor starter protector	Contactor <sup>2)</sup>	Size
Standard output <i>P</i> kW	Motor current (guide value) <i>I</i> A		Type	Type	
<b>IEC Type of coordination 1 at <math>I_q = 50</math> kA/AC 400 V Normal starting Class 10</b>					
1.5	3.6	3.5 ... 5	3RV20 11-1FA10	3RT20 15-1AP00	<b>S00</b>
2.2	4.9	4.5 ... 6.3	3RV20 11-1GA10		
3	6.5	5.5 ... 8	3RV20 11-1HA10		
4	8.5	7 ... 10	3RV20 11-1JA10	3RT20 16-1AP01	
5.5	11.5	9 ... 12.5	3RV20 11-1KA10	3RT20 17-1AP01	
7.5	15.5	11 ... 16	3RV20 11-4AA10	3RT20 18-1AP01	
<b>IEC Type of coordination 2 at <math>I_q = 50</math> kA/AC 400 V Normal starting Class 10</b>					
0.06	0.2	0.14 ... 0.2	3RV20 11-0BA10	3RT20 15-1AP01	<b>S00</b>
0.06	0.2	0.18 ... 0.25	3RV20 11-0CA10		
0.09	0.3	0.22 ... 0.32	3RV20 11-0DA10		
0.09	0.3	0.28 ... 0.4	3RV20 11-0EA10		
0.12	0.4	0.35 ... 0.5	3RV20 11-0FA10		
0.18	0.6	0.45 ... 0.63	3RV20 11-0GA10		
0.18	0.6	0.55 ... 0.8	3RV20 11-0HA10		
0.25	0.85	0.7 ... 1	3RV20 11-0JA10		
0.37	1.1	0.9 ... 1.25	3RV20 11-0KA10		
0.55	1.5	1.1 ... 1.6	3RV20 11-0AA10		
0.75	1.9	1.4 ... 2	3RV20 11-1BA10		
0.75	1.9	1.8 ... 2.5	3RV20 11-1CA10		
1.1	2.7	2.2 ... 3.2	3RV20 11-1DA10		
1.5	3.6	2.8 ... 4	3RV20 11-1EA10		
1.5	3.6	3.5 ... 5	3RV20 11-1FA10	3RT20 24-1AP01	<b>S0</b>
2.2	4.9	4.5 ... 6.3	3RV20 11-1GA10		
3	6.5	5.5 ... 8	3RV20 11-1HA10		
4	8.5	7 ... 10	3RV20 11-1JA10		
5.5	11.5	9 ... 12.5	3RV20 11-1KA10		
7.5	15.5	11 ... 16	3RV20 21-4AA10	3RT20 26-1AP01	
7.5	15.5	14 ... 20	3RV20 21-4BA10		
11	22	17 ... 22	3RV20 21-4CA10	3RT20 27-1AP01	
11	22	20 ... 35	3RV20 21-4DA10		
15	29	27 ... 32	3RV20 21-4EA10		

1) Selection depends on the actual startup and rated data of the protected motor.

2) Rated control supply voltage 120 V AC. Other voltages are possible.

Components for IEC types of coordination 1 and 2 at AC 500 V

Technical data

Three-phase standard motor <sup>1)</sup> 4-pole at AC 500 V		Setting range Inverse-time delayed overload release	Motor starter protector	Contactors <sup>2)</sup>	Size
Standard output <i>P</i> kW	Motor current (guide value) <i>I</i> A		Type	Type	

**IEC Type of coordination 1 at  $I_q = 50$  kA/AC 500 V  
Normal starting Class 10**

On request			3RV2031-4DA10	3RT20 35-1AK60	<b>S2</b>
On request			3RV2031-4EA10	3RT20 35-1AK60	
On request			3RV2031-4FA10	3RT20 35-1AK60	
On request			3RV2031-4GA10	3RT20 36-1AK60	
On request			3RV2031-4HA10	3RT20 36-1AK60	
On request			3RV2041-4JA10	3RT20 45-1AK60	<b>S3</b>
On request			3RV2041-4KA10	3RT20 45-1AK60	
On request			3RV2041-4LA10	3RT20 46-1AK60	

**IEC Type of coordination 2 at  $I_q = 50$  kA/AC 500 V  
Normal starting Class 10**

On request			3RV20 31-4AA10	3RT20 35-1AK60	<b>S2</b>
On request			3RV20 31-4BA10	3RT20 35-1AK60	
On request			3RV20 31-4DA10	3RT20 35-1AK60	
On request			3RV20 31-4EA10	3RT20 35-1AK60	
On request			3RV20 31-4FA10	3RT20 35-1AK60	
On request			3RV20 31-4GA10	3RT20 36-1AK60	
On request			3RV20 31-4HA10	3RT20 36-1AK60	
On request			3RV20 31-4JA10	3RT20 45-1AK60	<b>S3</b>
On request			3RV20 31-4KA10	3RT20 45-1AK60	
On request			3RV20 31-4LA10	3RT20 46-1AK60	

1) Selection depends on the actual startup and rated data of the protected motor.

2) Rated control supply voltage 120 V AC. Other voltages are possible.



Components for IEC types of coordination 1 and 2 at AC 690 V

Technical data

Three-phase standard motor 4-pole at AC 690 V <sup>3)</sup>		Setting range MSP	Standard IEC circuit-breaker with limiting function	Subsequent MSP	Contactor <sup>1)</sup>	Size	Short-circuit switching capacity $I_q$ at 690 V
Standard output	Motor current (guide value)		Type	Type	Type		
$P$ kW	$I$ A	A					kA

IEC Types of coordination 1 and 2 at AC 690 V  
Normal starting Class 10

On request	11 ... 16	3RV13 31-4HC10	3RV20 31-4AA10	3RT20 35-1AK60	<b>S2</b>	50
On request	14 ... 20	Size S2	3RV20 31-4BA10	3RT20 35-1AK60		
On request	18 ... 25	$I_n = 50$ A	3RV20 31-4DA10	3RT20 35-1AK60		
On request	22 ... 32		3RV20 31-4EA10	3RT20 35-1AK60		
On request	28 ... 40		3RV20 31-4FA10	3RT20 45-1AK60 <sup>2)</sup>	<b>S2/S3</b>	50
On request	36 ... 45		3RV20 31-4GA10	3RT20 45-1AK60 <sup>2)</sup>		
On request	40 ... 50		3RV20 31-4HA10	3RT20 46-1AK60 <sup>2)</sup>		

Installation guidelines for AC 400/500 V

The following distances from earthed components must be observed when installing combinations:

Motor starter protectors in combination with contactors			Distances from earthed or live parts		
MSP	Contactor	Rated operational voltage	Y mm	X2 <sup>4)</sup> mm	Z mm
3RV2. 1 with	3RT20 1	400/500 V	20	10	9
3RV2. 2 with	3RT20 1	400/500 V	30	10	9
	3RT2. 2	400/500 V	30	10	9
	3RT2. 3	400/500 V	30	10	9
3RV2. 3 with	3RT20 2	400/500 V	50	10	10
	3RT2. 3	400/500 V	50	10	10
	3RT20 4	400/500 V	50	10	10
3RV2. 4 with	3RT20 4	400 V	90	10	12
	3RT20 4	500 V	220	10	20

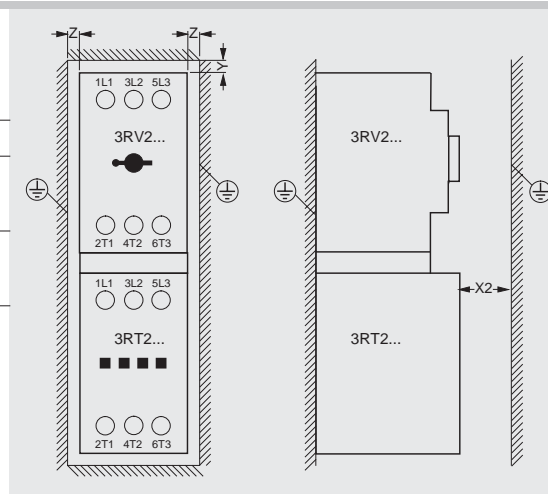

- No upstream circuit-breaker required; short-circuit proof up to 100 kA.

- Rated control supply voltage 120 V AC. Other voltages are possible.
- With these combinations, the distance between the subsequent MSP and the contactor must be at least 10 cm.
- Selection depends on the specific startup and rated data of the protected motor.
- Minimum distance to contactor at front. For the MSP, no minimum distance at the front must be maintained.

3RA2 – up to 100 A

Technical data

Installation guidelines for AC 690 V

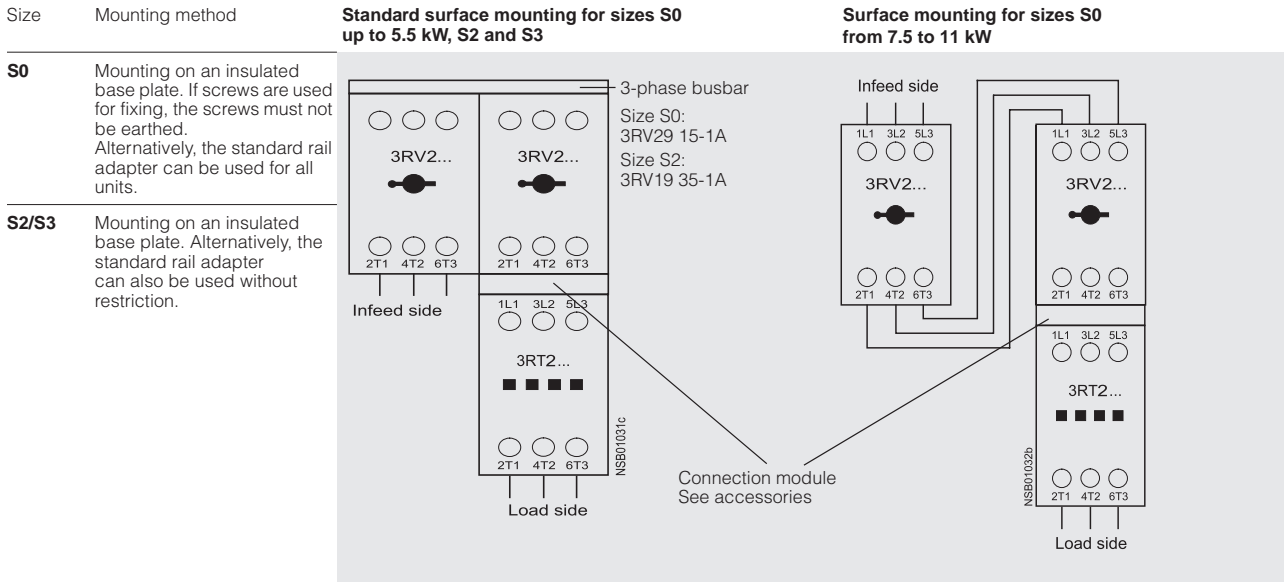

4 COMBINATION STARTERS

The following distances from earthed components must be observed when installing combinations:

Two MSPs in combination with contactors			Distances from earthed or live components					
MSP	Contactor	Rated operational voltage	Y1 mm	Y2 mm	Y3 mm	X1 mm	X2 mm	Z mm
3RV2. 2 with	3RT20 2	690 V	80	10	95	20	14	20
3RV2. 3 with	3RT20 3	690 V	50	10	120	10	32	10
	3RT20 4	690 V	50	10	120	10	40	10

a 3-phase busbar:  
Size S0: 3RV29 15-1A  
Size S2: 3RV19 35-1A

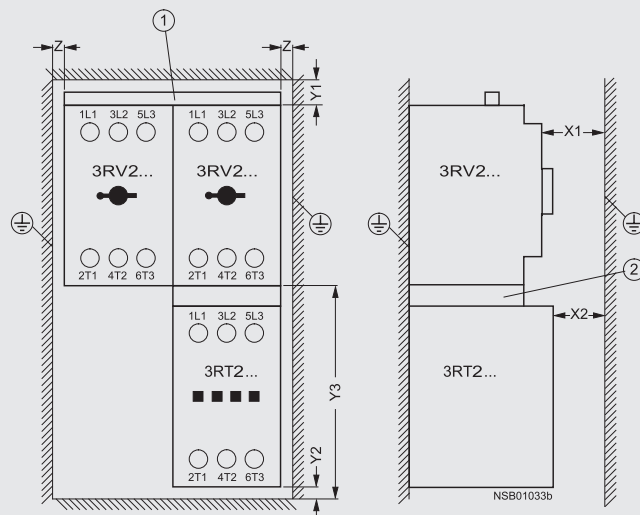

b In combination with size S2 MSPs and size S3 contactors, a spacing of 100 mm must be maintained.

3RA2 – up to 100 A

Technical data					
General data					
Specifications	IEC 60 947-1, EN 60 947-1 (VDE 0660 Part 100) IEC 60 947-2, EN 60 947-2 (VDE 0660 Part 101) IEC 60 947-4-1, EN 60 947-4-1 (VDE 0660 Part 102)				
<b>Type</b>		<b>3RA2. 1</b>	<b>3RA2. 2</b>	<b>3RA2. 3</b>	<b>3RA2.4</b>
Size		<b>S00</b>	<b>S0</b>	<b>S2</b>	<b>S3</b>
Number of poles		3	3	3	3
<b>Max. rated current <math>I_{nmax}</math></b> (= max. rated operational current $I_e$ )	A	16	32	65	100
<b>Permissible ambient temperature</b>	°C for storage/transport °C for operation	-55 ... +80 -20 ... +60 (restrictions apply at more than +60 °C)		-50 ... +80 -20 ... +60	
<b>Rated operational voltage <math>U_o</math></b>	V	690			
<b>Rated frequency</b>	Hz	50/60			
<b>Rated insulation voltage <math>U_i</math></b>	V	690			
<b>Rated impulse withstand voltage <math>U_{imp}</math></b>	kV	6			
<b>Release class (CLASS)</b>	acc. to IEC 60 947-4-1, EN 60 947-4-1 (VDE 0660 Part 102)	10			
<b>Rated fused short-circuit current <math>I_{cs}</math> at 50/60 Hz AC 400 V</b> acc. to IEC 60 947-4-1, DIN EN 60 947-4-1 (VDE 0660 Part 102)	kA	150		100	50
<b>Types of coordination to IEC 60 947-4-1, EN 60 947-4-1</b> (VDE 0660 Part 102)		1)			
<b>Power losses <math>P_{vmax}</math> of all main conducting paths</b> depending on the rated current $I_n$ (upper current setting range)	<ul style="list-style-type: none"> <li>• Up to 1.25 A W</li> <li>• 1.6 - 6.3 A W</li> <li>• 8 - 12 A W</li> <li>• 16 A W</li> <li>• 5 - 6.3 A W</li> <li>• 8 - 12 A W</li> <li>• 16 - 32 A W</li> <li>• 25 - 32 A W</li> <li>• 40 A W</li> <li>• 45 - 50 A W</li> <li>• 63 A W</li> <li>• 75 - 90 A W</li> <li>• 100 A W</li> </ul>				
		2			
		2.3			
		3.5			
		4.3			
			2.3		
			3.5		
			4.3		
				16.2	
				17.2	
				21	
					29
					45
					60
<b>Power consumption of solenoid coils</b> (with cold coil and $U_s$ , 50 Hz)					
• AC operation	closing	27	65	190	270
	p.f.	0.8	0.82	0.72	0.68
	closed	4.2	8.5	16	22
	p.f.	0.25	0.25	0.37	0.27
• DC operation	closing = closed	4	5.9	-	15
<b>Coil voltage tolerance for contactors</b>		0.8 - 1.1 x $U_s$			
low limit	at 55 °C	0.8 x $U_s$			
	at 60 °C	0.85 x $U_s$			
<b>Endurance of MSP</b>					
• Mechanical endurance	operating cycles	100 000		Up to 52A: 50 000	50 000
• Electrical endurance	operating cycles	100 000		from 65A: On request	50 000
• Max. switching frequency per hour (motor starts)	1/h	15		15	15
<b>Endurance of contactor</b>					
• Mechanical endurance	operating cycles	30 million	10 million		
• Electrical endurance	operating cycles	See endurance curves of contactors in Part 3.			
<b>Shock resistance</b> (sine-wave acc. to IEC 60 068 Part 2-27 pulse)	g	up to 6	up to 6	up to 6	up to 6
<b>Degree of protection</b>	acc. to IEC 60 947-1	IP 20		IP 20	
<b>Shock-hazard protection</b>	acc. to DIN VDE 0106 Part 100	Finger-safe			
<b>Phase failure sensitivity of MSP</b>	acc. to IEC 60 947-4-1, EN 60 947-4-1 (VDE 0660 Part 102)	Yes			
<b>Isolating characteristics of MSP</b>	acc. to IEC 60 947-2, EN 60 947-2 (VDE 0660 Part 101)	Yes			
<b>Main and EMERGENCY-STOP switch characteristics of MSP and accessories</b>	acc. to IEC 60 204-1, EN 60 204-1 (VDE 0113 Part 1)	Yes (with overvoltage releases of category 1 under conditions of proper use)			
<b>Safe isolation between main and auxiliary circuits</b>	acc. to DIN VDE 0160 Part 101	up to 400 V			
<b>Positively driven operation at contactors</b>		Yes	Yes, from main contact to auxiliary NC contact		

1) See selection and ordering data on pages 4/36 to 4/43.

3RA2 – up to 100 A

Technical data

Conductor cross-sections of main circuit

Specifications	IEC 60 947-1, EN 60 947-1 (VDE 0660 Part 100) IEC 60 947-2, EN 60 947-2 (VDE 0660 Part 101) IEC 60 947-4-1, EN 60 947-4-1 (VDE 0660 Part 102)			
<b>Type</b> Size Number of poles	<b>3RA2. 1</b> <b>S00</b> 3	<b>3RA2. 2</b> <b>S0</b> 3	<b>3RA2.3</b> <b>S2</b> 3	<b>3RA21 4</b> <b>S3</b> 3
<b>Connection type</b>	Screw terminal M3 Posidrive size 2	Screw terminal M3 Posidrive size 2	Screw Terminals M6 Pozidriv size 2	Box terminals Allen screw
<b>Terminal screw</b>				
<b>Conductor cross-sections (min./max)</b> 1 or 2 conductors can be connected				
• Solid and stranded	mm <sup>2</sup> mm <sup>2</sup> mm <sup>2</sup>	2 x (0.5 ... 1.5) <sup>2)</sup> only for contactors 2 x (0.75 ... 2.5) <sup>2)</sup> max. 2 x 4	2 x (1 ... 25) <sup>2)</sup> 1 x (1 ... 35) <sup>2)</sup> 2 x (1 ... 35) <sup>2)</sup> 1 x (1 ... 50) <sup>2)</sup>	
• Finely stranded without end sleeve	mm <sup>2</sup>	–		
• Finely stranded with end sleeves (DIN 46 228 T1)	mm <sup>2</sup>	2 x (0.5 ... 1.5) <sup>2)</sup> 2 x (0.75 ... 2.5) <sup>2)</sup>	2 x (1 ... 16) <sup>2)</sup> 1 x (1 ... 25) <sup>2)</sup> 2 x (1 ... 25) <sup>2)</sup> 1 x (1 ... 35) <sup>2)</sup>	
• AWG cables, solid or stranded	AWG AWG AWG	2 x (20 ... 16) <sup>2)</sup> 2 x (18 ... 14) 2 x 12	2 x (18 ... 3) <sup>2)</sup> 1 x (18 ... 2) <sup>2)</sup> 2 x (18 ... 2) <sup>2)</sup> 1 x (18 ... 1) <sup>2)</sup>	
<b>Minimum/maximum conductor cross-sections</b>				
• flexible with ferrule - 1 conductor	mm <sup>2</sup>		0.75/25	2.5/50 <sup>1)</sup>
- 2 conductors	mm <sup>2</sup>		0.75/16	2.5/35 <sup>1)</sup>
• solid or stranded - 1 conductor	mm <sup>2</sup>		0.75/35	2.5/70 <sup>1)</sup>
- 2 conductors	mm <sup>2</sup>		0.75/25	2.5/50 <sup>1)</sup>
<b>Ribbon cable</b>			yes	yes
<b>Bus connection</b>			–	yes
• solid or stranded	AWG		2 x (30 ... 2)	–
• stranded	AWG		–	2 x (10 ... 1/0)
<b>Connection type</b>	Spring Loaded connection			
• Solid and stranded	mm <sup>2</sup>	2 x (0.5 ... 2.5)	–	2 x (0.5 ... 2.5)
• Finely stranded without end sleeve	mm <sup>2</sup>			2 x (0.5 ... 2.5)
• Finely stranded with end sleeves	mm <sup>2</sup>			2 x (0.5 ... 2.5)
• AWG cables, solid or stranded	AWG	2 x (20 ... 12)		2 x (20 ... 14)
<b>Permissible mounting position</b>	<p>Attention: acc. to DIN 43 602 Start command "I" right-hand or above</p>			

1) Cable-lug and busbar connection possible after removing the box terminals.

2) If two different conductor cross-sections are connected to one clamping point, both cross-sections must lie in the range specified. If identical cross-sections are used, this restriction does not apply.

3RA2 – up to 100 A

**Overview**

The 3RA combination starters consist of the 3RV MSP and the 3RT contactor. MSP and contactor are prewired and mechanically connected with preassembled kits (link modules, connection assembly kits and mounting rail or busbar adapters).

As the 3RA combination starters are constructed from 3RV MSPs and 3RT contactors, the same accessories can be used for the combination starter as for these MSPs and contactors.

Pre-assembled link modules are available as accessories for the power spectrum up to 75 HP. The desired combination starter can thus be assembled quickly and economically by the customer. A time saving is also achieved with the link modules as – unlike with conventional wiring systems – there is no need to rectify possible wiring errors.

As a combination starter rated for tap conductor protection for group installation the 3RV MSP is responsible for overload and short-circuit protection in the motor circuit. Back-up protective devices, such as fuses or SIEMENS Sentron circuit breakers are required as per NEC 430-53 guidelines for group installations for multiple motor applications

The 3RT contactor is ideal for extremely complex switching tasks requiring durable components.

The permissible ambient temperature is 60 °C with butt-mounting and without derating (70 °C possible subject to certain restrictions).

3RA combination starters are available for motors up to 75 Hp at 460 V AC and setting ranges from 0.14 A to 100 A.

3RA combination starters are supplied in four different sizes:

Size	Overall width mm	Max. rated current $I_{n\ max}$ A	For three-phase motors up to HP
S00	45	8	5
S0	45	22	15
S2	55	50	40
S3	70	100	75

**Operating conditions**

3RA combination starters are climate-proof. They are intended for use in enclosed rooms in which no severe conditions (such as dust, caustic vapors, hazardous gases) prevail. Suitable enclosures must be provided for installation in dusty and damp locations.

**Accessories**

The accessories for the special equipment, such as auxiliary contacts and undervoltage trips, can also be used for the 3RA combination starters.

In addition, certain accessories have been optimized for the combination starters. They include the top-connected, transverse auxiliary contact on the MSP with one changeover contact or one NO contact + one NC contact. Special auxiliary contact blocks that can be snapped on from below are available for the contactor.

These two accessories enable the combination starters to be wired easily without having to route cables via the equipment.

The special accessories for 3RA combination starters take the form of link modules for 3RV MSPs and 3RT contactors.

**Technical data**

For technical data, see pages 4/56-4/58. Additional details are contained in the respective tables for the 3RV MSPs and 3RT contactors.

**Configuration**

**Overload tripping times**

All the 3RA combination starters described here are designed for normal starting, in other words for overload tripping times of less than 10 s (CLASS 10). At rated-load operating temperature the tripping times are shorter, depending on the particular equipment and the setting range. The exact values can be derived from the tripping characteristics of the MSPs.

**Classification types**

DIN VDE 0660 Part 102 and IEC 60 947-4-1 make a distinction between two different types of coordination (types 1 and 2). Any short-circuits that occur are cleared safely by both types of coordination. The only differences concern the extent of the damage caused to the equipment by a short-circuit.

**IEC Type of coordination 1**

The combination starter may be non-operational after a short-circuit has been cleared. Damage to the contactor or to the overload relay is permissible. In 3RA load feeders, the MSP itself always achieves type of coordination 2.

**IEC Type of coordination 2**

There must be no damage to the overload trip or to any other components after a short-circuit has been cleared. The 3RA combination starter can resume operation without needing to be renewed. At most, it is permissible to weld the contactor contacts if they can be disconnected easily without any significant deformation.

**Mounting**

**Complete equipment**

The 3RA combination starters can be ordered as complete equipment for direct starting or for reversing mode. Control supply voltages of 50 Hz AC 230 V or DC 24 V and assembly on a 35 mm standard mounting rail or in a 40 or 60 mm busbar system are possible.

Special equipment for customer assembly can be ordered if other rated control supply voltages are required. The link modules simplify customer assembly of the load feeders.

The corresponding distances from earthed or live parts, as detailed in the technical data, must be observed.

**Customer assembly**

The standard devices can be combined optimally in terms of both technical data and dimensions, thanks to the modular system of the SIRIUS series.

The combination starters can thus be assembled easily by the customer. It is simply necessary to assemble the standard 3RV MSP and 3RT contactor and the appropriate link module together.

For the order numbers for special equipment and link modules, see the selection and ordering data.

For the link modules for direct starting or reversing mode and assembly on a standard mounting rail or busbar, see accessories.

If a MSP with a rotary operating mechanism is required for the lower setting ranges up to 12 A, the S0 MSP can also be assembled with an S00 contactor. A special connecting module is available for this purpose.

For the installation of feeders, it is imperative to use standard rail adapters, as from size S2 for direct starting and as from size S0 for reversing, to ensure the necessary mechanical strength. A standard rail adapter is not necessary if a busbar adapter is used.

**Assembly**

3RA combination starters are available for assembly on standard mounting rails in accordance with EN 50 022-35 x 15 or on busbar adapters with a busbar centre-line spacing of 40 or 60 mm and a busbar thickness of 5 or 10 mm.

The combination starters are also suitable for screw fixing.

Size S00 and S0 can be screwed on with the aid of plug-in clips (see accessories on page 4/47).

3RA2 – up to 100 A

**Direct-on-line starting • For standard rail mounting or screw fixing • Sizes S00 and S0**

4  
COMBINATION  
STARTERS

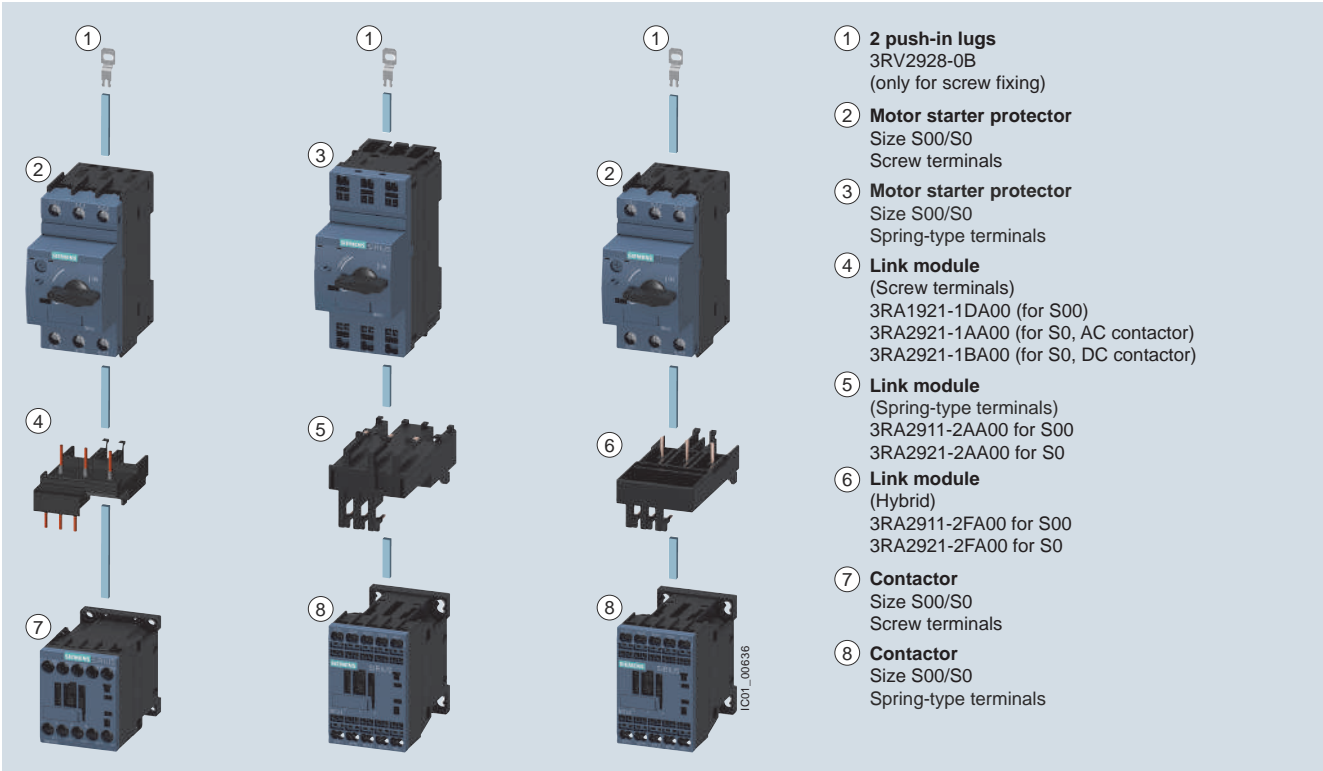

- ① **2 push-in lugs**  
3RV2928-0B  
(only for screw fixing)
- ② **Motor starter protector**  
Size S00/S0  
Screw terminals
- ③ **Motor starter protector**  
Size S00/S0  
Spring-type terminals
- ④ **Link module**  
(Screw terminals)  
3RA1921-1DA00 (for S00)  
3RA2921-1AA00 (for S0, AC contactor)  
3RA2921-1BA00 (for S0, DC contactor)
- ⑤ **Link module**  
(Spring-type terminals)  
3RA2911-2AA00 for S00  
3RA2921-2AA00 for S0
- ⑥ **Link module**  
(Hybrid)  
3RA2911-2FA00 for S00  
3RA2921-2FA00 for S0
- ⑦ **Contactor**  
Size S00/S0  
Screw terminals
- ⑧ **Contactor**  
Size S00/S0  
Spring-type terminals

Left: 3RA21 load feeder with screw terminals  
Center: 3RA21 load feeder with spring-type terminals  
Right: Motor starter protector combination with screw terminals, with contactor with spring-type terminals

**Direct-on-line starting • For standard rail mounting • Up to Size S3**

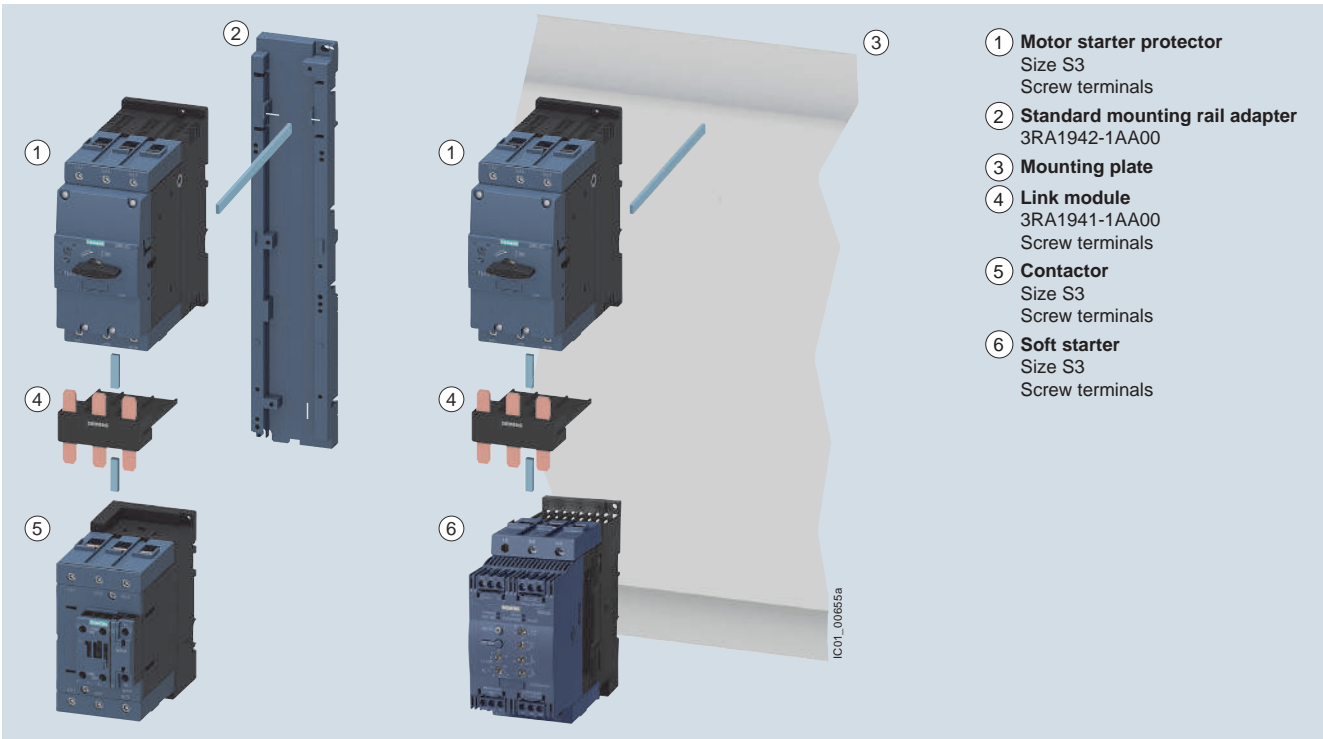

- ① **Motor starter protector**  
Size S3  
Screw terminals
- ② **Standard mounting rail adapter**  
3RA1942-1AA00
- ③ **Mounting plate**
- ④ **Link module**  
3RA1941-1AA00  
Screw terminals
- ⑤ **Contactor**  
Size S3  
Screw terminals
- ⑥ **Soft starter**  
Size S3  
Screw terminals

Load feeder for direct-on-line starting and standard rail mounting in size S3 (the version with screw terminals is shown in the picture)

3RA2 – up to 100 A

**Direct-on-line starting • For 60 mm busbar systems • Sizes S00 and S0**

① 60 mm busbar adapter for screw terminals  
8US1251-5DS10 for S00  
8US1251-5NT10 for S0

② 60 mm busbar adapter for spring-type terminals  
8US1251-5DT11 for S00  
8US1251-5NT11 for S0

③ Motor starter protector  
Size S00/S0  
Screw terminals

④ Motor starter protector  
Size S00/S0  
Spring-type terminals

⑤ Link module  
Screw terminals  
3RA1921-1DA00 for S00  
3RA2921-1AA00 for S0, AC contactor  
3RA2921-1BA00 for S0, DC contactor

⑥ Link module  
3RA2911-2AA00 for S00  
3RA2921-2AA00 for S0  
(additional 3RA2911-1CA00 spacer for height compensation on AC contactors size S0 with spring-type terminals)

⑦ Contactor  
Size S00/S0  
Screw terminals

⑧ Contactor  
Size S00/S0  
Spring-type terminals

IC01\_00633

Left: 3RA21 load feeder for direct-on-line starting with busbar adapter with screw terminals  
 Right: 3RA21 load feeder for direct-on-line starting with busbar adapter with spring-type terminals

**Direct-on-line starting • For 60 mm busbar systems • Size S2**

① Motor starter protector  
Size S2  
Screw terminals

② Busbar adapter 60 mm  
8US1261-6MT10

③ Link module  
3RA2931-1AA00  
Screw terminals

④ Contactor  
Size S2  
Screw terminals

IC01\_00640

3RA21 load feeder for direct-on-line starting with busbar adapter with screw terminals



3RA2 – up to 100 A

Reversing duty • For standard rail mounting or screw fixing • Size S00

4  
COMBINATION  
STARTERS

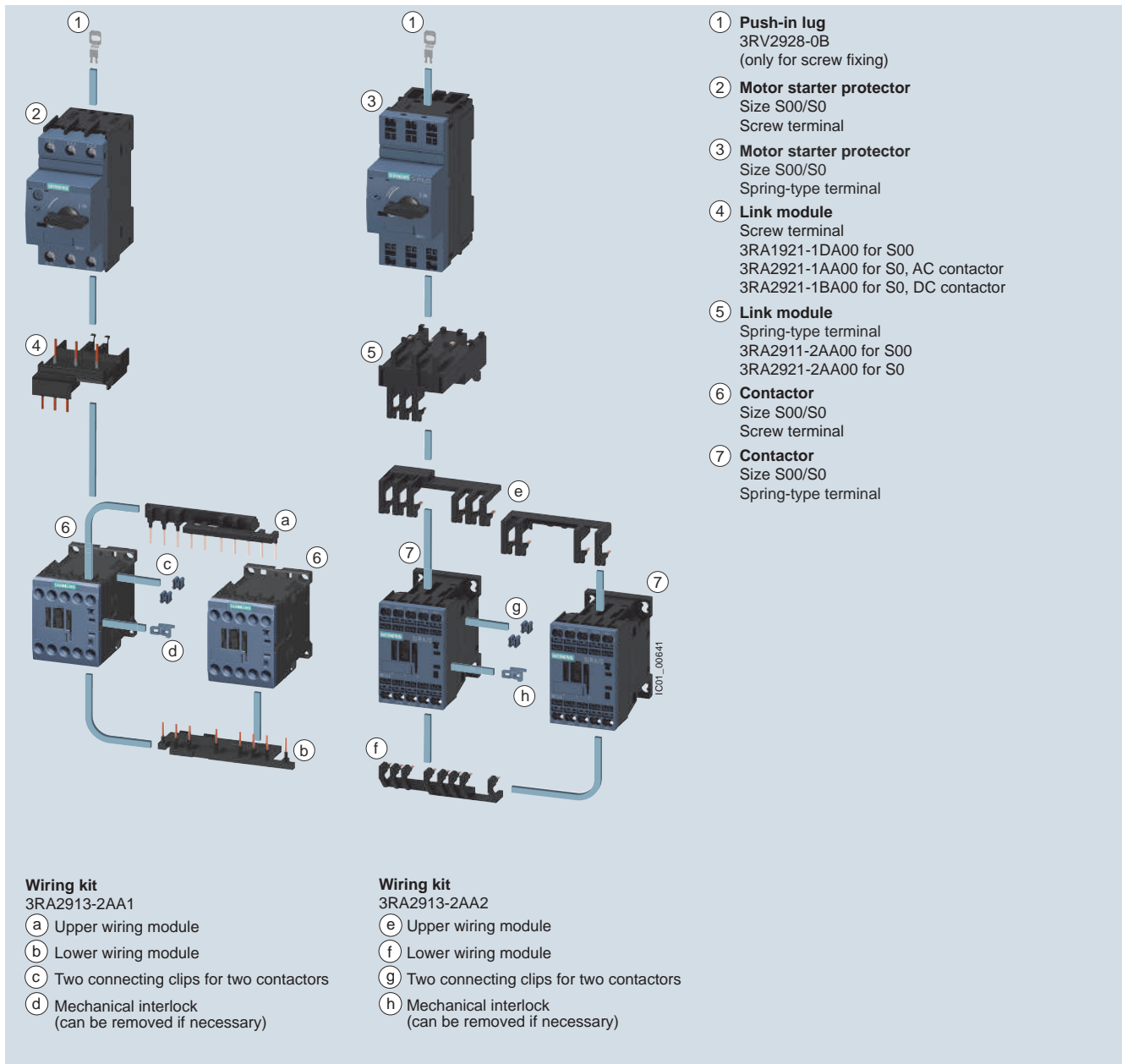

Left: 3RA22 load feeder with screw terminals with push-in lugs with two contactors for reversing duty and 3RA2913-2AA1 wiring kit for connection of the contactors (incl. mechanical interlocking and connecting clips)

Right: 3RA22 load feeder with spring-type terminals with push-in lugs with two contactors for reversing duty and 3RA2913-2AA2 wiring kit (incl. mechanical interlocking and connecting clips)



Reversing duty • For standard rail mounting • Size S0

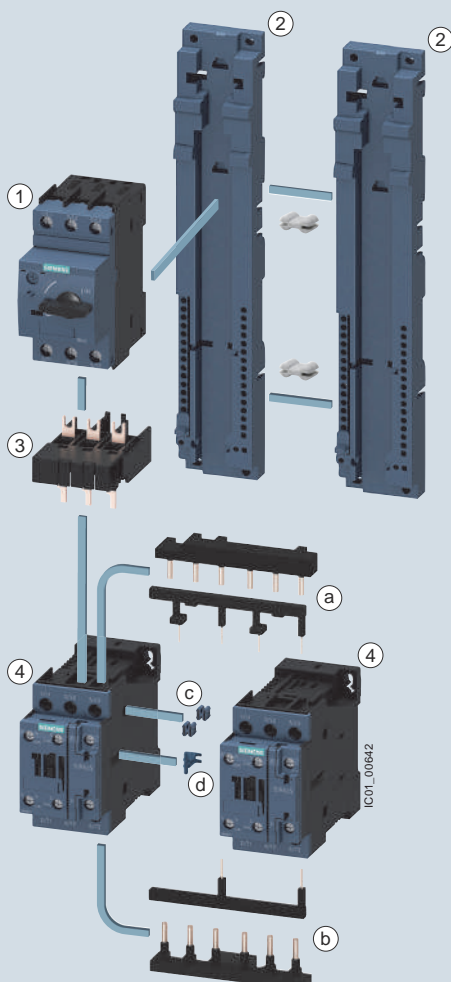

**RH assembly kit for reversing duty and standard rail mounting in size S0**

Screw terminals  
**3RA2923-1BB1**

Spring-type terminals  
**3RA2923-1BB2<sup>1)</sup>**

Comprising:

- Wiring kit for the main and auxiliary circuits
- Two standard mounting rail adapters
- Two connecting wedges
- Mechanical interlock
- Two connecting clips
- Fixing accessories

**① Motor starter protector**  
 Size S0  
 Screw terminals/spring-type terminals

**② Standard mounting rail adapters**  
 3RA2922-1AA00  
 with two connecting wedges  
 8US1998-1AA00

**③ Link module**  
 Screw terminals:  
 3RA2921-1AA00 for S0, AC contactor  
 3RA2921-1BA00 for S0, DC contactor  
 Spring-type terminals:  
 3RA2921-2AA00<sup>2)</sup>

**④ Contactor**  
 Size S0  
 Screw terminals/spring-type terminals

**Wiring kit**  
 Screw terminals:  
 3RA2923-2AA1

Spring-type terminals:  
 3RA2923-2AA2

**a** Upper wiring module  
**b** Lower wiring module  
**c** Two connecting clips for two contactors  
**d** Mechanical interlock  
 (can be removed if necessary)

<sup>1)</sup> Contains two 3RA2911-1CA00 spacers for height compensation on AC contactors size S0 with spring-type terminals.

<sup>2)</sup> Additionally two 3RA2911-1CA00 spacers for height compensation on AC contactors size S0 with spring-type terminals.

3RA22 load feeder for reversing duty and standard rail mounting in size S0 (the version with screw terminals is shown in the picture)

RH assembly kits for reversing duty and standard rail mounting in size S0, [see page 8/51](#).

Reversing duty • For standard rail mounting • Size S2

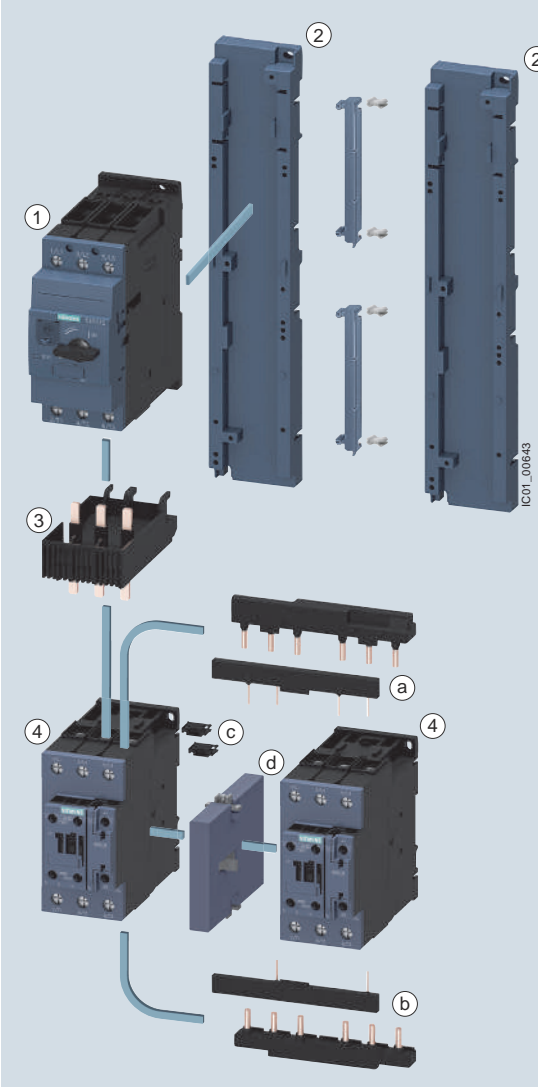

**RH assembly kit for reversing duty and standard rail mounting in size S2**

**3RA2933-1BB1**

Comprising:

- Wiring kit for the main and auxiliary circuits
- Two standard mounting rail adapters
- Two side modules
- Four connecting wedges
- Mechanical interlock
- Two connectors for two contactors
- Fixing accessories

① **Motor starter protector**  
Size S2  
Screw terminals

② **Standard mounting rail adapter**  
3RA2932-1AA00  
with two side modules  
3RA1902-1B  
and four connecting wedges  
8US1998-1AA00

③ **Link module**  
3RA2931-1AA00  
Screw terminals

④ **Contactors**  
size S2  
Screw terminals

**Wiring kit**  
Screw terminals  
3RA2933-2AA1

ⓐ Upper wiring module

ⓑ Lower wiring module

ⓒ Two connectors for two contactors

ⓓ Mechanical interlock  
3RA2934-2B (not part of the wiring kit, must be ordered separately)

Load feeder for reversing duty and standard rail mounting in size S2 (the version with screw terminals is shown in the picture)

RH assembly kits for reversing duty and standard rail mounting in size S2, [see page 8/51](#).

Reversing duty • For standard rail mounting • size S3

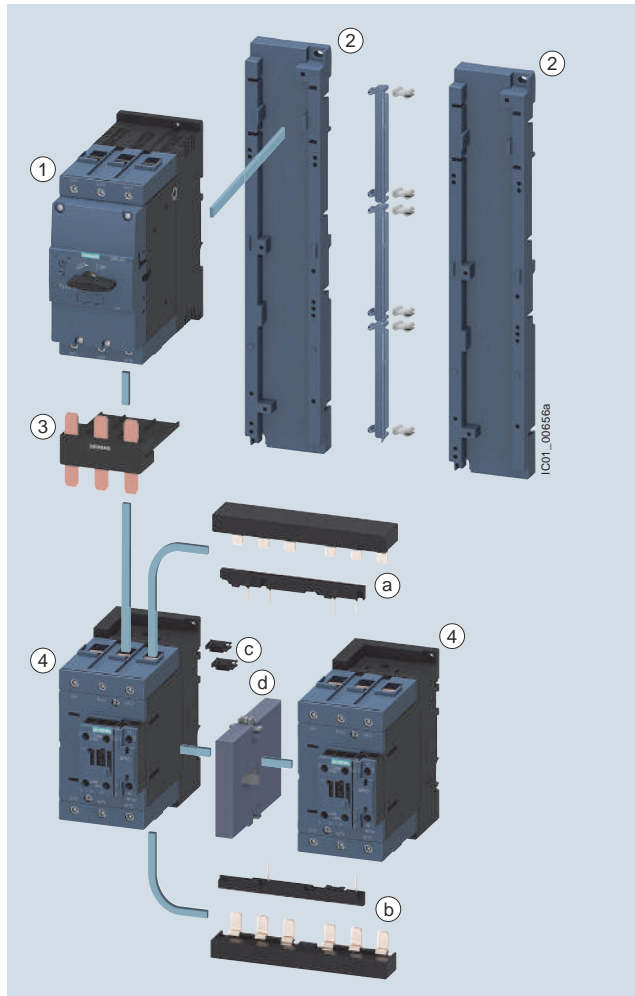

**Assembly kit (RH) for reversing duty and mounting onto standard rails in size S3**  
**3RA2943-1BB1**  
 Comprising:

- Wiring kit for the main and auxiliary circuits
- Two standard mounting rail adapters
- Three side modules
- Six connecting wedges
- Mechanical interlock
- Two connectors for two contactors
- Fixing accessories

① **Motor starter protector**  
size S3

② **Standard mounting rail adapter**  
3RA2932-1AA00  
with two side modules  
3RA1902-1B  
and four connecting wedges  
8US1998-1AA00

③ **Link module**  
3RA1941-1AA00

④ **Contactors**  
size S3

**Wiring kit**  
Screw terminals  
3RA2943-2AA1

(a) Upper wiring module

(b) Lower wiring module

(c) Two connectors for two contactors

(d) Mechanical interlock  
3RA2934-2B (not part of the wiring kit,  
must be ordered separately)

Load feeder for reversing duty and standard rail mounting in size S3 (the version with screw terminals is shown in the picture)

RH assembly kits for reversing duty and standard rail mounting in size S3, see page 8/51.

Reversing duty • For 60 mm busbar systems • Sizes S00 and S0

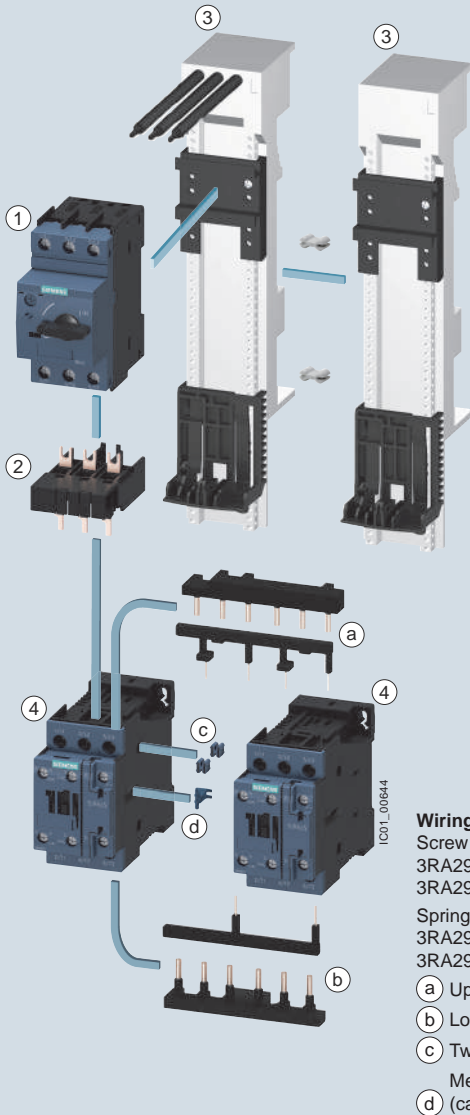

**Wiring kit**

- Screw terminals
- 3RA2913-2AA1 for S00
- 3RA2923-2AA1 for S0
- Spring-type terminals
- 3RA2913-2AA2 for S00
- 3RA2923-2AA2 for S0
- (a) Upper wiring module
- (b) Lower wiring module
- (c) Two connecting clips for two contactors
- Mechanical interlock
- (d) (can be removed if necessary)

**RS assembly kit for reversing duty and busbar mounting in size S00/S0**

- Screw terminals
- 3RA2913-1DB1 for S00
- 3RA2923-1DB1 for S0
- Spring-type terminals
- 3RA2913-1DB2 for S00
- 3RA2923-1DB2 for S0<sup>1)</sup>
- Comprising:
- Wiring kit for the main and auxiliary circuits
- Busbar adapter
- Device holder
- Two connecting wedges
- Mechanical interlock
- Two connecting clips for two contactors
- Fixing accessories

- (1) **Motor starter protector**  
Size S00/S0  
Screw terminals/spring-type terminals
- (2) **Link module**  
Screw terminals  
3RA1921-1DA00 for S00  
3RA2921-1AA00 for S0, AC contactor  
3RA2921-1BA00 for S0, DC contactor  
Spring-type terminals  
3RA2911-2AA00 for S00  
3RA2921-2AA00 for S0<sup>2)</sup>
- (3) **60 mm busbar adapter**  
Screw terminals  
8US1251-5DS10 for S00/S0  
8US1251-5NT10 for S0  
Spring-type terminals  
8US1251-5DT11 for S00/S0  
8US1251-5NT11 for S0  
2 connecting wedges  
8US1998-1AA00
- 60 mm device holder**  
8US1250-5AS10 or  
8US1250-5AT10  
(according to left adapter)
- (4) **Contactor**  
Size S00/S0  
Screw terminals/spring-type terminals

<sup>1)</sup> Contains two 3RA2911-1CA00 spacers for height compensation on AC contactors size S0 with spring-type terminals.

<sup>2)</sup> Additionally two 3RA2911-1CA00 spacers for height compensation on AC contactors size S0 with spring-type terminals.

3RA22 load feeder for reversing duty and 60 mm busbar (the version with screw terminals is shown in the picture)

RS assembly kits for reversing duty and busbar mounting in size S00/S0, see page 8/53.

Reversing duty • For 60 mm busbar systems • size S2

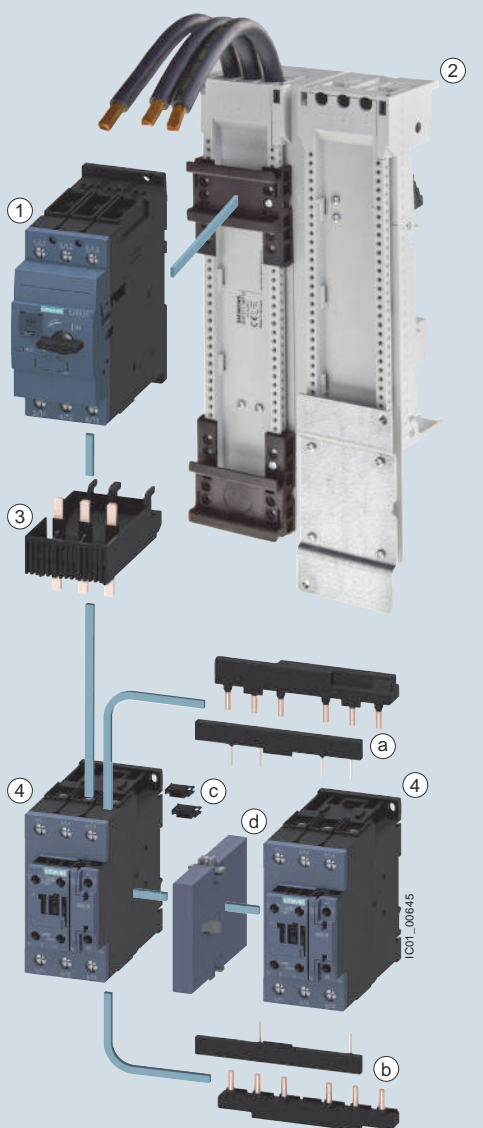

**RS assembly kit for reversing duty and busbar mounting in size S2**

**3RA2933-1DB1**

Comprising:

- Wiring kit for the main and auxiliary circuits
- Busbar adapter
- Mechanical interlock
- Two connectors for two contactors
- Fixing accessories

① **Motor starter protector**  
Size S2  
Screw terminals

② **Busbar adapter 60 mm**  
8US1211-6MT10

③ **Link module**  
3RA2931-1AA00  
Screw terminals

④ **Contactor**  
Size S2  
Screw terminals

**Wiring kit**  
For screw terminals  
3RA2933-2AA1

Ⓐ Upper wiring module

Ⓑ Lower wiring module

Ⓒ Two connecting pins for two contactors

Ⓓ Mechanical interlock  
3RA2934-2B (not part of the wiring kit, must be ordered separately)

Load feeder for reversing duty and 60 mm busbar in size S2 (the version with screw terminals is shown in the picture)

RS assembly kits for reversing duty and busbar mounting in size S2, see page 8/53.

3RA2 – up to 100 A

Components for Fast Bus mounting

- ① Link module  
for AC: 3RA19 41-1A  
for DC: 3RA19 41-1B
- ② Mechanical interlock  
3RA19 24-2B

3RV204 with Reversing 3RT204

Adapter shoe  
8US1211-4TR00

MSP  
3RV204

- 3RA2943-2AA1 Wiring kit (screw type)
- 3RA2943-2AA2 Wiring kit (spring type)
- Ⓐ Upper wiring module
- Ⓑ Lower wiring module

2 Contactors  
3RT204

2 Brackets  
FBS0070B

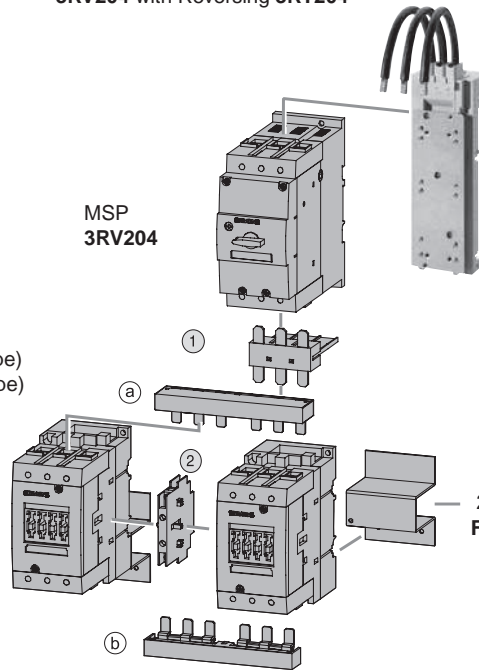

Circuit diagrams

Direct-on-line starting

Size S00: 3RA21.1

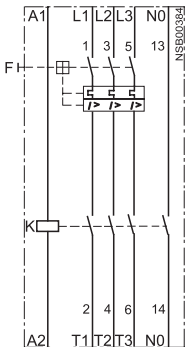

Sizes S0, S2 and S3: 3RA21 2, 3RA21 3

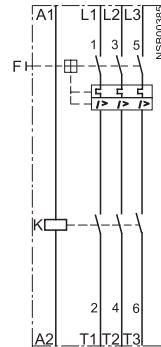

Reversing duty

Size S00: 3RA22

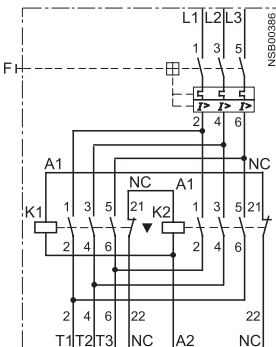

Size S0: 3RA22

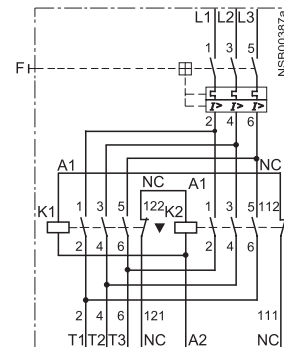

3RA2 – up to 100 A

Dimension drawings

Size S00 · for standard rail mounting

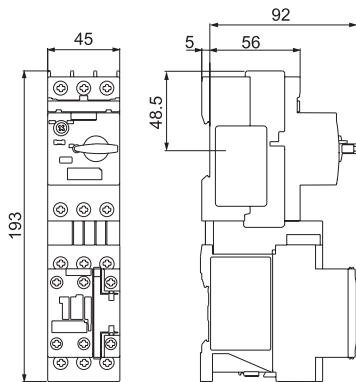

S0 direct-on-line starter,  
AC, screw-type connection system  
3RA2120-..A

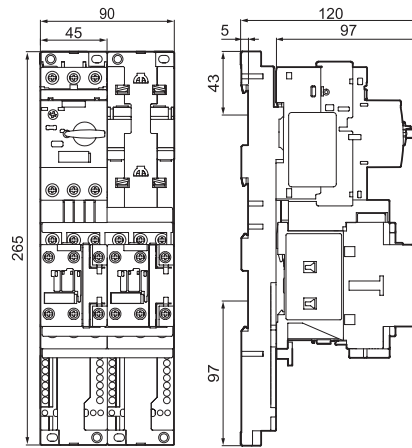

S0/S0 and S00/S0 reversing starters,  
AC, screw-type connection system  
3RA2220-..B...0AP0

Size S00 · for 40 mm and 60 mm busbar systems

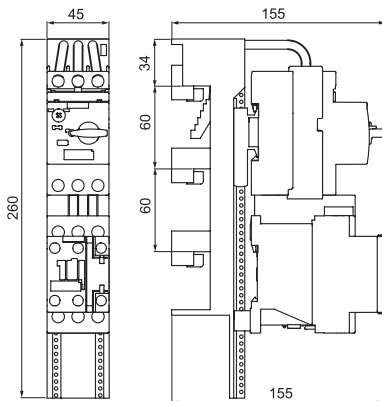

S0/S0 and S00/S0 direct-on-line starters,  
AC, screw-type connection system  
3RA2120-..D...0AP0

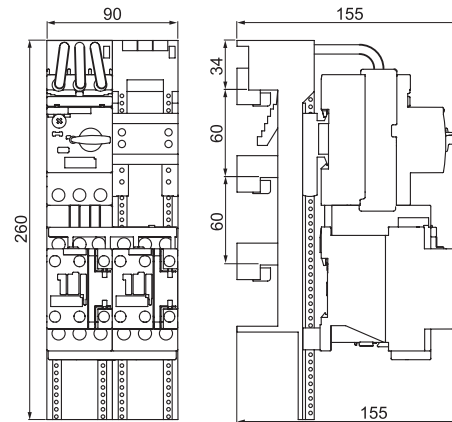

S0/S0 and S00/S0 reversing starters,  
AC, screw-type connection system  
3RA2220-..D...0AP0

When mounting the combinations, observe the installation guidelines (page 4/60-4/61).

Dimension drawings

Size S0 · for standard rail mounting

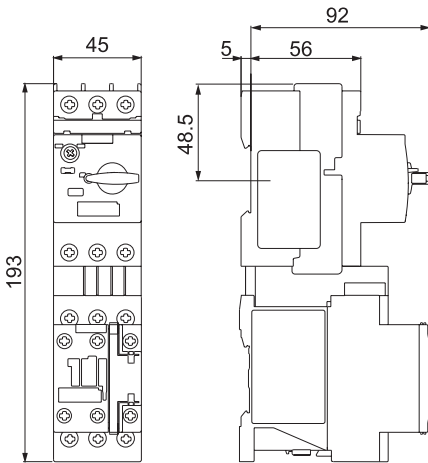

S0 direct-on-line starter, AC, screw-type connection system  
3RA2120-..A

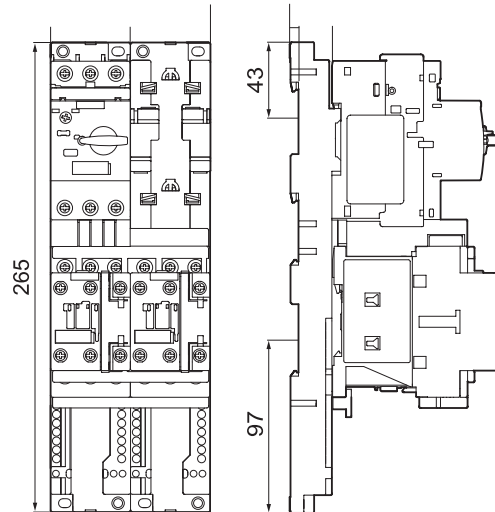

S0/S0 and S00/S0 reversing starters, AC, screw-type connection system  
3RA2220-..B..-0AP0

Size S0 · for 40 mm and 60 mm busbar systems

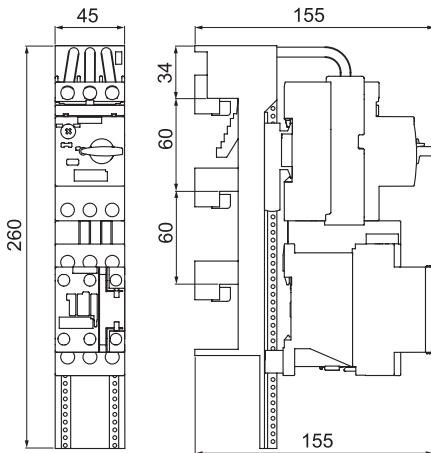

S0/S0 and S00/S0 direct-on-line starters, AC, screw-type connection system  
3RA2120-..D..-0AP0

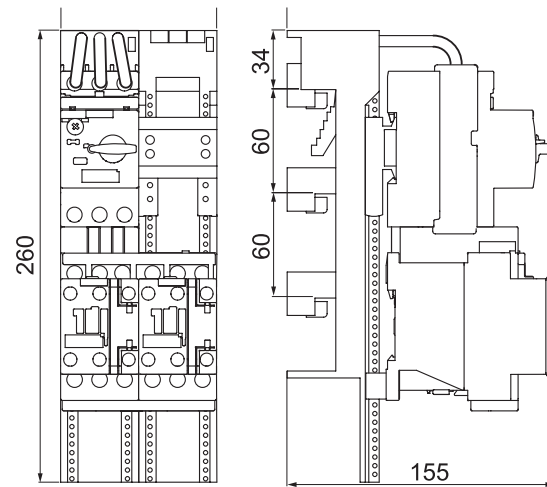

S0/S0 and S00/S0 reversing starters, AC, screw-type connection system  
3RA2220-..D..-0AP0

When mounting the combinations, observe the installation guidelines (page 4/60-4/61).



3RA2 – up to 50 A

Dimension drawings

Size S2 · for standard rail mounting

Direct-on-line starting

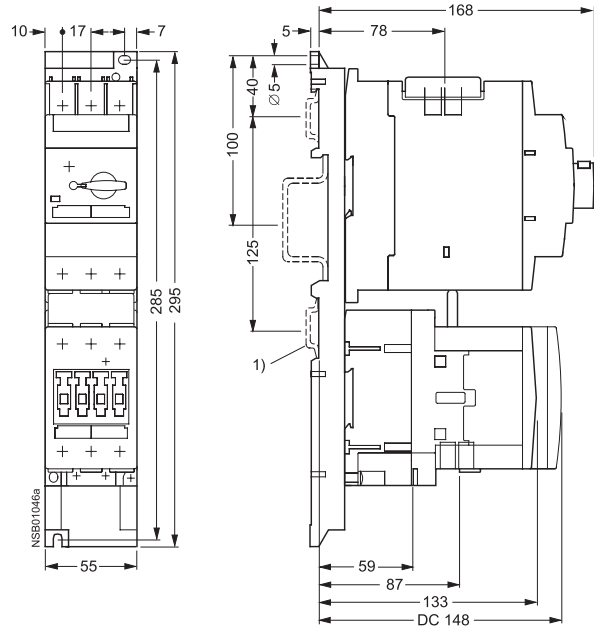

Reversing duty

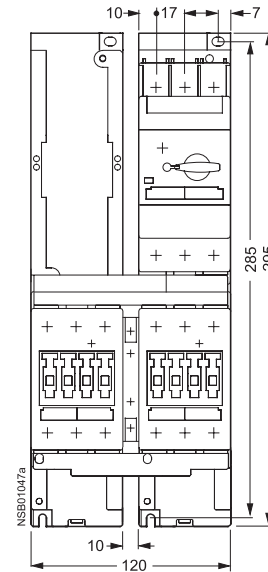

- 1) Alternative fixing methods
  - a) 2 35 mm mounting rails acc. to DIN EN 50022 Spacing: 125 mm Depth: 7.5 or 15 mm.
  - b) 1 75 mm mounting rail acc. to DIN EN 50 023.

Size S2 · for 40 mm and 60 mm busbar systems

Direct-on-line starting

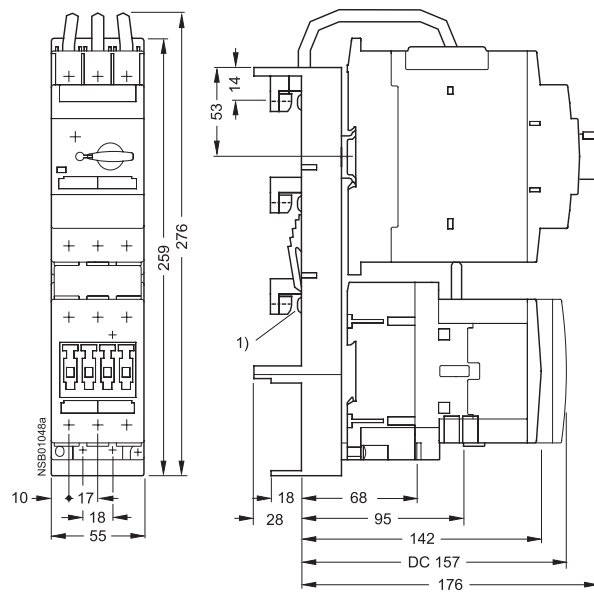

Reversing duty

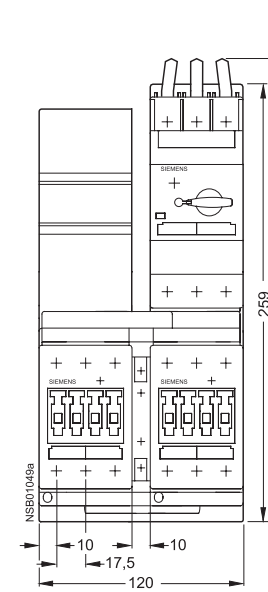

- 1) Busbar adapter suitable for rail thicknesses of 5 and 10 mm with chamfered edges.

When mounting the combinations, observe the installation guidelines (page 4/60-4/61).

3RA2 – up to 100 A

Dimension drawings

Size S3 · for standard rail mounting

Direct-on-line starting

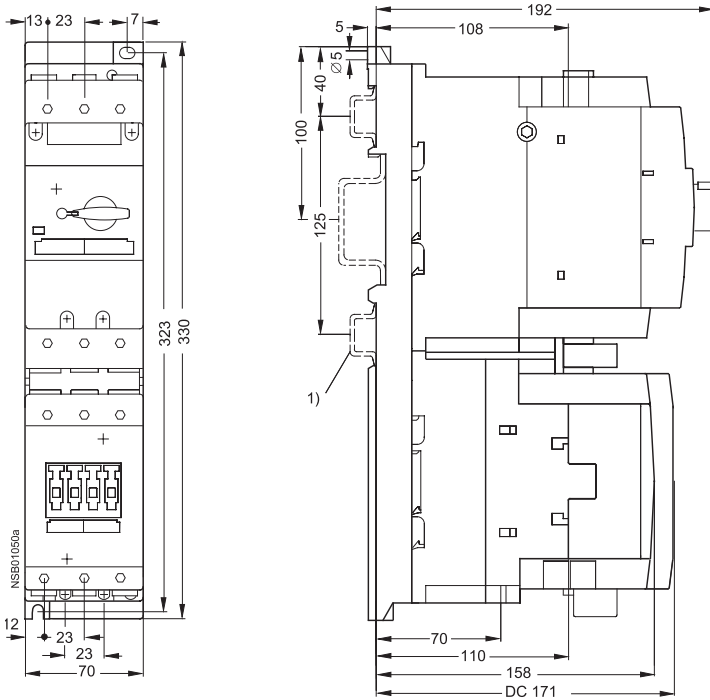

Reversing duty

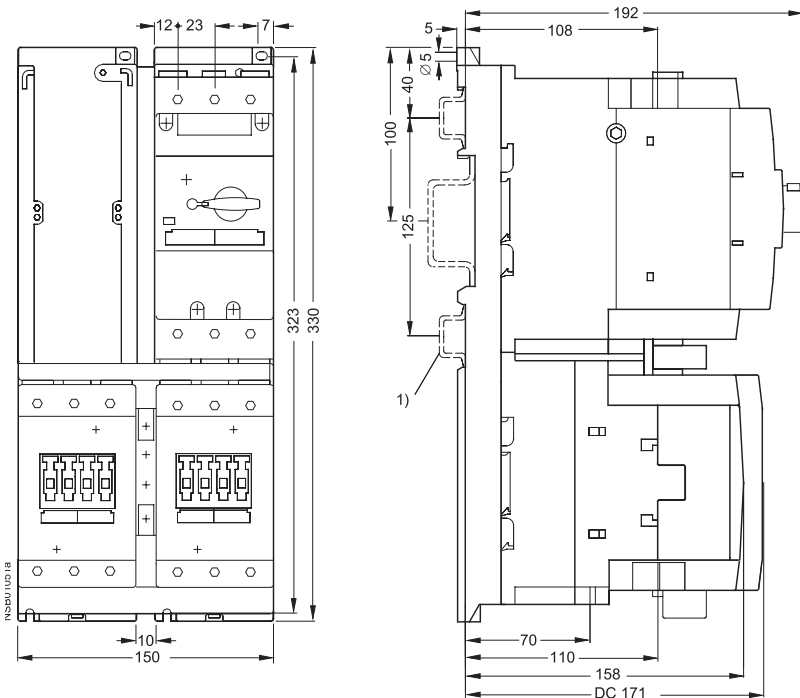

- 1) Alternative fixing methods
- a) 2 35 mm mounting rails acc. to DIN EN 50 022 Spacing: 125 mm Depth: 7.5 or 15 mm.
  - b) 1 75 mm mounting rail acc. to DIN EN 50 023.

When mounting the combinations, observe the installation guidelines (page guidelines 4/60-4/64).