

SIEMENS



Albatros² Heat pump controller User Manual

Series F
RVS61.843

AVS75.370
AVS75.39x

Edition 1.2
Controller series F
CE1U2355en_055
2020-02-03

Smart Infrastructure



Siemens Switzerland Ltd
Smart Infrastructure
Global Headquarters
Theilerstrasse 1a
6300 Zug
Switzerland
Tel. +41 58 724 24 24
<http://www.siemens.com>

© Siemens Switzerland Ltd, 2009
Subject to change

Legal notes

Warning concept

The instructions contained in this User Manual must be observed to ensure your personal safety and to prevent damage to equipment or property. Instructions relating to your personal safety are highlighted by a warning triangle. Instructions relating solely to equipment or property damage are without a warning triangle. The warning notes are presented in descending order as follows, depending on the hazard level:

 WARNING	Means that death or severe personal injury can occur if the respective precautionary measures are not taken.
 CAUTION	With warning triangle – means that minor personal injury can occur if the respective precautionary measures are not taken.
CAUTION	Without warning triangle – means that property damage can occur if the respective precautionary measures are not taken.
NOTE	Means that an undesired result can be produced or an undesired state can occur if the respective note is not observed.

Qualified personnel

Only qualified personnel are allowed to perform the tasks on the device/system covered by this document. Qualified personnel in the context of the safety-related notes contained in this document are persons who – owing to their education and experience – are able to identify and avoid risks that might occur in connection with the device/system.

Correct use

The device/system may only be used in building services plant and applications as described in this document.

Transport, storage, mounting, installation and commissioning as intended as well as careful operation are prerequisites to ensure safe and trouble-free operation of the products.

The permissible environmental conditions must be observed. The information given in chapter "Technical data" and the notes relating to the respective pieces of documentation must be observed.

Fuses, switches, wiring and earthing must comply with local safety regulations for electrical installations. Local and currently valid legislation must be observed.

Disclaimer

The content of this document has been checked to ensure it accords with the described hardware and firmware. Nevertheless, discrepancies cannot be excluded so that full accordance cannot be guaranteed. The information given in this document is checked at regular intervals; any corrections necessary will be included in subsequent versions.

Software used

The device software includes code generated by MATLAB (© 1987-2010 The MathWorks, Inc.).

Table of contents

Legal notes	3
1 Summary	7
1.1 Type summary	9
1.1.1 Topology, "building side"	9
1.1.2 Topology, "cloud side"	10
2 Safety notes RVS61.843	11
3 Mounting and installation	12
3.1 Heat pump controller RVS61.843	12
3.1.1 Connection terminals RVS61.843	13
3.2 Extension module AVS75.370	16
3.2.1 Connection terminals AVS75.370	17
3.3 Extension modules AVS75.39x	19
3.3.1 Connection terminals AVS75.390	20
3.3.2 Connection terminals AVS75.391	22
3.4 Modbus clip-in OCI351.01/101	24
4 Commissioning	25
4.1 Commissioning with operator units AVS37.x9x	25
4.2 Commissioning with operating unit UI400	27
5 Overview of settings	28
6 The settings in detail	97
6.1 Time programs	97
6.2 Holidays	98
6.3 Heating circuits	99
6.4 Cooling circuit	121
6.5 Ventilation	135
6.6 DHW	143
6.7 Consumer circuits and swimming pool circuit	149
6.8 Swimming pool	152
6.9 Primary controller/system pump	154
6.10 Heat pump	156
6.11 Energy meters	249
6.12 Cascade (heating and cooling)	266
6.13 Supplementary source (generator)	278
6.14 Solar	287
6.15 Solid fuel boiler	294
6.16 Buffer storage tank	299
6.17 DHW storage tank	312
6.18 Instantaneous water heater	344
6.19 General functions	347
6.20 Configuration	354
6.21 LPB	407
6.22 Modbus	411

6.23	Modbus expert.....	417
6.24	Errors	419
6.25	Maintenance/special operation.....	421
6.26	Configuring the extension modules	434
6.27	Diagnostics Modbus slave	444
6.28	Input/output test.....	445
6.29	State.....	449
6.30	Diagnostics cascade.....	455
6.31	Diagnostics heat generation.....	457
6.32	Diagnostics consumers.....	465
6.33	Pump and valve kick.....	472
6.34	Display lists	475
6.34.1	Error codes.....	475
6.34.2	Maintenance codes.....	480
6.34.3	Special operating codes.....	480
7	Plant diagrams.....	482
7.1	Basic plant diagrams	482
8	Technical data.....	507
8.1	Basic unit RVS61.843.....	507
8.2	Extension module AVS75.370.....	510
8.3	Extension module AVS75.390.....	512
8.4	Modbus clip-in OCI350.01/101.....	514
8.5	Modbus clip-in OCI351.01/101.....	515
8.6	Sensor characteristics.....	516
8.6.1	NTC 1k.....	516
8.6.2	NTC 5k.....	517
8.6.3	NTC 10k.....	517
8.6.4	Pt1000.....	518
8.6.5	Room setpoint readjustment	518
8.7	Xp, Tn, Tv – Step response method	519
Index	520

1 Summary

RVS61.843

This User Manual gives a detailed description of the Albatros2 heat pump controller RVS61.843, the compatible extension modules AVS75.370 and AVS75.39x, and the Modbus clip-in OCI351.01.

Product no. (ASN)	Description
RVS61.843	Basic unit for heat pump
AVS75.370	Extension module with connection facility for stepper motor
AVS75.39x	Extension module
OCI350.01	Modbus clip-in
OCI351.01	Modbus clip-in

The User Manual contains settings and configurations for the access levels end-user, heating engineer, and OEM.

Albatros2 range

Heat pump controller RVS61.843 is part of the Albatros2 range, which has been developed for all control tasks in the heating field. The Albatros2 range comprises the following pieces of equipment and devices:

- Service tool (for commissioning), web server (visualization and operation via browser and HomeControl app for mobile phones and tablets) plus other central communication units
- Room units and operating units (HMI), wired or wireless (RF)
- BSB RF gateways for connection to the controller, can be freely positioned on the BSB, used to amplify the wireless signal (repeater)
- Various connecting cables for the connection of extension modules and operating units (HMI)
- Sensors for temperature, pressure, flow, humidity, and indoor air quality
- Housing and covers for wall mounting

Demo case

Demo case KF8921.1 is used to simulate a heat pump plant. In addition to the heat pump controller RVS61.843, the demo case contains a room unit QAA75, the RF module AVS71.390, and a number of potentiometers.

Product no. (ASN)	Description	Document *
Room and operating units (HMI)		
QAA55.110...	Room unit "Basic"	U2358
QAA58.110...	Room unit "Basic", wireless	U2358
AVS37.390	Operating unit "Basic"	U2358
AVS37.x9x...	Operating unit with text display	U2358
QAA74.xxx AVS74.xxx	UI400 room and operator units	U2348
Commissioning and visualization		
OZW672...	Web server for LPB/BSB	N5712, C5712
OCI670	Gateway for LPB/BSB plants	A6V101022127, A6V101022140
OCI700.1	Service interface (including ACS790)	N5655
Gateways and connecting cables		
AVS71.390	RF module (from controller to BSB wireless)	U2358
AVS71.393	RF module BSB (from BSB wire to BSB wireless)	U2358
AVS82.490	Ribbon cable (400 mm) to HMI and extension modules	S2359
AVS82.491	Ribbon cable (1,000 mm) to HMI and extension modules	S2359
AVS82.490	Adapter cable to HMI and extension modules	S2359
AVS82.491	Service cable between room unit and operating unit	S2359
Sensors		
<i>Temperature</i>		
AVS13.399	Wireless outside sensor	U2358
QAC34	Outside sensor NTC 1k	Q1811
QAD36	Strap-on temperature sensor NTC 10k	Q1801
QAZ36	Immersion temperature sensor NTC 10k	Q1843
QAK36...	Threaded immersion temperature sensor NTC 10k	Q1845
QAR36	Strap-on temperature sensor NTC 10k	Q1806
<i>Pressure</i>		
QBE620-P...	Pressure sensor for liquids, gases and refrigerants	Q1909
<i>Flow</i>		
QVE2000...	Flow sensor	N1592
<i>Humidity</i>		
QFA100...	Room hygrostat	N1514
QFA2000	Room sensor for relative humidity	N1850
QFA2060...	Room sensor for relative humidity and temperature	N1850
QXA2000	Condensation monitor	N1542
<i>Indoor air quality</i>		
QPA...	Air quality sensor for rooms	N1901
QAM22...	Air quality sensor for air ducts	N1901
Housing, covers, and demo cases		
AGS7A.100	Housing for wall mounting	S2359
AVS38.291	Dummy cover (96 x 144 mm)	S2359
KF8921.1	Demo case for RVS61.843	S2359
Control technology in buildings		
Siemens Brochure on control technology in buildings		BT_0098

1.1 Type summary

1.1.1 Topology, "building side"

Wired room units

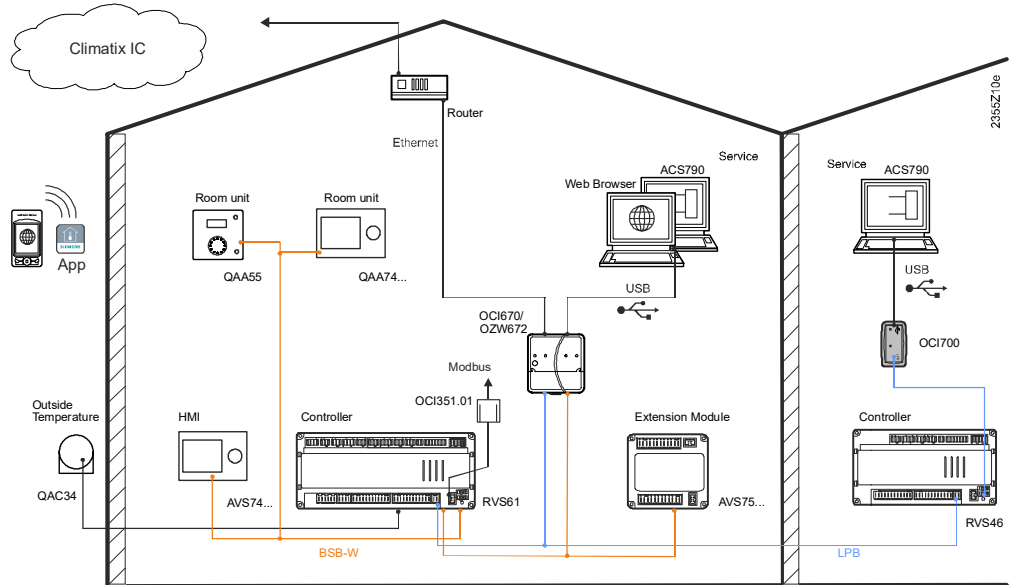

Wireless room units

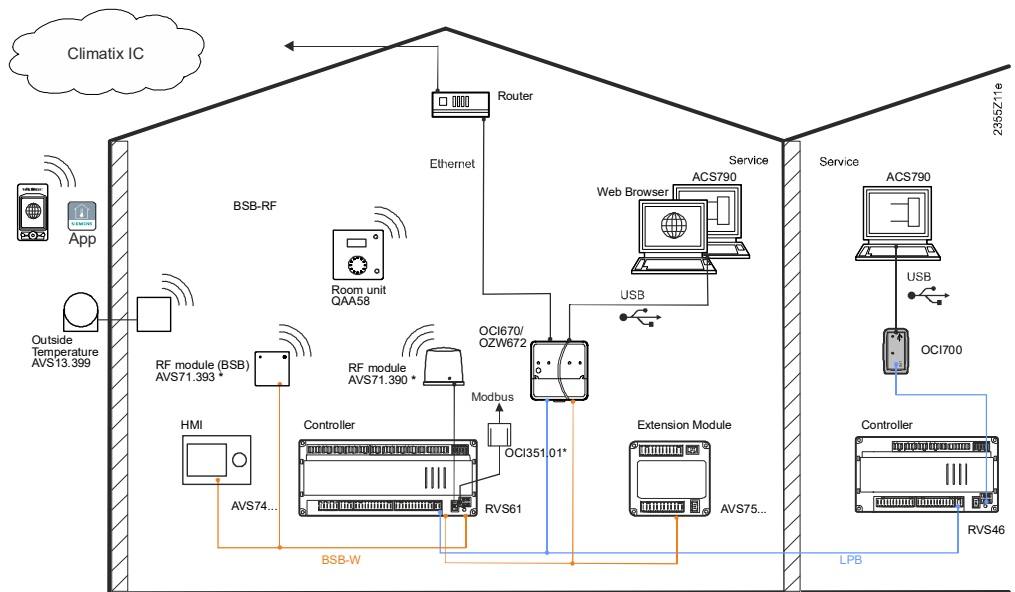

* RF module and RF module BSB only alternatively

* RF Module and OC1351.01 only alternatively

Key

BSB-W	Boiler System Bus, wired
BSB-W	Boiler System Bus, wireless
LPB	Local Process Bus

1.1.2 Topology, "cloud side"

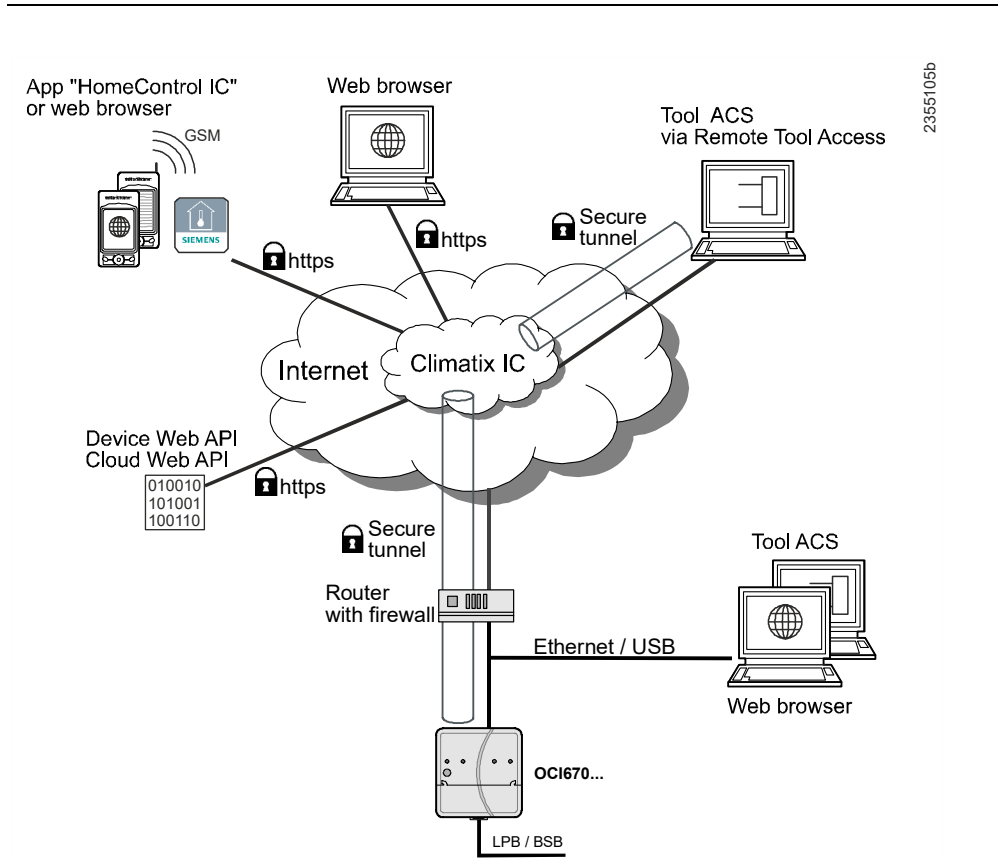

2 Safety notes RVS61.843

Basic concept

- The controller is designed for mounting in a heat pump, a control panel or in a housing fitted to the wall
- The connections for mains and low voltage are physically separated

 WARNING	Electrical installation: <ul style="list-style-type: none">• Prior to installation, power supply to the controller must be turned off• For wiring and setup, the requirements of safety class II must be satisfied• When wiring the system, strictly segregate the AC 230 V section from the AC 24 V safety extra-low voltage (SELV) section to ensure protection against electric shock• Power to the controller may be supplied only when completely installed. If this is not observed, there is a risk of electric shock hazard near the terminals and through the cooling slots
--	--

 WARNING	Safety provided by the equipment: <p>The hardware and firmware (class A) of the RVSxxx heat pump controllers and extension modules (e.g. AVS75.370) are not designed and not able to provide safety-related functions.</p> <p>The safety requirements stipulated by the relevant standards must be ensured by appropriately tested components and facilities, such as a limiting function for shutdown in the event of excessive compressor pressure.</p>
--	--

CAUTION	<ul style="list-style-type: none">• Air circulation around the controller must be ensured, thus making certain that the heat produced by it is emitted• A clearance of at least 10 mm must be provided for the controller's cooling slots at the top and bottom of the device• This space should not be accessible and no objects should be placed there.• If the controller is enclosed in another (insulating) casing, a clearance of up to 100 mm must be observed around the cooling slots• Permissible ambient temperature when mounted and when ready to operate: -20...50 °C• The controller must not be exposed to dripping water
----------------	--

NOTE	<ul style="list-style-type: none">• Power cables must be clearly separated from low-voltage cables (sensors) observing a distance of at least 100 mm• The same sensor must not be connected to several inputs
-------------	--

3 Mounting and installation

3.1 Heat pump controller RVS61.843

Mounting

Screwed

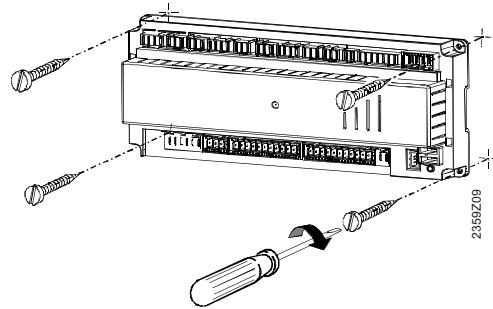

On DIN rail

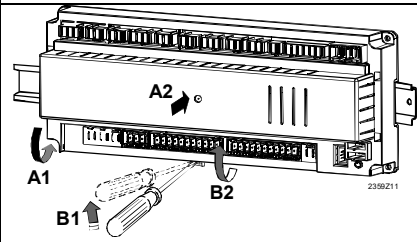

A: Mounting / B: Removal

Note: To mount the controller on a DIN rail, a mounting clip is required!

Dimensions and drilling plan

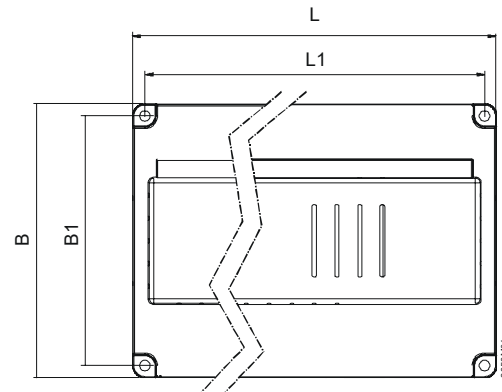

Dimensions in mm

	L	B	H	L1	B1
RVS61.843	281	121	52	270	110

Total height required

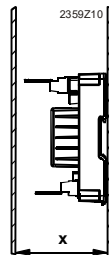

x:

- Connectors with tongues: Min. 70 mm
- Connectors without tongues: Min. 60 mm

3.1.1 Connection terminals RVS61.843

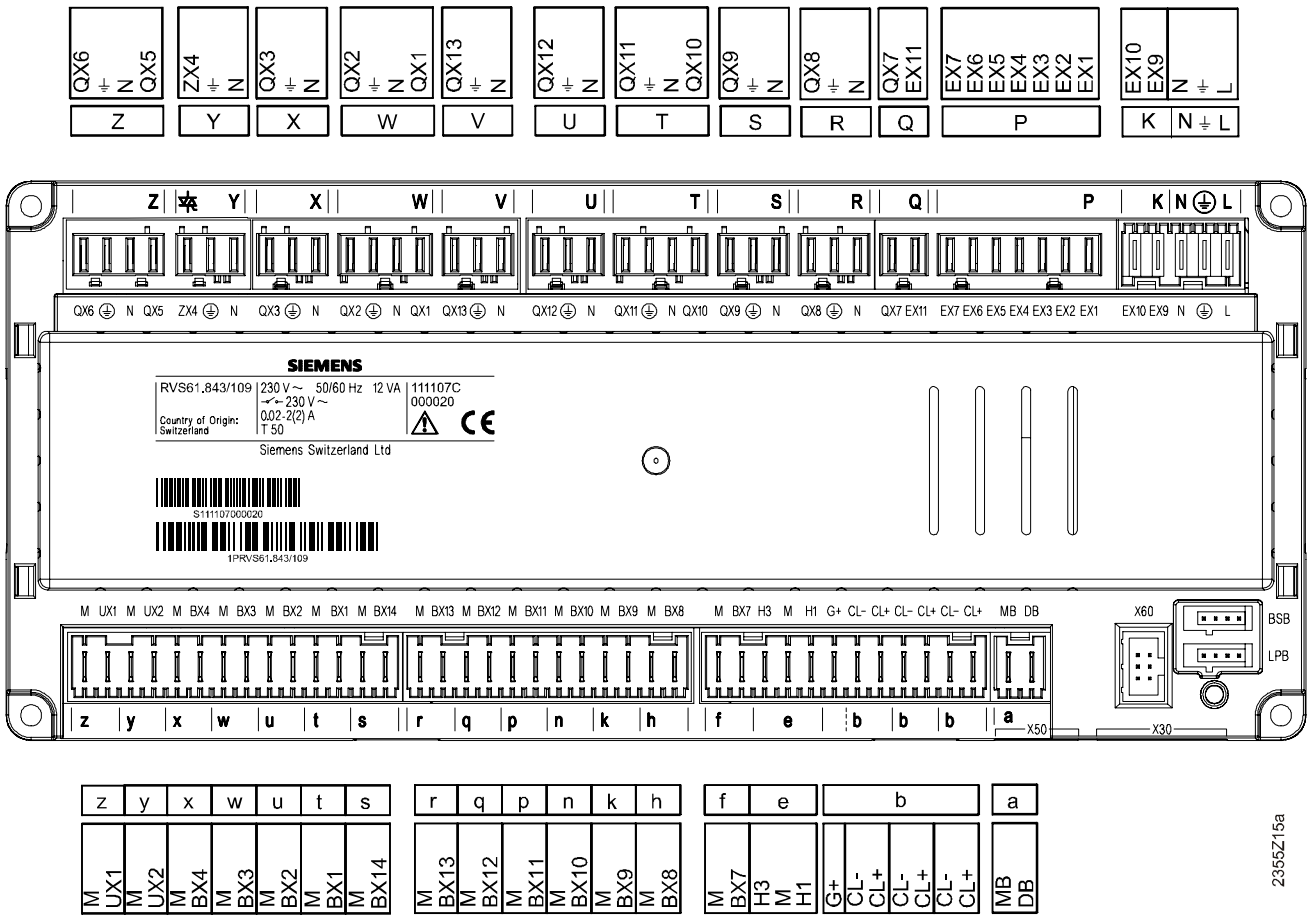

Connection diagram

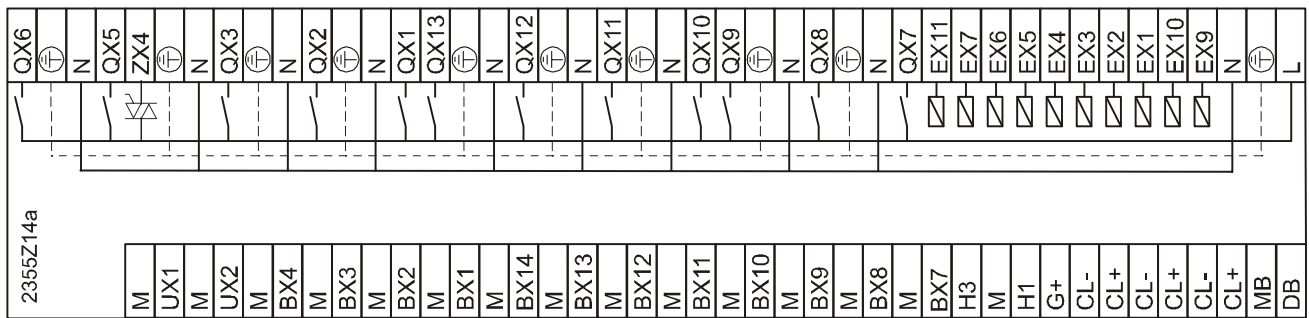

Terminal markings

RVS61.843

Mains voltage

	Use	Socket	Connector type
L	Mains connection, live conductor AC 230 V	L	
⊥	Mains connection, protective earth	⊥	AGP4S.03E/109
N	Mains connection, neutral conductor	N	
EX9	Multifunctional input EX9	K	AGP4S.02J/109
EX10	Multifunctional input EX10		
Alternative to AGP4S.03E/109 and AGP4S.02J/109:			AGP4S.05A/109
EX1	Multifunctional input EX1	B	AGP8S.07A/109
EX2	Multifunctional input EX2		
EX3	Multifunctional input EX3		
EX4	Multifunctional input EX4		
EX5	Multifunctional input EX5		
EX6	Multifunctional input EX6		
EX7	Multifunctional input EX7		
EX11	Multifunctional input EX11	Q	AGP8S.02E/109
QX7	Multifunctional output QX7		
N	Neutral conductor	R	AGP8S.03A/109
⊥	Protective earth		
QX	Multifunctional output QX8		
N	Neutral conductor	S	AGP8S.03B/109
⊥	Protective earth		
QX9	Multifunctional output QX9		
QX10	Multifunctional output QX10	T	AGP8S.04B/109
N	Neutral conductor		
⊥	Protective earth		
QX11	Multifunctional output QX11		
N	Neutral conductor	U	AGP8S.03C/109
⊥	Protective earth		
QX12	Multifunctional output QX12		
N	Neutral conductor	V	AGP8S.03D/109
⊥	Protective earth		
QX13	Multifunctional output QX13		
QX1	Multifunctional output QX1	W	AGP8S.04E/109
N	Neutral conductor		
⊥	Protective earth		
QX2	Multifunctional output QX2		
N	Neutral conductor	X	AGP8S.03E/109
⊥	Protective earth		
QX3	Multifunctional output QX3		
N	Neutral conductor	Y	AGP8S.03G/109
⊥	Protective earth		
ZX4	Triac output ZX4		
QX5	Multifunctional output QX5	Z	AGP8S.04C/109
N	Neutral conductor		
⊥	Protective earth		
QX6	Multifunctional output QX6		

Low-voltage

	<i>Use</i>	<i>Socket</i>	<i>Connector type</i>
	Connection service tool (OCI700) LPB (all controllers visible/operable)	LPB	-
	Connection service tool (OCI700) BSB (1 controller visible/operable)	BSB	-
	RF module AVS71.390 or Modbus clip-in OCI350.01/OCI351.01	X60	-
	Extension modules AVS75.xxx or operating unit (HMI) AVS37.xxx	X50	AVS82.490/109 AVS82.491/109
	Extension modules AVS75.xxx or operating unit (HMI) AVS37.xxx	X30	AVS82.490/109 AVS82.491/109
DB	LPB data bus	a	AGP4S.02H/109
MB	LPB ground bus		
CL+	BSB data bus	b	AGP4S.02A/109
CL-	BSB ground bus		
CL+	Data bus room unit 2	b	AGP4S.02 A /109
CL-	Ground bus room unit 2		
CL+	Data bus room unit 1	b	AGP4S.03D/109
CL-	Ground bus room unit 1		
G+	Power supply optional lighting		
H1	Digital/DC 0...10 V input H1	e	AGP4S.03G/109
M	Ground		
H3	Digital/DC 0...10 V input H3		
BX7	Sensor input BX7	f	AGP4S.02B/109
M	Ground		
BX8	Sensor input BX8	h	AGP4S.02C/109
M	Ground		
BX9	Sensor input BX9	k	AGP4S.02D/109
M	Ground		
BX10	Sensor input BX10	n	AGP4S.02F/109
M	Ground		
BX11	Sensor input BX11	p	AGP4S.02G/109
M	Ground		
BX12	Sensor input BX12	q	AGP4S.02K/109
M	Ground		
BX13	Sensor input BX13	r	AGP4S.02L/109
M	Ground		
BX14	Sensor input BX14	s	AGP4S.02S/109
M	Ground		
BX1	Sensor input BX1	t	AGP4S.02M/109
M	Ground		
BX2	Sensor input BX2	u	AGP4S.02N/109
M	Ground		
BX3	Sensor input BX3	w	AGP4S.02P/109
M	Ground		
BX4	Sensor input BX4	x	AGP4S.02R/109
M	Ground		
UX2	Output UX2 (DC 0...10 V/PWM output)	Y	AGP4S.02T/109
M	Ground		
UX1	Output UX1 (DC 0...10 V/PWM output)	z	AGP4S.02U/109
M	Ground		

3.2 Extension module AVS75.370

i For engineering, mounting location and mounting method, the information given for the basic unit applies.

Dimensions and drilling plan

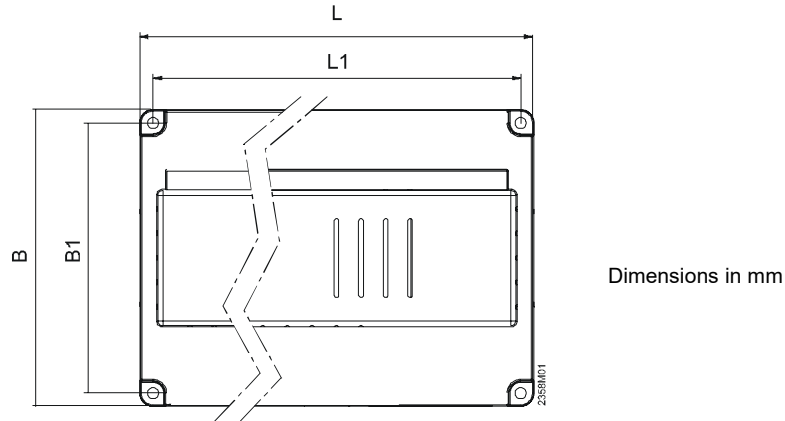

	<i>L</i>	<i>B</i>	<i>H</i>	<i>L1</i>	<i>B1</i>
AVS75.370	108.7	120.9	51.7	98	110

Electrical connections

Use connecting cable AVS82.490/109 or AVS82.491/109 to connect the AVS75.370 extension module (normal usage; see note below) via socket X50 to socket X50 or X30 of the basic unit. The connectors are coded.

Additional modules are connected from socket X50 of the first module to socket X50 of the next module.

A maximum of 3 extension modules can be connected to the basic unit.

- i**
- When observing the maximum number of extension modules, compatible extension modules can be freely combined
 - Extension module AVS75.370 can also be connected to the controller's BSB terminals

3.2.1 Connection terminals AVS75.370

Mains voltage connections

Diagram of AVS75.370

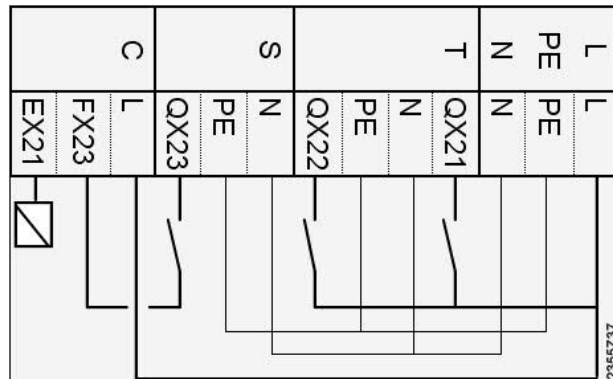

Terminal markings AVS75.370

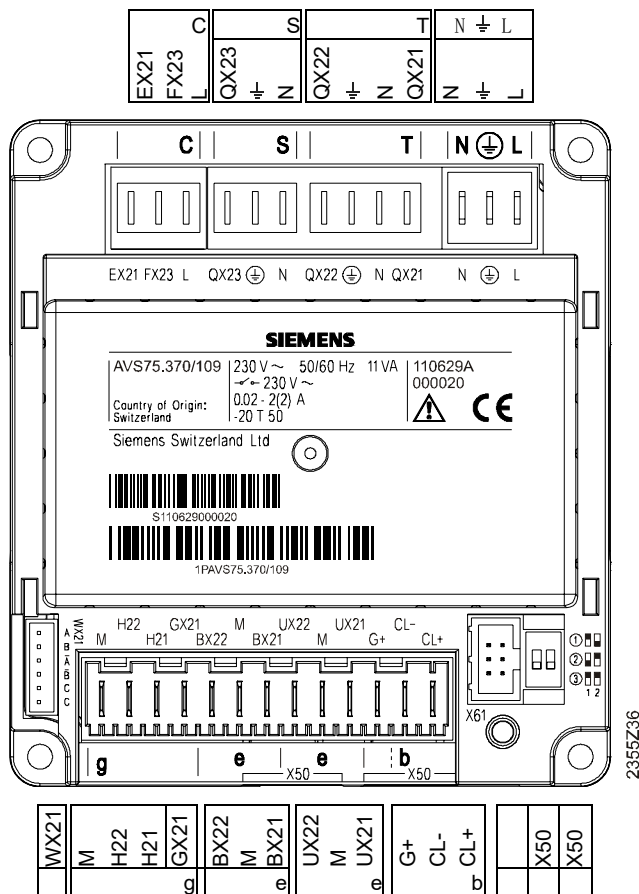

Module address with DIP switches

When using several extension modules, the modules' unambiguous address must be set with the DIP switch. Per default, the modules are set to "Address 1". If a second or third module is connected, their addresses must be changed according to the following assignment:

- ① Address 1: Module 1
- ② Address 2: Module 2
- ③ Address 3: Module 3

The assignment table is also shown on the extension module. Black means: Switch position.

Terminal markings

AVS75.370

Mains voltage

	Use	Socket	Connector type
L	Mains connection, live conductor AC 230 V	L	AGP4S.03E/109
\perp	Mains connection, protective earth	\perp	
N	Mains connection, neutral conductor	N	
QX21	Multifunctional output QX21	T	AGP8S.04B/109
N	Neutral conductor		
\perp	Protective earth		
QX22	Multifunctional output QX22	S	AGP8S.03B/109
N	Neutral conductor		
\perp	Protective earth		
QX23	Multifunctional output QX23	C	AGP8S.03K/109
L	Live conductor AC 230 V		
FX23	Power supply QX23		
EX21	Multifunctional input EX21		

Low-voltage

	Use	Socket	Connector type
	Connection to basic unit or extension module	X50	AVS82.490/109 AVS82.491/109
	Connection to basic unit or extension module	X50	AVS82.490/109 AVS82.491/109
CL+	BSB data bus	b	AGP4S.02A/109 AGP4S.03D/109
CL-	BSB ground bus		
G+	Power supply 12 V (optional lighting)		
UX21	Output UX21 (DC 0...10 V/PWM output)	e	AGP4S.03G/109
M	Ground		
UX22	Output UX22 (DC 0...10 V/PWM output)		
BX21	Sensor input BX21	e	AGP4S.03G/109
M	Ground		
BX22	Sensor input BX22		
GX21	Power supply 5 V/12 V for active sensors	g	AGP4S.04D/109
H21	Digital/DC 0...10 V input H21		
H22	Digital/DC 0...10 V input H22		
M	Ground		
	Connection facility for stepper motor (expansion valve)	WX21	
A	Coil A		
B	Coil B		
\bar{A}	Coil A		
\bar{B}	Coil B		
C	DC 12 V		
C	DC 12 V		

Assignment of terminals

Parameters ...

- "Function extension module 1" (line 7300)
- "Function extension module 2" (line 7375)
- "Function extension module 3" (line 7450)

are used to define usage of the respective module.

3.3 Extension modules AVS75.39x



For engineering, mounting location and mounting method, the information given for the basic units applies.

Dimensions and drilling plan

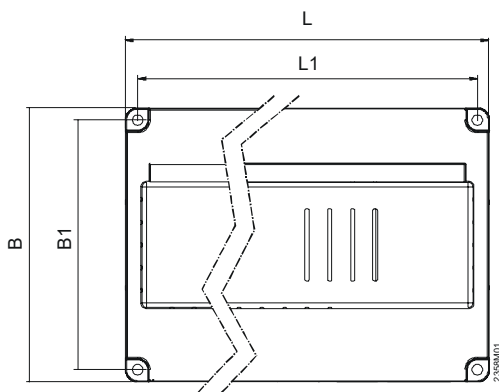

Dimensions in mm

	<i>L</i>	<i>B</i>	<i>H</i>	<i>L1</i>	<i>B1</i>
AVS75.39x	109	121	52	98	110

Electrical connections

Use connecting cable AVS82.490/109 or AVS82.491/109 to connect the AVS75.390 extension module via socket X50 to socket X50 or X30 of the basic unit. The connectors are coded.

Additional modules are connected from socket X50 of the first module to socket X50 of the next module.

A maximum of 3 extension modules can be connected to a basic unit.



- When observing the maximum number of extension modules, compatible extension modules can be freely combined

3.3.1 Connection terminals AVS75.390

Mains voltage connections

Diagram of AVS75.390

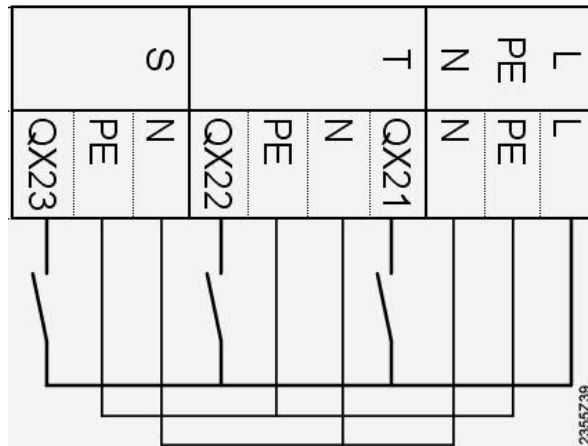

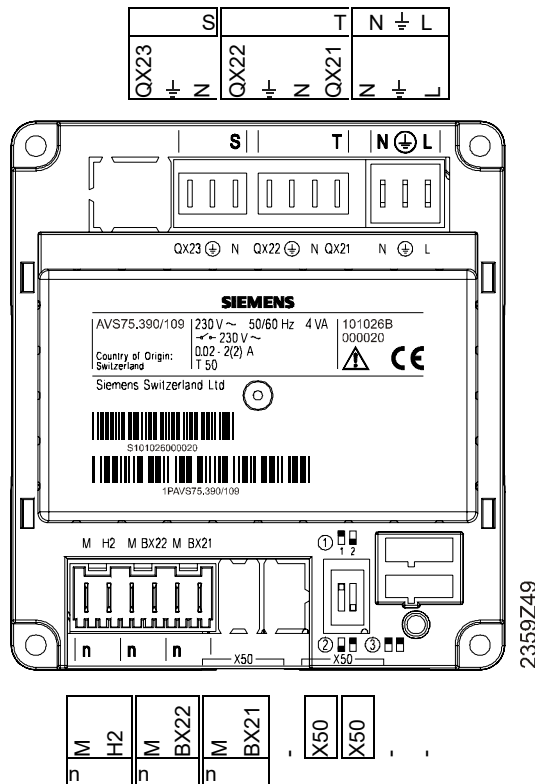

Terminal markings AVS75.390



Module address with DIP switches

When using several extension modules, the modules' unambiguous address must be set with the DIP switch. Per default, the modules are set to "Address 1". If a second or third module is connected, their addresses must be changed according to the following assignment:

- ①  Address 1: Module 1
- ②  Address 2: Module 2
- ③  Address 3: Module 3

The assignment table is also shown on the extension module. Black means: Switch position.

Terminal markings AVS75.390

Mains voltage

	<i>Use</i>	<i>Socket</i>	<i>Connector type</i>
L	Mains connection, live conductor AC 230 V	L	AGP4S.03E/109
\perp	Mains connection, protective earth	\perp	
N	Mains connection, neutral conductor	N	
QX21	Multifunctional output QX21	T	AGP8S.04B/109
N	Neutral conductor		
\perp	Protective earth		
QX22	Multifunctional output QX22	S	AGP8S.03B/109
N	Neutral conductor		
\perp	Protective earth		
QX23	Multifunctional output QX23		

Low-voltage

	<i>Use</i>	<i>Socket</i>	<i>Connector type</i>
	Connection to basic unit or extension module	X50	AVS82.490/109 AVS82.491/109
	Connection to basic unit or extension module	X50	AVS82.490/109 AVS82.491/109
BX21	Sensor input BX21	n	AGP4S.02F/109
M	Ground		
BX22	Sensor input BX22	n	AGP4S.02F/109
M	Ground		
H2	Digital/DC 0...10 V input	n	AGP4S.02F/109
M	Ground		

Assignment of terminals

Parameters ...

- "Function extension module 1" (line 7300)
- "Function extension module 2" (line 7375)
- "Function extension module 3" (line 7450)

are used to define usage of the respective module.

3.3.2 Connection terminals AVS75.391

Mains voltage connections

Diagram of AVS75.391

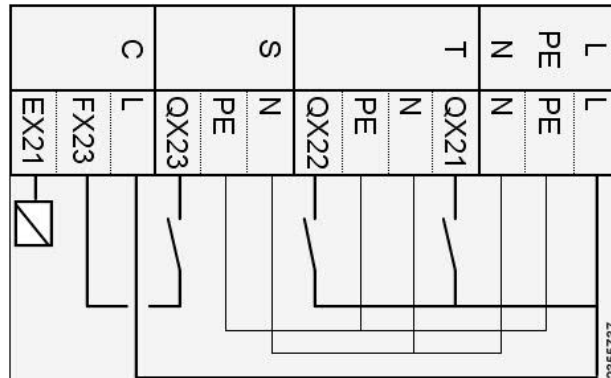

Terminal markings AVS75.391

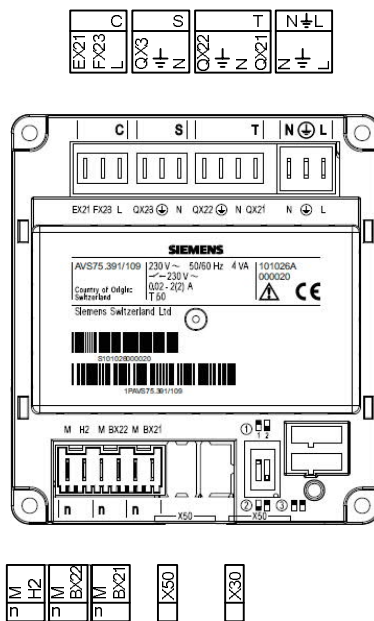

Module address with DIP switches

When using several extension modules, the modules' unambiguous address must be set with the DIP switch. Per default, the modules are set to "Address 1". If a second or third module is connected, their addresses must be changed according to the following assignment:

- ① Address 1: Module 1
- ② Address 2: Module 2
- ③ Address 3: Module 3

The assignment table is also shown on the extension module. Black means: Switch position.

Terminal markings

AVS75.391

Mains voltage

	Use	Socket	Connector type
L	Mains connection, live conductor AC 230 V	L ⏏ N	AGP4S.03E/109
⏏	Mains connection, protective earth		
N	Mains connection, neutral conductor		
QX21	Multifunctional output QX21	T	AGP8S.04B/109
N	Neutral conductor		
⏏	Protective earth		
QX22	Multifunctional output QX22	S	AGP8S.03B/109
N	Neutral conductor		
⏏	Protective earth		
QX23	Multifunctional output QX23	C	AGP8S.03K/109
L	Live conductor AC 230 V		
FX23	Power supply QX23		
EX21	Multifunctional input EX21		

Low-voltage

	Use	Socket	Connector type
	Connection to extension module	X30	AVS82.490/109 AVS82.491/109
	Connection to basic unit or extension module	X50	AVS82.490/109 AVS82.491/109
BX21	Sensor input BX21	n	AGP4S.02F/109
M	Ground		
BX22	Sensor input BX22	n	AGP4S.02F/109
M	Ground		
H2	Digital/DC 0...10 V input	n	AGP4S.02F/109
M	Ground		

Assignment of terminals

Parameters ...

- "Function extension module 1" (line 7300)
- "Function extension module 2" (line 7375)
- "Function extension module 3" (line 7450)

are used to define usage of the respective module.

3.4 Modbus clip-in OCI351.01/101

Front view

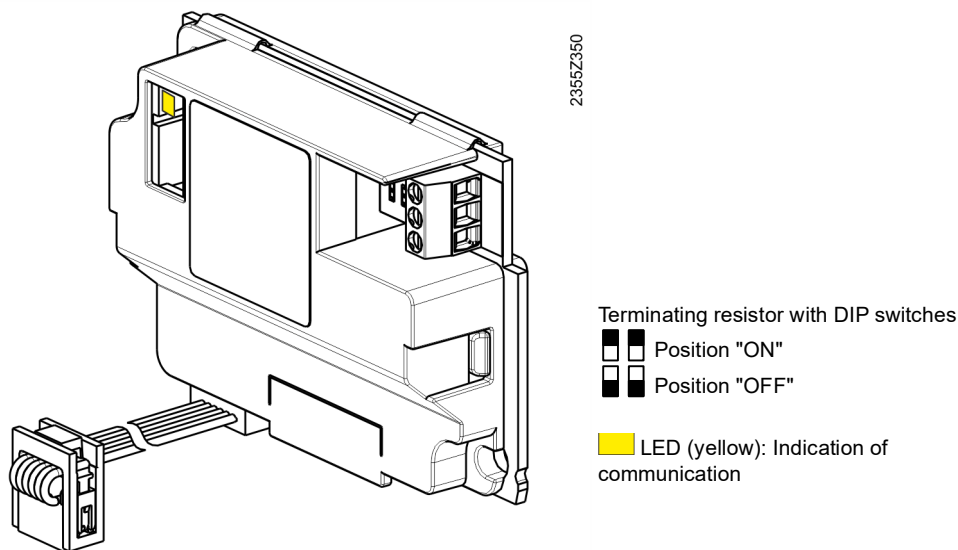

Dimensions and drilling plan

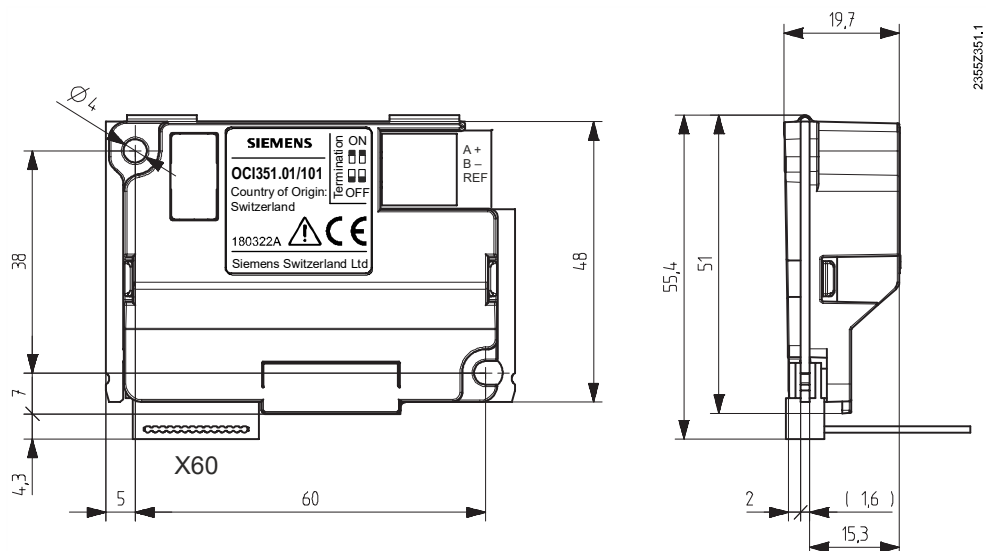

Assignment of terminals

Low-voltage

	Use	Connector type
X60	Connecting cable to RVS	Direct LP connector
A+	TxD+/RxD+ (noninverting pin)	Connection Modbus: 3-pole screw terminal
B-	TxD-/RxD- (inverting pin)	
REF	Reference pin	



4 Commissioning

Prerequisites

Mounting and electrical installation, especially that of the sensors, are completed. All wireless connections, if required, are made.

4.1 Commissioning with operator units AVS37.x9x

Units

AVS37.x9x...	
AVS37.294	AVS37.394
	

Start

The controller is to be set up in connection with the operating unit (HMI). The operating unit (HMI) is to be installed by the source (producer). The operating unit shows the basic display. The basic display can always be retrieved by pressing the ESC button once or several times.



The operating unit's function and the operating buttons are intended for practical usage. Commissioning, by contrast, takes place in programming mode at the user level "Commissioning".

Calling up
"Commissioning"

1. Press the OK button on the operating unit.
The device changes to programming mode.
2. Press the INFO button for 3 seconds.
The user level menu appears.
3. Use the knob to select user level "Commissioning" and confirm by pressing the OK button.

Configuring the basic
settings

Basic settings are made on operating page "Configuration", for example:

- The configuration of inputs and outputs.
 - The selection of the plant diagram (line 5700).
1. Call up user level "Commissioning" as described above.
 2. Use the knob to select operating page "Configuration" and confirm by pressing the OK button.

Resetting the attenuated outside temperature

The controller operates with the attenuated outside temperature. The previous data of the attenuated outside temperature are undefined at the time of commissioning and must be reset.

1. Call up user level "Commissioning" as described above.
2. Use the knob to select operating page "Diagnostics consumers" and confirm by pressing the OK button.
The operating lines of the operating page are displayed.
3. Use the knob to select operating line 8703 "Outside temperature attenuated" "Reset?".
4. Press the OK button.
"Yes" flashes.
5. Confirm by pressing the OK button.
The attenuated outside temperature is reset.
6. Press the ESC button to exit the menus as required.

Commissioning

- Check the controller's inputs and outputs (hardware): Call up operating page "Input/output test" and give consideration to the respective chapters of this User Manual.
- Analyze errors and evaluate messages: Call up operating pages "Diagnostics heat generation" and "Diagnostics consumers" and give consideration to the respective chapters in this User Manual.
- Check controller's current operating state and adjust it: Call up operating page "State" and give consideration to the respective chapters in this User Manual.

LEDs

Controller and extension modules are equipped with an LED.

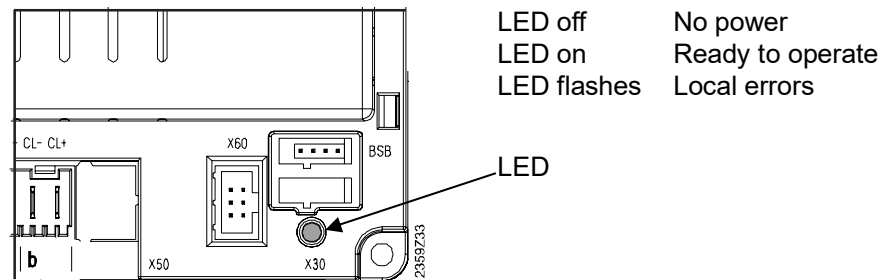

In the case of local errors, refer to operating pages "Diagnostics heat generation" and "Diagnostics consumers" and the respective chapters in this User Manual.

Plant-specific configuration/settings

After commissioning, plant-specific settings are made, for example:

- Settings relating to DHW on operating page "DHW".
- Settings of the source (heat pump) on operating page "Heat pump".

For overview of all settings, refer to chapter 5; the technical explanations of the settings are described in chapter 6.



4.2 Commissioning with operating unit UI400

Units

QAA74.xxx*

AVS74.xxx

QAA 74.xxx does not have a commissioning wizard for the plant.

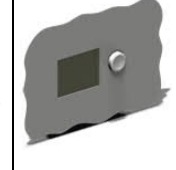
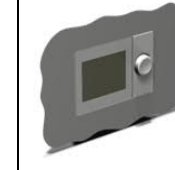
QAA74.611	QAA74.614	AVS74.261	AVS74.661	AVS74.761
Wall	Wall	Panel, frontside	Panel, rearside	Panel, rearside
				

Procedure

The operating units UI400 offer additional possibilities, including producer lock or forced switch on.

A commissioning wizard is available for commissioning; it automatically starts at power up. It guides you through the necessary setting steps.

During commissioning, the present operating states are supplemented on the status display with the wrench symbol .

Detailed information on commissioning the room and operating units UI400 is available in the technical guide for these units (CE1U2348en).

5 Overview of settings



The following table gives an overview of the controller's menus and parameters.

The availability of menus and parameters on a specific controller depends on the following factors:

- Controller version
- Access level (end-user, commissioning engineer, heating engineer)
- Configurations
 - Active plant diagrams (e.g. buffer storage tank or solar)
 - Type of heat pump (brine, water, air)
 - Presence and type of extension module and/or I/O module













Abbreviations

E line	End-user Operating line	F ACS	Heating engineer With ACS tool	I O	Commissioning engineer OEM	 Function with energy saving potential
-----------	----------------------------	----------	-----------------------------------	--------	-------------------------------	---

















Operating line	Op. level	Function	Default value	Min.	Max.	Unit	Green leaf
Time program cooling 1 							
470	E	Preselection Mo - Su Mo - Fr Sa - Su Mo Tu We Th Fr Sa Su	Mo - Su				
471	E	1 st phase on	06:00	00:00	24:00	hh:mm	
472	E	1 st phase off	22:00	00:00	24:00	hh:mm	
473	E	2 nd phase on	24:00	00:00	24:00	hh:mm	
474	E	2 nd phase off	24:00	00:00	24:00	hh:mm	
475	E	3 rd phase on	24:00	00:00	24:00	hh:mm	
476	E	3 rd phase off	24:00	00:00	24:00	hh:mm	
479	E	Default values No Yes	No				
Time program cooling 2 							
480	E	Preselection Mo - Su Mo - Fr Sa - Su Mo Tu We Th Fr Sa Su	Mo - Su				
481	E	1 st phase on	06:00	00:00	24:00	hh:mm	
482	E	1 st phase off	22:00	00:00	24:00	hh:mm	
483	E	2 nd phase on	24:00	00:00	24:00	hh:mm	
484	E	2 nd phase off	24:00	00:00	24:00	hh:mm	
485	E	3 rd phase on	24:00	00:00	24:00	hh:mm	
486	E	3 rd phase off	24:00	00:00	24:00	hh:mm	
489	E	Default values No Yes	No				
Time program cooling 3 							
490	E	Preselection Mo - Su Mo - Fr Sa - Su Mo Tu We Th Fr Sa Su	Mo - Su				
491	E	1 st phase on	06:00	00:00	24:00	hh:mm	
492	E	1 st phase off	22:00	00:00	24:00	hh:mm	
493	E	2 nd phase on	24:00	00:00	24:00	hh:mm	
494	E	2 nd phase off	24:00	00:00	24:00	hh:mm	
495	E	3 rd phase on	24:00	00:00	24:00	hh:mm	
496	E	3 rd phase off	24:00	00:00	24:00	hh:mm	
499	E	Default values No Yes	No				





Operating line	Op. level	Function	Default value	Min.	Max.	Unit	Green leaf
Time prog heating circuit 1							
500	E	Preselection Mo - Su Mo - Fr Sa - Su Mo Tu We Th Fr Sa Su	Mo - Su				
501	E	1 st phase on	06:00	00:00	24:00	hh:mm	
502	E	1 st phase off	22:00	00:00	24:00	hh:mm	
503	E	2 nd phase on	24:00	00:00	24:00	hh:mm	
504	E	2 nd phase off	24:00	00:00	24:00	hh:mm	
505	E	3 rd phase on	24:00	00:00	24:00	hh:mm	
506	E	3 rd phase off	24:00	00:00	24:00	hh:mm	
516	E	Default values No Yes	No				
Time prog heating circuit 2							
520	E	Preselection Mo - Su Mo - Fr Sa - Su Mo Tu We Th Fr Sa Su	Mo - Su				
521	E	1 st phase on	06:00	00:00	24:00	hh:mm	
522	E	1 st phase off	22:00	00:00	24:00	hh:mm	
523	E	2 nd phase on	24:00	00:00	24:00	hh:mm	
524	E	2 nd phase off	24:00	00:00	24:00	hh:mm	
525	E	3 rd phase on	24:00	00:00	24:00	hh:mm	
526	E	3 rd phase off	24:00	00:00	24:00	hh:mm	
536	E	Default values No Yes	No				
Time program 3							
540	E	Preselection Mo - Su Mo - Fr Sa - Su Mo Tu We Th Fr Sa Su	Mo - Su				
541	E	1 st phase on	06:00	00:00	24:00	hh:mm	
542	E	1 st phase off	22:00	00:00	24:00	hh:mm	
543	E	2 nd phase on	24:00	00:00	24:00	hh:mm	
544	E	2 nd phase off	24:00	00:00	24:00	hh:mm	
545	E	3 rd phase on	24:00	00:00	24:00	hh:mm	
546	E	3 rd phase off	24:00	00:00	24:00	hh:mm	
556	E	Default values No Yes	No				
Time program 4/DHW							
560	E	Preselection Mo - Su Mo - Fr Sa - Su Mo Tu We Th Fr Sa Su	Mo - Su				
561	E	1 st phase on	00:00	00:00	24:00	hh:mm	
562	E	1 st phase off	05:00	00:00	24:00	hh:mm	
563	E	2 nd phase on	24:00	00:00	24:00	hh:mm	
564	E	2 nd phase off	24:00	00:00	24:00	hh:mm	
565	E	3 rd phase on	24:00	00:00	24:00	hh:mm	
566	E	3 rd phase off	24:00	00:00	24:00	hh:mm	
576	E	Default values No Yes	No				
Time program ventilation 1							
580	E	Preselection Mo - Su Mo - Fr Sa - Su Mo Tu Mi Do Fr Sa Su	Mo - Su				
581	E	1 st phase on	00:00	00:00	24:00	hh:mm	
582	E	1 st phase off	05:00	00:00	24:00	hh:mm	
583	E	2 nd phase on	24:00	00:00	24:00	hh:mm	
584	E	2 nd phase off	24:00	00:00	24:00	hh:mm	
585	E	3 rd phase on	24:00	00:00	24:00	hh:mm	











Operating line	Op. level	Function	Default value	Min.	Max.	Unit	Green leaf
586	E	3 rd phase off	24:00	00:00	24:00	hh:mm	
589	E	Default values No Yes	No				
Time program ventilation 2							
590	E	Preselection Mo - Su Mo - Fr Sa - Su Mo Tu Mi Do Fr Sa Su	Mo - Su				
591	E	1 st phase on	00:00	00:00	24:00	hh:mm	
592	E	1 st phase off	05:00	00:00	24:00	hh:mm	
593	E	2 nd phase on	24:00	00:00	24:00	hh:mm	
594	E	2 nd phase off	24:00	00:00	24:00	hh:mm	
595	E	3 rd phase on	24:00	00:00	24:00	hh:mm	
596	E	3 rd phase off	24:00	00:00	24:00	hh:mm	
599	E	Default values No Yes	No				
Time program 5							
600	E	Preselection Mo - Su Mo - Fr Sa - Su Mo Tu We Th Fr Sa Su	Mo - Su				
601	E	1 st phase on	06:00	00:00	24:00	hh:mm	
602	E	1 st phase off	22:00	00:00	24:00	hh:mm	
603	E	2 nd phase on	24:00	00:00	24:00	hh:mm	
604	E	2 nd phase off	24:00	00:00	24:00	hh:mm	
605	E	3 rd phase on	24:00	00:00	24:00	hh:mm	
606	E	3 rd phase off	24:00	00:00	24:00	hh:mm	
616	E	Default values No Yes	No				
Time program ventilation 3							
620	E	Preselection Mo - Su Mo - Fr Sa - Su Mo Tu Mi Do Fr Sa Su	Mo - Su				
621	E	1 st phase on	00:00	00:00	24:00	hh:mm	
622	E	1 st phase off	05:00	00:00	24:00	hh:mm	
623	E	2 nd phase on	24:00	00:00	24:00	hh:mm	
624	E	2 nd phase off	24:00	00:00	24:00	hh:mm	
625	E	3 rd phase on	24:00	00:00	24:00	hh:mm	
626	E	3 rd phase off	24:00	00:00	24:00	hh:mm	
629	E	Default values No Yes	No				
Holidays zone 1							
641	E	Preselection Period 1...8		1	8		
642	E	Start	--:--	01.01	31.12	DD.MM	
643	E	End	--:--	01.01	31.12	DD.MM	
648	E	Operating level Protection Reduced	Protection				
Holidays zone 2							
651	E	Preselection Period 1...8		1	8		
652	E	Start	--:--	01.01	31.12	DD.MM	
653	E	End	--:--	01.01	31.12	DD.MM	
658	E	Operating level Protection Reduced	Protection				
Holidays zone 3							
661	E	Preselection Period 1...8		1	8		



Operating line	Op. level	Function	Default value	Min.	Max.	Unit	Green leaf
662	E	Start	--:--	01.01	31.12	DD.MM	
663	E	End	--:--	01.01	31.12	DD.MM	
668	E	Operating level Protection Reduced	Protection				
Heating circuit 1							
Operating mode							
700	E	Operating mode Protection Automatic Reduced Comfort	Automatic				
Setpoints							
710	E	Comfort setpoint	20.0	Line 712	Line 716	°C	
712	E	Reduced setpoint	19	Line 714	Line 710	°C	
714	E	Protection setpoint	10.0	4	Line 712	°C	
716	F	Comfort setpoint max	35.0	Line 710	35	°C	
Heating curve							
720	E	Heating curve slope	0.8	0.10	4.00		
721	F	Heating curve displacement	0.0	-4.5	4.5	°C	
726	F	Heating curve adaption Off On	Off				
"Eco" functions							
730	E	Summer/winter heating limit	18	--- / 8	30	°C	
732	F	24-hour heating limit	-3	--- / -10	10	°C	
733	O	Ext'n 24-hour heating limit No Yes	Yes				
Limitations of flow temperature setpoint							
740	I	Flow temp setpoint min	8	8	Line 741	°C	
741	I	Flow temp setpoint max	50	Line 740	95	°C	
742	E	Flow temp setpoint room stat	---	--- / line 740	Line 741	°C	
744	O	Swi-on ratio room stat	---	--- / 1	99	%	
Room influence							
750	F	Room influence	20	--- / 1	100	%	
Room temperature limitation							
760	F	Room temp limitation	1	--- / 0	4	°C	
Boost heating/quick setback							
761	O	Heating limit room controller	6	0	100	%	
762	O	Prop band Xp room contr	3	0.5	32	°C	
763	O	Int act time Tn room contr	4800	10	24000	s	
764	O	Der act time Tv room contr	480	10	2400	s	
766	O	SD room temp limitation	25	0	100	%	
Boost heating/quick setback							
770	F	Boost heating	---	--- / 0	20	°C	
780	F	Quick setback Off To Reduced setpoint To Protection setpoint	To Reduced setpoint				
Optimum start/stop control							
790	F	Optimum start control max	0:00:00	00:00:00	00:06:00	hh:mm:ss	
791	F	Optimum stop control max	0:00:00	00:00:00	00:06:00	hh:mm:ss	
794	F	Heat up gradient	60	0	600	min/K	
Increase of "Reduced" setpoint							
800	F	Reduced setp increase start	---	--- / line 801	10	°C	
801	F	Reduced setp increase end	-15	-30	Line 800	°C	

















Operating line	Op. level	Function	Default value	Min.	Max.	Unit	Green leaf
Heating circuit pump							
810	F	Frost prot plant HC pump Off On	On				
813	O	Frost prot room model Off On	On				
Overtemperature protection							
820	F	Overtemp prot pump circuit Off On	Off				
Control of mixing valve							
830	F	Mixing valve boost	0	0	50	°C	
832	F	Actuator type 2-position 3-position	3-position				
833	F	Switching differential 2-pos	2	0	20	°C	
834	F	Actuator running time	120	30	650	s	
835	O	Mixing valve Xp	24	1	100	°C	
836	O	Mixing valve Tn	90	10	650	s	
"Floor curing" function							
850	I	Floor curing function Off Functional heating Curing heating Functional/curing heating Curing/functional heating Manually	Off				
851	I	Floor curing setp manually	25	0	95	°C	
856	I	Floor curing day current	0	0	32	-	
857	I	Floor curing days completed	0	0	32	-	
Forced&Lock							
861	F	Excess heat draw Off Heating mode Always	Always				
863	F	Minimum flow function Off On	Off				
Buffer storage tank/primary controller							
870	F	With buffer No Yes	Yes				
872	F	With prim contr/system pump No Yes	Yes				
Speed-controlled pump							
880	F	Pump speed reduction Operating level Characteristic	Characteristic				
881	O	Starting speed	80	0	100	%	
882	F	Pump speed min	40	0	Line 883	%	
883	F	Pump speed max	100	Line 882	100	%	
885	O	Pump speed min OEM	40	0	Line 883	%	
886	O	Pump speed max OEM	100	Line 882	100	%	
888	O	Curve readj at 50% speed	33	0	100	%	
890	O	Flow setp readj speed ctrl No Yes	No				
882	F	Pump speed min	40	0	Line 883	%	
883	F	Pump speed max	100	Line 882	100	%	
Remote control							
900	F	Optg mode changeover None Protection Reduced Comfort Automatic	Protection				





Operating line	Op. level	Function	Default value	Min.	Max.	Unit	Green leaf
Cooling circuit 1							
Operating mode							
901	E	Operating mode Protection Automatic Reduced Comfort	Automatic				
Setpoints							
902	E	Comfort setpoint	24	Line 905	Line 903	°C	
903	E	Reduced setpoint	26	Line 902	Line 904	°C	
904	E	Protection setpoint	35	Line 903	40	°C	
905	F	Comfort setpoint min	5	5	Line 902	°C	
Release							
907	I	Release Time program HC Time program CC	Time program HC				
Cooling curve							
908	I	Flow temp setp at OT 25°C	20	6	35	°C	
909	I	Flow temp setp at OT 35°C	16	6	35	°C	
"Eco" functions							
912	I	Cooling limit at OT	20	--- / 8	35	°C	
913	F	Lock time at end heat/cool	24	--- / 8	100	h	
914	F	24-hour cooling limit	3	--- / -10	10	°C	
915	O	Ext'n 24-hour cooling limit No Yes	Yes				
Summer compensation							
918	F	Summer comp start at OT	26	20	Line 919	°C	
919	F	Summer comp end at OT	35	Line 918	50	°C	
920	F	Summer comp setp increase	4	--- / 1	10	°C	
Limitations of flow temperature setpoint							
923	F	Flow temp setp min OT 25°C	18	6	35	°C	
924	F	Flow temp setp min OT 35°C	18	6	35	°C	
Room influence							
928	F	Room influence	80	--- / 1	100	%	
929	O	Prop band Xp room contr	1.5	0.5	32	°C	
930	O	Int act time Tn room contr	5400	10	24000	s	
931	O	Der act time Tv room contr	10	10	2400	s	
Room temperature limitation							
932	F	Room temp limitation	0.5	--- / 0	4	°C	
Optimizations							
935	F	Quick increase Off To Reduced setpoint To Protection setpoint	To Reduced setpoint				
Frost protection							
937	F	Frost prot plant CC pump Off On	Off				
Control of mixing valve							
938	F	Mixing valve decrease	0	0	20	°C	
939	F	Actuator type 2-position 3-position	3-position				
940	F	Switching differential 2-pos	2	0	20	°C	
941	F	Actuator running time	120	30	650	s	
942	O	Mixing valve Xp	12	1	100	°C	
943	O	Mixing valve Tn	90	10	650	s	
945	F	Mixing valve in heating mode Control Open	Open				











Operating line	Op. level	Function	Default value	Min.	Max.	Unit	Green leaf
Dewpoint monitoring							
946	F	Lock time dewpoint monitor	60	- - - / 10	600	min	
947	F	Flow temp setp incr hygro	10	- - - / 1	20	°C	
948	F	Flow setp incr start at r.h.	60	0	100	%	
950	F	Flow temp diff dewpoint	2	- - - / 0	5	°C	
Buffer storage tank/primary controller							
962	F	With buffer No Yes	No				
963	F	With prim contr/system pump No Yes	No				
Remote control							
969	F	Optg mode changeover None Protection Reduced Comfort Automatic	Protection				
Ventilation 1							
Operating mode							
970	E	Operating mode Off Automatic Stage 1 Stage 2 Stage 3	Automatic				
Air quality							
974	F	Air quality Comfort	1000	0	OL 975	ppm	
975	F	Air quality Reduced	1600	OL 974	2000	ppm	
ACS	O	P-band (Xp) indoor air quality	400	0	2000	ppm	
Boost ventilation							
977	E	Boost ventilation ... Boost ventilation	...				
978	F	Duration boost ventilation	30	0	240	min	
979	F	Stage boost ventilation Off Stage 1 Stage 2 Stage 3	Stage 3				
Night cooling							
981	I	Forward shift night cooling	0	0	1440	min	
983	F	Stage night cooling Off Stage 1 Stage 2 Stage 3	Stage 1				
ACS	O	Min duration night cooling	30	0	720	min	
ACS	I	Outside temp limit night cooling	12	0	50	°C	
ACS	I	Min temp diff room/outside for night cooling	5	0	20	°C	
Room humidity limit							
985	F	Room humidity limit	85	1	100	%	
987	F	Stage room humidity limit Off Stage 1 Stage 2 Stage 3	Off				
ACS	O	Room humidity limitation, switching differential	5	0	20	%	
ACS	O	Room humidity limitation, on time	30	0	720	min	
ACS	O	Room humidity limitation, off time	60	0	720	min	
Operating modes and stages							
989	F	Stage Comfort Off Stage 1 Stage 2 Stage 3	Stage 2				
991	F	Stage Reduced Off Stage 1 Stage 2 Stage 3	Stage 1				
992	F	Stage Protection Off Stage 1 Stage 2 Stage 3	Stage 1				
995	I	Optg mode changeover None Off Stage 1 Stage 2 Stage 3	Off				
Ventilation switch							
996	F	Duration ventilation switch	0	0	240	min	

Operating line	Op. level	Function	Default value	Min.	Max.	Unit	Green leaf
997	F	Stage ventilation switch Off Stage 1 Stage 2 Stage 3	Stage 1				
Holiday mode ventilation							
ACS	I	Holiday mode, switch-on time ventilation	10:00	00:00	23:50	hh:mm	
ACS	I	Holiday mode, on time ventilation	30	0	360	min	
Air cooling 1							
ACS	I	Operating mode Protection Automatic Reduced Comfort	Automatic				
ACS	I	Comfort setpoint	24	5	Red. SW	°C	
ACS	I	Reduced setpoint	26	Comf. SW	40	°C	
ACS	I	Start of summer compensation at outside temp	26	20	End SK	°C	
ACS	I	End of summer compensation at outside temp	35	Begin SK	35	°C	
ACS	I	Summer compensation, setpoint increase	4	1	10	°C	
ACS	I	Release 24h/day Time program heating circuit Time program 5 Time program ventilation	Time program heating circuit				
Heating circuit 2							
1000	E	Operating mode Protection Automatic Reduced Comfort	Automatic				
Setpoints							
1010	E	Comfort setpoint	20.0	Line 1012	Line 1016	°C	
1012	E	Reduced setpoint	19	Line 1014	Line 1010	°C	
1014	E	Protection setpoint	10.0	4	Line 1012	°C	
1016	F	Comfort setpoint max	35.0	Line 1010	35	°C	
Heating curve							
1020	E	Heating curve slope	0.8	0.10	4.00	-	
1021	F	Heating curve displacement	0.0	-4.5	4.5	°C	
1026	F	Heating curve adaption Off On	Off				
"Eco" functions							
1030	E	Summer/winter heating limit	18	--- / 8	30	°C	
1032	F	24-hour heating limit	-3	--- / -10	10	°C	
1033	O	Ext'n 24-hour heating limit No Yes	Yes				
Limitations of flow temperature setpoint							
1040	I	Flow temp setpoint min	8	8	Line 1041	°C	
1041	I	Flow temp setpoint max	50	Line 1040	95	°C	
1042	E	Flow temp setpoint room stat	---	--- / line1040	Line 1041	°C	
1044	O	Swi-on ratio room stat	---	--- / 1	99	%	
Room influence							
1050	F	Room influence	20	--- / 1	100	%	
Room temperature limitation							
1060	F	Room temp limitation	1	--- / 0	4	°C	
1061	O	Heating limit room controller	6	0	100	%	
1062	O	Prop band Xp room contr	3	0.5	32	°C	
1063	O	Int act time Tn room contr	4800	10	24000	s	
1064	O	Der act time Tv room contr	480	10	2400	s	
1066	O	SD room temp limitation	25	0	100	%	

















Operating line	Op. level	Function	Default value	Min.	Max.	Unit	Green leaf
Boost heating/quick setback							
1070	F	Boost heating	---	--- / 0	20	°C	
1080	F	Quick setback Off To Reduced setpoint To Protection setpoint	To Reduced setpoint				
Optimum start/stop control							
1090	F	Optimum start control max	0:00:00	00:00:00	00:06:00	hh:mm:ss	
1091	F	Optimum stop control max	0:00:00	00:00:00	00:06:00	hh:mm:ss	
1094	F	Heat up gradient	60	0	600	min/K	
Increase of "Reduced" setpoint							
1100	F	Reduced setp increase start	---	-- -/line 1101	10	°C	
1101	F	Reduced setp increase end	-15	-30	Line 1100	°C	
Heating circuit pump							
1110	F	Frost prot plant HC pump Off On	On				
1113	O	Frost prot room model Off On	On				
Overtemperature protection							
1120	F	Overtemp prot pump circuit Off On	Off				
Control of mixing valve							
1130	F	Mixing valve boost	0	0	50	°C	
1132	F	Actuator type 2-position 3-position	3-position				
1133	F	Switching differential 2-pos	2	0	20	°C	
1134	F	Actuator running time	120	30	650	s	
1135	O	Mixing valve Xp	24	1	100	°C	
1136	O	Mixing valve Tn	90	10	650	s	
"Floor curing" function							
1150	I	Floor curing function Off Functional heating Curing heating Functional/curing heating Curing/functional heating Manually	Off			-	
1151	I	Floor curing setp manually	25	0	95	°C	
1156	I	Floor curing day current	---	0	32	°C	
1157	I	Floor curing days completed	0	0	32	-	
Forced&Lock							
1161	F	Excess heat draw Off Heating mode Always	Always				
1163	F	Minimum flow function Off On	Off				
Buffer storage tank/primary controller							
1170	F	With buffer No Yes	Yes				
1172	F	With prim contr/system pump No Yes	Yes				
Speed-controlled pump							
1180	F	Pump speed reduction Operating level Characteristic	Characteristic				
1181	O	Starting speed	80	0	100	%	
1182	F	Pump speed min	40	0	Line 1183	%	
1183	F	Pump speed max	100	Line 1182	100	%	
1185	O	Pump speed min OEM	40	0	Line 883	%	
1186	O	Pump speed max OEM	100	Line 882	100	%	





Operating line	Op. level	Function	Default value	Min.	Max.	Unit	Green leaf
1188	O	Curve readj at 50% speed	33	0	100	%	
1190	O	Flow setp readj speed ctrl No Yes	No				
1182	F	Pump speed min	40	0	Line 1183	%	
1183	F	Pump speed max	100	Line 1182	100	%	
Remote control							
1200	F	Optg mode changeover None Protection Reduced Comfort Automatic	Protection				
Cooling circuit 2							
Operating mode							
1201	E	Operating mode Protection Automatic Reduced Comfort	Automatic				
Setpoints							
1202	E	Comfort setpoint	24	Line 1205	Line 1203	°C	
1203	E	Reduced setpoint	26	Line 1202	Line 1204	°C	
1204	E	Protection setpoint	35	Line 1203	40	°C	
1205	F	Comfort setpoint min	5	5	Line 1202	°C	
Release							
1207	I	Release Time program HC Time program CC	Time program HC				
Cooling curve							
1208	I	Flow temp setp at OT 25°C	20	6	35	°C	
1209	I	Flow temp setp at OT 35°C	16	6	35	°C	
"Eco" functions							
1212	I	Cooling limit at OT	20	--- / 8	35	°C	
1213	F	Lock time at end of heating	24	--- / 8	100	h	
1214	F	24-hour cooling limit	3	--- / -10	10	°C	
1215	O	Ext'n 24-hour cooling limit No Yes	Yes				
Summer compensation							
1218	F	Summer comp start at OT	26	20	Line 1219	°C	
1219	F	Summer comp end at OT	35	Line 1218	50	°C	
1220	F	Summer comp setp increase	4	--- / 1	10	°C	
Limitations of flow temperature setpoint							
1223	F	Flow temp setp min OT 25°C	18	6	35	°C	
1224	F	Flow temp setp min OT 35°C	18	6	35	°C	
Room influence							
1228	F	Room influence	80	--- / 1	100	%	
1229	O	Prop band Xp room contr	1.5	0.5	32	°C	
1230	O	Int act time Tn room contr	5400	10	24000	s	
1231	O	Der act time Tv room contr	10	10	2400	s	
Room temperature limitation							
1232	F	Room temp limitation	0.5	--- / 0	4	°C	
Optimizations							
1235	F	Quick increase Off To Reduced setpoint To Protection setpoint	To Reduced setpoint				
Frost protection							
1237	F	Frost prot plant CC pump Off On	Off				
Control of mixing valve							
1238	F	Mixing valve decrease	0	0	20	°C	



Operating line	Op. level	Function	Default value	Min.	Max.	Unit	Green leaf
1239	F	Actuator type 2-position 3-position	3-position				
1240	F	Switching differential 2-pos	2	0	20	°C	
1241	F	Actuator running time	120	30	650	s	
1242	O	Mixing valve Xp	12	1	100	°C	
1243	O	Mixing valve Tn	90	10	650	s	
1245	F	Mixing valve in heating mode Control Open	Open				
Dewpoint monitoring							
1246	F	Lock time dewpoint monitor	60	--- / 10	600	min	
1247	F	Flow temp setp incr hygro	10	--- / 1	20	°C	
1248	I	Flow setp incr start at r.h.	60	0	100	%	
1250	I	Flow temp diff dewpoint	2	--- / 0	5	°C	
Buffer storage tank/primary controller							
1262	F	With buffer No Yes	No				
1263	F	With prim contr/system pump No Yes	No				
Remote control							
1269	F	Optg mode changeover None Protection Reduced Comfort Automatic	Protection				
Ventilation 2							
Operating mode							
1270	E	Operating mode Off Automatic Stage 1 Stage 2 Stage 3	Automatic				
Air quality							
1274	F	Air quality Comfort	1000	0	OL 1275	ppm	
1275	F	Air quality Reduced	1600	OL 1274	2000	ppm	
ACS	O	P-band (Xp) indoor air quality	400	0	2000	ppm	
Boost ventilation							
1277	E	Boost ventilation ... Boost ventilation	...				
1278	F	Duration boost ventilation	30	0	240	min	
1279	F	Stage boost ventilation Off Stage 1 Stage 2 Stage 3	Stage 3				
Night cooling							
1281	I	Forward shift night cooling	0	0	1440	min	
1283	F	Stage night cooling Off Stage 1 Stage 2 Stage 3	Stage 1				
ACS	O	Min duration night cooling	30	0	720	min	
ACS	I	Outside temp limit night cooling	12	0	50	°C	
ACS	I	Min temp diff room/outside for night cooling	5	0	20	°C	
Room humidity limit							
1285	F	Room humidity limit	85	1	100	%	
1287	F	Stage room humidity limit Off Stage 1 Stage 2 Stage 3	Off				
ACS	O	Room humidity limitation, switching differential	5	0	20	%	
ACS	O	Room humidity limitation, on time	30	0	720	min	
ACS	O	Room humidity limitation, off time	60	0	720	min	
Operating modes and stages							
1289	F	Stage Comfort Off Stage 1 Stage 2 Stage 3	Stage 2				









Operating line	Op. level	Function	Default value	Min.	Max.	Unit	Green leaf
1291	F	Stage Reduced Off Stage 1 Stage 2 Stage 3	Stage 1				
1292	F	Stage protection Off Stage 1 Stage 2 Stage 3	Stage 1				
1295	I	Optg mode changeover None Off Stage 1 Stage 2 Stage 3	Off				
Ventilation switch							
1296	F	Duration ventilation switch	0	0	240	min	
1297	F	Stage ventilation switch Off Stage 1 Stage 2 Stage 3	Stage 1				
Holiday mode ventilation							
ACS	I	Holiday mode, switch-on time ventilation	10:00	00:00	23:50	hh:mm	
ACS	I	Holiday mode, on time ventilation	30	0	360	min	
Air cooling 2							
ACS	I	Operating mode Protection Automatic Reduced Comfort	Automatic				
ACS	I	Comfort setpoint	24	5	Red. SW	°C	
ACS	I	Reduced setpoint	26	Comf. SW	40	°C	
ACS	I	Start of summer compensation at outside temp	26	20	End SK	°C	
ACS	I	End of summer compensation at outside temp	35	Begin SK	35	°C	
ACS	I	Summer compensation, setpoint increase	4	1	10	°C	
ACS	I	Release 24h/day Time program heating circuit Time program 5 Time program ventilation	Time program heating circuit				
Heating circuit 3							
1300	E	Operating mode Protection Automatic Reduced Comfort	Automatic				
Setpoints							
1310	E	Comfort setpoint	20.0	Line 1312	Line 1316	°C	
1312	E	Reduced setpoint	19	Line 1314	Line 1310	°C	
1314	E	Protection setpoint	10.0	4	Line 1312	°C	
1316	F	Comfort setpoint max	35.0	Line 1310	35	°C	
Heating curve							
1320	E	Heating curve slope	0.8	0.10	4.00	-	
1321	F	Heating curve displacement	0.0	-4.5	4.5	°C	
1326	F	Heating curve adaption Off On	Off				
"Eco" functions							
1330	E	Summer/winter heating limit	18	-- / 8	30	°C	
1332	F	24-hour heating limit	-3	-- / -10	10	°C	
1333	O	Ext'n 24-hour heating limit No Yes	Yes				
Limitations of flow temperature setpoint							
1340	I	Flow temp setpoint min	8	8	Line 1341	°C	
1341	I	Flow temp setpoint max	50	Line 1340	95	°C	
1342	E	Flow temp setpoint room stat	---	--- /line1340	Line 1341	°C	
1344	O	Swi-on ratio room stat	---	--- / 1	99	%	
Room influence							
1350	F	Room influence	20	-- / 1	100	%	
Room temperature limitation							
1360	F	Room temp limitation	1	-- / 0	4	°C	
1361	O	Heating limit room controller	6	0	100	%	





Operating line	Op. level	Function	Default value	Min.	Max.	Unit	Green leaf
1362	O	Prop band Xp room contr	3	0.5	32	°C	
1363	O	Int act time Tn room contr	4800	10	24000	s	
1364	O	Der act time Tv room contr	480	10	2400	s	
1366	O	SD room temp limitation	25	0	100	%	
Boost heating/quick setback							
1370	F	Boost heating	---	--/0	20	°C	
1380	F	Quick setback Off To Reduced setpoint To Protection setpoint	To Reduced setpoint				🌿
Optimum start/stop control							
1390	F	Optimum start control max	0:00:00	00:00:00	00:06:00	hh:mm:ss	
1391	F	Optimum stop control max	0:00:00	00:00:00	00:06:00	hh:mm:ss	🌿
1394	F	Heat up gradient	60	0	600	min/K	
Increase of "Reduced" setpoint							
1400	F	Reduced setp increase start	---	---/line1401	10	°C	
1401	F	Reduced setp increase end	-15	-30	Line 1400	°C	
Heating circuit pump							
1410	F	Frost prot plant HC pump Off On	On				
1413	O	Frost prot room model Off On	On				
Overtemperature protection							
1420	F	Overtemp prot pump circuit Off On	Off				
Control of mixing valve							
1430	F	Mixing valve boost	0	0	50	°C	
1432	F	Actuator type 2-position 3-position	3-position				
1433	F	Switching differential 2-pos	2	0	20	°C	
1434	F	Actuator running time	120	30	650	s	
1435	O	Mixing valve Xp	24	1	100	°C	
1436	O	Mixing valve Tn	90	10	650	s	
"Floor curing" function							
1450	I	Floor curing function Off Functional heating Curing heating Functional/curing heating Curing/functional heating Manually	Off				
1451	I	Floor curing setp manually	25	0	95	°C	
1456	I	Floor curing day current	0	0	32	-	
1457	I	Floor curing days completed	0	0	32	-	
Forced&Lock							
1461	F	Excess heat draw Off Heating mode Always	Always				
1463	F	Minimum flow function Off On	Off				
Buffer storage tank/primary controller							
1470	F	With buffer No Yes	Yes				
1472	F	With prim contr/system pump No Yes	Yes				
Speed-controlled pump							
1480	F	Pump speed reduction Operating level Characteristic	Characteristic				
1481	O	Starting speed	80	0	100	%	

Operating line	Op. level	Function	Default value	Min.	Max.	Unit	Green leaf
1482	F	Pump speed min	40	0	Line 1483	%	
1483	F	Pump speed max	100	Line 1482	100	%	
1485	O	Pump speed min OEM	40	0	Line 883	%	
1486	O	Pump speed max OEM	100	Line 882	100	%	
1488	O	Curve readj at 50% speed	33	0	100	%	
1490	O	Flow setp readj speed ctrl No Yes	No				
1482	F	Pump speed min	40	0	Line 1483	%	
1483	F	Pump speed max	100	Line 1482	100	%	
Remote control							
1500	F	Optg mode changeover None Protection Reduced Comfort Automatic	Protection				
Cooling circuit 3							
Operating mode							
1501	E	Operating mode Protection Automatic Reduced Comfort	Automatic				
1502	E	Comfort setpoint	24	OL 1205	OL 1203	°C	
1503	E	Reduced setpoint	26	OL 1202	OL 1204	°C	
1504	E	Protection setpoint	35	OL 1203	40	°C	
1505	F	Comfort setpoint min	5	5	OL 1202	°C	
Release							
1507	I	Release Time program HC Time program CC	Time program HC				
Cooling curve							
1508	I	Flow temp setp at OT 25°C	20	6	35	°C	
1509	I	Flow temp setp at OT 35°C	16	6	35	°C	
Eco functions							
1512	I	Cooling limit at OT	20	--- / 8	35	°C	
1513	F	Lock time at end of heating	24	--- / 8	100	h	
1514	F	24-hour cooling limit	3	--- / -10	10	°C	
1515	O	Ext'n 24-hour cooling limit No Yes	Yes				
Summer compensation							
1518	F	Summer comp start at OT	26	20	OL 1219	°C	
1519	F	Summer comp end at OT	35	OL 1218	50	°C	
1520	F	Summer comp setp increase	4	--- / 1	10	°C	
Flow temperature setpoint limitations							
1523	F	Flow temp setp min OT 25°C	18	6	35	°C	
1524	F	Flow temp setp min OT 35°C	18	6	35	°C	
Room influence							
1528	F	Room influence	80	--- / 1	100	%	
1529	O	Prop band Xp room contr	1.5	0.5	32	°C	
1530	O	Int act time Tn room contr	5400	10	24000	s	
1531	O	Der act time Tv room contr	10	10	2400	s	
Room temperature limitation							
1532	F	Room temp limitation	0.5	--- / 0	4	°C	
Optimizations							
1535	F	Quick increase Off To Reduced setpoint To Protection setpoint	To Reduced setpoint				
Frost protection							
1537	F	Frost prot plant CC pump	Off				

Operating line	Op. level	Function	Default value	Min.	Max.	Unit	Green leaf
		Off On					
Mixing control							
1538	F	Mixing valve decrease	0	0	20	°C	
1539	F	Actuator type 2-position 3-position	3-position				
1540	F	Switching differential 2-pos	2	0	20	°C	
1541	F	Actuator running time	120	30	650	s	
1542	O	Mixing valve Xp	12	1	100	°C	
1543	O	Mixing valve Tn	90	10	650	s	
1545	F	Mixing valve in heating mode Control Open	Open				
Dewpoint monitoring							
1546	F	Lock time dewpoint monitor	60	- - - / 10	600	min	
1547	F	Flow temp setp incr hygro	10	- - - / 1	20	°C	
1548	I	Flow setp incr start at r.h.	60	0	100	%	
1550	I	Flow temp diff dewpoint	2	- - - / 0	5	°C	
Buffer storage tank/precontroller							
1562	F	With buffer No Yes	No				
1563	F	With prim contr/system pump No Yes	No				
Remote control							
1569	F	Optg mode changeover None Protection Reduced Comfort Automatic	Protection				
Ventilation 3							
Operating mode							
1570	E	Operating mode Off Automatic Stage 1 Stage 2 Stage 3	Automatic				
Air quality							
1574	F	Air quality Comfort	1000	0	OL 1575	ppm	
1575	F	Air quality Reduced	1600	OL 1574	2000	ppm	
ACS	O	P-band (Xp) indoor air quality	400	0	2000	ppm	
Boost ventilation							
1577	E	Boost ventilation ... Boost ventilation	...				
1578	F	Duration boost ventilation	30	0	240	min	
1579	F	Stage boost ventilation Off Stage 1 Stage 2 Stage 3	Stage 3				
Night cooling							
1581	I	Forward shift night cooling	0	0	1440	min	
1583	F	Stage night cooling Off Stage 1 Stage 2 Stage 3	Stage 1				
ACS	O	Min duration night cooling	30	0	720	min	
ACS	I	Outside temp limit night cooling	12	0	50	°C	
ACS	I	Min temp diff room/outside for night cooling	5	0	20	°C	
Room humidity limit							
1585	F	Room humidity limit	85	1	100	%	
1587	F	Stage room humidity limit Off Stage 1 Stage 2 Stage 3	Off				
ACS	O	Room humidity limitation, switching differential	5	0	20	%	
ACS	O	Room humidity limitation, on time	30	0	720	min	
ACS	O	Room humidity limitation, off time	60	0	720	min	

Operating line	Op. level	Function	Default value	Min.	Max.	Unit	Green leaf
Operating modes and stages							
1589	F	Stage Comfort Off Stage 1 Stage 2 Stage 3	Stage 2				
1591	F	Stage Reduced Off Stage 1 Stage 2 Stage 3	Stage 1				
1592	F	Stage protection Off Stage 1 Stage 2 Stage 3	Stage 1				
1595	I	Optg mode changeover None Off Stage 1 Stage 2 Stage 3	Off				
Ventilation switch							
1596	F	Duration ventilation switch	0	0	240	min	
1597	F	Stage ventilation switch Off Stage 1 Stage 2 Stage 3	Stage 1				
Holiday mode ventilation							
ACS	I	Holiday mode, switch-on time ventilation	10:00	00:00	23:50	hh:mm	
ACS	I	Holiday mode, on time ventilation	30	0	360	min	
Air cooling 3							
ACS	I	Operating mode Protection Automatic Reduced Comfort	Automatic				
ACS	I	Comfort setpoint	24	5	Red. SW	°C	
ACS	I	Reduced setpoint	26	Comf. SW	40	°C	
ACS	I	Start of summer compensation at outside temp	26	20	End SK	°C	
ACS	I	End of summer compensation at outside temp	35	Begin SK	35	°C	
ACS	I	Summer compensation, setpoint increase	4	1	10	°C	
ACS	I	Release 24h/day Time program heating circuit Time program 5 Time program ventilation	Time program heating circuit				
Domestic hot water							
1600	E	Operating mode Off On Eco	On				
1601	O	Optg mode selection Eco None DHW storage tank	None				
1610	E	Nominal setpoint	50	Line 1612	Line 1614	°C	
1612	F	Reduced setpoint	40	8	Line 1610	°C	
1614	O	Nominal setpoint max	65	Line 1610	80	°C	
1620	I	Release 24h/day All time programs HC/CC Time program 4/DHW Low-tariff T'prog 4/DHW or low-tariff	Time program 4/DHW				
1630	I	Charging priority Absolute Shifting None MC shifting, PC absolute	Absolute				
1631	O	Temp request selection Max limitation Max selection	Max limitation				
1640	F	Legionella function Off Periodically Fixed weekday	Off				
1641	F	Legionella funct periodically	3	1	7	Days	
1642	F	Legionella funct weekday Monday Tuesday Wednesday Thursday Friday Saturday Sunday	Monday				

Operating line	Op. level	Function	Default value	Min.	Max.	Unit	Green leaf
1644	F	Legionella funct time	- - -	- - - / 00:00	23:50	hh:mm	
1645	F	Legionella funct setpoint	65	55	95	°C	
1646	F	Legionella funct duration	30	- - - / 2	360	min	
1647	F	Legionella funct circ pump Off On	On				
1648	F	Legio funct circ temp diff	- - -	- - - / 0	20	°C	
1660	F	Circulating pump release Time program HC/CC 3 DHW release Time program 4/DHW Time program 5	Time program HC/CC 3				
1661	F	Circulating pump cycling Off On	On				
1663	F	Circulation setpoint	45	8	80	°C	
1680	F	Optg mode changeover None Off On Eco	Off				
Consumer circuit 1							
1854	F	Request opt energy Off On	Off				
1859	I	Flow temp setp cons request	30	8	120	°C	
1860	F	Frost prot plant VK pump Off On	On				
1874	O	DHW charging priority No Yes	Yes				
1875	F	Excess heat draw Off On	On				
1878	F	With buffer No Yes	Yes				
1880	F	With prim contr/system pump No Yes	Yes				
Consumer circuit 2							
1904	F	Request opt energy Off On	Off				
1909	I	Flow temp setp cons request	30	8	120	°C	
1910	F	Frost prot plant VK pump Off On	On				
1924	O	DHW charging priority No Yes	Yes				
1925	F	Excess heat draw Off On	On				
1928	F	With buffer No Yes	Yes				
1930	F	With prim contr/system pump No Yes	Yes				
Swimming pool circuit							
1952	F	Release source heating None 24h/day Time program 5	24h/day				
1954	F	Request opt energy Off On	Off				
1959	I	Flow temp setpoint	30	8	120	°C	
1960	F	Frost prot plant pool pump Off On	Off				
1973	F	Last priority to charge No Yes	No				
1974	O	DHW charging priority No Yes	Yes				
1975	F	Excess heat draw Off On	On				

Operating line	Op. level	Function	Default value	Min.	Max.	Unit	Green leaf
1978	F	With buffer No Yes	Yes				
1980	F	With prim contr/system pump No Yes	Yes				
Swimming pool							
2055	E	Setpoint solar heating	26	8	Line 2070	°C	
2056	E	Setpoint source heating	22	8	Line 2070	°C	
2057	F	Swi diff source heating	0.5	0.5	3	°C	
2065	F	Charging priority solar Priority 1 Priority 2 Priority 3	Priority 3				
2066	F	Charging prio photovoltaics None Priority 1 Priority 2 Priority 3	Priority 3				
2070	O	Swimming pool temp max	32	Line 2055	95	°C	
2080	F	With solar integration No Yes	Yes				
Primary contr/system pump							
2110	O	Flow temp setpoint min	8	8	Line 2111	°C	
2111	O	Flow temp setpoint max	80	Line 2110	95	°C	
2112	O	Flow temp setp cooling min	8	8	20	°C	
System pump							
2120	F	Frost prot plant syst pump Off On	On				
Control of mixing valve							
2130	O	Mixing valve boost	0	0	50	°C	
2131	O	Mixing valve decrease	0	0	20	°C	
2132	O	Actuator type 2-position 3-position	3-position				
2133	O	Switching differential 2-pos	2	0	20	°C	
2134	O	Actuator running time	120	30	650	s	
2135	O	Mixing valve Xp	24	1	100	°C	
2136	O	Mixing valve Tn	90	10	650	s	
Forced&Lock							
2145	O	DHW charging priority No Yes	Yes				
Plant hydraulics							
2150	I	Primary contr/system pump Before buffer After buffer	After buffer				
Primary contr/syst pump 2							
2160	F	Frost prot plant syst pump Off On	On				
Heat pump							
Condenser							
2776	I	Pump speed min with DHW	---	0	OL 2777	%	
2777	I	Pump speed max with DHW	---	OL 2776	100	%	
2778	I	Pump speed min cool mode	---	0	OL 2779	%	
2779	I	Pump speed max cool mode	---	OL 2778	100	%	
2785	O	Max condensation temp	65	8	100	°C	
2786	O	Max condensation temp SD	8	1	20	°C	
2787	O	Max condensation temp red	2	0	20	°C	
Condenser pump Q9							
2788	I	Modulation cond pump DHW --- None HP setpoint Compressor output Temp diff condenser	HP setpoint				

Operating line	Op. level	Function	Default value	Min.	Max.	Unit	Green leaf
2789	I	Condenser pump with DHW Off On	On				
2790	F	Modulation condenser pump None HP setpoint Compressor output Temp diff condenser	HP setpoint				🌿
ACS	O	Modulation condens pump DHW --- None Heat pump setpoint Compressor output Temp diff condensor	---				
ACS	O	Modulation condens pump cooling --- None Heat pump setpoint Compressor output Temp diff condensor	---				
2792	F	Pump speed min	40	0	Line 2793	%	
2793	F	Pump speed max	100	Line 2792	100	%	
2794	O	Speed Xp	24	1	100	°C	
2795	O	Speed Tn	40	1	650	s	
2796	O	Speed Tv	0	0	60	s	
2799	O	Pump setpoint reduction	3	0	20	°C	
2800	F	Frost prot plant cond pump Off On	Off				
2801	I	Control cond pump Automatically Temp request Parallel compr operation	Automatically				
2802	I	Prerun time cond pump	5	0	600	s	
2803	I	Overrun time cond pump	5	0	600	s	
Condenser							
2804	O	Max temp diff condenser	15	--- / line 2805	30	°C	
2805	F	Req temp diff condenser	7	--- / 1	Line 2804	°C	
ACS	O	Req temp diff condens DHW	---	--- / 1	15	°C	
2806	O	Max dev temp diff cond	---	--- / 1	10	°C	
2807	O	Min temp diff cond DHW	---	--- / 1	10	°C	
2808	F	Req temp diff condens DHW	---	--- / 1	15	°C	
2809	O	Temp frost alarm	---	--- / 0	10	°C	
2810	O	Condenser frost protection	5	--- / -15	8	°C	
2811	O	Overrun cond frost protect	300	0	600	s	
Evaporator							
2812	O	Operation limit OT min air	---	--- / -50	20	°C	
2813	O	Operation limit OT max air	---	--- / 0	50	°C	
2814	O	Source temp max	---	--- / 10	60	°C	
2815	F	Source temp min water	3	--- / -20	30	°C	
2816	F	Source temp min brine	-5	--- / -30	50	°C	
2817	F	Switching diff source prot	3	1	10	°C	
ACS	O	Source protection with substitute sensor	0	0	1	-	
2818	F	Incr source temp min fl cur	2	0	10	°C	
ACS	O	Increase source temp min	1	0	10	°C	
2819	I	Prerun time source	15	0	240	s	
2820	I	Overrun time source	5	0	240	s	
2821	F	Source startup time max	5	1	10	min	
2822	F	T'limit source temp min brine	4	1	24	h	
2823	O	Req temp diff evaporator	3.5	1	20	°C	
ACS	O	Required temp diff evaporator cooling mode	---	--- / 1	20	°C	
2824	O	Max dev temp diff evap	---	--- / 1	10	°C	
2825	O	Min evaporation temp	---	--- / -50	50	°C	

Operating line	Op. level	Function	Default value	Min.	Max.	Unit	Green leaf
ACS	O	Min evaporation temp switching diff	8	0	30	°C	
ACS	O	Min evaporation temp cooling mode	---	--- / -50	50	°C	
ACS	O	Min evaporation temp increase	3	0	20	°C	
2828	O	Min evaporation temp water	-2	--- / -50	50	°C	
2826	O	Max evaporation temp	---	--- / 0	50	°C	
ACS	O	Max evaporation temp delay	5	0	120	s	
ACS	O	Max evaporation temp cooling mode	---	--- / -50	50	°C	
ACS	O	Max evaporation temp reduction	2	0	20	°C	
2827	F	Time limit source temp	15	1	360	min	
2829	O	Ext range min evap temp	---	--- / -0.5	-20	°C	
2830	O	Max dur ext min evap temp	2000	10	10000	h	
Compressor							
2832	O	Setpoint crankcase heater	10	--- / -30	50	°C	
2835	O	Restart lock compressor	10	10	1800	s	
2836	O	Start swi-off temp red	2	-30	20	°C	
2837	O	Swi-off temp max reduced	---	--- / 8	100	°C	
2838	O	Settl'time process reversal	45	0	300	s	
2839	F	Settl'time ch'over DHW/HC	120	--- / 15	600	s	
2840	I	Switching diff return temp	4	1	20	°C	
2841	F	Keep compr run time min No Yes	No				
2842	I	Compressor run time min	20	0	120	min	
2843	I	Compressor off time min	20	0	120	min	
2844	F	Switch-off temp max	55	8	100	°C	
2845	F	Red switch-off temp max	2	-20	20	°C	
2846	O	Hot-gas temp max	125	20	180	°C	
2847	O	Swi diff hot-gas temp max	10	1	40	°C	
2848	O	Reduction hot-gas temp max	10	0	20	°C	
2849	O	Setpoint hot-gas temp	100	20	180	°C	
2850	O	SD setp hot-gas temp	5	1	40	°C	
2851	O	Cont'type setp hot-gas temp NC NO	NO				
2852	F	LP delay on startup	5	0	120	s	
2853	O	LP delay during operation	2	0	120	s	
2854	O	LP supervision Always Without defrosting	Without defrosting				
ACS	O	Supervision soft starter Always With compr operation	Always				
ACS	O	Supervision low-pressure Always With compr operation	With compr operation				
ACS	O	Supervision high-pressure Always With compr operation	With compr operation				
ACS	O	Supervision overload compressor Always With compr operation	With compr operation				
ACS	O	Supervision 3-phase current/mains Always With compr operation	With compr operation				
ACS	O	Supervision overload source Always With source operation	With source operation				
ACS	O	Supervision pressure switch source Always With source operation According to heat source	According to heat source				
ACS	O	Supervision pressure switch source intermed circ Always With source operation	Always				

Operating line	Op. level	Function	Default value	Min.	Max.	Unit	Green leaf
ACS	O	Supervision external superheat controller Always With compr operation	Always				
ACS	O	Pressure diff min process reversal	---	--- / 0.1	5	bar	
ACS	O	Min compr run time prior to process reversal	3	--- / 0	30	s	
ACS	O	Delay pressure diff error process reversal	30	5	120	s	
ACS	O	Basic position process reversing valve Last request Heating Cooling None	Last request				
ACS	O	Compressor modulation on process reversal	---	--- / 0	100	%	
2855	I	Switch-off temp max HC	---	--- / 8	100	°C	
Compressor 2							
2860	F	Lock stage 2 with DHW Off On	Off				
2861	F	Release stage 2 below OT	5	--- / -30	30	°C	
Compressor modulation							
2862	O	Locking time stage2/mod	10	0	40	min	
2863	O	Release integral stage2/mod	250	0	500	°C*min	
2864	O	Reset integral stage2/mod	10	0	500	°C*min	
2865	F	Compr sequence changeover	100	--- / 10	1000	h	
Output data							
2867	O	Output optimum	---	--- / 1	100	%	
2868	O	Output nominal	20	0	1000	kW	
2869	O	Output basic stage	5	0	1000	kW	
ACS	O	Source temp 1 for COP	-7	-25	35	°C	
ACS	O	Source temp 2 for COP	7	-25	35	°C	
ACS	O	Flow temp 1 for COP	35	25	65	°C	
ACS	O	Flow temp 2 for COP	55	25	65	°C	
ACS	O	COP at source temp 1 and flow temp 1	---	--- / 1	10	-	
ACS	O	COP at source temp 1 and flow temp 2	---	--- / 1	10	-	
ACS	O	COP at source temp 2 and flow temp 1	---	--- / 1	10	-	
ACS	O	COP at source temp 2 and flow temp 2	---	--- / 1	10	-	
ACS	O	El compr. power at source temp 1 and flow temp 1	100	0	600		
ACS	O	El compr. power at source temp 1 and flow temp 2	110	0	600		
ACS	O	El compr. power at source temp 2 and flow temp 1	72	0	600		
ACS	O	El compr. power at source temp 2 and flow temp 2	80	0	600		
ACS	O	OT limit compressor power	-7	-25	35	°C	
ACS	O	Minimum compressor power below OT limit	33	0	100	%	
ACS	O	Minimum compressor power over OT limit	16	0	100	%	
Compressor modulation							
2870	O	Compressor modulation max	100	Line 2871	100	%	
2871	O	Compressor modulation min	15	0	Line 2870	%	
2873	O	Compressor mod run time	60	0	600	s	
2874	O	Compressor mod Xp	32	1	200	°C	
2875	O	Compressor mod Tn	120	1	650	s	
2878	O	PWM period digital scroll	---	--- / 5	30	s	
2879	O	Compr mod run time closing	---	--- / 0	600	s	
ACS	O	Compressor kick release	---	--- / 0	100	%	
ACS	O	Compressor kick modulation	60	0	100	%	
ACS	O	Compressor kick interval	30	10	600	min	
ACS	O	Compressor kick duration	20	10	120	s	

Operating line	Op. level	Function	Default value	Min.	Max.	Unit	Green leaf
Electric immersion heaters in the flow							
2880	I	Use electric flow Substitute Complem operation HC Complem operation DHW Complem operation HC+DHW End DHW charging Emergency operation Legionella function	Complem operation HC				
2881	I	Locking time electric flow	30	0	255	min	
2882	I	Release integr electric flow	250	0	500	°C*min	
2883	I	Reset integr electric flow	10	0	500	°C*min	
2884	I	Release el flow below OT	---	--- / -30	30	°C	
2885	O	Electric on below flow temp	---	--- / 5	20	°C	
General parameters							
2886	F	Compensation heat deficit Off On Only with floor curing fct	On				
2889	O	Duration error repetition	24	1	40	h	
2893	F	Number DHW charg attempts	1	--- / 1	10	-	
2894	F	Delay mains fault	3	1	40	s	
2895	F	Delay flow switch	0	0	10	s	
2896	O	Flow switch source active Always Heating mode only	Always				
2898	I	Min flow switch source	---	1	12000	l/h	
2899	I	Min flow switch consumers	---	1	12000	l/h	
2900	O	Refrigerant None R134A R236FA R290 R404A R407A R407B R407C R410A R410B R413A R417A R422A R422D R427A R507A R600 R600A R744 R1270 R32 R448A R449A R450A R1234yf R12354ze R452B R454B R454C R455A R513A	None				
2903	I	Release strategy COP Energy price COP and energy price COP or energy price	COP				
2904	I	Release of COP	---	--- / 1	10	-	
2908	F	OT limit with DHW charging Ignore Note	Note				
2909	F	Release below outside temp	---	--- / -50	50	°C	
2910	F	Release above outside temp	---	--- / -30	30	°C	
2911	F	For forced buffer charging Locked Released	Released				
2912	F	Full charging buffer Off On	On				
2922	O	Condenser overtemp prot Off Cooling down Switch-on lock + cool down	Cooling down				
2923	O	Condens prot buffer sensor None With B4 With B41 With B42	With B4				
External process reversal							
2941	F	Use of diverting valve Y28 Passive cooling Active and passive cooling	Passive cooling				
Defrosting							
2951	I	Defrost release below OT	7	5	20	°C	
2952	O	Swi diff defrost	3.5	0	15	°C	
2953	O	Temp diff defrost max	20	5	50	°C	
2954	O	Evapor temp defrost end	15	2	40	°C	
2955	O	Compressor during defrost Off On	On				
2956	O	dT cooling down end evapor	0	-10	10	°C	



Operating line	Op. level	Function	Default value	Min.	Max.	Unit	Green leaf
2958	I	Max num defrost repetitions	3	0	10	-	
2959	O	Defrost settling time	9	1	20	min	
2960	O	Duration dT start defrost	---	--- / 5	300	s	
2962	I	Duration defrost lock	30	0	100	min	
2963	I	Time up to forced defrost	120	--- / 60	600	min	
2964	I	Defrost time max	10	1	42	min	
2965	I	Dripping time evapor	2	0	10	min	
2966	O	Cooling down time evapor	5	--- / 0	240	s	
2967	O	Temp thresh drip tray heat	2	-5	10	°C	
2968	O	Max compr output defrost	100	1	100	%	
ACS	O	Position expansion valve when defrost	---	--- / 0	100	%	
2969	F	Defrost with DHW charging Automatically DHW Heating circuit HC, defrost delayed	Automatically				
2970	O	Switch-off temp min	8	1	40	°C	
2971	O	Defrost fan above	4	1	Line 2951	°C	
2972	O	Defrost time fan min	2	1	Line 2973	min	
2973	O	Defrost time fan max	10	Line 2972	42	min	
2974	O	dT end defrost fan	1	0.5 / ---	10	°C	
2975	O	Speed Q9 by defrost	---	0	100	%	
ACS	O	Defrost with fan above outside temp at 100% r.h.	2	1	Line 2971	°C	
ACS	F	Defrost with electrical utility lock No Yes	Yes				
ACS	O	Delay forced defrost after power up	60	0	240	s	
Cooling							
3000	I	Switch-off temp max cooling	40	20 / ---	60	°C	
3002	F	Source temp min cool mode	2	-20 / ---	30	°C	
3004	F	SD ch'over cooling pas/act	5	1	10	°C	
3007	F	In passive cooling mode Condenser pump off Condenser pump on	Condenser pump off				
3008	F	Temp diff cond cooling mode	5	0	20	°C	
Output control source							
3009	O	Modulation fan/source pump None Compressor output Temp diff evaporator	Temp diff evaporator				
ACS	O	Modulation fan/source pump cooling mode --- None Refrig temp liquid Compressor output Temp diff evaporator	---				
3010	O	Speed max fan/source pump	100	Line 3011	100	%	
3011	O	Speed min fan/source pump	30	0	Line 3010	%	
3012	O	Source off below temp B83	---	--- / 10	Line 3015	°C	
3014	O	Switching diff source off	5	1	10	°C	
3015	O	Start speed control B83	30	Line 3012	Line 3016	°C	
3016	O	End speed control B83	50	Line 3015	60	°C	
3017	O	Locking time speed control	---	--- / 0	250	s	
3019	O	Start speed fan/sce pump	---	--- / 0	100	%	
3021	O	Speed fan/source pump Xp	24	1	100	°C	
3022	O	Speed fan/source pump Tn	40	1	650	s	
3023	O	Speed fan/source pump Tv	0	0	60	s	
ACS	O	Max deviation suction gas temp	1	--- / 0.5	10	°C	
ACS	O	Outp limit with mod source Off Heating mode Cooling mode Heating and cooling mode	Off				
3025	I	Silent mode speed max	---	--- / 0	100	%	



Operating line	Op. level	Function	Default value	Min.	Max.	Unit	Green leaf	
3026	I	Silent mode on	22:00	00:00	23:50	hh:mm		
3027	I	Silent mode off	06:00	00:00	23:50	hh:mm		
3028	F	Silent mode speed incr start	---	--- / -50	50	°C		
3029	F	Silent mode speed incr end	-10	-50	50	°C		
Sensor calibration								
3030	I	Auto readj HP cond sensor Off Now After pump prerun	Off					
3031	I	Readj HP flow sensor	0	-20	20	°C		
3032	I	Readj HP return sensor	0	-20	20	°C		
3033	I	Readj status Not readjusted Manually readjusted Automatically readjusted Readjustment running	Not readjusted					
3035	F	Readj source inlet sensor	0	-20	20	°C		
3036	F	Readj source outlet sens	0	-20	20	°C		
3038	F	Readj source int circ flow	0	-20	20	°C		
3039	F	Readj source int circ return	0	-20	20	°C		
Superheat controller								
3042	O	Superheat setpoint	8	0 / ---	15	°C		
3043	O	Superheat controller Xp	10	1	200	°C		
3044	O	Superheat controller Tn	30	4	650	s		
3045	O	Superheat controller Tv	0	0	60	s		
3046	O	Expansion valve run time	5	1	1000	s		
3047	O	Min superheat	3	--- / 0.5	5	°C		
3049	O	Superheat setp cooling mode	8	--- / 0	25	°C		
3050	O	Superheat incr silent mode	0	0	10	°C		
ACS	O	SHC setp source 20	8	0 / ---	25	°C		
ACS	O	SHC setp source 15	8	0 / ---	25	°C		
ACS	O	SHC setp source 7	8	0 / ---	25	°C		
ACS	O	SHC setp source 2	8	0 / ---	25	°C		
ACS	O	SHC setp source -7	8	0 / ---	25	°C		
ACS	O	SHC setp source -15	8	0 / ---	25	°C		
ACS	O	SHC setp source -25	8	0 / ---	25	°C		
3051	O	Delay compressor start	0	0	120	s		
3052	O	Pos expansion valve start	0	0	100	%		
3053	O	Delay superheat controller	0	0	240	s		
3054	O	Superheat setp adaption Off Heating mode Cooling mode Heating and cooling mode	Off					
ACS	O	Adaption lock upon compressor start	10	0	30	min		
ACS	O	Adaption lock upon change of superheat setp	90	0	600	s		
ACS	O	Wait time up to red superheat setp adapt	210	0	600	s		
ACS	O	Adaption lock upon increase of superheat setp	10	0	30	min		
ACS	O	Min deviation superheat setp adapt	0.39	0.1	5	°C		
ACS	O	Max deviation superheat setp adapt	0.80	0.1	5	°C		
ACS	O	Critical deviation superheat setp adapt	1.2	0.1	5	°C		
ACS	O	Adaption step superheat setp	0.2	0.1	5	°C		
ACS	O	Max increase superheat setpoint adapt	0	0	10	°C		
ACS	O	Output limitation with SHC Off Heating mode Cooling mode Heating and cooling mode	Off					
3056	O	Output control with SHC Off Heating mode Cooling mode Heating and cooling mode	Off					
ACS	O	Output control with SHC Xp	20	1	200	°C		





Operating line	Op. level	Function	Default value	Min.	Max.	Unit	Green leaf
ACS	O	Output control with SHC Tn	60	1	650	s	
ACS	O	Max deviation superheat	2	--- / 0.5	10	°C	
ACS	O	Delay expansion valve evaporator error	20	--- / 0	255	s	
3058	O	Pump off function Off Automatic	Off				
3059	O	Pump off funct press limit	---	--- / 0	100	bar	
Vapor injection (EVI)							
3062	O	Superheat setpoint EVI	6	1	15	°C	
3063	O	EVI controller Xp	10	1	200	°C	
3064	O	EVI controller Tn	30	4	650	s	
3065	O	EVI controller Tv	0	0	60	s	
3066	O	Expansion valve EVI run time	5	1	1000	s	
3071	O	Threshold hot-gas temp EVI	---	--- / 20	180	°C	
3072	O	SD hot-gas temp EVI	10	1	20	°C	
3073	O	Threshold source temp EVI	---	--- / -50	50	°C	
3074	O	SD source temp EVI	5	1	20	°C	
3077	O	Swi-off temp sat vapor op	---	--- / 8	100	°C	
3078	O	Thresh hot-gas temp satur	---	--- / 20	180	°C	
3080	O	Thresh source temp satur	---	--- / -50	50	°C	
Energy meter							
Heat delivered							
3090	I	Pulse count heat None With input H1 With input H21 module 1 With input H21 module 2 With input H21 module 3 With input H22 module 1 With input H22 module 2 With input H22 module 3 With input H3	None				
3092	I	Pulse unit heat None kWh Liter	None				
3093	I	Pulse value heat numer	1	1	1000	-	
3094	I	Pulse value heat denom	1	1	1000		
3095	I	Flow measurement heat None With input H1 With input H2 module 1 With input H2 module 2 With input H2 module 3 With input H21 module 1 With input H21 module 2 With input H21 module 3 With input H22 module 1 With input H22 module 2 With input H22 module 3 With input H3	None				
3097	F	Flow heating	---	10	60000	l/h	
3098	F	Flow DHW	---	10	60000	l/h	
Energy input (electricity/gas)							
3100	F	Pulse count energy Ditto 3090	None				
3102	I	Pulse unit energy None kWh m3	None				
3103	I	Pulse value energy numer	1	1	1000		
3104	I	Pulse value energy denom	1	1	1000		
3106	F	Mean gas energy content	11.5	1	100	kWh/m3	
3108	I	Electrical source output	---	--- / 0.01	10	kW	
3109	I	Int count el imm heater flow None Heat delivered Energy brought in Both	None				
Energy meter/performance factor							
3110	F	Heat delivered	-	0	9999999	kWh	
3112	F	Heat drawn by source	-	0	3500000	kWh	
3113	F	Energy brought in	-	0	3500000	kWh	

Operating line	Op. level	Function	Default value	Min.	Max.	Unit	Green leaf
3116	F	Performance factor	-	0	10		
		Due day					
3119	I	Fixed day yearly perf fact	30.6.	1.01	31.12	DD.MM	
		Fixed day storage					
3120	E	Yearly perf factor 1	-	0	10		
3120	E	Fixed day 1	-	1.9.2004	31.12.2099	DD.MM. YYYY	
3121	E	Heat delivered heating 1	-	0	9999999	kWh	
3122	E	Heat delivered DHW 1	-	0	9999999	kWh	
3123	E	Cooling energy delivered 1	-	0	9999999	kWh	
3124	E	Energy brought in heating 1	-	0	3500000	kWh	
3125	E	Energy brought in DHW 1	-	0	3500000	kWh	
3126	E	Energy brought in cooling 1	-	0	3500000	kWh	
3127	E	Yearly perf factor 2	-	- - - / 0	10		
3127	E	Fixed day 2	-	1.9.2004	31.12.2099	DD.MM. YYYY	
3128	E	Heat delivered heating 2	-	0	9999999	kWh	
3129	E	Heat delivered DHW 2	-	0	9999999	kWh	
3130	E	Cooling energy delivered 2	-	0	9999999	kWh	
3131	E	Energy brought in heating 2	-	0	3500000	kWh	
3132	E	Energy brought in DHW 2	-	0	3500000	kWh	
3133	E	Energy brought in cooling 2	-	0	3500000	kWh	
3134	E	Yearly perf factor 3	-	- - - / 0	10		
3134	E	Fixed day 3	-	1.9.2004	31.12.2099	DD.MM. YYYY	
3135	E	Heat delivered heating 3	-	0	9999999	kWh	
3136	E	Heat delivered DHW 3	-	0	9999999	kWh	
3137	E	Cooling energy delivered 3	-	0	9999999	kWh	
3138	E	Energy brought in heating 3	-	0	3500000	kWh	
3139	E	Energy brought in DHW 3	-	0	3500000	kWh	
3140	E	Energy brought in cooling 3	-	0	3500000	kWh	
3141	E	Yearly perf factor 4	-	- - - / 0	10		
3141	E	Fixed day 4	-	1.9.2004	31.12.2099	DD.MM. YYYY	
3142	E	Heat delivered heating 4	-	0	9999999	kWh	
3143	E	Heat delivered DHW 4	-	0	9999999	kWh	
3144	E	Cooling energy delivered 4	-	0	9999999	kWh	
3145	E	Energy brought in heating 4	-	0	3500000	kWh	
3146	E	Energy brought in DHW 4	-	0	3500000	kWh	
3147	E	Energy brought in cooling 4	-	0	3500000	kWh	
3148	E	Yearly perf factor 5	-	- - - / 0	10		
3148	E	Fixed day 5	-	1.9.2004	31.12.2099	DD.MM. YYYY	
3149	E	Heat delivered heating 5	-	0	9999999	kWh	
3150	E	Heat delivered DHW 5	-	0	9999999	kWh	
3151	E	Cooling energy delivered 5	-	0	9999999	kWh	
3152	E	Energy brought in heating 5	-	0	3500000	kWh	
3153	E	Energy brought in DHW 5	-	0	3500000	kWh	
3154	E	Energy brought in cooling 5	-	0	3500000	kWh	









Operating line	Op. level	Function	Default value	Min.	Max.	Unit	Green leaf
3155	E	Yearly perf factor 6	-	- - - / 0	10		
3155	E	Fixed day 6	-	1.9.2004	31.12.2099	DD.MM. YYYY	
3156	E	Heat delivered heating 6	-	0	9999999	kWh	
3157	E	Heat delivered DHW 6	-	0	9999999	kWh	
3158	E	Cooling energy delivered 6	-	0	9999999	kWh	
3159	E	Energy brought in heating 6	-	0	3500000	kWh	
3160	E	Energy brought in DHW 6	-	0	3500000	kWh	
3161	E	Energy brought in cooling 6	-	0	3500000	kWh	
3162	E	Yearly perf factor 7	-	- - - / 0	10		
3162	E	Fixed day 7	-	1.9.2004	31.12.2099	DD.MM. YYYY	
3163	E	Heat delivered heating 7	-	0	9999999	kWh	
3164	E	Heat delivered DHW 7	-	0	9999999	kWh	
3165	E	Cooling energy delivered 7	-	0	9999999	kWh	
3166	E	Energy brought in heating 7	-	0	3500000	kWh	
3167	E	Energy brought in DHW 7	-	0	3500000	kWh	
3168	E	Energy brought in cooling 7	-	0	3500000	kWh	
3169	E	Yearly perf factor 8	-	- - - / 0	10		
3169	E	Fixed day 8	-	1.9.2004	31.12.2099	DD.MM. YYYY	
3170	E	Heat delivered heating 8	-	0	9999999	kWh	
3171	E	Heat delivered DHW 8	-	0	9999999	kWh	
3172	E	Cooling energy delivered 8	-	0	9999999	kWh	
3173	E	Energy brought in heating 8	-	0	3500000	kWh	
3174	E	Energy brought in DHW 8	-	0	3500000	kWh	
3175	E	Energy brought in cooling 8	-	0	3500000	kWh	
3176	E	Yearly perf factor 9	-	- - - / 0	10		
3176	E	Fixed day 9	-	1.9.2004	31.12.2099	DD.MM. YYYY	
3177	E	Heat delivered heating 9	-	0	9999999	kWh	
3178	E	Heat delivered DHW 9	-	0	9999999	kWh	
3179	E	Cooling energy delivered 9	-	0	9999999	kWh	
3180	E	Energy brought in heating 9	-	0	3500000	kWh	
3181	E	Energy brought in DHW 9	-	0	3500000	kWh	
3182	E	Energy brought in cooling 9	-	0	3500000	kWh	
3183	E	Yearly perf factor 10	-	- - - / 0	10		
3183	E	Fixed day 10	-	1.9.2004	31.12.2099	DD.MM. YYYY	
3184	E	Heat delivered heating 10	-	0	9999999	kWh	
3185	E	Heat delivered DHW 10	-	0	9999999	kWh	
3186	E	Cooling energy delivered 10	-	0	9999999	kWh	
3187	E	Energy brought in heat 10	-	0	3500000	kWh	
3188	E	Energy brought in DHW 10	-	0	3500000	kWh	
3189	E	Energy brought in cooling 10	-	0	3500000	kWh	
3190	F	Reset fixed day storage No Yes	No				
Extended energy metering							
3192	I	Int count el imm heater DHW None Heat delivered Energy brought in Both	None				





Operating line	Op. level	Function	Default value	Min.	Max.	Unit	Green leaf
3193	I	Int count el imm heat buffer None Heat delivered Energy brought in Both	None				
3195	I	Electric pump power heating	---	--- / 0.01	10	kW	
3196	I	Electric pump power DHW	---	--- / 0.01	10	kW	
3197	F	Electric power compressor	1	0.1	60	kW	
Heat input (source)							
3250	I	Pulse count source None With input H1 With input H21 module 1 With input H21 module 2 With input H21 module 3 With input H22 module 1 With input H22 module 2 With input H22 module 3 With input H3	None				
3252	I	Pulse unit source None kWh Liter	None				
3253	I	Pulse value source numer	1	1	1000		
3254	I	Pulse value source denom	1	1	1000		
3255	I	Flow measurement source None With input H1 With input H2 module 1 With input H2 module 2 With input H2 module 3 With input H21 module 1 With input H21 module 2 With input H21 module 3 With input H22 module 1 With input H22 module 2 With input H22 module 3 With input H3	None				
3257	I	Flow source	---	--- / 10	60000	l/h	
3260	I	Antifreeze source None Ethylene glycol Propylene glycol Ethyl and propyl glycol	None				
3261	I	Antifreeze concentr source	30	1	100	%	
Energy prices							
3264	I	E'gy price high-tariff	---	--- / 1	1000	-	
3265	I	E'gy price low/sm grid wish	---	--- / 1	1000	-	
3266	I	E'gy price sm grid imposed	---	--- / 1	1000	-	
3267	I	E'gy price altern source	---	--- / 1	1000	-	
Cascade							
3510	O	Lead strategy Late on, early off Late on, late off Early on, late off According to buffer temp	Late on, late off				
3511	O	Output band min	0	0	Line 3512	%	
3512	O	Output band max	100	Line 3511	100	%	
3514	F	Stage sequence Serial, release all 2nd stage Serial, release last stage Parallel, release last stage	Serial, release last stage				
3516	O	Max sources forced charg	4	1	16		
3517	O	Max source force charg OT	---	-- / -20	15	°C	
3518	F	Numb source defrost allowed	50	1	100	%	
3522	F	Rel integr source seq cool	20	1	200	°C*min	
3523	F	Res integr source seq cool	10	1	200	°C*min	
3525	F	Switch-on delay cooling	5	0	20	min	
3530	F	Release integral source seq	100	0	500	°C*min	
3531	F	Reset integral source seq	20	0	500	°C*min	
3533	F	Switch on delay	5	0	120	min	
3538	F	Substitute common flow temp None Highest source value Internal source value Mean source value	Highest source value				
3540	F	Auto source seq ch'over	500	--- / 10	990	h	
3541	F	Auto source seq exclusion	None				

Operating line	Op. level	Function	Default value	Min.	Max.	Unit	Green leaf
		None First Last First and last					
3542	F	Source seq cooling mirrored No Yes	Yes				
3543	O	Source seq with opt energy No Yes	Yes				
3544	F	Leading source Source 1...16	Source 1				
3590	O	Temp differential min	---	--- / 0	20	°C	
ACS	O	Neutral zone heating cascade	4	1	10	°C	
ACS	O	Neutral zone cooling cascade	2	1	20	°C	
Supplementary source							
Operating mode							
ACS	F	Use of supplementary source Supplementary Hybrid	Supplementary				
3690	F	Setpoint incr main source	5	0	60	°C	
3691	F	Ouput limit main source	---	--- / 1	100	%	
ACS	O	Switching differential ouput limit main source	10	--- / 1	100	%	
3692	F	With DHW charging Locked Substitute Complement Instantly First Alone	Complement		-		
3694	F	OT limit with DHW charging Ignore Note	Note				
3695	O	Release with DHW charging According to release With load only With load or heating	According to release				
3696	O	Lock with DHW charging With end of charging No heating and B3 hot Sensor B3 hot	With end of charging				
3697	O	With DHW push Off On	Off				
3698	O	With warmer/cooler function Off On	Off				
3700	F	Release below outside temp	---	--- / -50	50	°C	
3701	F	Release above outside temp	---	--- / -50	50	°C	
3704	F	With heat generation lock Off On DHW On	Off				
3705	F	Overrun time	5	0	120	min	
Setpoints							
3710	F	Setpoint min	---	--- / 0	80	°C	
3711	F	Setpoint max	80	0	140	°C	
3712	F	Setpoint chimney sweep	50	0	80	°C	
Control							
3718	F	Release integral	20	--- / 1	500		
3719	F	Reset integral	10	--- / 1	500		
3720	F	Switching integral	50	--- / 0	500	°C*min	
ACS	O	Neutral zone switching integral	1	0	20		
3722	F	Switching diff off	15	0	20	°C	
3723	F	Locking time	30	--- / 0	120	min	
3725	F	Control sensor Common flow temp Buffer sensor B4	Common flow temp				
ACS	O	Flow temperature hybrid source Max value flow temp HP/boiler temp Mean value flow temp HP/boiler temp Flow temp heat pump Boiler temp	Max value flow temp HP/boiler temp				
ACS	O	Pump hybrid source Separately Boiler pump Q1 Condenser pump Q9	Separately				
Configuration							

Operating line	Op. level	Function	Default value	Min.	Max.	Unit	Green leaf	
3750	F	Source type Other Solid fuel boiler Heat pump Oil/gas boiler	Oil/gas boiler					
3755	F	Delay lockout position	1	--- / 1	40	min		
Solar								
3810	F	Temp diff on	8	Line 3811	40	°C		
3811	F	Temp diff off	4	0	Line 3810	°C		
3812	F	Charg temp min DHW st tank	20	--- / 8	95	°C		
3813	O	Temp diff on buffer	---	--- /line3814	40	°C		
3814	O	Temp diff off buffer	---	--- / 0	Line 3813	°C		
3815	F	Charging temp min buffer	20	--- / 8	95	°C		
3816	O	Temp diff on swi pool	---	--- /line3817	40	°C		
3817	O	Temp diff off swi pool	---	--- / 0	Line 3816	°C		
3818	F	Charging temp min swi pool	20	--- / 8	95	°C		
3822	F	Charging prio storage tank None DHW storage tank Buffer storage tank	DHW storage tank			-		
3825	F	Charging time relative prio	---	--- / 2	60	min		
3826	F	Waiting time relative prio	5	1	40	min		
3827	F	Waiting time parallel op	---	--- / 0	40	min		
3828	F	Delay secondary pump	60	0	600	s		
3830	F	Collector start function	---	--- / 5	60	min		
3831	F	Min run time collector pump	20	5	120	s		
3832	O	Collector start function on	07:00	00:00	23:50	hh:mm		
3833	O	Collector start function off	19:00	00:00	23:50	hh:mm		
3834	F	Collector start funct grad	---	--- / 1	20	min/°C		
3835	F	Min collector temp start fct	5	--- / 0	30	°C		
3840	F	Collector frost protection	---	--- / -20	5	°C		
3850	F	Collector overtemp prot	---	--- / 30	350	°C		
3860	F	Evaporation heat carrier	---	--- / 60	350	°C		
3862	F	Impact evaporation superv On own collector pump On both collector pumps	On own collector pump					
3870	F	Pump speed min	40	0	Line 3871	%		
3871	F	Pump speed max	100	Line 3870	100	%		
3872	O	Speed Xp	24	1	100	°C		
3873	O	Speed Tn	40	10	650	s		
3880	F	Antifreeze None Ethylene glycol Propylene glycol Ethyl and propyl glycol	None					
3881	F	Antifreeze concentration	30	1	100	%		
3884	F	Pump capacity	---	--- / 10	1500	l/h		
3886	F	Pulse count yield None With input H1 With input H21 module 1 With input H21 module 2 With input H21 module 3 With input H22 module 1 With input H22 module 2 With input H22 module 3 With input H3						
3887	F	Pulse unit yield None kWh Liters	None					
3888	F	Pulse value yield numer	10	1	1000	-		
3889	F	Pulse value yield denom	10	1	1000	-		
3891	F	Flow measurement yield None With input H1 With input H2 module 1 With input H2 module 2 With input H2 module 3 With input H21 module 1 With input H21 module 2 With input H21 module 3 With input H22 module 1 With input H22 module 2 With input H22 module 3 With input H3						
3896	F	Readj solar flow sensor	0	-20	20	°C		
3897	F	Readj solar return sensor	0	-20	20	°C		

Operating line	Op. level	Function	Default value	Min.	Max.	Unit	Green leaf
Solid fuel boiler							
4102	F	Locks other heat sources Off On	On				
4103	F	Charg prio DHW stor tank Off On	Off				
4110	F	Setpoint min	40	8	120	°C	
4114	F	Temp differential min	4	0	40	°C	
4130	F	Temp diff on	4	1	40	°C	
4134	F	Connection DHW stor tank None With B3 With B31 With B3 and B31	None				
4135	F	Boiler temp setp DHW charg Storage tank temp Storage tank setpoint Boiler temp setpoint min	Storage tank temp				
4136	F	DHW charging with Q3 No Yes	Yes				
4137	F	Connection buffer With B4 With B42/B41 With B4 and B42/B41	With B4				
4138	F	Boil temp setp buffer charg Storage tank temp Storage tank setpoint Boiler temp setpoint min	Storage tank temp				
4140	F	Pump overrun time	20	0	120	min	
4141	O	Excess heat discharge	90	60	140	°C	
4153	F	Return setpoint min	8	8	95	°C	
4158	F	Flow influence return ctrl Off On	Off				
4163	O	Actuator running time	120	30	650	s	
4164	O	Mixing valve Xp	24	1	100	°C	
4165	O	Mixing valve Tn	90	10	650	s	
4170	O	Frost prot plant boiler pump Off On	Off				
4190	F	Residual heat fct dur max	---	-- / 5	60	min	
4192	F	Residual heat fct trigg Once Several times	Once				
4201	F	Pump speed min	40	0	Line 4202	%	
4202	F	Pump speed max	100	Line 4201	100	%	
4203	O	Speed Xp	24	1	100	°C	
4204	O	Speed Tn	40	1	650	s	
Buffer storage tank							
Forced charging							
4705	O	Forced charging Off Demand Always	Demand				
4706	F	Charging prio photovoltaics None Priority 1 Priority 2 Priority 3	Priority 2				
4708	F	Forced charging setp cooling	---	-- / 6	35	°C	
4709	I	Forced charg setp heat min	40	20	Line 4710	°C	
4710	I	Forced charg setp heat max	50	Line 4709	80	°C	
4711	I	Forced charging time	---	--- / 00:00	23:50	hh:mm	
4712	I	Forced charg duration max	4	1	20	h	
Automatic generation locks							
4720	F	Auto generation lock None With B4 With B4 and B42/B41 With B42 With B42 and B41 With B4 and B71	With B4				
4721	O	Auto heat gen lock SD	2	0	20	°C	
4722	F	Temp diff buffer/HC	0	-20	20	°C	

Operating line	Op. level	Function	Default value	Min.	Max.	Unit	Green leaf
4723	O	Temp diff buffer/CC	0	-20	20	°C	
4724	F	Min st tank temp heat mode	---	--- / 8	95	°C	
4726	F	Max st tank temp cool mode	25	--- / 10	40	°C	
4728	F	Rel temp diff buffer/HC	0	-50	50	%	
4735	F	Setpoint reduction B42/B41	0	0	20	°C	
Stratification/discharging protection							
4739	F	Stratification protection Off Always	Off				
4740	O	Strat prot temp diff max	5	0	20	°C	
4743	O	Strat prot anticipation time	60	0	240	S	
4744	O	Strat protection Tn	120	10	200	s	
Solar charging/solid fuel boiler							
4749	F	Min charging setpoint solar	8	8	95	°C	
4750	F	Charging temp max	80	8	Line 4751	°C	
4751	O	Storage tank temp max	90	Line 4750	95	°C	
Recooling							
4755	F	Recooling temp	70	8	95	°C	
4756	F	Recooling DHW/HCs Off On	Off				
4757	F	Recooling collector Off Summer Always	Off				
Electric immersion heater							
4760	F	Charg sensor el imm heater With B4 With B42/B41	With B4				
4761	F	Forced charging electric No Yes Smart grid, draw forced	No				
4783	F	With solar integration No Yes	No				
Diversion of flow							
4830	O	Flow diversion temp	---	--- / 50	95	°C	
4831	O	Swi diff flow diversion	4	0	20	°C	
ACS	O	Delay flow diversion	30	0	60	s	
DHW storage tank							
Release							
5007	F	Charging request Setpoint With B3 With B31	Setpoint				
5008	F	Charging request timed	---	--- / 1	240	min	
ACS	O	Heating output reduction per degree	4	0	10	°C	
5010	O	Charging Once/day Several times/day	Several times/day				
5013	O	Charging opt energy Off Current setpoint Nominal setpoint	Off				
5016	O	Charging opt energy contact Off Nominal setpoint Legionella funct setpoint	Off				
5018	F	Charging prio photovoltaics None Priority 1 Priority 2 Priority 3	Priority 1				
Charging control							
5020	F	Flow setpoint boost	8	0	30	°C	
5021	F	Transfer boost	8	0	30	°C	
5022	F	Type of charging Recharging Full charging Full charging legio Full charg 1st time day Full charg 1st time legio	Full charging				
5023	F	Setpoint reduction B31	0	0	20	°C	

Operating line	Op. level	Function	Default value	Min.	Max.	Unit	Green leaf
5024	F	Switching diff	5	0	20	°C	
Charging limitation							
5030	F	Charging time limitation	240	--- / 10	600	min	
5031	F	Heating time limitation	---	--- / 10	600	min	
5032	F	Max charg abortion temp	---	--- / 8	80	°C	
5033	O	Dynamic switching diff Off On	Off				
Discharging protection							
5040	O	Discharging protection Off Always Automatically	Automatically				
5041	O	Discharging prot sensor With B3 With B31	With B31				
Overtemperature protection							
5050	F	Charging temp max	80	8	Line 5051	°C	
5051	O	Storage tank temp max	90	Line 5050	95	°C	
Recooling							
5055	F	Recooling temp	70	8	95	°C	
5056	F	Recooling heat gen/HCs Off On	Off				
5057	F	Recooling collector Off Summer Always	Off				
Electric immersion heater							
5060	F	EI imm heater optg mode Substitute Summer Always Cooling mode Emergency operation Legionella function	Substitute				
5061	F	EI immersion heater release 24h/day DHW release Time program 4/DHW	DHW release				
5062	F	EI immersion heater control External thermostat DHW sensor	DHW sensor				
5066	F	EI imm heater in legio funct According to operating mode Alone	According to operating mode				
DHW push							
5070	O	Automatic push Off On	Off				
5071	O	Charging prio time push	0	0	120	min	
Configuration							
5085	F	Excess heat draw Off On	On				
5090	F	With buffer No Yes	No				
5092	F	With prim contr/system pump No Yes	No				
5093	F	With solar integration No Yes	Yes				
Speed-controlled pumps							
5101	F	Pump speed min	40	0	Line 5102	%	
5102	F	Pump speed max	100	Line 5101	100	%	
5103	O	Speed Xp	24	1	100	°C	
5104	O	Speed Tn	40	10	650	s	
5105	O	Speed Tv	1	0	60	s	
5108	O	Starting speed charg pump	---	--- / 0	100	%	
5109	O	St speed interm circ pump	40	--- / 0	100	%	

Operating line	Op. level	Function	Default value	Min.	Max.	Unit	Green leaf
Precontrol of mixing valve							
5120	O	Mixing valve boost	0	0	50	°C	
5124	O	Actuator running time	120	30	650	s	
5125	O	Mixing valve Xp	24	1	100	°C	
5126	O	Mixing valve Tn	90	10	650	s	
Transfer of heat							
5130	F	Transfer strategy Off Always DHW release	Always				
5131	F	Comparison temp transfer With B3 With B31 With B3 and B31	With B3				
Stratification storage tank/intermediate circuit							
5140	F	Intermediate circuit boost	2	0	10	°C	
5142	O	Flow setp compensation delay	---	--- / 0	60	s	
5143	O	Flow setp compensation Xp	24	1	100	°C	
5144	O	Flow setp compensation Tn	120	1	650	s	
5145	O	Flow setp compensation Tv	0	0	60	s	
5146	F	Full charging with B36 No Yes	No				
5147	O	Min overrun time Q33	10	0	250	s	
5148	F	Min start temp diff Q33	0	--- / -20	20	°C	
5156	O	Int circuit actuator run time	120	30	650	s	
5157	O	Int circuit mixing valve Xp	24	1	100	°C	
5158	O	Int circuit mixing valve Tn	90	10	650	s	
5159	O	Use int circuit mixing valve Always Only hi-temp charging	Always				
Mixing pump							
5160	F	Legionella funct mixing pump Off With charging With charging and duration	With charging and duration				
5165	F	Restratification Off On	Off				
5166	F	Restrat temp min	8	8	95	°C	
5167	F	Restrat temp diff min	8	0	40	°C	
5169	F	Functions Q35 with Q33 No Yes	No				
High-temperature charging							
5170	F	Hi-temp charging Off Own source, heating mode Own source heat/cool mode All sources, heating mode	Off				
5171	F	Hi-temp charging setpoint	---	--- / 40	80	°C	
5172	O	Hi-temp min ch diff flow	5	--- / 0.5	20	°C	
5173	O	Hi-temp min ch diff hot-gas	10	--- / 0.5	20	°C	
ACS	O	DHW high-temp charging, duration start kick	---	--- / 0	120	s	
DHW heat pump							
5177	O	DHW HP off time min	20	0	120	min	
5178	O	DHW HP source temp min	4	0	20	°C	
5179	O	DHW HP source pump None Heat circuit pump HC1 Q2 Heat circuit pump HC2 Q6 Heat circuit pump HC3 Q20 Condenser pump Q9 Cooling circ pump CC1 Q24 Cooling circ pump CC2 Q28	None				

Operating line	Op. level	Function	Default value	Min.	Max.	Unit	Green leaf	
Instantaneous water heater								
5406	F	Min setp diff to tank temp	4	--- / 0	20	°C		
5407	F	Storage tank setpoint incr	6	0	20	°C		
5530	F	Pump speed min	0	0	Line 5531	%		
5531	O	Pump speed max	100	Line 5530	100	%		
5532	O	Speed Xp	16	1	100	°C		
5533	O	Speed Tn	8	4	650	s		
5534	O	Speed Tv	0	0	60	s		
5544	F	Actuator running time	15	7.5	480	s		
5545	O	Mixing valve Xp	20	1	200	°C		
5546	O	Mixing valve Tn	150	4	650	s		
5547	O	Mixing valve Tv	4.5	0	30	s		
General functions								
Delta-T-controller 1								
5570	F	Temp diff on dT contr 1	20	0	40	°C		
5571	F	Temp diff off dT contr 1	10	0	40	°C		
5572	F	On temp min dT contr 1	0	-30	120	°C		
5573	F	Sensor 1 dT controller 1 None Buffer sensor B4 Buffer sensor B41 Collector sensor B6 DHW sensor B31 DHW circulation sensor B39 Swimming pool sensor B13 Collector sensor 2 B61 Buffer sensor B42 Common flow sensor B10 Cascade return sensor B70 Special temp sensor 1 Special temp sensor 2 DHW sensor B3 HP flow sensor B21 HP return sensor B71 Outside sensor B9 Source inlet sensor B91 Source outl sens B92/B84 Room sensor B5 Room sensor B52 Room sensor B53 Flue gas temp sensor B8 Solid fuel boiler sensor B22 Solid fuel boil ret sens B72 Primary contr sensor B15						
5574	F	Sensor 2 dT controller 1 None Buffer sensor B4 Buffer sensor B41 Collector sensor B6 DHW sensor B31 DHW circulation sensor B39 Swimming pool sensor B13 Collector sensor 2 B61 Buffer sensor B42 Common flow sensor B10 Cascade return sensor B70 Special temp sensor 1 Special temp sensor 2 DHW sensor B3 HP flow sensor B21 HP return sensor B71 Outside sensor B9 Source inlet sensor B91 Source outl sens B92/B84 Room sensor B5 Room sensor B52 Room sensor B53 Flue gas temp sensor B8 Solid fuel boiler sensor B22 Solid fuel boil ret sens B72 Primary contr sensor B15						
5575	F	On time min dT contr 1	0	0	250	°C		
5577	F	Pump/valve kick K21 Off On	On					
5578	F	Off temp max dT contr 1	---	--- / -30	120	°C		
Delta-T-controller 2								
5580	F	Temp diff on dT contr 2	20	0	40	°C		
5581	F	Temp diff off dT contr 2	10	0	40	°C		
5582	F	On temp min dT contr 2	0	-30	120	°C		
5583	F	Sensor 1 dT controller 2 Ditto 5573						
5584	F	Sensor 2 dT controller 2 Ditto 5574						
5585	F	On time min dT contr 2	0	0	250	°C		
5587	F	Pump/valve kick K22 Off On	On					
5588	F	Off temp max dT contr 2	---	--- / -30	120	°C		
Outside air temperature control 1...3								
ACS	I	Outside air temp control Off Summer only Winter only Summer and Winter	Summer and Winter					
ACS	O	Outside air temp control below outside temp	5	-20	20	°C		
ACS	O	Outside air temp control, temp diff	-3	-20	20	°C		
ACS	O	Outside air temp control, on time min	30	0	255	min		
ACS	O	Outside air temp control, off time min	30	0	255	min		

Operating line	Op. level	Function	Default value	Min.	Max.	Unit	Green leaf
Dehumidifier							
5600	F	Air dehumidifier Off On	Off				
5602	F	Air dehumidifier r.h. on	55	0	100	%	
5603	F	Air dehumidifier r.h. SD	5	2	50	%	
5606	F	Release air dehumidifier 24h/day Time program HC Time program 5	24h/day				
5608	F	Acquisition rel air humidity None With input H1 With input H2 module 1 With input H2 module 2 With input H2 module 3 With input H21 module 1 With input H21 module 2 With input H21 module 3 With input H22 module 1 With input H22 module 2 With input H22 module 3 With input H3					
Configuration							
Presetting							
5700	I	Presetting	---	--- / 1	24		
ACS	I	Plant diagram selection validity Changed Unchanged	Changed				
Heating circuits/cooling circuit							
5710	I	Heating circuit 1 Off On	On				
5711	I	Cooling circuit 1 Off 4-pipe system cooling 2-pipe system cooling	Off				
5712	I	Use of mixing valve 1 None Heating Cooling Heating and cooling	Heating and cooling				
5715	I	Heating circuit 2 Off On	Off				
5716	I	Cooling circuit 2 Off 4-pipe system cooling 2-pipe system cooling	Off				
5717	I	Use of mixing valve 2 None Heating Cooling Heating and cooling	Heating and cooling				
5721	I	Heating circuit 3 Off On	Off				
5722	I	Cooling circuit 3 Off 4-pipe system cooling 2-pipe system cooling	Off				
5723	I	Use of mixing valve 3 None Heating Cooling Heating and cooling	Heating and cooling				
5728	F	DHW storage tank Off On	On				
DHW storage tank/instantaneous water heater							
5731	I	DHW ctrl elem Q3 No charging request Charging pump Diverting valve	Charging pump				
5734	F	Basic position DHW div valve Last request Heating circuit DHW	Heating circuit				
5736	I	DHW separate circuit Off On	Off				
5740	I	Output el imm heater K6	10	0.1	99	kW	
5742	F	Restart lock pump Q34 Off On	Off				
5743	F	Cooling during DHW charging Off On	Off				
Consumer circuits							
5750	I	Consumer circuit 1 Off Heating 4-pipe system cooling 2-pipe system cooling	Heating				
5751	I	Consumer circuit 2 Off Heating 4-pipe system cooling 2-pipe system cooling	Heating				



Operating line	Op. level	Function	Default value	Min.	Max.	Unit	Green leaf
Swimming pool							
5752	I	Swimming pool Off On	On				
Heat pump							
5800	I	Heat source Brine Water Air Externally brine Externally water Externally air	Brine				
5803	F	Device address ext source	---	--- / 1	16		
5804	O	Source prot sens brine HP Source inlet B91 Source outlet B92	Source inlet B91				
5805	O	Location el imm heater flow After flow sensor B21 Before flow sensor B21 Flow desuperheater	After flow sensor B21				
5806	O	Type el imm heater flow None 3-stage 2-stage excluding 2-stage complementary 1-stage	3-stage				
5807	I	Refrigeration Off Active and passive cooling Active cooling Passive cooling	Off				
5808	I	Cooling system 4-pipe system cooling 2-pipe system cooling	2-pipe system cooling				
5810	I	Differential HC at OT -10°C	7	0	20	°C	
5811	I	Output el imm heater K25	10	0.1	99	kW	
5813	I	Output el imm heater K26	20	0.1	99	kW	
5822	O	Press acquisition evap H82 None With input H1 With input H21 module 1 With input H21 module 2 With input H21 module 3 With input H22 module 1 With input H22 module 2 With input H22 module 3 With input H3	None				
5823	O	Press acquisition cond H83 None With input H1 With input H2 module 1 With input H2 module 2 With input H2 module 3 With input H21 module 1 With input H21 module 2 With input H21 module 3 With input H22 module 1 With input H22 module 2 With input H22 module 3 With input H3	None				
5826	O	Press acquisition EVI H86 Ditto 5822	None				
5827	I	Hum acquis air inlet H91 Ditto 5823	None				
Solar							
5840	I	Solar controlling element Charging pump Diverting valve	Charging pump				
5841	I	External solar exchanger Jointly DHW storage tank Buffer storage tank	Jointly				
Buffer storage tank							
5870	I	Combi storage tank No Yes	No				
5872	I	Output el imm heater K16	10	0.1	99	kW	

Operating line	Op. level	Function	Default value	Min.	Max.	Unit	Green leaf
QX/ZX basic unit							
5890	I	Relay output QX1 None ; Compressor 2 K2 ; Process revers valve Y22 ; Hot-gas temp K31 ; El imm heater 1 flow K25 ; El imm heater 2 flow K26 ; Div valve cool source Y28 ; System pump Q14 ; Cascade pump Q25 ; Heat gen shutoff valve Y4 ; El imm heater DHW K6 ; Circulating pump Q4 ; St tank transfer pump Q11 ; DHW interm circ pump Q33 ; DHW mixing pump Q35 ; Collector pump Q5 ; Collector pump 2 Q16 ; Solar pump ext exch K9 ; Solar ctrl elem buffer K8 ; Solar ctrl elem swi pool K18 ; El imm heater buffer K16 ; Cons circuit pump VK1 Q15 ; Cons circuit pump VK2 Q18 ; Swimming pool pump Q19 ; Heat circuit pump HC3 Q20 ; 2nd pump speed HC1 Q21 ; 2nd pump speed HC2 Q22 ; 2nd pump speed HC3 Q23 ; Div valve HC/CC1 Y21 ; Air dehumidifier K29 ; Heat request K27 ; Refrigeration request K28 ; Alarm output K10 ; Time program 5 K13 ; Heat circuit pump HC1 Q2 ; DHW ctrl elem Q3 ; Source pump Q8/fan K19 ; Condenser pump Q9 ; Compressor stage 1 K1 ; Suppl source control K32 ; Heat circuit pump HC2 Q6 ; Instant WH ctrl elem Q34 ; Common flow valve Y13 ; Div valve HC/CC2 Y45 ; Div valve HC/CC3 Y46 ; Cooling circ pump CC1 Q24 ; Cooling circ pump CC2 Q28 ; Cooling circ pump CC3 Q29 ; Solid fuel boiler pump Q10 ; Flue gas relay K17 ; Assisted firing fan K30 ; Crankcase heater K40 ; Drip tray heater K41 ; Valve evaporator K81 ; Valve EVI K82 ; Valve injection capillary K83 ; dT controller 1 K21 ; dT controller 2 K22 ; Ventilation fan 1 K51 ; Ventilation fan 2 K52 ; Ventilation fan 3 K53 ; Ventilation bypass 1 K54 ; Ventilation bypass 2 K55 ; Ventilation bypass 3 K56 ; Outside air temp contr Q17 ; Source int circ pump Q81 ; Source int circ div Y81 ; DHW heat pump K33 ; System pump 2 Q44 ; Div valve cooling cond Y27 ; Div valve cooling flow Y29 ; Cond reversing valve Y91 ; Buffer reversing valve Y47 ; Status info heating K42 ; Status info cooling K43 ; Status info DHW charg K44 ; Heat/cool circ pump 1 Q2 ; Heat/cool circ pump 2 Q6 ; Heat/cool circ pump 3 Q20 ; Status info generation K45 ; Fault info generation K46					
5891	I	Relay output QX2 Ditto 5890	None				
5892	I	Relay output QX3 Ditto 5890	None				
5894	I	Triac output ZX4 Ditto 5890	None				
5895	I	Relay output QX5 Ditto 5890	None				
5896	I	Relay output QX6 Ditto 5890	None				
5897	I	Relay output QX7 Ditto 5890	Compressor stage 1 K1				
5898	I	Relay output QX8 Ditto 5890	DHW ctrl elem Q3				
5899	I	Relay output QX9 Ditto 5890	None				
5900	I	Relay output QX10 Ditto 5890	None				
5901	I	Relay output QX11 Ditto 5890	None				
5902	I	Relay output QX12 Ditto 5890	Source pump Q8/fan K19				
5903	I	Relay output QX13 Ditto 5890	Condenser pump Q9				
ZX module basic unit							
5909	I	Function output ZX4-Mod None ; Source pump Q8/fan K19 ; DHW pump Q3 ; DHW interm circ pump Q33 ; Heat circuit pump HC1 Q2 ; Heat circuit pump HC2 Q6 ; Heat circuit pump HC3 Q20 ; Collector pump Q5 ; Solar pump ext exch K9 ; Solar pump buffer K8 ; Solar pump swi pool K18 ; Collector pump 2 Q16 ; Instant WH pump Q34 ; Solid fuel boiler pump Q10 ; Condenser pump Q9 ; Heat/cool circ pump 1 Q2 ; Heat/cool circ pump 2 Q6 ; Heat/cool circ pump 3 Q20 ; Compressor modulation ; Ventilation fan 1 K51 ; Ventilation fan 2 K52 ; Ventilation fan 3 K53					

Operating line	Op. level	Function	Default value	Min.	Max.	Unit	Green leaf
BX basic unit							
5930	I	Sensor input BX1 None Buffer sensor B4 Buffer sensor B41 Collector sensor B6 DHW sensor B31 Hot-gas sensor B82 Refrig sensor liquid B83 DHW charging sensor B36 DHW outlet sensor B38 DHW circulation sensor B39 Swimming pool sensor B13 Collector sensor 2 B61 Solar flow sensor B63 Solar return sensor B64 Buffer sensor B42 Common flow sensor B10 Cascade return sensor B70 Special temp sensor 1 Special temp sensor 2 DHW sensor B3 HP flow sensor B21 HP return sensor B71 Hot-gas sensor B81 Outside sensor B9 Source inlet sensor B91 Source outl sens B92/B84 Room sensor B5 Room setp readjustment 1 Room sensor B52 Room setp readjustment 2 Room sensor B53 Room setp readjustment 3 Flue gas temp sensor B8 Solid fuel boiler sensor B22 Solid fuel boil ret sens B72 Suction gas sensor B85 Suction gas sensor EVI B86 Evaporation sensor EVI B87 DHW prim contr sensor B35 Outside air sensor B19 Common flow sensor 2 B11 Common return sensor B73 Source int circ flow B93 Source int circ return B94 Suction gas sensor cool B88					
5931	I	Sensor input BX2 Ditto 5930	None				
5932	I	Sensor input BX3 None Buffer sensor B4 Buffer sensor B41 Collector sensor B6 DHW sensor B31 Hot-gas sensor B82 Refrig sensor liquid B83 DHW charging sensor B36 DHW outlet sensor B38 DHW circulation sensor B39 Swimming pool sensor B13 Collector sensor 2 B61 Solar flow sensor B63 Solar return sensor B64 Buffer sensor B42 Common flow sensor B10 Cascade return sensor B70 Special temp sensor 1 Special temp sensor 2 DHW sensor B3 HP flow sensor B21 HP return sensor B71 Hot-gas sensor B81 Outside sensor B9 Room sensor B5 Room setp readjustment 1 Room sensor B52 Room setp readjustment 2 Room sensor B53 Room setp readjustment 3 Flue gas temp sensor B8 Solid fuel boiler sensor B22 Solid fuel boil ret sens B72 DHW prim contr sensor B35 Outside air sensor B19 Common flow sensor 2 B11 Common return sensor B73---					
5933	I	Sensor input BX4 Ditto 5932	None				
5936	I	Sensor input BX7 Ditto 5932	Hot-gas sensor B81				
5937	I	Sensor input BX8 Ditto 5932	DHW sensor B3				
5938	I	Sensor input BX9 Ditto 5932	Outside sensor B9				
5939	I	Sensor input BX10 Ditto 5932	HP flow sensor B21				
5940	I	Sensor input BX11 Ditto 5932	None				
5941	I	Sensor input BX12 Ditto 5932	HP return sensor B71				
5942	I	Sensor input BX13 None Buffer sensor B4 Buffer sensor B41 Collector sensor B6 DHW sensor B31 Hot-gas sensor B82 Refrig sensor liquid B83 DHW charging sensor B36 DHW outlet sensor B38 DHW circulation sensor B39 Swimming pool sensor B13 Collector sensor 2 B61 Solar flow sensor B63 Solar return sensor B64 Buffer sensor B42 Common flow sensor B10 Cascade return sensor B70 Special temp sensor 1 Special temp sensor 2 DHW sensor B3 HP flow sensor B21 HP return sensor B71 Hot-gas sensor B81 Outside sensor B9 Source inlet sensor B91 Source outl sens B92/B84 Room sensor B5 Room setp readjustment 1 Room sensor B52 Room setp readjustment 2 Room sensor B53 Room setp readjustment 3 Flue gas temp sensor B8 Solid fuel boiler sensor B22 Solid fuel boil ret sens B72 ---Suction gas sensor B85 Suction gas sensor EVI B86--- Evaporation sensor EVI B87 DHW prim contr sensor B35 Outside air sensor B19 Common flow sensor 2 B11 Common return sensor B73 Source int circ flow B93 Source int circ return B94 Suction gas sensor cool B88---					
5943	I	Sensor input BX14 Ditto 5942	Source outl sens B92/B84				

Operating line	Op. level	Function	Default value	Min.	Max.	Unit	Green leaf
H1 basic unit							
5950	I	Function input H1 None Op'mode change zones+DHW Optg mode changeover DHW Op'mode changeover zones Op'mode changeover zone 1 Op'mode changeover zone 2 Op'mode changeover zone 3 Error/alarm message Consumer request VK1 Consumer request VK2 Release swi pool source heat Release swi pool solar Operating level DHW Operating level HC1 Operating level HC2 Operating level HC3 Room thermostat HC1 Room thermostat HC2 Room thermostat HC3 DHW flow switch Pulse count Dewpoint monitor Flow temp setp incr hygro Swi-on command HP stage 1 Swi-on command HP stage 2 Status info suppl source Charg prio DHW sol fuel boil Ventilation switch 1 Ventilation switch 2 Ventilation switch 3 Flow measurement Hz Consumer request VK1 10V Consumer request VK2 10V Pressure measurement 10V Humidity measurement 10V Room temp 10V Flow measurement 10V Temp measurement 10V Air quality measurement 10V					
5951	I	Contact type H1 NC NO	NO				
5953	I	Input value 1 H1	0	0	1000	-	
5954	I	Function value 1 H1	0	-100	500	-	
5955	I	Input value 2 H1	10	0	1000	-	
5956	I	Function value 2 H1	100	-100	500	-	
5957	I	Temperature sensor H1 None Solar flow sensor B63 Solar return sensor B64 HP flow sensor B21 HP return sensor B71	None				
H3 basic unit							
5960	I	Function input H3 Ditto 5950					
5961	I	Contact type H3 NC NO	NO				
5963	I	Input value 1 H3	0	0	1000	-	
5964	I	Function value 1 H3	0	-100	500	-	
5965	I	Input value 2 H3	10	0	1000	-	
5966	I	Function value 2 H3	100	-100	500	-	
5967	I	Temperature sensor H3 None Solar flow sensor B63 Solar return sensor B64 HP flow sensor B21 HP return sensor B71	None				
EX/E basic unit							
5980	I	Function input EX1 None Electrical utility lock E6 Low-tariff E5 Overload compressor 2 E12 Overload source E14 Pressure switch source E26 Flow switch source E15 Flow switch consumers E24 Manual defrost E17 Common fault HP E20 Fault soft starter E25 Low-pressure switch E9 High-pressure switch E10 Overload compressor 1 E11 Error/alarm message Mains supervision E21 Fault soft starter 2 E27 Pressure diff defrost E28 Pres sw source int circ E29 Flow sw source int circ E30 Smart grid E61 Smart grid E62 Low-pressure switch 2 E31 High-pressure switch 2 E32 Defrost message E33 Photovoltaics E64 SHC error message E34 SHC 2 error message E35					
5981	O	Cont type input EX1 NC NO	NO				
5982	I	Function input EX2 Ditto 5980	Low-tariff E5				
5983	O	Cont type input EX2 NC NO	NO				
5984	I	Function input EX3 Ditto 5980	Overload source E14				
5985	O	Cont type input EX3 NC NO	NO				
5986	I	Function input EX4 Ditto 5980	Pressure switch source E26				
5987	O	Cont type input EX4 NC NO	NO				

Operating line	Op. level	Function	Default value	Min.	Max.	Unit	Green leaf
5988	I	Function input EX5 None Electrical utility lock E6 Low-tariff E5 Overload compressor 2 E12 Overload source E14 Pressure switch source E26 Flow switch source E15 Flow switch consumers E24 Manual defrost E17 Common fault HP E20 Fault soft starter E25 3-phase current Low-pressure switch E9 High-pressure switch E10 Overload compressor 1 E11 Error/alarm message Mains supervision E21 Fault soft starter 2 E27 Pressure diff defrost E28 Pres sw source int circ E29 Flow sw source int circ E30 Smart grid E61 Smart grid E62 Low-pressure switch 2 E31 High-pressure switch 2 E32 Defrost message E33 Photovoltaics E64 SHC error message E34 SHC 2 error message E35					
5989	O	Cont type input EX5 NC NO	NO				
5990	I	Function input EX6 Ditto 5988	Flow switch consumers E24				
5991	O	Cont type input EX6 NC NO	NO				
5992	I	Function input EX7 Ditto 5988	None				
5993	O	Cont type input EX7 NC NO	NO				
5996	I	Function input EX9 Ditto 5980	Low-pressure switch E9				
5997	I	Function input EX10 Ditto 5980	High-pressure switch E10				
5998	I	Function input EX11 Ditto 5980	Overload compressor 1 E11				
5999	O	Cont type input EX9 NC NO	NC				
6000	O	Cont type input EX10 NC NO	NC				
6001	O	Cont type input EX11 NC NO	NC				
Mixing groups 1 basic unit							
6014	I	Function mixing group 1 Multifunctional Heating circuit 1 Heating circuit 2 Heating circuit 3 Primary contr/system pump DHW primary controller Instantaneous water heater Cooling circuit 1 Heating circ/cooling circ 1 Ret temp contr sol fuel boil Cooling circuit 2 Heating circ/cooling circ 2 Cooling circuit 3 Heating circ/cooling circ 3 DHW interm circuit controller					
UX1 (10V/PWM) basic unit							
6070	I	Function output UX1 None Source pump Q8/fan K19 DHW pump Q3 DHW interm circ pump Q33 Heat circuit pump HC1 Q2 Heat circuit pump HC2 Q6 Heat circuit pump HC3 Q20 Collector pump Q5 Solar pump ext exch K9 Solar pump buffer K8 Solar pump swi pool K18 Collector pump 2 Q16 Instant WH pump Q34 Solid fuel boiler pump Q10 Condenser pump Q9 Heat/cool circ pump 1 Q2 Heat/cool circ pump 2 Q6 Heat/cool circ pump 3 Q20 HP setpoint Output request Heat request Refrigeration request Compressor modulation Expansion valve evapor V81 Expansion valve EVI V82 Ventilation fan 1 K51 Ventilation fan 2 K52 Ventilation fan 3 K53					
6071	I	Signal logic output UX1 Standard Inverted	Standard				
6072	I	Signal output UX1 0..10V PWM	0..10V				
6075	I	Temp value 10V UX1	100	5	130	°C	
6076	O	Output voltage UX1	10	0	10	V	
UX2 (10V/PWM) basic unit							
6078	I	Function output UX2 Ditto 6070	None				

Operating line	Op. level	Function	Default value	Min.	Max.	Unit	Green leaf
6079	I	Signal logic output UX2 Standard Inverted	Standard				
6080	I	Signal output UX2 0..10V PWM	0..10V				
6084	I	Temp value 10V UX2	100	5	130	°C	
6087	O	Output voltage UX2	10	0	10	V	
Sensor types/readjustments							
6096	O	Sensor type device NTC 10k/1k NTC 5k	NTC 10k/1k				
6097	F	Sensor type collector NTC Pt 1000	NTC				
6098	F	Readjustm collector sensor	0	-20	20	°C	
6099	F	Readjustm coll sensor 2	0	-20	20	°C	
6100	F	Readjustm outside sensor	0.0	-3.0	3.0	°C	
6101	F	Sensor type flue gas temp NTC Pt 1000	NTC				
6102	F	Readjustm flue gas sensor	0	-20	20	°C	
6104	F	Sensor type solar flow/ret NTC Pt 1000	NTC				
6105	F	Sensor type HP flow/return NTC Pt 1000	NTC				
6106	F	Sens type source in-/outlet NTC Pt 1000	NTC				
Building and room model							
6110	F	Time constant building	20	0	50	h	
Setpoint compensation							
6114	O	Setp compensation Xp	24	1	100	°C	
6115	O	Setp compensation Tn	120	10	650	s	
6116	O	Time constant setp compens	0	0	14		
6117	F	Central setp compensation	20	--- / 1	100	°C	
6118	O	Setpoint drop delay	10	--- / 1	200	K/min	
6119	F	Central setp compens cooling	-5	--- / -20	-1	°C	
Pump/valve							
6120	F	Frost protection plant Off On	On				
6123	F	Restart lock pumps	---	--- / 0	600	s	
Static pressure supervision							
6140	O	Water pressure max	3	--- / 0	10	bar	
6141	O	Water pressure min	0.8	--- / 0	10	bar	
6142	O	Water pressure critical min	0.5	--- / 0	10	bar	
6148	F	Static press supervision 1 None With input H1 With input H2 module 1 With input H2 module 2 With input H2 module 3 With input H21 module 1 With input H21 module 2 With input H21 module 3 With input H22 module 1 With input H22 module 2 With input H22 module 3 With input H3	None				
6150	O	Water pressure 2 max	3	--- / 0	10	bar	
6151	O	Water pressure 2 min	0.8	--- / 0	10	bar	
6152	O	Water press 2 critical min	0.5	--- / 0	10	bar	
6154	F	Static press supervision 2 Ditto 6148	None				
6180	O	Water pressure 3 max	3	--- / 0	10	bar	
6181	O	Water pressure 3 min	0.8	--- / 0	10	bar	
6182	O	Water press 3 critical min	0.5	--- / 0	10	bar	
6184	F	Static press supervision 3	None				

Operating line	Op. level	Function	Default value	Min.	Max.	Unit	Green leaf
		Ditto 6148					
Parameter reset							
6200	F	Save sensors No Yes	No				
6201	F	Reset sensors No Yes	No				
6204	F	Save parameters No Yes	No				
6205	F	Reset to default parameters No Yes	No				
Plant diagrams							
6212	I	Check no. heat source 1	-	0	199999	-	
6213	I	Check no. heat source 2	-	0	199999	-	
6215	I	Check no. storage tank	-	0	199999	-	
6217	I	Check no. heating circuits	-	0	199999	-	
Device data							
6220	I	Software version	-	0	99	-	
6221	O	Development index	-	0	65535	-	
6222	O	Device hours run	-	0	20833	h	
6228	O	Bootloader version	-	0	65535	-	
6229	O	Eeprom version	1	0	65535	-	
6345	O	Code commissioning	-	0	99999	-	
6346	O	Code engineer	-	0	99999	-	
Room sensors 10V to Hx							
6290	I	Acquisition room temp 1 None With input H1 With input H2 module 1 With input H2 module 2 With input H2 module 3 With input H21 module 1 With input H21 module 2 With input H21 module 3 With input H22 module 1 With input H22 module 2 With input H22 module 3 With input H3					
6291	I	Acquisition room temp 2 None With input H1 With input H2 module 1 With input H2 module 2 With input H2 module 3 With input H21 module 1 With input H21 module 2 With input H21 module 3 With input H22 module 1 With input H22 module 2 With input H22 module 3 With input H3					
6292	I	Acquisition room temp 3 None With input H1 With input H2 module 1 With input H2 module 2 With input H2 module 3 With input H21 module 1 With input H21 module 2 With input H21 module 3 With input H22 module 1 With input H22 module 2 With input H22 module 3 With input H3					
6293	I	Acquisition room rh 1 None With input H1 With input H2 module 1 With input H2 module 2 With input H2 module 3 With input H21 module 1 With input H21 module 2 With input H21 module 3 With input H22 module 1 With input H22 module 2 With input H22 module 3 With input H3					
6294	I	Acquisition room rh 2 None With input H1 With input H2 module 1 With input H2 module 2 With input H2 module 3 With input H21 module 1 With input H21 module 2 With input H21 module 3 With input H22 module 1 With input H22 module 2 With input H22 module 3 With input H3					
6295	I	Acquisition room rh 3 None With input H1 With input H2 module 1 With input H2 module 2 With input H2 module 3 With input H21 module 1 With input H21 module 2 With input H21 module 3 With input H22 module 1 With input H22 module 2 With input H22 module 3 With input H3					
6296	I	Acquis room air quality 1 None With input H1 With input H2 module 1 With input H2 module 2 With input H2 module 3 With input H21 module 1 With input H21 module 2 With input H21 module 3 With input H22 module 1 With input H22 module 2 With input H22 module 3 With input H3					
6297	I	Acquis room air quality 2 None With input H1 With input H2 module 1 With input H2 module 2 With input H2 module 3 With input H21 module 1 With input H21 module 2 With input H21 module 3 With input H22 module 1 With input H22 module 2 With input H22 module 3 With input H3					



Operating line	Op. level	Function	Default value	Min.	Max.	Unit	Green leaf
6298	I	Acquis room air quality 3 None With input H1 With input H2 module 1 With input H2 module 2 With input H2 module 3 With input H21 module 1 With input H21 module 2 With input H21 module 3 With input H22 module 1 With input H22 module 2 With input H22 module 3 With input H3					
ACS	F	Partial diagram heat circuit 1					
ACS	F	Partial diagram cooling circuit 1					
ACS	F	Partial diagram heat circuit 2					
ACS	F	Partial diagram cooling circuit 2					
ACS	F	Partial diagram heat circuit 3					
ACS	F	Partial diagram cooling circuit 3					
ACS	F	Partial diagram ventilation 1					
ACS	F	Partial diagram ventilation 2					
ACS	F	Partial diagram ventilation 3					
ACS	F	Partial diagram Consumer circuit 1					
ACS	F	Partial diagram Consumer circuit 2					
ACS	F	Partial diagram swimming pool circuit					
ACS	F	Partial diagram swimming pool					
ACS	F	Partial diagram converter					
ACS	F	Partial diagram converter 2					
ACS	F	Selection of partial diagram heat pump					
ACS	F	Partial diagram suppl source					
ACS	F	Partial diagram hydraulic balancing					
ACS	F	Cascade status Inactive Active	-				
ACS	F	Partial diagram solar collector					
ACS	F	Partial diagram solid fuel boiler					
ACS	F	Partial diagram buffer					
ACS	F	Partial diagram dhw storage					
ACS	F	Partial diagram instantaneous heater					
ACS	F	LPB interface available					
ACS	F	Modbus interface available					
LPB system							
6600	I	Device address	1	0	16	-	
6601	F	Segment address	0	0	14	-	
6604	F	Bus power supply function Off Automatically	Automatically				
6605	F	Bus power supply state Off On	On				
6610	O	Display system messages No Yes	Yes				
6612	O	Alarm delay	- - -	- - - / 2	60	min	
6620	F	Action changeover functions Segment System	System				
6621	F	Summer changeover Locally Centrally	Locally				
6623	F	Optg mode changeover Locally Centrally	Centrally				
6625	F	DHW assignment All HC/CC locally All HC/CC in segment All HC/CC in system	All HC/CC in system				
6627	F	Refrigeration request Locally Centrally	Centrally				
6630	F	Cascade master Always Automatically	Automatically				

Operating line	Op. level	Function	Default value	Min.	Max.	Unit	Green leaf
6632	F	Note OT limit ext source No Yes	Yes				
6640	I	Clock mode Autonomously Slave without remote setting Slave with remote setting Master	Autonomously				
6650	F	Outside temp source	-	S0/G1	S14/G16	-	
Modbus							
6651	I	Slave address	---	--- / 1	247	-	
6652	I	Baud rate 1'200 2'400 4'800 9'600 19'200 38'400 57'600 76'800 115'200	19'200				
6653	I	Parity Even Odd None	Even				
6654	I	Stop bit	1	1	2	-	
6655	O	Modbus OV version	1	0	9999	-	
6658	F	Master loss detection	---	0	600 -		
6660	I	Slave address port 1	1	--- / 1	247	-	
6661	I	Device port 1 None OEM Pump Grundfos Pump Wilo Fan Ebm-papst Inverter Invertek	None				
6662	I	Function port 1 None ... Heat/cool circ pump 3 Q20	None				
6665	I	Slave address port 2	1	--- / 1	247	-	
6666	I	Device port 2 None OEM Pump Grundfos Pump Wilo Fan Ebm-papst Inverter Invertek	None				
6667	I	Function port 2 None ... Heat/cool circ pump 3 Q20	None				
6670	I	Slave address port 3	1	--- / 1	247	-	
6671	I	Device port 3 None OEM Pump Grundfos Pump Wilo Fan Ebm-papst Inverter Invertek	None				
6672	I	Function port 3 None ... Heat/cool circ pump 3 Q20	None				
6675	I	Slave address port 4	1	--- / 1	247	-	
6676	I	Device port 4 None OEM Pump Grundfos Pump Wilo Fan Ebm-papst Inverter Invertek	None				
6677	I	Function port 4 None ... Heat/cool circ pump 3 Q20	None				
6680	I	Slave address port 5	1	--- / 1	247	-	
6681	I	Device port 5 None OEM Pump Grundfos Pump Wilo Fan Ebm-papst Inverter Invertek	None				
6682	I	Function port 5 None ... Heat/cool circ pump 3 Q20	None				
6685	I	Slave address port 6	1	--- / 1	247	-	
6686	I	Device port 6 None OEM Pump Grundfos Pump Wilo Fan Ebm-papst Inverter Invertek	None				
6687	I	Function port 6 None ... Heat/cool circ pump 3 Q20	None				
6690	I	Slave address port 7	1	--- / 1	247	-	
6691	I	Device port 7 None OEM Pump Grundfos Pump Wilo Fan Ebm-papst Inverter Invertek	None				

Operating line	Op. level	Function	Default value	Min.	Max.	Unit	Green leaf
6692	I	Function port 7 None ... Heat/cool circ pump 3 Q20	None				
6695	I	Slave address port 8	1	- - - / 1	247	-	
6696	I	Device port 8 None OEM Pump Grundfos Pump Wilo Fan Ebm-papst Inverter Invertek	None				
6697	I	Function port 8 None ... Heat/cool circ pump 3 Q20	None				
Modbus expert (ACS)							
ACS	O	Modbus response timeout	300	100	10000	ms	
ACS	I	Source error by Modbus error No Yes	Yes				
Port 1...8							
ACS	I	Byte order little Endian big Endian	big Endian				
ACS	I	Modbus function QX dito 5890					
ACS	I	Modbus function code QX No function Write single coil Write single register	No function				
ACS	I	Modbus register address QX	0	0	65535		
ACS	I	Modbus data type QX Boolean sign 16 bit unsign 16 bit	sign 16 bit				
ACS	I	Modbus bit mask QX	65535	0	65535		
ACS	I	Modbus multiplicator QX	1	-32768	32767		
ACS	I	Modbus divisor QX	1	-32768	32767		
ACS	I	Modbus offset QX	0	-32768	32767		
ACS	I	Modbus function UX dito 6070					
ACS	I	Modbus function code UX No function Write single coil Write single register	No function				
ACS	I	Modbus register address UX	0	0	65535		
ACS	I	Modbus data type UX Boolean sign 16 bit unsign 16 bit	sign 16 bit				
ACS	I	Modbus bit mask UX	65535	0	65535		
ACS	I	Modbus multiplicator UX	1	-32768	32767		
ACS	I	Modbus divisor UX	1	-32768	32767		
ACS	I	Modbus offset UX	0	-32768	32767		
ACS	I	Modbus function code state No function Read coils Read discrete inputs Read holding registers Read input registers	No function				
ACS	I	Modbus register address state	0	0	65535		
ACS	I	Modbus data type state Boolean sign 16 bit unsign 16 bit	sign 16 bit				
ACS	I	Modbus bit mask state	65535	0	65535		
ACS	I	Modbus multiplicator state	1	-32768	32767		
ACS	I	Modbus divisor state	1	-32768	32767		
ACS	I	Modbus offset state	0	-32768	32767		
ACS	I	Modbus function code UX feedback No function Read coils Read discrete inputs Read holding registers Read input registers	No function				
ACS	I	Modbus register address UX feedback	0	0	65535		
ACS	I	Modbus data type UX feedback Boolean sign 16 bit unsign 16 bit	sign 16 bit				

Operating line	Op. level	Function	Default value	Min.	Max.	Unit	Green leaf
ACS	I	Modbus bit mask UX feedback	65535	0	65535		
ACS	I	Modbus multiplicator UX feedback	1	-32768	32767		
ACS	I	Modbus divisor UX feedback	1	-32768	32767		
ACS	I	Modbus offset UX feedback	0	-32768	32767		
ACS	I	Modbus function BX dito 5930 plus Special temp sensor 3...8					
ACS	I	Modbus function code BX No function Read coils Read discrete inputs Read holding registers Read input registers	No function				
ACS	I	Modbus register address BX	0	0	65535		
ACS	I	Modbus data type BX Boolean sign 16 bit unsign 16 bit	sign 16 bit				
ACS	I	Modbus bit mask BX	65535	0	65535		
ACS	I	Modbus multiplicator BX	1	-32768	32767		
ACS	I	Modbus divisor BX	1	-32768	32767		
ACS	I	Modbus offset BX	0	-32768	32767		
ACS	I	Modbus function EX dito 5980					
ACS	I	Modbus function code EX No function Read coils Read discrete inputs Read holding registers Read input registers	No function				
ACS	I	Modbus register address EX	0	0	65535		
ACS	I	Modbus data type EX Boolean sign 16 bit unsign 16 bit	sign 16 bit				
ACS	I	Modbus bit mask EX	0	0	65535		
ACS	I	Modbus multiplicator EX	1	-32768	32767		
ACS	I	Modbus divisor EX	1	-32768	32767		
ACS	I	Modbus offset EX	0	-32768	32767		
ACS	I	Modbus compare value EX	- - -	0	65535		
ACS	I	Modbus function output 1	0	0	65535		
ACS	I	Modbus function code output 1 No function Write single coil Write single register	No function				
ACS	I	Modbus register address output 1	0	0	65535		
ACS	I	Modbus data type output 1 Boolean sign 16 bit unsign 16 bit	sign 16 bit				
ACS	I	Modbus bit mask output 1	65535	0	65535		
ACS	I	Modbus multiplicator output 1	1	-32768	32767		
ACS	I	Modbus divisor output 1	1	-32768	32767		
ACS	I	Modbus offset output 1	0	-32768	32767		
ACS	I	Modbus function code input 1 No function Read coils Read discrete inputs Read holding registers Read input registers	No function				
ACS	I	Modbus register address input 1	0	0	65535		
ACS	I	Modbus data type input 1 Boolean sign 16 bit unsign 16 bit	sign 16 bit				
ACS	I	Modbus bit mask input 1	65535	0	65535		
ACS	I	Modbus multiplicator input 1	1	-32768	32767		
ACS	I	Modbus divisor input 1	1	-32768	32767		
ACS	I	Modbus offset input 1	0	-32768	32767		
Fault							
6710	I	Reset alarm relay No Yes	No				

Operating line	Op. level	Function	Default value	Min.	Max.	Unit	Green leaf
6711	I	Reset HP No Yes	No				
6740	F	Flow temp 1 alarm	---	--- / 10	240	min	
6741	F	Flow temp 2 alarm	---	--- / 10	240	min	
6742	F	Flow temp 3 alarm	---	--- / 10	240	min	
6745	F	DHW charging alarm	---	--- / 1	48	h	
6746	F	Flow temp cooling 1 alarm	---	--- / 10	240	min	
6747	F	Flow temp cooling 2 alarm	---	--- / 10	240	min	
6748	F	Flow temp cooling 3 alarm	---	--- / 10	240	min	
6800	F	History 1	-				
6801	F	Error code 1	-	0	255	-	
6802	F	History 2	-				
6803	F	Error code 2	-	0	255	-	
6804	F	History 3	-				
6805	F	Error code 3	-	0	255	-	
6806	F	History 4	-				
6807	F	Error code 4	-	0	255	-	
6808	F	History 5	-				
6809	F	Error code 5	-	0	255	-	
6810	F	History 6	-				
6811	F	Error code 6	-	0	255	-	
6812	F	History 7	-				
6813	F	Error code 7	-	0	255	-	
6814	F	History 8	-				
6815	F	Error code 8	-	0	255	-	
6816	F	History 9	-				
6817	F	Error code 9	-	0	255	-	
6818	F	History 10	-				
6819	F	Error code 10	-	0	255	-	
6820	O	Reset history No Yes	No				
ACS	O	Repetition Error 107:Hot-gas compressor 1	2	--- / 0	50	-	
ACS	O	Repetition Error 108:Hot-gas compressor 2	2	--- / 0	50	-	
ACS	O	Repetition Error 134:Disturbance heat pump	---	--- / 0	50	-	
ACS	O	Repetition Error 204:Fan fault (overload)	2	--- / 0	50	-	
ACS	O	Repetition Error 222:High-pressure HP	2	--- / 0	50	-	
ACS	O	Repetition Error 225:Low-pressure HP	2	--- / 0	50	-	
ACS	O	Repetition Error 226:Compressor 1 overload	2	--- / 0	50	-	
ACS	O	Repetition Error 227:Compressor 2 overload	2	--- / 0	50	-	
ACS	O	Repetition Error 228:Flow switch heat source	2	--- / 0	50	-	
ACS	O	Repetition Error 229:Pressure switch heat source	2	--- / 0	50	-	
ACS	O	Repetition Error 230:Source pump overload	2	--- / 0	50	-	
ACS	O	Rep Error 355/385:Three-phase current/undervolt	2	--- / 0	50	-	
ACS	O	Repetition Error 356:Flow switch consumers	2	--- / 0	50	-	
ACS	O	Repetition Error 358/483: Soft starter	---	--- / 0	50	-	
ACS	O	Repetition Error 491:Max evaporation temp	2	--- / 0	50	-	
ACS	O	Repetition error 504:Press diff process reversal	2	--- / 0	50	-	
ACS	O	Repetition error 529/530: Superheat controller	2	--- / 0	50	-	
Service/special operation							
ACS	E	Maintenance message	-	0	360	-	

Operating line	Op. level	Function	Default value	Min.	Max.	Unit	Green leaf
ACS	I	Responsibility for message No display of responsibility Only display phone no Service Customer service Installer Janitor Administration Refrigeration engineer Hotline					
ACS	I	Telephone responsibility for message	-	0	255	-	
ACS	F	Displ event message electr immers heater Yes No	Yes	0	1	-	
7070	I	HP interval	---	--- / 1	240	Month	
7071	I	HP time since maint	0	0	240	Month	
7072	I	Max starts compr1/hrs run	---	--- / 0.1	12.0	-	
7073	I	Cur starts compr1/hrs run	0	0	12.0	-	
7074	I	Max starts compr2/hrs run	---	--- / 0.1	12.0	-	
7075	I	Cur starts compr2/hrs run	0	0	12.0	-	
7076	I	Diff condens max/week	---	--- / 1	250	-	
7077	I	Cur diff condens max/week	0	0	250	-	
7078	I	Diff condens min/week	---	--- / 1	250	-	
7079	I	Cur diff condens min/week	0	0	250	-	
7080	I	Diff evap max/week	---	--- / 1	250	-	
7081	I	Cur diff evap max/week	0	0	250	-	
7082	I	Diff evap min/week	---	--- / 1	250	-	
7083	I	Cur diff evap min/week	0	0	250	-	
7084	E	Maint interval ventilation 1	0	100	10000	h	
7085	E	Time since maint vent'n 1	0	0	10000	h	
7086	E	Maint interval ventilation 2	0	100	10000	h	
7087	E	Time since maint vent'n 2	0	0	10000	h	
7088	E	Maint interval ventilation 3	0	100	10000	h	
7089	E	Time since maint vent'n 3	0	0	10000	h	
7090	I	DHW storage tank interval	---	--- / 1	240	Month	
7091	I	DHW stor tank since maint	0	0	240	Month	
7092	I	DHW charg temp HP min	40	--- / 8	80	°C	
7093	I	Curr DHW charg temp HP	-	8	80	°C	
7119	F	Economy function Locked Released	Locked				
7120	E	Economy mode Off On	Off				
7124	F	Substitute setpoint source	60		8	95	
7125	F	Modbus T'out sub setpsourc	---		--- / 0	600	
7126	F	Modbus T'out sub setpcasc	---		--- / 0	600	
7127	F	LPB T'out sub setp source	---		--- / 0	600	
7130	F	Chimney sweep function Off On	Off				
7141	E	Emergency operation Off On	Off				
7142	F	Emergency op function type Manually Automatically	Manually				
7150	I	Simulation outside temp	---	--- / -50	50	°C	
7152	I	Triggering defrost No Yes	No				
7153	I	Pumping off refrigerant Off On	Off				
7154	F	Release wo source prot	0		0	240	
7167	I	Commissioning wizard On Off	On				

Operating line	Op. level	Function	Default value	Min.	Max.	Unit	Green leaf
7180	O	Text responsibility No display of responsibility Only display of phone no. Service Customer service Installer Janitor Administration Refrigeration engineer Hotline	No display of responsibility				
7181	I	Phone no. responsibility 1		0	16	Digits	
7182	O	Text responsibility 2 No display of responsibility Only display of phone no. Service Customer service Installer Janitor Administration Refrigeration engineer Hotline	No display of responsibility				
7183	I	Phone no. responsibility 2		0	16	Digits	
7184	O	Text responsibility 3 No display of responsibility Only display of phone no. Service Customer service Installer Janitor Administration Refrigeration engineer Hotline	No display of responsibility				
7185	O	Phone no. responsibility 3		0	16	Digits	
7186	O	Text responsibility 4 No display of responsibility Only display of phone no. Service Customer service Installer Janitor Administration Refrigeration engineer Hotline	No display of responsibility				
7187	O	Phone no. responsibility 4		0	16	Digits	
7188	O	Text responsibility 5 No display of responsibility Only display of phone no. Service Customer service Installer Janitor Administration Refrigeration engineer Hotline	No display of responsibility				
7189	O	Phone no. responsibility 5		0	16	Digits	
7202	I	Commissioning heat pump Off Heating mode Cooling mode	Off				
7207	I	Outp selection HP modulating	0	0	100	%	
7212	I	Outp selection HP multistage Off Compressor 1 Compressor 2 Compressor 1+2	Off				
7223	F	Disable heat pump Inactive Active	Inactive				
7226	O	Monitoring heat pump On Critical only	On				

Operating line	Op. level	Function	Default value	Min.	Max.	Unit	Green leaf
Config extension module							
Module 1							
7300	I	Function extension module 1 None Multifunctional Heating circuit 1 Heating circuit 2 Heating circuit 3 Solar DHW Primary contr/system pump DHW primary controller Instantaneous water heater Cooling circuit 1 Heating circ/cooling circ 1 Solid fuel boiler Cooling circuit 2 Heating circ/cooling circ 2 Cooling circuit 3 Heating circ/cooling circ 3 DHW interm circuit controller					
7301	I	Relay output QX21 module 1 None Compressor 2 K2 Process revers valve Y22 Hot-gas temp K31 El imm heater 1 flow K25 El imm heater 2 flow K26 Div valve cool source Y28 System pump Q14 Cascade pump Q25 Heat gen shutoff valve Y4 El imm heater DHW K6 Circulating pump Q4 St tank transfer pump Q11 DHW interm circ pump Q33 DHW mixing pump Q35 Collector pump Q5 Collector pump 2 Q16 Solar pump ext exch K9 Solar ctrl elem buffer K8 Solar ctrl elem swi pool K18 El imm heater buffer K16 Cons circuit pump VK1 Q15 Cons circuit pump VK2 Q18 Swimming pool pump Q19 Heat circuit pump HC3 Q20 2nd pump speed HC1 Q21 2nd pump speed HC2 Q22 2nd pump speed HC3 Q23 Div valve HC/CC1 Y21 Air dehumidifier K29 Heat request K27 Refrigeration request K28 Alarm output K10 Time program 5 K13 Heat circuit pump HC1 Q2 DHW ctrl elem Q3 Source pump Q8/fan K19 Condenser pump Q9 Compressor stage 1 K1 Suppl source control K32 Heat circuit pump HC2 Q6 Instant WH ctrl elem Q34 Common flow valve Y13 Div valve HC/CC2 Y45 Div valve HC/CC3 Y46 Cooling circ pump CC1 Q24 Cooling circ pump CC2 Q28 Cooling circ pump CC3 Q29 Solid fuel boiler pump Q10 Flue gas relay K17 Assisted firing fan K30 Crankcase heater K40 Drip tray heater K41 Valve evaporator K81 Valve EVI K82 Valve injection capillary K83 dT controller 1 K21 dT controller 2 K22 Ventilation fan 1 K51 Ventilation fan 2 K52 Ventilation fan 3 K53 Ventilation bypass 1 K54 Ventilation bypass 2 K55 Ventilation bypass 3 K56 Outside air temp contr Q17 Source int circ pump Q81 Source int circ div Y81 DHW heat pump K33 System pump 2 Q44 Div valve cooling cond Y27 Div valve cooling flow Y29 Cond reversing valve Y91 Buffer reversing valve Y47 Status info heating K42 Status info cooling K43 Status info DHW charg K44 Heat/cool circ pump 1 Q2 Heat/cool circ pump 2 Q6 Heat/cool circ pump 3 Q20 Status info generation K45 Fault info generation K46					
7302	I	Relay output QX22 module 1 Ditto 7301					
7303	I	Relay output QX23 module 1 Ditto 7301					
7307	I	Sensor input BX21 module 1 None Buffer sensor B4 Buffer sensor B41 Collector sensor B6 DHW sensor B31 Hot-gas sensor B82 Refrig sensor liquid B83 DHW charging sensor B36 DHW outlet sensor B38 DHW circulation sensor B39 Swimming pool sensor B13 Collector sensor 2 B61 Solar flow sensor B63 Solar return sensor B64 Buffer sensor B42 Common flow sensor B10 Cascade return sensor B70 Special temp sensor 1 Special temp sensor 2 DHW sensor B3 HP flow sensor B21 HP return sensor B71 Hot-gas sensor B81 Outside sensor B9 Source inlet sensor B91 Source outl sens B92/B84 Room sensor B5 Room setp readjustment 1 Room sensor B52 Room setp readjustment 2 Room sensor B53 Room setp readjustment 3 Flue gas temp sensor B8 Solid fuel boiler sensor B22 Solid fuel boil ret sens B72 Suction gas sensor B85 Suction gas sensor EVI B86 Evaporation sensor EVI B87 DHW prim contr sensor B35 Outside air sensor B19 Common flow sensor 2 B11 Common return sensor B73 Source int circ flow B93 Source int circ return B94 Suction gas sensor cool B88					
7308	I	Sensor input BX22 module 1 Ditto 7307					
7311	I	Function input H2 module 1 None Op'mode change zones+DHW Optg mode changeover DHW Op'mode changeover zones Op'mode changeover zone 1 Op'mode changeover zone 2 Op'mode changeover zone 3 Error/alarm message Consumer request VK1 Consumer request VK2 Release swi pool source heat Release swi pool solar Operating level DHW Operating level HC1 Operating level HC2 Operating level HC3 Room thermostat HC1 Room thermostat HC2 Room thermostat HC3 DHW flow switch Dewpoint monitor Flow temp setp incr hygro Swi-on command HP stage 1 Swi-on command HP stage 2 Status info suppl source Charg prio DHW sol fuel boil Ventilation switch 1 Ventilation switch 2 Ventilation switch 3 Consumer request VK1 10V Consumer request VK2 10V Pressure measurement 10V Humidity measurement 10V Room temp 10V Flow measurement 10V Temp measurement 10V					
7312	I	Contact type H2 module 1 NC NO	NO				
7314	I	Voltage value 1 H2 module 1	0	0	10	V	
7315	I	Funct value 1 H2 module 1	0	-100	500		
7316	I	Voltage value 2 H2 module 1	10	0	10	V	
7317	I	Funct value 2 H2 module 1	100	-100	500		
7318	I	Temp sensor H2 module 1 None Solar flow sensor B63 Solar return sensor B64 HP flow sensor B21 HP return sensor B71	None				

Operating line	Op. level	Function	Default value	Min.	Max.	Unit	Green leaf
7321	I	Function input H21 module 1 None ; Op'mode change zones+DHW ; Optg mode changeover DHW ; Op'mode changeover zones ; Op'mode changeover zone 1 ; Op'mode changeover zone 2 ; Op'mode changeover zone 3 ; Error/alarm message ; Consumer request VK1 ; Consumer request VK2 ; Release swi pool source heat ; Release swi pool solar ; Operating level DHW ; Operating level HC1 ; Operating level HC2 ; Operating level HC3 ; Room thermostat HC1 ; Room thermostat HC2 ; Room thermostat HC3 ; DHW flow switch ; Pulse count ; Dewpoint monitor ; Flow temp setp incr hygro ; Swi-on command HP stage 1 ; Swi-on command HP stage 2 ; Status info suppl source ; Charg prio DHW sol fuel boil ; Ventilation switch 1 ; Ventilation switch 2 ; Ventilation switch 3 ; Flow measurement Hz ; Consumer request VK1 10V ; Consumer request VK2 10V ; Pressure measurement 10V ; Humidity measurement 10V ; Room temp 10V ; Flow measurement 10V ; Temp measurement 10V ; Air quality measurement 10V					
7322	I	Contact type H21 module 1 NC ; NO	NO				
7324	I	Input value 1 H21 module 1	0	0	1000		
7325	I	Funct value 1 H21 module 1	0	-100	500		
7326	I	Input value 2 H21 module 1	10	0	1000		
7327	I	Funct value 2 H21 module 1	100	-100	500		
7328	I	Temp sensor H21 module 1 None ; Solar flow sensor B63 ; Solar return sensor B64 ; HP flow sensor B21 ; HP return sensor B71	None			-	
7331	I	Function input H22 module 1 Ditto 7321					
7332	I	Contact type H22 module 1 NC ; NO	NO				
7334	I	Input value 1 H22 module 1	0	0	1000		
7335	I	Funct value 1 H22 module 1	0	-100	500		
7336	I	Input value 2 H22 module 1	10	0	1000		
7337	I	Funct value 2 H22 module 1	100	-100	500		
7338	I	Temp sensor H22 module 1 None ; Solar flow sensor B63 ; Solar return sensor B64 ; HP flow sensor B21 ; HP return sensor B71	None				
7341	I	Voltage out GX21 module 1 5 Volt ; 12 Volt	5 Volt				
7342	I	Funct input EX21 module 1 None ; Electrical utility lock E6 ; Low-tariff E5 ; Overload compressor 2 E12 ; Overload source E14 ; Pressure switch source E26 ; Flow switch source E15 ; Flow switch consumers E24 ; Manual defrost E17 ; Common fault HP E20 ; Fault soft starter E25 ; Low-pressure switch E9 ; High-pressure switch E10 ; Overload compressor 1 E11 ; Error/alarm message ; Mains supervision E21 ; Fault soft starter 2 E27 ; Pressure diff defrost E28 ; Pres sw source int circ E29 ; Flow sw source int circ E30 ; Smart grid E61 ; Smart grid E62 ; Low-pressure switch 2 E31 ; High-pressure switch 2 E32 ; Defrost message E33 ; Photovoltaics E64 ; SHC error message E34 ; SHC 2 error message E35					
7343	O	Cont type inp EX21 module 1 NC ; NO	NO				
7348	I	Funct output UX21 module 1 None ; Source pump Q8/fan K19 ; DHW pump Q3 ; DHW interm circ pump Q33 ; Heat circuit pump HC1 Q2 ; Heat circuit pump HC2 Q6 ; Heat circuit pump HC3 Q20 ; Collector pump Q5 ; Solar pump ext exch K9 ; Solar pump buffer K8 ; Solar pump swi pool K18 ; Collector pump 2 Q16 ; Instant WH pump Q34 ; Solid fuel boiler pump Q10 ; Condenser pump Q9 ; Heat/cool circ pump 1 Q2 ; Heat/cool circ pump 2 Q6 ; Heat/cool circ pump 3 Q20 ; HP setpoint ; Output request ; Heat request ; Refrigeration request ; Compressor modulation ; Expansion valve evapor V81 ; Expansion valve EVI V82 ; Ventilation fan 1 K51 ; Ventilation fan 2 K52 ; Ventilation fan 3 K53					
7349	I	Sign logic out UX21 module1 Standard ; Inverted	Standard				
7350	I	Signal output UX21 module 1 0..10V ; PWM	0..10V				
7354	I	Temp val 10V UX21 module1	100	5	130	°C	
7355	I	Funct output UX22 module 1 Ditto 7348					
7356	I	Sign logic out UX22 module1 Standard ; Inverted	Standard				
7357	I	Signal output UX22 module 1 0..10V ; PWM	0..10V				

Operating line	Op. level	Function	Default value	Min.	Max.	Unit	Green leaf
7361	I	Temp val 10V UX22 module 1	100	5	130	°C	
7362	O	Funcnt output WX21 module 1 None Expansion valve evapor V81 Expansion valve EVI V82	None				
ACS	O	Operating mode WX21 module 1 Halbschritt Vollschritt 1-phasig	Halbschritt				
ACS	O	Rotating direction WX21 module 1 Standard Inverted	Inverted				
ACS	O	Step rate WX21 module 1	30	30	300	-	
ACS	O	Number of steps WX21 module 1	500	0	6400	-	
ACS	O	Steps at setpoint 0% WX21 module 1	12	0	6400	-	
ACS	O	Steps at setpoint 100% WX21 module 1	500	0	6400	-	
ACS	O	Steps overdrive WX21 module 1	50	0	6400	-	
ACS	O	Calibration WX21 module 1	50	- - - / 0	255	h	
Module 2							
7375	I	Function extension module 2 None Multifunctional Heating circuit 1 Heating circuit 2 Heating circuit 3 Solar DHW Primary contr/system pump DHW primary controller Instantaneous water heater Cooling circuit 1 Heating circ/cooling circ 1 Solid fuel boiler Cooling circuit 2 Heating circ/cooling circ 2 Cooling circuit 3 Heating circ/cooling circ 3 DHW interm circuit controller					
7376	I	Relay output QX21 module 2 None Compressor 2 K2 Process revers valve Y22 Hot-gas temp K31 El imm heater 1 flow K25 El imm heater 2 flow K26 Div valve cool source Y28 System pump Q14 Cascade pump Q25 Heat gen shutoff valve Y4 El imm heater DHW K6 Circulating pump Q4 St tank transfer pump Q11 DHW interm circ pump Q33 DHW mixing pump Q35 Collector pump Q5 Collector pump 2 Q16 Solar pump ext exch K9 Solar ctrl elem buffer K8 Solar ctrl elem swi pool K18 El imm heater buffer K16 Cons circuit pump VK1 Q15 Cons circuit pump VK2 Q18 Swimming pool pump Q19 Heat circuit pump HC3 Q20 2nd pump speed HC1 Q21 2nd pump speed HC2 Q22 2nd pump speed HC3 Q23 Div valve HC/CC1 Y21 Air dehumidifier K29 Heat request K27 Refrigeration request K28 Alarm output K10 Time program 5 K13 Heat circuit pump HC1 Q2 DHW ctrl elem Q3 Source pump Q8/fan K19 Condenser pump Q9 Compressor stage 1 K1 Suppl source control K32 Heat circuit pump HC2 Q6 Instant WH ctrl elem Q34 Common flow valve Y13 Div valve HC/CC2 Y45 Div valve HC/CC3 Y46 Cooling circ pump CC1 Q24 Cooling circ pump CC2 Q28 Cooling circ pump CC3 Q29 Solid fuel boiler pump Q10 Flue gas relay K17 Assisted firing fan K30 Crankcase heater K40 Drip tray heater K41 Valve evaporator K81 Valve EVI K82 Valve injection capillary K83 dT controller 1 K21 dT controller 2 K22 Ventilation fan 1 K51 Ventilation fan 2 K52 Ventilation fan 3 K53 Ventilation bypass 1 K54 Ventilation bypass 2 K55 Ventilation bypass 3 K56 Outside air temp contr Q17 Source int circ pump Q81 Source int circ div Y81 DHW heat pump K33 System pump 2 Q44 Div valve cooling cond Y27 Div valve cooling flow Y29 Cond reversing valve Y91 Buffer reversing valve Y47 Status info heating K42 Status info cooling K43 Status info DHW charg K44 Heat/cool circ pump 1 Q2 Heat/cool circ pump 2 Q6 Heat/cool circ pump 3 Q20 Status info generation K45 Fault info generation K46					
7377	I	Relay output QX22 module 2 Ditto 7376					
7378	I	Relay output QX23 module 2 Ditto 7376					
7382	I	Sensor input BX21 module 2 None Buffer sensor B4 Buffer sensor B41 Collector sensor B6 DHW sensor B31 Hot-gas sensor B82 Refrig sensor liquid B83 DHW charging sensor B36 DHW outlet sensor B38 DHW circulation sensor B39 Swimming pool sensor B13 Collector sensor 2 B61 Solar flow sensor B63 Solar return sensor B64 Buffer sensor B42 Common flow sensor B10 Cascade return sensor B70 Special temp sensor 1 Special temp sensor 2 DHW sensor B3 HP flow sensor B21 HP return sensor B71 Hot-gas sensor B81 Outside sensor B9 Source inlet sensor B91 Source outl sens B92/B84 Room sensor B5 Room setp readjustment 1 Room sensor B52 Room setp readjustment 2 Room sensor B53 Room setp readjustment 3 Flue gas temp sensor B8 Solid fuel boiler sensor B22 Solid fuel boil ret sens B72 Suction gas sensor B85 Suction gas sensor EVI B86 Evaporation sensor EVI B87 DHW prim contr sensor B35 Outside air sensor B19 Common flow sensor 2 B11 Common return sensor B73 Source int circ flow B93 Source int circ return B94 Suction gas sensor cool B88					
7383	I	Sensor input BX22 module 2 Ditto 7382					

Operating line	Op. level	Function	Default value	Min.	Max.	Unit	Green leaf
7386	I	Function input H2 module 2 None ; Op'mode change zones+DHW ; Optg mode changeover DHW ; Op'mode changeover zones ; Op'mode changeover zone 1 ; Op'mode changeover zone 2 ; Op'mode changeover zone 3 ; Error/alarm message ; Consumer request VK1 ; Consumer request VK2 ; Release swi pool source heat ; Release swi pool solar ; Operating level DHW ; Operating level HC1 ; Operating level HC2 ; Operating level HC3 ; Room thermostat HC1 ; Room thermostat HC2 ; Room thermostat HC3 ; DHW flow switch ; Dewpoint monitor ; Flow temp setp incr hygro ; Swi-on command HP stage 1 ; Swi-on command HP stage 2 ; Status info suppl source ; Charg prio DHW sol fuel boil ; Ventilation switch 1 ; Ventilation switch 2 ; Ventilation switch 3 ; Consumer request VK1 10V ; Consumer request VK2 10V ; Pressure measurement 10V ; Humidity measurement 10V ; Room temp 10V ; Flow measurement 10V ; Temp measurement 10V					
7387	I	Contact type H2 module 2 NC ; NO	NO				
7389	I	Voltage value 1 H2 module 2	0	0	10	V	
7390	I	Funct value 1 H2 module 2	0	-100	500		
7391	I	Voltage value 2 H2 module 2	10	0	10	V	
7392	I	Funct value 2 H2 module 2	100	-100	500		
7393	I	Temp sensor H2 module 2 None ; Solar flow sensor B63 ; Solar return sensor B64 ; HP flow sensor B21 ; HP return sensor B71	None				
7396	I	Function input H21 module 2 None ; Op'mode change zones+DHW ; Optg mode changeover DHW ; Op'mode changeover zones ; Op'mode changeover zone 1 ; Op'mode changeover zone 2 ; Op'mode changeover zone 3 ; Error/alarm message ; Consumer request VK1 ; Consumer request VK2 ; Release swi pool source heat ; Release swi pool solar ; Operating level DHW ; Operating level HC1 ; Operating level HC2 ; Operating level HC3 ; Room thermostat HC1 ; Room thermostat HC2 ; Room thermostat HC3 ; DHW flow switch ; Pulse count ; Dewpoint monitor ; Flow temp setp incr hygro ; Swi-on command HP stage 1 ; Swi-on command HP stage 2 ; Status info suppl source ; Charg prio DHW sol fuel boil ; Ventilation switch 1 ; Ventilation switch 2 ; Ventilation switch 3 ; Flow measurement Hz ; Consumer request VK1 10V ; Consumer request VK2 10V ; Pressure measurement 10V ; Humidity measurement 10V ; Room temp 10V ; Flow measurement 10V ; Temp measurement 10V ; Air quality measurement 10V					
7397	I	Contact type H21 module 2 NC ; NO	NO				
7399	I	Input value 1 H21 module 2	0	0	1000		
7400	I	Funct value 1 H21 module 2	0	-100	500		
7401	I	Input value 2 H21 module 2	10	0	1000		
7402	I	Funct value 2 H21 module 2	100	-100	500		
7403	I	Temp sensor H21 module 2 None ; Solar flow sensor B63 ; Solar return sensor B64 ; HP flow sensor B21 ; HP return sensor B71	None				
7406	I	Function input H22 module 2 Ditto 7396					
7407	I	Contact type H22 module 2 NC ; NO	NO				
7409	I	Input value 1 H22 module 2	0	0	1000		
7410	I	Funct value 1 H22 module 2	0	-100	500		
7411	I	Input value 2 H22 module 2	10	0	1000		
7412	I	Funct value 2 H22 module 2	100	-100	500		
7413	I	Temp sensor H22 module 2 None ; Solar flow sensor B63 ; Solar return sensor B64 ; HP flow sensor B21 ; HP return sensor B71	None				
7416	I	Voltage out GX21 module 2 5 Volt ; 12 Volt	5 Volt				
7417	I	Funct input EX21 module 2 None ; Electrical utility lock E6 ; Low-tariff E5 ; Overload compressor 2 E12 ; Overload source E14 ; Pressure switch source E26 ; Flow switch source E15 ; Flow switch consumers E24 ; Manual defrost E17 ; Common fault HP E20 ; Fault soft starter E25 ; Low-pressure switch E9 ; High-pressure switch E10 ; Overload compressor 1 E11 ; Error/alarm message ; Mains supervision E21 ; Fault soft starter 2 E27 ; Pressure diff defrost E28 ; Pres sw source int circ E29 ; Flow sw source int circ E30 ; Smart grid E61 ; Smart grid E62 ; Low-pressure switch 2 E31 ; High-pressure switch 2 E32 ; Defrost message E33 ; Photovoltaics E64 ; SHC error message E34 ; SHC 2 error message E35					
7418	O	Cont type inp EX21 module 2 NC ; NO	NO				

Operating line	Op. level	Function	Default value	Min.	Max.	Unit	Green leaf
7423	I	Funct output UX21 module 2 None Source pump Q8/fan K19 DHW pump Q3 DHW interm circ pump Q33 Heat circuit pump HC1 Q2 Heat circuit pump HC2 Q6 Heat circuit pump HC3 Q20 Collector pump Q5 Solar pump ext exch K9 Solar pump buffer K8 Solar pump swi pool K18 Collector pump 2 Q16 Instant WH pump Q34 Solid fuel boiler pump Q10 Condenser pump Q9 Heat/cool circ pump 1 Q2 Heat/cool circ pump 2 Q6 Heat/cool circ pump 3 Q20 HP setpoint Output request Heat request Refrigeration request Compressor modulation Expansion valve evapor V81 Expansion valve EVI V82 Ventilation fan 1 K51 Ventilation fan 2 K52 Ventilation fan 3 K53					
7424	I	Sign logic out UX21 module2 Standard Inverted	Standard				
7425	I	Signal output UX21 module 2 0..10V PWM	0..10V				
7429	I	Temp val 10V UX21 module2	100	5	130	°C	
7430	I	Funct output UX22 module 2 Ditto 7423					
7431	I	Sign logic out UX22 module2 Standard Inverted	Standard				
7432	I	Signal output UX22 module 2 0..10V PWM	0..10V				
7436	I	Temp val 10V UX22 module2	100	5	130	°C	
7437	O	Funct output WX21 module 2 None Expansion valve evapor V81 Expansion valve EVI V82	None				
ACS	O	Operating mode WX21 module 2 Halbschritt Vollschritt 1-phasig	Halbschritt				
ACS	O	Rotating direction WX21 module 2 Standard Inverted	Inverted				
ACS	O	Step rate WX21 module 2	30	30	300	-	
ACS	O	Number of steps WX21 module 2	500	0	6400	-	
ACS	O	Steps at setpoint 0% WX21 module 2	12	0	6400	-	
ACS	O	Steps at setpoint 100% WX21 module 2	500	0	6400	-	
ACS	O	Steps overdrive WX21 module 2	50	0	6400	-	
ACS	O	Calibration WX21 module 2	50	- - - / 0	255	h	
Module 3							
7450	I	Function extension module 3 None Multifunctional Heating circuit 1 Heating circuit 2 Heating circuit 3 Solar DHW Primary contr/system pump DHW primary controller Instantaneous water heater Cooling circuit 1 Heating circ/cooling circ 1 Solid fuel boiler Cooling circuit 2 Heating circ/cooling circ 2 Cooling circuit 3 Heating circ/cooling circ 3 DHW interm circuit controller					
7451	I	Relay output QX21 module 3 None Compressor 2 K2 Process revers valve Y22 Hot-gas temp K31 EI imm heater 1 flow K25 EI imm heater 2 flow K26 Div valve cool source Y28 System pump Q14 Cascade pump Q25 Heat gen shutoff valve Y4 EI imm heater DHW K6 Circulating pump Q4 St tank transfer pump Q11 DHW interm circ pump Q33 DHW mixing pump Q35 Collector pump Q5 Collector pump 2 Q16 Solar pump ext exch K9 Solar ctrl elem buffer K8 Solar ctrl elem swi pool K18 EI imm heater buffer K16 Cons circuit pump VK1 Q15 Cons circuit pump VK2 Q18 Swimming pool pump Q19 Heat circuit pump HC3 Q20 2nd pump speed HC1 Q21 2nd pump speed HC2 Q22 2nd pump speed HC3 Q23 Div valve HC/CC1 Y21 Air dehumidifier K29 Heat request K27 Refrigeration request K28 Alarm output K10 Time program 5 K13 Heat circuit pump HC1 Q2 DHW ctrl elem Q3 Source pump Q8/fan K19 Condenser pump Q9 Compressor stage 1 K1 Suppl source control K32 Heat circuit pump HC2 Q6 Instant WH ctrl elem Q34 Common flow valve Y13 Div valve HC/CC2 Y45 Div valve HC/CC3 Y46 Cooling circ pump CC1 Q24 Cooling circ pump CC2 Q28 Cooling circ pump CC3 Q29 Solid fuel boiler pump Q10 Flue gas relay K17 Assisted firing fan K30 Crankcase heater K40 Drip tray heater K41 Valve evaporator K81 Valve EVI K82 Valve injection capillary K83 dT controller 1 K21 dT controller 2 K22 Ventilation fan 1 K51 Ventilation fan 2 K52 Ventilation fan 3 K53 Ventilation bypass 1 K54 Ventilation bypass 2 K55 Ventilation bypass 3 K56 Outside air temp contr Q17 Source int circ pump Q81 Source int circ div Y81 DHW heat pump K33 System pump 2 Q44 Div valve cooling cond Y27 Div valve cooling flow Y29 Cond reversing valve Y91 Buffer reversing valve Y47 Status info heating K42 Status info cooling K43 Status info DHW charg K44 Heat/cool circ pump 1 Q2 Heat/cool circ pump 2 Q6 Heat/cool circ pump 3 Q20 Status info generation K45 Fault info generation K46					
7452	I	Relay output QX22 module 3 Ditto 7451					
7453	I	Relay output QX23 module 3 Ditto 7451					

Operating line	Op. level	Function	Default value	Min.	Max.	Unit	Green leaf
7457	I	Sensor input BX21 module 3 None ; Buffer sensor B4 ; Buffer sensor B41 ; Collector sensor B6 ; DHW sensor B31 ; Hot-gas sensor B82 ; Refrig sensor liquid B83 ; DHW charging sensor B36 ; DHW outlet sensor B38 ; DHW circulation sensor B39 ; Swimming pool sensor B13 ; Collector sensor 2 B61 ; Solar flow sensor B63 ; Solar return sensor B64 ; Buffer sensor B42 ; Common flow sensor B10 ; Cascade return sensor B70 ; Special temp sensor 1 ; Special temp sensor 2 ; DHW sensor B3 ; HP flow sensor B21 ; HP return sensor B71 ; Hot-gas sensor B81 ; Outside sensor B9 ; Source inlet sensor B91 ; Source outl sens B92/B84 ; Room sensor B5 ; Room setp readjustment 1 ; Room sensor B52 ; Room setp readjustment 2 ; Room sensor B53 ; Room setp readjustment 3 ; Flue gas temp sensor B8 ; Solid fuel boiler sensor B22 ; Solid fuel boil ret sens B72 ; Suction gas sensor B85 ; Suction gas sensor EVI B86 ; Evaporation sensor EVI B87 ; DHW prim contr sensor B35 ; Outside air sensor B19 ; Common flow sensor 2 B11 ; Common return sensor B73 ; Source int circ flow B93 ; Source int circ return B94 ; Suction gas sensor cool B88					
7458	I	Sensor input BX22 module 3 Ditto 7457					
7461	I	Function input H2 module 3 None ; Op'mode change zones+DHW ; Optg mode changeover DHW ; Op'mode changeover zones ; Op'mode changeover zone 1 ; Op'mode changeover zone 2 ; Op'mode changeover zone 3 ; Error/alarm message ; Consumer request VK1 ; Consumer request VK2 ; Release swi pool source heat ; Release swi pool solar ; Operating level DHW ; Operating level HC1 ; Operating level HC2 ; Operating level HC3 ; Room thermostat HC1 ; Room thermostat HC2 ; Room thermostat HC3 ; DHW flow switch ; Dewpoint monitor ; Flow temp setp incr hygro ; Swi-on command HP stage 1 ; Swi-on command HP stage 2 ; Status info suppl source ; Charg prio DHW sol fuel boil ; Ventilation switch 1 ; Ventilation switch 2 ; Ventilation switch 3 ; Consumer request VK1 10V ; Consumer request VK2 10V ; Pressure measurement 10V ; Humidity measurement 10V ; Room temp 10V ; Flow measurement 10V ; Temp measurement 10V					
7462	I	Contact type H2 module 3 NC ; NO	NO				
7464	I	Voltage value 1 H2 module 3	0	0	10	V	
7465	I	Funct value 1 H2 module 3	0	-100	500		
7466	I	Voltage value 2 H2 module 3	10	0	10	V	
7467	I	Funct value 2 H2 module 3	100	-100	500		
7468	I	Temp sensor H2 module 3 None ; Solar flow sensor B63 ; Solar return sensor B64 ; HP flow sensor B21 ; HP return sensor B71	None				
7471	I	Function input H21 module 3 None ; Op'mode change zones+DHW ; Optg mode changeover DHW ; Op'mode changeover zones ; Op'mode changeover zone 1 ; Op'mode changeover zone 2 ; Op'mode changeover zone 3 ; Error/alarm message ; Consumer request VK1 ; Consumer request VK2 ; Release swi pool source heat ; Release swi pool solar ; Operating level DHW ; Operating level HC1 ; Operating level HC2 ; Operating level HC3 ; Room thermostat HC1 ; Room thermostat HC2 ; Room thermostat HC3 ; DHW flow switch ; Pulse count ; Dewpoint monitor ; Flow temp setp incr hygro ; Swi-on command HP stage 1 ; Swi-on command HP stage 2 ; Status info suppl source ; Charg prio DHW sol fuel boil ; Ventilation switch 1 ; Ventilation switch 2 ; Ventilation switch 3 ; Flow measurement Hz ; Consumer request VK1 10V ; Consumer request VK2 10V ; Pressure measurement 10V ; Humidity measurement 10V ; Room temp 10V ; Flow measurement 10V ; Temp measurement 10V ; Air quality measurement 10V					
7472	I	Contact type H21 module 3 NC ; NO	NO				
7474	I	Input value 1 H21 module 3	0	0	1000		
7475	I	Funct value 1 H21 module 3	0	-100	500		
7476	I	Input value 2 H21 module 3	10	0	1000		
7477	I	Funct value 2 H21 module 3	100	-100	500		
7478	I	Temp sensor H21 module 3 None ; Solar flow sensor B63 ; Solar return sensor B64 ; HP flow sensor B21 ; HP return sensor B71	None				
7481	I	Function input H22 module 3 Ditto 7471					
7482	I	Contact type H22 module 3 NC ; NO	NO				
7484	I	Input value 1 H22 module 3	0	0	1000		
7485	I	Funct value 1 H22 module 3	0	-100	500		
7486	I	Input value 2 H22 module 3	10	0	1000		
7487	I	Funct value 2 H22 module 3	100	-100	500		

Operating line	Op. level	Function	Default value	Min.	Max.	Unit	Green leaf
7488	I	Temp sensor H22 module 3 None Solar flow sensor B63 Solar return sensor B64 HP flow sensor B21 HP return sensor B71	None				
7491	I	Voltage out GX21 module 3 5 Volt 12 Volt	5 Volt				
7492	I	Funcnt input EX21 module 3 None Electrical utility lock E6 Low-tariff E5 Overload compressor 2 E12 Overload source E14 Pressure switch source E26 Flow switch source E15 Flow switch consumers E24 Manual defrost E17 Common fault HP E20 Fault soft starter E25 Low-pressure switch E9 High-pressure switch E10 Overload compressor 1 E11 Error/alarm message Mains supervision E21 Fault soft starter 2 E27 Pressure diff defrost E28 Pres sw source int circ E29 Flow sw source int circ E30 Smart grid E61 Smart grid E62 Low-pressure switch 2 E31 High-pressure switch 2 E32 Defrost message E33 Photovoltaics E64 SHC error message E34 SHC 2 error message E35					
7493	O	Cont type EX21 module 3 NC NO	NO				
7498	I	Funcnt output UX21 module 3 None Source pump Q8/fan K19 DHW pump Q3 DHW interm circ pump Q33 Heat circuit pump HC1 Q2 Heat circuit pump HC2 Q6 Heat circuit pump HC3 Q20 Collector pump Q5 Solar pump ext exch K9 Solar pump buffer K8 Solar pump swi pool K18 Collector pump 2 Q16 Instant WH pump Q34 Solid fuel boiler pump Q10 Condenser pump Q9 Heat/cool circ pump 1 Q2 Heat/cool circ pump 2 Q6 Heat/cool circ pump 3 Q20 HP setpoint Output request Heat request Refrigeration request Compressor modulation Expansion valve evapor V81 Expansion valve EVI V82 Ventilation fan 1 K51 Ventilation fan 2 K52 Ventilation fan 3 K53					
7499	I	Sign logic out UX21 module3 Standard Inverted	Standard				
7500	I	Signal output UX21 module 3 0..10V PWM	0..10V				
7504	I	Temp val 10V UX21 module3	100	5	130	°C	
7505	I	Funcnt output UX22 module 3 Ditto 7498					
7506	I	Sign logic out UX22 module3 Standard Inverted	Standard				
7507	I	Signal output UX22 module 3 0..10V PWM	0..10V				
7511	I	Temp val 10V UX22 module3	100	5	130	°C	
7512	O	Funcnt output WX21 module 3 None Expansion valve evapor V81 Expansion valve EVI V82	None				
ACS	O	Rotating direction WX21 module 3 Standard Inverted	Inverted				
ACS	O	Operating mode WX21 module 3 Halbschritt Vollschritt 1-phasig	Halbschritt				
ACS	O	Step rate WX21 module 3	30	30	300	-	
ACS	O	Number of steps WX21 module 3	500	0	6400	-	
ACS	O	Steps at setpoint 0% WX21 module 3	12	0	6400	-	
ACS	O	Steps at setpoint 100% WX21 module 3	500	0	6400	-	
ACS	O	Steps overdrive WX21 module 3	50	0	6400	-	
ACS	O	Calibration WX21 module 3	50	- - - / 0	255	h	
Diagnostics Modbus slave							
Port1							
7610	F	Input signal BX port 1	0	0	65535	-	
7611	F	Input signal UX port 1	0	0	65535	-	
7612	F	Input state QX port 1	0	0	65535	-	
7613	F	Input state EX port 1	0	0	65535	-	
7614	F	Input signal 1 port 1	0	0	65535	-	
7616	F	Output signal UX port 1	0	0	65535	-	
7617	F	Output state QX port 1	0	0	65535	-	
7618	F	Output signal 1 port 1	0	0	65535	-	

Operating line	Op. level	Function	Default value	Min.	Max.	Unit	Green leaf
		Port2					
7620...7628:		dito					
		Port3					
7630..7638:		dito					
		Port4					
7640..7648:		dito					
		Port5					
7650..7658:		dito					
		Port6					
7660..7668:		dito					
		Port7					
7670..7678:		dito					
		Port8					
7680..7688:		dito					
Input/output test							
7700	I	Relay test No test Everything off Relay output QX1 Relay output QX2 Relay output QX3 Output QX4/ZX4 Relay output QX5 Relay output QX6 Relay output QX7 Relay output QX8 Relay output QX9 Relay output QX10 Relay output QX11 Relay output QX12 Relay output QX13 Relay output QX21 module 1 Relay output QX22 module 1 Relay output QX23 module 1 Relay output QX21 module 2 Relay output QX22 module 2 Relay output QX23 module 2 Relay output QX21 module 3 Relay output QX22 module 3 Relay output QX23 module 3					
7705	I	Mod setpoint ZX4 relay test	100	0	100	%	
7708	I	Modulation signal ZX4	-	0	100	%	
7710	I	Output test UX1	---	--- / 0	100	%	
7711	I	Output signal UX1	-	0	100		
7711	I	[Output signal UX1] Voltage V PWM %	None				
7716	I	Output test UX2	---	--- / 0	100	%	
7717	I	Output signal UX2	-	0	100		
7717	I	[Output signal UX2] Voltage V PWM %	None				
7780	I	Output test UX21 module 1	---	--- / 0	100	%	
7781	I	Output signal UX21 module 1	-	0	100		
7781	I	[Output signal UX21 module 1] Voltage V PWM %	None				
7782	I	Output test UX22 module 1	---	--- / 0	100	%	
7783	I	Output signal UX22 module 1	-	0	100		
7783	I	[Output signal UX22 module 1] Voltage V PWM %	None				
7784	I	Output test UX21 module 2	---	--- / 0	100	%	
7785	I	Output signal UX21 module 2	-	0	100		
7785	I	[Output signal UX21 module 2] Voltage V PWM %	None				
7786	I	Output test UX22 module 2	---	--- / 0	100	%	
7787	I	Output signal UX22 module 2	-	0	100		
7787	I	[Output signal UX22 module 2] Voltage V PWM %	None				
7788	I	Output test UX21 module 3	---	--- / 0	100	%	
7789	I	Output signal UX21 module 3	-	0	100		
7789	I	[Output signal UX21 module 3] Voltage V PWM %	None				
7790	I	Output test UX22 module 3	---	--- / 0	100	%	

Operating line	Op. level	Function	Default value	Min.	Max.	Unit	Green leaf
7791	I	Output signal UX22 module 3	-	0	100		
7791	I	[Output signal UX22 module 3] Voltage V ; PWM %	None				
7796	I	Output test WX21 module 1	- - -	- - - / 0	100	%	
7797	I	Pos step motor WX21 mod 1	-	0	65535		
7798	I	Output test WX21 module 2	- - -	- - - / 0	100	%	
7799	I	Pos step motor WX21 mod 2	-	0	65535		
7800	I	Output test WX21 module 3	- - -	- - - / 0	100	%	
7801	I	Pos step motor WX21 mod 3	-	0	65535		
7804	I	Sensor temp BX1	-	-28	350	°C	
7805	I	Sensor temp BX2	-	-28	350	°C	
7806	I	Sensor temp BX3	-	-28	350	°C	
7807	I	Sensor temp BX4	-	-28	350	°C	
7810	I	Sensor temp BX7	-	-28	350	°C	
7811	I	Sensor temp BX8	-	-28	350	°C	
7812	I	Sensor temp BX9	-	-28	350	°C	
7813	I	Sensor temp BX10	-	-28	350	°C	
7814	I	Sensor temp BX11	-	-28	350	°C	
7815	I	Sensor temp BX12	-	-28	350	°C	
7816	I	Sensor temp BX13	-	-28	350	°C	
7817	I	Sensor temp BX14	-	-28	350	°C	
7830	I	Sensor temp BX21 module 1	-	-28	350	°C	
7831	I	Sensor temp BX22 module 1	-	-28	350	°C	
7832	I	Sensor temp BX21 module 2	-	-28	350	°C	
7833	I	Sensor temp BX22 module 2	-	-28	350	°C	
7834	I	Sensor temp BX21 module 3	-	-28	350	°C	
7835	I	Sensor temp BX22 module 3	-	-28	350	°C	
7844	I	Input signal H1	-	0	65535		
7844	I	[Output signal H1] None ; Closed (ooo), Open (---) ; Pulse ; Frequency Hz ; Voltage V	None				
7845	I	Input signal H2 module 1	-	0	65535		
7845	I	[Output signal H2 module 1] None ; Closed (ooo), Open (---) ; Frequency Hz ; Voltage V	None				
7845	I	Input signal H21 module 1	-	0	65535		
7845	I	[Output signal H21 module 1] None ; Closed (ooo), Open (---) ; Pulse ; Frequency Hz ; Voltage V	None				
7846	I	Input signal H22 module 1	-	0	65535		
7846	I	[Output signal H22 module 1] None ; Closed (ooo), Open (---) ; Pulse ; Frequency Hz ; Voltage V	None				
7847	I	Input signal H2 module 2	-	0	65535		
7847	I	[Output signal H2 module 2] None ; Closed (ooo), Open (---) ; Frequency Hz ; Voltage V	None				
7847	I	Input signal H21 module 2	-	0	65535		
7847	I	[Output signal H21 module 2] None ; Closed (ooo), Open (---) ; Pulse ; Frequency Hz ; Voltage V	None				
7848	I	Input signal H22 module 2	-	0	65535		
7848	I	[Output signal H22 module 2] None ; Closed (ooo), Open (---) ; Pulse ; Frequency Hz ; Voltage V					

Operating line	Op. level	Function	Default value	Min.	Max.	Unit	Green leaf
7849	I	Input signal H2 module 3	-	0	65535		
7849	I	[Output signal H2 module 3] None Closed (ooo), Open (---) Frequency Hz Voltage V	None				
7849	I	Input signal H21 module 3	-	0	65535		
7849	I	[Output signal H21 module 3] None Closed (ooo), Open (---) Pulse Frequency Hz Voltage V	None				
7850	I	Input signal H22 module 3	-	0	65535		
7850	I	[Output signal H22 module 3] None Closed (ooo), Open (---) Pulse Frequency Hz Voltage V	None				
7858	I	Input signal H3	-	0	65535		
7858	I	[Output signal H3] None Closed (ooo), Open (---) Pulse Frequency Hz Voltage V	None				
7911	I	Input EX1 0V 230V	-				
7912	I	Input EX2 0V 230V	-				
7913	I	Input EX3 0V 230V	-				
7914	I	Input EX4 0V 230V	-				
7915	I	Input EX5 0V 230V	-				
7916	I	Input EX6 0V 230V	-				
7917	I	Input EX7 0V 230V	-				
7919	I	Input EX9 0V 230V	-				
7945	I	Input EX10 0V 230V	-				
7946	I	Input EX11 0V 230V	-				
7950	I	Input EX21 module 1 0V 230V	-				
7951	I	Input EX21 module 2 0V 230V	-				
7952	I	Input EX21 module 3 0V 230V	-				
ACS	O	Output test Modbus Port 1...8	- - -	- - -/0	100	%	
ACS	O	Output state Modbus Port 1...8	-	0	1	-	
ACS	O	Output signal Modbus Port 1...8	-	0	100	%	
ACS	O	Input signal Modbus Port 1...8	-	0	100	%	
State							
8000	I	State heating circuit 1	-	0	255	-	
8001	I	State heating circuit 2	-	0	255	-	
8002	I	State heating circuit 3	-	0	255	-	
8003	I	State DHW	-	0	255	-	
8004	I	State cooling circuit 1	-	0	255	-	
8006	I	State heat pump	-	0	255	-	
8007	I	State solar	-	0	255	-	
8008	I	State solid fuel boiler	-	0	255	-	
8010	I	State buffer	-	0	255	-	

Operating line	Op. level	Function	Default value	Min.	Max.	Unit	Green leaf
8011	I	State swimming pool	-	0	255	-	
8022	I	State supplementary source	-	0	255	-	
8025	I	State cooling circuit 2	-	0	255	-	
8026	I	Status cooling circuit 3	-	0	255	-	
8027	I	State ventilation 1	-	0	255	-	
8028	I	State ventilation 2	-	0	255	-	
8029	I	State ventilation 3	-	0	255	-	
8030	I	State consumer circuit 1	-	0	255	-	
8031	I	State consumer circuit 2	-	0	255	-	
8050	I	History 1	-				
8051	I	State code 1	-	0	255	-	
8052	I	History 2	-				
8053	I	State code 2	-	0	255	-	
8054	I	History 3	-				
8055	I	State code 3	-	0	255	-	
8056	I	History 4	-				
8057	I	State code 4	-	0	255	-	
8058	I	History 5	-				
8059	I	State code 5	-	0	255	-	
8060	I	History 6	-				
8061	I	State code 6	-	0	255	-	
8062	I	History 7	-				
8063	I	State code 7	-	0	255	-	
8064	I	History 8	-				
8065	I	State code 8	-	0	255	-	
8066	I	History 9	-				
8067	I	State code 9	-	0	255	-	
8068	I	History 10	-				
8069	I	State code 10	-	0	255	-	
8070	O	Reset history No Yes	No				
Diagnostics cascade							
8100	I	Priority/state source 1...16	-	0	16		
8102							
8130							
8101	I	[Status producer 1...16]					
8103		Missing Faulty Manual control active Heat generation lock active Chimney sweep funct active Temporarily unavailable					
8131		Outside temp limit active Not released Released Released, cooling Released, passive cooling					
ACS	I	Priority cooling source 1... 16	-	0	16		
8138	I	Cascade flow temp	-	0	140	°C	
8139	I	Cascade flow temp setp	-	0	140	°C	
8140	I	Cascade return temp	-	0	140	°C	
8141	I	Cascade return temp setp	-	0	140	°C	
8144	I	Cooling casc flow temp	-	0	140	°C	
8145	I	Cooling casc flow temp setp	-	0	140	°C	
8150	I	Source seq ch'over current	-	0	990	h	
8155	I	Source seq ch'ov cool, curr	-	0	990	h	
ACS	F	State cascade pump (Q25)	-	Off	On		
ACS	F	Switching sequence actual	-	0	16	-	
ACS	F	Number of cooling sources	-	0	16	-	

Operating line	Op. level	Function	Default value	Min.	Max.	Unit	Green leaf
ACS	F	Number of sources with active cooling	-	0	16	-	
ACS	F	Number of sources with passive cooling	-	0	16	-	
ACS	F	Number of cooling sources with optimum energy	-	0	16	-	
ACS	F	Common cooling	-	0	2	-	
Diagnostics heat generation							
Heat pump brine-water-air							
8395	I	Heat delivered	-	0	999.9	kW	
8396	I	Heat draw source	-	0	999.9	kW	
8397	I	Power consumption	-	0	999.9	kW	
8398	I	Coefficient of performance	-	0	20		
8400	I	Compressor 1	-	Off	On	-	
8401	I	Compressor 2	-	Off	On	-	
8402	I	El imm heater 1 flow	-	Off	On	-	
8403	I	El imm heater 2 flow	-	Off	On	-	
8404	I	Source pump	-	Off	On	-	
8405	F	Speed of source pump	-	0	100	%	
8406	I	Condenser pump	-	Off	On	-	
8407	F	Speed condenser pump	-	0	100	%	
8408	I	Diverting valve cool source	-	Off	On	-	
8410	E	Return temp HP	-	0	140	°C	
8411	E	Setpoint HP	-	0	140	°C	
8412	E	Flow temp HP	-	0	140	°C	
8413	F	Compressor modulation	-	0	100	%	
8415	I	Hot-gas temp 1	-	0	180	°C	
8417	I	Hot-gas temp 2	-	0	180	°C	
8420	I	Refrig temp liquid	-	0	140	°C	
8423	F	Condensation temp	-	-50	180	°C	
8423	F	Condensation pressure	-	-1	50	bar	
8425	I	Temp diff condenser	-	-50	140	°C	
8426	I	Temp diff evaporator	-	-50	140	°C	
8427	I	Source inlet temp	-	-50	50	°C	
8427	I	Switch-off threshold	-	-50	50	°C	
8428	I	Source inlet temp min	-	-50	350	°C	
8429	I	Source outlet temp	-	-50	50	°C	
8429	I	Switch-off threshold	-	-50	50	°C	
8430	I	Source outlet temp min	-	-50	350	°C	
8431	I	Source int circ flow temp	-	-50	50	°C	
8432	I	Source int circ return temp	-	-50	50	°C	
8434	F	Suction gas temp	-	-50	180	°C	
8435	F	Evaporation temp	-	-50	180	°C	
8435	F	Evaporation pressure	-	-1	50	bar	
8436	F	Superheat	-	-10	180	°C	
8436	F	Superheat setpoint	-	0	140	°C	
8437	F	Expansion valve	-	0	100	%	
8438	F	Magnetic valve	-	Off	On		
8440	I	Remain stage 1 off time min	-	(0) 1	255	min	
8441	I	Remain stage 2 off time min	-	(0) 1	255	min	
8442	I	Remain stage 1 on time min	-	(0) 1	255	min	
8443	I	Remain stage 2 on time min	-	(0) 1	255	min	

Operating line	Op. level	Function	Default value	Min.	Max.	Unit	Green leaf
8444	I	Remain limit source temp	-	(0) 00:01	24:00	hh:mm	
8446	I	Compressor sequence 1 - 2 2 - 1	-				
8448	F	Optg hours ext evap temp	-	0	199'999	h	
8449	F	Operating hours refrig circ	-	0	199'999	h	
8450	F	Hours run compressor 1	-	0	199'999	h	
8451	F	Start counter compressor 1	-	0	199'999	-	
8452	F	Hours run compressor 2	-	0	199'999	h	
8453	F	Start counter compressor 2	-	0	199'999	-	
8454	F	Locking time HP	-	0	199'999	h	
8455	F	Counter number of locks HP	-	0	199'999	-	
8456	F	Hours run el flow	-	0	199'999	h	
8457	F	Start counter el flow	-	0	199'999	-	
8458	I	State smart grid Draw disabled Draw free Draw wish Draw forced	-				
8460	I	Heat pump throughput	-	0	65535	l/min	
8461	I	Source throughput	-	0	65535	l/min	
8462	F	Suction gas temp EVI	-	-50	180	°C	
8463	F	Evaporation temp EVI	-	-50	180	°C	
8463	F	Evaporation pressure EVI	-	-1	50	bar	
8464	F	Superheat EVI	-	-10	180	°C	
8464	F	Superheat setpoint EVI	-	0	140	°C	
8465	F	Expansion valve EVI	-	0	100	%	
8466	F	Magnetic valve EVI	-	Off	On		
8467	F	Magn valve injection cap	-	Off	On		
Air-to-water heat pump							
8469	F	Fan speed	-	0	100	%	
8470	I	Fan	-	Off	On	-	
8471	I	Process revers valve	-	Off	On	-	
8475	I	Evaporator temp	-	-50	50	°C	
8477	I	Temp diff defrost act value	-	-50	50	°C	
8478	I	Temp diff defrost setpoint	-	-50	50	°C	
8480	I	Remain time defrost lock	-	0	255	min	
8481	I	Remain time forced defrost	-	00:00	07:00	hh:mm	
8482	O	Remain time defrost settling	-	0	255	min	
8485	I	Number defrost attempts	-	0	10	-	
8487	O	Defrost state HP off,defr release OT off Locked Monitoring ice Preheating for defrost Defrost active Dripping Cooling down evaporator Fault Forced defrost Defrost settling Defrost with fan Defrost with compressor Forced defrost fan Forced defrost compressor Start delay defrost Defrosting with ext heat					
8488	F	Relative humidity air inlet	-	0	100	%	
ACS	F	Zustand Ölsumpfheizung (K40)	-	Off	On		
ACS	F	Drip tray heater K41	-	Off	On		
ACS	F	State of source interm circuit pump (Q81)	-	Off	On		
ACS	F	State of source interm circuit div valve (Y81)	-	Off	On		
ACS	F	State of diverting valve cooling condenser (Y27)	-	Off	On		
ACS	F	State of condenser reversing valve (Y91)	-	Off	On		
ACS	F	State status information heating (K42)	-	Off	On		
ACS	F	State status information cooling (K43)	-	Off	On		
ACS	F	State status information DHW (K44)	-	Off	On		
Solar collector field							

Operating line	Op. level	Function	Default value	Min.	Max.	Unit	Green leaf
8499	F	Collector pump 1	-	Off	On		
8505	F	Speed collector pump 1	-	0	100	%	
8506	F	Speed solar pump ext exch	-	0	100	%	
8507	F	Speed solar pump buffer	-	0	100	%	
8508	F	Speed solar pump swi pool	-	0	100	%	
8510	I	Collector temp 1	-	-28	350	°C	
8511	I	Collector temp 1 max	-	-28	350	°C	
8512	I	Collector temp 1 min	-	-28	350	°C	
8513	I	dT collector 1/DHW	-	-28	350	°C	
8514	I	dT collector 1/buffer	-	-168	350	°C	
8515	I	dT collector 1/swimming pool	-	-168	350	°C	
8519	I	Solar flow temp	-	-28	350	°C	
8520	I	Solar return temp	-	-28	350	°C	
8521	I	Solar throughput	-	0	65535	l/min	
8526	I	24-hour yield solar energy	-	0	999.9	kWh	
8527	I	Total yield solar energy	-	0	9999999.9	kWh	
8530	F	Hours run solar yield	-	0	199'999	h	
8531	F	Hours run collect overtemp	-	0	199'999	h	
8542	F	Collector pump 2	-	Off	On		
8543	F	Speed collector pump 2	-	0	100	%	
8547	I	Collector temp 2	-	-28	350	°C	
8548	I	Collector temp 2 max	-	-28	350	°C	
8549	I	Collector temp 2 min	-	-28	350	°C	
8550	I	dT collector 2/DHW	-	-168	350	°C	
8551	I	dT collector 2/buffer	-	-168	350	°C	
8552	I	dT collector 2/swimming pool	-	-168	350	°C	
ACS	F	Status solar pump ext. Exchanger K9	-	Off	On		
ACS	F	Status solar actuator buffer (K8)	-	Off	On		
ACS	F	Status solar actuator pool (K18)	-	Off	On		
Solid fuel boiler							
8560	I	Solid fuel boiler temp	-	0	140	°C	
8561	I	Solid fuel boiler setpoint	-	0	140	°C	
8563	I	Solid fuel boiler return temp	-	0	140	°C	
8564	I	Solid fuel boiler return setp	-	0	140	°C	
8565	F	Flue gas temp	-	0	350	°C	
8567	F	Flue gas temp max	-	0	350	°C	
8568	F	Speed solid fuel boiler pump	-	0	100	%	
8570	E	Hours run solid fuel boiler	-	0	199'999	h	
ACS	F	Status Solid fuel boiler pump (Q10)	-	Off	On		
ACS	F	Solid fuel boiler mixing valve opens (Y9)	-	Off	On		
ACS	F	Solid fuel boiler mixing valve closes (Y10)	-	Off	On		
Supplementary generator							
8585	F	Control temperature	-	0	140	°C	
8586	F	Suppl source setpoint	-	0	140	°C	
8590	F	Hours run suppl source	-	0	199,999	h	
ACS	F	Status heat demand (K27)	-	Off	On		
ACS	F	State suppl source control (K32)	-	Off	On		

Operating line	Op. level	Function	Default value	Min.	Max.	Unit	Green leaf
Diagnostics consumers							
Meteo							
8700	E	Outside temp	-	-50	50	°C	
8701	E	Outside temp min	-	-50	50	°C	
8702	E	Outside temp max	-	-50	50	°C	
8703	I	Outside temp attenuated	-	-50	50	°C	
8704	I	Outside temp composite	-	-50	50	°C	
Dehumidifier							
8723	I	Relative air humidity	-	0	100	%	
ACS	F	State air dehumidifier (K29)		Off	On		
Zone 1							
8730	I	Heating circuit pump 1	-	Off	On		
8731	I	Heat circ mix valve 1 open	-	Off	On		
8732	I	Heat circ mix valve 1 close	-	Off	On		
8735	F	Speed heating circuit pump 1	-	0	100	%	
8739	E	Relative room humidity 1	-	0	100	%	
8740	E	Room temp 1	-	0	50	°C	
8741	E	Room setpoint 1	-	4	35	°C	
8742	O	Room temp 1 model	-	0	50	°C	
8743	E	Flow temp 1	-	0	140	°C	
8744	E	Flow temp setpoint 1	-	0	140	°C	
8747	E	Dewpoint temp 1	-	0	50	°C	
8749	E	Room thermostat 1	-	No demand	Demand		
8751	I	Cooling circuit pump 1	-	Off	On		
8752	I	Cool circ mix valve 1 open	-	Off	On		
8753	I	Cool circ mix valve 1 close	-	Off	On		
8754	I	Diverting valve cooling 1	-	Off	On		
8756	E	Flow temp cooling 1	-	0	140	°C	
8757	E	Flow temp setp cooling 1	-	0	140	°C	
ACS	F	State 2nd speed heating circuit pump (Q21)	-	Off	On		
ACS	F	Operating mode changeover zone 1	-	Inactive	Active		
Zone 2							
8760	I	Heating circuit pump 2	-	Off	On		
8761	I	Heat circ mix valve 2 open	-	Off	On		
8762	I	Heat circ mix valve 2 close	-	Off	On		
8765	F	Speed heating circuit pump 2	-	0	100	%	
8769	E	Relative room humidity 2	-	0	100	%	
8770	E	Room temp 2	-	0	50	°C	
8771	E	Room setpoint 2	-	4	35	°C	
8772	O	Room temp 2 model	-	0	50	°C	
8773	E	Flow temp 2	-	0	140	°C	
8774	E	Flow temp setpoint 2	-	0	140	°C	
8777	E	Dewpoint temp 2	-	0	50	°C	
8779	E	Room thermostat 2	-	No demand	Demand		
8781	I	Cooling circuit pump 2	-	Off	On		
8782	I	Cool circ mix valve 2 open	-	Off	On		
8783	I	Cool circ mix valve 2 close	-	Off	On		
8784	I	Diverting valve cooling 2	-	Off	On		
8786	E	Flow temp cooling 2	0	0	140	°C	

Operating line	Op. level	Function	Default value	Min.	Max.	Unit	Green leaf
8787	E	Flow temp setp cooling 2	0	0	140	°C	
ACS	F	State 2nd speed heating circuit pump (Q22)	-	Off	On		
ACS	F	Operating mode changeover zone 2	-	Inactive	Active		
Zone 3							
8790	I	Heating circuit pump 3	-	Off	On		
8791	I	HC mixing valve 3 open	-	Off	On		
8792	I	HC mixing valve 3 closed	-	Off	On		
8795	F	Speed heating circuit pump 3	-	0	100	%	
8799	E	Relative room humidity 3	-	0	100	%	
8800	E	Room temp 3	-	0	50	°C	
8801	E	Room setpoint 3	-	4	35	°C	
8802	O	Room temp 3 model	-	0	50	°C	
8803	E	Flow temp setpoint 3	-	0	140	°C	
8804	E	Flow temp 3	-	0	140	°C	
8807	E	Dewpoint temp 3	-	0	50	°C	
8809	E	Room thermostat 3	-	No demand	Demand		
8811	F	Cooling circuit pump 3	-	Off	On		
8812	F	Cool circ mix valve 3 open	-	Off	On		
8813	F	Cool circ mix valve 3 close	-	Off	On		
8814	F	Diverting valve cooling 3	-	Off	On		
8816	E	Flow temp cooling 3	0	0	140	°C	
8817	E	Flow temp setp cooling 3	0	0	140	°C	
ACS	F	Stat 2nd speed heating circuit pump (Q23)	-	Off	On		
ACS	F	Operating mode changeover zone 3	-	Inactive	Active		
DHW							
8820	I	DHW pump	-	Off	On		
8821	I	El imm heater DHW	-	Off	On		
8825	F	Speed DHW pump	-	0	100	%	
8826	F	Speed DHW interm circ pump	-	0	100	%	
8827	F	Speed inst DHW heater pump	-	0	100	%	
8830	E	DHW temp 1	-	0	140	°C	
8831	E	DHW temp setpoint	-	8	80	°C	
8832	I	DHW temp 2	-	0	140	°C	
8835	I	DHW circulation temp	-	0	140	°C	
8836	I	DHW charging temp	-	0	140	°C	
8837	I	DHW charging setpoint	-	0	100	°C	
8840	F	Hours run DHW pump	-	0	199'999	h	
8841	F	Start counter DHW pump	-	0	199'999	-	
8842	F	Hours run el DHW	-	0	199'999	h	
8843	F	Start counter el DHW	-	0	199'999	-	
8850	I	DHW primary controller temp	-	0	140	°C	
8851	I	DHW primary controller setp	-	0	140	°C	
8852	I	DHW consumption temp	-	0	140	°C	
8853	I	Instant WH setpoint	-	0	140	°C	
ACS	F	State DHW circulating pump (Q4)	-	Off	On		
ACS	F	State of DHW precontr mix valve Open (Y31)	-	Off	On		
ACS	F	State of DHW precontr mix valve Closed (Y32)	-	Off	On		
ACS	F	Status instantaneous heater pump (Q34)	-	Off	On		
ACS	F	Status instantaneous heater opens (Y33)	-	Off	On		

Operating line	Op. level	Function	Default value	Min.	Max.	Unit	Green leaf
ACS	F	Status instantaneous heater closes (Y34)	-	Off	On		
ACS	F	State storage transfer pump (Q11)	-	Off	On		
ACS	F	State DHW stirring pump (Q35)	-	Off	On		
ACS	F	DHW intermediate circuit pump (Q33)	-	Off	On		
ACS	F	Zustand TWW-Zwischenkreismischer Auf (Y37)	-	Off	On		
ACS	F	Zustand TWW-Zwischenkreismischer Zu (Y38)	-	Off	On		
ACS	F	State DHW Heatpump (K33)	-	Off	On		
ACS	F	Operating mode changeover DHW	-	Off	On		
ACS	F	Flowswitch	-	Off	On		
Consumer circuits							
8875	I	Flow temp setp VK1	-	0	130	°C	
8885	I	Flow temp setp VK2	-	0	130	°C	
ACS	F	State CC1 pump (Q15)	-	Off	On		
ACS	F	State CC2 pump (Q18)	-	Off	On		
Swimming pool							
8895	I	Flow temp setp swimming pool	-	0	130	°C	
8900	I	Swimming pool temp	-	0	140	°C	
8901	I	Swimming pool setpoint	-	8	80	°C	
ACS	F	Swimming pool pump (Q19)	-	Off	On		
Primary controller/system pump							
8930	I	Primary controller temp	-	0	140	°C	
8931	I	Primary controller setpoint	-	0	140	°C	
ACS	F	Status primary pump (Q14)	-	Off	On		
ACS	F	Status precontroller mixing valve opens (Y19)	-	Off	On		
ACS	F	Status precontroller mixing valve closes (Y20)	-	Off	On		
ACS	F	Status primary pump 2 (Q44)	-	Off	On		
Preheating/precooling outside air (ventilation 1...3)							
8932	F	Outside air temp	-	-50.0	50.0	°C	
ACS	I	State of outside air temp control (Q17)					
8935	F	Indoor air quality 1	-	0	2000	ppm	
8937	I	Ventilation stage 1 Off Stage 1 Stage 2 Stage 3	-				
ACS	I	State of ventilation fan 1 (K51)	-	Off	On		
ACS	I	State of ventilation bypass 1 (K54)	-	Off	On		
ACS	I	Room temp setpoint air cooling 1	20	4	35	°C	
8940	F	Indoor air quality 2	-	0	2000	ppm	
8942	I	Ventilation stage 2 Off Stage 1 Stage 2 Stage 3	-				
ACS	I	State of ventilation fan 2 (K52)	-	Off	On		
ACS	I	State of ventilation bypass 2 (K55)	-	Off	On		
ACS	I	Room temp setpoint air cooling 2	20	4	35	°C	
8945	F	Indoor air quality 3	-	0	2000	ppm	
8947	I	Ventilation stage 3 Off Stage 1 Stage 2 Stage 3	-				
ACS	I	State of ventilation fan 3 (K53)	-	Off	On		
ACS	I	State of ventilation bypass 3 (K56)	-	Off	On		
ACS	I	Room temp setpoint air cooling 3	20	4	35	°C	
Common flow values							
8950	I	Common flow temp	-	0	140	°C	
8951	I	Common flow temp setpoint	-	0	140	°C	

Operating line	Op. level	Function	Default value	Min.	Max.	Unit	Green leaf
8952	I	Common return temp	-	0	140	°C	
8956	I	Common flow temp 2	-	0	140	°C	
8957	I	Common flow setp refriger	-	0	140	°C	
ACS	F	Status heat demand (K27)	-	Off	On		
ACS	F	Status cool demand (K28)	-	Off	On		
ACS	F	State of diverting valve cooling, flow (Y29)	-	Off	On		
Buffer storage tank							
8970	I	El imm heater buffer	-	Off	On		
8980	E	Buffer temp 1	-	0	140	°C	
8981	I	Buffer setpoint	-	0	140	°C	
8982	E	Buffer temp 2	-	0	140	°C	
8983	I	Buffer temp 3	-	0	140	°C	
8990	F	Hours run el buffer	-	0	199'999	h	
8991	F	Start counter el buffer	-	0	199'999	-	
ACS	F	Output heat generation lock (Y4)	-	Off	On		
Inputs H							
9005	I	Water pressure 1	-	-1	50	bar	
9006	I	Water pressure 2	-	-1	50	bar	
9009	I	Water pressure 3	-	-1	50	bar	
9010	I	Measurement room temp 1	-	0	50	°C	
9011	I	Measurement room temp 2	-	0	50	°C	
9012	I	Measurement room temp 3	-	0	50	°C	
9016	I	Special temp 1	-	0	140	°C	
9017	I	Special temp 2	-	0	140	°C	
9018	I	Special temp 3	-	0	140	°C	
9019	I	Special temp 4	-	0	140	°C	
9020	I	Special temp 5	-	0	140	°C	
9021	I	Special temp 6	-	0	140	°C	
9022	I	Special temp 7	-	0	140	°C	
9023	I	Special temp 8	-	0	140	°C	
States of relays/triac QX/ZX							
9031	I	Relay output QX1	-	Off	On		
9032	I	Relay output QX2	-	Off	On		
9033	I	Relay output QX3	-	Off	On		
9034	I	Triac output ZX4	-	Off	On		
9035	I	Relay output QX5	-	Off	On		
9036	I	Relay output QX6	-	Off	On		
9037	I	Relay output QX7	-	Off	On		
9038	I	Relay output QX8	-	Off	On		
9039	I	Relay output QX9	-	Off	On		
9040	I	Relay output QX10	-	Off	On		
9041	I	Relay output QX11	-	Off	On		
9042	I	Relay output QX12	-	Off	On		
9043	I	Relay output QX13	-	Off	On		
9050	I	Relay output QX21 module 1	-	Off	On		
9051	I	Relay output QX22 module 1	-	Off	On		
9052	I	Relay output QX23 module 1	-	Off	On		
9053	I	Relay output QX21 module 2	-	Off	On		
9054	I	Relay output QX22 module 2	-	Off	On		

Operating line	Op. level	Function	Default value	Min.	Max.	Unit	Green leaf
9055	I	Relay output QX23 module 2	-	Off	On		
9056	I	Relay output QX21 module 3	-	Off	On		
9057	I	Relay output QX22 module 3	-	Off	On		
9058	I	Relay output QX23 module 3	-	Off	On		
ACS	F	State alarm relay (K10)	-	Off	On		
ACS	F	Status time program 5 relais (K13)	-	Off	On		
ACS	F	Status delta-T controller 1 K21	-	Off	On		
ACS	F	Status delta-T controller 2 K22	-	Off	On		

6 The settings in detail

6.1 Time programs

For the heating/cooling circuits, ventilation, and DHW heating, a number of switching programs are available. They are activated in Automatic mode and control the change of temperature levels (and the respective setpoints) via the set switching times.

Entering the switching times

The switching times can be set in a combined way, either jointly for several days, or separately for individual days. When preselecting groups of days like for instance Mo...Fr and Sa...Su that shall use the same switching times, the setting of switching programs is simplified.

Switching points

Line no.								Operating line
CC1	CC2	CC3	HC1	HC2	HC3	4 / DHW	5	
470	480	490	500	520	540	560	600	Preselection Mo – Su Mo – Fr Sa – Su Mo ... Su
471	481	491	501	521	541	561	601	1st phase on
472	482	492	502	522	542	562	602	1st phase off
473	483	493	503	523	543	563	603	2nd phase on
474	484	494	504	524	544	564	604	2nd phase off
475	485	495	505	525	545	565	605	3rd phase on
476	486	496	506	526	546	566	606	3rd phase off

Line no.				Operating line
L1	L2	L3		
580	590	620		Preselection Mo – Su Mo – Fr Sa – Su Mo ... Su
581	591	621		1st phase on
582	592	622		1st phase off
583	593	623		2nd phase on
584	594	624		2nd phase off
585	595	625		3rd phase on
586	596	626		3rd phase off

Tip: Time programs 1...3

If the space is not used for certain periods of time during the day, the room temperature setpoint can be lowered (heating) or raised (cooling) for the time of absence via these time programs.

Tip: Time programs L1...L3

Time programs L1...L3 can also achieve additional energy savings in ventilation mode during absences. The ventilation modes are switched as per the time switch program if the operating mode (OL 970) is set to **Auto**

Tip: Time programs 4...5

These time programs are used for a number of functions (e.g. electricity night tariff or "Legionella" function) and should therefore be correctly set.



For time programs, this means:

- "Phase on" = "Comfort mode"
- "Phase off" = "Reduced mode".

Standard program

Line no.								Operating line
CC1	CC2	CC3	HC1	HC2	HC3	4 /DHW	5	
479	489	499	516	536	556	576	616	Default values No Yes

Line no.					Operating line
L1	L2	L3			
589	599	629			Default values No Yes

All time programs can be reset to their factory settings. Each time program has its own operating line to make this reset.



Individual settings will be lost in that case.

6.2 Holidays

Operating line			
HC/CC1	HC/CC2	HC3	
641	651	661	Preselection Period 1...8
642	652	662	Start
643	653	663	End
648	658	668	Operating level Protection Reduced

The holiday program is used to switch zones (heating/cooling circuits and ventilation) to a selectable operating level according to calendar dates. A total of 8 independent holiday periods can be set.



Important note:

The holiday program can only be used in Automatic mode.



Tip

During longer periods of absence (e.g. more than 3 days), energy can be saved by lowering the temperature level for heating and raising it for cooling. Also, for annually recurring special days (e.g. bank holidays), a specific operating mode can be selected.

Ventilation in holiday mode

During holiday periods, ventilation is operated in a special interval mode (off/on). The ventilation state for "on" mode corresponds to the selected operating level. The ventilation stage for protection or reduced level can be parameterized (OL 991 and 992, off/stage 1...3). The interval can be set via ACS (see Section Holiday mode in Section "Ventilation" 6.5)

6.3 Heating circuits

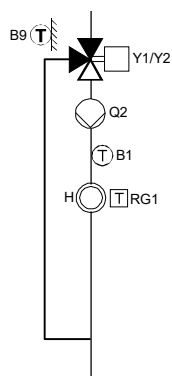

A number of functions are available for the heating circuits which can be individually set for each heating circuit.

Operating mode

Line no.			Operating line
HC1	HC2	HC3	
700	1000	1300	Operating mode Protection Automatic Reduced Comfort

Protection

In Protection mode, the heating system is off. However, the room remains protected against frost (Frost protection setpoint, line 714).

Characteristics of Protection mode:

- Heating mode off.
- Temperature according to the "Frost protection setpoint" (line 714).
- "Eco" functions active.

Automatic

In Automatic mode, the room temperature is controlled according to the selected time program.

Characteristics of Automatic mode:

- Heating mode according to the time program
- Temperature setpoints according to heating program "Comfort setpoint" (line 710) or "Reduced setpoint" (line 712)
- "Eco" functions active
- Operating level changeover via presence button

Tip

Many of the integrated energy saving functions, such as the time and holiday programs or summer/winter changeover, are active when Automatic mode is selected.

Reduced

In Reduced mode, the room temperature is maintained at the set "Reduced setpoint" (line 712).

Characteristics of Reduced mode:

- Heating mode without time program
- "Eco" functions active

Comfort

In Comfort mode, the room temperature is maintained at the set "Comfort setpoint" (line 710).

Characteristics of Comfort mode:

- Heating mode without time program
- "Eco" functions are **not** active

Presence button

In automatic mode, the temperature level is changed over based on the time programs.

The presence button can be used to manually changeover between comfort and reduced setpoint, if another temperature level is desired for a temporary period.

The changeover continues until the next switching point or until the next time the presence button is activated.

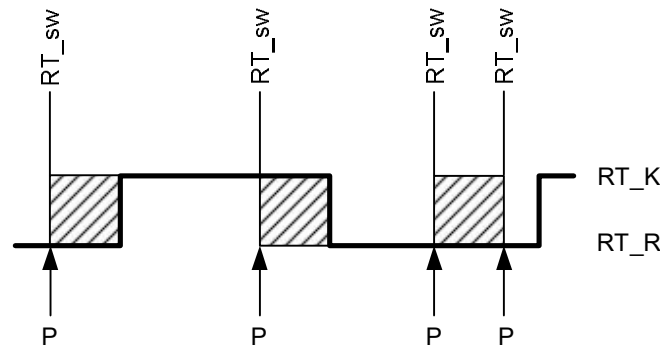

P	Pressure to presence button
RT_sw	Operating level changeover
RT_K	Comfort setpoint
RT_R	Reduced setpoint



The function is only available for use on operator units with presence buttons (normally room units).

Warmer/cooler function

The room temperature can be temporary set to warmer or cooler for each living zone using room units QAA74 and operator units (HMI) AVS74.

The setting is only temporary. It cannot permanently influence any parameters.

Initiate function

The warmer/cooling function is initiated on the temperate side 🌡️ of the unit using the push and roll knob.

Three settings are available:

Cooler Starts the cooler function

..... Neutral position (control by operating mode)

Warmer Starts the warmer function

QAA74 / AVS74

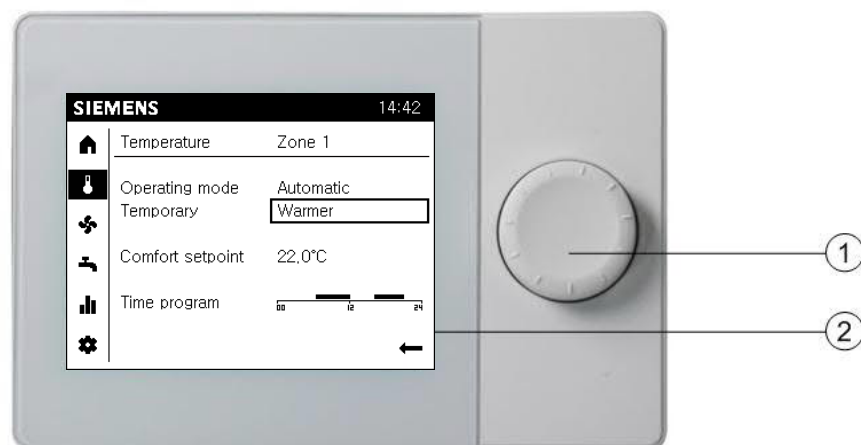

① Push and roll knob

② Display with temperature page

Additional information on operating room unit QAA74 and operator unit (HMI) AVS74 is available in technical guide CE1U2348en.

Impact in heating mode

Warmer function

Initiated during the comfort phase

The room setpoint is increased by 1K and at least 1K above the room actual value, or the room model value.

Initiated during the reduced phase

The room setpoint is set to the comfort setpoint and at least 1K above the room actual value, or room model value.

Cooler function

The room setpoint is reduced by 1K and at least 1K below the room actual value, or the room model value.

ECO functions are temporarily deactivated as needed.

Ending the function

The function ends automatically at the next operating level changeover by time switch program or at midnight, at the earliest, however, after 2 hours (function time).

End through operator intervention

The warmer/cooler function can be ended manually by returning the settings "warmer" or "cooler" to the neutral position "....".

Manually changing the operating mode also ends the function.

Setpoints

Line no.			Operating line
HC1	HC2	HC3	
710	1010	1310	Comfort setpoint
712	1012	1312	Reduced setpoint
714	1014	1314	Protection setpoint
716	1016	1316	Comfort setpoint max

Room temperature

The different setpoint setting ranges are interlocked, which means that the next lower setpoint cannot be higher than the next higher, and vice versa. The individual setpoints required for each heating circuit can be adjusted.

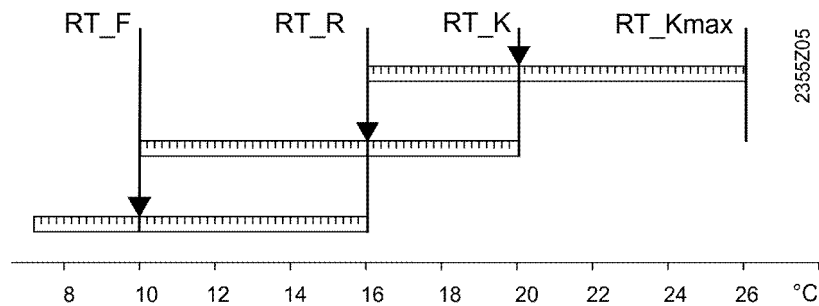

RT_Kmax Comfort setpoint max
 RT_K Comfort setpoint
 RT_R Reduced setpoint
 RT_F Protection setpoint

Comfort setpoint The "Comfort" setpoint is the room temperature setpoint for normal room usage (e.g. during the day). It is the setpoint used when the plant operates in Automatic mode (during the Comfort phase) and in Comfort mode.

 **Tip** The setpoint recommended for heating in terms of comfort and energy efficiency lies typically between 20 and 22 °C.

Reduced setpoint The "Reduced" setpoint is the room temperature setpoint for reduced room usage (e.g. during the night or when absent for several hours). It is used as the setpoint when the plant operates in Automatic mode (during the Reduced phase) and in Reduced mode.

 **Tip** The "Reduced setpoint" can be adapted, depending on the type of heating system and the type of building structure. If the selected "Reduced" setpoint is lower, it takes more time for the room temperature to reach the Comfort level.

Protection setpoint The protection setpoint is the room temperature setpoint for the periods of time when the room is not occupied (e.g. during holidays), but protection from extremely low temperatures shall be provided for the hydraulic system or animals and plants, antiquities, etc.
It is used as the setpoint when the plant operates in Protection mode.

Comfort setpoint max "Comfort setpoint max" ensures maximum limitation of the adjustable "Comfort" setpoint. The "Comfort" setpoint cannot be set to a level higher than the level defined here.

Heating curve

Line no.			Operating line
HC1	HC2	HC3	
720	1020	1320	Heating curve slope
721	1021	1321	Heating curve displacement
726	1026	1326	Heating curve adaption

The set heating curve ensures that the flow temperature setpoint changes depending on the outside temperature.

When setting the heating curve, consideration can be given to the type of building structure (thermal insulation) and the type of plant.

The slope of the heating curve and the absolute temperature level of the flow temperature setpoints (parallel displacement) can be set.

 **Tip** The heating curve is correctly set when the desired room temperature is maintained throughout the entire heating season despite changes to outdoor temperatures.

We recommend changing the curve only once a day and then in small increments.

Heating curve slope Great differences in the slope lead to great flow temperature changes at low outside temperatures.
If the room temperature only deviates at low outside temperatures, the slope must be readjusted.

Increase the value Raises the flow temperature, especially at low outside temperatures.

Decrease the value Lowers the flow temperature, especially at low outside temperatures.



The adjusted heating curve is based on a room temperature setpoint of 20 °C. If the room temperature setpoint is changed, the heating curve adjusts itself automatically.

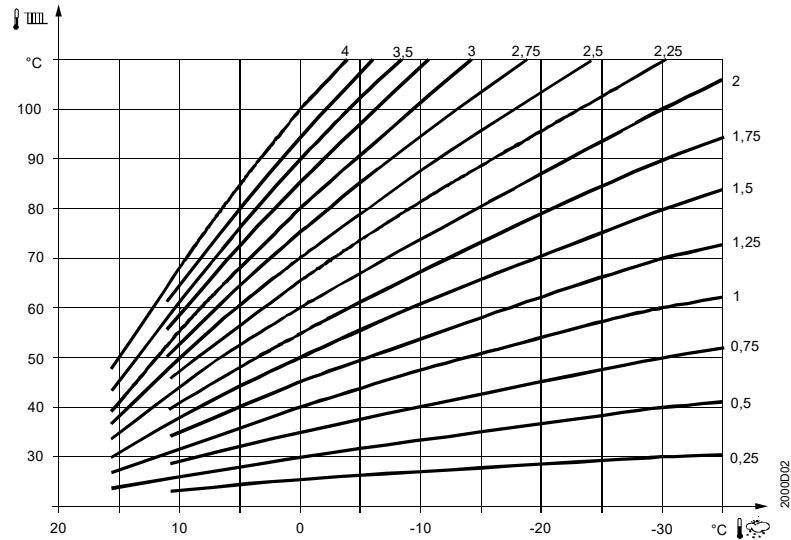

Heating curve displacement

A parallel displacement of the heating curve produces a general change of the flow temperature, uniformly across the whole outside temperature range.

If the room temperature is always too high or too low, it is recommended to make use of the parallel displacement.

Heating curve adaption

Function "Heating curve adaption" is used by the controller to **automatically** adapt the heating curve to the type of building structure.

NOTE	<p>To assure this function, following must be observed:</p> <ul style="list-style-type: none"> • A room sensor must be connected • "Room influence" must be set to a value between 1 and 99 • There should be no thermostatic radiator valves in the reference room (location of room sensor); if such valves are installed, they must be fully opened
-------------	---

"Eco" functions

Line no.			Operating line
HC1	HC2	HC3	
730	1030	1330	Summer/winter heating limit
732	1032	1332	24-hour heating limit
733	1033	1333	Ext'n 24-hour heating limit
			No Yes

Summer/winter heating limit

If the attenuated outside temperature exceeds the "Summer/winter heating limit" (e.g. in spring), the heating system is shut down. If the attenuated outside temperature drops (e.g. in autumn), the heating is switched on only when the temperature reaches a level of 1 Kelvin below the limit temperature.

Increase

- Change from winter to summer operation will be later
- Change from summer to winter operation will be earlier

Decrease

- Change from winter to summer operation will be earlier
- Change from summer to winter operation will be later

Example

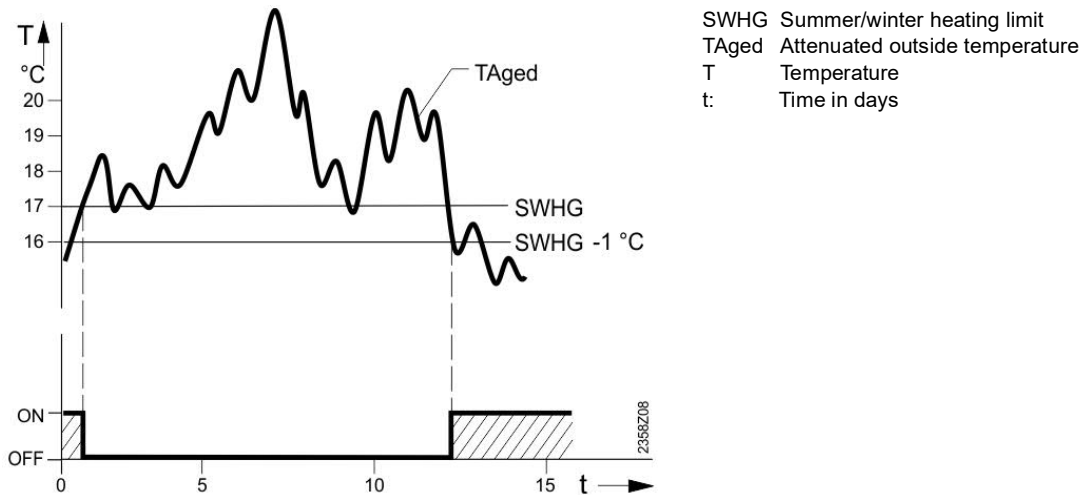

- The function is not active in Comfort mode.
- For definition of "attenuated outside temperature", refer to parameter 8703.

Tip

Summer operation means that space heating is no longer used/required and cooling mode is possible (if installed).

24-hour heating limit

Parameter setting "24-hour heating limit" produces a limit temperature. If the outside temperature exceeds this limit, the heating system is shut down in the course of the day.

If, in the course of the day, the outside temperature drops again, the heating system is switched on again only when the outside temperature reaches a level of 1 Kelvin below the limit temperature.

Parameter "24-hour heating limit" itself is a temperature differential. The value is subtracted from (negative value) or added to (positive value) the room temperature setpoint.

Example

Operating line	E.g.
Automatic mode, Comfort setpoint	22 °C
24-hour heating limit	-3 K
Limit temperature "Heating off"	= 19 °C
Switching differential (fixed)	-1 K
Limit temperature "Heating on"	= 18 °C



- The function is not active in Comfort mode
- Function "24-hour heating limit" operates with the current outside temperature

Ext'n 24-hour heating limit

To delay new activations of the heating system in the course of the day, or to make use of the thermal energy stored by the building over a longer period of time, "Ext'n 24-hour heating limit" can be used to extend the off phase.

Ext'n 24-hour heating limit = **No**

The heating system is switched on again when the **current** outside temperature (TA) drops 1 Kelvin below the set differential.

The building dynamics (building structure and insulation) are **not** taken into consideration.

Ext'n 24-hour heating limit = **Yes**

The heating system is switched on again when the **composite** outside temperature (TAgem) drops 1 Kelvin below the set differential.

The building dynamics (building structure and insulation) are taken into consideration.



For definition of "composite outside temperature", refer to parameter 8704.

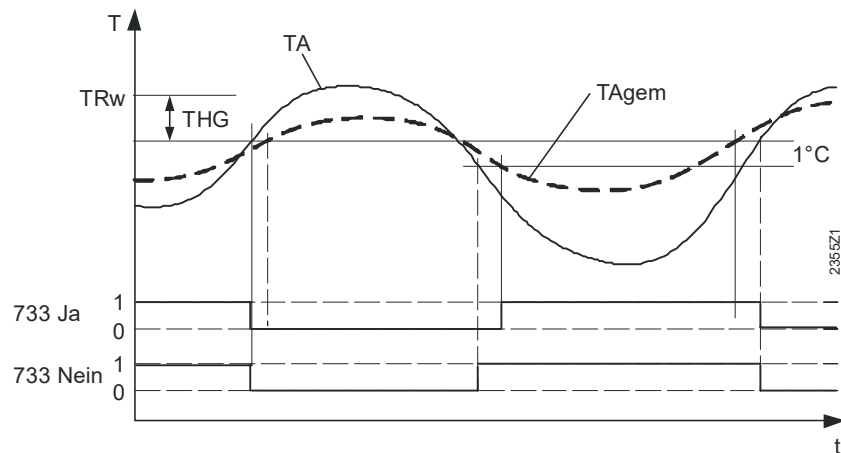

- 733 Selection Yes/No (line 733, 1033, or 1333)
- TRw Room temperature setpoint
- TA Current outside temperature
- TAgem Composite outside temperature
- THG 24-hour heating limit (line 732)
- T Temperature
- t Time
- 1 Heating on
- 0 Heating off

Limitations of flow temperature setpoint

Line no.			Operating line
HC1	HC2	HC3	
740	1040	1340	Flow temp setpoint min
741	1041	1341	Flow temp setpoint max

Flow temp setpoint
min/max

This limitation can be used to select a range for the flow temperature setpoint. If the flow temperature setpoint demanded by the heating circuit reaches the relevant limit and the request for heat increases or decreases, the flow temperature setpoint is maintained at the maximum or minimum limit respectively.

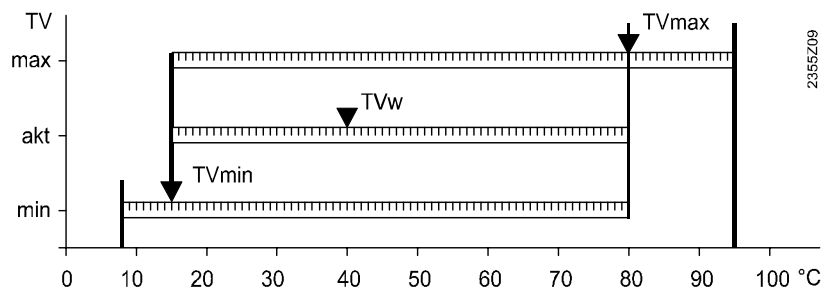

TVw Current flow temperature setpoint
TVmax Flow temp setpoint max
TVmin Flow temp setpoint min

Fixed flow temperature setpoint with adaption

Line no.			Operating line
HC1	HC2	HC3	
742	1042	1342	Flow temp setpoint room stat
744	1044	1344	Swi-on ratio room stat

Flow temp setpoint room
stat

On applications with room thermostat, the heating circuit is switched on only when the room thermostat calls for heat.

A fixed or weather-compensated temperature value is called for, depending on the selected setting:

Selection	Compensation variant
- - -	Temperature request according to the heating curve
8...95 °C	Temperature request according to the set value*

* In "Comfort" mode only – there is no temperature request in other operating modes and the heating circuit remains off



Using one of the Hx inputs, the room thermostat can be connected to the controller, the extension module, or the I/O module.

Swi-on ratio room stat

The function is used for room temperature control with a room thermostat.

If a fixed flow temperature setpoint is parameterized (lines 742, 1042, and 1342), this function can be used to adapt the flow temperature depending on demand.

<i>Selection</i>	<i>Compensation variant</i>
- - -	Setting "- - -" deactivates adaption.
1...99%	Adaption is activated.

The flow temperature is adapted in 2 different ways:

Adaption at midnight

Adaption at midnight adjusts the heat demand for the next day based on the amount of heat that was required the previous day.

This adaption changes the parameterized flow temperature setpoint. The adapted value is stored and retained should a power failure occur.

For the adaption, a preselected on-time ratio of the room thermostat is used as the target value (1...99%). If, during the Comfort phase, the on-time is too long, the setpoint is increased. If the on-time is too short, the setpoint is decreased.

If boost heating has been parameterized, this is taken into account when calculating the required readjustment.

The setpoint is readjusted at midnight.



If, at midnight, the room thermostat is off, the setpoint is readjusted when the thermostat switches on again.

Dynamic readjustment during the Comfort phase

The dynamic readjustment adapts the current demand for heat if the current flow temperature setpoint is too low.

When making the readjustment, the current on-time ratio of the room thermostat is compared with the target value. If, during the Comfort phase, the on-time is too long, the setpoint is increased.



Since an on-time ratio is not yet available when changing to the Comfort level, the setpoint is increased if the room thermostat maintains the on state for more than 2 hours.

To prevent the flow temperature from rising too quickly, the off-time for dynamic readjustments is limited to a minimum of 30 minutes.

Room influence

Line no.			Operating line
HC1	HC2	HC3	
750	1050	1350	Room influence

Compensation variants

When using a room temperature sensor, there is a choice of 3 different types of compensation:

Selection	Compensation variant
- - -	Weather compensation alone*
1...99 %	Weather compensation with room influence*
100 %	Room compensation alone

* Outside sensor mandatory

Weather compensation alone

The flow temperature is calculated via the heating curve, depending on the composite outside temperature.

This compensation variant calls for a correct adjustment of the heating curve because with this setting the control system gives no consideration to the room temperature.

Weather compensation with room influence

The deviation of the current room temperature from the setpoint is acquired and taken into account when controlling the room temperature. Heat gains can thus be considered, facilitating more accurate room temperature control.

The authority of the deviation is set as a percentage value. The better the reference room conditions (correct room temperature, correct mounting location, etc.), the higher the value can be set.

Example

Approx. 60% Good reference room
Approx. 20 % Unfavorable reference room



To provide the function, following must be considered:

- A room sensor must be connected
- "Room influence" must be set to a value between 1 and 99
- There should be no thermostatic radiator valves in the reference room (mounting location of room sensor); if such valves are installed, they must be fully opened

Room compensation alone

The flow temperature is controlled depending on the room temperature setpoint, the current room temperature and its progression.

For example, a slight increase in room temperature leads to an immediate reduction in flow temperature.



To provide the function, following must be considered:

- A room sensor must be connected
- "Room influence" must be set to 100%
- There should be no thermostatic radiator valves in the reference room (mounting location of room sensor); if such valves are installed, they must be fully opened.

Room temperature limitation

Line no.			Operating line
HC1	HC2	HC3	
760	1060	1360	Room temp limitation
761	1061	1361	Heating limit room controller
766	1066	1366	SD room temp limitation

- i** The functions "Room temp limitation" and "SD room temp limitation" are connected. "Heating limit room controller" is a further, independent function.

Room temperature limitation

If the room temperature exceeds its current setpoint by more than "Room temp limitation", the heating circuit pump is deactivated.

The switch-on point for the heating circuit pump is determined by the parameter "SD room temp limitation" (Line 766).

During the time the "Room temp limitation" function is active, no request is sent to the heat source.

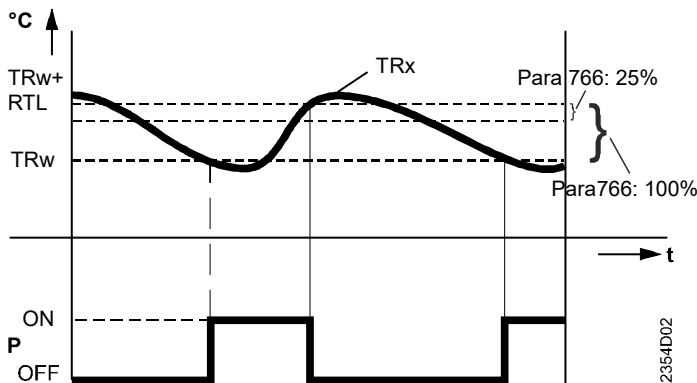

TRx Actual value of room temperature
 TRw Room temperature setpoint, heating
 RTL "Room temp limitation" (para760)
 P Pump
 t Time

- i** Following criteria deactivate the function:
- "Room temp limitation" = "---"
 - Room temperature sensor not present
 - "Room influence" (line 928) = "---" , that is, weather compensation alone

Heating limit room controller

Function switches off the heating circuit pump and invalidates a request of the heating circuit, if the room is warm enough and an outside temperature sensor does not exist.

- i** Only with 'pure room control' ("Room influence" (OL750, ...) = 100%)

The requested flow setpoint becomes invalid if it drops below the minimum flow setpoint and the heating circuit pump switches off.

"Heating limit room controller" [%] can influence the minimum flow setpoint.

It is calculated as follows:

$$\text{Minimum flow setpoint} = (\text{Flow maximum} - \text{room setpoint}) * \text{Heating limit room controller} / 100$$

The flow setpoint request becomes active again once the requested flow setpoint exceeds the minimum flow setpoint by 8%.

The function is switched off

1...100 %

Heating limit in percentages.

- i** The functions daily heating limit and summer-winter changeover can also switch off heating if an outside temperature sensor is available.

SD room temp limitation

A switching differential as a percentage to the "Room temp limitation"(OL760) can be configured for switch on.

The heating pump switches on again if the room temperature drops below the switch-off temperature by the set percentage.

The minimum switching differential is limited to 0.25°C to prevent cycling of the heating pump.

At setting 100%, it switches on again at the present 'Room setpoint heating TRw' (see Graphic at Line 760).

Line no.			Operating line
CC1	CC2	CC3	
762	1062	1362	Prop band Xp room contr
763	1063	1363	Int act time Tn room contr
764	1064	1364	Der act time Tv room contr

Parameters Xp, Tn and Tv

By setting the right proportional band Xp, the integral action time Tn, and the derivative action time Tv the control action can be matched to the type of plant (controlled system).

Xp, Tn and Tv can be determined using common methods, e.g. the step response method depicted in Section "Xp, Tn, Tv – Step response method".

Brochure BT_0098_EN provides additional notes on control technology in buildings.

Boost heating

Line no.			Operating line
HC1	HC2	HC3	
770	1070	1370	Boost heating

Boost heating is used to reach the new setpoint more quickly when switching from the Reduced setpoint to the Comfort setpoint, thus reducing the heating up time.

During boost heating, the room temperature setpoint is raised by the value set here.

Higher settings lead to shorter heat up times, lower settings to longer heat up times.



Boost heating is possible with or without room temperature sensor.

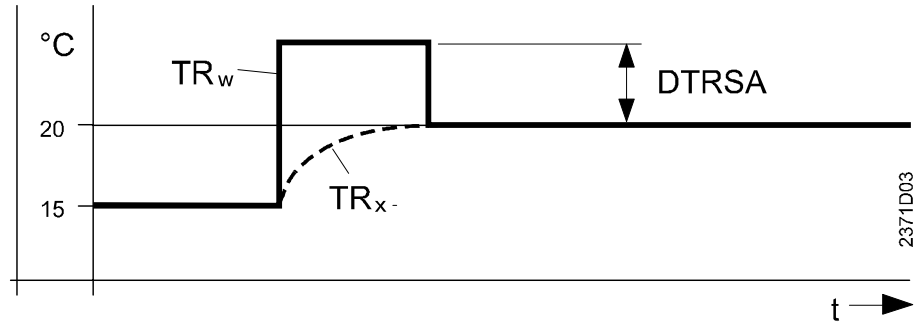

TRw Room temperature setpoint
 TRx Actual value of room temperature
 DTRSA Increase of room temperature setpoint

Quick setback

Line no.			Operating line
HC1	HC2	HC3	
780	1080	1380	Quick setback Off To Reduced setpoint To Protection setpoint

During the "Quick setback" function, the heating circuit pump is deactivated and, in the case of mixing valve circuits, the mixing valve is fully closed.

The temperature level down to which quick setback may take place can be set:

- In any case, only "To Reduced setpoint" or
- When changing to the "Protection setpoint" (line 714), until that level is reached.

Function with room sensor

When using a room sensor, the function ensures that the heating system is kept off until the room temperature drops to the level of the "Reduced" or "Protection setpoint" setpoint.

If the room temperature falls to the reduced or the protection level, the heating circuit pump is activated and the mixing valve released.

Function without room sensor

Quick setback switches the heating system off for a certain period of time, depending on the composite outside temperature and the building time constant.

Example

Duration of quick setback at different composite outside temperatures and building time constants.

- "Comfort" setpoint minus "Reduced setpoint" = 2 Kelvin
e.g. "Comfort setpoint" = 20 °C, "Reduced setpoint" = 18 °C

Composite outside temperature	Building time constant [h]						
	0	2	5	10	15	20	50
	<i>Duration of quick setback [h]</i>						
15 °C	0	3.1	7.7	15.3	23	30.6	76.6
10 °C	0	1.3	3.3	6.7	10	13.4	33.5
5 °C	0	0.9	2.1	4.3	6.4	8.6	21.5
0 °C	0	0.6	1.6	3.2	4.7	6.3	15.8
-5 °C	0	0.5	1.3	2.5	3.8	5.0	12.5
-10 °C	0	0.4	1.0	2.1	3.1	4.1	10.3
-15 °C	0	0.4	0.9	1.8	2.6	3.5	8.8
-20 °C	0	0.3	0.8	1.5	2.3	3.1	7.7

Optimum start/stop control

Line no.			Operating line
HC1	HC2	HC3	
790	1090	1390	Optimum start control max
791	1091	1391	Optimum stop control max
794	1094	1394	Heat up gradient

Optimum start control max

With "Optimum start control", the change from one temperature level to the other is shifted forward such that the "Comfort" setpoint will be reached at the respective switching times.

Setting "Optimum start control max" limits the duration of the forward shift.

Optimum stop control max

With "Optimum stop control", the change from one temperature level to the other is shifted forward such that the "Comfort" setpoint -1/4 Kelvin will be reached at the respective switching times.

Setting "Optimum stop control max" limits the duration of the forward shift.

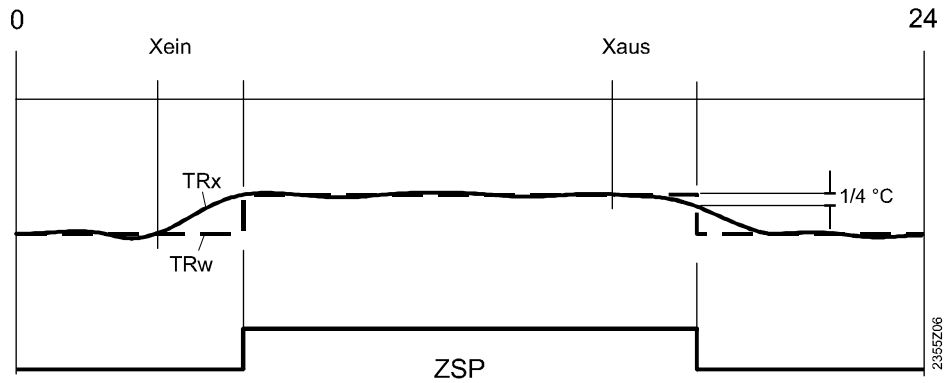

Xein Forward shift of switch-on time
 Xaus Forward shift of switch-off time
 ZSP Time program
 TRx Actual value of room temperature
 TRw Room temperature setpoint

i Optimum start/stop control can be performed with or without room temperature sensor. In that case, optimum start/stop control is calculated with the help of the room model.

Heat up gradient

The heat up gradient defines the period of time the heating system requires to raise the room temperature by 1 Kelvin.

If the room temperature does not reach the "Comfort" setpoint at the respective switching times, the setting must be increased.

- i** The heat up gradient is only active when optimum start control is switched on
- If a room sensor is used, the heat up gradient is set automatically

Increase of "Reduced" setpoint

Line no.			Operating line
HC1	HC2	HC3	
800	1100	1400	Reduced setp increase start
801	1101	1401	Reduced setp increase end

The function is used primarily in connection with heating systems with only little spare capacity (e.g. low-energy houses). In such cases, the heat up time at low outside temperatures would be too long. When the "Reduced" setpoint is increased, the rooms are prevented from cooling down excessively, thus shortening the heat up time when changing to the nominal setpoint.

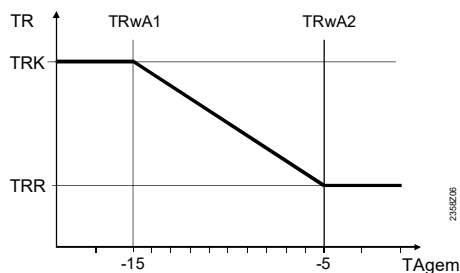

TRwA1 Reduced setp increase end
 TRwA1 Reduced setp increase start
 TRK Comfort setpoint
 TRR Reduced setpoint
 TAgem Composite outside temperature

Frost protection for the plant HC pump

Line no.			Operating line
HC1	HC2	HC3	
810	1110	1410	Frost prot plant HC pump Off On
813	1113	1413	Frost prot room model Off On

Frost prot plant HC pump

When selecting "On", the respective heating circuit pump is put into operation when frost protection for the plant is active (refer to parameter 6120, "Frost protection plant").

Frost prot room model

Frost protection can be triggered via the room model on heating circuits without a room temperature sensor.

The heating circuit remains in operation as long as the calculated room temperature is below the protection setpoint (Line 714, 1014, 1314) until the calculated temperature is once again 1 °C above the protection setpoint.

Overtemperature protection pump heating circuit

Line no.			Operating line
HC1	HC2	HC3	
820	1120	1420	Overtemp prot pump circuit Off On

In the case of heating plants with pump heating circuits, the flow temperature of the heating circuit can be higher than the flow temperature called for by the heating curve, the reason being higher requests from other heat consumers (mixing heating circuit, DHW charging, external heat demand) or a parameterized minimum producer temperature.

As a result of this too high flow temperature, the pump heating circuit would assume excessive temperatures.

By switching the pump on/off, function "Overtemp prot pump circuit" ensures that the heat supply to pump heating circuits corresponds to the demand from the heating curve.

CAUTION

Together with heat pumps, the function may only be activated in plants that use buffer or combi storage tanks. In the case of plants without storage tank, there is a risk of a compressor being in operation without having a consumer pump running.

Control of mixing valve

Line no.			Operating line
HC1	HC2	HC3	
830	1130	1430	Mixing valve boost
832	1132	1432	Actuator type 2-position 3-position
833	1133	1433	Switching differential 2-pos
834	1134	1434	Actuator running time
835	1135	1435	Mixing valve Xp
836	1136	1436	Mixing valve Tn

Mixing valve boost

The controller adds the mixing valve boost set here to the current flow temperature setpoint and uses this value as the setpoint for the heat source.

Actuator type

2-position

The controller uses only one relay output to drive the actuator. When the output delivers a signal, the connected valve opens. When there is no signal, the valve closes automatically.

3-position

The controller uses 2 relay outputs to drive the actuator. One output is used for opening the connected valve, the other for closing it.

Switching differential 2-pos

For a 2-position actuator, "Switching differential 2-pos" might have to be adapted. With 3-position actuators, the switching differential has no impact.

Actuator running time

In the case of 3-position control, the running time of the mixing valve actuator can be adapted. With 2-position control, the actuator running time has no impact.

Control of mixing valve

Parameters Xp and Tn

By setting the right proportional band Xp and integral action time Tn, the control action can be matched to the type of plant (controlled system).

Xp and Tn can be determined using common methods, e.g. the step response method depicted in Section "Xp, Tn, Tv – Step response method".

Brochure BT_0098_EN provides additional notes on control technology in buildings.

"Floor curing" function

Line no.			Operating line
HC1	HC2	HC3	
850	1150	1450	Floor curing function Off Functional heating Curing heating Functional/curing heating Curing/functional heating Manually
851	1151	1451	Floor curing setp manually
856	1156	1456	Floor curing day current
857	1157	1457	Floor curing days completed

The "Floor curing" function ensures controlled drying of the floor. It controls the flow temperature according to a certain temperature profile.

CAUTION	<ul style="list-style-type: none"> Observe the relevant standards and regulations of the company supplying the floor The "Floor curing" function demands a correctly installed plant (hydraulics, electrical installation, settings). If this is not observed, the "Floor curing" function – if activated – can damage the floor
----------------	--



- The function can be aborted prematurely by selecting "Off"
- Maximum limitation of the flow temperature remains active

Floor curing function

Off

The function is deactivated.

Functional heating

The first section of the temperature profile (Fh) is completed automatically.

Curing heating

The second section of the temperature profile (Bh) is completed automatically.

Functional/curing heating

The entire temperature profile completed in the sequence: Fh then Bh section.

Curing/functional heating

The entire temperature profile is completed in the sequence: Bh then Fh section.

Manually

In manual mode, no temperature profile is used. The required flow temperature is set individually for every heating circuit using parameter "Floor curing setp manually".

The function is automatically ended after 25 days.

Floor curing setp manually

The flow temperature setpoint for the "Manual floor curing" function can be set separately for each heating circuit.

NOTE	First, start the "Floor curing function" , then adjust the setpoint manually.
-------------	---



- The start value is 25 °C and can be manually readjusted at any time
- "Floor curing setp manually" can only be adjusted within the 2 limit values "Flow temp setpoint max" (TVMax) and "Flow temp setpoint min" (TVmin)

The function is ended when the functional days (Fh+Bh = 25 days) have elapsed or when the function is deactivated via the respective parameter. The start day (day 0) does not count as a functional day.

Floor curing day current
Floor setpoint current

Displays the current day and the current setpoint of the "Floor curing" function in progress.

Floor curing days completed

The completed number of days are continuously stored and retained until the function is started the next time.
The temperature is regarded maintained if the deviation from the setpoint is less than 2 Kelvin. The periods of time the flow temperature is correct are added up by a meter.
If the required temperature is not reached for more than 1 hour, the meter is stopped until the deviation drops again below 2 Kelvin.



In the event of a power failure, the plant resumes the "Floor curing" function at the point in time the power failure occurred.

Temperature profile

In Automatic modes, the controller ensures automatic completion of the selected temperature profile.

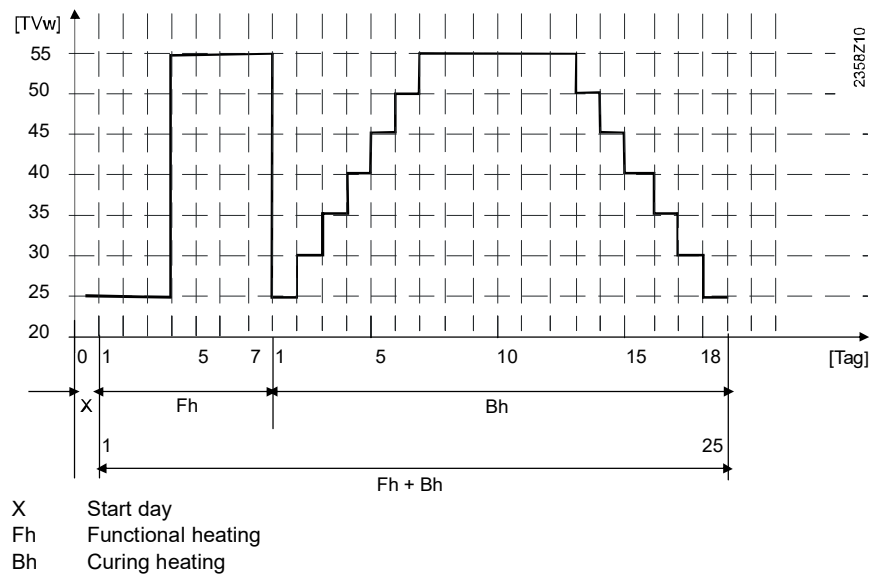

The temperature change is always made at midnight. The start day (day 0), that is, the period of time from activation to midnight, does not count as a functional day. The setpoint used for the start day is the value of the first functional day.
During floor curing mode, the profile temperature is limited within the 2 limit values "Flow temp setpoint max" (TVMax) and "Flow temp setpoint min" (TVmin).
The function is ended when the functional days have elapsed or when the function is deactivated via the respective parameter.

NOTE	<p>In the case of heat pumps controlled according to the return temperature, the switch-on point for the heat pump may not be reached in the summer.</p> <p>The return temperature needed for switching on the heat pump is calculated based on the flow temperature setpoint minus the required temperature differential ("Differential HC at OT -10°C", parameter 5810).</p> <p>If the temperature acquired by the return sensor lies above that temperature, the heat pump is not put into operation so that the "Floor curing" function is started too late (only when the temperature increase according to the "Floor curing" function necessitates switching on).</p>
-------------	---

Excess heat draw

Line no.			Operating line
HC1	HC2	HC3	
861	1161	1461	Excess heat draw Off Heating mode Always
863	1163	1463	Minimum flow function Off On

Excess heat draw

Excess heat draw can be triggered from some other device via bus or through storage tank recooling.

When dissipation of excess heat is activated, it can be drawn by space heating. This can be selected separately for each heating circuit.

Off

Excess heat draw is deactivated.

Heating mode

Excess heat is drawn only when the controller operates in heating mode.

Always

Excess heat is drawn in all operating modes.

Minimum flow function

The minimum flow function is required for plants with mixing heating circuits without a buffer storage tank.

It ensures that flow on the secondary side of the heat pump is always available.

This is ensured as follows:

- The mixing valve is forced open if the mixing heating circuit provides the current highest heat requirement to the producer. The monitoring of the maximum flow temperature remains active.
- At the end of DHW charging or drop of a heat request with a higher setpoint, the pump overrun is extended until the mixing heating circuit opens its valve to 90%, but for a maximum of 5 minutes.



The function only takes effect if the controller is used as a stand-alone device. The function has no impact on other controllers connected over the LPB.

Buffer storage tank/primary controller

Line no.			Operating line
HC1	HC2	HC3	
870	1170	1470	With buffer No Yes
872	1172	1472	With prim contr/system pump No Yes

With buffer

If a buffer storage tank is installed, enter whether the heating circuit can draw heat from it.

With prim contr/system pump

Select whether the heating circuit shall receive its heat via the primary controller or with the help of the system pump (depending on the type of plant).

Speed control

Speed-controlled pumps can be connected to outputs Zx and Ux.

Line no.			Operating line
HC1	HC2	HC3	
880	1180	1480	Pump speed reduction Operating level Characteristic
881	1181	1481	Starting speed
882	1182	1482	Pump speed min
883	1183	1483	Pump speed max
885	1185	1485	Pump speed min OEM
886	1186	1486	Pump speed max OEM
888	1188	1488	Curve readj at 50% speed
890	1190	1490	Flow setp readj speed ctrl No Yes

Pump speed reduction

Operating level

The heating circuit pump speed is calculated by the present operating level. The pump is controlled at operating level Comfort or during the floor curing function at the maximum configured speed. At a reduced operating level, the pump is controlled at the minimum configured speed.

Characteristic

Strategy

At the compensation variant 'weather compensation' (with or without room influence), the following strategy is implemented:

- The heating circuit pump speed is maintained at the configured "Pump speed min" as long as the heat demand can be covered.
- The heating curve is increased to cover the heat demand at a reduced speed. The speed is increased once the maximum permitted flow setpoint is achieved.

Settings

With "Curve readj at 50% speed" (flow temperature increase as a percentage at 50% heating circuit pump speed) the curve of strategy "Characteristic" is entirely defined.

Starting speed

A individual starting speed can be configured for the pump to guarantee safe pump start-up.

The pump is increased at start to maximum speed for 10 seconds if no parameter is entered ("- -").

Pump speed min / max

The setting limits the pump speed.

Pump speed min OEM /
Maximum OEM

Setting limit for heating technician settings (Parameter 882/883).

Curve readj at 50%
speed

Percentage for flow setpoint boost at 50% speed.

Flow setp readj speed
ctrl

In the event the strategy "Characteristic" is able to retrieve additionally required heat from the buffer storage tank, maintaining the pump speed at a low level can also save energy for heat pump systems.

The inclusion of producers can be entered in the parameter "Flow setp readj speed ctrl":

Yes

The heat request to the **producer** is increased by the configured percentage (according to "Curve readj at 50% speed").

$\text{Heat request increase} = (\text{Flow setpoint} - \text{room setpoint}) * \text{percentage}/100$
--

No

The request to the **producer** is **not** increased by the configured percentage (according to "Curve readj at 50% speed").



Following applies to strategy "Characteristic" in all cases

If the present flow temperature is warmer (f.e. from buffer) than the heating required at 100% pump speed, the speed is reduced until the heat output is correct as per the characteristic calculation.

Remote control

Line no.			Operating line
HC1	HC2	HC3	
900	1200	1500	Optg mode changeover None Protection Reduced Comfort Automatic

Optg mode changeover

In the case of external changeover via the Hx inputs, the operating mode to be used after changeover can be selected.

**Frost protection for
the heating circuit**

Frost protection for the heating circuit is always active.

If the flow temperature falls below 5 °C, the controller switches on the heating circuit pumps (regardless of the heating system's current operating mode).

When the flow temperature returns to a level above 7 °C, the controller will switch the pumps off again after 5 minutes.

6.4 Cooling circuit

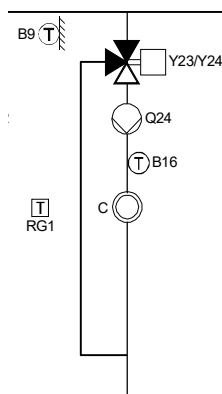

A number of functions are available for the cooling circuits which can be set individually for each cooling circuit.



The operator unit UI400 is required to take full advantage of the 3rd cooling circuit (see Section 4.2)

2-pipe system

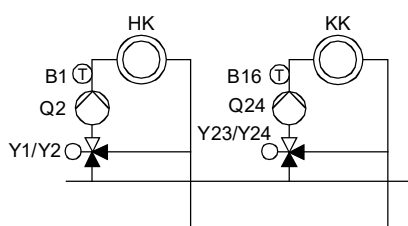

- Cooling and heating circuit draw their cooling energy/heat from the same common flow
- Cooling mode (active cooling) is interrupted if one of the consumers calls for heat

4-pipe system

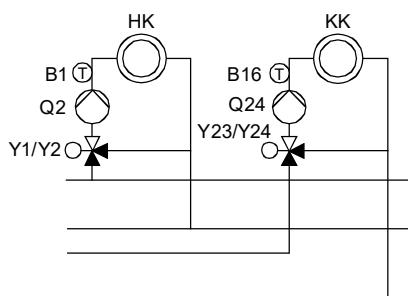

- Cooling and heating circuit draw their cooling energy/heat from separate common flows
- DHW charging and heating (with some other heating circuit) during cooling mode are possible

Operating mode

Line number			Operating line
CC1	CC2	CC3	
901	1201	1501	Operating mode
			Protection Automatic Reduced Comfort

Protection

In Protection mode, the cooling system is off. However, the room remains protected against too high temperatures (Protection setpoint, line 904).

Characteristics of Protection mode:

- Cooling mode off
- Temperature according to the "Protection setpoint" (line 904)
- "Eco" functions active

Automatic

In Automatic mode, the room temperature is controlled according to the selected time program.

Characteristics of Automatic mode:

- Cooling mode based on time program
- Temperature setpoints according to cooling program "Comfort setpoint" (line 902) or "Reduced setpoint" (line 903)
- "Eco" functions active

Tip

Many of the integrated energy saving functions, such as the time and holiday programs or restrictions in cooling mode, are active only when Automatic mode is selected.

Reduced

In Reduced mode, the room temperature is maintained at the set "Reduced setpoint" (line 903).

Characteristics of Reduced mode:

- Cooling mode without time program
- "Eco" functions active

Comfort

In Comfort mode, the room temperature is maintained at the set "Comfort setpoint" (line 902).

Characteristics of Comfort mode:

- Cooling mode without time program
- "Eco" functions are **not** active

Presence button

In automatic mode, the temperature level is changed over based on the time programs.

The presence button can be used to manually changeover between comfort and reduced setpoint, if another temperature level is desired for a temporary period.

The changeover continues until the next switching point or until the next time the presence button is activated.

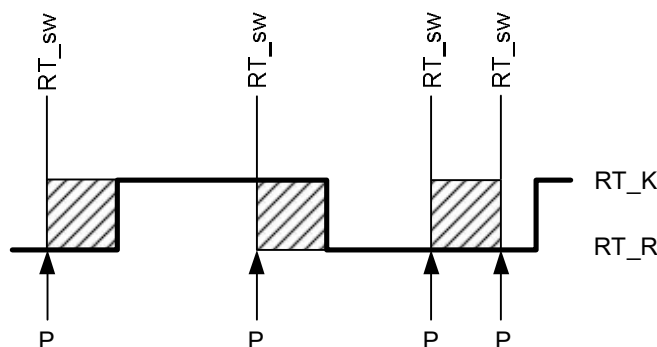

- P Push the presence button
- RT_sw Operating level changeover
- RT_K Comfort setpoint
- RT_R Reduced setpoint



The function is only available for use on operator units with presence buttons (normally room units).

Warmer/cooler function The room temperature can be temporary set to warmer or cooler for each living zone using room units QAA74 and operator units (HMI) AVS74.
The setting is only temporary. It cannot permanently influence any parameters.

Initiate function The warmer/cooling function is initiated on the temperate side  of the unit using the push and roll knob.

Three settings are available:

- Cooler** Starts the cooler function
- Neutral position (control by operating mode)
- Warmer** Starts the warmer function

QAA74 / AVS74

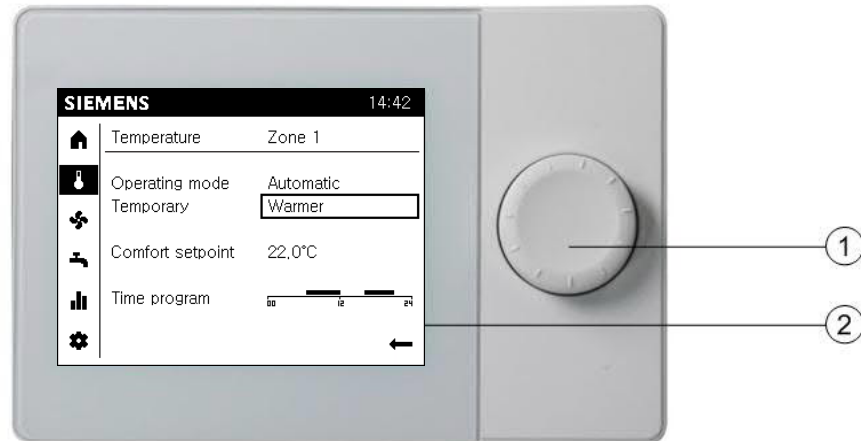

- ① Push and roll knob
- ② Display with temperature page

Additional information on operating room unit QAA74 and operator unit (HMI) AVS74 is available in technical guide CE1U2348en.

Impact in cooling mode

Cooler function **Initiated during the comfort phase**
The room setpoint reduced by 1K and at least 1K below the room actual value, or the room model value.

Initiated during the reduced phase
The room setpoint is set to the comfort setpoint and at least 1K under the room actual value, or the room model value.

Warmer function The room setpoint is increased by 1K and at least 1K above the room actual value, or the room model value.

ECO functions are temporarily deactivated as needed.

Ending the function The function ends automatically at the next operating level changeover by time switch program or at midnight, at the earliest, however, after 2 hours (function time).

End by operator intervention The warmer/cooler function can be ended manually by returning the settings "warmer" or "cooler" to the neutral position "....".
Manually changing the operating mode also ends the function.

Setpoints

Line no.			Operating line
CC1	CC2	CC3	
902	1202	1502	Comfort setpoint
903	1203	1503	Reduced setpoint
904	1204	1504	Protection setpoint
905	1205	1505	Comfort setpoint min

Room temperature The different setpoint setting ranges are interlocked, which means that the next higher setpoint cannot be lower than the next lower, and vice versa. The individual setpoints required for each cooling circuit can be adjusted.

Comfort setpoint

The "Comfort" setpoint is the room temperature setpoint for normal room usage (e.g. during the day). It is used as the setpoint when the plant operates in Automatic mode (during the Comfort phase) and in Comfort mode.

Tip

It is recommended to have the setpoint for cooling at a sufficiently high level to prevent a feeling of draft or cold. Also, it is advisable to leave a dead zone between the setpoints for heating and cooling, thus enhancing comfort and improving the system's stability.

Reduced setpoint

The "Reduced" setpoint is the room temperature setpoint for reduced room usage (e.g. during the night or when absent for several hours). It is used as the setpoint when the plant operates in Automatic mode (during the Reduced phase) and in Reduced mode.

Tip

If the space is not used, the temperature level for cooling can be raised (e.g. by allowing a natural room temperature increase during such non-occupancy times).

Protection setpoint

The "Protection setpoint" represents the desired room temperature when the space is not used (e.g. during holidays). However, the space is protected from reaching too high temperatures. It is used as the setpoint when the plant operates in Protection mode.

Comfort setpoint min

"Comfort setpoint min" ensures minimum limitation of the adjustable "Comfort" setpoint. The "Comfort" setpoint cannot be set to a level lower than the level defined here.

Release

Line no.			Operating line
CC1	CC2	CC3	
907	1207	1507	Release Time program HC Time program CC

The time program to enable cooling can be selected.

Time program heating circuit

Cooling enable occurs at the same times as for heating:

- Release cooling 1 = Time prog Heating 1 (see. Operating line 501 – 506)
- Release cooling 2 = Time prog Heating 2 (see Operating line 521 – 526)
- Release cooling 3 = Time prog heating 3 (see Operating line 541 – 546)

Time program cooling circuit

The release of cooling occurs as per the separately adjustable time program cooling:

- Release cooling 1 = Time prog 1 (s. Operating line 471 – 476)
- Release cooling 2 = Time prog 2 (s. Operating lines 481 – 486)
- Release cooling 3 = Time prog 3 (s. Operating lines 491 – 496)

Cooling curve

Line no.			Operating line
CC1	CC2	CC3	
908	1208	1508	Flow temp setp at OT 25°C
909	1209	1509	Flow temp setp at OT 35°C

Based on the cooling curve, the controller determines the required flow temperature at a certain composite outside temperature. The cooling curve is determined by defining 2 fixed points (flow temperature setpoint at 25 °C and 35 °C).

Flow temp setp at OT 25°C

Determines the flow temperature required for cooling at a composite outside temperature of 25 °C, without giving consideration to summer compensation.

Flow temp setp at OT 35°C

Determines the flow temperature required for cooling at a composite outside temperature of 35 °C, without giving consideration to summer compensation.

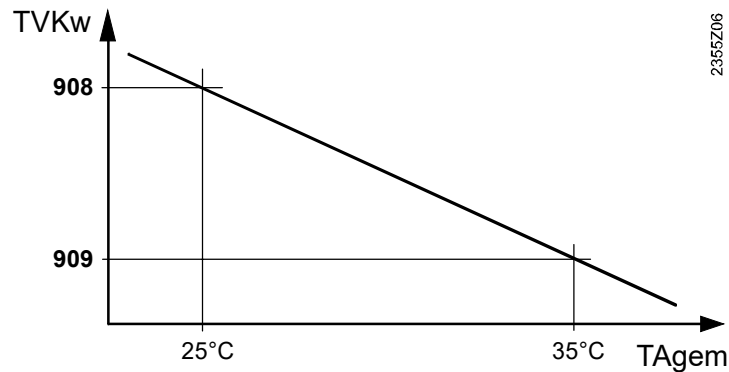

TVKw Flow temperature setpoint for cooling
TAgem Composite outside temperature



The set cooling curve is based on a room temperature setpoint of 25 °C. If the room temperature setpoint is changed, the cooling curve is automatically adapted.

"Eco" functions

Line no.			Operating line
CC1	CC2	CC3	
912	1212	1512	Cooling limit at OT
913	1213	1513	Lock time at end heat/cool
914	1214	1514	24-hour cooling limit
915	1215	1515	Ext'n 24-hour cooling limit No Yes

Cooling limit at OT

"Cooling limit at OT" for cooling corresponds to the "Summer/winter heating limit" (line 730) for heating.

If the attenuated outside temperature exceeds the "Cooling limit at OT" (e.g. at the beginning of summer), the cooling system is switched on. When the attenuated outside temperature drops (e.g. at the end of summer), the cooling system is switched off again only when the temperature reaches a level of 0.5 Kelvin below the limit temperature.

Increase

- Changeover to cooling takes place later
- Changeover to cooling off takes place earlier

Decrease

- Changeover to cooling takes place earlier
- Changeover to cooling off takes place later



- The function is not active in Comfort mode
- For definition of "attenuated outside temperature", refer to parameter 8703

Lock time at end heat/cool

To avoid too rapid a change to cooling at the end of heating, the "Cooling" function is locked for the period of time set here. This locking period starts when there is no valid heat request from the heating circuit.

The same applies to the reverse case. To avoid too rapid a change to heating at the end of cooling, the "Heating" function is locked for the period of time set here. This locking period starts when there is no valid cooling request from the cooling circuit.

24-hour cooling limit

Parameter setting "24-hour cooling limit" produces a limit temperature. If the current outside temperature drops below this limit, the cooling system is switched off (e.g. toward the evening).

When the outside temperature rises again (e.g. in the course of the morning), the cooling system is switched on again only when the outside temperature reaches a level of 0.5 Kelvin above the limit temperature.

Parameter "24-hour cooling limit" itself is a temperature differential. The value is added to (positive value) or subtracted from (negative value) the current room temperature setpoint.

Example

<i>Operating line</i>	<i>E.g.</i>
Auto mode, Comfort setpoint	24 °C
24-hour cooling limit	+3 K
Limit temperature "Cooling off"	= 27 °C
Switching differential (fixed)	+0.5 K
Changeover temperature cooling on	= 27.5 °C



- The function is not active in Comfort mode
- The function operates with the current outside temperature

Ext'n 24-hour cooling limit

To delay new activations of the cooling system in the course of the day, or to make use of the thermal energy stored by the building for a longer period of time, "Ext'n 24-hour cooling limit" can be used to extend the off phase.

Ext'n 24-hour cooling limit = **No**

The cooling system is switched on, when the **current** outside temperature (TA) exceeds the set limit temperature.

The building dynamics (building structure and insulation) are not taken into consideration.

Ext'n 24-hour cooling limit = **Yes**

The cooling system is switched on, when the **composite** outside temperature (TAGem) exceeds the set limit temperature.

The building dynamics (building structure and insulation) are taken into consideration.



Summer compensation

For definition of "composite outside temperature", refer to parameter 8704.

<i>Line no.</i>			<i>Operating line</i>
918	1218	1518	Summer comp start at OT
919	1219	1519	Summer comp end at OT
920	1220	1520	Summer comp setp increase

In the summer, the "Comfort setpoint" (line 902) is shifted upward as the outside temperature rises. This saves cooling energy, and prevents too great differentials between room and outside temperature.



For the resulting "Room setpoint" (cooling), refer to "Diagnostics" menu (lines 8741 and 8771 (8801)).

Summer comp start at OT

Summer compensation starts to take effect at the outside temperature level set here. If the outside temperature continues to rise, the "Comfort" setpoint is raised continuously.

Summer comp end at OT

At this outside temperature, summer compensation is fully active ("Summer comp setp increase", line 920). Any further increase of the outside temperature will have no more impact on the "Comfort" setpoint.

Summer comp setp increase

This setting defines the maximum by which the "Comfort" setpoint is raised.

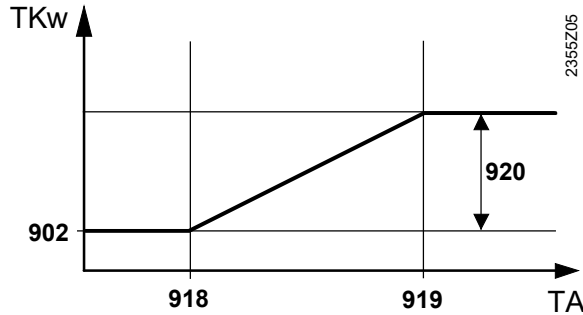

TKw Comfort setpoint
TA Outside temperature

Limitations of flow temperature setpoint

Line no.			Operating line
CC1	CC2	CC3	
923	1223	1523	Flow temp setp min OT 25°C
924	1224	1524	Flow temp setp min OT 35°C

The flow temperature required for cooling can be limited to a minimum. The limit curve is determined by defining 2 fixed points.

In addition, there is a minimum limit for the resulting flow temperature setpoint, which must not fall below 5 °C.

Flow temp setp min OT 25°C

Defines the lowest permissible flow temperature at a composite outside temperature of 25 °C.

Flow temp setp min OT 35°C

Defines the lowest permissible flow temperature at a composite outside temperature of 35 °C.



If no valid outside temperature is available, the controller uses the value of "Flow temp setp min OT 35°C".

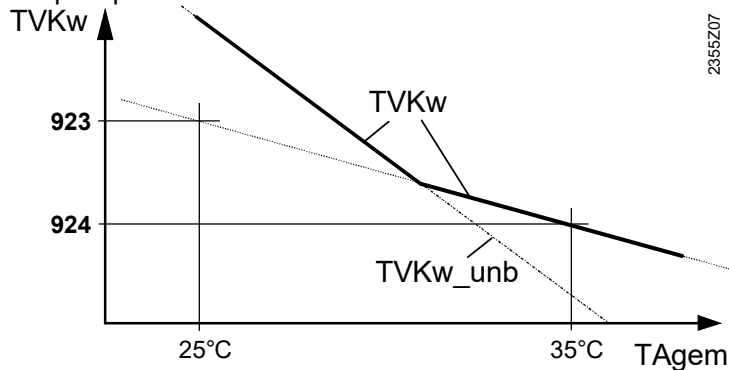

TVKw Flow temperature setpoint for cooling (with minimum limitation)
TVKw_unb Flow temperature setpoint for cooling (without minimum limitation)
TAgem Composite outside temperature

Room influence

Line no.			Operating line
CC1	CC2	CC3	
928	1228	1528	Room influence

Compensation variants

When using a room temperature sensor, there is a choice of 3 different types of compensation:

Selection	Compensation variant
– – – %	Weather compensation alone*
1...99 %	Weather compensation with room influence*
100 %	Room compensation alone

* Outside sensor is mandatory

Weather compensation alone

The flow temperature is calculated based on the cooling curve, depending on the composite outside temperature.

This compensation variant demands a correct adjustment of the cooling curve since in that case the control gives no consideration to the room temperature.

Weather compensation with room influence

The deviation of the current room temperature from the setpoint is acquired and taken into account when controlling the room temperature. This way, consideration is given to room temperature deviations, ensuring more accurate room temperature control. The authority of the deviation is set as a percentage value.

The better the reference room conditions (correct room temperature, correct mounting location, etc.) the higher the value can be set.

Example

Approx. 60% Good reference room
Approx. 20% Unfavorable reference room



To provide the function, following must be considered:

- A room sensor must be connected
- "Room influence" must be set to a value between 1 and 99
- There should be no thermostatic radiator valves in the reference room (mounting location of room sensor); if such valves are installed, they must be fully opened

Room compensation alone

The flow temperature is controlled depending on the room temperature setpoint, the current room temperature and its progression.

For example, a slight increase in room temperature leads to an immediate reduction in flow temperature.



To provide the function, following must be considered:

- A room sensor must be connected
- "Room influence" must be set to 100%
- There should be no thermostatic radiator valves in the reference room (mounting location of room sensor); if such valves are installed, they must be fully opened

Line no.			Operating line
CC1	CC2	CC3	
929	1229	1529	Prop band Xp room contr
930	1230	1530	Int act time Tn room contr
931	1231	1531	Der act time Tv room contr

Parameters Xp and Tn

By setting the right proportional band Xp and integral action time Tn, the control action can be matched to the type of plant (controlled system).

Xp and Tn can be determined using common methods, e.g. the step response method depicted in Section "Xp, Tn, Tv – Step response method".

Brochure BT_0098_EN provides additional notes on control technology in buildings.

Room temperature limitation

Line no.			Operating line
CC1	CC2	CC3	
932	1232	1532	Room temp limitation

If the room temperature drops below the current setpoint by more than "Room temp limitation", cooling circuit pump 1/2 is deactivated.

Cooling circuit pump 1/2 is activated again when the room temperature exceeds the current room temperature setpoint.

- If appropriately set, the current room temperature setpoint may include summer compensation (also refer to line 920)
- When "Room temp limitation" is active, no cooling request is sent to the source

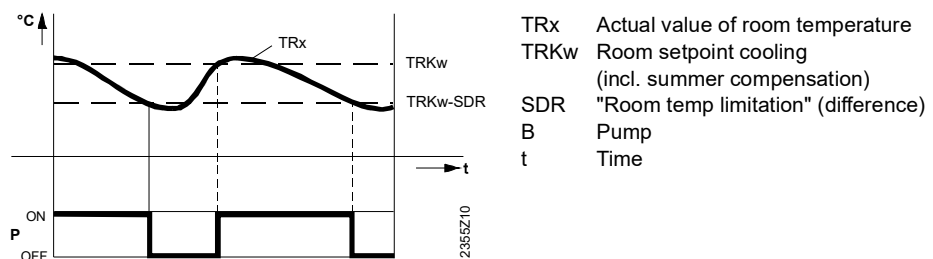

Following criteria deactivate the function:

- "Room temp limitation" = "---"
- Room temperature sensor not present
- "Room influence" (line 928) = "---", that is, weather compensation alone

Quick increase

Line no.			Operating line
CC1	CC2	CC3	
935	1235	1535	Quick increase Off To Reduced setpoint To Protection setpoint

During the "Quick increase" function, the cooling circuit pump is deactivated and, in the case of mixing valve circuits, the mixing valve is fully closed.

The temperature level up to which quick increase may take place can be set:

- In any case, only "To Reduced setpoint" or
- When changing to the "Protection setpoint" (line 904), until that level is reached.

Function with room sensor

When using a room sensor, the function switches the cooling system off until the room temperature rises to the level of the "Reduced" or "Protection" setpoint.

If the room temperature rises to the "Reduced" or "Protection" level, the cooling circuit pump is activated and the mixing valve released.

Function without room sensor

Function "Quick increase" switches the cooling system off for a certain time, depending on the composite outside temperature and the building time constant.

Example

Duration of quick increase at different composite outside temperatures and building time constants.

- "Comfort" setpoint minus "Reduced setpoint" = 2 Kelvin
e.g. "Comfort setpoint" = 24 °C, "Reduced setpoint" = 26 °C

Composite outside temperature	Building time constant [h]					
	0	2	5	10	20	50
	<i>Duration of quick setback [h]</i>					
35 °C	0	1.2	3.0	6.0	12.0	30.1
30 °C	0	2.4	6.1	12.2	24.3	60.8

Frost protection for the plant CC pumps

Line no.			Operating line
CC1	CC2	CC3	
937	1237	1537	Frost prot plant CC pump Off On

When selecting "On", cooling circuit pump 1/2 is put into operation when frost protection for the plant is active (refer to parameter 6120, "Frost protection plant").

Control of mixing valve

Line no.			Operating line
CC1	CC2	CC3	
938	1238	1538	Mixing valve decrease
939	1239	1539	Actuator type 2-position 3-position
940	1240	1540	Switching differential 2-pos
941	1241	1541	Actuator running time
942	1242	1542	Mixing valve Xp
943	1243	1543	Mixing valve Tn
945	1245	1545	Mixing valve in heating mode Control Open

Mixing valve decrease

The refrigeration request from the mixing circuit to the producer is reduced by the set value. The purpose of this reduction is to enable the mixing valve controller to compensate for the temperature variations produced by the refrigeration source (2-position control).

Actuator type

2-position

The controller uses only one relay output to drive the actuator. When the output delivers a signal, the connected valve opens. When there is no signal, the valve closes automatically.

3-position

The controller uses 2 relay outputs to drive the actuator. One output is used for opening the connected valve, the other for closing it.

Switching differential 2-pos

For a 2-position actuator, "Switching differential 2-pos" might have to be adapted. With 3-position actuators, the switching differential has no impact.

Actuator running time

In the case of 3-position control, the running time of the mixing valve actuator can be adjusted. With 2-position control, the actuator running time has no impact.

Parameters Xp and Tn

By setting the right proportional band Xp and integral action time Tn, the control action can be matched to the type of plant (controlled system).

Xp and Tn can be determined using common methods, e.g. the step response method depicted in Section "Xp, Tn, Tv – Step response method".

Brochure BT_0098_EN provides additional notes on control technology in buildings.

Mixing valve in heating mode

Defines the position of the mixing valve in heating mode.

This parameter is only active when using heating/cooling circuits with a common mixing valve.

Control

The mixing valve provides control in heating and cooling mode.

Open

The valve provides control in cooling mode, it is open in heating mode.

Dewpoint monitoring

Line no.			Operating line
CC1	CC2	CC3	
946	1246	1546	Lock time dewpoint monitor
947	1247	1547	Flow temp setp incr hygro
948	1248	1548	Flow setp incr start at r.h.
950	1250	1550	Flow temp diff dewpoint

CAUTION

Condensation can cause damage to the building.

Lock time dewpoint monitor

When the connected dewpoint monitor detects the formation of condensation, it closes its contact, thereby deactivating cooling.

The "Lock time dewpoint monitor" set here starts when the contact opens again. Cooling can be put into operation again only when the lock time has elapsed.

NOTE

The dewpoint monitor must be assigned to one of the Hx inputs as "Dewpoint monitor".

Flow temp setp incr hygro

To prevent the formation of condensation due to excess indoor air humidity, a hygrostat can be installed to implement a fixed increase in flow temperature. As soon as the room humidity exceeds the value set on the hygrostat, its contact closes and the flow temperature setpoint is increased by the set amount.

NOTE

The hygrostat must be assigned to one of the Hx inputs as "Flow temp setp incr hygro".

Flow setp incr start at r.h.

To prevent condensation due to excess indoor air humidity, "Acquisition room r.h." can be used to implement a continuous increase of the flow temperature setpoint. If the relative humidity in the room exceeds the level of "Flow setp incr start at r.h.", the flow temperature setpoint is continuously increased. The start of increase (line 948) and the maximum increase (line 947) can be set.

NOTE

The humidity sensor must be assigned to an Hx input as "Relative room humidity 10V". The operator unit UI400 with humidity sensor can be used as an alternative.

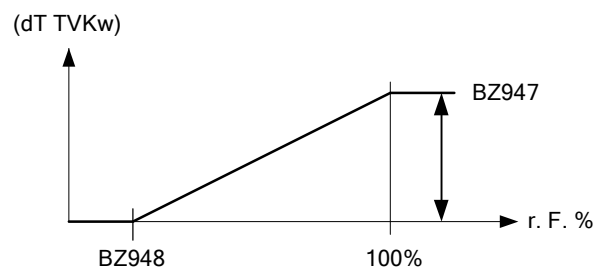

dT TVKw Increase of flow temperature setpoint
r.F. Relative humidity
BZ Operating line

Flow temp diff dewpoint

The dewpoint temperature is determined based on the relative room humidity and the associated room temperature.

To prevent condensation on surfaces, a minimum limit can be applied to the flow temperature, meaning that it always remains above the dewpoint temperature by the value set here (line 950).

Setting "- -" deactivates the function.

NOTE	The humidity sensor may be assigned to one of the inputs Hx as "Humidity measurement 10V" and a room temperature sensor must be installed (Hx input as "Room temp 10V" or room unit). The operator unit UI400 with humidity sensor can be used as an alternative.
-------------	---

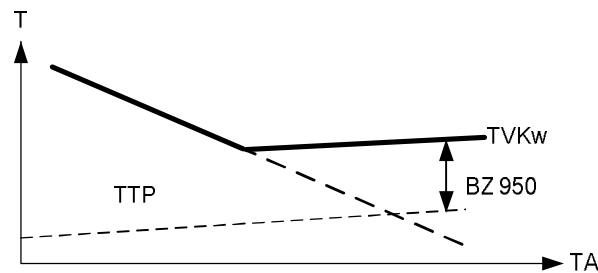

- TVKw Flow temperature setpoint cooling
- TTP Dewpoint temperature
- TA Outside temperature
- BZ Operating line

Buffer storage tank/primary controller

Line no.			Operating line
CC1	CC2	CC3	
962	1262	1562	With buffer No Yes
963	1263	1563	With prim contr/system pump No Yes

With buffer

If a buffer storage tank is installed, it must be selected whether the cooling circuit may draw cooling energy from it.

No

Hydraulically speaking, the cooling circuit is connected **upstream** of the buffer storage tank and cannot draw any cooling energy from it. The refrigeration request is forwarded to the producer upstream of the buffer storage tank.

Yes

The cooling circuit is connected downstream from the buffer storage tank. It draws cooling energy from the buffer storage tank and its temperature request is taken into account by buffer management.

With prim contr/system pump

The setting defines whether the primary controller/system pump has an impact on the cooling circuit.

No

Hydraulically speaking, the cooling circuit is connected **upstream** of the primary controller/system pump and cannot draw any "precontrolled" cooling energy. The refrigeration request is always forwarded to the producer located upstream of the primary controller.

Yes

The cooling circuit is connected **downstream** from the primary controller/system pump. The primary controller ensures control of a valid refrigeration request, or the system pump is activated.

Remote control

Line no.			Operating line
CC1	CC2	CC3	
969	1269	1569	Optg mode changeover None Protection Reduced Comfort Automatic

With external changeover via the Hx inputs, the operating mode to be used next can be selected.

6.5 Ventilation

Overview

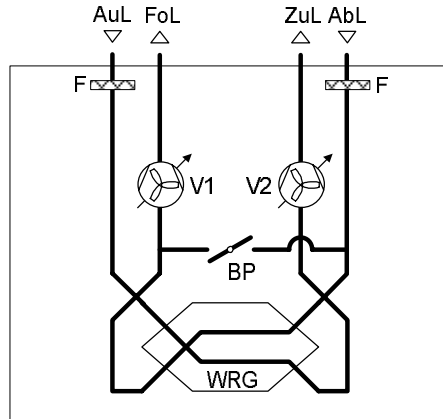

Various functions are available for room ventilation; each can be individually set for the 3 ventilation zones.

AuL	Outside air
FoL	Exhaust air
ZuL	Supply air (room)
AbL	Extract air (room)
F	Filter
V1 / V2	Fan 1 / 2 (K51/K52/K53)
BP	Bypass damper (K54/K55/K56)
WRG	Heat recovery

Operation

Using the room and operator units UI400 (QAA74.xxx und AVS74.xxx), you can directly operate ventilation from the "ventilation side".

Operation with other room and operator units takes place by setting the parameters of the RVS61.

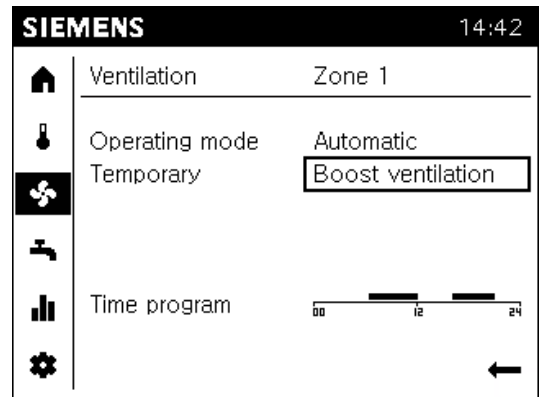

The UI400 operator unit is required to fully operate ventilation (see Section 4.2)

Detailed information on operating ventilation on the room and operator units UI400 is available in the technical manual for these units (CE1U2348en).

Operating mode

Line no.			Operating line
L1	L2	L3	
970	1270	1570	Operating mode Off Automatic Stage 1 Stage 2 Stage 3

The operating mode can either define an automatic stage selection of the ventilation plant can be operated at a fixed stage.

When setting a fixed stage, the ventilation stages are no longer changed over automatically, if the room quality/room humidity requires it.

Activating boost ventilation (OL 977) or the ventilation switch can, however, change the set stage.

Automatic	Automatic stage selection as per switching program and holiday program
Off	Ventilation is switched off
Stage 1	Ventilation operates continuously on stage 1
Stage 2	Ventilation operates continuously on stage 2
Stage 3	Ventilation operates continuously on stage 3

The set operating mode can be forced to another operating mode using the function operating mode changeover (Hx input or LPB, OL 995). Operation of the operating mode via operating line 970 is then locked.

Air quality

Line no.			Operating line
L1	L2	L3	
974	1274	1574	Air quality Comfort ppm
975	1275	1575	Air quality Reduced ppm
ACS	ACS	ACS	P-band (Xp) indoor air quality

For active air quality measurement (OL 993), ventilation is controlled to the setpoint for the current ventilation operating mode Comfort or Reduced as per the time switch program ventilation (OL 580-589).

The controller measures air load, compares it with the setpoint (OL 974 and OL 975) and changes over the ventilation stages accordingly.

The switching distance depends on the available ventilation stages.



The set stage for ventilation operating mode (Comfort OL 989, reduced OL 991) is not exceeded, even if the room air quality would permit it. For the best possible control range for air quality control, make these settings (OL 989 und 991) as low as possible (stage 1). Comply however with any local regulations on minimum air exchange.

The current room air load (ppm) is displayed on operating lines 8935 / 8940 / 8945.

P-band (Xp) air quality

The air quality value is controlled to the present air quality setpoint by the P-controller. The ventilation stages are switched based on the P-band.

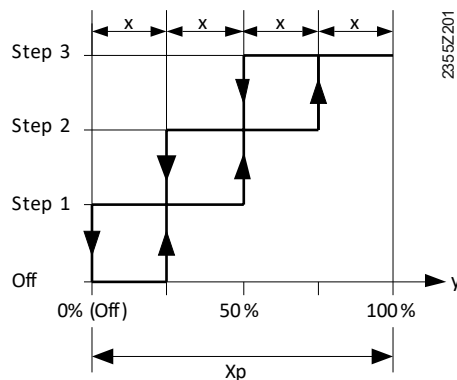

Boost ventilation

Line no.			Operating line
L1	L2	L3	
977	1277	1577	Boost ventilation ... Boost ventilation
978	1278	1578	Duration boost ventilation
979	1279	1579	Stage boost ventilation Off Stage 1 Stage 2 Stage 3

Boost ventilation switches the ventilation plant to the set "Stage boost ventilation" (OL 979), regardless of the present ventilation operating mode (OL 970) and the current actual values for room air quality and room humidity.

After the set "Duration boost ventilation" (OL 978) expires, ventilation switches back to ventilation stage corresponding to the current operating mode.

Boost ventilation	Start boost ventilation.
...	Stop boost ventilation.

Boost ventilation can be cancelled at any time via operation.

Night cooling

Line no.			Operating line
L1	L2	L3	
981	1281	1581	Forward shift night cooling
983	1283	1583	Stage night cooling Off Stage 1 Stage 2 Stage 3
ACS	ACS	ACS	Min duration night cooling
ACS	ACS	ACS	Outside temp limit night cooling
ACS	ACS	ACS	Min temp diff room/outside for night cooling

Prerequisites

Other conditions, in addition to the conditions as per the described parameters, must be simultaneously met:

- Heating must be in summer operation.
- The operating mode must be in "Auto" and the time switch in the reduced phase (unoccupied periods).
- The temperature in the reference room must be at least 1K above the comfort setpoint for heating.
- The time until the next regular switch on of ventilation (per time program/holiday program), must be shorter than the minimum period for night cooling.

Function

In summer operation, ventilation can precool the rooms during the unoccupied period (e.g. at night). This saves cooling energy during the occupancy period. During active night cooling, the heat recovery bypass for the ventilation unit is activated.

Night cooling is cancelled if the comfort setpoint is reached or if one of the preconditions are no longer met, at the latest, however, after the set forward shift expires.



For night cooling, an outside temperature sensor B9 and a room temperature sensor in the desired reference room must be available.

Forward shift night cooling

Night cooling is released only during the set maximum forward shift. Night cooling is switched off at setting "0 Min".

Stage night cooling

Ventilation operates for active night cooling at the set stage (OL 983)

Off	Ventilation switched off
Stage 1	Ventilation operating on stage 1
Stage 2	Ventilation operating on stage 2
Stage 3	Ventilation operating on stage 3

Minimum duration night cooling (ACS)

Activated night cooling continues to operate for set time.

Outside temperature limit night cooling (ACS)

The measured outside temperature B9 cannot be lower than the set outside temperature limit.

Min temp diff room/outside for night cooling (ACS)

The outside temperature must be lower by at least this value as the temperature in the reference room.

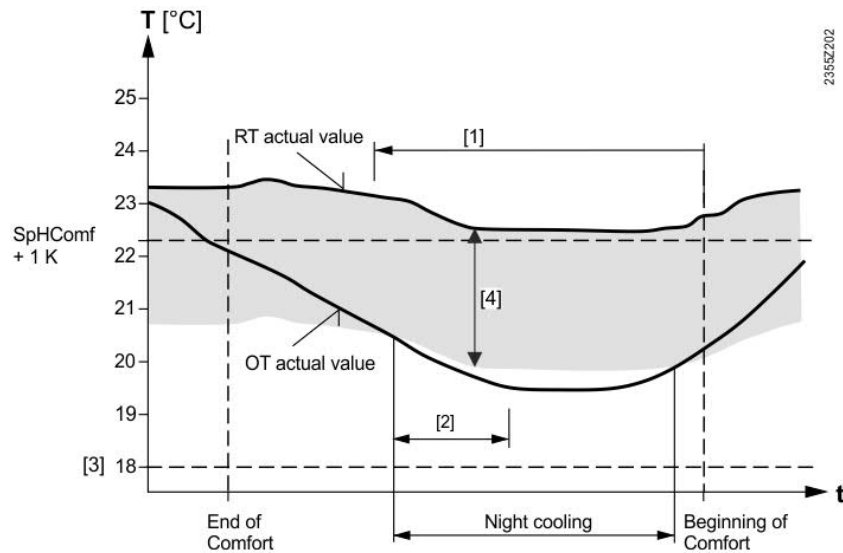

- [1] Forward shift night cooling (OL 981)
- [2] Min duration night cooling (ACS)
- [3] Outside temp limit night cooling (ACS)
- [4] Min temp diff room/outside for night cooling (ACS)
- SpHComf + 1 K Comfort setpoint for heating plus 1 Kelvin

Room humidity limit

Line no.			Operating line
L1	L2	L3	
985	1285	1585	Room humidity limit
987	1287	1587	Stage room humidity limit Off Stage 1 Stage 2 Stage 3
ACS	ACS	ACS	Room humidity limitation, switching differential
ACS	ACS	ACS	Room humidity limitation, on time
ACS	ACS	ACS	Room humidity limitation, off time

The controller measures relative air humidity at the connected humidity sensor (OL 6293).
The current relative room air humidity (% r.h.) is displayed at OL 8723.

Room humidity limit

The controller initiates ventilation if air humidity climbs above the room humidity limit (1..99 % r.h.).
The room humidity function is ended if the air humidity switching differential (ACS) is below the room humidity limit, or the set "Room humidity limitation, on time" (ACS) expires.

Stage room humidity limitation

The active humidity limitation function initiates ventilation at the set stage.

Off	Ventilation switched off
Stage 1	Ventilation operating on stage 1
Stage 2	Ventilation operating on stage 2
Stage 3	Ventilation operating on stage 3

Room humidity limitation, switching differential (ACS)

The controller switches off ventilation again if air humidity is below the room humidity limit by this switching differential.

Room humidity limitation, on time (ACS)

The controller switches off the humidity limitation function at the latest after the set runtime, even if the air humidity is still too high.

Room humidity limitation, off time (ACS)

Air humidity in the room is rechecked after the set pause expires and the humidity limitation function is reinitiated as needed.

Stage

Line no.			Operating line
L1	L2	L3	
989	1289	1589	Stage Comfort Off Stage 1 Stage 2 Stage 3
991	1291	1591	Stage Reduced Off Stage 1 Stage 2 Stage 3
992	1292	1592	Stage Protection Off Stage 1 Stage 2 Stage 3

Ventilation operating modes are switched as per time switch program (OL 580-589) if the operating mode (OL 970) is set to **Automatic**. Each ventilation operating mode (Comfort, reduced, and protection) then operates at the stage defined here.

Off	Ventilation switched off
Stage 1	Ventilation operates at stage 1
Stage 2	Ventilation operates at stage 2
Stage 3	Ventilation operates at stage 3

i The stage set here is not breached if ventilation is controlled to relative air humidity or air quality.

i Comply with all local regulations on minimum air exchange.

Operating mode changeover

Line no.			Operating line
L1	L2	L3	
995	1295	1595	Optg mode changeover None Off Stage 1 Stage 2 Stage 3

The present operating mode can be forced using the function operating mode changeover via an H input or via LPB (central changeover) to another operating mode. Operation of the operating mode (OL 970) is then locked.

You can set the operating mode by initiating an operating mode changeover for each ventilation group.

"None" means that the operating mode changeover has no impact on ventilation. After removing the operating mode changeover, each ventilation group returns to the operating mode as per the setting "operating mode".

i Operating mode changeover acts on all functions (heating, cooling, DHW, and ventilation) of the room or room group for which an operating mode changeover was defined. All functions are driven to their applicable, preselected operating modes.

Ventilation switch

Line no.			Operating line
L1	L2	L3	
996	1296	1596	Duration ventilation switch
997	1297	1597	Stage ventilation switch Off Stage 1 Stage 2 Stage 3

One ventilation switch can be connected to each ventilation group via the H-input. Once the contact is activated, the present fan stage is driven to the stage defined here, unless operating mode (OL 970) is set to "Off".

The stage is maintained as long as the switch is active, but at a minimum for the set "Duration ventilation switch".

Holiday mode

Line no.			Operating line
L1	L2	L3	
ACS	ACS	ACS	Holiday mode, switch-on time ventilation
ACS	ACS	ACS	Holiday mode, on time ventilation

In holiday mode (as per settings in the Holiday menu), ventilation only operates at time intervals as defined here.

Ventilation assumes the present apartment operating mode and selects the necessary ventilation stage based on it.

This ventilation stage is initiated daily at the set switch-on time (00:00...24:00) for the defined on time.

Outside air temperature control

Outside air temperature control can occur via the water-air heat exchanger if a brine or water source is available in Section 6.19 "General functions".

Air cooling

Operating mode

Line no.			Operating line
L1	L2	L3	
ACS	ACS	ACS	Operating mode Protection Automatic Reduced Comfort

Air cooling can be used to lower the room temperature in summer. Individual settings are planned for forming the setpoint. The start time and period is essentially determined by the outside temperature and room temperature.

Protection

Air cooling is switched off in protection mode. The room remains, however, protected against excessing heat.

Protection mode features:

- Temperature is fixed by "Protection setpoint cooling coils" at 35 °C

Automatic

In automatic mode, the room temperature is controlled to the selected time program accordingly.

Properties of automatic mode:

- Air cooling as per time program
- Temperature setpoints by cooling program "Comfort setpoint" (ACS) or "Reduced setpoint" (ACS)

Reduced

In reduced mode, the room temperature is maintained at a constant, set "Reduced setpoint" (ACS).

Reduced mode properties:

- Air cooling mode without time program

Comfort

In comfort mode, the room temperature is maintained at a constant, set "Comfort setpoint" (ACS).

Comfort mode properties:

- Air cooling without time program

Setpoints

Line no.			Operating line
L1	L2	L3	
ACS	ACS	ACS	Comfort setpoint
ACS	ACS	ACS	Reduced setpoint

Comfort setpoint

The comfort setpoint is the desired room temperature during normal room occupancy (e.g. during the day). Automatic mode (during the comfort phase) and comfort mode use it as the setpoint.



Air cooling is possible as well without room sensors. The room temperature is calculated with the help of a room model.



Tip

We recommend setting the setpoint for air cooling high enough to prevent a feeling of draughts or cold. A deadzone should also be planned between the setpoints for heating and cooling to improve the comfort level and stabilize the system.

Reduced setpoint

The reduced setpoint is the desired room temperature at reduced room occupancy (e.g. at night or during periods of absence for a number of hours). Automatic mode (during reduced phase) and reduced mode use it as the setpoint.



Tip

If the room is unoccupied, the temperature level for air cooling can be increased (e.g. by permitted a natural increase in temperature during these periods).

Protection setpoint

The protection setpoint for air cooling is the room temperature when the room is unoccupied (e.g. during holidays), but the room must still be protected against excessive temperatures. Protection mode uses it as the setpoint (35°C, cannot be changed).

Release air cooling

Line no.			Operating line
L1	L2	L3	
ACS	ACS	ACS	Release 24h/day Time program heating circuit Time program 5 Time program ventilation

Determines if air cooling is released.

At 24 hours a day, operating mode "Automatic" continuously controls air cooling to the comfort setpoint.

For release following a time program, the operating mode "automatic" controls air cooling during the "on" phases, as per the corresponding time program, to the comfort setpoint and then to the reduced setpoint during the "off" phases.

Summer compensation

Line no.			Operating line
L1	L2	L3	
ACS	ACS	ACS	Start of summer compensation at outside temp
ACS	ACS	ACS	End of summer compensation at outside temp
ACS	ACS	ACS	Summer compensation, setpoint increase

In summer, the "Comfort setpoint" (ACS) is increased on a sliding scale as the outside temperature increases. This saves cooling energy and prevents temperature differences that are too large between the room and outside temperatures.



The resulting "room setpoint" (air cooling), can be viewed in the Diagnostics menu (ACS only).

Start of summer compensation at outside temp

Summer compensation takes effect as of the outside temperature set here. The comfort setpoint then continuously increases in line with continued increases to the outside temperature.

End of summer compensation at outside temp

Summer compensation assumes it full effect at this outside temperature ("Summer compensation, setpoint increase ", ACS). Any further increase in the outside temperature has no effect on the comfort setpoint.

Summer compensation, setpoint increase

The setting established maximum amount by which the comfort setpoint is increased.

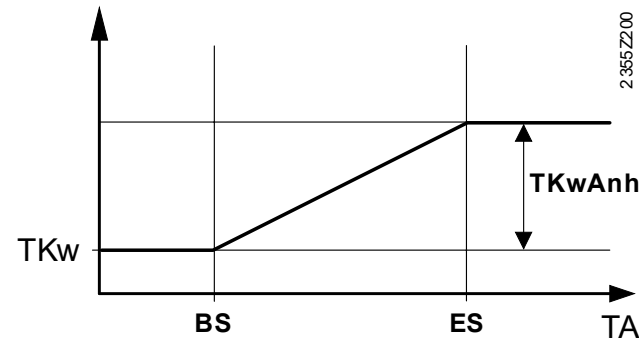

- BS Start of summer compensation at outside temp
- ES End of summer compensation at outside temp
- TA Outside temperature
- TKw Setpoint air cooling
- TKwAnh Summer compensation, setpoint increase

6.6 DHW

Summary

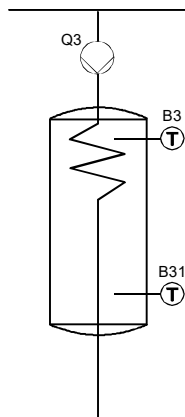

The unit controls the DHW temperature according to the time program, or continuously, to the required setpoint. Priority of DHW charging over space heating can be selected.

The controller features a "Legionella" function with a number of setting choices, fighting legionella viruses both in the storage tank and in the circulation pipe. The circulating pump is controlled to the setpoint according to the selectable time program and the selectable operating mode.

Line no.	Operating line
1600	Operating mode Off On Eco
1601	Optg mode selection Eco None DHW storage tank

Operating mode

"Operating mode" can be used to switch DHW charging on/off or to switch it to Eco mode.

Tip

If larger DHW temperature variations are acceptable and sufficient free energy is available via solar heating or a solid fuel boiler, the Eco function can be used. If local regulations relating to the "Legionella" function are in force, they must be observed.

Optg mode selection Eco

None

"Eco" does not offer the Operating mode option (hidden).

DHW storage tank

Eco mode is used in connection with the DHW storage tank.

In Eco mode, DHW heating is restricted by controllable heat sources. These heat sources are switched on only if the DHW temperature falls below the reduced level or if the "Legionella" function is active.



The manual push can also be activated in Eco mode.

Setpoints

Line no.	Operating line
1610	Nominal setpoint
1612	Reduced setpoint
1614	Nominal setpoint max

The DHW is heated up according to different setpoints. These setpoints become active depending on the selected operating mode, thus leading to the required temperature level in the DHW storage tank.

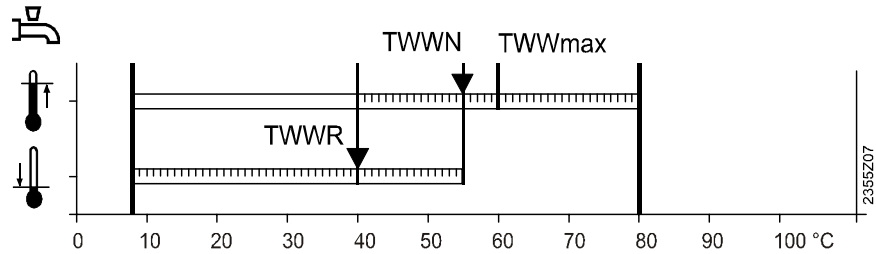

TWWR Reduced DHW setpoint
 TWWN Nominal DHW setpoint
 TWWmax Nominal DHW setpoint maximum

Nominal setpoint max

"Nominal setpoint max" limits setting "Nominal setpoint" (line 1610) at the top.

Release

Line no.	Operating line
1620	Release 24h/day All time programs HC/CC Time program 4/DHW Low-tariff T'prog 4/DHW or low-tariff

24h/day

The DHW temperature is always maintained at the nominal DHW setpoint (regardless of time programs).

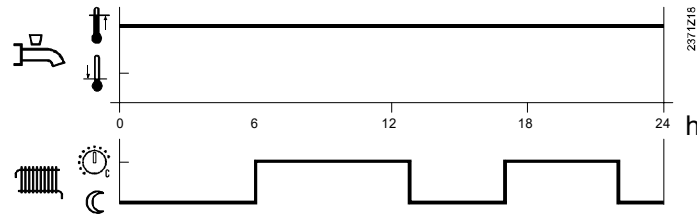

All time programs HC/CC

The DHW setpoint changes between the nominal and the reduced DHW setpoint according to the heating circuit's/cooling circuit's time program. The first switch-on point of each phase is shifted forward in time by 1 hour.

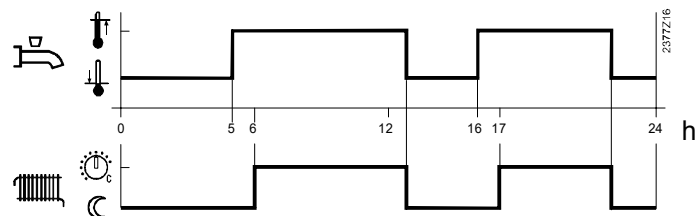

Time program 4/DHW

DHW heating makes use of time program 4 of the local controller. The set switching times of that program are used to change between the nominal and the reduced DHW setpoint. This way, the DHW storage tank is charged independently of the heating circuits.

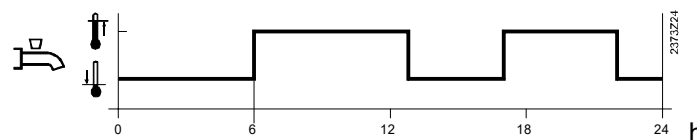

Low-tariff

DHW heating is released when the low-tariff input (E5) is active. Smart grid states "Draw wish" and "Draw imposed" are considered like low-tariff.

T'prog 4/DHW or low-tariff

DHW heating is released when the nominal setpoint of DHW program 4 or the low-tariff input (E5) or smart grid state "Draw wish" is active.

Charging priority

Line no.	Operating line
1630	Charging priority Absolute Shifting None MC shifting, PC absolute

If the heating circuits and DHW call for heat at the same time, the "DHW priority" function ensures that, during DHW charging, the heat produced by the heat source is used primarily for DHW.

Absolute priority

Mixing and pump heating circuits are locked until the DHW reaches the required temperature level.

Shifting priority

If the heat source is no longer able to meet the demand, the mixing and pump heating circuits are restricted until the DHW reaches the required temperature level. To ensure the temperature available for DHW charging is high enough and to be able to end DHW charging, the request to heat pump fix is raised by 6 Kelvin (DHW target + 6 Kelvin).



This does not apply to separate DHW circuits.

No priority

DHW charging and space heating take place at the same time.

In the case of tightly sized heat sources and mixing heating circuits, the DHW setpoint might not be reached if space heating calls for considerable amounts of heat.

Mixing heating circuit shifting, pump heating circuit absolute

The pump heating circuits remain locked until the DHW storage tank is heated up. If the heat source is no longer able to meet the demand, the mixing heating circuits will be restricted as well.

NOTE

- Plants without buffer or combi storage tanks: Parameter "Charging priority" should be set to "Absolute" to ensure that the consumers are switched off. If this is not observed, the required DHW temperature might not be reached
- Plants with buffer or combi storage tanks: Parameter "Charging priority" should be set to "None"
If this is not observed, the heating circuits of plants using storage tanks will be unnecessarily restricted



Parameter "Charging priority" has no impact on condenser pump Q9.

Temp request selection

Line no.	Operating line
1631	Temp request selection Max limitation Max selection

The heat request to the producer or cascade can be limited on the maximum side when DHW charging is active.

Max limitation

The temperature request from the DHW storage tank is transmitted to the producer. A higher temperature request, e.g. from room heating, is ignored. The lowest heat request from all DHW storage tanks is transmitted to the producer when simultaneously charging multiple DHW storage tanks in the system (via LPB).

Max selection

The highest request from all consumers is transmitted to the producer.

"Legionella" function

Line no.	Operating line
1640	Legionella function Off Periodically Fixed weekday
1641	Legionella funct periodically
1642	Legionella funct weekday Monday...Sunday
1644	Legionella funct time
1645	Legionella funct setpoint
1646	Legionella funct duration
1647	Legionella funct circ pump
1648	Legio funct circ temp diff

Legionella function

Off

The "Legionella" function is deactivated.

Periodically

The "Legionella" function is repeated according to the selected interval ("Legionella funct periodically", line 1641). If the legionella setpoint is attained via solar plant, independent of the time set, the time period is started again.

Fixed weekday

The "Legionella" function can be activated on a certain weekday ("Legionella funct weekday", line 1642). When using this setting, heating up to the legionella setpoint takes place on the parameterized weekday, regardless of previous storage tank temperatures.

Legionella funct time

Defines the time of day the "Legionella" function is started. The setpoint is increased at this point in time, starting DHW charging.

If no time is parameterized, the "Legionella" function is started on the respective day together with the first normal release of DHW heating. If no release is scheduled for that day, (continuously reduced), the "Legionella" function is performed at 24:00 o'clock.

If DHW heating is off (operating mode = off or "Holiday" function of the heating circuits active), the "Legionella" function is made up for as soon as DHW heating is switched on again (operating mode = on or end of holiday period).

Legionella funct setpoint The DHW storage tank is heated up to the adjusted setpoint (55...95 °C).
 For the "Legionella" function to be regarded as fulfilled, the sensor at the top of the storage tank (B3) or both sensors (B3 and B31) must reach the legionella setpoint, depending on the type of charging (line 5022); that setpoint must then be maintained for the set duration of the function.

 The higher the setpoint, the shorter the duration that need be set to reliably kill the legionella viruses in the DHW.

Legionella funct duration Defines the period of time during which the legionella setpoint in the storage tank/circulation pipes must be maintained.

Legionella funct circ pump During the period of time the "Legionella" function is performed, the DHW circulating pump can be activated.

 CAUTION	When opening the taps during the time the "Legionella" function is performed, there is a risk of scalding.
--	--

Legio funct circ temp diff The circulating pump remains in operation until the temperature acquired by the circulation sensor (B39) reaches the setpoint (line 1645) minus the circulation difference (line 1648), and the set duration of the function (line 1646) has elapsed.
 If, for 48 hours, the circulation pipe does not reach the required temperature, an error message (127:Legionella temp) is delivered.
 If the temperature differential is not set, the temperature at sensor B39 is not monitored during the period of time the "Legionella" function is performed.

Circulating pump

<i>Line no.</i>	<i>Operating line</i>
1660	Circulating pump release Time program HC/CC 3 DHW release Time program 4/DHW Time program 5
1661	Circulating pump cycling
1663	Circulation setpoint

Circulating pump release

With setting "DHW release", the circulating pump runs whenever DHW heating is released. With the other settings, it operates according to the respective time program.

Circulating pump cycling

When the function is activated, the circulating pump operates for 10 minutes within the release time and is then switched off again for 20 minutes.

Circulation setpoint

If sensor B39 is used, the circulating pump Q4 switches on as soon as the water temperature drops below the set value. The pump operates until the setpoint is reached again (min. 2 minutes). The circulating setpoint is automatically limited to 8 °C below the storage tank temperature actual value (sensor B3).

Example 1

- DHW setpoint: 55 °C
 - DHW actual value (B3): 55 °C
 - Circulation setpoint: 45 °C
- The circulating pump is activated when the temperature at the sensor drops below 45 °C and until the setpoint is reached again (min. 2 minutes).

Example 2

- DHW setpoint: 55 °C
 - Circulation setpoint: 50 °C
- The circulating pump is activated when the temperature at the sensor drops below 42 °C (50 °C – 8 K) and operates until the setpoint is reached again (min. 2 minutes).

Remote control

<i>Line no.</i>	<i>Operating line</i>
1680	Optg mode changeover None Off On Eco

In the case of external changeover via the Hx inputs, the operating mode for DHW heating to be used after changeover can be selected.

6.7 Consumer circuits and swimming pool circuit

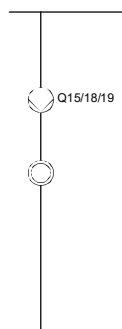

In addition to heating circuits HC1...HC3 and the cooling circuit, other consumers can be connected or controlled (e.g. warm air curtain, swimming pool, etc.).

The controller can receive their temperature requests via one of the Hx inputs to control the respective pumps via a Qx relay output.

For the consumer circuits, the following settings are available:

Prerequisite for the use of consumer circuits/swimming pool circuit is an appropriately defined Hx input on the controller itself or on an extension module. The input can be defined as follows:

- Consumer request VK1, 2
- Consumer request VK1 10V, Consumer request VK2 10V
- Release swi pool source heat
- Operating lines 5750 and 5751 are available to select whether the consumer circuits are used for heating or cooling
- The pumps are to be connected to the appropriately defined multifunctional relay outputs Qx

The consumer circuit pumps (Q15/Q18) are put into operation when there is a heat or refrigeration request at the respective Hx input, or when excess heat draw is called for.

The swimming pool circuit (Q19) is put into operation when there is a release at the respective Hx input and when the swimming pool temperature lies below "Setpoint source heating" (line 2056).

Line no.			Operating line
VK1	VK2	SC	
1854	1904	1954	Request opt energy Off On

On

When used in connection with producers operating with optimum efficiency (condensing boilers, heat pumps, etc.), the consumer circuit makes non-mandatory heat requests.

Only heat sources supporting the function

"Producers with optimum efficiency" (parameter 2867) handle such requests.

Off

The consumer circuit makes no requests that demand optimum efficiency.

Consumer circuits 1 and 2/swimming pool circuit

Line no.			Operating line
VK1	VK2	SC	
1859	1909	1959	Flow temp setp cons request, Flow temp setpoint
1860	1910	1960	Frost prot plant VK pump, Frost prot plant pool pump
1874	1924	1974	DHW charging priority No Yes
1875	1925	1975	Excess heat draw Off On
1878	1928	1978	With buffer No Yes
1880	1930	1980	With prim contr/system pump No Yes



The current flow temperature setpoints of the consumer circuits appear on operating lines 8875 and 8885 and that of the swimming pool circuit on operating line 8895.

Flow temperature setpoint

When a heat or refrigeration request is pending at an appropriately defined Hx input, the flow temperature of the respective consumer circuit is increased/decreased until the value set here is reached.

For the swimming pool circuit, a request from swimming pool sensor B13 is required, in addition to the release at the Hx input.

Frost protection for the plant

Defines whether the consumer circuit pumps and the swimming pool pump shall be put into operation when frost protection for the plant responds.

DHW charging priority

Defines whether DHW charging priority shall act on the respective consumer circuit/swimming pool circuit.

When selecting "Yes", DHW charging is given priority over the respective consumer circuit. When selecting "No", DHW charging and the consumer circuit are treated equally, meaning that both receive heat.

Excess heat draw

Excess heat draw can be triggered from some other device via bus or through storage tank recooling.

When dissipation of surplus heat is activated, it can be drawn by the consumer circuits/swimming pool circuit. This can be selected separately for each consumer circuit/the swimming pool circuit.

Off

Excess heat draw is deactivated.

On

Excess heat draw is activated.

With buffer

No

Hydraulically speaking, the consumer circuit/swimming pool circuit is connected **upstream** of the buffer storage tank and cannot draw any heat or cooling energy from it. The heat or refrigeration request is forwarded to the heat/refrigeration source upstream of the buffer storage tank.

Yes

The consumer circuit/swimming pool circuit is connected **downstream** from the buffer storage tank. It draws heat or cooling energy from the buffer storage tank and its temperature request is taken into account by buffer management.

With prim contr/system pump

No

Hydraulically speaking, the consumer circuit/swimming pool circuit is connected **upstream** of the primary controller/system pump and cannot draw any "precontrolled" heat or cooling energy. The heat or refrigeration request is always forwarded to the heat/refrigeration source upstream of the primary controller.

Yes

The consumer circuit/swimming pool circuit is connected **downstream** from the primary controller/system pump. The primary controller ensures control of a valid heat or refrigeration request, or the system pump is activated.

Swimming pool circuit

<i>Line no.</i>	<i>Operating line</i>
1952	Release source heating None 24h/day Time program 5

The release for heating by the heat source can take place either via the assigned Hx input or parameter "Release source heating".

If only 1 of the 2 types of release is configured, swimming pool heating is released when the configured release is active.

If both types of release are configured, swimming pool heating is released only if both types of release are active.

<i>Input Hx configured</i>	<i>Contact state Hx</i>	<i>Release source heating (line 1952)</i>	<i>State switching program 5</i>	<i>Release producer heating for swimming pool</i>
No		None	-	No
		24h/day	-	Yes
		Time program 5	Off	No
			On	Yes
Yes	Inactive	None	-	No
		24h/day	-	
		Time program 5	Off	
			On	
	Active	None	-	Yes
				Yes
				No
		Time program 5	Off	No
			On	Yes

<i>Line no.</i>	<i>Operating line</i>
1973	Last priority to charge No Yes

Parameter "Last priority to charge" is used to select the charging priority for the swimming pool.

No

Swimming pool heating is performed with the same priority as other heat requests. When, at the same time, the DHW is heated with charging priority, swimming pool heating is interrupted if demanded by the DHW priority.

Yes

Swimming pool heating is performed with the last priority. When using this parameter setting, the swimming pool is heated only if no other heat request is active.

6.8 Swimming pool

Summary

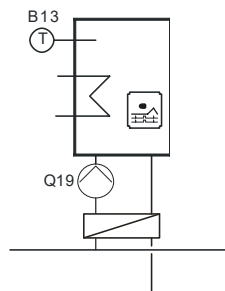

The controller facilitates swimming pool heating with solar energy or via a heat pump using separately adjustable setpoints. In the case of solar heating, it is possible to select priority of swimming pool heating over storage tank charging.

Setpoints

Line no.	Operating line
2055	Setpoint solar heating
2056	Setpoint source heating
2057	Swi diff source heating

Setpoint solar heating

When using solar energy, the swimming pool is heated up to this setpoint.



Function "Overtemperature protection for the collector" can reactivate the collector pump until the maximum swimming pool temperature is reached.



Solar swimming pool heating can be made dependent on the release of 1 or 2 Hx inputs.

Setpoint source heating

When using heating by the heat source, the swimming pool is heated up to this setpoint.

Tip

It is recommended to set the lowest temperature setpoint which still offers adequate comfort. This is to avoid unnecessary energy usage by the main heat source.

Swi diff source heating

When released (see parameter 1952), the charging controller switches the swimming pool pump on or off based on "Swi diff source heating". Also, when switching on, a heat request is forwarded to the producer.

Priority

Line no.	Operating line
2065	Charging priority solar Priority 1 Priority 2 Priority 3
2066	Charging prio photovoltaics None Priority 1 Priority 2 Priority 3

Charging priority solar

Priority 1

Swimming pool heating is assigned the first priority.

Priority 2

Swimming pool heating is assigned the second priority (after the buffer storage tank, before the DHW storage tank, or after the DHW storage tank, before the buffer storage tank).

Priority 3

Swimming pool heating is assigned the last priority (after the buffer and the DHW storage tank).

Charging prio photovoltaics

A photovoltaics plant can commission the heat pump via the EX input E64 (Line 5980...) and charge a storage tank using the generated thermal energy. The storage tank charging sequence occurs as per the set priorities. Priorities can be set on the following storage tanks:

- Swimming pool, line 2066
- Buffer storage tank, line 4706
- DHW storage tank, line 5018

None

No swimming pool charging.

Priority 1

Swimming pool charging has the highest priority.

Priority 2

Swimming pool charging is the second priority (after buffer storage tank, before DHW storage tank or after DHW storage tank, before buffer storage tank).

Priority 3

Swimming pool charging is the lowest priority (after buffer storage tank and DHW storage tank).



Charging occurs in accordance to the predefined sequence if storage tanks are set at the same priorities: DHW storage tank, buffer storage tank, swimming pool.

Overtemperature protection

Line no.	Operating line
2070	Swimming pool temp max

When the swimming pool temperature reaches the maximum set here, the collector pump is deactivated.

Plant hydraulics

Line no.	Operating line
2080	With solar integration

This setting defines whether the swimming pool can be heated by solar energy.

6.9 Primary controller/system pump

Summary

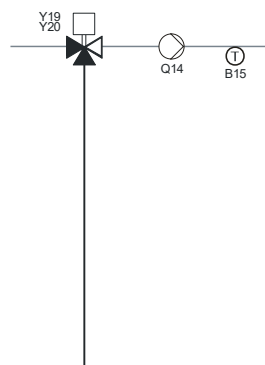

The primary controller allows lower or higher flow temperatures by mixing to obtain flow temperatures for heating/cooling zones with setpoints higher or lower than those of the common flow.

The system pump can be used to overcome the pressure drop to remote heating/cooling zones.

Limitations of flow temperature setpoint

Line no.	Operating line
2110	Flow temp setpoint min
2111	Flow temp setpoint max
2112	Flow temp setp cooling min

Flow temp setpoint min and max

This limitation can be used to select a range for the flow temperature setpoint in heating mode. If the requested flow temperature setpoint reaches the relevant limit and the request for heat continues to increase or decrease, the flow temperature setpoint is maintained at the maximum or minimum limit respectively.

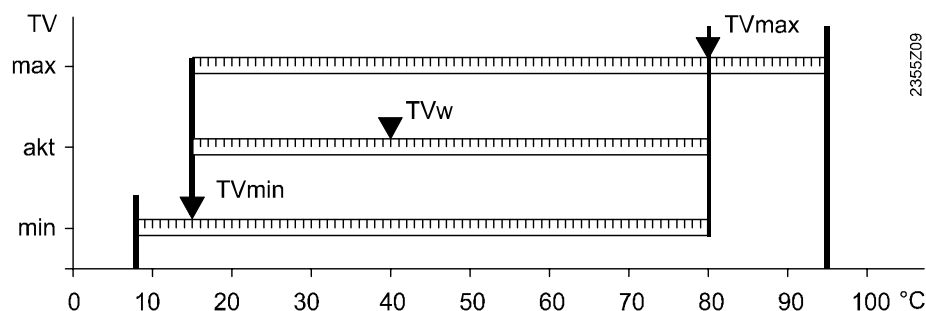

TVw Current flow temperature setpoint
 TVmax Flow temperature setpoint, maximum
 TVmin Flow temperature setpoint, minimum

Flow temp setp cooling min

This limitation can be used to define the low limit for the flow temperature setpoint in cooling mode.

Primary controller/system pump

Line no.	Operating line	
1	2	
2120	2160	Frost prot plant syst pump Off On

Frost prot plant syst pump

It can be selected if, in the case of frost protection for the plant, system pumps 1 and 2 shall be activated.

Control of mixing valve

<i>Line no.</i>	<i>Operating line</i>
2130	Mixing valve boost
2131	Mixing valve decrease
2132	Actuator type
2133	Switching differential 2-pos
2134	Actuator running time
2135	Mixing valve Xp
2136	Mixing valve Tn

Mixing valve boost

The controller generates the source temperature setpoint based on the boost set here and the current flow temperature setpoint.

Mixing valve decrease

The controller generates the refrigeration request to the refrigeration source based on the decrease set here and the current flow temperature setpoint.

Actuator type

The selection of the type of actuator determines the control of the mixing valve actuator used.

Switching differential 2-pos

For the 2-position actuator, "Switching differential 2-pos" can be adapted.

Actuator running time

Setting the running time for the actuator used with the mixing valve. Parameters Xp and Tn By setting the right proportional band Xp and integral action time Tn, the control action can be matched to the type of plant (controlled system).

Control of mixing valve

Parameters Xp and Tn

By setting the right proportional band Xp and integral action time Tn, the control action can be matched to the type of plant (controlled system).

Xp and Tn can be determined using common methods, e.g. the step response method depicted in Section "Xp, Tn, Tv – Step response method".

Brochure BT_0098_EN provides additional notes on control technology in buildings.

DHW charging priority

<i>Line no.</i>	<i>Operating line</i>
2145	DHW charging priority No Yes

DHW charging priority

No

DHW charging with priority has no impact on the system pump or the mixing valve.

Yes

When DHW is charged with priority, the system pump is deactivated or the mixing valve is closed.

<i>Line no.</i>	<i>Operating line</i>
2150	Primary contr/system pump Before buffer After buffer

Primary contr/system pump

If the plant uses a buffer storage tank, it is to be selected here whether – hydraulically speaking – the primary controller or the system pump is installed upstream of or downstream from the buffer storage tank.

6.10 Heat pump

Heat pumps draw energy from the environment (brine, water or air) and deliver it to the heating system, raised to a higher temperature level. If the heat pump is equipped with a process reversing valve, it can also be used for active cooling. Also, brine-to-water and water-to-water heat pumps can be employed for passive cooling.

Function diagrams

The following function diagrams show the plant components and designations used in the descriptions:

Brine-to-water heat pump

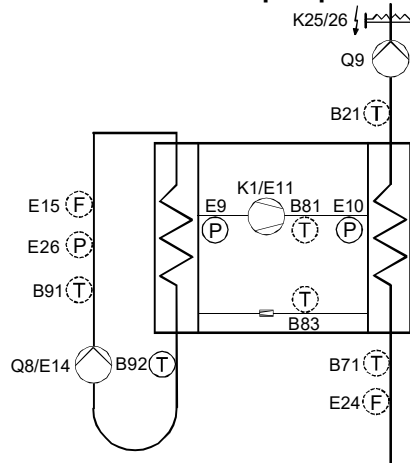

Water-to-water heat pump

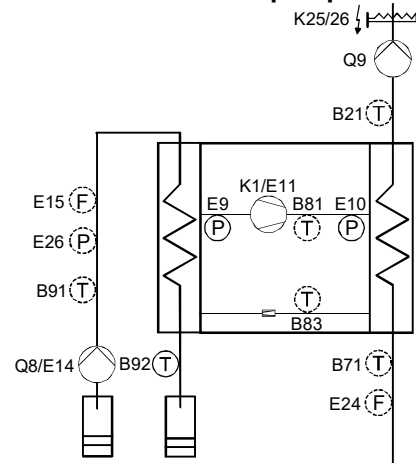

Air-to-water heat pump

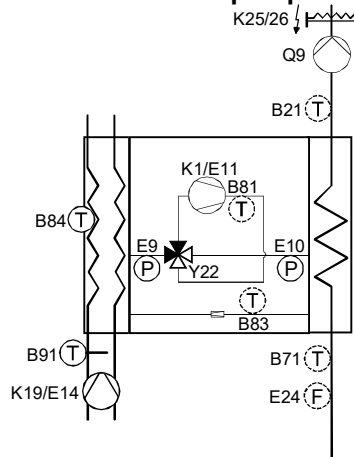

Mains voltage

E5	Low-tariff E5
E6	Electrical utility lock E6
E9	Low-pressure switch E9
E10	High-pressure switch E10
E11	Overload compressor 1 E11
E14	Overload source E14
E15	Flow switch source E15
E17	Manual defrost E17
E24	Flow switch consumers
E26	Pressure switch source
K1	Compressor stage 1 K1
K19	Source pump Q8/fan K19
K25	El imm heater 1 flow K25
K26	El imm heater 2 flow K26

Q8	Source pump Q8/fan K19
Q9	Condenser pump Q9
Y22	Process revers valve Y22

Low-voltage

B21	HP flow sensor B21
B71	HP return sensor B71
B81	Hot-gas sensor B81
B83	Refrig sensor liquid B83
B84	Source outl sens B92/B84
B91	Source inlet B91
B92	Source outl sens B92/B84

Condenser

Speed limitation for condenser pump for DHW and cooling

Line no.	Operating line
2776	Pump speed min with DHW
2777	Pump speed max with DHW
2778	Pump speed min cool mode
2779	Pump speed max cool mode

Pump speed min/max

This setting limits minimum and maximum speed of the condenser pump during DHW charging and cooling mode.
A general description of speed-controlled condenser pumps is available under OL 2790.
The mode for the condenser pump during DHW charging to OL 2789.



During DHW charging or cooling mode, these settings replace "Pump speed min" (2792) and "Pump speed max" (2793).

High-pressure switch E10

- High-pressure switch E10 (HD pressostat) is taken into consideration only when the compressor is running.
- When the compressor is started, no consideration is given to high-pressure switch E10 for the first 3 seconds.

In general: If high-pressure switch E10 (HD pressostat) trips, the heat pump is switched off. A distinction is made between 2 types of high-pressure switch faults:

Upon start

Both the flow temperature (B21) and the return temperature (B71) lie below 20 °C. This is an indication of no flow on the consumer side.

- The heat pump goes to lockout and can only be restarted by making a reset.
- With the error message, a distinction is made if, at the time the fault occurred, DHW charging was active.
 - 223:Hi-press on start HC: When the heating circuit is started.
 - 224:Hi-press on start DHW: When DHW charging is started.

In operation

Both the flow temperature (B21) and the return temperature (B71) lie above 20 °C.

- On completion of the minimum off time (line 2843, "Compressor off time min"), the heat pump is switched on again.
- If, within the adjustable "Duration error repetition" (line 2889), high-pressure switch E10 trips several times, the heat pump initiates lockout if the number of "Repetition Error 222:High-pressure HP" (adjustable via ACS tool) is exceeded.
- If the heat pump goes to lockout, it can only be restarted by making a reset.



- In the case of 2-stage heat pumps, high-pressure switch E10 acts on both compressors.
- For information about low-pressure switch E9, refer to parameter 2825.

Line no.	Operating line
2785	Max condensation temp
2786	Max condensation temp SD
ACS	Repetition Error 222:High-pressure HP
2787	Max condensation temp red

High-pressure supervision

The objective is to prevent tripping of the high-pressure switch with the described consequences. For that, function "High-pressure supervision" (parameters 2785 and 2786) and controller-internal measures (parameter 2787) are provided.

Prerequisite: An Hx input is configured as "Press acquisition cond H83" (line 5823).

Max condensation temp,
Max condensation temp
SD

If the condensation temperature exceeds the set "Max condensation temp" (line 2785), the compressor is switched off. The compressor may be switched on again only after the condensation temperature has dropped by "Max condensation temp SD" (line 2786).

Error repetition

When using high-pressure supervision, error repetition counting within "Duration error repetition" is extended as follows:

If, in addition, high-pressure supervision with "Press acquisition cond H83" is configured, ...

- the value of "Repetition Error 222:High-pressure HP" applies (can be set with the ACS tool),
- if "High-pressure switch E10" still trips, it is no longer included in the error count, the heat pump goes immediately to lockout and can only be restarted by making a reset.

Controller-internal
measures

Measures taken by the controller influence plant components in a way that "Max condensation temp" will not be exceeded.

Max condensation temp
red

They intervene as soon as the temperature level of "Max condensation temp" minus "Max condensation temp red" is exceeded (line 2787).

The following plant components – if installed and controllable – are influenced in the following order:

	Strategy	Heating	Cooling
		<i>Component: Internal measure</i>	<i>Component: Internal measure</i>
1	Maximization of output delivered	Condenser pump: Speed is increased	Source pump/fan: Speed is increased
2	Reduction of output	Compressor: Output is reduced 2nd stage is switched off	Compressor: Output is reduced 2nd stage is switched off
3.1	Reduction of input	Expansion valve: Evaporation pressure is reduced*	Expansion valve: Evaporation pressure is reduced*
3.2		Or: Source pump/fan: Speed is reduced	Condenser pump: Speed is reduced
4	Suppression of requests	Consumer: Storage tank charging (DHW) is aborted	-

* For technical principle, refer to parameter 3056

Condenser pump

Line no.	Operating line
2788	Modulation cond pump DHW - - - None HP setpoint Compressor output Temp diff condenser
2789	Condenser pump with DHW Off On

Modulation cond pump
DHW

The strategy for speed control "Modulation cond pump DHW" can be selected. The same options are available as for "Modulation condenser pump" (OL 2790) and "Modulation condens pump cooling" (ACS).

A detailed description is available at OL 2790.

Condenser pump with
DHW

Parameter "Condenser pump with DHW" is used to select whether the condenser pump shall operate during DHW charging.

Application example

"Condenser pump with DHW" = off

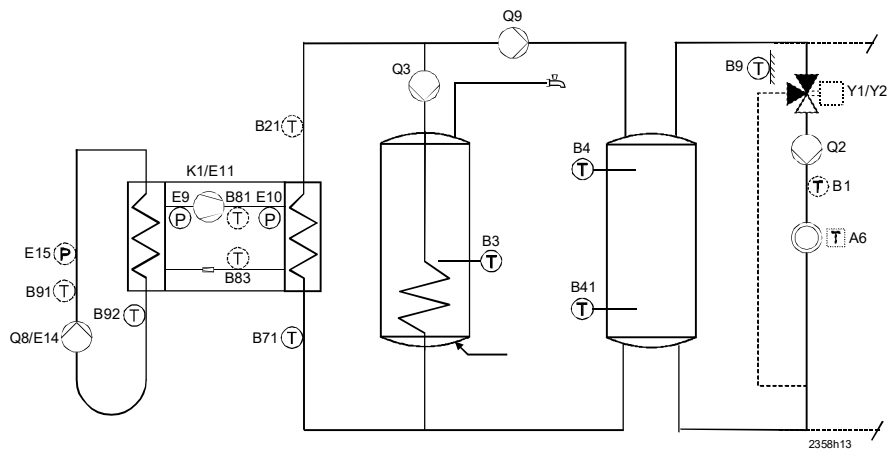

Speed-controlled condenser pump

Speed control of the condenser pump is effected via a triac (ZX) or UX output. For that purpose, the respective output is to be configured as "Condenser pump Q9".



Also, the condenser pump can be controlled via relay output (on/off).

The condenser pump's speed control can be parameterized.

- Choice of 4 speed control strategies.
- For DHW charging, another strategy of these 4 can be selected.
If "- - -" is selected, the strategy of parameter 2790 applies.
- For cooling mode, another strategy of these 4 can be selected.
If "- - -" is selected, the strategy of parameter 2790 applies.



The condenser pump operates at maximum speed, regardless of the selected control strategy:

- In passive cooling mode with the condenser pump.
- When the electric immersion heater in the flow is in operation.

Line no.	Operating line
2790	Modulation condenser pump None HP setpoint Compressor output Temp diff condensor
ACS	Modulation condens pump cooling - - - None Heat pump setpoint Compressor output Temp diff condensor

Setting the condenser pump's modulation

For "Modulation condenser pump" (line 2790) and, if required, for "Modulation condens pump DHW" (2788) and "Modulation condens pump cooling" (ACS), the following speed control strategies are available:

None

The speed of the condenser pump is not controlled. Speed output corresponds to the parameterized "Pump speed max" (line 2793).



- Exception: If the condenser pump operates only to ensure frost protection, it runs at the parameterized "Pump speed min" (line 2792).
- Heat pump monitoring functions can reduce the speed down to the parameterized "Pump speed min". To make certain, for example, that the maximum evaporation temperature will not be exceeded in cooling mode.

HP setpoint

The control strategy lowers the pump speed to such a level that the required heat pump setpoint at flow temperature sensor B21 is reached.

The speed of the condenser pump is calculated such that it can be reduced to the permissible minimum ("Pump speed min", line 2792) only when the compressor operates at full capacity.

Compressor output

The speed of the condenser pump is controlled according to the compressor output currently released. The action depends on the type of heat pump.

- 1-stage compressor

When the compressor is in operation, the condenser pump runs at maximum speed.

When the compressor is off, the condenser pump runs at minimum speed.

- 2-stage compressor

When both compressors are in operation, the condenser pump runs at maximum speed.

When one compressor is in operation, the condenser pump runs at maximum speed minus the minimum speed, divided by 2 .

When both compressors are off, the condenser pump runs at minimum speed.

- Modulating compressor

With this function, the speed of the condenser pump depends directly on the compressor's current output.

If the compressor's output is $\leq 20\%$, the speed of the condenser pump is maintained at the minimum.

If the compressor's output is $\geq 80\%$, the speed of the condenser pump is maintained at the maximum.

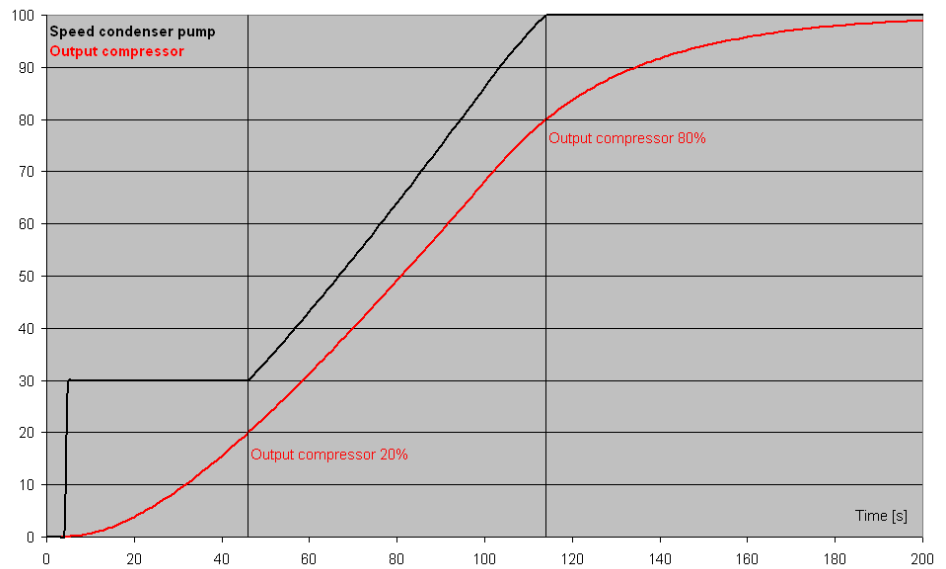

2355Z42

Temp diff condenser

The strategy controls the pump speed such that the parameterized temperature differential of heat pump flow and heat pump return is maintained.

- Setting for heating mode via "Req temp diff condenser" (line 2805).
- If the strategy is used for DHW charging as well, either explicitly or implicitly, "Req temp diff condens DHW" (ACS) offers a separate setting.
- In cooling mode, parameter "Temp diff cond cooling mode" (line 3008) is used.

Condenser pump speed under special operating conditions

In general, the condenser pump's speed is controlled according to the selected control strategy (line 2790 ff.).

However, with certain operating states, the selected control strategy is not suited or cannot be applied.

The following table shows the condenser pump's speed behavior in such cases:

#	Plant state	Note	Condition	Speed behavior
1	Frost protection for the plant	Line 2800	Condenser pump operates only if frost protection for the plant is required	Minimum speed
2.1	Frost protection for the condenser	Line 2810	Condenser pump operates only if frost protection for the condenser is required	Minimum speed
2.2			Condenser pump operates only if frost protection for the condenser is required and electric immersion heater or compressor is in operation	According to strategy
3	Pump prerun	Line 2802		According to strategy ¹⁾
4	Pump overrun	Line 2803		According to strategy ^{1), 2)}
5.1	With electric immersion heater, emergency operation	Not for emergency operation	Generally when electric immersion heater is in operation	Maximum speed
5.2			Strategy "HP setpoint" and electric immersion heater located upstream of flow temperature sensor B21	According to this strategy
5.3			Strategy "Temp diff condenser" and electric immersion heater located upstream of flow temperature sensor B21 and compressor in operation	According to this strategy
6	Passive cooling mode			Maximum speed
7	Automatic sensor readjustment	Line 3030		Maximum speed
8.1	Defrost with compressor	Process reversal	Strategy "HP setpoint" or "Temp diff condenser" and compressor on and storage tank charging active (buffer or DHW)	Minimum speed
8.2			Strategy "HP setpoint" or "Temp diff condenser" and compressor on and storage tank charging inactive (buffer or DHW)	Maximum speed
8.3			Strategy "HP setpoint" or "Temp diff condenser" and compressor off (condensation)	Minimum speed
8.4			Strategy "Compressor output"	According to this strategy
9	Defrost with fan			According to strategy ¹⁾
10	Defrost with external heat pump	Input at X75		Same: Defrost with compressor
11	Pump off refrigerant	Line 3058		According to strategy ²⁾
12	Pump off refrigerant, manually	Line 7153		Maximum speed

1) In practical operation usually "minimum speed"

2) When controlling to the setpoint and there is no more request, the setpoint valid last is maintained

Line no.	Operating line
2792	Pump speed min
2793	Pump speed max

Pump speed min/max

These settings ensure minimum and maximum limitation of the condenser pump speed.

<i>Line no.</i>	<i>Operating line</i>
2794	Speed Xp
2795	Speed Tn
2796	Speed Tv

Pump speed

The speed of the pump is controlled by a PID controller.

Parameters Xp, Tn, and Tv

By setting the right proportional band Xp, integral action time Tn, and the derivative action time Tv, the control action can be matched to the type of plant (controlled system).

Xp, Tn and Tv can be determined using common methods, e.g. the step response method depicted in Section "Xp, Tn, Tv – Step response method".

Brochure BT_0098_EN provides additional notes on control technology in buildings.

Line no.	Operating line
2799	Pump setpoint reduction

Pump setpoint reduction

The purpose of pump setpoint reduction is that in the case of speed control to the heat pump setpoint and an output-controlled compressor, the speed of the condenser pump is reduced to the permissible minimum (line 2792) only when the compressor operates at full capacity.

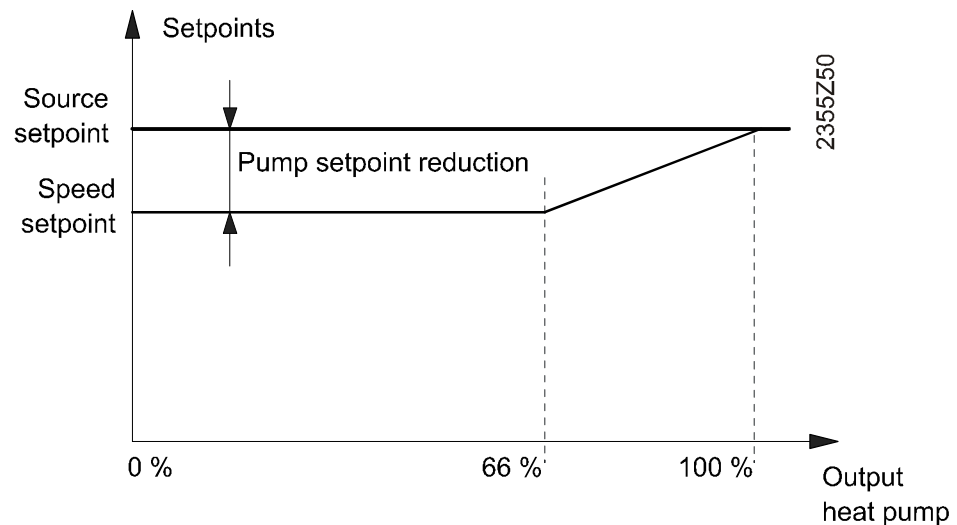

With pump setpoint reduction

When the compressor operates at low output (<66%), the setpoint for speed control is reduced by a selectable difference.

When the compressor's output exceeds 66%, the setpoint for the speed is increased in a way that at 100% heat pump output, the setpoint used for calculating the speed corresponds to the heat pump setpoint.

This prevents the heat pump from reaching the setpoint when the compressor's output is reduced and the pump's speed is kept at a low level.

Without pump setpoint reduction

If setpoint reduction is deactivated (Pump setpoint reduction = 0 °C), following applies:

- The pump's speed is reduced only when the compressor delivers 100% output.
- The compressor's output is reduced only when the pump speed reaches its maximum.



In all cases, following applies: The setpoint for speed control is limited to a level of 2 Kelvin below the maximum switch-off temperature.

<i>Line no.</i>	<i>Operating line</i>
2800	Frost prot plant cond pump Off On
2801	Control cond pump Automatically Temp request Parallel compr operation
2802	Prerun time cond pump
2803	Overrun time cond pump

Frost prot plant cond pump

It can be defined whether or not the condenser pump shall be put into operation when frost protection for the plant is activated.

Off

Off

The condenser pump does not run when frost protection for the plant is active.

On

The condenser pump runs when frost protection for the plant is active..

Control cond pump

The setting defines whether the pump shall run when there is a valid request or only when the compressor is in operation.

Automatically

The controller decides when the condenser pump needs to be switched on, based on the origin of the requests.

Temp request

The condenser pump starts running as soon as there is a valid temperature request.

Parallel compr operation

The condenser pump runs when the compressor is in operation.

The condenser pump also runs when the electric immersion heater installed in the flow is in operation.



The condenser pump can also be activated by the following functions:

- Frost protection for the plant
- Frost protection for the heat pump.
- Storage tank recooling.
- Passive cooling



In the event of a heat pump failure, the condenser pump is deactivated until the fault is corrected.

Prerun time cond pump

Prior to starting the compressor, the condenser pump must be activated, enabling the sensors to acquire the correct temperature.

Overrun time cond pump

When the compressor is switched off, the condenser pump continues to run for the set overrun time.

Condenser

<i>Line no.</i>	<i>Operating line</i>
2804	Max temp diff condenser
2805	Req temp diff condenser
ACS	Req temp diff condens DHW
2806	Max dev temp diff cond
2807	Min temp diff cond DHW
2808	Req temp diff condens DHW
2809	Temp frost alarm
2810	Condenser frost protection
2811	Overrun cond frost protect

Temperature differential: Condenser

This is the temperature differential of the medium on the consumer side between condenser inlet (B71) and condenser outlet (B21).

The function described below is only active when both sensors are installed.

Max temp diff condenser

The speed of the condenser pump is only reduced to such a level (see line 2799) that the maximum temperature differential across the condenser ("Max temp diff condenser") will not be exceeded.

Req temp diff condenser

"Req temp diff condenser" is the temperature differential anticipated across the condenser with maximum compressor output in heating mode. The setting is used for different functions (e.g. speed control of condenser pump, parameter 2790 ff.).

Req temp diff condens DHW

"Req temp diff condens DHW" (2808) is the temperature differential to be expected at the condenser when the compressor operates at maximum capacity for DHW charging. If "-" is selected, DHW charging also uses parameter 2805. The setting is used for speed control of the condenser pump (parameter 2790 and parameter 2788 for DHW charging).

Max dev temp diff cond

Setting the maximum deviation from the required temperature differential (line 2805, "Req temp diff condenser"), either upward or downward.

If the permitted deviations are not observed, a status message is displayed.

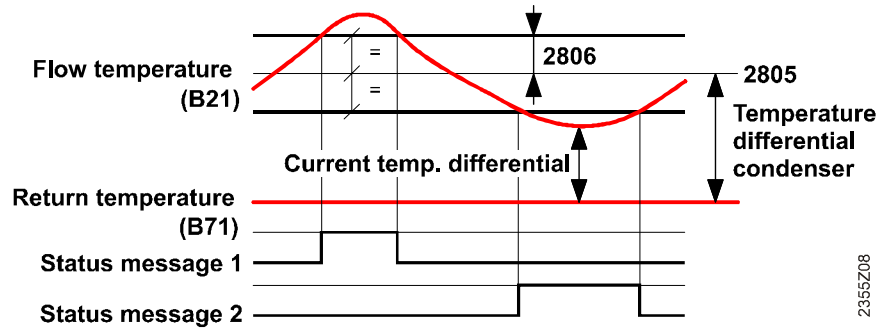

2805: Req temp diff condenser
2806: Max dev temp diff cond
Status message 1: Limit diff condens max
Status message 2: Limit diff condens min

- For a too great or too small a temperature differential to be displayed as a status message, the compressor must have run for a minimum of 3 minutes and DHW charging must not be active.
- When changing from DHW charging to space heating, the controller waits another 3 minutes until it displays too great a deviation.
-



- The function can be deactivated.
- In cooling mode, the function is automatically deactivated.
- With air-to-water heat pumps, the function is automatically deactivated.

Min temp diff cond DHW

Function "Min temp diff cond DHW" is used to abort DHW charging when the external heat pump is shut down.

During DHW charging, the temperature differential across the condenser (between sensors B21 and B71) must not drop below the value set here.

- If the temperature differential is too small, DHW charging is aborted.
- If several charging attempts are permitted (line 2893, "Number DHW charge attempts"), the next charging attempt is made when "Compressor off time min" (line 2843) has elapsed.
- If the charging attempts are unsuccessful, charging can be finished via the electric immersion heater installed in the flow or the DHW storage tank.



For detailed information about the process after abortion of the charging attempt, refer to the description given under "Number DHW charge attempts" (line 2893).

Temp frost alarm

"Temp frost alarm" provides a function for "internally" controlled and external heat pumps:

- In the case of "internally" controlled heat pumps, the process reversing valve is monitored. If valve seizing occurs (e.g. after defrosting), the plant is prevented from freezing up.
- With external heat pumps, the plant is prevented from freezing up when the heat pump operates in cooling mode in place of heating mode.

If the temperature at the flow sensor B21 drops below the adjustable frost alarm level, the heat pump is shut down and can only be put back into operation by making a reset (fault "201:Frost alarm").

For the alarm to be delivered, a process reversing valve must be parameterized and the compressor must run for a minimum of 15 seconds.

The function can be deactivated (setting "- -").

Condenser frost protection

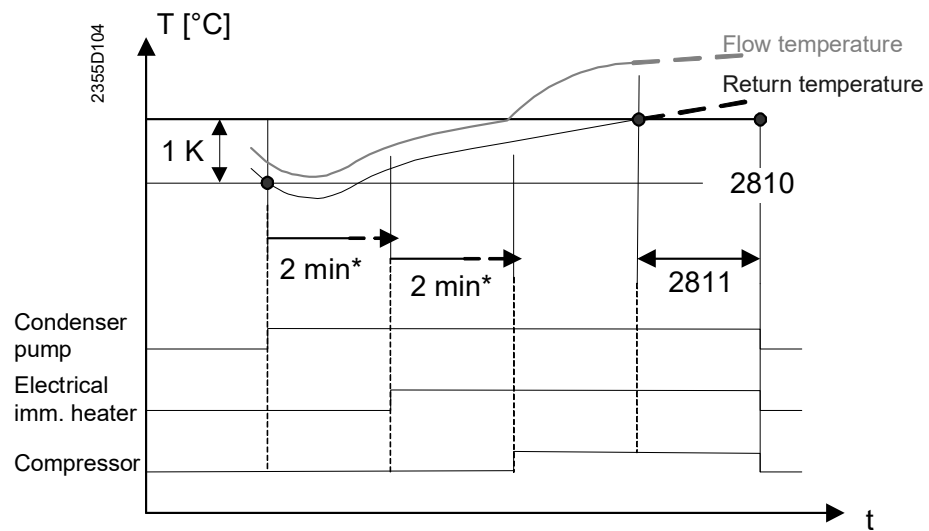

2810 Condenser frost protection 2811 Overrun cond frost protect

* Or 2811 (Overrun cond frost protect) if >2 minutes

Overrun cond frost protect
Heating mode

"Condenser frost protection" is ensured by a multi-stage process.

- If the flow temperature (B21) or the return temperature (B71) falls below the set frost protection level (line 2810), the condenser pump is activated.
- If, after 2 minutes or – if longer – after "Overrun cond frost protect" (line 2811), both the flow and the return temperature do not reach the frost protection level (line 2810) plus 1 Kelvin, the electric immersion heater in the flow is switched on as well.



In the case of a 3-stage electric immersion heater (K25 and K26 parameterized), both relays are energized.

- If, after another 2 minutes or – if longer – after "Overrun cond frost protect" (line 2811), both the flow and the return temperature do not reach the frost protection level (line 2810) plus 1 Kelvin, the electric immersion heater in the flow is switched on as well.

After successful "Condenser frost protection", the switch-off behavior is as follows:

- If both the flow and return temperature reach the frost protection level (line 2810) plus 1 Kelvin, condenser pump, electric immersion heater and compressor remain in operation during "Overrun cond frost protect" (line 2811).
- Then, the 3 aggregates are switched off.

The function can be deactivated ("- -").

CAUTION

- If the function is deactivated, frost protection is no longer ensured.
- Frost protection temperatures below 5 °C are permitted only if the distribution system on the consumer side is filled with antifreeze. If the temperature is extremely low, the heat exchanger can be damaged beyond repair.

Overrun cond frost protect
Cooling mode

In cooling mode, frost protection for the condenser operates in the reverse sense.

If the flow temperature (B21) or the return temperature (B71) falls below the set frost protection level (line 2810), the condenser pump is activated.

If both the flow and the return temperature reach the frost protection level (line 2810) plus 1 Kelvin, the heat pump remains locked during "Overrun cond frost protect" (line 2811).



The condenser pump remains in operation during the whole time.

Evaporator

Source pump Functional interrelationships

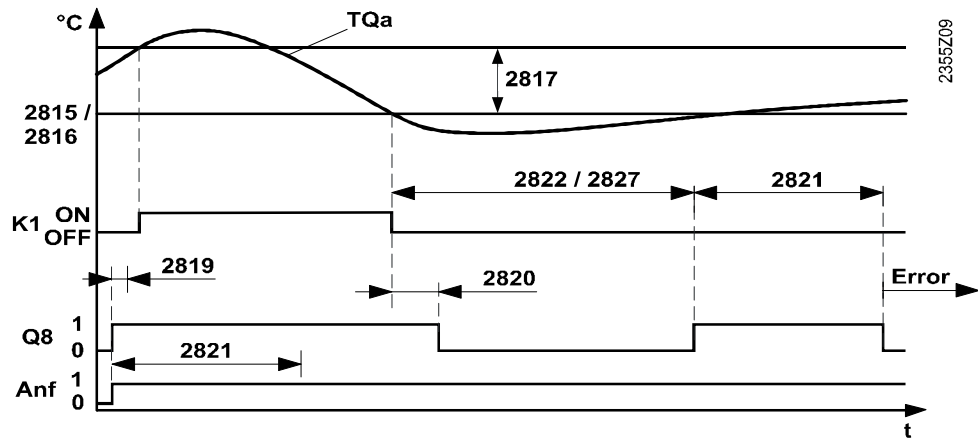

2815	Source temp min water
2817	Switching diff source prot
2821	Source startup time max
2822	T'limit source temp min brine
2827	Time limit source temp
TQa	Source outlet temperature
K1	Compressor
Q8	Source pump
Anf	Heat request

Operation limit

Line no.	Operating line
2812	Operation limit OT min air
2813	Operation limit OT max air

Operation limit OT min
air

If, with an air-to-water heat pump, the outside temperature falls below the level set here, the controller locks the heat pump. It will be released again as soon as the outside temperature exceeds the set limit by 2 Kelvin.

Operation limit OT max
air

If, with an air-to-water heat pump, the outside temperature exceeds the set level, the controller locks the heat pump. It will be released again as soon as the outside temperature falls 2 Kelvin below the set limit.

Minimum and maximum source temperature

<i>Line no.</i>	<i>Operating line</i>
2814	Source temp max
2815	Source temp min water
2816	Source temp min brine
2817	Switching diff source prot
ACS	Source protection with substitute sensor
2818	Incr source temp min fl cur
ACS	Increase source temp min

Source temp max

If the source inlet temperature (B91) lies above the maximum source temperature (parameter dependent on the type of heat pump, see below), the compressor is not switched on and the source pump keeps running. If the source inlet temperature drops below the maximum source temperature minus 1 °C, the compressor is switched on.

If, on completion of the maximum source startup time (2821), the compressor does not run, the source pump is switched off. After the set minimum off time, the controller tries to restart the compressor. The pumps are put into operation and the compressor is started, provided the maximum source temperature is not exceeded.

When the compressor is in operation and the source inlet temperature exceeds "Source temp max", the compressor is switched off and, on completion of the minimum off time, the controller tries to switch the heat pump on again.

If the source inlet temperature is not available, the function uses the source outlet temperature.



Parameter 2814 only acts in heating mode.

Distinction between heat pump types

- In the case of brine-to-water or water-to-water heat pumps, parameter 2814 is used as the threshold (maximum source temperature).
- In the case of air-to-water heat pumps, parameter 2813 is used as the threshold (maximum source temperature). This means that with air-to-water heat pumps, "Source temp max" is available without parameterizing operating line 2814 (instead, the function makes use of parameter 2813).

Source temp min water

This function prevents the heat pump from operating when the source outlet temperature is too low. The function is intended for plants that use water as a heat source.

If, during operation, the source outlet temperature drops below "Source temp min water", both the pumps and the compressor are switched off for an adjustable period of time ("Time limit source temp", parameter 2827).

Source temp min brine	<p>The function shall prevent the source from cooling down excessively. It is intended for plants that use geothermal energy as the source of heat.</p> <p>If, during operation, the source outlet temperature drops below "Source temp min brine", both the pumps and the compressor are switched off for an adjustable period of time ("T'limit source temp min brine", parameter 2822).</p> <p>Compared to function "Source temp min water" (line 2815), the following additional differences exist, which must be observed:</p> <ul style="list-style-type: none"> • "Source prot sens brine HP" (parameter 5804) can be used to select whether the temperature at the source inlet or source outlet shall be considered. • During the time the "Floor curing" function is performed, the controller automatically raises the minimum source temperature by the value set on operating line 2818.
	<p> During "T'limit source temp min brine" (line 2822), the electric immersion heaters installed in the flow are activated.</p>
Switching diff source prot	<p>After the set maximum source startup time (line 2821), the source temperature must exceed the source protection temperature (line 2815 or 2816) by at least "Switching diff source prot" (line 2817) to ensure the compressor is switched on.</p>
Source protection with substitute sensor (ACS)	<p>In the event the temperature sensors B91 or B92 fail (Line 5804 "Source prot sens brine HP"), the source can be operated using the other source sensor as a substitute.</p> <p>The controller calculates the setpoint on the other sensor to include the required temperature differential evaporator (Line 2823) to maintain the minimum source temperature (Line 2815 or 2816).</p> <p>Heat source water</p> <p>The source outlet temperature B92 is used for source protection. The minimum source temperature is therefore configured for B92. The source inlet sensor B91 can be used as a substitute.</p> <p>Substitute mode with source inlet sensor B91: Source temperature minimum water HP+ temperature differential evaporator (Parameter 2815 + parameter 2823)</p> <p>Heat source brine</p> <p>Depending on the configuration, the source outlet temperature at B92 or the source inlet temperature at B91 is used for source protection. The minimum source temperature thus applies to the selected source protection sensor.</p> <p>B91 or B92 can be used as a substitute.</p> <p>Substitute mode with source inlet sensor B91: Source temperature minimum brine HP + Temperature differential evaporator (Parameter 2816 + Parameter 2823)</p> <p>Substitute mode with source outlet sensor B92: Source temperature minimum water HP – Temperature differential evaporator (Parameter 2816 - Parameter 2823)</p>
Incr source temp min fl cur	<p>With brine-to-water heat pumps, the controller automatically raises the minimum source temperature (line 2816) by the adjustable value "Increase source prot temp" during the time the "Floor curing" function is performed.</p>

Increase source temp min (ACS) The system tries to maintain the adjusted setpoint (minimum source temperature plus "Increase source temp min" (ACS)).

Controller-internal measures If the source temperature approaches the parameterized minimum, other plant components are influenced to prevent the temperature from dropping below its minimum. The following plant components – if installed and controllable – are influenced in the following order:

	Strategy	Heating
		Component: Internal measure
1	Reduce evaporator differential	Source pump speed is increased *
2	Reduction of output	Compressor: Output is reduced. 2nd stage is switched off

* When source is brine only if source protection sensor (5804) = B92

 The minimum source temperature is only monitored in heating mode.

Times

Line no.	Operating line
2819	Prerun time source
2820	Overrun time source
2821	Source startup time max
2822	T'limit source temp min brine
2827	Time limit source temp

Prerun time source Before putting the compressor into operation, the source pump (or the fan in the case of an air-to-water heat pump) need be activated, ensuring that the refrigerant passes through the evaporator, enabling the sensors to acquire the correct temperature.

Overrun time source When the compressor is switched off, the source pump (or the fan in the case of an air-to-water heat pump) continues to operate for the set overrun time.

Source startup time max If, during "Prerun time source" (line 2819), the source temperature does not reach the required level (line 2815 or line 2816 plus 2817), the heat pump continues to operate until "Source startup time max" is reached (line 2821).
If, during "Source startup time max" too, the source temperature does not reach the required level (line 2815 or line 2816 plus 2817), the heat pump goes to lockout. The fault must be manually reset.

T'limit source temp min brine Refer to description of "Source temp min brine" (line 2816).

Time limit source temp See use of "Time limit source temp" with function "Source temp min water". Also note: This setting is used in connection with all problems associated with the source.

 In the event of a heat pump failure, the source pump will stay deactivated until the fault is corrected.

<i>Line no.</i>	<i>Operating line</i>
2823	Req temp diff evaporator
ACS	Required temp diff evaporator cooling mode
2824	Max dev temp diff evap

Req temp diff evaporator Setting the required temperature differential (cooling down) of the medium (water-brine) between evaporator inlet (B91) and evaporator outlet (B92).

Required temp diff evaporator cooling mode (ACS) Separate setpoint for cooling mode, analogous to parameter 2823.

Max dev temp diff evap Maximum deviation from the required temperature differential, either upward or downward.
 If the measured deviation is greater than the set maximum deviation, the relevant status message appears, provided the compressor was previously in operation for at least 3 minutes.

 In cooling mode and when using air-to-water heat pumps, parameters 2823 and 2824 are not active .

Low-pressure switch E9 If low-pressure switch E9 (ND pressostat) trips, the heat pump is switched off. On completion of the minimum off time (line 2843, "Compressor off time min"), the heat pump is switched on again.

If, within "Duration error repetition" (line 2889), the low-pressure switch trips several times, the heat pump goes to lockout if the number of "Repetition Error 225:Low-pressure HP" is exceeded.

If the heat pump has gone to lockout, it can only be restarted by making a manual reset.

- 
- For settings in connection with low-pressure switch E9, refer to parameters 2853 and 2854.
 - For information about high-pressure switch E10, refer to parameter 2785.

Line no.	Operating line
2825	Min evaporation temp
ACS	Min evaporation temp switching diff
ACS	Min evaporation temp cooling mode
ACS	Min evaporation temp increase
2828	Min evaporation temp water

Low-pressure supervision

The objective is to prevent tripping of the low-pressure switch with the described consequences. For that, function "Low-pressure supervision" (parameters 2825 and 2828) and controller-internal measures (parameter 2787) are provided.

Prerequisite: An Hx input is configured as "Press acquisition evap H82" (line 5822).



The settings for parameters 2852...2854 also apply to monitoring with a pressure sensor as described here.

Min evaporation temp

If the evaporation temperature falls below "Min evaporation temp" (line 2825), the compressor is switched off. The compressor may be switched on again only when the evaporation temperature has risen by "Min evaporation temp switching diff" (ACS).

In addition, if an electronic expansion valve is installed, the evaporation temperature must exceed "Min evaporation temp" by more than the current superheat setpoint plus the "Switching diff source prot" (Line 2817).

Cooling mode

For cooling mode, "Min evaporation temp cooling mode" can be set separately (ACS).



When changing from heating to cooling mode, or vice versa, the lower of the 2 limit values applies during "Settl'time process reversal" (line 2838).

Min evaporation temp water

For water-to-water heat pumps, a separate minimum value "Min evaporation temp water" can be set.

Controller-internal measures

If the evaporation temperature approaches "Min evaporation temp increase" within less than 3 Kelvin (can be set via "Min evaporation temp increase"(ACS)), the following measures are initiated concurrently:

The input is maximized by...

- increasing the speed of the source pump/fan in heating mode,
- increasing the speed of the condenser pump in cooling mode.

The integral action time of the superheat controller is reduced in a linear manner to 50% of the set time (line 3044, "Superheat controller Tn"). This means that the valve opens more quickly*.

* This measure necessitates an expansion valve. It suits a faster drop of the evaporation temperature (e.g. in the case of quick load changes)

<i>Line no.</i>	<i>Operating line</i>
2826	Max evaporation temp
ACS	Max evaporation temp delay
ACS	Repetition Error 491:Max evaporation temp
ACS	Max evaporation temp cooling mode
ACS	Max evaporation temp reduction

Max evaporation temp

When the compressor is in operation and the evaporation pressure exceeds "Max evaporation temp" (line 2826), the compressor is switched off.- {}- The compressor may be switched on again only when the minimum off time (line 2843, "Compressor off time min") has elapsed.



When the compressor is started and when the process reversing valve changes over, no consideration is given to "Max evaporation temp" during "Max evaporation temp delay" (ACS).

If, during the adjustable "Duration error repetition" (line 2889), "Max evaporation temp" is exceeded several times, the heat pump goes to lockout as soon as the number of "Repetition Error 491:Max evaporation temp" (ACS) is exceeded.

If the heat pump has gone to lockout, it can only be restarted by making a reset.

Cooling mode

For cooling mode, "Max evaporation temp cooling mode" can be set separately (ACS).



When the process reversing valve changes over, "Max evaporation temp" (line 2826) is not monitored during "Settl'time process reversal" (line 2838).

Controller-internal measures

Measures taken by the controller influence the plant components in a way that "Max evaporation temp" will not be exceeded. They try to maintain "Max evaporation temp" minus "Max evaporation temp reduction" (ACS tool). The following plant components – if installed and controllable – are influenced in the following order:

	<i>Strategy</i>	<i>Heating</i>	<i>Cooling</i>
		<i>Component: Internal measure</i>	<i>Component: Internal measure</i>
1.1	Reduction of input	Expansion valve *: Evaporation pressure is reduced	Expansion valve *: Evaporation pressure is reduced
1.2	Reduction of input	Or: Source pump/fan: Speed is reduced	Or: Condenser pump: Speed is reduced

* For technical principle, refer to parameter 3056

Line no.	Operating line
2829	Ext range min evap temp
2830	Max dur ext min evap temp

This function allows the evaporation temperature to drop below its minimum limit for a certain period of time.

When the function is activated, "Min evaporation temp" (line 2825) is reduced by the set differential (Ext range min evap temp).

When "Max dur ext min evap temp" has elapsed, the normal limit of parameter 2825 applies again.



- The time the heat pump operated in the extended range is accumulated by an hours run meter and shown on line 8448 (menu "Diagnostics heat generation").
- In the case of air-to-water heat pumps, minimum source temperature monitoring (line 2812, "Operation limit OT min air") also applies to the extended range.

Compressor

Compressor control without buffer or combi storage tank

If there is **no** buffer or combi storage tank, the compressor is switched on and off according to the return temperature (B71) and the "Switching diff return temp" (line 2840).

The return temperature setpoint is used to calculate the switch-on or switch-off point. It is calculated based on the demanded flow temperature setpoint and the "Differential HC at OT -10°C" (line 5810). The adjustable "Switching diff return temp" (line 2840) lies symmetrically about the calculated return temperature setpoint.

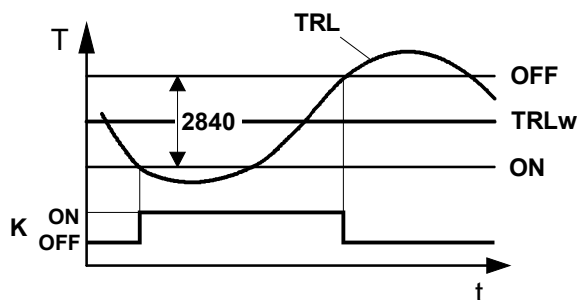

2840	Switching diff return temp
OFF	Switch-off point
ON	Switch-on point
TRLw	Return temperature setpoint
K	Compressor

The switch-on/off points are influenced by a number of other functions (maximum switch-off temperature, compensation of heat deficits, compressor running time minimum, compressor off time minimum, pump prerun time, and pump overrun time).

Required sensors

To enable the controller to put the heat pump into operation without control of a buffer or combi storage tank, at least the return temperature sensor (B71) and the relevant source temperature sensor must be installed. In the case of air-to-water heat pumps, the evaporator temperature sensor (B84) is required also.

Compressor control with buffer or combi storage tank

If a buffer or combi storage tank is installed, the controller uses sensors B4 and B41 to control the compressor. "Switching diff return temp" (line 2840) has no impact.

If there is no sensor B41, heat pump return temperature sensor B71 is used. The heat pump is switched on as soon as there is a heat request from the buffer storage tank. Control is effected via the buffer storage tank's automatic generation lock (see parameter 4720).

Required sensors

- In the case of control with a buffer or combi storage tank, the buffer storage tank sensor at the top (B4), the storage tank sensor at the bottom (B41) and the relevant source sensor must be installed.
- If the buffer storage tank sensor at the bottom (B41) is missing, the controller uses the return temperature sensor (B71) to switch the heat pump off.



If a solar application is configured, sensor B41 is not considered for full charging of the buffer storage tank. Sensor B71 is switched off. Sensor B41 is reserved for the "Solar" function.

Overview of switching points for staged and modulating HP

A number of factors determine which sensor is used to control to which setpoint. The following table provides an overview of the plant configurations and sensors used to maintain the various setpoints. Prerequisite is always a valid heat request to the heat pump.



Behavior in case of faults is not considered here and not all cases listed may represent practical plant configurations.

	Sensors		5810 ¹⁾	Compressor type				
	B21	B71		Staged		Modulating		
				K1/K2 On	K1/K2 Off	Basic stage On (K1)	Basic stage Off (K1)	Setpoint modulation (Bx = Sensor)
No demand from storage tank	no	no	x	Off: Err138 "No control sensor HP"		Off: Err138 "No control sensor HP"		
	no	yes	x	$B71 < T_{RLw} - SD/2$	$B71 > T_{RLw} + SD/2$	$B71 < T_{RLw} - SD/2$	$B71 > T_{RLw} + SD/2$	$T_{RLw} \pm 0.75K (B71)$
	yes	no	x	Off: Err138 "No control sensor HP"		$B21 < T_{Vw} - SD/2$	$B21 > T_{Vw} + SD/2$	$T_{Vw} \pm 0.75K (B21)$
	yes	ok	= 0	$B71 < T_{RLw} - SD/2$	$B71 > T_{RLw} + SD/2$	$B71 < T_{RLw} - SD/2$	$B71 > T_{RLw} + SD/2$	$T_{RLw} \pm 0.75K (B71)$
			> 0	$B71 < T_{RLw} - SD/2$	$B71 > T_{RLw} + SD/2$	$B21 < T_{RLw} - SD/2$	$B21 > T_{RLw} + SD/2$	$T_{Vw} \pm 0.75K (B21)$
Demand from storage tank ²⁾	no	no	x	On	³⁾	Off: Err138 "No control sensor HP"		
	no	ok	x	On	³⁾	On	³⁾	$T_{RLw} \pm 0.75K (B71)$
	yes	no	x	On	³⁾	On	³⁾	$T_{Vw} \pm 0.75K (B21)$
	yes	yes	x	On ⁴⁾	³⁾	On ⁴⁾	³⁾	$T_{Vw} \pm 0.75K (B21)$

¹⁾ "Differential HC at OT -10°C" (OL5810)

²⁾ Heat demand comes from a storage tank (DHW, heating circuit via buffer, forced charging)

³⁾ Safety functions switch off compressor (high pressure, hot gas, switch-off temperature)

⁴⁾ B21 is used for the enable and reset integral of the 2nd compressor stage.

T_{Vw} = Flow setpoint

T_{RLw} = Return setpoint

SD = "Switching diff return temp" (OL2840)

Sensor states: Yes (Sensor available), no (Sensor not available), x (No influence)

Parameter setting: x (No influence)



For different legal norms on cascades, see section "6.12".

Crankcase heater

Line no.	Operating line
2832	Setpoint crankcase heater

The function activates the heater via relay K40 whenever the hot-gas temperature falls below the parameterized level (line 2832). When the compressor is in operation, the crankcase heater is switched off. If the hot-gas temperature exceeds the setpoint by 5 Kelvin, the heater is switched off.

- If 2 hot-gas sensors are installed, the lower temperature is used.
- If there is no hot-gas sensor, the outside temperature acquired by sensor B9 is used.

Restart lock

Line no.	Operating line
2835	Restart lock compressor

When a compressor was switched off, it is not switched on again until the locking time has elapsed. Restart lock is observed under all operating conditions, even during defrosting.

Switch-off temperature

Line no.	Operating line
2836	Start swi-off temp red
2837	Swi-off temp max reduced

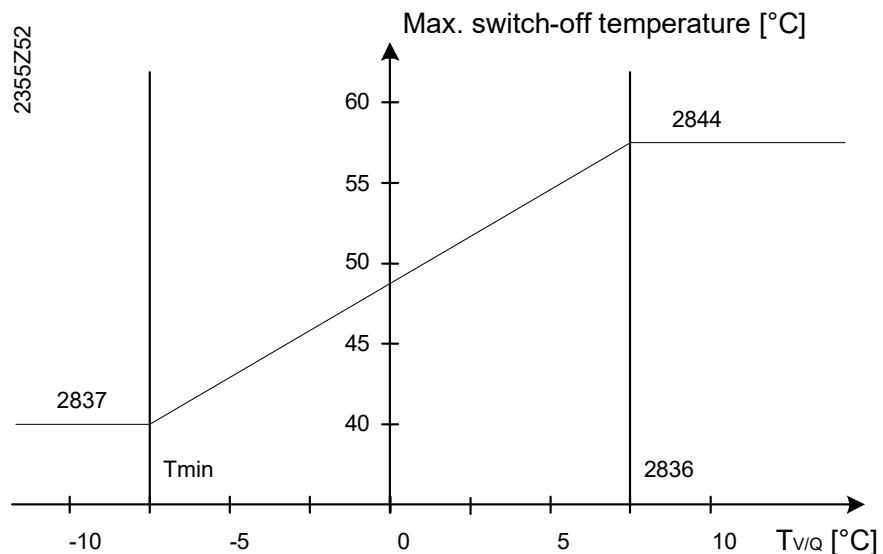

T_{min} : Depending on the type of source (line 2812, 2815, 2816, or 2825)

$T_{v/q}$: Evaporation/source temperature

2844: Switch-off temp max

The maximum switch-off temperature can be reduced while giving consideration to the evaporation or source temperature ($T_{v/q}$).

The maximum switch-off temperature is reduced in a linear manner. The reduction curve is defined by 2 points of intersection:

- Point of intersection of operating lines 2844 and 2836.
- Point of intersection of line 2837 with (line 2812, 2815, 2816 or 2825), depending on the type of source.

If the evaporation temperature is not available, a backup sensor is used for calculating the reduction. The following order applies:

<i>Prio</i>	<i>Sensor</i>	<i>Source type</i>	<i>Operating lines: Tmin</i>
1	Evaporation temperature H82	All types	2825: Min evaporation temp
2	Evaporator temperature B84	Air	2812: Operation limit OT min air
3a	Source outlet temperature B92	Brine/external	2816: Source temp min brine
3b	Source outlet temperature B92	Water	2815: Source temp min water
4	Source inlet temperature B91	Brine/external	2816: Source temp min brine
5	Outside temperature B9	External	2812: Operation limit OT min air



- If none of the sensors is available, or if the respective limitation function (Tmin) is deactivated, there will be no reduction.
- The function can be deactivated.

<i>Line no.</i>	<i>Operating line</i>
2838	Settl'time process reversal

Settl'time process reversal

If the process reversing valve is switched while the compressor is running, the heat pump requires a settling time. This period of time can be adjusted.

For the 3 functions below, the setpoints and limit values for heating and cooling mode are different. To ensure that the heat pump is not switched off, the less stringent limit value applies during "Settl'time process reversal".

- Minimum evaporation temperature (parameter 2825).
- Maximum evaporation temperature (parameter 2826).
- Superheat setpoint (parameter 3042).



The parameter descriptions specify the relevant limit values.

<i>Line no.</i>	<i>Operating line</i>
2839	Settl'time ch'over DHW/HC

Settl'time ch'over DHW/HC

DHW- or heating circuit-specific monitoring functions give consideration to the settling time and ensure smooth changeover.

When a change is made from DHW to heating mode (or vice versa) while the compressor is running, the heat pump continues to operate during the settling time while the compressor delivers its current output.

Nevertheless, safety functions are allowed to reduce the compressor's output.

Line no.	Operating line
2840	Switching diff return temp

Switching diff return temp

If the return temperature exceeds the setpoint by half the switching differential, the heat pump is switched off; if it falls below the setpoint by half the switching differential, the controller demands operation of the heat pump.

If the return temperature setpoint drops below 30 °C, the switching differential is reduced in a way that the switch-on point approaches the setpoint. At a return temperature setpoint of 20 °C, the switch-on point is identical with the return temperature setpoint.

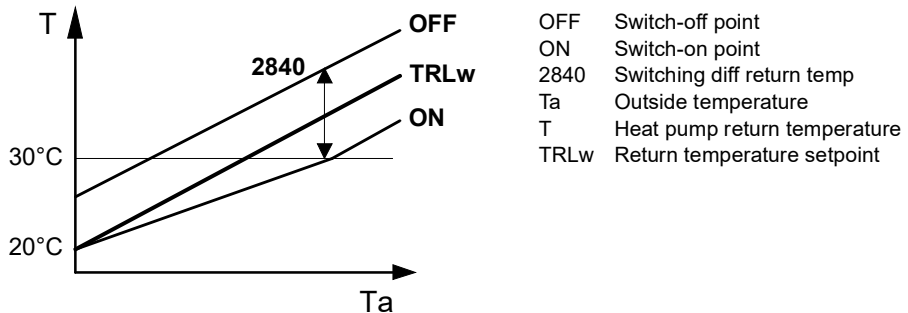

Calculation of the return temperature setpoint is explained on line 5810 ("Differential HC at OT -10 °C").



The function is not active when "Compensation heat deficit" is switched on (line 2886).

Setting the compressor

Line no.	Operating line
2841	Keep compr run time min No Yes
2842	Compressor run time min
2843	Compressor off time min

Keep compr run time min

Determines whether the minimum compressor running time set on operating line 2842 shall be observed if the heat request becomes invalid before:

No

The minimum compressor running time is **not** taken into consideration. When there is no more request for heat, the compressor is switched off.

Yes

The minimum compressor running time is also observed when there is no more request for heat.

NOTE

When using this setting, the plant must be designed such that the produced heat is also dissipated when the consumer is not in operation (e.g. via the buffer storage tank).

Compressor run time min

To prevent the compressor from getting damaged due to too frequent cycling, it always operates for at least the period of time set here, each time it is switched on.

Compressor off time min

For the same reason, the compressor remains off for the minimum period of time set here.



The minimum compressor on and off time prevents short switching cycles under low-load conditions. When operation changes (heating, cooling, DHW charging), there is no waiting until these times have elapsed. To ensure the compressor's off times are not too short, parameter 2835 "Restart lock compressor" is to be used.

Line no.	Operating line
2844	Switch-off temp max
2845	Red switch-off temp max

Switch-off temp max

If the flow or the return temperature exceeds the maximum switch-off temperature, the compressor is switched off.

The heat pump is switched on again when the temperature at both sensors (B21 and B71) dropped by the "Switching diff return temp" (line 2840) below the maximum switch-off temperature while the minimum off time elapsed.

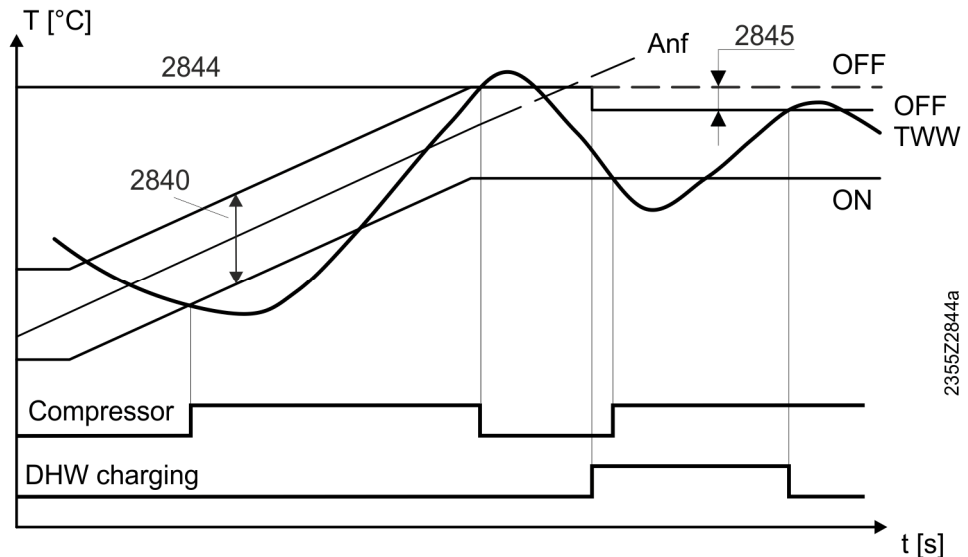

2840	Switching diff return temp	ON	Switch-on point
2844	Switch-off temp max	OFF	Switch-off point
2845	Red switch-off temp max	OFF DHW	Switch-off point DHW
Req	Consumer request		

i The settings are required in particular for plants without a buffer storage tank.

i For heating (room heating), a separate, lower limit value can be set (see OL 2855).

Red switch-off temp max

In the case of DHW charging, forced buffer storage tank charging during operation of the second compressor stage, "Switch-off temp max" (line 2844) is reduced by this value.

If the flow or the return temperature (B21/B71) exceeds this level, DHW charging or forced buffer storage tank charging is prematurely aborted and a change to space heating is made, provided the heating circuits call for heat.

In this case, the heat pump continues to operate with no interruption. During a settling time (line 2839) and after abortion of DHW charging, the heating circuit's setpoint is not taken into consideration. This means that the compressor remains in operation, regardless of the return temperature, enabling the heat pump to settle at the new temperature level.

If an electric immersion heater is installed in the DHW storage tank, it ends DHW charging and the heat pump is immediately made available for space heating. If an electric immersion heater is only fitted in the flow and parameter "Use electric flow" (line 2880) is **not** set to "Substitute", DHW charging is ended.

The compressor remains locked during this time.

If an electric immersion heater is not available, DHW charging is aborted.

Parameter "Number DHW charg attempts" (line 2893) can be used to set the number of attempts the heat pump shall make until storage tank charging is aborted or ended by an electric immersion heater.

If there is no request for heat from space heating, the heat pump is shut down. It can only be put back into operation when the minimum off time ("Compressor off time min", line 2843) has elapsed, provided the flow or return temperature (B21/B71) dropped by the amount of the adjustable switching differential ("Switching diff return temp", line 2840) below the reduced maximum switch-off temperature.

If a negative value is set for the reduction, the maximum switch-off temperature is increased by the parameterized negative reduction during the time DHW is charged. If the flow reaches the increased switch-off temperature, DHW charging is aborted.

The compressor continues to operate if space heating calls for heat. The flow temperature is not monitored during the settling time. On completion of the settling time, the compressor is switched off when the maximum switch-off temperature is reached.

Behavior with 2 compressors

If the flow or return temperature approaches the maximum switch-off temperature, compressor 2 should be switched off before compressor 1 reaches its limitation.

For this reason, compressor 2 always switches off at the maximum switch-off temperature minus the reduction and no status message will appear. Only the second stage is initially switched off if a negative reduction is parameterized and both compressor stages operate for DHW charging. The flow temperature is not monitored during the settling time. If, on completion of the settling time, the flow temperature returns to a level above the increased switch-off temperature, DHW charging is aborted.

Only the second stage is initially switched off if a negative reduction is parameterized and both compressor stages operate for space heating. The flow temperature is not monitored during the settling time. If, on completion of the settling time, the flow temperature returns to a level above the maximum switch-off temperature, the first stage is switched off as well.

NOTE	In the situations described above, the flow temperature is not monitored during the settling time if a negative value is set for "Red switch-off temp max" (parameter 2845). Other monitoring functions such as hot-gas, high-pressure, etc., are not affected.
-------------	---

Controller-internal measures

Measures taken by the controller influence plant components in a way that "Switch-off temp max" will not be exceeded. They try to maintain the level of "Switch-off temp max" minus "Red switch-off temp max" (line 2845). The following plant components – if installed and controllable – are influenced in the following order:

	Strategy	Heating
		<i>Component: Internal measure</i>
1	Maximization of output delivered	Condenser pump: Speed is increased
2	Reduction of output	Compressor: Output is reduced. 2nd stage is switched off
3.1	Reduction of input	Expansion valve *: Evaporation pressure is reduced
3.2	Reduction of input	Or: Source pump/fan: Speed is reduced
4	Suppression of requests	Consumer: Storage tank charging (DHW) is aborted

* For technical principle, refer to parameter 3056

Maximum switch-off temperature with negative reduction

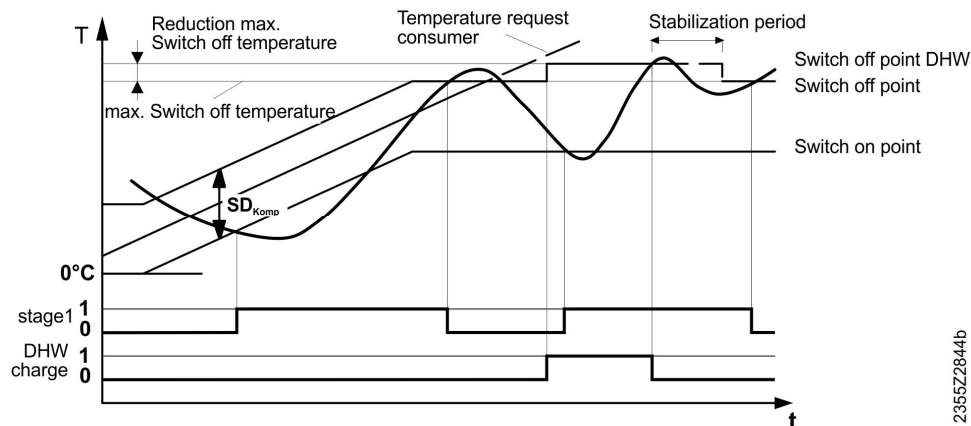

2355Z2844b

Behavior of Q9 with buffer storage tank at the maximum switch-off temperature.

If, due to "Switch-off temp max" (line 2844), the heat pump had to shut down and a new start is made, condenser pump Q9 is put into operation first and then the compressor, whenever the following criteria are satisfied:

- The minimum off time ("Compressor off time min", line 2843) has elapsed.
- The temperature at sensor B21 or B4 dropped by the switching differential (line 2840).
- A request for heat is pending.
- The buffer storage tank has not yet reached its setpoint.

The heat pump remains in operation until the buffer storage tank is charged or "Switch-off temp max" has again been reached.

Line no.	Operating line
2846	Hot-gas temp max
2847	Swi diff hot-gas temp max
2848	Reduction hot-gas temp max

Hot-gas temp max

Setting the maximum permissible hot-gas temperature of the refrigerant (B81/B82). The heat pump is shut down whenever this temperature is exceeded. The pumps continue to run for the adjusted overrun times.

If, within the adjustable "Duration error repetition" (line 2889), the fault occurs more often than the permissible maximum number of shutdowns, the heat pump goes to lockout and can be put back into operation only by making a manual reset.

Swi diff hot-gas temp max

For the heat pump to switch on again after reaching "Hot-gas temp max" (line 2846), the hot-gas temperature (B81/B82) must drop below its maximum by at least the switching differential set here.

Reduction hot-gas temp max

DHW charging or forced buffer storage tank charging via the heat pump is aborted prematurely if the hot-gas temperature (B81/B82) reaches the level of maximum hot-gas temperature (line 2846) minus the reduction set here.

The controller switches to space heating, if required.

In this case, the heat pump continues to operate without interruption, provided the switch-off condition has not yet been satisfied.

If there is no request for heat from space heating, the heat pump is shut down. It can be put back into operation only when the minimum off time (line 2843, "Compressor off time min") has elapsed, provided the hot-gas temperature has dropped below the reduced maximum hot-gas temperature by the amount of the adjustable hot-gas switching differential (line 2847, "Swi diff hot-gas temp max").



If an electric immersion heater is installed, DHW charging can be completed. Otherwise, for DHW charging to be resumed, the DHW storage tank temperature (B3) must drop by the amount of the DHW switching differential (line 5024, "Switching diff").

Controller-internal measures

Measures taken by the controller influence plant components in a way that "Hot-gas temp max" will not be exceeded. They try to maintain the adjusted setpoint ("Hot-gas temp max" minus "Reduction hot-gas temp max"). The following plant components – if installed and controllable – are influenced in the following order:

	Strategy	Heating	Cooling
		Component: Internal measure	Component: Internal measure
1	Cooling the compressor	Compressor: Vapor injection (EVI) *	Compressor: Vapor injection (EVI) *
2	Maximization of output delivered	Condenser pump: Speed is increased	Source pump Speed is increased
3	Reduction of output	Compressor: Output is reduced	Compressor: Output is reduced
4	Suppression of requests	Consumer: Storage tank charging (DHW) is aborted	-

* See description of EVI (parameter 3071 ff.)

Hot-gas temperature

Line no.	Operating line
2849	Setpoint hot-gas temp
2850	SD setp hot-gas temp
2851	Cont'type setp hot-gas temp
	NC NO

Setpoint hot-gas temp

When the hot-gas temperature of the compressor (B81) exceeds the "Setpoint hot-gas temp" set here, relay "Hot-gas temp K31" is energized.

SD setp hot-gas temp

When the hot-gas temperature of the compressor falls below the "Setpoint hot-gas temp" minus the switching differential set here, relay "Hot-gas temp K31" is deenergized.

Cont'type setp hot-gas temp

The type of contact for relay "Hot-gas temp K31" can be selected here.

NC

The contact opens when the hot-gas temperature K31 is exceeded.

NO (factory setting)

The contact closes when the hot-gas temperature K31 is exceeded.

Low-pressure switch

<i>Line no.</i>	<i>Operating line</i>
2852	LP delay on startup
2853	LP delay during operation
2854	LP supervision Always ; Without defrosting

LP delay on startup

When starting the compressor, no consideration is given to the low-pressure switch (E9) during the period of time set here.



When the process reversing valve changes over, no consideration is given to the low-pressure switch (E9) also during the period of time set here.

LP delay during operation

If the low-pressure switch (E9) trips during operation, the controller waits the period of time set here before switching the heat pump off. This is to make certain that the heat pump will not be switched off each time the low-pressure switch trips for a short moment.

LP supervision

Defines monitoring by the low-pressure switch (B9) during the time the "Defrost" function is active.

Always

The low-pressure switch is always taken into consideration.

Without defrosting

The low-pressure switch is not taken into consideration during the time the "Defrost" function is active.



This function only acts on air-to-water heat pumps.

Monitoring

<i>Line no.</i>	<i>Operating line</i>
ACS	Supervision soft starter Always With compr operation
ACS	Supervision low-pressure Always With compr operation
ACS	Supervision high-pressure Always With compr operation
ACS	Supervision overload compressor Always With compr operation
ACS	Supervision 3-phase current/mains Always With compr operation
ACS	Supervision overload source Always With source operation
ACS	Supervision pressure switch source (E26) Always With source operation According to heat source
ACS	Supervision pressure switch source intermed circ Always With source operation
ACS	Supervision external superheat controller (E34 / E35) Always With compr operation

It can be selected when a corresponding fault is noted.

It can be selected when a fault of the soft starter shall be considered.

Always

The input is always taken into consideration.

With compr operation

The input is considered only when the compressor is in operation.

When the compressor is started, no consideration is given to the fault for the first 3 seconds.

With source operation

The input is only considered if the source pump is switched on.

According to heat source

The pressure switch E26, connected at the input, monitors pressure regardless of the heat source:

- Heat source water = For source mode
- Heat source brine = Always

Control of the process reversing valve

<i>Line no.</i>	<i>Operating line</i>
ACS	Pressure diff min process reversal
ACS	Min compr run time prior to process reversal
ACS	Delay pressure diff error process reversal
ACS	Basic position process reversing valve Last request Heating Cooling None

To change its position, a pilot-controlled 4-port valve requires a minimum differential between evaporation and condensation pressure.

If the pressure differential is too small and an attempt is made to move the valve, it might get stuck in an intermediate position. In that case, a "hydraulic short-circuit" might occur between high- and low-pressure. In the worst case, the valve will have to be removed and manually repositioned.

Pressure diff min process reversal ACS*

The process reversing valve may be moved only when the condensation pressure exceeds the evaporation pressure by the set pressure differential.

The function is active only when both evaporation pressure (H82) and condensation pressure are known.

Delay pressure diff error process reversal ACS*

If the minimum pressure differential is not reached within "Delay pressure diff error process reversal", the compressor is shut down and an error message ("504:Pres diff proc reversal") is displayed.

Min compr run time prior to process reversal ACS*

The process reversing valve may be moved only when the compressor has been in operation for the "Min compr run time prior to process reversal".

If both a minimum pressure differential and a minimum compressor running time are parameterized, both conditions must be satisfied for the process reversing valve to be allowed to change over.

Basic position process reversing valve

When the compressor shuts down, the process reversing valve is driven to the set basic position. The valve maintains this position until the compressor is switched on the next time. This also prevents the valve from seizing should a power failure occur.

Last request

When the compressor is shut down, the valve maintains its current position. It stays there until the compressor is started the next time.

Heating

When the compressor is shut down, the valve is driven to its basic "heating" position.



When defrosting, the valve is also reset to its "heating" position during dripping.

Cooling

When the compressor is shut down, the valve is driven to its basic "cooling" position.

None

The valve may also change its position when the compressor is off.



When the compressor is off, the valve changes over only if permitted by "Pressure diff min process reversal" (ACS) and "Min compr run time prior to process reversal" (ACS).

Compressor modulation on process reversal

<i>Line no.</i>	<i>Operating line</i>
ACS	Compressor modulation on process reversal

When the compressor is in operation, the process reversing valve is allowed to change over only when the compressor's output has dropped to a certain level. This is ensured by function "Compressor modulation on process reversal", which reduces the compressor's output to the set level before the process is reversed. The function reduces wear and tear, e.g. when defrosting with process reversal, that is, when changing from heating to defrost mode. In the case of modulating, a fixed time of 25 seconds need to elapse after output reduction until the process reversing valve is allowed to change over.

Setting "Compressor modulation on process reversal" for different types of compressors:

<i>Type of compressor</i>	<i>Selection</i>	<i>Process reversing valve changes over when ...</i>
Modulating	0%	compressor off
	1...100%	compressor output <= value and waiting time has elapsed
2-stage	0%	compressor off
	1...50%	compressor 2 off and waiting time has elapsed
	51...100%	setting without impact
1-stage	0%	compressor off (no waiting time)
	1...100%	setting without impact

Compressor 2

Line no.	Operating line
2860	Lock stage 2 with DHW Off On
2861	Release stage 2 below OT
2865	Compr sequence changeover

Lock stage 2 with DHW

It can be selected whether the second compressor stage shall be locked during DHW charging.

Off

Compressor stage 2 is released during the time the DHW storage tank is charged.

On

Compressor stage 2 is locked during the time the DHW storage tank is charged.

Release stage 2 below OT

If the attenuated outside temperature lies below the set release temperature, the second compressor stage is released.

Compr sequence changeover

Automatic changeover of the compressors ensures that both compressors operate pretty much the same number of hours.

If the difference of operating hours between the first and the second compressor exceeds the limit (in hours) set here, the startup order changes as soon as both compressors are switched off. This means that compressor 1 becomes compressor 2, and vice versa.

To view the current "Compressor sequence", go to operating line 8446.

Releasing and locking modulation (stage 2)

Line no.	Operating line
2862	Locking time stage2/mod
2863	Release integral stage2/mod
2864	Reset integral stage2/mod

Locking time stage2/mod

After switching the compressor on, modulation/stage 2 remains locked during "Locking time stage2/mod" (line 2862).

The locking time prevents additional output from being released before the heat pump reaches a stable operating state.

During the time modulation is locked, the output setpoint is maintained at the output defined under "Compressor modulation min" (line 2871).

Release integral stage2/mod

If the required flow temperature setpoint cannot be attained with the minimum compressor output/stage 2, modulation/stage 2 is released when the release integral is fulfilled (line 2863, "Release integral stage2/mod").



If the release integral is filled, the anticipated actual value is calculated on completion of a further locking time, based on the current temperature gradient. Modulation/stage 2 is released only if, on completion of the second locking time, the actual value to be anticipated lies below the required setpoint.

Release of stage 2

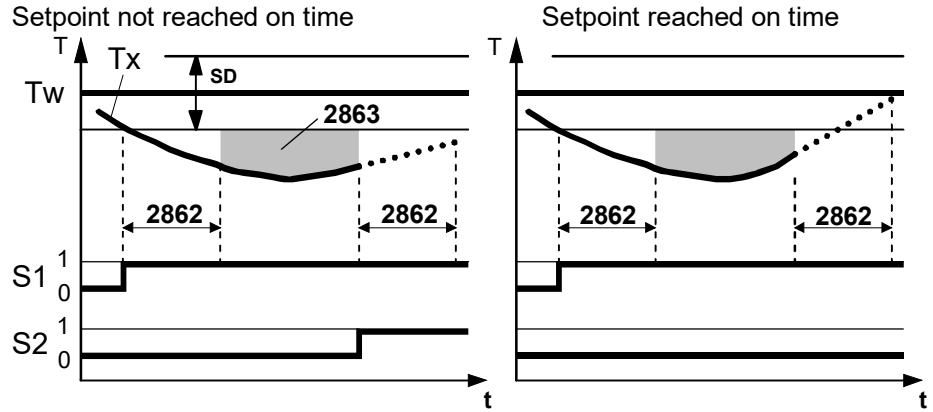

- T_w Flow or return temperature setpoint
- T_x Actual value of flow or return temperature
- SD Switching differential
- S1 Compressor stage 1
- S2 Compressor stage 2
- 2862 Locking time stage2/mod
- 2863 Release integral stage2/mod
- T Temperature
- t Time

Reset integral stage2/mod

The compressor can only be switched off again when modulation/stage 2 is locked and the reset integral has been fulfilled (line 2864, "Reset integral stage2/mod").

Stage 2

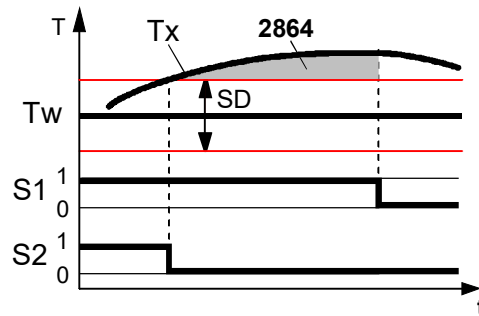

- T_w Flow or return temperature setpoint
- T_x Actual value of flow or return temperature
- SD Switching differential
- S1 Heat pump stage 1
- S2 Heat pump stage 2
- 2864 Reset integral stage 2
- T Temperature
- t Time

Output data

Line no.	Operating line
2867	Output optimum
2868	Output nominal
2869	Output basic stage
ACS	Source temp 1 for COP
ACS	Source temp 2 for COP
ACS	Flow temp 1 for COP
ACS	Flow temp 2 for COP
ACS	COP at source temp 1 and flow temp 1
ACS	COP at source temp 1 and flow temp 2
ACS	COP at source temp 2 and flow temp 1
ACS	COP at source temp 2 and flow temp 2
ACS	El compr. power at source temp 1 and flow temp 1
ACS	El compr. power at source temp 1 and flow temp 2
ACS	El compr. power at source temp 2 and flow temp 1
ACS	El compr. power at source temp 2 and flow temp 2
ACS	OT limit compressor power
ACS	Minimum compressor power below OT limit
ACS	Minimum compressor power over OT limit

Compressor operation with optimum efficiency

If use shall be made of "Compressor operation with optimum efficiency", the compressor's optimum degree of modulation (as specified by the supplier, representing optimum efficiency) needs to be entered via parameter 2867, "Output optimum".

In addition to normal requirements, "energy-optimized" requirements can be parameterized.

If, during operation, a "consumer" places an "energy-optimized" requirement and there is no normal requirement, the compressor is operated with optimum efficiency.

The different types of heat pumps are distinguished as follows:

- With 1-stage heat pumps, the set value is of no importance.
- With 2-stage heat pumps, operation with stage 1 can be defined as "optimum efficiency".
→ "Output optimum" must then be set to ≤ 50%.
- With modulating heat pumps, the set degree of modulation applies.



- The parameterized limits (Compressor modulation max/min) are given priority.
- If "Output optimum" is not selected, the heat pump is not switched on when there is a request for "energy-optimized" operation.
- Electric immersion heaters are locked when there is a request for "energy-optimized" operation.
- If parameter 2867 is activated (value between 1 and 100%) and cascades are used, there is an impact on the cascade's sequence and strategy.

Output nominal

Setting the heat pump's nominal output (heat output) in kW.

This setting may be required in the case of cascades with different types of generators.

Output basic level

Setting for output of the basic level (heating output) for the heat pump in kilowatt. The setting may be needed for cascades with different producers.

COP depending on the source and the flow temperature

The coefficient of performance (COP) is dependent on the heat pump's design, but primarily on the source and the flow temperature. If the COP at 4 operating points is known, it can be roughly calculated for any other operating point. This is also possible when the compressor is off.



The 2 source and the 2 flow temperatures of the operating points can be freely selected. This means that the data usually produced by test rig measurements can be used.

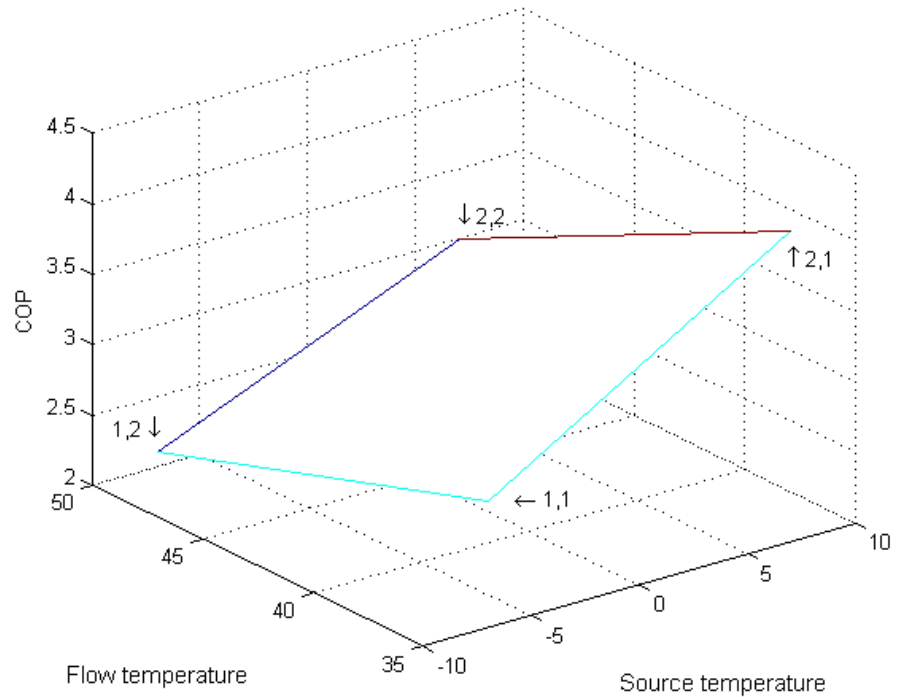

Point coordinates:

- 1,1: COP at source temp 1 and flow temp 1
- 1,2: COP at source temp 1 and flow temp 2
- 2,1: COP at source temp 2 and flow temp 1
- 2,2: COP at source temp 2 and flow temp 2

Compressor power based on source and flow temperature	<p>The controller can calculate electrical compressor power at the present operating point.</p> <p>The function is enabled via operating line 3197 by setting a value for parameter "Electric power compressor" and not configuring an Hx input for electric power consumption.</p> <p>To calculate the resulting compressor power based on source and flow temperature, the electric power consumption of the compressor must be known to the four point coordinates (see graphic for COP). The same point coordinates as for COP are used.</p>
El compr. power at source temp 1 and flow temp 1 / source 1, flow 2 (ACS)	<p>Electric power consumption at the operating point:</p> <ul style="list-style-type: none"> • Source temp 1 for COP / Flow temp 1 for COP • Or Source temp 1 for COP / Flow temp 2 for COP
El compr. power at source temp 2 and flow temp 1 / source 2, flow 2 (ACS)	<p>Electrical power consumption at the operating point:</p> <ul style="list-style-type: none"> • Source temp 2 for COP / Flow temp 1 for COP • Or Source temp 2 for COP / Flow temp 2 for COP
OT limit compressor power (ACS)	Outside temperature limit value for minimum compressor power.
Minimum compressor power below OT limit (ACS)	Minimum compressor power for $TA < \text{Limit value}$.
Minimum compressor power over OT limit (ACS)	Minimum compressor power for $TA > \text{Limit value}$.

Modulating compressors

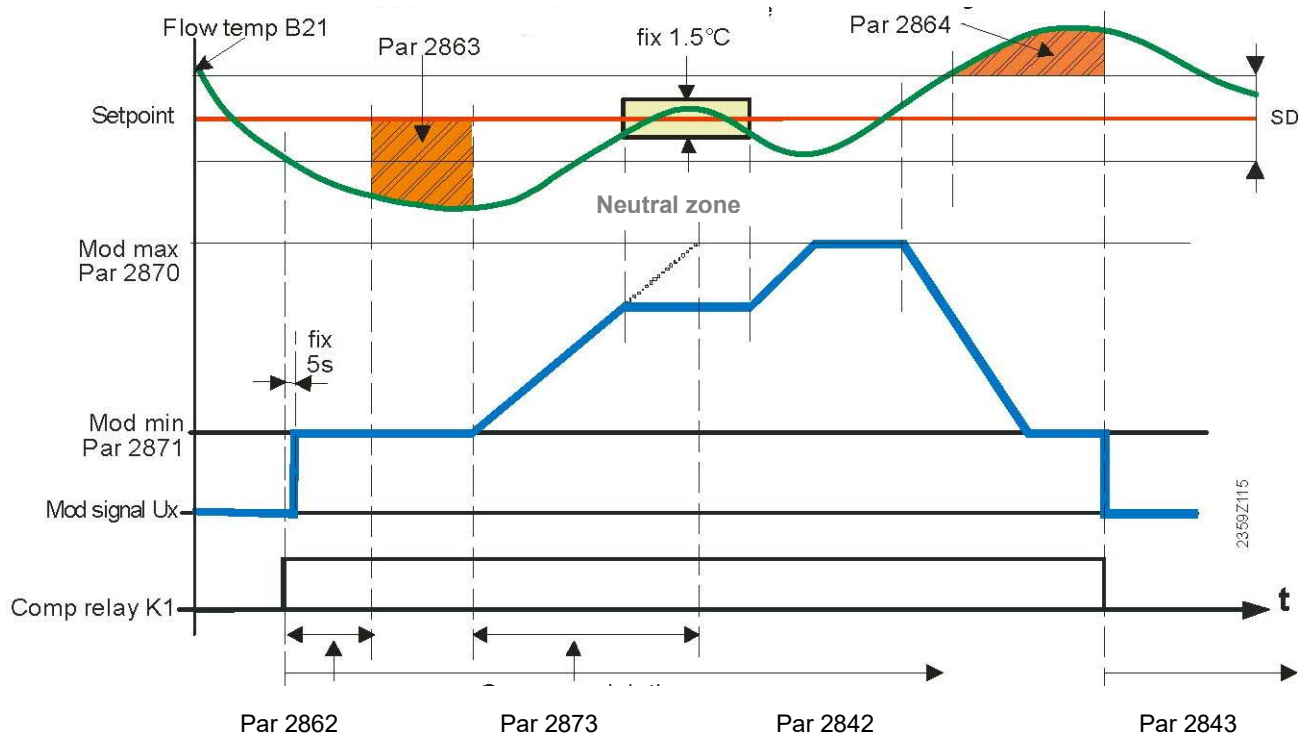

- BZ 2842: Compressor run time min
- BZ 2843: Compressor off time min
- BZ 2862: Locking time stage2/mod
- BZ 2863: Release integral stage2/mod
- BZ 2864: Reset integral stage2/mod
- BZ 2873: Compressor mod run time
- SD: BZ 2840: Switching diff return temp

Control of compressor:
On/Off

Control is ensured by a 2-position controller with an adjustable switching differential (line 2840, "Switching diff return temp").

If the flow temperature drops by more than half the switching differential below the heat pump's setpoint, the compressor is released via relay K1.

If the flow temperature exceeds the heat pump's setpoint by more than half the switching differential, the compressor is locked, provided the reset integral is zero or fulfilled.

To prevent short on/off cycles, minimum compressor on and off times should be parameterized. The compressor is switched only when the respective time has elapsed.

Switch-off temperature max heat pump heating circuit

<i>Line no.</i>	<i>Operating line</i>
2855	Switch-off temp max HC

Similar to Switch-off temp max (OL 2844) for DHW charging, a maximum switch-off temperature for heating can be defined on this operating line.
 During DHW charging and the follow-on stabilization time, the limit value for OL 2844 applies. During heating, OL 2855 applies.
 The value for OL 2844 applies for switched-off function OL 2855.

The higher set value at OL 2844 protects the heat pump.
 The lower set value at OL 2855 protects the heating circuit, so that, for example, it does not generate temperatures that are too high for floor heating.

The stabilization time (OL 2839) must be switched off if the limit value for heating must also be strictly maintained immediately after changing over from DHW charging.

In this event, the setpoint drop off delay (OL 6118) prevents the compressor from switching off in the event the setpoint jumps below the limit value.

 The settings are especially needed for plants without a buffer storage tank.

Releasing and locking modulation (modulating compressor)

<i>Line no.</i>	<i>Operating line</i>
2862	Locking time stage2/mod
2863	Release integral stage2/mod
2864	Reset integral stage2/mod

Locking time stage2/mod After switching the compressor on, modulation remains locked during "Locking time stage2/mod" (line 2862).

The locking time prevents additional output from being released before the heat pump reaches a stable operating state.

During the time modulation is locked, the output setpoint is maintained at the output defined under "Compressor modulation min" (line 2871).

Release integral stage2/mod If the required flow temperature setpoint cannot be attained with the minimum compressor output, modulation is released when the release integral is fulfilled (line 2863, "Release integral stage2/mod").

When modulation is released, the compressor is kept in operation and control to the setpoint is ensured by modulation.

 If the release integral is filled, the anticipated actual value is calculated on completion of a further locking time, based on the current temperature gradient. Modulation is released only if, on completion of the second locking time, the anticipated actual value lies below the required setpoint.

Reset integral stage2/mod The compressor can only be switched off again when modulation is locked and the reset integral has been fulfilled (line 2864, "Reset integral stage2/mod").

Output data

<i>Line no.</i>	<i>Operating line</i>
2867	Output optimum
2868	Output nominal
2869	Output basic stage
ACS	Source temp 1 for COP
ACS	Source temp 2 for COP
ACS	Flow temp 1 for COP
ACS	Flow temp 2 for COP
ACS	COP at source temp 1 and flow temp 1
ACS	COP at source temp 1 and flow temp 2
ACS	COP at source temp 2 and flow temp 1
ACS	COP at source temp 2 and flow temp 2
ACS	El compr. power at source temp 1 and flow temp 1
ACS	El compr. power at source temp 1 and flow temp 2
ACS	El compr. power at source temp 2 and flow temp 1
ACS	El compr. power at source temp 2 and flow temp 2
ACS	OT limit compressor power
ACS	Minimum compressor power below OT limit
ACS	Minimum compressor power over OT limit



See explanation given in section "Compressor 2"

Compressor modulation

Compressor modulation

As long as the compressor is off (K1 = off) or not released (D3 = off), the output setpoint is maintained at 0%.

When the compressor is switched on (K1 = on) and "Locking time stage2/mod" (line 2862) has elapsed, the output setpoint is shifted to "Compressor modulation min" (line 2871) and maintains that level as long as modulation is locked.

As soon as modulation is released, the control generates an output setpoint between "Compressor modulation min" and "Compressor modulation max" (line 2870) based on the deviation of the current heat pump setpoint from the flow temperature (B21).



- During the defrost process (D6 at X75), the control is "frozen in", which means that the current output setpoint is maintained during defrosting.
- Parameter "Compressor modulation min" must be set such that the external controller is able to run the compressor at minimum output.
- Control is basically provided to the flow temperature setpoint, regardless of whether it is a heating circuit or storage tank request.

<i>Line no.</i>	<i>Operating line</i>
2870	Compressor modulation max
2871	Compressor modulation min
2873	Compressor mod run time
2874	Compressor mod Xp
2875	Compressor mod Tn
2878	PWM period digital scroll
2879	Compr mod run time closing

For modulating heat pumps, the control action can be preselected via the following parameters:

Compressor modulation
max/min



Compressor modulation is limited in both directions by setting these minimum and maximum limitations.

The value should be set such that the controller of other manufacture will be able to operate the external heat pump at minimum output.

Compressor mod run
time and Compr mod run
time closing

The maximum ramp up and ramp down rate of compressor modulation can be adjusted. The time for ramping down the modulation can be set separately. If "Compr mod run time closing" is set to "- - -", the ramp down time equals the ramp up time.

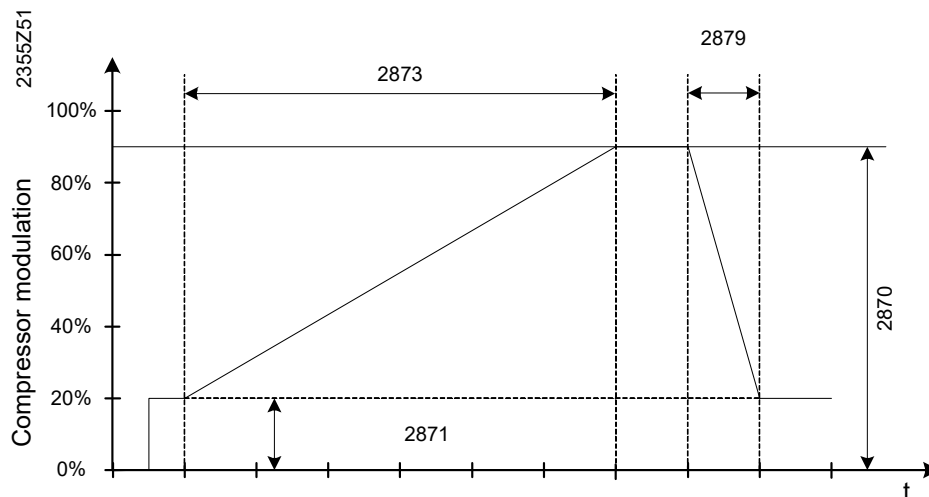

Parameters Xp and Tn

By setting the right proportional band Xp and integral action time Tn, the control action can be matched to the type of plant (controlled system).

Xp and Tn can be determined using common methods, e.g. the step response method depicted in Section "Xp, Tn, Tv – Step response method".

Brochure BT_0098_EN provides additional notes on control technology in buildings.

PWM period digital scroll With digital scroll compressors, the scroll at the top can be lifted by means of a magnetic valve. As a result, the compressor is "leaking". The refrigerant is no longer compressed. During this idling time, the compressor only uses a fraction of the electrical power.

To switch a digital scroll compressor, relay "Compressor stage 1 K1" is used. The output is controlled by means of a PWM signal delivered via the triac output.

- Triac off (0 V): Full compressor output.
- Triac on (AC 230 V): Compressor idling.

The compressor's output is modulated by the magnetic valve's periodic opening and closing actions.

As a function of the power signal

Setting "- - -"

In addition to the pulse width, the duration of the period is changed, depending on the compressor's output.

As a fixed setting

Setting within the value range (5 to 30 s)

If the setting is made within the value range, the duration of the PWM signal's period is fixed.

<i>Line no.</i>	<i>Operating line</i>
ACS	Compressor kick release
ACS	Compressor kick modulation
ACS	Compressor kick interval
ACS	Compressor kick duration

Compressor kick for lubrication (ACS)

If the compressor runs at low speed for a longer period of time, transport of the lubricant and thus lubrication itself might be inadequate. This means that the compressor might get damaged. To prevent this, a "compressor kick" can be parameterized.

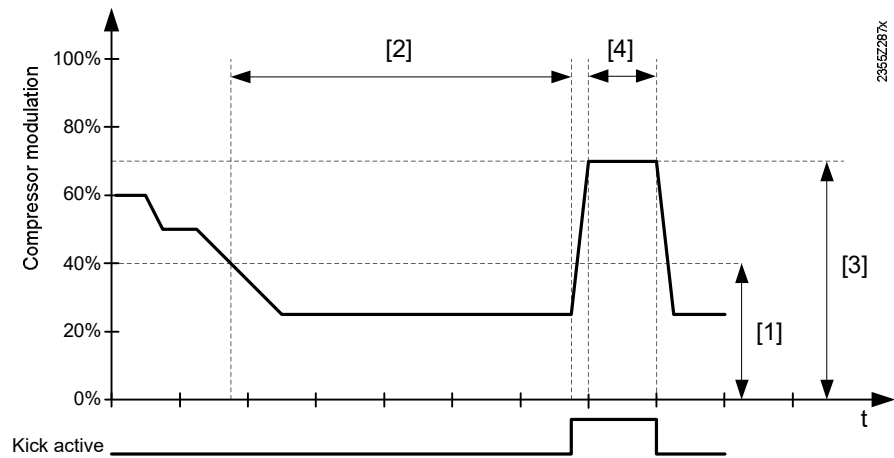

- [1] "Compressor kick release" (ACS)
- [2] "Compressor kick interval" (ACS)
- [3] "Compressor kick modulation" (ACS)
- [4] "Compressor kick duration" (ACS)

If the compressor operates below "Compressor kick release" (ACS) during the "Compressor kick interval" (ACS), the compressor kick is triggered.

With the "valve kick", the compressor operates on "Compressor kick modulation" (ACS) for the "Compressor kick duration" (ACS).

Time measurements

- When the compressor is off, the measurement of time is stopped, but the time is not reset.
- The measurement of time is stopped, but the time is not reset, even above "Compressor kick release" (ACS).
- The time is reset when, during operation or due to a compressor kick during "Compressor kick duration" (ACS), the compressor was operated on "Compressor kick modulation" (ACS).

When the speed changes, the maximum rates of change of compressor modulation are observed.

Electric immersion heater in the flow



Relays K25 and K26 are used for an electric immersion heater installed in the flow. They are controlled via 2 appropriately configured multifunctional relay outputs QX1...QX6.

If both relays are available, the electric immersion heater is controlled in 3 stages (1st stage K25, 2nd stage K26, and 3rd stage K25 and K26).

If a flow temperature sensor (B21) is connected, it is used to provide control to the flow temperature setpoint. The switching differential is 1 Kelvin.

If the flow temperature sensor is missing, but a common flow temperature sensor (B10) is available, that sensor is used for the control.

If no flow temperature sensor is available, the electric immersion heater is controlled based on the return temperature (B71) and the return temperature setpoint. The switching differential is set with parameter "Switching diff return temp" (line 2840).

-  During an electrical utility lock, the electric immersion heaters installed in the flow are locked also.
-  Placement of the electric immersion heating is defined on OL 5805, the type of the electric immersion heating on OL 5806. The output of the stage connected at relay K25 is set on OL 5811; the output of the stage connected to relay K26 on OL 5813.

Line no.	Operating line
2880	Use electric flow Substitute ; Complem operation HC ; Complem operation DHW ; Complem operation HC+DHW ; End DHW charging ; Emergency operation ; Legionella function
2881	Locking time electric flow
2882	Release integr electric flow
2883	Reset integr electric flow
2884	Release el flow below OT

 WARNING	Electric immersion heaters must be fitted with a safety limit thermostat.
--	---

Use electric flow

Use and control of the electric immersion heater can be parameterized:

Substitute

The electric immersion heater is only used for emergency operation (parameters 7141 and 7142) when the temperature drops below the minimum source temperature (parameters 2815 and 2816), or outside the operating limits of air-to-water heat pumps (parameters 2812 and 2813).

When activating emergency operation, either manually or automatically, the electric immersion heater is immediately released to ensure control to the current setpoint. No consideration is given to "Locking time electric flow" (line 2881) and "Release el flow below OT" (line 2884).

-  If there is no control sensor (B21, B10, B71), the electric immersion heater is switched on for emergency operation when there is a valid temperature request. When using a 3-stage electric immersion heater, both stages (K25 and K26) are switched on at the same time.

Control of the electric immersion heater must be provided by an external thermostat.

Complem operation HC, DHW, HC+DHW

If the electric immersion heater installed in the flow is released for support of the heat pump (complementing the compressor), the time entered via "Locking time electric flow" (parameter 2881) starts to run as soon as the compressor is switched on. When the locking time has elapsed, calculation of the release integral is started (parameter 2882). When the release integral has elapsed, the electric immersion heater is released **in addition** to the compressor, for heating only, for DHW charge only, or for both, depending on the selection made. In this case, the electric immersion heaters act like additional stages.

End DHW charging

During heating mode and DHW charging, the electric immersion heater is locked.

Exception: If, during DHW charging, the compressor must be switched off due to the maximum switch-off temperature, high-pressure or hot-gas problems, the electric immersion heater ensures DHW charging as soon as the number of charging attempts exceeds the set "Number DHW charg attempts".



- Parameters "Locking time electric flow" and "Release el flow below OT" have no impact.
- In the case of a 3-stage electric immersion heater (K25 and K26 parameterized), both relays are energized at the same time.
- If the electric immersion heater is parameterized as "End DHW charging", it is also released in the cases described under "Substitute".

Emergency operation

The electric immersion heater is only used for emergency operation. The electric immersion heater is released immediately and controls to the current setpoint.



- Parameters "Locking time electric flow" and "Release el flow below OT" have no impact.
- For activation of emergency operation, refer to parameter 7141, "Emergency operation".

Legionella function

Behavior like "End DHW charging", but only when the "Legionella" function is active.



In the following cases, setting "Use electric flow" has no impact on the use of the electric immersion heater:

- With frost protection.
- With air-to-water heat pumps during the defrost process.
- During active limitation due to too low source temperatures (see "T'limit source temp min brine", line 2822).

If the flow switch on the consumer side trips, or if the water pressure is too low, the electric immersion heater is switched off.

Locking time electric flow The electric immersion heater may be switched on only when the locking time after the compressor start set here has elapsed.



The locking time is considered only if the electric immersion heater is used for "Complementary operation" (parameter 2880). It is not taken into consideration when using the "Substitute" setting.

Release integr electric flow

When using a 2- or 3-stage electric immersion heater, the stages are released in accordance with the release and the reset integral (lines 2882 and 2883).

Release integral with setting 2880: "Substitute"

After release of the electric immersion heater's first stage (K25), the controller compares the actual temperature value with the switch-on point and generates an integral based on the heat deficit, if there is any. When the value of the integral reaches the set maximum ("Release integr electric flow", line 2882), the second stage is released (K25 off, K26 controls).

The controller continues to compare the actual value of the temperature with the switch-on point and calculates again the heat deficit in the release integral. When the release integral reaches the set value (line 2882), the third stage of the electric immersion heater is released (K25 fixed on, and K26 controls).

Release integral with setting 2880: "Complem operation HC, DHW, HC+DHW"

When "Locking time electric flow" has elapsed, the controller starts calculating the heat deficit, if there is any. The first stage of the electric immersion heater (K25) is released only when the heat deficit has reached the value set here.

For the second and third stage of the electric immersion heater, the locking time is not taken into consideration, but the release integral must again reach the set value.

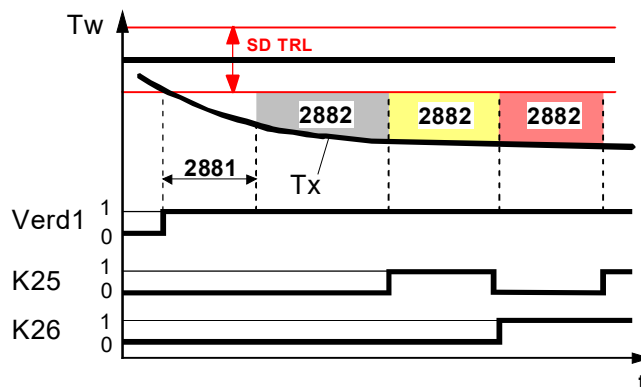

SD TRL	Switching differential return temperature
Verd1	Compressor
K25	Electric immersion heater relay K25
K26	Electric immersion heater relay K26
T_w	Temperature setpoint (switch-on point)
T_x	Actual value of temperature
2881	Locking time electric flow
2882	Release integr electric flow
t	Time

Reset integr electric flow If the actual value lies above the switch-off point, the controller switches off the (controlling) stage switched on last and – based on surplus heat, if available – starts to compute the reset integral.
 The next lower stage is switched off each time surplus heat reaches the set reset integral (line 2883).
 For a new release, the release integral must be filled again.

Release el flow below OT The electric immersion heater is released only when the attenuated outside temperature lies below the temperature set here.



This setting is considered only if the electric immersion heater is used as a "complement" to heat pump operation" (line 2880). When using the "Substitute" setting, the electric immersion heater is always released.

<i>Line no.</i>	<i>Operating line</i>
2885	Electric on below flow temp

If, with a valid heat request (from the heating circuit or DHW) or during the defrost process, the temperature at B21 or B71 drops below the set value of parameter "Electric on below flow temp", both electric immersion heaters installed in the flow are switched on.

The electric immersion heater is switched off again when ...

- the temperature at B71 exceeds "Electric on below flow temp" by 8 Kelvin, or
- the temperature at B21 exceeds "Electric on below flow temp" by 18 Kelvin.



The function can be deactivated.

General parameters

Line no.	Operating line
2886	Compensation heat deficit Off On Only with floor curing fct

Compensation heat deficit

This function compensates for excess heat and heat deficits. These can occur in the following situations:

- Minimum compressor on and off times.
- In the case of low temperature requests, the flow temperature can lie below the required setpoint, but the return temperature may not drop below the switch-on point for a longer period of time. In this situation, the heat pump must be switched on to prevent heat deficits.

The controller compares continuously the flow temperature setpoint with the actual value and integrates the surplus heat and heat deficits. Differences are compensated for by extending the compressor on and off times.

If the compressor is not switched on or off due to surplus heat/heat deficits, the controller displays an appropriate status message.



This function is not active during the time the DHW storage tank is charged. Even in plants with buffer (combi) storage tanks, the function is not active.



"Compensation heat deficit" only acts in heating mode. The parameter is inactive in cooling mode.



The maximum switch-off temperature is given priority over the "Compensation" function.

In the case of sudden setpoint changes, both integrals are cleared.

Behavior with the "Floor curing" function

When activating the "Floor curing" function, the integral is set to a level representing 1.5 times the predefined value (factory setting). If the current temperature lies at least 2 Kelvin below the required setpoint, the heat pump is immediately switched on.

If compensation of surplus heat/heat deficits shall act "Only with floor curing fct", the respective setting must be selected. This means that the parameter is deactivated in normal heating mode.

Calculation of integral

- If a flow temperature sensor (B21) is connected and the heating curve is set to the flow temperature setpoint, the controller uses the flow temperature and the flow temperature setpoint for computing the integrals.
- If sensor B21 is not installed and the compressor does not operate, the temperature at the return sensor (B71) is used and, when the compressor runs, the temperature at B71 plus parameter "Req temp diff condenser" (line 2805).
- If the heating curves are set to the return (line 5810), the return temperature sensor (B71) and the return temperature setpoint are used for computing the integral.
- If that is not the case, the return sensor (B71) and the return temperature setpoint are used.

In the following situations, the integral is set to "0":

- No valid temperature request delivered
- Setpoint change >2 Kelvin.
- Frost protection for the heat pump is active.
- The heat pump has gone to lockout or cannot deliver any heat for a longer period of time
- The heat pump is in active cooling mode
- A buffer storage tank is being charged.
- The function is deactivated.

With active DHW charging, the integral value is frozen.

In the following example of compensation, surplus heat occurs during the minimum compressor on time. This surplus heat is reduced again on completion of the set minimum compressor off time in that the compressor will not yet be released.

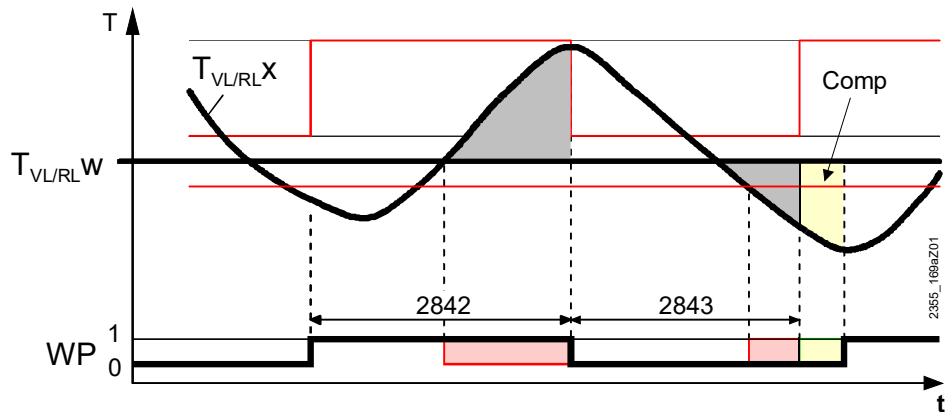

- $T_{VL/RLX}$ Actual value of flow or return temperature
- $T_{VL/RLW}$ Flow or return temperature setpoint
- 2842 Compressor run time min
- 2843 Compressor off time min
- WP Heat pump switching state: 0 = off, 1 = on
- Comp Compensation of surplus heat resulting from running time

Line no.	Operating line
2889	Duration error repetition

Duration error repetition

If, within this period of time, the same fault occurs more often than set under "Number of error repetitions", lockout is triggered.



For "Number of error repetitions", refer to chapter 6.24.

<i>Line no.</i>	<i>Operating line</i>
2893	Number DHW charg attempts

Number DHW charg attempts

This number determines how many times DHW charging or forced buffer storage tank charging may be aborted until either the electric immersion heater installed in the flow or that in the DHW storage tank completes the charging process.

Heat pump protection during DHW charging

The heat pump is switched off, when high-pressure switch E10 (HD pressostat) trips during DHW charging or because the hot-gas or flow temperature approaches its maximum.

"Number DHW charg attempts" (parameter 2893) is used to select whether charging is aborted immediately or whether the heat pump shall make a certain number of charging attempts. In the case of several attempts, the heat pump starts the next charging attempt each time the minimum off time ("Compressor off time min", Parameter 2843) has elapsed.

If the heat pump shall make only one charging attempt or if, after the selected number of attempts, the DHW has still not reached the required temperature, DHW charging is aborted, the controller stores the current DHW temperature and readjusts the switch-on point to the DHW temperature minus the DHW switching differential. With diagnostics, the stored temperature appears on the display as "Curr DHW charg temp HP" (parameter 7093). The value is maintained until – due to a limitation – the heat pump is again forced to abort DHW charging.

If "Curr DHW charg temp HP" lies below the adjustable value "DHW charg temp HP min" (parameter 7092), a maintenance message appears.

If the Reduced setpoint lies below "DHW charg temp HP min" and the heat pump can end DHW charging, the controller will not deliver a maintenance message.

<i>Line no.</i>	<i>Operating line</i>
2894	Delay mains fault

Delay mains fault

The compressor is switched off if the mains fault is constantly present for the period of time set here. When "Min off time" has elapsed, the heat pump is switched on again. If, within "Duration error repetition", the 3-phase current error occurs again for at least the delay time, the heat pump initiates lockout, provided the permitted preset number of faults has been exceeded.

<i>Line no.</i>	<i>Operating line</i>
2895	Delay flow switch
2896	Flow switch source active

Delay flow switch
Source/consumers

The compressor is switched off if the flow switch signal is constantly present during the period of time set here. When "Min off time" has elapsed, the heat pump is switched on again. If, within "Duration error repetition", the flow switch trips again, the heat pump initiates lockout, if the permitted preset number of faults is exceeded.

Flow switch source active

A flow switch connected to one of the Ex inputs is monitored. The incoming signal is only active when the source pump runs, the prerun time has elapsed, and the switch shall be monitored as defined below:

Always

The flow switch is monitored in heating and cooling mode.

Heating mode only

The flow switch is monitored in heating mode only.

<i>Line no.</i>	<i>Operating line</i>
2898	Min flow switch source
2899	Min flow switch consumers

If flow measurement is installed on the source or consumer side, it can also assume the flow switch function (E15, E24). In that case, flow measurement source/consumers must be configured and the required minimum flow must be stated.



The "flow measurement heating" takes place at OL 3095; consideration of "Flow measurement source " on OL 3255.

Line no.	Operating line
2900	Refrigerant None R134A R236FA R290 R404A R407A R407B R407C R410A R410B R413A R417A R422A R422D R427A R507A R600 R600A R744 R1270 R32 R448A R449A R450A R1234yf R12354ze R452B R454B R454C R455A R513A

Selection of refrigerant For overheating control the parameter "Refrigerant" must be set as per the physically used refrigerant.

CAUTION	If a refrigerant other than the type of refrigerant used by the plant is parameterized, the plant might get damaged.
----------------	--

New refrigerant Controller software version V8.8 supports the following, new refrigerants: R32, R448A, R449A, R450A, R1234yf, R12354ze, R452B, R454B, R454C, R455A, and R513A.

Required software versions Note the following regarding the required software states depending on whether "Press acquisition evap H82", the "Press acquisition cond H83" or " Press acquisition EVI H86" is configured on the control or an extension module:

- For controllers with a software version (OL6220) \geq **V8.8** the selection of new refrigerant is available and is supported by the control application.
- For controllers with a software version (OL6220) $<$ **V8.8** the selection of new refrigerant is **not** available and cannot be selected.
- For a combination of controller with a software version (OL6220) \geq **V8.8** and configuring EEV V81 and/or EEV V82 (EVI) on an extension modules version \geq **V1.6** the new refrigerant is selectable and can be supported by the control application.
- For a combination of controllers with a software version (OL6220) \geq **V8.8** and to configure EEV V81 and/or EEV V82 (EVI) on an extension module with version $<$ **V1.6**, the new refrigerant can be selected but not supported by the control application. The error "479:No refrigerant selected" is issued and the heat pump goes to faul.



You can view the version of the extension modules in ACS. Current extension modules for ordering meet these requirements.

Ensuring the correct refrigerant setting

- To make certain the plant is not put into operation with an incorrectly selected type of refrigerant, the controller is supplied with the refrigerant selection preset to "None".
- Until a refrigerant is selected, the expansion valve and the magnetic valve are shut, the compressor is locked and error "479:No refrigerant selected" (common error: "Configuration error") is delivered.
- To ensure the superheat controller can be preconfigured, selection of the type of refrigerant is demanded only when one of the pressure sensors (H82, H83 or H86) is connected.

Generator release management

If several generators are installed, their release can be managed according to ecological or economical criteria. For that purpose, various release functions are available.



If several release functions are parameterized, the heat pump is put into operation as soon as one of the functions demands a release.

Basic rules

- A second generator must be available which, in case the heat pump is locked, can ensure the production of heat.
- If a second generator is used which, however, cannot deliver any heat due to a fault, the heat pump is put into operation even if it would be locked by release criteria.

The following table contains parameters and extra settings of the release functions. The parameters and extra settings are described after the table.

#	Release strategy <i>Line 2903</i>	Release of CPO, <i>line 2904</i>	COP characteristic (ACS)	Energy prices*, <i>lines 3264...3267</i>
1	According to COP	Yes	Yes	Not relevant
2a	According to "Energy price", AT	Not relevant	Yes	HT, AT
2b	According to "Energy price", LT	Yes	Yes	HT, LT
3	According to COP and energy price	Yes	Yes	HT, AT
4	According to COP or energy price	Yes	Yes	HT, AT

* Stated tariffs are required

Abbreviations: AT: Alternative tariff HT: High-tariff LT: Low-tariff



Another release function is "Release according to the outside temperature" (lines 2908...2910).

Release strategy

Line no.	Operating line
2903	Release strategy COP Energy price COP and energy price COP or energy price

"Release strategy" selects the criteria according to which the heat pump is released.

COP

The heat pump is released via "Release of COP".

In plants operating with a second generator, this strategy is used to switch off the heat pump outside optimum operation, and the second generator alone satisfies the demand.

Required inputs

- "Release of COP" (line 2904)
- "COP characteristic" (chapter 6.9, section "Output data")

Energy price

The heat pump is released based on the energy prices entered.

Variant with alternative tariff

When the COP characteristic is defined, the controller can calculate the current coefficient. Based on the energy price(s) for electricity, the current costs per kWh heating energy can be calculated.

In plants operating with a second generator whose energy price per kWh heating energy (alternative tariff) was entered, the heat pump is switched off when its operation is more expensive than that of the alternative generator.

Required inputs

- "COP characteristic" (chapter 6.9, section "Output data")
- Energy prices: At least heat pump's own electricity high-tariff and tariff of alternative generator.

**Variante ohne
alternative Tarife**

Berücksichtigt die Tarife (Hoch- und Niedertarife), kann die Wärmepumpe mit einem weniger günstigen COP während Niedertarifzeiten betrieben werden, was durch die COP-Strategie nicht zulässig wäre.

Die Reduzierung des COP-Kriteriums ist proportional zum Preisverhältnis von Niedertarif- und Hochtarif. Aus diesem Grund ist dies primär ein ökonomisches Kriterium.

Benötigte Eingangsdaten

- "Release of COP" (Zeile 2904)
- "COP charakteristisch" (Kapitel 6.9, Abschnitt "Ausgabedaten")
- Energiepreise: Mindestens eigene Elektrizität Hoch- und Niedertarif.

COP und Energiepreis

Die Wärmepumpe bleibt in Betrieb, solange der COP **und** der Energiepreis günstiger sind als die des alternativen Generators. Wenn eines der beiden Kriterien nicht erfüllt ist, wird die Wärmepumpe gesperrt.

Wenn eines der beiden Kriterien nicht berechnet werden kann, weil Informationen fehlen (z. B. keine Informationen über Energiepreise), wird nur das andere Kriterium berücksichtigt.

Benötigte Eingangsdaten

- "Release of COP" (Zeile 2904)
- "COP charakteristisch" (Kapitel 6.9, Abschnitt "Ausgabedaten")
- Energiepreise: Mindestens eigene Elektrizität Hochtarif; alternative Tarife praktikabel..

COP oder Energiepreis

Die Wärmepumpe bleibt in Betrieb, solange der COP **oder** der Energiepreis günstiger ist als die des alternativen Generators. Die Wärmepumpe wird gesperrt, wenn beide Kriterien nicht erfüllt sind.

Wenn eines der beiden Kriterien nicht berechnet werden kann, weil Informationen fehlen (z. B. keine Informationen über Energiepreise), wird nur das andere Kriterium berücksichtigt.

Benötigte Eingangsdaten

- "Release of COP" (Zeile 2904)
- "COP charakteristisch" (Kapitel 6.9, Abschnitt "Ausgabedaten")
- Energiepreise: Mindestens eigene Elektrizität Hochtarif; alternative Tarife praktikabel..

Anmerkung zu Energiepreisen

Energiepreise sind ohne Einheiten einzugeben. Um Vergleiche durchführen zu können, muss eine einheitliche Währungseinheit (z. B. Cent/kWh) verwendet werden.

Die Energiepreise sind auf den Zeilen 3264 bis 3267 einzugeben.

Release of COP

Line no.	Operating line
2904	Release of COP

Die Einstellung, die gemacht werden muss, ist der COP ("Release of COP") bis zu dem die Wärmepumpe betrieben werden soll. Wenn der COP unter den festgelegten Grenzwert sinkt, wird die Wärmepumpe gesperrt.

COP charakteristisch

Der COP der Wärmepumpe hängt von der aktuellen Quelltemperatur und der aktuellen Strömungstemperatur ab. Das Ergebnis ist eine wärmepumpenspezifische COP charakteristisch, die im Voraus definiert werden muss.



Für die Beschreibung der ACS-Parameter, die mit dem COP charakteristisch zusammenhängen, siehe Kapitel 6.9, Abschnitt "Ausgabedaten".

Release according to the outside temperature

Line no.	Operating line
2909	Release below outside temp
2910	Release above outside temp
2908	OT limit with DHW charging Ignore Note

Release below outside temp/above outside temperature

When the composite outside temperature lies below or above the set temperature, the heat pump is put into operation.
The release also applies to active cooling mode.

OT limit with DHW charging

In the case of DHW charging, the effect of releasing/locking (lines 2909 and 2910) can be negated.

Line no.	Operating line
2911	For forced buffer charging Locked Released
2912	Full charging buffer Off On

For forced buffer charging

Using function "For forced buffer charging", forced charging of the storage tank can be demanded, independent of the request (e.g. during low-tariff periods).

If the heat pump is released via parameter "For forced buffer charging", it is switched on while forced storage tank charging is pending. In that case, the minimum off time ("Compressor off time min", line 2843) and any active "Minimum running time" of the heat pump are adhered to.

Locked

The heat pump is not put into operation for forced buffer storage tank charging.

Released

The heat pump may be put into operation for forced buffer storage tank charging.

Full charging buffer

"Full charging buffer" only applies to heating mode. It takes effect when, due to the "Automatic generation lock", the resulting request from the storage tank is dropped. Full charging can extend the heat pump's running time.

The heat pump contributes to full charging only if it is in operation and the function is activated via parameter "Full charging buffer". In that case, the heat pump's "Minimum running time" is adhered to.

Off

The heat pump remains locked until the buffer storage tank is fully charged by some other generator. It is released only when the current demand for heat cannot be satisfied ("Auto generation lock", line 4720).

On

The heat pump is released when the buffer storage tank is fully charged.

**Condenser
overtemperature
protection**

<i>Line no.</i>	<i>Operating line</i>
2922	Condenser overtemp prot Off Cooling down Switch-on lock + cool down
2923	Condens prot buffer sensor None With B4 With B41 With B42

Condenser overtemp prot

Off

Overtemperature protection of the condenser is deactivated.

Cooling down

If the heat pump had to be shut down because "Switch-off temp max" (line 2844) was reached, it can be switched on again only when the temperatures at B21 and B71 drop by the set switching differential (line 2840, "Switching diff return temp").

Due to good insulation in the vicinity of the sensors, this might take quite some time and the buffer storage tank could have been discharged in that time.

To update the sensor temperatures, the condenser pump is put into operation as soon as the following criteria are met:

- There is a heat request from the buffer or combi storage tank.
- The buffer storage tank temperature is lower than the compressor's maximum permissible switch-on temperature.
- The compressor's minimum off time has elapsed.
- No fault pending.

Switch-on lock + cool down

Switch-on lock

If the heat pump is connected to a buffer storage tank that is charged by other generators as well (solar, oil, gas, etc.), activation of condenser pump Q9 alone can cause the heat pump to go to high-pressure. The switch-on lock prevents the condenser pump from switching on when the buffer storage tank temperature is already too high to ensure practical operation of the heat pump.

Cooling down

See above under "Cooling down".

Condens prot buffer
sensor

Defines which of the buffer storage tank sensor values is considered for use as a comparison temperature for function "Condenser overtemp prot".

When selecting "None", the switch-on lock is no longer possible.

External process reversal

Line no.	Operating line
2941	Use of diverting valve Y28 Passive cooling Active and passive cooling

Process reversal through external hydraulic changeover

Heat pumps without built-in process reversing valve in the refrigeration circuit can also be used for heating and cooling by implementing hydraulic changeover outside the heat pump unit.

Heating, passive cooling and active cooling are accomplished by the following control logic:

Operation	Y22	Y28
Heating	0	0
Passive cooling	0	1
Active cooling	1	1

Use of diverting valve Y28

To be able to switch Y22 and Y28 concurrently, parameter 2941, "Use of diverting valve Y28", needs to be set to "Active and passive cooling".



The parameter's default setting is "Passive cooling" for conventional heat pumps with built-in process reversing valve Y22.

The following diagram shows a heat pump with external hydraulic changeover in heating mode.

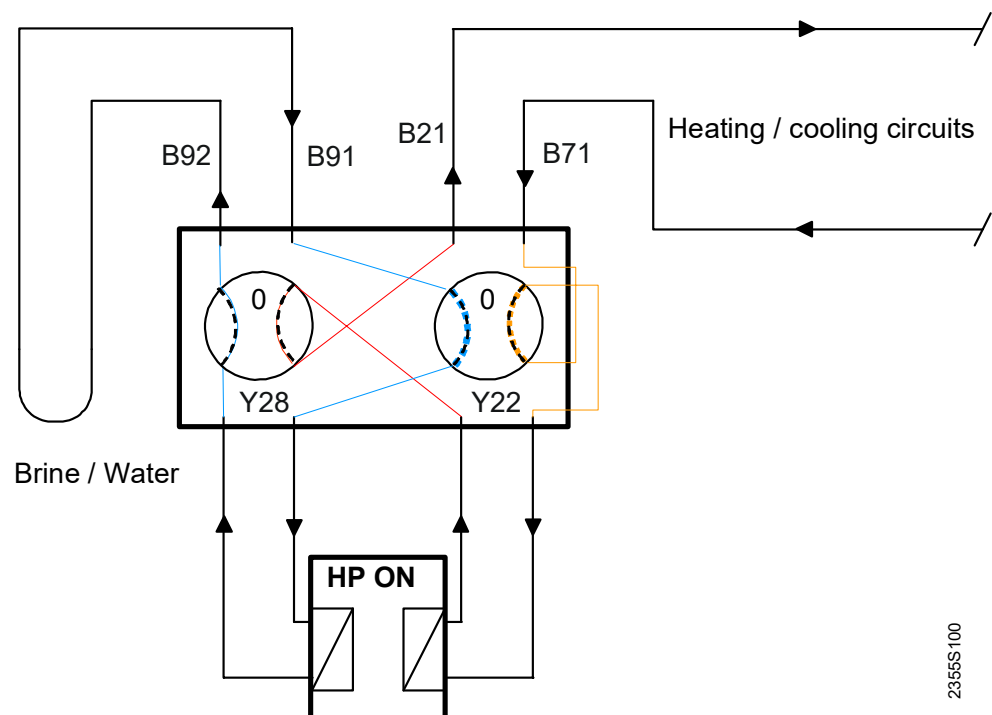

The 2 diagrams below show heat pumps with external hydraulic changeover in passive and active cooling mode.

Passive cooling

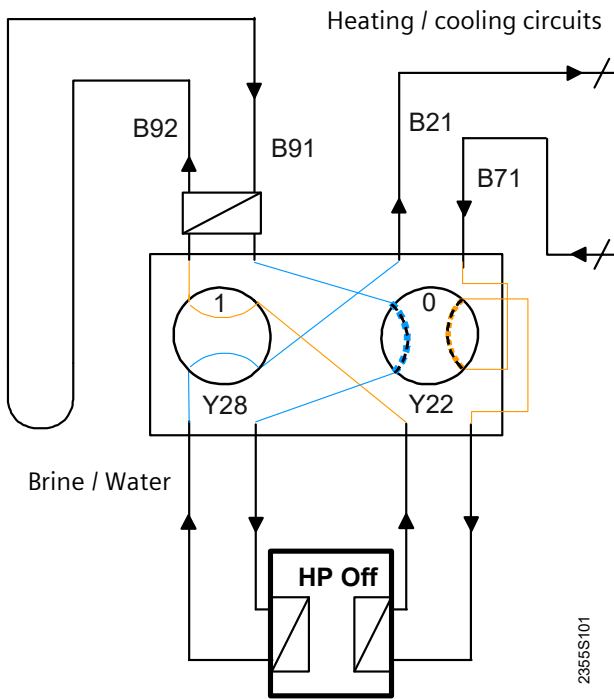

Active cooling

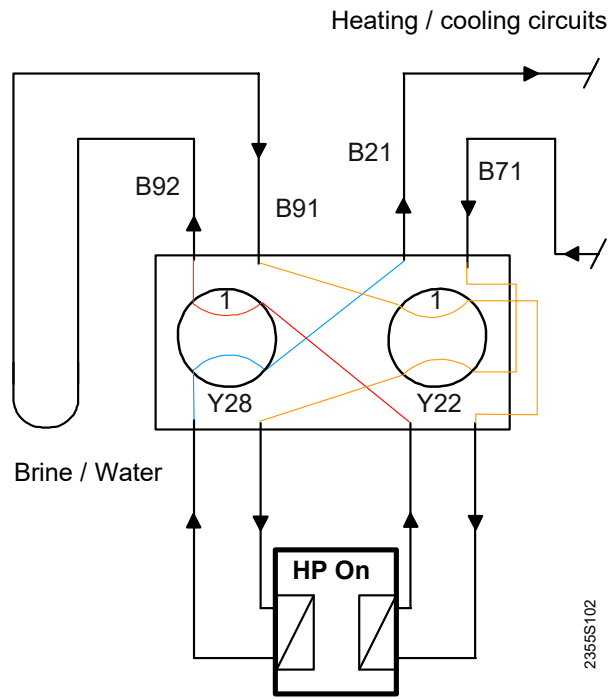

Defrosting of air-to-water heat pumps

Defrosting with fan or process reversal

Defrosting of an iced up evaporator is effected either with the fan or the compressor through process reversal (depending on the source inlet temperature):

- Above the set source inlet temperature (line 2971) with the **fan (passive defrosting)**.
- Below the set source inlet temperature (line 2971) through **process reversal (active defrosting)**.

Explanation

Up to the set source inlet temperature (B91), "Defrost fan above" (line 2971), defrosting takes place with the fan.

If the source inlet temperature falls below this level, defrosting is effected by reversing the process with the compressor.

If both parameters 2971, "Defrost fan above", and 2951, "Defrost release below OT", are set to the same level, defrosting is started directly with active defrosting, "Defrost with process revers".

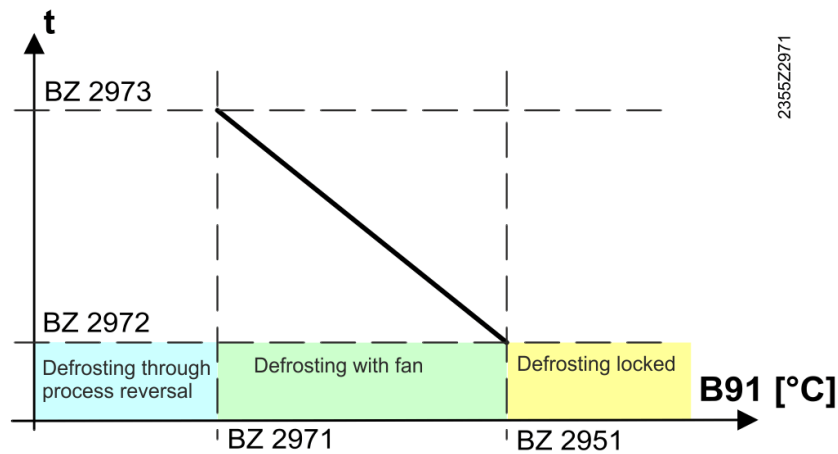

- 2951: Defrost release below OT
- 2971: Defrost fan above
- 2972: Defrost time fan min
- 2973: Defrost time fan max

The example below shows a heat pump in heating and defrost mode with process reversal.

Plant in heating mode

In normal heating mode of an air-to-water heat pump, condensation can occur at low temperatures, causing the evaporator to ice up. This reduces the heat pump’s output and can lead to malfunction on the low-pressure side or even damage to the evaporator.

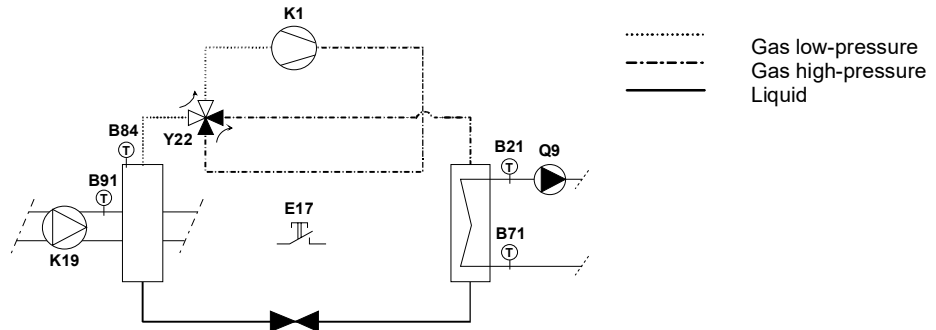

Plant in defrost mode (process reversal)

The iced up evaporator is defrosted either with the fan or – as shown in the example below – with process reversing valve Y22. For process reversal, a HP partial diagram with process reversing valve (Y22) must be used.

Demand-dependent defrost control ensures that the defrost energy drawn from the heating circuit in the case of process reversal is kept at a minimum. During the defrost process with process reversal, the fan remains deactivated.

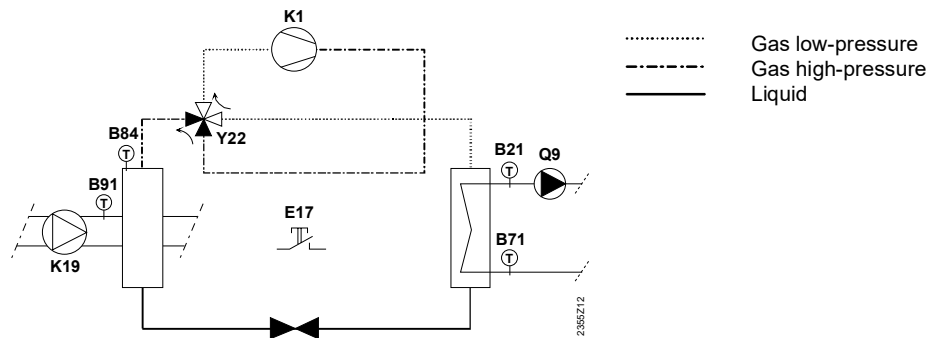

Progression of defrosting

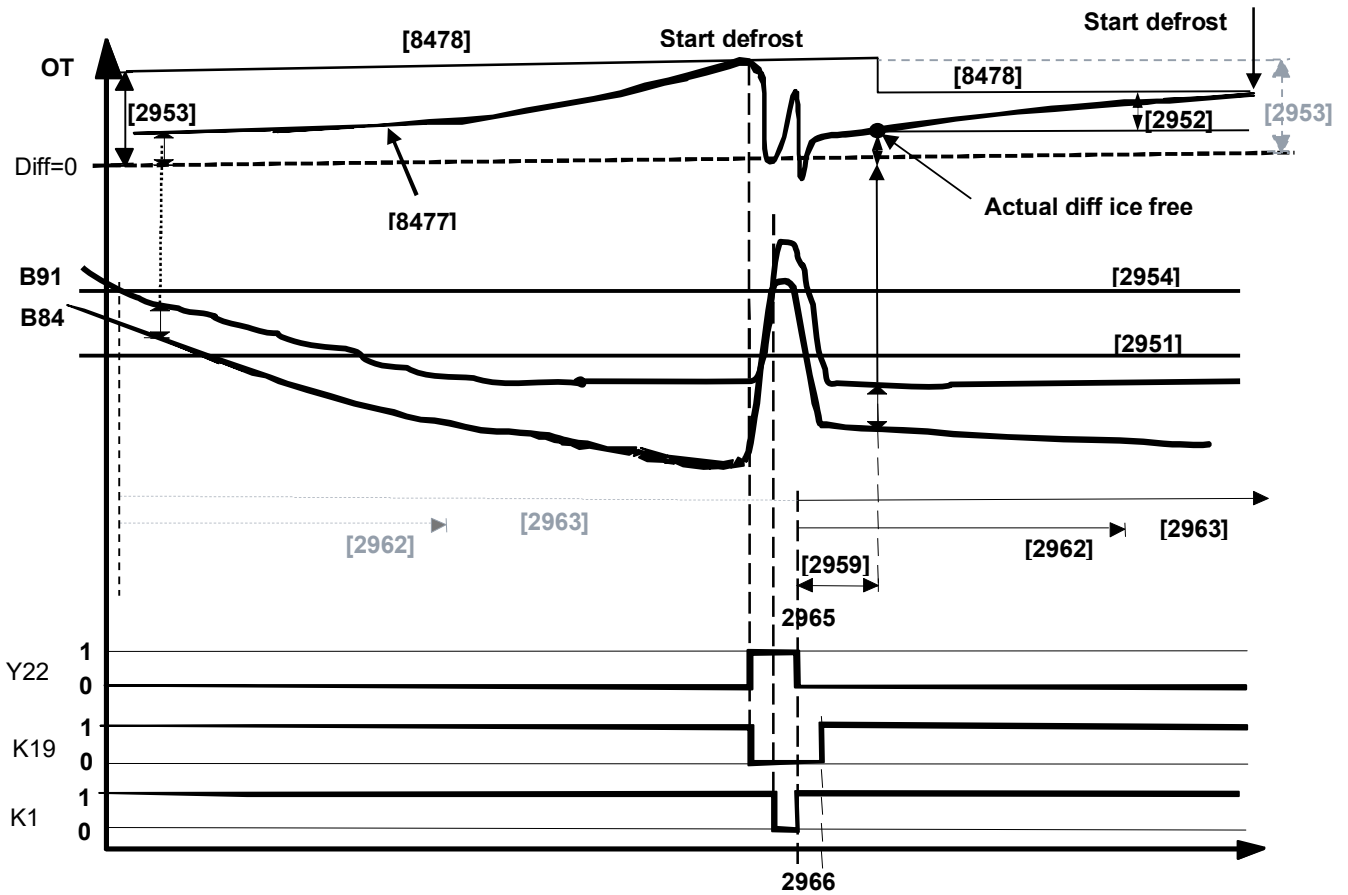

B91	Source inlet temperature	2951	Defrost release below OT
B84	Evaporator temperature	2952	Swi diff defrost
Y22	Process reversing valve	2953	Temp diff defrost max
K19	Fan source inlet	2954	Evapor temp defrost end
K1	Compressor	2959	Defrost settling time
		2962	Duration defrost lock
		2963	Time up to forced defrost
		2965	Dripping time evapor
		2966	Cooling down time evapor
		8477	Temp diff defrost act value
		8478	Temp diff defrost setpoint

Start of defrosting

When the compressor is in operation, "Duration defrost lock" (line 2962) and "Time up to forced defrost" (line 2963) elapse. If the source inlet temperature (B91) drops below the defrost release temperature (line 2951, "Defrost release below OT"), the "Defrost" function is released.

The heat pump switches to defrost mode after "Duration defrost lock" at the earliest, and on completion of "Time up to forced defrost" at the latest.

If, due to icing during this period of time, "Temp diff defrost act value" (line 8477) between the source inlet temperature (B91) and the evaporator (B84) exceeds the setpoint (line 8478, "Temp diff defrost setpoint"), the "Defrost" function is activated.

If, during this period of time, "Differential pressure switch defrost" (E28) responds, the "Defrost" function is triggered as well.

Defrosting is effected (depending on the source inlet temperature, see line 2971) either with the fan or through process reversal.

End of defrosting when defrosting through process reversal

When defrosting is successful, the evaporator temperature (B84) rises. When the evaporator exceeds "Evapor temp defrost end" (line 2954), the defrost process can be successfully completed, and the compressor is switched off during "Dripping time evapor" (line 2965). Then, heating mode is resumed.

With parameter "Cooling down time evapor" (line 2966), the fan's start is delayed. This way, the evaporator can cool down again before cold outside air is introduced by the fan.

End of defrosting when defrosting with the fan

Defrosting with the fan is considered ended when one of the 2 following conditions is satisfied:

- The temperature differential ("Temp diff defrost act value", line 8477) of source inlet (B91) and evaporator (B84) is smaller than parameter 2974, "dT end defrost fan".
- "Defrost duration fan" has elapsed.



For "Defrost duration fan", refer to description of parameters 2972 and 2973.

Starting heating mode and preparing for the next defrost process

Heating mode is resumed after successful completion of the defrost process through process reversal or with the fan. "Duration defrost lock", "Time up to forced defrost", and "Defrost settling time" (line 2959) are restarted. When the "Defrost settling time" has elapsed, the current differential is acquired and stored.

Now, this differential serves as the starting point for the next calculation of the differential of B91 and B84. If the differential increases by setting "Swi diff defrost" (line 2952), the next defrost process is triggered. The stored differential plus "Swi diff defrost" produce "Temp diff defrost setpoint" (line 8478).



Defrosting can also be performed manually. Either via an input EX1...EX4 or via line 7152, "Triggering defrost". When defrosting manually, no consideration is given to the release temperature (line 2951, "Defrost release below OT") and to "Duration defrost lock" (line 2962).



When a heat pump lock is pending, any active defrost process is ended.

Defrosting, settings

<i>Line no.</i>	<i>Operating line</i>
2951	Defrost release below OT

Defrost release below OT The "Defrost" function can be released only when the current source inlet temperature (B91) lies below the release temperature set here.
Above this source inlet temperature, the automatic "Defrost" function is not active (locked when $B91 > \text{line } 2951 + 1 \text{ Kelvin}$).

<i>Line no.</i>	<i>Operating line</i>
2952	Swi diff defrost
2953	Temp diff defrost max
2954	Evapor temp defrost end

Swi diff defrost If the acquired and stored differential of B91 and B84 after defrosting (and after the settling time) is exceeded by the switching differential set here, the controller triggers the next defrost process.

Temp diff defrost max This parameter is used only for as long as there is no valid stored temperature differential of source inlet (B91) and evaporator temperature (B84), that is, before initial defrosting and as a maximum limit.
If the temperature differential of source inlet (B91) and evaporator temperature (B84) exceeds the maximum value that can be set here, automatic defrosting is activated.

Evapor temp defrost end Defrosting through process reversal is successfully completed when the evaporator temperature reaches the temperature set here.

Defrosting with extraneous heat

Line no.	Operating line
2955	Compressor during defrost Off ; On

In the case of air-to-water heat pumps operating with an intermediate source circuit (also refer to description of Y81, line 5890), defrosting of the heat exchanger can be effected by using heat from a heat exchanger.

"Off" under "Compressor during defrost" is required to make certain the compressor remains off in this case.

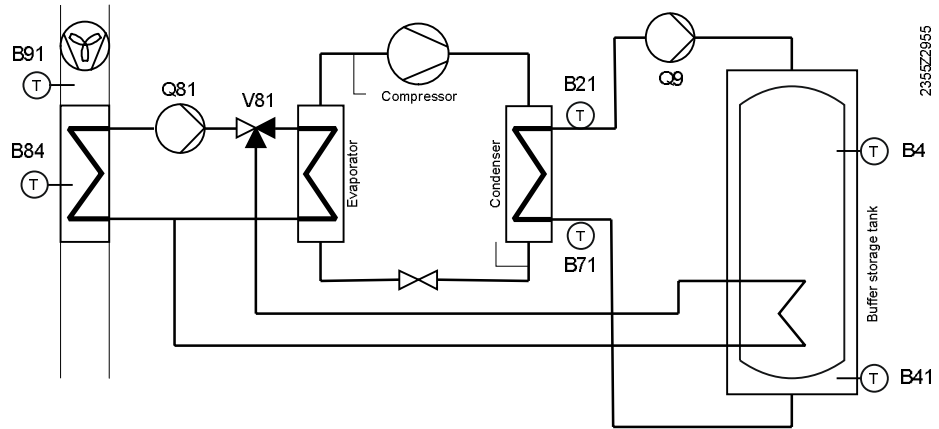

The defrost process cycle is basically the same as that with the compressor. The only difference is that the compressor remains off.

The required heat is supplied to the iced up heat exchanger from an installed storage tank through changeover of diverting valve Y81.

Line no.	Operating line
2956	dT cooling down end evapor

The fan is switched off at the end of defrost so that defrost heat can be provided again to the compressor and is not lost in extract air.

The fan remains switched off until the following two parameters are fulfilled:

- Line 2956 dT cooling down end evapor
- Line 2966 Cooling down time evapor

Both parameters must be fulfilled if both are set.

dT cooling down end evapor

The value source temperature B91 is saved at the end of defrost.

The fan only resumes operation after the compressor is switched on (without fan operation), once the evaporator temperature (B84) is below the value saved from B91 by the temperature differential entered here.

Line no.	Operating line
2958	Max num defrost repetitions

Max num defrost repetitions

If the defrost process could not be successfully ended, another attempt is made after a preheating phase (see "Duration defrost lock"). If it is still not possible to normally end the defrost process after the number of attempts set here, the heat pump is switched off and an error message is delivered (error 247:Defrost fault).



For the heat pump to resume operation, the fault must be manually reset.

Line no.	Operating line
----------	----------------

2959	Defrost settling time
2960	Duration dT start defrost
2962	Duration defrost lock
2963	Time up to forced defrost
2964	Defrost time max
2965	Dripping time evapor
2966	Cooling down time evapor

- Defrost settling time** "Defrost settling time" can be used to define the period of time the heat pump requires – after resuming heating mode – to reach a steady operating state. When, after successful defrosting, the heat pump switches to heating mode, the system waits until the "Defrost settling time" has elapsed and then stores the "Temperature differential when freed from ice". Prerequisite is that the temperature drops below the defrost release temperature (line 2951, "Defrost release below OT").
- Duration dT start defrost** The defrost process is started only when the start condition (see description "Swi diff defrost") was continuously satisfied during the parameterized delay time (line 2960).
- Duration defrost lock** When the heat pump is switched on in heating mode, "Duration defrost lock" is started. It is at the end of this period of time at the earliest the controller is allowed to start the next evaporator defrost attempt. Prerequisite for defrosting is that the source inlet temperature (B91) lies below the set release temperature (line 2951).
-  After a prematurely aborted defrost attempt (see "Defrost time max"), the heating water is preheated during "Duration defrost lock". If an electric immersion heater is installed in the flow or in the buffer/combi storage tank, it is switched on to support preheating. Then, a direct change to defrost mode is made.
- Time up to forced defrost** If the heat pump was in operation during the period of time set here – with no defrosting in the meantime – forced defrosting is activated. The same prerequisite applies here in that the source temperature (B91) must lie below the set release temperature (line 2951). Setting "- - -" switches off the function.

Settings for process reversal

- Defrost time max** If, in the case of defrosting via process reversal, it was not possible to successfully defrost the evaporator during "Defrost time max", or based on the minimum temperature in the condenser circuit (line 2970), the controller aborts the defrost process and tries again after the preheating phase (see "Duration defrost lock"). The permitted number of defrost attempts is limited by "Max num defrost repetitions" (line 958).
- Dripping time evapor** Before the heat pump is allowed to resume heating mode after successfully defrosting through process reversal, the "Dripping time evapor" set here must elapse. The heat pump resumes operation only on completion of this period of time, and the fan is switched on when the delay time preset by the supplier has elapsed.

Cooling down time evapor

Heating mode is resumed on completion of the defrost process through process reversal and when "Dripping time evapor" (line 2965) has elapsed.

"Cooling down time evapor" (line 2966) is used to define the period of time the fan remains deactivated **after** the resumption of heating mode.

This function prevents evaporation of the incoming outside air.

Setting "- - -" means that the fan is switched on before heating mode is resumed.

The period of time is the time set via parameter 2819, "Prerun time source".

<i>Line no.</i>	<i>Operating line</i>
2967	Temp thresh drip tray heat

Temp thresh drip tray heat

If, at the time the defrost process is started, the outside temperature (B9) or the source inlet temperature (B91) lies below the set temperature threshold, the drip tray heater (K41) is switched on. On completion of the defrost process, the drip tray heater remains switched on for another 3 minutes.

<i>Line no.</i>	<i>Operating line</i>
2968	Max compr output defrost
ACS	Position expansion valve when defrost

Max compr output defrost

During the defrost process, the compressor's current output is maintained. If the compressor's current output exceeds "Max compr output defrost", the output is reduced to the set value.

On completion of the defrost process and when the delay time has elapsed, the restriction is negated again.

Note

The following differentiation is made:

- With 1-stage heat pumps, the parameter has no impact.
- With 2-stage heat pumps, the second stage is locked when the parameter setting is $\leq 50\%$.

Position expansion valve when defrost (ACS)

When the function is activated, the expansion valve is driven to a fixed position during the defrost process with the compressor.

In that case, superheat control remains deactivated during this period of time.

Line no.	Operating line
2969	Defrost with DHW charging Automatically ; DHW ; Heating circuit ; HC, defrost delayed

Defrost with DHW charging

If defrosting during DHW charging is required, the following choices are available:

Automatically

Based on the return temperature, the decision is made whether defrosting can be effected during DHW heating or whether changeover to the heating circuit is required.

DHW

DHW charging will not be interrupted.

Heating circuit

DHW charging is interrupted during the defrost process. If required, the heating circuit pumps are put into operation for defrosting.

HC, defrost delayed

DHW charging is interrupted during the defrost process. First, the change to heating mode is made; then, the setting time (line 2839) must elapse for the defrost process to be started. On completion of the defrost process, the setting time must elapse; then, DHW charging is resumed.



If a DHW request is received while the defrost process is already running, the change to DHW charging is only made when the defrost process is ended.

Line no.	Operating line
2970	Switch-off temp min

Switch-off temp min

In defrost mode

Every time a defrost attempt is made, the controller acquires the temperature in the condenser circuit (B21 or B71).

If, during the defrost process, the temperature in the condenser circuit drops below "Switch-off temp min", defrosting is unsuccessful and therefore aborted.

When "Duration defrost lock" (line 2962) has elapsed, or when "Temp diff defrost max" (line 2953) is exceeded, a new attempt is made, provided this is permitted by "Duration defrost lock" (line 2958).

In cooling mode

If the flow (B21) or the return temperature (B71) falls below the minimum switch-off temperature, the compressor is switched off.

It is switched on again when the temperature at both sensors exceeds "Switching diff return temp" by the amount of "Switching diff return temp" (line 2840) and "Switch-off temp min" (line 2843) has elapsed.

Settings, fan settings

Line no.	Operating line
2971	Defrost fan above
2972	Defrost time fan min
2973	Defrost time fan max
2974	dT end defrost fan
2975	Speed Q9 by defrost
ACS	Defrost with fan above outside temp at 100% r.h.

Defrost fan above

Down to the source inlet temperature "Defrost fan above" set here, defrosting is effected with the fan. If the source inlet temperature falls below this level, defrosting is effected through process reversal with the compressor.



If there is a risk of icing ($B91 < \text{parameter } 2951$) and the source inlet temperature ($B91$) allows defrosting with the fan, defrosting is effected each time the compressor is shut down.

Defrost time fan min /max

Depending on the source inlet temperature ($B91$) at the time the defrost process is started, the defrost time with the fan is determined according to the following graph, based on "Defrost time fan min" and "Defrost time fan max". When, in the case of defrosting with the fan, this time is reached, the defrost process is considered to be successfully completed.

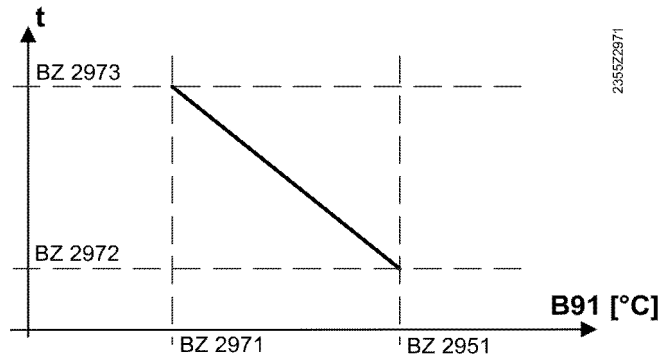

dT end defrost fan

Setting the required temperature differential of source inlet ($B91$) and evaporator ($B84$) needed to successfully end the defrost process with the fan.

Speed Q9 by defrost

The speed of the condenser pump during defrost with compressor can be individually configured.

- If no speed is specified, the speed is calculated based on plant hydraulics.
- The defrost speed is limited on the minimum side by a minimum speed (Defrost time fan min, OL 2792).

Defrost with fan above outside temp at 100% r.h. (ACS)

Example

The limit temperature at which defrosting with the fan is no longer possible so that process reversal is used can be defined more accurately (can be lower), if consideration is also given to the current outside air humidity.

At an outside temperature of 3 °C and low relative humidity, defrosting with the fan is almost impossible. The situation is a different one when the relative humidity is high. In that case, defrosting with the fan might still be possible.

To give consideration to outside air humidity, the following configuration is required:

- Assign function "Humidity measurement 10V" to one of the inputs Hx.
- Set parameter 5827 "Hum acquis air inlet H91" to that input Hx.
- Set the limit temperature for 100% relative humidity ("Defrost with fan above outside temp at 100% r.h.", ACS).

Principle of operation

Parameter "Defrost with fan above outside temp at 100% r.h." (ACS) is used to set the limit temperature that is still permitted (transition from defrosting with fan to defrosting through process reversal) when the relative humidity is at its maximum of 100%.

Parameter 2971 "Defrost fan above" is the limit value for "dry air" (controller-internally defined at 50% relative humidity).

From this, the limit temperature valid at the currently measured relative humidity for the transition from defrosting with the fan to defrosting through process reversal is calculated (in the following graph: Position (2)).

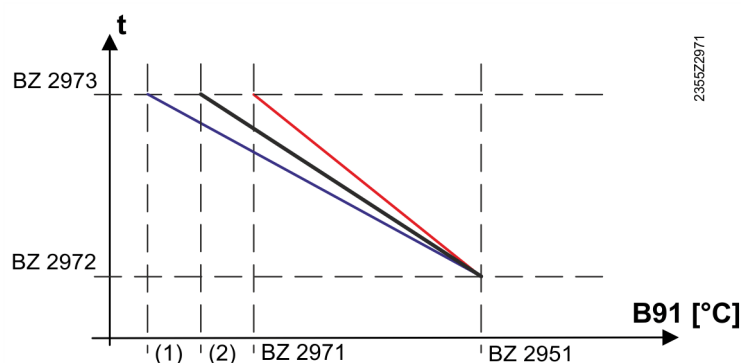

- 2951: Defrost release below OT
- 2971: Defrost fan above (relative humidity 50%)
- 2972: Defrost time fan min
- 2973: Defrost time fan max
- (1): Defrost with fan above outside temp at 100% r.h.
- (2): "Defrost fan above" at current humidity (calculated)

Line no.	Operating line
ACS	Defrost with electrical utility lock No Yes
ACS	Delay forced defrost after power up

Defrost with electrical utility lock (ACS)

Heat pump and electric immersion heaters can be locked via an AC 230 V input (parameterized as "Electrical utility lock E6").

If, in the case of an air-to-water heat pump, locking occurs during the defrost process, setting "Defrost with electrical utility lock" decides whether defrosting is first ended ("Yes"), or whether the compressor is immediately locked ("No").

Delay forced defrost after power up (ACS)

When, after power-up, the state of icing is not known, forced defrosting is triggered. Per default, the defrost process is started 60 seconds after the compressor. This time period can be adjusted.

Cooling

Line no.	Operating line
3000	Switch-off temp max cooling
3002	Source temp min cool mode
3004	SD ch'over cooling pas/act
3007	In passive cooling mode Condenser pump off Condenser pump on
3008	Temp diff cond cooling mode

Switch-off temp max cooling

If the return temperature (B71) lies above "Switch-off temp max cooling", the compressor must not be put into operation. If already running, it will be switched off.

On completion of the set pump prerun times (but not before 2 minutes have elapsed), the pumps are deactivated if the temperatures are still too high.

Another compressor startup attempt is made on completion of the minimum compressor off time ("Compressor off time min", line 2843).



This function is only active in the case of active cooling. It has no impact with passive cooling. For more information about active/passive cooling, refer to chapter "Cooling circuit".

Source temp min cool mode (Frost protection)

To prevent the formation of ice in the heat exchanger during passive cooling, a minimum source temperature can be entered. If the temperature at the source outlet sensor (B92) falls below the value set via parameter "Source temp min cool mode", the consumers are locked until the source outlet temperature exceeds the minimum temperature by 1 Kelvin.

SD ch'over cooling pas/act

If the source inlet temperature drops below the cooling setpoint minus the switching differential set here and the minimum compressor on time has elapsed, the controller switches to passive cooling.

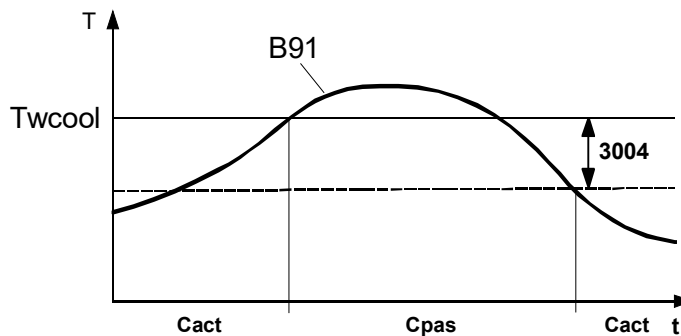

B91 Source inlet sensor
 Twcool Setpoint for cooling
 3004 SD ch'over cooling pas/act
 Cact Active cooling mode
 Cpas Passive cooling mode
 T Temperature
 t Time

In passive cooling mode

Defines the behavior of the condenser pump in passive cooling mode.

Condenser pump off

The condenser pump remains deactivated during passive cooling mode.

Condenser pump on

The condenser pump remains activated during passive cooling mode.

Temp diff cond cooling mode

To obtain the return temperature setpoint for active cooling mode, the current flow temperature setpoint (according to the cooling curve) is increased by the value set here.

If the setting is "0", the cooling curve in plants with return temperature control must be based on the return (plants with pump heating circuits and without buffer or combi storage tanks).

The setting is used for speed control of the condenser pump (parameter 2790 and ACS parameter for cooling mode).

Output control source

Speed control of the source pump or the fan is effected via a triac output (ZX) or output UX. For that purpose, the respective output is to be configured as "Source pump Q8/fan K19".



In addition, the source pump or the fan can be controlled via a relay output (on/off).

Speed control of the source pump/fan can be parameterized.

- Choice of up to 4 speed control strategies.
- For cooling mode, another of these 4 strategies can be selected.
 - If "- - -" is selected, the strategy of parameter 3009 applies.

Control strategies

Line no.	Operating line
3009	Modulation fan/source pump None Compressor output Temp diff evaporator
ACS	Modulation fan/source pump cooling mode --- None Refrig temp liquid Compressor output Temp diff evaporator

The control strategy for speed control is to be selected via parameter "Modulation fan/source pump" (BZ 3009) and for cooling mode, if required, via "Modulation fan/source pump cooling mode" (ACS).



- Strategy "Refrig temp liquid" can only be selected with "Modulation fan/source pump cooling mode" (ACS).
- For strategies "Refrig temp liquid" and "Temp diff evaporator", extra parameters are available which are listed and explained directly with the strategy.

Setting the source pump's modulation

For "Modulation fan/source pump" (line 3009) and, if required, also for "Modulation fan/source pump cooling mode" (ACS), the following speed control strategies are available:

None

The speed of the source pump/fan corresponds to the set "Speed max fan/source pump" (line 3010).



But monitoring functions can reduce the speed down to "Speed min fan/source pump" (line 3011), e.g. to make certain that the maximum evaporation temperature will not be exceeded.

Refrig temp liquid

(can only be selected with "Modulation fan/source pump cooling mode")

The fan speed of an air-to-water heat pump or of the source pump of a brine-to-water or water-to-water heat pump is controlled based on "Refrig temp liquid" (B83).

When switching on, the fan or source pump operates at the minimum speed (line 3011, "Locking time speed control") during the set "Speed min fan/source pump" (line 3017). Then, the speed changes according to the set straight line (see graph).

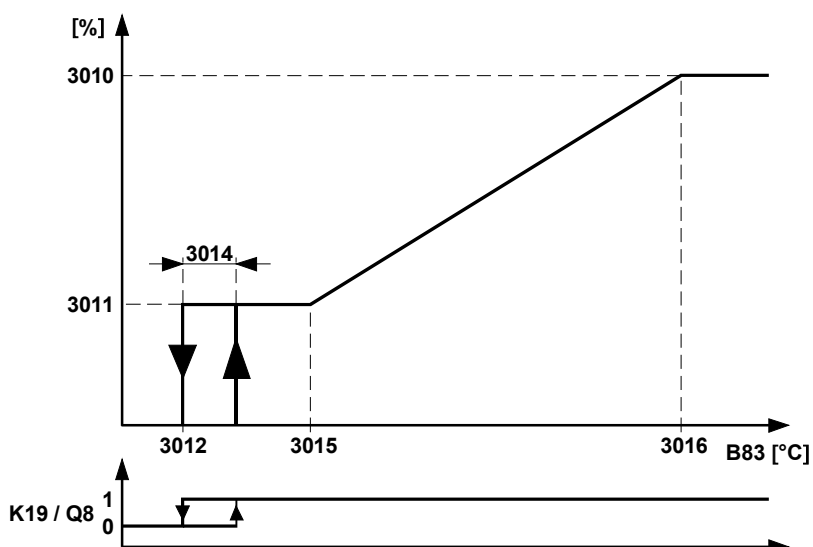

B83	Refrigerant temperature liquid	3010	Speed max fan/source pump
K19	Fan air-to-water heat pump	3011	Speed min fan/source pump
Q8	Source pump	3012	Source off below temp B83
		3014	Switching diff source off
		3015	Start speed control B83
		3016	End speed control B83

Further settings

Line no.	Operating line
3012	Source off below temp B83
3014	Switching diff source off
3015	Start speed control B83
3016	End speed control B83

Source off below temp B83

If the "Refrigerant temperature liquid" (B83) lies below the switch-off point "Source off below temp B83", the fan or source pump is switched off (or is not put into operation).

The compressor continues to operate. The fan is switched on again as soon as the temperature at B83 exceeds the switch-off point plus the switching differential.



The function can be deactivated ("- - -").

Switching diff source off

Setting the switching differential for "Source off below temp B83" (line 3012).

Start speed control B83/
End speed control B83

Below the set temperature "Start speed control B83", the fan or the source pump operates at the minimum speed (line 3011, "Start speed control B83").

If "Refrigerant temperature liquid" (B83) lies between "Start speed control B83" and "End speed control B83", the speed is increased in a linear manner until the maximum speed (line 3010, "Speed max fan/source pump") is reached.

If the "Refrigerant temperature liquid" (B83) exceeds the set temperature "End speed control B83", the fan or the source pump continues to operate at the set maximum speed (line 3010, "Speed max fan/source pump").

Compressor output

The speed of the source pump/fan is controlled according to the compressor output currently released. The action depends on the type of heat pump.

- 1-stage compressor

When the compressor is in operation, the source pump/fan runs at maximum speed.

- 2-stage compressor

When both compressors are in operation, the source pump/fan runs at maximum speed.

When one compressor is in operation, the source pump/fan runs at minimum speed.

- Modulating compressor

With this function, the speed of the source pump/fan depends directly on the compressor's current output.

If the compressor's output is $\leq 20\%$, the source pump/fan constantly operates at minimum speed.

If the compressor's output is $\geq 80\%$, the source pump/fan constantly operates at maximum speed.

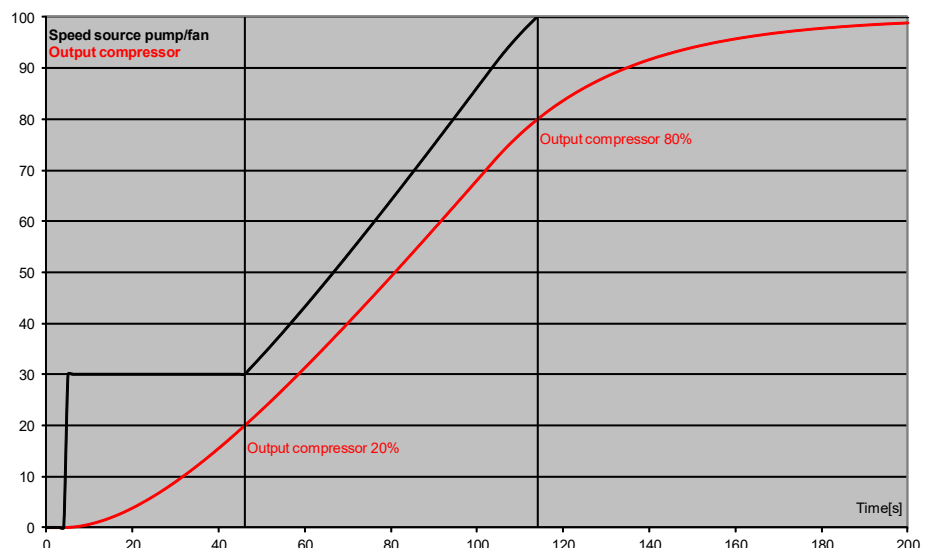

2355Z3009

Temp diff evaporator

Speed control tries to attain the parameterized and required temperature differential (line 2823, "Req temp diff evaporator") of source flow and source return sensor (B91/B92).

For cooling mode, a separate setpoint can be adjusted: "Required temp diff evaporator cooling mode" (ACS).



If the source return temperature (B92) is not known, control to the temperature differential of source inlet B91 and evaporation temperature H82 is provided as a substitute.

Further settings

<i>Line no.</i>	<i>Operating line</i>
3021	Speed fan/source pump Xp
3022	Speed fan/source pump Tn
3023	Speed fan/source pump Tv

Parameters Xp, Tn and Tv

By setting the right proportional band Xp, the integral action time Tn, and the derivative action time Tv the control action can be matched to the type of plant (controlled system).

Xp, Tn and Tv can be determined using common methods, e.g. the step response method depicted in Section "Xp, Tn, Tv – Step response method".

Brochure BT_0098_EN provides additional notes on control technology in buildings.

General settings

Line no.	Operating line
3010	Speed max fan/source pump
3011	Speed min fan/source pump
3017	Locking time speed control
3019	Start speed fan/sce pump
ACS	Max deviation suction gas temp
ACS	Outp limit with mod source Off ; Heating mode ; Cooling mode ; Heating and cooling mode

Speed max fan/source pump (line 3010)

This limits the control range of the fan or source pump speed at the top. In heating mode, this setting defines the constant speed.

Speed min fan/source pump (line 3011)
Locking time speed control (line 3017)

This limits the control range of the fan or source pump speed at the bottom.

During "Locking time speed control", the fan operates at "Start speed fan/sce pump").

Start speed fan/sce pump (line 3019)

The speed is limited by the set minimum and maximum speed. When switching on during the set "Locking time speed control", the fan runs at the set "Start speed fan/sce pump".

Max deviation suction gas temp (ACS)

If the source's output is sufficient and the heat exchanger is not undersized, the suction gas temperature is nearly at the level of the source inlet temperature. If the temperature differential exceeds a few tenths of a degree, it is an indication that the amount of heat transmitted via the evaporator is not sufficient. For this reason, the speed of the source pump is increased, if possible, aimed at keeping the evaporation temperature as high as possible.

Principle of operation

If the suction gas temperature B85 drops by more than "Max deviation suction gas temp" (ACS) below source inlet temperature B91, the speed of the source pump/fan is increased. As soon as the temperature differential becomes smaller again, the increase is reduced (neutral zone is 0.5 Kelvin).

Cooling mode

Preliminary remark: If, in cooling mode, the condenser operates in parallel mode, the temperatures cannot be compared the same way.



Therefore, in cooling mode, the function is active only when a "Cond reversing valve Y91" is used.

Then, the suction gas temperature is compared with the temperature acquired by return sensor B71, with action on the condenser pump.

Outp limit with mod source (ACS)

The counter-measures described in connection with monitoring of "Max condensation temp" (line 2785) and "Switch-off temp max" (line 2844) try to reduce the cooling capacity to prevent the heat pump from shutting down. This is reached preferably by reducing the compressor's output. Another option is a reduction of the evaporation temperature. If there is **no** electronic expansion valve, the last aforementioned measure can be implemented by reducing the speed of the source pump/fan. "Outp limit with mod source" (ACS) can be used to select in which operating situations this shall be permitted. Using this measure, the heat pump can work near its operating limit for longer periods of time (e.g. during DHW charging at high flow temperatures). On the other hand, a lower COP and – in the case of air-to-water heat pumps – increased icing up of the evaporator must be accepted.

Source pump/fan speed with special operating states

Generally, the speed of the source pump/fan is controlled according to the selected strategy (line 3009 ff.). However, with certain operating states, the selected control strategy is not suited or cannot be applied. The following table shows the speed behavior of the source pump/fan in such cases:

#	Plant state	Note	Speed behavior
1	Pump prerun	Line 2802	According to strategy ¹⁾
2	Pump overrun	Line 2803	According to strategy ¹⁾
3	Passive cooling mode		Maximum speed
4	Automatic sensor readjustment	Line 3030	Maximum speed
5	Defrost with fan		According to strategy ¹⁾
6	Pump off refrigerant	Line 3058	According to strategy
7	Pump off refrigerant, manually	Line 7153	According to strategy

1) Usually means "minimum speed" in practical operation

Silent mode

<i>Line no.</i>	<i>Operating line</i>
3025	Silent mode speed max
3026	Silent mode on
3027	Silent mode off
3028	Silent mode speed incr start
3029	Silent mode speed incr end

Silent mode serves for reducing noise by limiting the fan's speed during certain daylight or night hours. The limitation acts in all fan speed control modes and all heat pump operating modes.

What can be parameterized is a switch-on and a switch-off point and the possibility to appropriately adjust the silent mode at low outside temperatures.

Silent mode speed max

During a set time window (typically at night), the maximum fan speed is limited to the set value. If no maximum speed for silent mode is parameterized, the function is deactivated.

Silent mode on/off

A start and end time defines the time window for silent mode. Within this period of time, the fan's speed will not exceed the set maximum level.

Silent mode speed incr start/end

At low outside temperatures, the limitation can be canceled. If the outside temperature drops below the level set for the start of the increase, the maximum speed is raised in a linear manner to reach the initial value at the end of the increase (without silent mode).

The increase can be deactivated.



If the outside temperature (B9) is not available, the source inlet temperature (B91) is used to calculate the increase.

Sensor calibration

The "Sensor calibration" function can be used to readjust the 2 heat pump sensors B21 (flow) and B71 (return) as well as B91 (source inlet) and B92 (source outlet) with the following parameters and to calibrate them against one another.

If the temperature differential of flow and return sensor is used to determine the energy delivered, the sensors need to be calibrated against one another due to the relative large sensor tolerances. The calibration must be made on the sensors actually used in the plant.



If possible, the sensors should be calibrated at a temperature level of between 20 °C and 40 °C. The deviation of both sensors and the required readjustment should normally be <1 Kelvin and should not exceed 2 Kelvin.

Line no.	Operating line
3030	Auto readj HP cond sensor Off Now After pump prerun
3031	Readj HP flow sensor
3032	Readj HP return sensor
3033	Readj status Not readjusted Manually readjusted Automatically readjusted Readjustment running
3035	Readj source inlet sensor
3036	Readj source outlet sens
3038	Readj source int circ flow
3039	Readj source int circ return

Automatic readjustment

Automatic readjustment ensures that with the same temperatures at the flow and return sensor, the values used for the control and the calculation of the yearly performance factor are the same. A calibration using absolute temperatures is not done.

NOTE

Both sensor elements must be brought to the same temperature before making the automatic readjustment.

Auto readj HP cond sensor

Now

Setting "Now" triggers instantly automatic sensor readjustment. During the calibration, "Readj HP flow sensor" is set based on the temperature differential acquired between flow and return sensor.

$$T_{\text{readjB21}} = T_{\text{readjB71}} + (T_{\text{B71}} - T_{\text{B21}})$$



For the calibration to be made, the temperature at both sensor values must lie between 5 °C and 50 °C, the difference being a maximum of 3 Kelvin.



After pump prerun

If "After pump prerun" is selected, condensor pump Q9 is first switched on for 8 minutes, followed by the calibration.

The controller automatically activates function "Relay test Q9" to switch on the condensor pump. For this reason, the key symbol and special operating mode "Output test" are displayed during this time. The prerun time cannot be adjusted.

The readjustment can be immediately enforced at any time during pump prerun by selecting "Now". "Off" aborts the prerun without readjustment.

If a calibration at absolute temperatures is required, return temperature sensor B71 must be calibrated manually before making the automatic readjustment. The readjusted value of the return temperature sensor is not changed for automatic readjustment.

Readj HP flow sensor / return sensor	Using 2 separate parameters (3031 for the flow and 3032 for the return), the temperatures acquired by sensors B21 and B71 can be manually readjusted by a maximum of ± 20 Kelvin.
	 Menu "Input/output test" displays the measured sensor values without any readjustment. The readjusted temperature values used for the control are shown on menu "Diagnostics heat generation".
Readj status (Status display)	The readjustment state is displayed on the room unit/HMI directly by the readjustment parameters for the flow and the return sensor (double display). The ACS service tool displays the state on a separate operating line. The readjustment state is maintained even after power down.
	<p>Not readjusted The values were not readjusted, neither manually nor automatically, or automatic readjustment was aborted or did not work.</p> <p>Manually readjusted At least one of the readjustment values was changed via operation.</p> <p>Automatically readjusted The sensors were calibrated using automatic sensor readjustment. The readjustment values were not changed anymore afterwards.</p> <p>Readjustment running Pump prerun was started for automatic sensor readjustment. The readjustment has not yet been made.</p>
Readjustment source inlet sensor/source outlet sensor	Temperatures measured by sensors B91 and B92 can each be manually readjusted with a separate parameter (parameter 3035 for source inlet and parameter 3036 for source outlet) by a maximum of ± 20 Kelvin.
	 The menu "Input/output test" displays the measured temperature without a readjustment and the temperature values used for control are displayed in menu "Diagnostics heat generation". OL 3030 and 3033 have no impact on the source sensor.
Readjustment Source intermediate circuit flow and return sensor	Temperatures measured at sensors B93 and B94 can each be manually readjusted with a separate parameter (parameter 3038 for the source intermediate circuit flow sensor and parameter 3039 for source intermediate circuit return) by maximum ± 20 Kelvin.
	 In menu "Input/output test", the measured sensor values without readjustment are displayed and the readjusted temperature values used for control in the menu "Diagnostics heat generation". OL 3030 and 3033 have no impact on the source intermediate circuit sensor.

Superheat control (SHC)

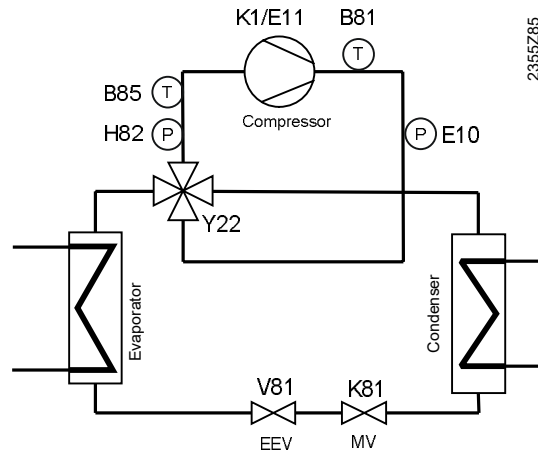

B85	Suction gas temperature
H82	Evaporation pressure (evaporation temperature calculated via refrigerant characteristic)
V81	Electronic expansion valve (EEV)
K81	Magnetic valve (MV)

Operation with 2 suction gas sensors

In the case of reversible heat pumps, a separate suction gas sensor (B88) can be selected for cooling mode.

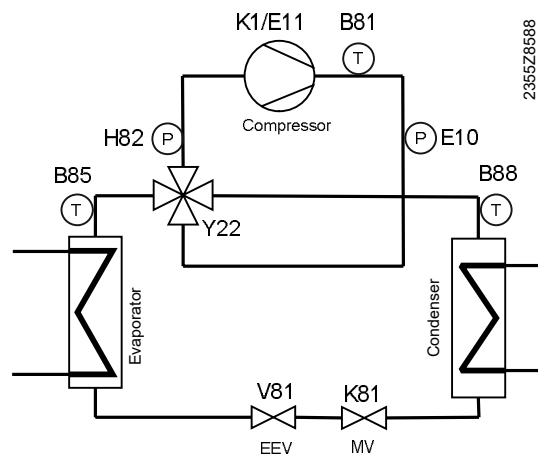

If 2 suction gas sensors B85 and B88 are installed and configured, the sensor for superheat control is selected depending on operation:

- B85: Heating mode.
- B88: Cooling mode, defrosting.



- If one suction gas sensor is used for both heating and cooling mode, B85 must be configured.
- If only B88 is configured, a configuration error is displayed.

<i>Line no.</i>	<i>Operating line</i>
3042	Superheat setpoint
3043	Superheat controller Xp
3044	Superheat controller Tn
3045	Superheat controller Tv
3046	Expansion valve run time
3047	Min superheat
3049	Superheat setp cooling mode
3050	Superheat incr silent mode
ACS	SHC setp source 20
ACS	SHC setp source 15
ACS	SHC setp source 7
ACS	SHC setp source 2
ACS	SHC setp source -7
ACS	SHC setp source -15
ACS	SHC setp source -25

Superheat controller

The superheat controller is a PID controller. P-, I- and D-action can be adjusted (lines 3043, 3044, and 3045).

Parameters Xp, Tn and Tv

By setting the right proportional band Xp, the integral action time Tn, and the derivative action time Tv the control action can be matched to the type of plant (controlled system).

Xp, Tn and Tv can be determined using common methods, e.g. the step response method depicted in Section "Xp, Tn, Tv – Step response method".

Brochure BT_0098_EN provides additional notes on control technology in buildings.

Expansion valve run time

Setting the running time of the expansion valve. This is the time required by the valve to travel from the fully closed to the fully open position.

Parameter "Expansion valve run time" is used only if the valve is controlled via one of the outputs UX (DC 0...10 V).



If a WX output is parameterized for use with an expansion valve, the running time is calculated from the stepper motor data.

Setting the superheat setpoint

To set the superheat setpoint, a number of parameters are available (3042, 3049, and 3050, plus various ACS settings).

Superheat setpoint

The control system stabilizes the temperature differential of suction gas and evaporation temperature (superheat) at the set "Superheat setpoint" by controlling the refrigerant flow via the electronic expansion valve.



The control and the magnetic valve (MV) are released as soon as a compressor is put into operation. To ensure that refrigerant does not enter the evaporator during off times, the control is locked when the compressor is off, and the expansion and magnetic valve are shut.

Superheat setp cooling mode

For cooling mode, the superheat setpoint is adjusted separately.



When changing from heating to cooling mode, or vice versa, the higher of the 2 setpoints applies during "Sett!time process reversal" (line 2838).

Superheat incr silent mode

When silent mode is active (line 3025 and subsequent lines), the superheat setpoint is increased by an adjustable value "Superheat incr silent mode".

SHC setp source 20 to SHC setp source -25

The superheat setpoint is defined for different source temperatures. Values in between are interpolated in a linear manner. To activate dependency on the source temperature, the fixed "Superheat setpoint" needs to be deactivated (line 3042: "---").

There is no need to define all points. Deactivated points are not considered when generating the setpoint.



This curve only applies to heating mode. In cooling mode, it is ways the fixed "Superheat setpoint" that is used.

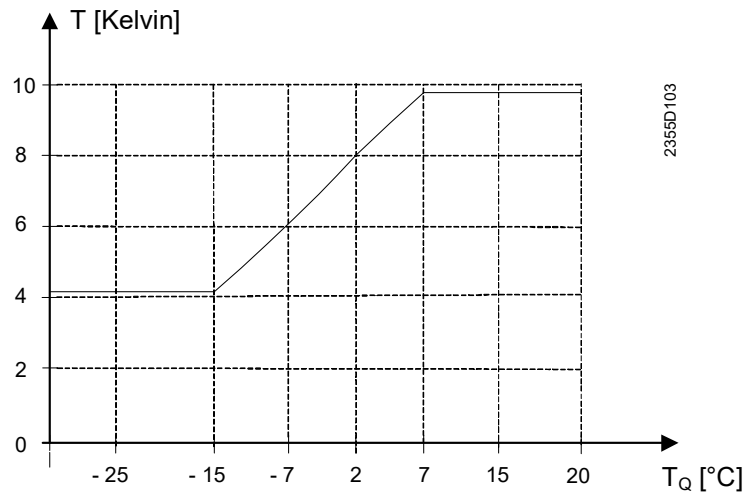

T_Q: Source temperature

Min superheat

The minimum superheat is continuously monitored. If the superheat falls below the set limit value "Min superheat", the superheat setpoint is increased, causing the expansion valve to reduce the refrigerant flow.

This is independent of the way the superheat setpoint is determined.

Behavior on compressor start

Line no.	Operating line
3051	Delay compressor start
3052	Pos expansion valve start
3053	Delay superheat controller

The expansion valve's behavior on compressor start can be influenced via the following settings:

- Degree of valve opening when compressor is started: "Pos expansion valve start"
- Time period with valve fully open until compressor is started: "Delay compressor start"
- Delay time upon compressor start until superheat is released: "Delay superheat controller"

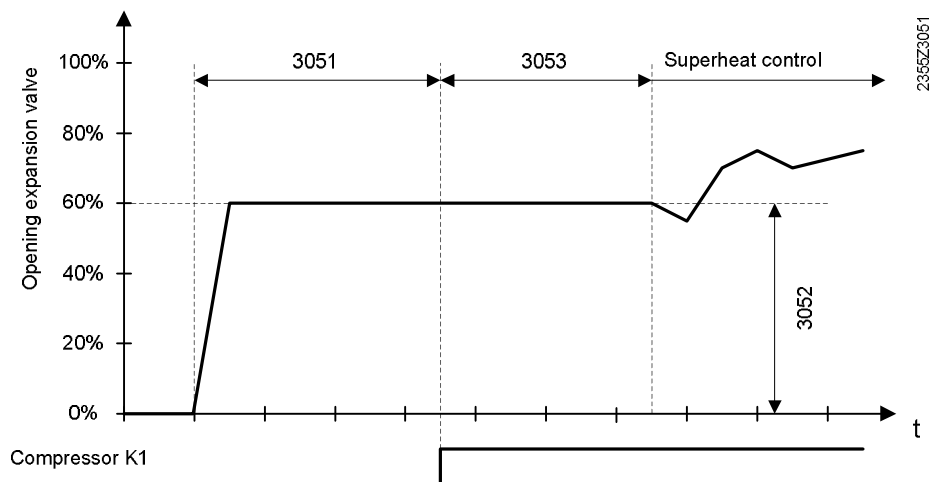

3051: Delay compressor start
 3052: Pos expansion valve start
 3053: Delay superheat controller

Adaptive superheat setpoint

Line no.	Operating line
3054	Superheat setp adaption Off Heating mode Cooling mode Heating and cooling mode
ACS	Adaption lock upon compressor start
ACS	Adaption lock upon change of superheat setp
ACS	Wait time up to red superheat setp adapt
ACS	Adaption lock upon increase of superheat setp
ACS	Min deviation superheat setp adapt
ACS	Max deviation superheat setp adapt
ACS	Critical deviation superheat setp adapt
ACS	Adaption step superheat setp
ACS	Max increase superheat setpoint adapt

Physical interrelationships

- Great superheat leads to a stable, less fluctuating evaporation process.
- Too little superheat leads to an instable, uncontrollable evaporation process.
- The smaller the superheat, the better the efficiency.
- The smallest, still stable superheat depends on a number of influencing factors and is difficult to calculate.

Adaptive superheat setpoint

Adaptive superheat control tries to find the minimum, still stable superheat under the current operating conditions.

- The fixed (parameter 3042) or source-dependent (various ACS parameters) superheat setpoint is used as the starting value.
- Adaption reduces the superheat in steps and, at the same time, monitors the stability.
- Whenever there are signs of instable behavior, superheat is not reduced any further.

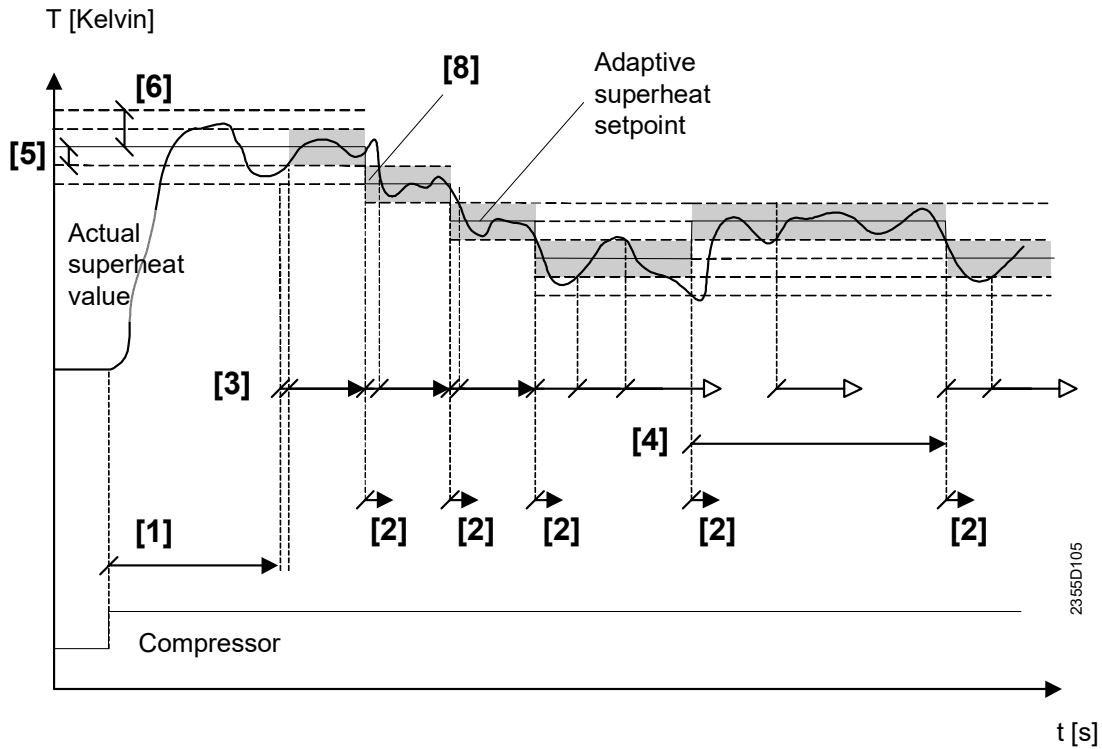

- [1] Adaption lock upon compressor start
- [2] Adaption lock upon change of superheat setp
- [3] Wait time up to red superheat setp adapt
- [4] Adaption lock upon increase of superheat setp
- [5] Min deviation superheat setp adapt
- [6] Max deviation superheat setp adapt
- [7] Critical deviation superheat setp adapt (not shown)
- [8] Adaption step superheat setp
- [9] Max increase superheat setpoint adapt (not shown)

Superheat setp adaption	The function is enabled via "Superheat setp adaption". It can be activated in "Heating mode", "Cooling mode", or "Heating and cooling mode".
Compressor start	Upon compressor start or changeover of the process reversing valve, adaption remains disabled for an adjustable period of time "Adaption lock upon compressor start" [1]. If adaption is disabled or deactivated, superheat is controlled according to the fixed (parameter 3042) or source-dependent (various ACS parameters) superheat setpoint.
Evaluation of control deviation	General rule: Evaluation of the control deviation always waits until the settling times "Adaption lock upon compressor start" [1], "Adaption lock upon change of superheat setp" [2], and "Adaption lock upon increase of superheat setp" [4] have elapsed.
Decrease of superheat	If the deviation of the actual value from the adaptive setpoint always remains within "Wait time up to red superheat setp adapt" [5] during "Min deviation superheat setp adapt" [3], either upward or downward, the setpoint is lowered by one "Adaption step superheat setp" [8]. The magnitude of the adaption step can be adjusted.
Increase of superheat	If the deviation of the actual value from the adaptive setpoint exceeds "Max deviation superheat setp adapt" [6], either upward or downward, the setpoint is immediately increased by one adaption step. If the deviation of the actual value from the adaptive setpoint exceeds "Critical deviation superheat setp adapt" [7, not shown in the graph], either upward or downward, the setpoint is immediately increased by 2 adaption steps. After an increase, no more decrease is allowed during "Adaption lock upon increase of superheat setp" [4]. The superheat setpoint can also be increased to a level above the initial value, but by no more than "Max increase superheat setpoint adapt" [9, not shown in the graph].
Stabilization after a change	If the superheat setpoint is changed through adaption, the function remains disabled for further setpoint changes during "Adaption lock upon change of superheat setp" [2].

MOP control

At high source temperatures, temperatures above "Max evaporation temp" (line 2826) must be prevented.

By closing the expansion valve, the refrigerant flow is reduced so that the evaporation temperature drops. For that, the superheat setpoint is increased to such a degree that the evaporation temperature remains "Max evaporation temp reduction" (ACS) below "Max evaporation temp".



- For behavior of heat pump when "Max evaporation temp" is exceeded, refer to parameter 2826.
- MOP stands for Maximum Operating Pressure.

Output limitation with SHC

Line no.	Operating line
ACS	Output limitation with SHC Off Heating mode Cooling mode Heating and cooling mode

The counter-measures described in connection with monitoring of "Max condensation temp" (line 2785) and "Switch-off temp max" (line 2844) try to reduce the cooling capacity to prevent the heat pump from shutting down.

This is reached preferably by reducing the compressor's output.

Another option is a reduction of the evaporation temperature by closing the expansion valve.

"Output limitation with SHC" (ACS) can be used to select in which operating situations this shall be permitted.

Using this measure, the heat pump can work near its operating limit for longer periods of time (e.g. during DHW charging at high flow temperatures).

On the other hand, a lower COP and – in the case of air-to-water heat pumps – increased icing up of the evaporator must be accepted.

Line no.	Operating line
3056	Output control with SHC Off Heating mode Cooling mode Heating and cooling mode
ACS	Output control with SHC Xp
ACS	Output control with SHC Tn

Internal output control

The compressor's output can be influenced indirectly via superheat control. This internal output control is used when controlling to the flow temperature setpoint (B21).

Principle: Refrigeration output is reduced by increasing the superheat.

The refrigerant flow is reduced, causing the evaporation temperature to drop and the superheat to increase.

Output control with SHC

Internal output control is especially suited for multistage compressors, thus allowing the implementation of continuous output control.

When using modulating compressors: Internal and "normal" output control have their restricted fields of use:

- Internal output control (lower range) interferes only when the compressor's output cannot be reduced any further.
- "Normal" output control (upper range) is started only when internal output control no longer influences the superheat setpoint.

Internal output control lowers the evaporation temperature to a limit 3 Kelvin above "Min evaporation temp" (line 2825).

The use of internal "Output control with SHC" can be restricted to heating or cooling.



SHC stands for Super Heat Control.

The increase of the superheat setpoint is calculated by a PI controller.

Parameters Xp and Tn

By setting the right proportional band Xp and integral action time Tn, the control action can be matched to the type of plant (controlled system).

Xp and Tn can be determined using common methods, e.g. the step response method depicted in Section "Xp, Tn, Tv – Step response method".

Brochure BT_0098_EN provides additional notes on control technology in buildings.

<i>Line no.</i>	<i>Operating line</i>
ACS	Max deviation superheat

Max deviation superheat (ACS)

In situations where the evaporation temperature is artificially kept at a low level so that superheat exceeds the setpoint significantly (MOP control, output limitation via SHC, output control via SHC), superheat can be reduced again to a practical level by lowering the speed of the source pump. In addition:

- Too high hot-gas temperatures are prevented.
- Source pump/fan use less energy and noise is reduced.

Principle of operation

If superheat exceeds the superheat setpoint by more than "Max deviation superheat" (ACS), the speed of the source pump/fan is reduced. As soon as the temperature differential becomes smaller again, speed reduction is negated in steps (neutral zone is 0.5 Kelvin).

Cooling mode

In cooling mode, the function acts in the same way on the condenser pump.

Detecting faulty expansion valves (V81)

<i>Line no.</i>	<i>Operating line</i>
ACS	Delay expansion valve evaporator error

If the valve maintains one of the 2 stop positions beyond "Delay expansion valve evaporator error" (ACS), the heat pump is shut down and an error message ("505:Expansion valve evap") is delivered.

Pump off function

<i>Line no.</i>	<i>Operating line</i>
3058	Pump off function Off Automatic
3059	Pump off funct press limit

Pumping off refrigerant (pumpdown)

Automatically

Before the compressor is switched off, the pump evacuates the evaporator. This is accomplished by letting the compressor continue to run while the valve is shut until the low-pressure switch (E9) trips or, at H82, the pressure falls below an adjustable low-pressure threshold (line 3059, "Pump off funct press limit").

Off

The function can be deactivated.

Manually

If the function is activated manually (line 7153, "Pumping off refrigerant"), the compressor is switched on and the expansion valve shut.

The compressor is switched off when the low-pressure switch trips or when the adjustable low-pressure threshold (line 3059) is reached.

After manually pumping off, the compressor is locked. The heat pump can only be put back into operation after a "Heat pump reset" or power-down.



If the low-pressure threshold is not reached after 2 minutes, the function is aborted.

Vapor injection (EVI)

Line no.	Operating line
3062	Superheat setpoint EVI
3063	EVI controller Xp
3064	EVI controller Tn
3065	EVI controller Tv
3066	Expansion valve EVI run time

Superheat setpoint EVI

The control system stabilizes the temperature differential of suction gas and evaporation temperature (superheat) at the set "Superheat setpoint EVI" by controlling the refrigerant flow with the electronic expansion valve.



To acquire the evaporation temperature, a pressure sensor H86 or temperature sensor B87 can be connected (between valve and economizer).

Electronic injection valve

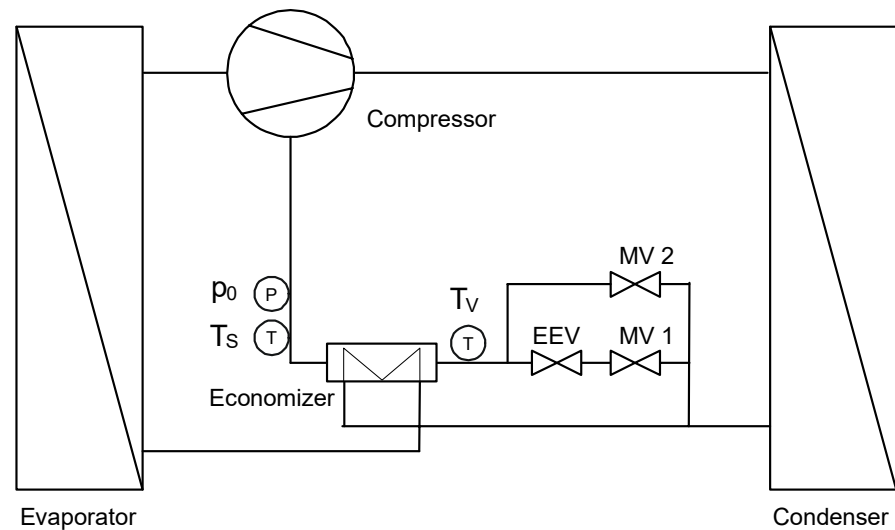

- T_s Suction gas temperature (B86)
- P₀ Evaporation pressure (H86); the evaporation temperature is calculated with the help of the refrigerant characteristic
- T_v Evaporation temperature (B87)
- EEV Electronic expansion valve (V82)
- MV1 Magnetic valve vapor injection (K82)
- MV2 Magnetic valve saturated vapor injection (K83)



EVI stands for Enhanced Vapor Injection.

Parameters Xp, Tn, and Tv

By setting the right proportional band Xp, integral action time Tn, and the derivative action time Tv, the control action can be matched to the type of plant (controlled system).

Xp, Tn and Tv can be determined using common methods, e.g. the step response method depicted in Section "Xp, Tn, Tv – Step response method".

Brochure BT_0098_EN provides additional notes on control technology in buildings.

Expansion valve EVI run time

Setting the running time of the injection valve (EVI).
If a WX output is parameterized for use with an injection valve, the running time is calculated from the stepper motor data.
Parameter "Expansion valve EVI run time" is only used if the valve is controlled via one of the outputs UX (DC 0...10 V).

<i>Line no.</i>	<i>Operating line</i>
3071	Threshold hot-gas temp EVI
3072	SD hot-gas temp EVI
3073	Threshold source temp EVI
3074	SD source temp EVI

Vapor injection

Vapor injection is only on when the compressor is running.

Threshold hot-gas temp EVI

Vapor injection is activated when the hot-gas temperature (B81) exceeds "Threshold hot-gas temp EVI".

SD hot-gas temp EVI

It is switched off again when the hot-gas temperature is at a level of "SD hot-gas temp EVI" (switching differential) below the switch-on threshold.

Threshold source temp EVI

Vapor injection is activated when the source temperature drops below "Threshold source temp EVI".

SD source temp EVI

It is switched off again when the source temperature is at a level of "SD source temp EVI" above the switch-on threshold.

Line no.	Operating line
3077	Swi-off temp sat vapor op
3078	Thresh hot-gas temp satur
3080	Thresh source temp satur

Saturated vapor injection

Thresh hot-gas temp satur

Saturated vapor injection is activated when the hot-gas temperature (B81) exceeds "Thresh hot-gas temp satur".

It is switched off again when the hot-gas temperature is at a level of "SD hot-gas temp EVI" (line 3072) below the switch-on threshold.

Thresh source temp satur

Saturated vapor injection is activated when the source temperature drops below "Thresh source temp satur".

It is switched off again when the source temperature is at a level of "SD source temp EVI" (line 3074) above the switch-on threshold.

Switch-off temp max

Saturated vapor injection is also activated when the maximum switch-off temperature (line 2844, "Switch-off temp max") in the reduced range (see lines 2836 and 2837) is exceeded.

For operation with saturated vapor injection, a separate, reduced switch-off temperature (line 3077, "Swi-off temp sat vapor op ") can be set.

The graph shows this range below the green line.

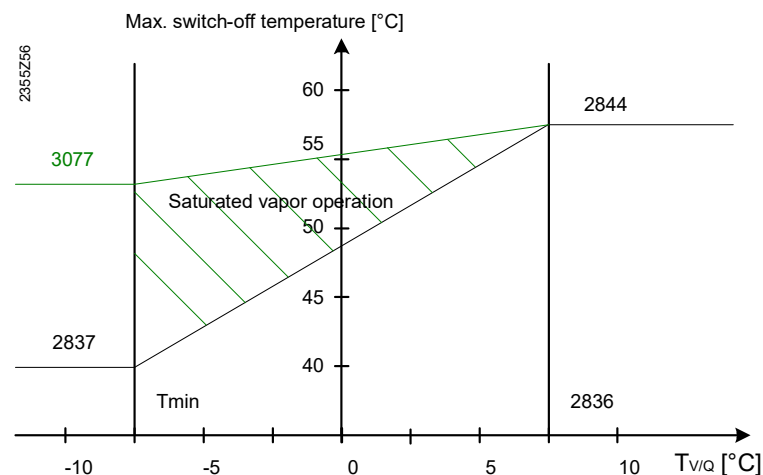

Tmin: Depending on the type of source (line 2812, 2815, 2816, or 2825)
T_{v/a}: Evaporation/source temperature

2836: Start swi-off temp red
2837: Swi-off temp max reduced
2844: Switch-off temp max

Behavior of the valve

Magnetic valve and injection capillary

As soon as one of the conditions for saturated vapor injection is satisfied, the magnetic valve "Valve EVI K82" (if installed) and "Valve injection capillary K83" are opened.

Electronic expansion valve

As soon as the hot-gas temperature exceeds "Thresh hot-gas temp satur" (line 3078), a change to hot-gas control is made. The setpoint used for control of the injection valve is also parameter 3078.

If saturated vapor injection is activated based on "Thresh source temp satur" (line 3080), the expansion valve is fully opened.



Limitation of the maximum valve position can be effected via the stepper motor's parameterization (ACS).

6.11 Energy meters

The controller can measure and display the amount of energy drawn from the source, the electrical energy input and the amount of energy supplied to the heating system.

This way, information on the plant's efficiency (performance factor) can be provided.

The Hx inputs offer the following choice of functions:

- **Pulse count:**
Connection of externally installed electricity, gas, heat or flow meters.
- **Flow measurement:**
Flow measurement; connection of flow sensors delivering voltage (10 V) or frequency signals (Hz).
- **Temperature measurement:**
Connection of temperature sensors delivering voltage signals (10 V).

The availability of the functions at the respective inputs is as follows:

<i>Inputs</i>	<i>H1/H3</i>		<i>H2</i>	<i>H21</i>	<i>H22</i>
Pulse count	Yes	Yes	No	Yes	Yes
Flow measurement 10 V	Yes	Yes	Yes	Yes	Yes
Flow measurement Hz	Yes	Yes	No	Yes	Yes
Temperature measurement 10 V	Yes	Yes	Yes	Yes	Yes

The heat pump's flow and return temperatures are acquired either via temperature measurement at one of the inputs Hx or via the resistance temperature sensors connected to Bx.

The functionality implemented in the controller, employed for acquiring the energy input/energy delivered and for calculating the yearly performance factor is based on the following model:

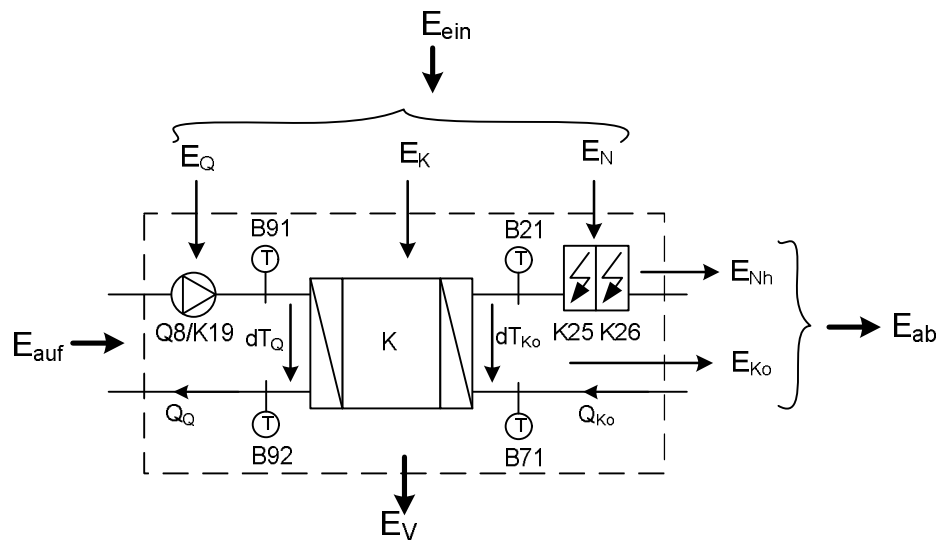

E_{ein}	Energy input ($E_Q + E_K + E_N$)
E_{ab}	Energy/heat delivered for space and DHW heating ($E_{Nh} + E_{Ko}$)
E_{auf}	Energy drawn from the environment (geothermal heat, ground water, air) ($dT_Q \times Q_Q$)
E_V	Technical losses
E_Q	Energy used to operate the source (pump/fan)
E_K	Energy used to operate the compressor (electricity or gas)
E_N	Electrical energy used to operate the electric immersion heaters K25/K26
E_{Nh}	Energy/heat delivered by the electric immersion heaters K25/K26
E_{Ko}	Energy/heat delivered by the condenser ($dT_{Ko} \times Q_{Ko}$)
dT_{Ko}	Temperature differential across the condenser (B21 - B71)
Q_{Ko}	Volumetric flow through the condenser
dT_Q	Temperature differential across the evaporator (B91 - B92)
Q_Q	Volumetric flow through the evaporator
Q8	Brine-to-water heat pump
K19	Fan (air-to-water heat pumps)
K25	Electric immersion heater 1, flow
K26	Electric immersion heater 2, flow
B21	Flow sensor
B71	Return sensor
B91	Source flow sensor
B92	Source return sensor

To acquire the energy flows depicted above, the controller provides the following functions:

Size	Function in the controller	Reference
E_Q	Calculating the electrical energy required to operate the source pump or the fan via adjustable output parameter [kW] and the effective running time.	Line 3108
E_K	Metering the electrical energy [kWh] to operate the compressor with an external electricity meter and connection to the pulse count input, or Metering the volumetric gas flow [m ³] with an external gas meter and connection to the pulse count input. Calculation of the gas energy [kWh] required to operate the compressor, based on the adjustable mean gas energy content [kWh/m ³]. or Calculating the amount of energy used per the settings mentioned in Line 3197.	Line 3100, Line 3102, Line 3103, Line 3104, Line 3106
E_N	Decision whether the thermal energy delivered (E_{Nh}) by the electric immersion heater shall also be regarded and metered as electrical energy input ($E_N = E_{Nh}$).	Line 3109
E_{ein}	Metering the total amount of electrical energy [kWh] required to operate the system (compressor, source and electric immersion heater) with an external electricity meter and connection to the pulse count input, or Adding the calculated energy required to operate the source and the electric immersion heater to the metered energy required to operate the compressor ($E_Q + E_N + E_K$).	Line 3113 (Display)
E_{Nh}	Calculating the thermal energy delivered by the electric immersion heaters via adjustable output parameters [kW] and the effective operating time.	Line 5811, Line 5813
E_{Ko}	Metering the volumetric flow through the condenser [l] with an external flow meter and connection to the pulse count input, or metering the volumetric flow [l/min] with an external flow meter and connection to the metering input. Measuring the temperature differential of heat pump flow (B21) and return (B71) and calculation of the amount of heat delivered, or Calculating the volumetric flow through the condenser via the adjustable pump flow rate [l/h] and the effective running time/speed. Measuring the temperature differential of heat pump flow (B21) and return (B71) and calculation of the amount of heat delivered,	Line 3090, Line 3092, Line 3093, Line 3094, Line 3095 Line 3097, Line 3098
E_{ab}	Metering the total amount of thermal energy [kWh] delivered with an external heat meter and connection to the pulse count input, or Adding the calculated and metered amounts of thermal energy of the electric immersion heater and the condenser ($E_{Nh} + E_{Ko}$).	Line 3110 (Display)
E_{auf}	Metering the volumetric flow through the source [l] with an external flow meter and connection to the pulse count input, or metering the volumetric flow [l/min] with an external flow meter and connection to the metering input. Measuring the temperature differential of source flow (B91) and return (B92) and calculating (based on volumetric flow and heat capacity of the source medium) the amount of heat drawn, or Calculating the volumetric flow through the source via adjustable pump flow rate [l/h] and effective running time/speed. Measuring the temperature differential of source flow (B91) and return (B92) and calculating (based on volumetric flow and heat capacity of the source medium) the amount of heat drawn,	Line 3112 (Display) Line 3250, Line 3252, Line 3253, Line 3254, Line 3255 BZ 3257 BZ 3260, BZ 3261
E_v	Not acquired	

Heat delivered

Pulse count

Line no.	Operating line
3090	Pulse count heat None With input H1 With input H21 module 1 With input H21 module 2 With input H21 module 3 With input H22 module 1 With input H22 module 2 With input H22 module 3 With input H3

Pulse count heat

Parameter "Pulse count heat" is used to select input Hx for metering the amount of heat or the volumetric flow of water:

None

No metering via input Hx. This setting is important if the inputs are used for other pulse counts.

With input Hx

The pulse counter is read via the selected input and the energy determined from it is added to the meter reading for the amount of heat delivered.



It is important that input Hx selected here is also set in the configuration for the "Pulse count".

Pulse valency

Line no.	Operating line
3092	Pulse unit heat None kWh Liter
3093	Pulse value heat numer
3094	Pulse value heat denom

The value of a pulse is entered with 3 setting parameters as a quotient (nominator and denominator) and the physical unit:

Pulse unit heat = kWh

The pulses or their energy values are added directly to the meter reading for the amount of heat delivered.

Pulse unit heat = liters

Using the pulses or their volume value, the acquired temperature differential of flow and return plus the specific heat capacity of water, the thermal energy is calculated and then added to the meter reading for the amount of heat delivered.

Pulse valency = (numerator/denominator) * unit

Example 1

Pulse value heat numer = 10
Pulse value heat denom = 1
Pulse unit heat = liters

→ Pulse valency = 10 liters/pulse

Example 2

Pulse value heat numer = 1
Pulse value heat denom = 1
Pulse unit heat = kWh

→ Pulse valency = 1 pulse/kWh

**Flow measurement
10 V/Hz**

Line no.	Operating line
3095	Flow measurement heat None ; With input H1 ; With input H2 module 1 ; With input H2 module 2 ; With input H2 module 3 ; With input H21 module 1 ; With input H21 module 2 ; With input H21 module 3 ; With input H22 module 1 ; With input H22 module 2 ; With input H22 module 3 ; With input H3

In place of using the pulse count, the flow can also be measured with a flow sensor (10 V or Hz) connected to an Hx input.

Flow measurement heat

Parameter "Flow measurement heat" is used to select the Hx input for making the flow measurements:

None

No metering via input Hx. This setting is important if the inputs are used for making other flow measurements (e.g. solar yield).

With input Hx

The flow via the selected input is acquired and used for calculating the volume. The determined volume is multiplied by the acquired temperature differential and the specific heat capacity of water, and then added as thermal energy to the meter reading for the amount of heat delivered.



The Hx input selected here must be set in the configuration for flow measurement (10 V or Hz).

Calculation of flow

Line no.	Operating line
3097	Flow heating
3098	Flow DHW

**Flow heating,
Flow DHW**

In place of pulse count or flow measurement, volume calculation can be used. Based on an adjustable flow output ("Flow heating", "Flow DHW"), running time and speed, this function calculates the theoretical volumetric flow through the condenser.

$\text{Volume [l]} = \text{running time [min]}/60 * \text{speed [\%]} * \text{volumetric flow [l/h]}$

The volumetric flow can be set separately for heating mode and DHW heating. The running time is acquired with an accuracy of 1 minute. In heating mode, the state of condenser pump Q9 is acquired, in DHW heating mode, the state of charging pump/diverting valve Q3.

The calculated volume is multiplied by the acquired temperature differential and the specific heat capacity of water, and then added as thermal energy to the meter reading for the amount of heat delivered.



Using this function and the acquired temperature differential, the amount of thermal energy delivered can be acquired without having to install a heat meter.



To ensure sufficient accuracy for the temperature differential, we recommend to calibrate sensors B21 and B71 relative to one another.



If the thermal energy shall not be metered through internal volume calculation, the function must be deactivated via both parameters ("---").

Energy input (electricity/gas)

Line no.	Operating line
3100	Pulse count energy None With input H1 With input H21 module 1 With input H21 module 2 With input H21 module 3 With input H22 module 1 With input H22 module 2 With input H22 module 3 With input H3

Pulse count energy

Parameter "Pulse count energy" is used to select an input Hx for metering the electrical energy or the volumetric flow of gas:

None

No metering via input Hx. This setting is important if the inputs are used for other pulse counts.

With input Hx

The pulse counter is read via the selected input and the energy determined from it (electricity or natural gas) is added to the meter reading for the amount of energy input.



The Hx input selected here must be set in the configuration for the pulse count.

Pulse valency

Line no.	Operating line
3102	Pulse unit energy None kWh m3
3103	Pulse value energy numer
3104	Pulse value energy denom

The value of a pulse is entered with 3 setting parameters as a quotient (nominator and denominator) and the physical unit:

Pulse unit energy = kWh

The pulses or their energy values are added directly to the meter reading for the amount of energy input.

Pulse unit energy = m3

Using the pulses or their volume value and the mean gas energy content, the gas energy is calculated and then added to the meter used for metering the energy input.

Pulse valency = (numerator/denominator) * unit

Example 1

Pulse value energy numer = 1
Pulse value energy denom = 100
Pulse unit energy = m3

→ Pulse valency = 0.01 m3/pulse (or 100 pulses/m3)

Example 2

Pulse value energy numer = 1
Pulse value energy denom = 100
Pulse unit energy = kWh

→ Pulse valency = 100 pulses/kWh (or 0.01 kWh/pulse)

Gas energy content

Line no.	Operating line
3106	Mean gas energy content

If the pulse count is parameterized for volume (pulse unit energy = m3), the gas energy input is calculated based on the metered volume and the adjustable mean gas energy content:

$$\text{Gas energy [kWh]} = \text{volume [m3]} * \text{mean gas energy content [kWh/m3]}$$

The value of the gas energy is then added to the meter reading for the amount of energy input.

Electrical source output

Line no.	Operating line
3108	Electrical source output

Based on the adjustable electrical source output, the running time and speed, this function calculates the electrical energy theoretically required to operate the source (pump/fan):

$$\text{Source operation [kWh]} = \text{running time [min]}/60 * \text{speed [\%]} * \text{electrical source output [kW]}$$

The running time is acquired with an accuracy of 1 minute. The state of source pump Q8 or air fan K19 is acquired.

The energy determined for source operation is added to the meter reading for the amount of energy input.



If source energy metering is not desired, the function must be deactivated via the output parameter ("---").

Line no.	Operating line
3109	Int count el imm heater flow None Heat delivered Energy brought in Both

Int count el imm heater flow

The energy input via the electric immersion heater installed in the flow can be added to one of the meter readings.

None

The energy input is not metered.

Heat delivered

The energy input is added to meter reading "Heat delivered".

Energy brought in

The energy input is added to meter reading "Energy brought in".

Both

The energy input is added to meter readings "Heat delivered" and "Energy brought in".



The energy input is calculated based on the number of hours run and the output of the electric immersion heaters (lines 5811 and 5813).

Energy meter/performance factor

Meters/performance factor

The following parameters are displayed values of the metered or calculated values.

Line no.	Operating line
3110	Heat delivered
3112	Heat drawn by source
3113	Energy brought in
3116	Performance factor

Heat delivered

The metered and calculated amounts of heat are added to meter reading "Heat delivered" at 1-minute intervals.

$$\text{Heat delivered} = \text{heat (metered)} + dT * \text{volume (calculated)} * K + dT * \text{volume (metered)} * K + \text{heat electric immersion heater}$$

K: Heat capacity



- Inside the controller, the heat delivered for heating mode and DHW charging is acquired separately, but displayed is only the total. The fixed day storage shows the values separately, however (parameters 3120....3189).
- Heat acquired during cooling mode for room cooling, is not metered.
- The display shows "---" if no "Metering" function (pulse or calculation) is selected.
- With the respective access right, the counter can be set to zero via operation and, via the ACS tool, to any desired value. This leads to a fixed day entry.

Heat drawn by source

The metered and calculated amounts of heat are added to meter reading "Heat drawn by source" at 1-minute intervals.

$$\text{Heat drawn by source} = \text{heat (metered)} + dT * \text{volume (measured/metered)} * K + dT * \text{volume (calculated)} * K$$

K: Heat capacity

NOTE

If the total amount of heat drawn is acquired by measuring/metering via input Hx, the respective internal calculation functions must be deactivated.



- Inside the controller, the amount of heat drawn for heating mode and DHW charging is acquired separately, but displayed is only the total.
- In the case of space cooling mode, the amount of energy drawn is not metered.
- The display shows "---" if no "Metering" function (pulse or volume/heat calculation) is selected.
- With the respective access right, the ACS tool can be used to set the meter to any desired value. This leads to a fixed day entry.

Energy brought in The energy increase (electricity or gas) determined via the pulse count and the calculated energy increase for operation of the source are added to meter reading "Energy brought in" at 1-minute intervals.

Energy brought in =
energy source operation (calculated) + electrical energy or gas (metered or calculated) + energy electric immersion heater (calculated)

-  • Inside the controller, the energy required for heating mode and DHW heating is acquired separately, but displayed is only the total. The fixed day storage shows the values separately, however (parameters 3120...3188).
- Heat acquired during cooling mode for room cooling, is not metered.
- The display shows "---" if no "Metering" function (pulse or calculation) is selected.
- With the respective access right, the ACS tool can be used to set the meter to any desired value. This leads to a fixed day entry.

Performance factor The performance factor is calculated from the 2 meters used for metering the energy delivered (parameter 3110) and the energy input (parameter 3113):

$$\text{Performance factor} = E_{ab} / E_{ein}$$

If, in place of the amount of heat delivered, the amount of heat drawn from the source is acquired, the performance factor is calculated as follows:

$$\text{Performance factor} = (E_{auf} + E_{ein}) / E_{ein}$$

-  The performance factor displays "---" if one of the 2 energy meters is not used (no "Metering" function set) and also displays "---".

Fixed day and fixed day storage

Fixed day storage (yearly performance factor)

The fixed day storage retains the total of meter values on the fixed day to calculate the yearly performance factor for the previous period.

For consumption or plant analyses, the underlying yearly energy data (separately for space heating, DHW heating, and cooling) are stored as well.

The following values are displayed per entry:

- Fixed date (storage date).
- Yearly perf factor 1...n
- Heat delivered heating 1...n
- Heat delivered DHW 1...n
- Cooling energy delivered 1...n
- Energy brought in heating 1...n
- Energy brought in DHW 1...n
- Energy brought in cooling 1...n

Displayed are the amounts of energy delivered and input over the course of one year (or between 2 fixed day entries).

Line no.	Operating line
3119	Fixed day yearly perf fact

Fixed day yearly performance factor

Parameter "Fixed day yearly perf fact" is used to set the date of the fixed day (day/month).

An entry is generated in the storage at mid-night of the set fixed day. The process is repeated annually. Entry of the fixed day cannot be deactivated.

Meter values

The meter values shown in the fixed day storage are the energy values acquired over the time period between the 2 fixed day entries, which are used to calculate the associated yearly performance factor.

The energy delivered and energy input for space heating, DHW heating and cooling are shown separately.

The fixed day storage makes it possible to store up to 10 entries (10 years). The first entry (index 1) is always the latest and moves the older entries in the index back 1 place. If the storage entry is empty, "---" is displayed as the counter value.

Overview of the respective operating lines:

Fixed day storage	Yearly perf factor 1...10, Fixed day 1...10	Heat delivered heating 1...10	Heat delivered DHW 1...10	Cooling energy delivered 1...10	Energy brought in heating 1...10	Energy brought in DHW 1...10	Energy brought in cooling 1...10
1. year	3120	3121	3122	3123	3124	3125	3126
2. year	3127	3128	3129	3130	3131	3132	3133
3. year	3134	3135	3136	3137	3138	3139	3140
4. year	3141	3142	3143	3144	3145	3146	3147
5. year	3148	3149	3150	3151	3152	3153	3154
6. year	3155	3156	3157	3158	3159	3160	3161
7. year	3162	3163	3164	3165	3166	3167	3168
8. year	3169	3170	3171	3172	3173	3174	3175
9. year	3176	3177	3178	3179	3180	3181	3182
10. year	3183	3184	3185	3186	3187	3188	3189

Yearly performance factor

Calculation of the yearly performance factor is based on the following definition:
The yearly performance factor is the quotient of energy delivered (E_{ab}) and energy input (E_{ein}) over a period of one year.

$$\text{Yearly performance factor} = \frac{\text{energy delivered}}{\text{energy input (over a period of one year)}}$$

Energy delivered Thermal energy for space heating and DHW heating together.

Energy input Energy required to operate the heat pump (compressor, source pump and fan) and for the electric immersion heaters.

With air-to-water heat pumps, the electrical energy required for defrosting is added to the energy input.



When calculating the yearly performance factor, cooling mode is not taken into consideration.

Definitions

Assignment of the acquired flows of energy to space or DHW heating is based on the following operating state definitions:

Heating mode.

Heating mode is defined as follows:

- All operating states which, in the following, are not specifically defined as DHW heating, cooling or defrost mode.

In heating mode, ...

- the acquired energy input is metered as energy used for space heating,
- the acquired amount of energy delivered is metered as heat used for space heating.

DHW heating

DHW heating is defined as follows:

- When a charging request with absolute priority is active.
- When a charging request is active and a diverting valve or separate circuit is configured.

In DHW heating mode, ...

- the energy input is metered as energy used for DHW heating,
- the energy delivered is metered as heat used for DHW heating.

All other types of DHW heating are considered to be heating mode operation, especially when no or shifting charging priority is selected.

Cooling mode (room cooling)

Cooling mode is defined as follows:

- Active cooling mode with process reversal is active.
- Passive cooling mode ex brine circuit is active.

In cooling mode, ...

- The amount of energy drawn is metered as energy used for cooling.
- The amount of energy delivered is metered as energy supplied for cooling.

Defrost mode (air-to-water heat pumps)

No special consideration is given to defrost mode. Depending on the plant's operating state, the amounts energy are added to space heating or DHW heating.

<i>Line no.</i>	<i>Operating line</i>
3190	Reset fixed day storage

Reset fixed day storage

Parameter "Reset fixed day storage" clears the entire storage with all entries. All entries or their values are displayed as "---".

Extended energy metering

Extended energy acquisition

<i>Line no.</i>	<i>Operating line</i>
3192	Int count el imm heater DHW None Heat delivered Energy brought in Both
3193	Int count el imm heat buffer None Heat delivered Energy brought in Both

Int count el imm heater DHW / Int count el imm heat buffer

The energy fed to the DHW storage tank and buffer storage tank via the electric immersion heater can be added to the reading of one of the meters.

None

The energy of the electric immersion heater is not metered.

Heat delivered

The energy of the electric immersion heater is added to meter reading "Heat delivered".

Energy brought in

The energy of the electric immersion heater is added to meter reading "Energy brought in".

Both

The energy of the electric immersion heater is added to meter readings "Heat delivered" and "Energy brought in".



The energy input is calculated based on the number of hours run and the output of the electric immersion heaters (lines 5740 and 5872).

<i>Line no.</i>	<i>Operating line</i>
3195	Electric pump power heating
3196	Electric pump power DHW

Electric pump power heating / Electric pump power DHW

The electric pumping power set here is used by the controller to calculate the energy required for operating these pumps.

This energy is calculated based on the running time and, if required, and the degree of modulation to be added to the energy input according to operating line 3113.

This means that the performance factor also gives consideration to the pumps' power consumption (line 3116).

<i>Line no.</i>	<i>Operating line</i>
3197	Electric power compressor

Electric power compressor

The electric compressor power is used by the controller to calculate the energy required to operate the compressor.

The calculation is enabled if the parameter "Electric power compressor" is set to on and no Hx input is configured for electric power consumption.

For "Electric power compressor", the electric power consumption must be set at 100 % compressor modulation (maximum power).

The present electric energy is calculated based on compressor power and the present operating point (source inlet temperature and flow temperature) per the characteristic curve for electrical power.

i The function must be switched off ("---") if you do not want to calculate electric compressor power.

The following settings influence the calculation (for descriptions, see Compressor 2 / power data):

Line	Parameter	Minimum	Maximum	Unit
3197	Electric power compressor	0.1	100	KW
ACS	El compr. power at source temp 1 and flow temp 1	0	600	%
ACS	El compr. power at source temp 1 and flow temp 2	0	600	%
ACS	El compr. power at source temp 2 and flow temp 1	0	600	%
ACS	El compr. power at source temp 2 and flow temp 2	0	600	%
ACS	OT limit compressor power	-25	35	°C
ACS	Minimum compressor power below OT limit	0	100	%
ACS	Minimum compressor power over OT limit	0	100	%

The present electric power consumption for the compressor is displayed in the Menu Energy meter / "Energy brought in" (Line 3113).

i The present compressor power has no minimum limit if "OT limit compressor power" is switched off.

Compressor power has a minimum limit as set by the parameter "Minimum compressor power over OT limit" if there is no outside sensor (B9) and "OT limit compressor power" is switched on.

Heat input (source)

Line no.	Operating line
3250	Pulse count source None With input H1 With input H21 module 1 With input H21 module 2 With input H21 module 3 With input H22 module 1 With input H22 module 2 With input H22 module 3 With input H3

Pulse count source

Parameter "Pulse count heat" is used to select an input Hx for metering the amount of heat or the volumetric flow of water:

None

No metering via input Hx. This setting is important if the inputs are used for other pulse counts.

With input Hx

The pulse counter is read via the selected input and the energy value or flow determined with it is used for metering the amount of heat drawn.



It is important that input Hx selected here is also set in the configuration for the "Pulse count".

Pulse valency

Line no.	Operating line
3252	Pulse unit source None kWh Liter
3253	Pulse value source numer
3254	Pulse value source denom

The value of a pulse is entered with 3 setting parameters as a quotient (nominator and denominator) and the physical unit:

Pulse unit source = kWh

The pulses or their energy values are added directly to the meter reading for the amount of heat drawn.

Pulse unit source = liters

The pulses or their volume values are multiplied by the measured temperature differential and the heat capacity of the source medium, and then added as thermal energy to the meter used for the heat drawn.

Pulse valency = (numerator/denominator) * unit

Example 1

Pulse value source numer = 10

Pulse value source denom = 1

Pulse unit source = liters

→ Pulse valency = 10 liters/pulse

Example 2

Pulse value source numer = 1

Pulse value source denom = 1

Pulse unit source = kWh

→ Pulse valency = 1 pulse/kWh

**Flow measurement
10 V/Hz**

Line no.	Operating line
3255	Flow measurement source None ; With input H1 ; With input H2 module 1 ; With input H2 module 2 ; With input H2 module 3 ; With input H21 module 1 ; With input H21 module 2 ; With input H21 module 3 ; With input H22 module 1 ; With input H22 module 2 ; With input H22 module 3 ; With input H3

In place of using the pulse count, the flow can also be measured with a flow sensor (10 V or Hz) connected to an Hx input.

Flow measurement
source

Parameter "Flow measurement source" is used to select an input Hx for making volumetric flow measurements:

None

No measurement via input Hx. This setting is important in case inputs Hx are used for other volumetric flow measurements.

With input Hx

The flow via the selected input is acquired and used for calculating the volume. The determined volume is multiplied by the measured temperature differential and the specific heat capacity of the source medium and then added as thermal energy to the meter reading for the amount of heat drawn.



It is important that the Hx input selected here is also set in the configuration for the volumetric flow measurement.

**Calculation of
volumetric flow**

Line no.	Operating line
3257	Flow source

Flow source

In place of the pulse count or flow measurement, volumetric flow calculation can be used. Based on an adjustable flow output ("Flow source"), the running time and speed, this function calculates the theoretical volumetric flow through the evaporator.

$$\text{Volume [l]} = \text{running time [min]}/60 * \text{speed [\%]} * \text{volumetric flow [l/h]}$$

The running time is acquired with an accuracy of 1 minute.

The calculated volume is multiplied by the measured temperature differential and the specific heat capacity of the source medium and then added as thermal energy to the meter reading for the amount of heat drawn.



If the thermal energy shall not be metered through internal volume calculation, the function must be deactivated via both parameters ("---").

Measurement of temperature differential

The flow and the return temperature at the evaporator are measured. Based on the temperature differential, the water volume passing through the evaporator and the heat capacity of the source medium, the amount of thermal energy drawn can be calculated.

Temperature differential dT_Q [K] =
source inlet temperature (B91) minus source outlet temperature (B92)

If both sensors (B93 and B94) are located in the intermediate source circuit, they are used to determine the temperature differential.

Temperature differential dT_Q [K] =
source intermediate circuit flow temperature (B93) minus source intermediate circuit return temperature (B94)



To calculate the temperature differential, the sensors must always be used as pairs (e.g. combination B91 – B94 is not permitted).

Heat capacity source medium

Line no.	Operating line
3260	Antifreeze source None Ethylene glycol Propylene glycol Ethyl and propyl glycol
3261	Antifreeze concentr source

The controller calculates the heat capacity of the water as a function of its density or its temperature according to a stored algorithm.

In the case of brine-to-water heat pumps, the heat coefficient is also dependent on the type of antifreeze used:

- Use of antifreeze and type ("Antifreeze source": None, Ethylene glycol, Propylene glycol, Ethyl and propyl glycol)
- concentration of antifreeze ("Antifreeze concentr source": 1...100%)

Energy prices

<i>Line no.</i>	<i>Operating line</i>
3264	E'gy price high-tariff
3265	E'gy price low/sm grid wish
3266	E'gy price sm grid imposed
3267	E'gy price altern source

E'gy price high-tariff

Price per kWh electrical energy, high-tariff.

E'gy price low/sm grid wish

Price per kWh electrical energy for low tariff or during smart grid state "Draw wish".

E'gy price sm grid imposed

Price per kWh electrical energy during smart grid state "Draw imposed".

E'gy price altern source

Price per kWh heating energy, delivered by the installed second generator (e.g. calculated from the gas or oil price).



- Energy prices are to be entered without their units. But to be able to make comparisons, a uniform currency unit (e.g. cent/kWh) must be used.
- The energy price information can be used to switch several generators according to ecological or economical criteria (see parameter 2903 ff.).

6.12 Cascade (heating and cooling)

Generator sequences

The basis used to operate heating or cooling cascades is the generators' sequence, that is, the order in which the different generators are switched on and off.

To set the generator sequence, a number of parameters are available (e.g. selection of lead generator).

Basis for the generator sequence is the order of the device addresses.

Heating and cooling cascades

This chapter describes heating and cooling cascades at the same time because many parameters apply to both applications. Main differences in terms of settings:

- There are no different switch-on strategies for cooling cascades (in contrast to lines 3510 and 3514 for heating cascades).
- In the case of cooling cascades, the existing generator sequence can be mirrored (line 3542).

Operating mode/strategy [heating only]

<i>Line no.</i>	<i>Operating line</i>
3510	Lead strategy Late on, early off Late on, late off Early on, late off According to buffer temp
3511	Output band min
3512	Output band max
3514	Stage sequence Serial, release all 2nd stage Serial, release last stage Parallel, release last stage

Lead strategy

Late on, early off

Additional generators are switched on as late as possible ("Output band max") and switched off again as early as possible ("Output band min") to have the smallest possible number of generators in operation, or to obtain short running times for additional generators.

Late on, late off

Additional generators are switched on as late as possible ("Output band max") and switched off again as late as possible ("Output band min"); in other words, the generators operate with the smallest possible number of switching cycles.

Early on, late off

Additional generators are switched on as early as possible ("Output band min") and switched off again as late as possible ("Output band max") to have the largest possible number of generators in operation, or to obtain long running times for additional generators.

According to buffer temp

The generators are switched on and off depending on the storage tank temperatures.

If the temperature at all sensors (B4, B41, and B42) lies below the required flow temperature, the control system releases the first generator stage. Additional generator stages are released every time the set switch-on delay time has elapsed.

As soon as the setpoint is reached at the buffer storage tank sensor at the top, the control system locks the stage released last (provided more than one stage is released). If the temperature at the buffer storage tank sensor in the middle reaches the setpoint, release of the last but one stage is canceled. If the temperature drops below the setpoint, the stage is released again. The same behavior applies to the buffer storage tank sensor at the bottom.

If all buffer storage tank sensors acquire temperatures above the required flow temperature setpoint, and the generation lock is not yet active, additional stages are switched on or off depending on the temperature acquired by the common flow temperature sensor (B10) and the lead strategy "Late on, late off".

Output band min/max

The values are used as switching on/off criteria according to the selected lead strategy.

Stage sequence

Parameter "Stage sequence" is used to select the required sequence of stages. The sequence of stages determines the order in which the cascade master releases and locks the available generator stages. The recommended sequence of stages depends on the types of generators used in the cascade (oil/gas boilers, heat pumps, etc.).

Serial, release all 2nd stage

With this sequence of stages, every generator is released with its basic stage first and then with its second stage/modulation stage, in accordance with its priorities. The second stages/modulation stages of all released generators are given release for control.

This means:

- Using their second stage, multistage generators may switch on/off in accordance with their setpoints and temperatures.
- Modulating generators may provide control with their modulation stage,
- but 1-stage generators are not allowed to use their stage for cycling.

This sequence of stages is used primarily in connection with oil or gas boilers.

Serial, release last stage

With this sequence of stages, every generator is released with its basic stage first and then with its second stage/modulation stage, in accordance with its priorities. The stage/modulation stage released last is the only stage given release of control.

This means:

- Only the output stage switched on last may switch on/off according to the setpoint and the generator's temperature.
- Modulating generators may provide control with their modulation stage.

This sequence of stages is used primarily in connection with heat pump cascades.

Generators with "optimum efficiency"

If generators are employed that use function "Output optimum", parameter 2867, setting "Serial, release last stage" the following strategy is pursued:

- The stages are released in a way that the generators first put into operation within their optimum output are those operating with "optimum efficiency" (line 2867).
- Full capacity of these generators is released only when the initial output is no longer sufficient.
- When all generators with "optimum efficiency" operate at full output, the generators without "optimum efficiency" are switched on as well.
- In the case of requests forwarded to the generators with "optimum efficiency" only, outputs above this permitted limit will not be released.

Parallel, release last stage

With this sequence of stages, all generators are released with their basic stage first, in accordance with their priorities. Only when all generators with their basic stages are released will the second stages/modulation stages be switched on as well, if required.

The stage/modulation stage released last is the only stage given release of control.

This means:

- Only the output stage switched on last may provide control according to the setpoint and the generator's temperature.

This sequence of stages is used primarily in connection with condensing boilers.

Forced charging [heating only]

<i>Line no.</i>	<i>Operating line</i>
3516	Max sources forced charg
3517	Max source force charg OT

Max sources forced charg

Defines the maximum permissible number of generators used for forced charging. The number of released generators also depend on the attenuated outside temperature (see setting below, line 3517).

Max source force charg OT

Defines the attenuated outside temperature at which the maximum number of generators are released. During forced charging, at least one generator is always released. Additional generators are released in a linear manner, depending on the temperature differential of 15 °C, "Max source force charg OT", and the attenuated outside temperature.

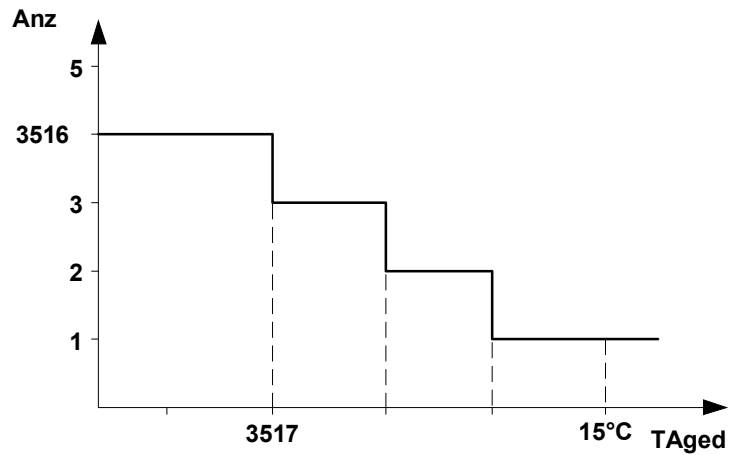

- With setting "Max source force charg OT" = "- - -", dependency on the outside temperature is deactivated, which means that the number of generators selected via parameter "Max source forced charg" are released.
- The number of generators to be released are calculated every time forced charging is started and do not change until forced charging is ended, even if the attenuated outside temperature changes.
- The generators are released at 1-minute intervals.

Coordination defrosting

Line no.	Operating line
3518	Numb source defrost allowed

It must be prevented that all heat pumps involved in a cascade defrost at the same time.

For this reason, the controller only allows a certain proportion of generators ("Numb source defrost allowed") to start defrosting simultaneously – and thus only the respective proportion of heat pumps.



- For that purpose, the heat pumps send defrost requests to the controller and the controller sends defrost delays to the heat pumps.
- The order of the defrost requests received is taken into consideration.
- "Numb source defrost allowed" includes all generators, therefore non-heat pumps as well.

Control
[heating and cooling]

<i>Line no.</i>	<i>Operating line</i>
3522	Rel integr source seq cool
3523	Res integr source seq cool
3525	Switch-on delay cooling
ACS	Neutral zone cooling cascade
3530	Release integral source seq
3531	Reset integral source seq
3533	Switch on delay
ACS	Neutral zone heating cascade

Temperature integrals
generator sequence
(cooling)

Release and reset integral are calculated based on the temperature differential of setpoint and actual value of the common flow.

In the case of cooling via common cooling flow 1, "Common flow sensor B10" is considered, in the case of common cooling flow 2, "Common flow sensor 2 B11".

Rel integr source seq
cool

If the common flow temperature (B10 or B11) exceeds the required flow temperature setpoint by more than half the "Neutral zone cooling cascade" (ACS) and if "Switch-on delay cooling" has elapsed, the release integral is calculated.

If the refrigeration produced drops below the demand by the "Rel integr source seq cool" set here, a second refrigeration generator is switched on.

When the value is increased, additional refrigeration generators are switched on at a slower rate.

When the value is decreased, additional refrigeration generators are switched on at a faster rate.

Res integr source seq
cool

If the common flow temperature (B10 or B11) lies by more than half the "Neutral zone cooling cascade" below the required common flow temperature setpoint, the reset integral is calculated.

If the demand for refrigeration exceeds the "Res integr source seq cool" set here, the refrigeration generator with the lowest priority is switched off.

When the value is increased, refrigeration generators – in the case of excess refrigeration – remain in operation for longer periods of time .

When the value is decreased, refrigeration generators are switched off at a faster rate.

Temperature integrals
generator sequence
(heating)

Release and reset integral are calculated based on the temperature differential of setpoint and actual value of the common flow.

Release integral source
seq

If the cascade flow temperature (B10) drops below its setpoint by the adjustable neutral zone (for explanation see below), the release integral is calculated.



If, in addition to the cascade flow temperature sensor, a cascade return temperature sensor is connected, the temperature acquired by the "warmer" sensor is used.

If the heat produced drops below the demand by the "Release integral source seq" set here, another generator is switched on.

When the value is increased, additional generators are switched on at a slower rate.

When the value is decreased, additional generators are switched on at a faster rate.

Reset integral source seq If the cascade flow temperature (B10) exceeds its setpoint by the adjustable neutral zone (for explanation see below), the reset integral is calculated.



If, in addition to the cascade flow temperature sensor, a cascade return temperature sensor is connected, the temperature acquired by the "warmer" sensor is used.

If the demand for heat exceeds the "Reset integral source seq" set here, the generator with the lowest priority is switched off.

When the value is increased, the generators operate for longer periods of time (in the case of surplus heat).

When the value is decreased, the generators are switched off at a faster rate.

Adjustable neutral zone (heating)

The neutral zone can be adjusted. It is also dependent on the number of generators released. The larger the number of generator stages released, the smaller the neutral zone becomes. The neutral zone is limited to a minimum of 1 Kelvin.

$\text{Neutral zone} = \text{"Neutral zone heating cascade"} \text{ (ACS) minus (stage sequence state/4)}$
--

Neutral zone Example of parameterization (4 K)

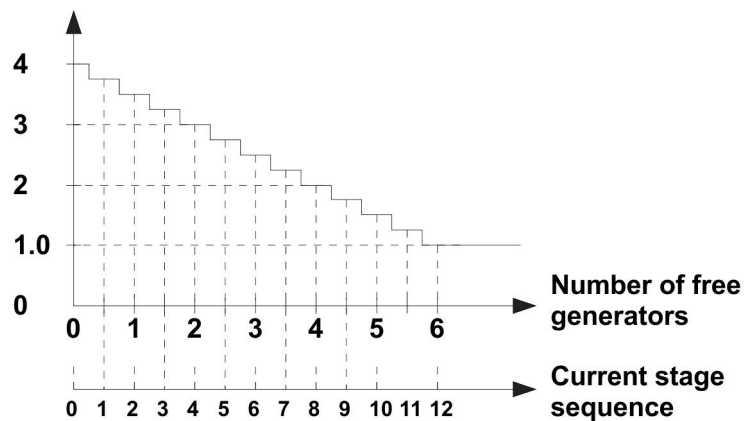

2355Z3522a

Switch on delay/
Switch-on delay cooling

For a heat/refrigeration generator to switch on, "Switch on delay" or "Switch-on delay cooling" must at least have elapsed.

The locking time ensures that the lag generator is allowed enough time to switch on. This prevents too frequent cycling of the generators.



When a DHW request is made, the locking time is a maximum of 1 minute.

**Substitute common
flow temp
[Heating only/cooling
common flow 1]**

<i>Line no.</i>	<i>Operating line</i>
3538	Substitute common flow temp

- With common flow sensor B10:
Whenever a common flow sensor B10 is connected, is used for acquiring the cascade flow temperature.
- Without common flow sensor B10:
If a common flow sensor B10 is not connected, the cascade flow temperature is calculated depending on the setting of parameter "Substitute common flow temp".

None

No backup temperature is used for the cascade flow temperature. If a cascade is installed, the order the cascade operates is calculated solely based on the output balance.

Highest source value

The currently highest generator temperature determines the common flow temperature.

- When a heat request to the cascade is made, the generators considered are only those that currently deliver heat to it.
- When there is no request for heat, all existing generators are considered.

Internal source value

The cascade master's own generator determines the common flow temperature. If this generator is not available or if its temperature sensor is faulty, the common flow temperature is not valid.

Mean source value

The temperature values of the generators currently released are averaged.

The parameterized rated output of the individual generators is considered when averaging the common flow temperature: Generators with great capacity have a greater impact on common flow temperature averaging than generators with small capacity.

If no request to the cascade is made, a common flow temperature backup value is not calculated.

**Generator sequence
[heating and cooling]**

Line no.	Operating line
3540	Auto source seq ch'over
3541	Auto source seq exclusion None First Last First and last
3544	Leading source - - - / 1..16

Absolute priority

If several generators use function "Output optimum" (parameter 2867), they are always the first to change over (regardless of the settings made on operating lines 3540, 3541 and 3544).

Auto source seq ch'over

Function "Auto source seq ch'over" can be used to balance capacity utilization of the generators in a heating/cooling cascade. This is accomplished by defining the order of switching lead and lag generators.

"- - -"

Setting "- - -" defines a **firm** order. The generators are switched in the order of the LPB device addresses.

According to the number of hours run

On completion of the number of hours set, the order of generators within the cascade changes. When changing over, the generator with the next higher device address assumes the function of the lead generator, and the previous lead generator is moved to the end of the generators (or generator group).

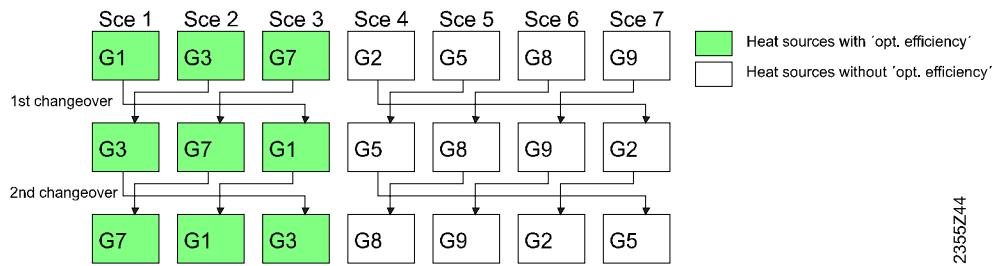

Erz: Heat/refrigeration generator
Gx: Device address

2355Z44

Auto source seq
exclusion

Setting the generator sequence exclusion is only used in connection with the activated generator sequence (line 3540).

With generator exclusion, the first and/or last generator can be exempted from automatic changeover.

None

The order of switching on the generators changes when the number of hours set is reached (line 3540).

First

The first generator in the addressing scheme always remains the lead generator. With the other generators, the order of switching on changes when the set number of hours are reached (line 3540).

Last

The last generator in the addressing scheme always remains the last. The other generators change when the set number of hours are reached (line 3540).

First and last

The first generator in the addressing scheme always remains the lead generator. The last generator in the addressing scheme always remains the last. The generators in between change when the set number of hours are reached (line 3540).

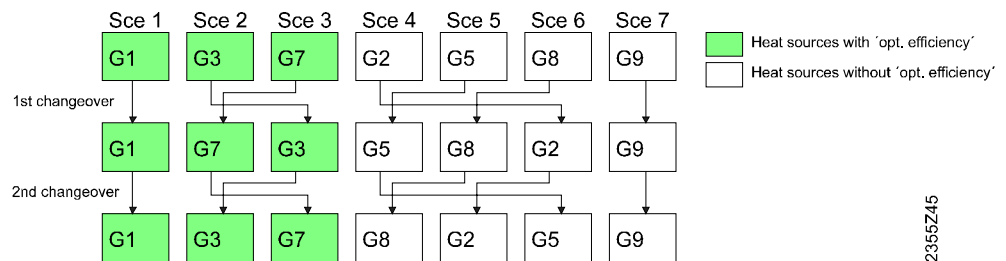

2355Z45

Erz: Heat/refrigeration generator
Gx: Device address

Leading source

Setting of the "Leading source" is only used in connection with the fixed order of generator sequence (line 3540).

The generator defined as the lead generator is always the first to be switched on and the last to be switched off. The other generators are switched in the order of their device addresses.



If generators with "optimum efficiency" are installed, the lead generator must also be able to ensure "optimum efficiency".

Electric immersion heaters in the cascade

Many heat pumps are equipped with electric immersion heaters (K25) installed in the flow (directly after the condenser). The electric immersion heaters can be of the 2- or 3-stage type (K25 and K26).

If all compressor stages of the cascade are released, the electric immersion heater of the heat pump with first priority is released. Electric immersion heaters are released according to the same criteria as heat pumps (release and reset integral).

Refrigeration generator sequence [cooling only]

The following switch-on criteria are predefined for cooling cascades:

- First, all passive generators are released according to their priority.
- If this not sufficient to satisfy the demand, the active generators are released according to their priority.
- The stage/modulation stage released last is the only stage released for control, which means that only this stage is allowed to provide control based on the setpoint and the generator temperature.
- If active stages are enabled, the released passive generators are allowed to switch off passive cooling if their source temperature is too high (source temperature > setpoint + parameter 3004). This ensures that the common flow temperature will not be raised by a source that is too hot.

In addition: With "optimum efficiency"

- The stages are released in a way that the generators first put into operation within their optimum output are those operating with "optimum efficiency" (line 2867).
- Full capacity of these generators is released only when the initial output is no longer sufficient.
- When all generators with "optimum efficiency" operate at full output, the generators without "optimum efficiency" are switched on as well.

Example 1

Generator priority 1 through 3: Active and passive

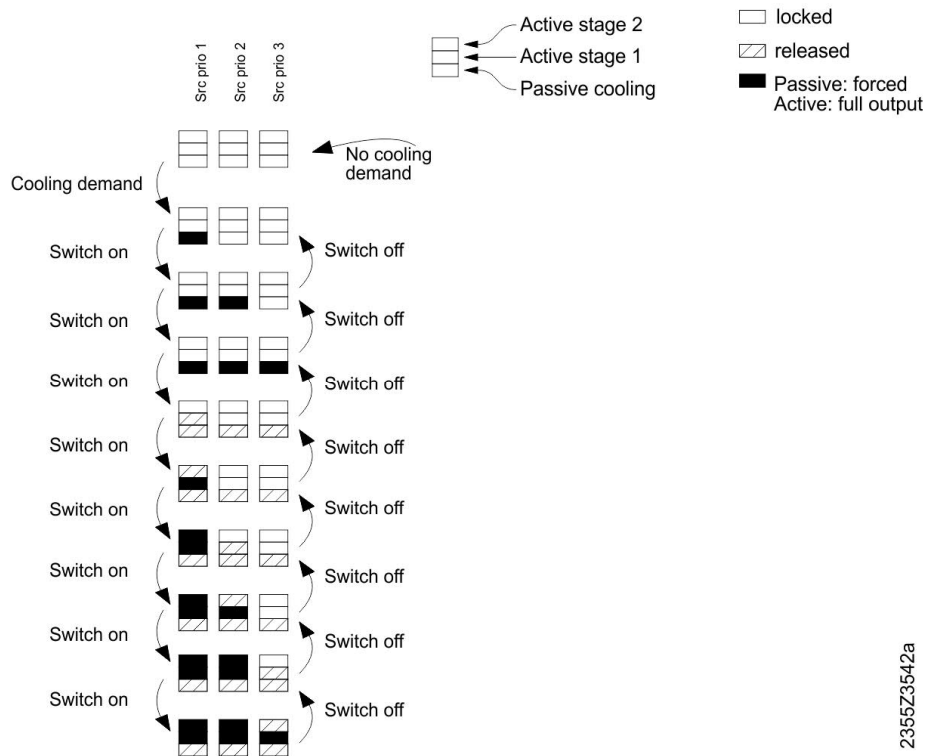

2355Z3542a

Example 2

- Generator priority 1: Active and passive
- Generator priority 2: Active only
- Generator priority 3: Passive only

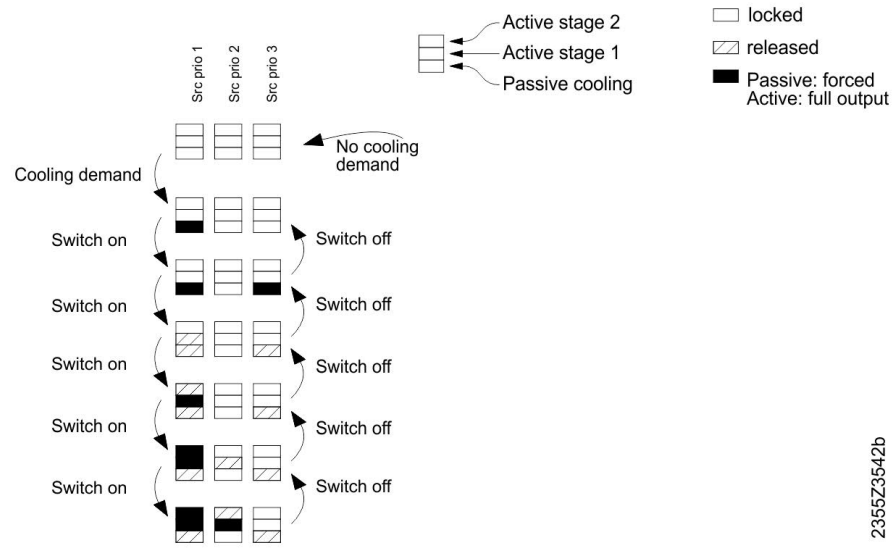

Source seq cooling mirrored
[cooling only]

Line no.	Operating line
3542	Source seq cooling mirrored No Yes

In addition to the fixed, predefined switch-on criteria, there is a special presetting for the generator sequence in connection with cooling cascades: "Source seq cooling mirrored".

The generator sequence is operated in reverse generator order ("Yes").

Mirroring can be practical when simultaneous heating and cooling is implemented (possible only with common cooling flow 2) or when, together with cooling mode, DHW shall be charged via the generator cascade.

When using this parameterization, the resulting generator sequence for cooling is started in the reverse order.



The priority shown on the "Diagnostics cascade" menu is mirrored as well.

Source seq with opt energy
[heating and cooling]

Line no.	Operating line
3543	Source seq with opt energy No Yes

If the cascade contains generators that can be operated with optimum efficiency when a certain output is called for, the generator sequence is subdivided into 2 groups:

1. Generators that can be operated with optimum efficiency.
2. Generators that cannot be operated with optimum efficiency.

- When the generators are released, those of the first group are released first. The generators of the second group are switched on only when all generators of the first group are no longer able to satisfy the demand.
- If a request applies only for the generators with optimum efficiency, the generators of the second group will not be released.
- If the consumers make a request with optimum efficiency to a cascade without generators with optimum output, none of the generators will be released.

If the described functionality is deactivated via parameter "Source seq with opt energy" ("No"), the resulting generator sequence gives no consideration to optimum efficiency of the generators.

Temperature differential
[heating only]

Line no.	Operating line
3590	Temp differential min

This function prevents excessive cascade return temperatures and improves the cascade's switch-off behavior.

If the temperature differential of flow and return sensor (B10 and B70) becomes smaller than the set minimum temperature differential (line 3550), one of the generators is switched off as early as possible, independent of the selected lead strategy.

When the temperature differential returns to the normal level, the selected lead strategy is resumed.

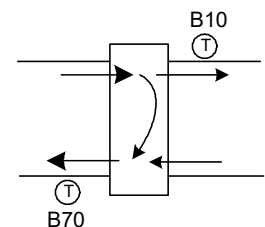

Switching off due to the minimum temperature differential does not apply to the last generator in the cascade.

6.13 Supplementary source (generator)

If the heat pump is complemented by a supplementary generator, 3 choices are available:

1. Supplementary generator in the common flow via relay K27/K32.
2. Supplementary generator (LMS...) with heat pump on the consumer side via BSB.
3. Supplementary generator with heat pump on the consumer side via relay K27/K32.

Hybrid solutions

Applications 2 and 3 are hybrid solutions, that is, the combination of main generator and supplementary generator forms one unit.

In the case of application 2, the supplementary generator is controlled by a boiler management unit LMS... via BSB.

In the case of application 3, the supplementary generator can be freely selected.

Identification of diagram

The controller is capable of identifying the type of application (identification of diagram) based on the following conditions:

Application 1
(supplementary generator)

- Relays K27 and/or K32 are configured.
- Parameter "Use of supplementary source" = supplementary.

Application 2 (LMS)

- A boiler management unit LMS... is connected to the BSB.

Application 3
(hybrid)

- Relays K27 and/or K32 are configured.
- Parameter "Use of supplementary source" = hybrid.

The following table shows the various functions possible with the applications including the parameters to be used for setting the functions:

Function	Application 1 (supplementary generator)	Application 2 (LMS) **	Application 3 (hybrid)
Control Ux heat request	Yes	LMS *	Yes
Control Ux output	Yes	LMS *	No
Feedback from operation Hx	Yes	LMS *	Yes
Setpoint increase main generator	Line 3690	Line 3690	Line 3690
Output limit main generator			
Release with output limit	Line 3691	Line 3691	Line 3691
Lock with output limit	No	SwitchDiffOutLimMainS (ACS)	No
Release of supplementary generator			
In heating mode	Yes	Yes	Yes
With DHW charging	Line 3692 (restrictions)	Line 3692	Line 3692 (restrictions)
OT limits with DHW	Line 3694	Line 3694	Line 3694
Operation limit according to OT	Lines 3700 and 3701	LMS *	Lines 3700 and 3701
Overrun	Line 3705	LMS *	Line 3705
Minimum flow temperature setpoint	Line 3710	LMS	BZ 3710
Control			
Release via K27/K32	Yes	No	Yes
Switch-on and -off integrals	Line 3720	Lines 3718/3719	Line 3720
Switch-off differential	Line 3722	LMS *	Line 3722
Locking time	Line 3723	Line 3723	Line 3723
Control sensor	Line 3725	Flow temperature hybrid source (ACS)	Line 3725
Generator pump	Yes (K27)	Pump hybrid source (ACS)	Yes (K27)
Release of burner	Yes (K32)	LMS *	Yes (K32)
Control of burner	Yes (K32)	LMS *	No

* LMS with "*" means that function is implemented on the LMS... side

** Compatibility/functionality dependent on type/version of LMS... (Type on request)

Line no.	Operating line
ACS	Use of supplementary source Supplementary Hybrid

Use of supplementary source (ACS)

Parameter used to distinguish between application 1 and 3.

Following is a detailed description of the functions used in connection with the applications. The notes in parentheses refer to the validity of the parameters for the applications (1/2/3).

Overview of applications:

Application 1 Supplementary source with relay K27/K32 (setting "Supplementary").
Application 2 Hybrid (LMS via BSB).
Application 3 Hybrid with relay K27/K32 (setting "Hybrid").

Heat request Ux (1/-/3)

One of the outputs Ux can be used to send the supplementary generator a DC 0...10 V signal for the required temperature setpoint.

Output request Ux (1/-/-)

One of the outputs Ux can be used to send the supplementary generator a DC 0...10 V signal for the required output setpoint.

Feedback from operation Hx/EX (1/-/3) Setpoint incr main source (1/-/3)

Feedback from the supplementary generator can be routed to one of the Hx inputs.

Line no.	Operating line
3690	Setpoint incr main source

Setpoint incr main source

For the period of time the supplementary generator is released, the setpoint of the main generator is increased by the value set here, ensuring that it is not switched off or that the degree of modulation is not reduced.



- This prevents the main generator from reducing its output when the supplementary source is in operation.
- When locking the supplementary generator, the setpoint of the main source is continuously shifted again to its own setpoint.

Output limit main generator

Line no.	Operating line
3691	Ouput limit main source
ACS	Switching differential ouput limit main source

Ouput limit main source (1/2/3/)

The supplementary generator is released only when the main generator' output exceeds the level [%] set here. This prevents the supplementary generator from being switched on while the main generator modulates at low output.

The locking time starts only when the main generator's output exceeds the set level [%].

Switching differential ouput limit main source (-/2/-)

In the case of application 2 (LMS), the output of the main generator can also influence the supplementary generator's lock, in addition to the release.

The supplementary generator is locked again when the main generator alone is capable of satisfying the current demand for heat.

The supplementary generator is locked when the main generator's output, after locking, does not exceed the switch-on limit minus the adjustable switching differential.

Output after locking < line – Switching differential ouput limit main source (ACS)

Release supplementary generator

In heating mode (1/2/3)

In heating mode, the supplementary generator is always switched on when there is demand.

If the main generator reports a fault or if it is locked (outside temperature limit, electrical utility lock or manual lock), the supplementary generator is immediately released when there is demand for heat.

Line no.	Operating line
3692	With DHW charging Locked Substitute Complement Instantly First Alone
3694	OT limit with DHW charging
3695	Release with DHW charging According to release With load only With load or heating
3696	Lock with DHW charging With end of charging No heating and B3 hot Sensor B3 hot
3697	With DHW push Off On
3698	With warmer/cooler function Off On

With DHW charging

Defines the release of the supplementary source for DHW charging:

Locked

The supplementary generator will not be released.

Substitute

The supplementary generator is released only if the main generator cannot be put into operation (e.g. in the event of fault).

Complement

The supplementary generator is released if the output of the main generator cannot satisfy the demand.

Instantly

The primary generator and the supplementary generator are always released.

First

The supplementary generator is always on, the heat pump is locked. In the event of fault of the supplementary generator or when in Eco mode, charging is effected by the heat pump.



On Application 1, the setting has the same meaning as the setting "Instantly".

Alone

DHW is always charged by the supplementary generator.

If the supplementary generator locked out, the electric immersion heater in the storage tank (K6) is requested.

During DHW charging, the heat pump is off.

If pump Q9 is used jointly, this pump is requested.



On Application 1, the setting has the same meaning as the setting "Instantly".



For information in Applications 1 to 3 see ACS parameter "Use of supplementary source" prior to line 3690.

OT limit with DHW charging (1/2/3)	<p>Parameter "OT limit with DHW charging" can be used to negate the operating limit for DHW charging according to the outside temperature.</p> <p>If "Ignore" is selected, the supplementary generator put into operation for DHW charging according to parameter setting 3692, although it would be locked because of the outside temperature level.</p>
Release with DHW charging	<p>The parameter "Release with DHW charging" releases the supplementary generator for DHW charging restricted.</p> <p>The parameter is only active if the setting "Complement" was selected on release "with DHW charging" (Line 3692).</p> <p>According to release</p> <p>Release with supplementary generator occurs only after the lockout time and switching integral (no influence on parameter 3692).</p> <p>With load only</p> <p>Release occurs only if the DHW sensor B3 (top) sinks by more than half the switching differential (Line 5024) during DHW charging due to increased consumption.</p> <p>With load or heating</p> <p>Release occurs only if the DHW sensor B3 (top) sinks by more than half the switching differential (Line 5024) or when a heat request is present at the same time as DHW charging.</p> <p>The lock time and the switch-on integral is calculated regardless of this setting. As a result, the supplementary generator is switched on immediately when it recognizes load or heating mode, if the lock time and integral are already fulfilled.</p>
Lock with DHW charging	<p>The supplementary generator can be locked as soon as the DHW sensor B3 is sufficiently warm for any DHW demand. The main generator takes care of the remaining charge, until the DHW sensor B31 is sufficiently warm.</p> <p>With end of charging</p> <p>The supplementary generator remains in operation until the DHW storage tank is fully charged (no influence on parameter 3692).</p> <p>No heating and B3 hot</p> <p>The supplementary generator is locked as soon as the DHW sensor B3 achieves the nominal setpoint to the configured switching differential, if no heating mode is requested at the same time.</p> <p>Sensor B3 hot</p> <p>The supplementary generator is locked as soon as the DHW sensor B3 achieves the nominal setpoint to the configured switching differential, even if heating mode is requested.</p>

With DHW push

The supplementary generator can be released immediately on a DHW push (manual triggering of a DHW charge outside the normal charging time).

Off

The supplementary generator is not released for a manual DHW push (no influence on parameter 3692).

On

The supplementary generator is released immediately for a manual DHW push. The lock out time and switching integral are ignored.

With warmer/cooler function

The supplementary generator can be released immediately for an enabled "warmer" function (pressing the "warmer" button).

Off

The supplementary generator is not released for an enabled "warmer" function. The release occurs as per the lock time and switching integral.

On

The supplementary generator is released immediately for an enabled "warmer" function. The lock time and switching integral are ignored.

Operating limit according to the outside temperature

Line no.	Operating line
3700	Release below outside temp
3701	Release above outside temp

Release below outside temp /above outside temperature (1/-/3)

Operation of the supplementary source is released only when the composite outside temperature lies above or below the set temperature limit.

This enables the supplementary generator to lock in a selected outside temperature range to ensure bivalent operation of supplementary generator and heat pump. Also refer to operating lines 2909 and 2910.



- To ensure continuous release of the supplementary source, setting "---" must be selected on the respective operating lines.
- If both release values are enabled, the outside temperature must satisfy both criteria for the supplementary generator to be released .



The function is also ensured with application 2 (LMS). The application limits are to be parameterized on the LMS...

Release for generation lock

Line no.	Operating line
3704	With heat generation lock Off On DHW On

Off

The supplementary source is locked.

On DHW

The supplementary source is enabled for DHW charging.



The heating circuits are locked if the supplementary generator is released during an active generation lock or switched on Eco mode for DHW charging.

On

The supplementary source is enabled for all heat requests.

Overrun time

Line no.	Operating line
3705	Overrun time

Overrun time (1/-/3)

Release relay K27 is deenergized at the earliest when the set overrun time has elapsed.

If the common flow temperature drops below its setpoint before the overrun time has elapsed, release relay K27 remains energized.

If the set overrun time elapses before the common flow temperature drops below its setpoint, release relay K27 is deenergized.

Overrun (-/2/-)

Overrun of the boiler pump is ensured by the LMS...

In addition, using a forced signal, the LMS... makes certain that the consumer pump or the DHW diverting valve also perform their overrun.



If a common hybrid pump is configured, that pump performs its overrun also.

Setpoints

Line no.	Operating line
3710	Setpoint min *
3711	Setpoint max
3712	Setpoint chimney sweep

* Active only if a control sensor is used

Setpoint min (1/-/3)

If the supplementary generator is released (relay K27 energized), that generator's setpoint is raised to the "Setpoint min" adjusted here.

During overrun, "Setpoint min" acts as the minimum switch-on temperature.

Setpoint max

Defines the flow setpoint maximum for the supplementary generator.

If a temperature sensor is available for the supplementary generator, (B10, B4, or common flow backup value), the supplementary generator is switched off as soon as the temperature sensor exceeds the flow setpoint maximum value.

The switching integral must be fulfilled to switch on again.

The lock time need not expire again.

In the event an output signal 0-10V is configured for the request to the supplementary generator, the output value is also limited by the flow setpoint maximum.

Setpoint chimney sweep

The common flow temperature setpoint determines the value outputted over output Ux when the chimney sweep function is enabled (Line 7130).

The value is only exported if the supplementary generator is controlled using the Ux output.

Flow temperature control

Release via K27/K32
(1/-/3)

The 2 relays K27 and K32 operate as simple release control when the switching integral and the switch-on differential are deactivated or when the selected control sensor is not installed.

Line no.	Operating line
3718	Release integral
3719	Reset integral
3720	Switching integral *
ACS	Neutral zone switching integral
3722	Switching diff off *
3723	Locking time
3725	Control sensor Common flow temp Buffer sensor B4
ACS	Flow temperature hybrid source Max value flow temp HP/boiler temp Mean value flow temp HP/boiler temp Flow temp heat pump Boiler temp

* Active only if a control sensor is used

Release integral/
Reset integral (-/2/-)

In the case of application 2 (LMS), specific parameters (lines 3718 and 3719) are available for both the switch-on and the switch-off integral.



When an LMS... is used to control a gas boiler, a switch-on and switch-off differential can be parameterized for the basic stage. These switching differentials for space and DHW heating can be parameterized separately.

Switching integral (1/-/3)

The temperature-time integral is a continuous summation of the temperature differential over time. In this case, the decisive criterion is the difference by which the temperature lies above or below the common flow temperature setpoint.

The temperature-time integral gives consideration not only to the period of time, but also to the extent of over-/undershoot. This means that when the crossing is significant, the supplementary source is released earlier, or locked earlier, than with minor crossings.

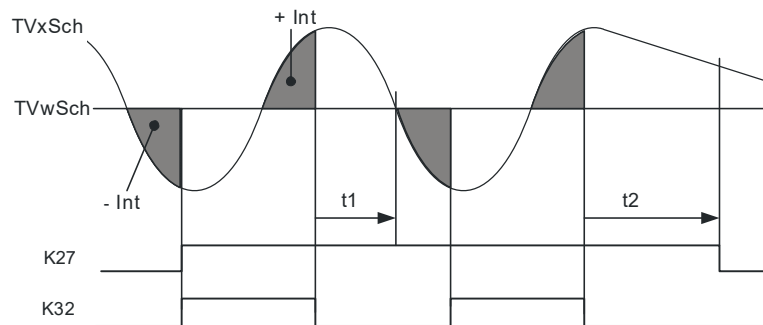

TVx Actual value of flow temperature
 TVw Flow temperature setpoint
 + Int Surplus integral
 - Int Deficit integral
 t1 Overrun time (not fully completed)
 t2 Overrun time (fully completed)
 K27 Release output K27
 K32 Control K32



Integration re-starts for a change of setpoint.

The release/switching integral is restarted (the locking time does not restart) if the supplementary generator is not yet released and the temperature request to the generator changes by more than 2 K.

The reset/switching integral also restarts if the supplementary generator is already running and the temperature request changes by more than 2 K.

Neutral zone switching integral (ACS)

A neutral zone can be configured for the supplementary generator switching integral. Half neutral zone is above the common flow setpoint; the other half, below. No integration takes place if the common flow actual value is within this neutral zone.

Integration occurs as soon as the actual value exits the neutral zone. The entire control deviation (actual value minus setpoint) is considered for the integration.

The configured locking time (line 3723) must expire for the integral calculation to begin.

Switching diff off (1/-/3)

If the common flow temperature exceeds the flow temperature setpoint by the amount of the switch-off differential, switching off takes place immediately, independent of the switching integral of the supplementary source (K32), and the request for heat (K27) is aborted on completion of the overrun time.

Locking time (1/2/3)

The locking time enables the heat pump to reach a stable operating state before the supplementary source is allowed to switch on.

The supplementary generator is released only when the locking time has elapsed. The locking time starts as soon as a valid flow temperature setpoint is available. Calculation of the release integral starts only when the locking time has elapsed.

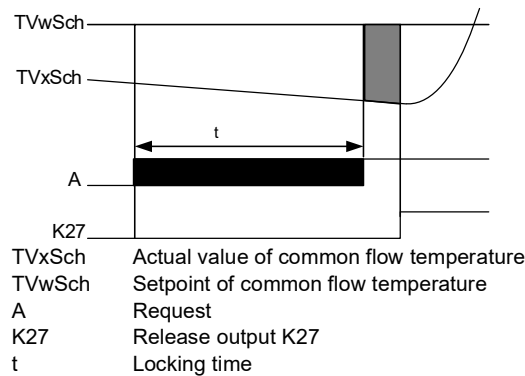

No consideration is given to the locking time, if the heat pump malfunctions or is locked, or if the supplementary generator must end DHW charging. Setting "- -" can be used to deactivate the function.

Control sensor (1/-/3)

Control of the supplementary generator is effected based on the temperature acquired by the sensor defined here.

- Common flow temp B10
- Buffer sensor B4

Control sensor (-/2/-)

To produce the generator temperature, the heat pump's generator sensor and/or that of the LMS... can be used.

The selection is made via parameter "Flow temperature hybrid source" (ACS):

Max value flow temp HP/boiler temp

The generator temperature used is the higher temperature value of the 2 generators.

Mean value flow temp HP/boiler temp

The generator temperature used is the mean temperature value of the 2 generators.

Flow temp heat pump

The sensor value of the heat pump is used.

Boiler temp

The sensor value of the LMS... is used.



For generation of the maximum and mean value, 2 exceptions are to be considered:

- The LMS... operates in instantaneous water heater mode and, at the same time, the heat pump is in heating mode (line 3692 ≠ Alone).
- The LMS... receives a request for separate DHW circuit and, at the same time, the heat pump is in heating mode (line 3692 = Alone).

In both cases, the generator temperature equals the sensor value of the heat pump.

Line no.	Operating line
ACS	Pump hybrid source Separately Boiler pump Q1 Condenser pump Q9

Pump hybrid source (-/2/-) LMS.. and heat pump may have their own pump or a common pump.

"Pump hybrid source" (ACS) is used to configure if both have their own pump ("Separately"), or if there is only a boiler pump ("Boiler pump Q1") or only a condenser pump ("Condenser pump Q9").

- If a condenser pump is configured, the LMS... is put into operation only when the condenser pump runs.
- If a boiler pump is configured, the heat pump is put into operation only when the boiler pump runs.

Source type (1/-/3)

Line no.	Operating line
3750	Source type Other Solid fuel boiler Heat pump Oil/gas boiler

Defines the type of producer of the supplementary source.
Hence, operating units supporting this function can display the type of supplementary source currently in operation.

Delay lockout position (1/-/3)

Line no.	Operating line
3755	Delay lockout position

If an Hx input is configured as "Status info suppl source" and a delay time is set via parameter "Delay lockout position", following applies:

- After switching on, output "Supplementary source" (K32) must send status information to the respective Hx input within the delay time set here.
- If missing, the controller signals "Fault".



- If no output (relay) "Supplementary source" (K32) is configured, "Delay lockout position" starts from the release (K27).
- Should a fault occur, the controller deactivates the release (K27), but keeps output (relay) "Supplementary source" (K32) activated.
- If no supplementary source (K32) is configured, the controller also maintains the release (K27).
- The "Lockout position" function can be deactivated by switching off the delay time.

6.14 Solar

Summary

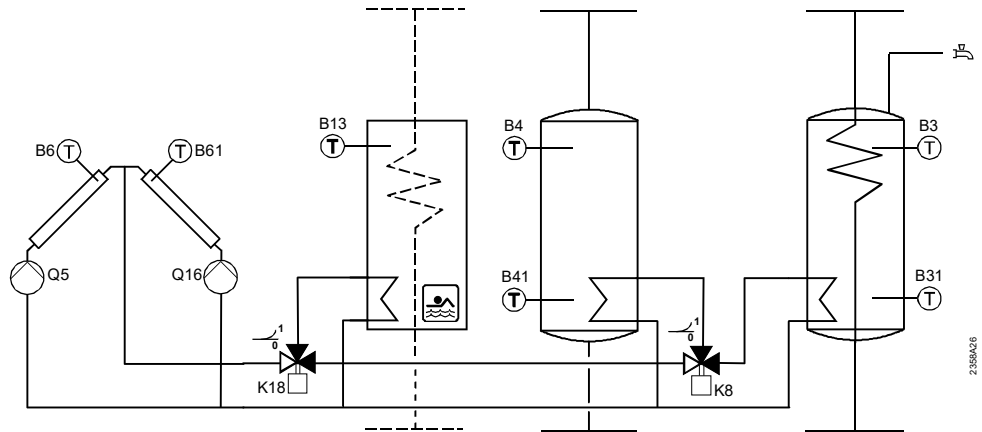

If sufficient solar energy is available, the solar plant can charge the DHW storage tank and the buffer storage tank and heat the swimming pool.

Priorities for charging the individual storage tanks can be selected. The pumps can be speed-controlled. Protection for the plant is ensured by a "Frost protection" and an "Overtemperature protection" function.

Charging controller (dT)

Line no.	Operating line
3810	Temp diff on
3811	Temp diff off
3812	Charg temp min DHW st tank
3813	Temp diff on buffer
3814	Temp diff off buffer
3815	Charging temp min buffer
3816	Temp diff on swi pool
3817	Temp diff off swi pool
3818	Charging temp min swi pool

To charge the DHW storage tank/buffer/swimming pool via the heat exchanger, a sufficiently large temperature differential between collector and DHW storage tank/buffer/swimming pool is required.

Also, the collector temperature must lie above the "Minimum charging temperature" for the DHW storage tank/buffer/swimming pool.



When using setting "- - -" for lines 3813, 3814 and 3816, 3817, the values of lines 3810 and 3811 are adopted.

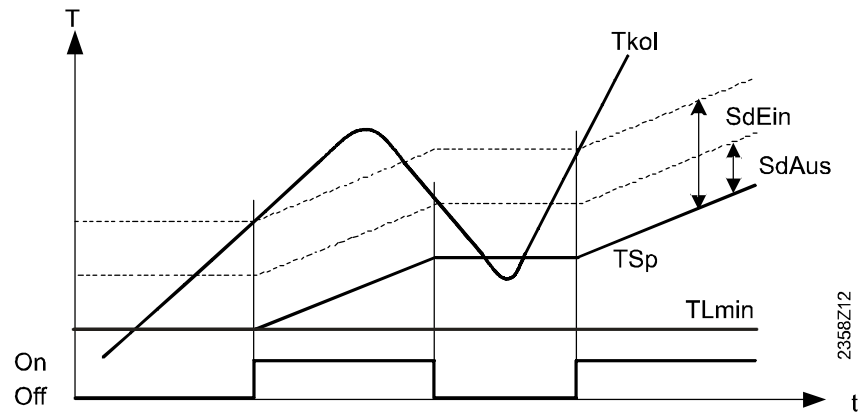

Tkol Collector temperature
 SdEin Temperature differential On (DHW storage tank/buffer/swimming pool)
 SdAus Temperature differential Off (DHW storage tank/buffer/swimming pool)
 TSp Storage tank temperature (DHW storage tank/buffer/swimming pool)
 TLmin Minimum charging temperature (DHW storage tank/buffer/swimming pool)
 On/Off Collector pump

Priority

Line no.	Operating line
3822	Charging prio storage tank None DHW storage tank Buffer storage tank
3825	Charging time relative prio
3826	Waiting time relative prio
3827	Waiting time parallel op
3828	Delay secondary pump

The priority circuit for the swimming pool ("Charging priority solar", line 2065) can influence the storage tank priority of solar charging and heat the swimming pool before charging the storage tanks.

Charging prio storage tank

If a plant uses several heat exchangers, it is possible to set a priority for the integrated storage tanks, which defines the charging sequence.

None

The storage tanks are charged alternately for a temperature increase of 5 Kelvin at a time, until every setpoint reaches the level of A, B or C (see below). The setpoints of the next higher level are approached only after all setpoints of the previous level have been reached.

DHW storage tank

During solar charging, preference is given to the DHW storage tank. At every level A, B or C (see table below), charging is effected with priority. Only then will the other consumers of the same level be charged (see table below).

When all setpoints of a level are reached, those of the next level are approached and here too, the DHW storage tank has priority.

Buffer storage tank

During solar charging, preference is given to the buffer storage tank. At every level A, B or C (see table below), charging is effected with priority. Only then will the other consumers of the same level be charged.

When all setpoints of a level are reached, those of the next level are approached and here too, the buffer storage tank has priority.

Storage tank setpoints

Level	DHW storage tank	Buffer storage tank	Swimming pool
A	Line 1610	Buffer setpoint (slave pointer)	Line 2055
B	Line 5050	Line 4750	Line 2055
C	Line 5051	Line 4751	Line 2070

* When priority for the swimming pool is activated ("Charging priority solar", line 2065), the swimming pool is heated before the storage tanks are charged

1610: Nominal setpoint
 5050: Charging temp max
 5051: Storage tank temp max
 4750: Charging temp max
 4751: Storage tank temp max
 2055: Setpoint solar heating
 2070: Swimming pool temp max

Charging time relative prio

If, for some reason, the preferred storage tank cannot be charged in accordance with charging control, priority is transferred to the next storage tank or the swimming pool for the period of time set (e.g. because the temperature differential of collector and storage tank is too great).

As soon as the preferred storage tank (according to setting "Charging prio storage tank") is again ready to be charged, the transfer of priority is immediately aborted.

If the parameter is disabled ("- -"), priority always follows the settings for "Charging prio storage tank".

Waiting time relative prio

During the period of time set, the transfer of priority is delayed. This prevents relative priority from intervening too frequently.

Waiting time parallel op

If solar output is sufficient and solar charging pumps are used, simultaneous operation is possible. In that case, the storage tank of the priority model can be the next to be charged at the same time, in addition to the storage tank to be charged next. Simultaneous operation can be delayed by a waiting time. This way, in the case of simultaneous operation, switching on of the storage tanks can be effected in steps.

Setting "- -" deactivates simultaneous operation.

Delay secondary pump

To remove cold water from the primary circuit, operation of the secondary pump of the external heat exchanger can be delayed.

"Start" function

Line no.	Operating line
3830	Collector start function
3831	Min run time collector pump
3832	Collector start function on
3833	Collector start function off
3834	Collector start funct grad
3835	Min collector temp start fct

Collector start function

If the collector temperature cannot be accurately acquired during the time the pump is deactivated (especially in the case of vacuum tubes), the pump can be switched on from time to time. This setting defines the interval at which the collector pump is put into operation. Then, it always runs for the time set "Min run time collector pump" (line 3831).

Min run time collector pump

The function activates periodically the collector pump for at least the set minimum running time.

Collector start function on

Defines the time of day from which the collector start function is enabled.

- Collector start function off Defines the time of day from which the collector start function is deactivated (e.g. during the night).
- Collector start funct grad If the temperature increase at the collector sensor exceeds the set "Collector start funct grad", the collector pump is activated.
- Min collector temp start fct The collector pump may be activated only if the temperature acquired by the collector sensor reaches at least the level set here.

Collector frost protection

Line no.	Operating line
3840	Collector frost protection

If there is risk of frost at the collector, the collector pump is put into operation to prevent the heat transfer medium from freezing.

- If the collector temperature falls below the frost protection level, the collector pump is activated
- When the collector temperature returns to a level 1 Kelvin above frost protection, the collector pump is deactivated again

Collector overtemperature protection

Line no.	Operating line
3850	Collector overtemp prot

If there is a risk of overtemperature at the collector, storage tank charging is continued to reduce the amount of surplus heat. Charging is aborted when the storage tank reaches its safety temperature.

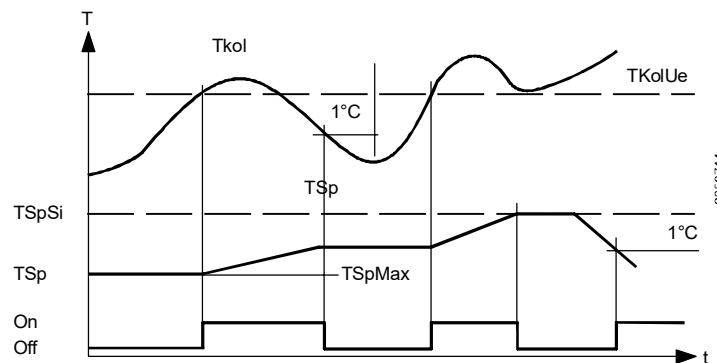

- TSpSi Storage tank safety temperature
- TSp Storage tank temperature
- TKolUe Collector temperature for overtemperature protection
- TSpmax Maximum charging temperature
- Tkol Collector temperature
- On/Off Collector pump
- T Temperature
- t Time

Supervision of evaporation

Line no.	Operating line
3860	Evaporation heat carrier
3862	Impact evaporation superv On own collector pump On both collector pumps

- Evaporation heat carrier If there is a risk of evaporation of the heat transfer medium due to high collector temperatures, the collector pump is deactivated to prevent it from overheating. This is a "Pump protection" function.
- Impact evaporation superv In the case of collector fields equipped with 2 collector pumps, it can be selected if only the pump of the collector circuit with risk of evaporation or if both pumps shall be deactivated.

Speed control

<i>Line no.</i>	<i>Operating line</i>
3870	Pump speed min
3871	Pump speed max

Pump speed
min /max

The speed range of the solar pump is limited by a permissible minimum and maximum speed.

Speed control

<i>Line no.</i>	<i>Operating line</i>
3872	Speed Xp
3873	Speed Tn

- For speed control, the charging setpoint for the storage tank with the first charging priority and the collector temperature are used. A PI controller calculates the speed required to ensure that the collector temperature lies 2 Kelvin below the switch-on temperature
- If the collector temperature rises due to increased solar irradiance, the speed is raised. If the collector temperature drops below this setpoint, the speed is reduced. Parameters can be set to define a minimum and maximum pump speed
- The resulting speed is delivered via the speed output selected during configuration
- If the charging priority is changed, the controller regulates the speed according to the new charging setpoint

Parameters Xp and Tn

By setting the right proportional band Xp and integral action time Tn, the control action can be matched to the type of plant (controlled system).

Xp and Tn can be determined using common methods, e.g. the step response method depicted in Section "Xp, Tn, Tv – Step response method".

Brochure BT_0098_EN provides additional notes on control technology in buildings.

Yield measurement

<i>Line no.</i>	<i>Operating line</i>
3880	Antifreeze
3881	Antifreeze concentration
3884	Pump capacity

To ensure accurate solar yield measurement, both additional sensors (B63 in the solar flow and B64 in the solar return) should be connected. If one or both sensors is/are missing, the controller uses collector sensor B6 or B61 and the respective storage tank sensor B31 or B41 to make the calculation.

More accurate measurements are made with B63/B64. The 24-hour and total solar energy yield (lines 8526 and 8527) are calculated based on these data.

Antifreeze

Since the mixing ratio of the collector medium has an impact on heat transfer, the type of antifreeze agent used and its concentration must be entered to be able to determine the energy yield.

Pump capacity

When establishing the yield without external pulse count or flow measurement, the flow (in liters per hour) must be determined according to the pump used and serves for calculating the volume input.



If the flow is metered via an input Hx, this setting must be deactivated.

Yield measurement pulse

Line no.	Operating line
3886	Pulse count yield None With input H1 With input H21 module 1 With input H21 module 2 With input H21 module 3 With input H22 module 1 With input H22 module 2 With input H22 module 3 With input H3

Pulse count yield

Parameter "Pulse count yield" is used to select input Hx for metering the amount of heat or the flow of water:

None

No metering via input Hx. This setting is important if the inputs are used for other pulse counts (e.g. acquisition of energy input).

With input Hx

The pulse counter is read by the selected input and the energy determined from it is added to the reading of the meter used for metering the heat delivered.



It is important that the count input selected here is set in the configuration for the pulse count as well.

Pulse measurement

Line no.	Operating line
3887	Pulse unit yield None kWh Liter
3888	Pulse value yield numer
3889	Pulse value yield denom

Every pulse received can be interpreted as a value (kWh or liters).

The pulse value is defined on operating lines 3887...3889 (unit, numerator and denominator).

Examples

$$1 \text{ pulse value corresponds to } \frac{\text{Numerator}}{\text{Denominator}} * \text{Unit} = \frac{\text{Line 3888}}{\text{Line 3889}} * \text{Line 3887}$$

In other words, for example $\frac{1}{10} * kWh$ or $\frac{11}{2} * liters$



- The pulses are counted by input Hx selected via operating line 3886
- The sum of the counted pulses is displayed by the respective pulse counter (lines 7842, 7856, 7987, 7992 and 7997)

Pulse unit yield

None

The pulse value will not be counted.

kWh

The pulse value is interpreted as kWh and added to "24-hour yield solar energy" (line 8526).

Liter

The pulse value is counted as liters. The yield in kWh is determined based on the flow and the temperature differential of collector flow and return and then added to "24-hour yield solar energy" (line 8526).

Flow measurement yield

<i>Line no.</i>	<i>Operating line</i>
3891	Flow measurement yield None With input H1 With input H2 module 1 With input H2 module 2 With input H2 module 3 With input H21 module 1 With input H21 module 2 With input H21 module 3 With input H22 module 1 With input H22 module 2 With input H22 module 3 With input H3

In place of using the pulse count, the flow can also be measured with a flow sensor (10 V or Hz) connected to input Hx.

Flow measurement yield

Parameter "Flow measurement yield" is used to select input Hx used for making the flow measurement:

None

No measurement via input Hx. This setting is important if the inputs are used for making other flow measurements (e.g. heat pump).

With input Hx

The flow via the selected input is acquired and used for calculating the volume. The determined volume is multiplied by the measured temperature differential and added to "24-hour yield solar energy" (line 8526).



The Hx input selected here must be set in the configuration for the flow measurement.

Sensor calibration

<i>Line no.</i>	<i>Operating line</i>
3896	Readj solar flow sensor
3897	Readj solar return sensor

By making sensor readjustments, inaccuracies of the sensor's measured values can be compensated for.

6.15 Solid fuel boiler

Summary

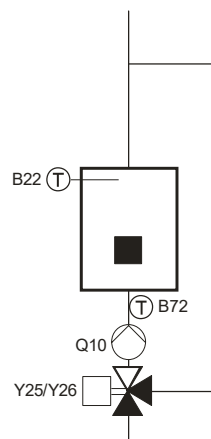

When the temperature of the solid fuel boiler is high enough, the boiler pump is activated and the DHW storage tank and/or the buffer storage tank are charged.

The solid fuel boiler operates as follows:

- Only with boiler sensor B22, or
- With boiler sensor B22 and return sensor B72

Operating mode

Line no.	Operating line
4102	Locks other heat sources
4103	Charg prio DHW stor tank Off On

Locks other heat sources

When the solid fuel boiler is heated up, other heat sources, such as oil/gas boilers, are locked.

Locking takes place as soon as an increase of the boiler temperature is detected.

This predictive function allows locked heat sources to end any overrun of pumps before the solid fuel boiler pump is activated.

Also, in the case of a common flueway, it can be made certain that only one boiler is in operation at a time.

Charg prio DHW stor tank

When the solid fuel boiler is in operation, the DHW storage tank can be charged with priority (on) against the other consumers.

When selecting "Off", normal DHW charging priority applies (line 1630).

Setpoints

Line no.	Operating line
4110	Setpoint min
4114	Temp differential min
4130	Temp diff on

Setpoint min

The boiler pump is put into operation when the boiler temperature reaches its minimum level plus "Temp diff on".

If the boiler temperature falls below its minimum level, the boiler pump is deactivated again when pump overrun is ended.

Temp differential min

If the temperature increase (differential of boiler flow and boiler return temperature) is too small, the boiler pump is deactivated when pump overrun is ended.

If a return sensor is not installed, the boiler temperature increase is calculated from the boiler temperature and the minimum return temperature setpoint (e.g. when using a thermal return temperature controller).

Temp diff on

Refer to description of "Setpoint min".

DHW charging

Line no.	Operating line
4134	Connection DHW stor tank None With B3 With B31 With B3 and B31
4135	Boiler temp setp DHW charg Storage tank temp Storage tank setpoint Boiler temp setpoint min
4136	DHW charging with Q3 No Yes

Connection DHW stor tank
Boiler temp setp DHW charg

When using a solid fuel boiler, the sensors must be selected.

This setting is used to select the required calculation of the boiler temperature setpoint during DHW charging.

Storage tank temp

The boiler temperature setpoint is calculated based on the DHW "Flow setpoint boost" (line 5020) and the current DHW storage tank temperature (according to line 4134).

Storage tank setpoint

The boiler temperature setpoint is calculated based on the DHW flow setpoint boost (line 5020) and the setpoint of the DHW storage tank (nominal or legionella setpoint).

Boiler temp setpoint min

The boiler temperature setpoint corresponds to the minimum setpoint.

DHW charging with Q3

Determines whether charging pump Q3 is used by the solid fuel boiler for DHW heating.

No

The solid fuel boiler charges the DHW storage tank directly via boiler pump Q10. Charging pump Q3 is not controlled by the solid fuel boiler.

Yes

For DHW charging with the solid fuel boiler, charging pump Q3 must run.

Charging of buffer storage tank

Line no.	Operating line
4137	Connection buffer With B4 With B42/B41 With B4 and B42/B41
4138	Boil temp setp buffer charg Storage tank temp Storage tank setpoint Boiler temp setpoint min

Connection buffer

When integrating a solid fuel boiler, the sensors must be selected.

Boil temp setp buffer charg

This setting is used to select the required calculation of the boiler temperature setpoint during buffer storage tank charging.

Storage tank temp

The boiler temperature setpoint corresponds to the current storage tank temperature (according to line 4137).

Storage tank setpoint

The boiler temperature setpoint corresponds to the setpoint of the buffer storage tank (slave pointer).

Boiler temp setpoint min

The boiler pump remains in operation as long as the boiler temperature lies above the minimum setpoint.

Pump overrun

<i>Line no.</i>	<i>Operating line</i>
4140	Pump overrun time

Pump overrun time

If the temperature of the solid fuel boiler drops below the minimum temperature differential or the minimum setpoint, the boiler pump keeps running for the parameterized overrun time.

Overtemperature protection

<i>Line no.</i>	<i>Operating line</i>
4141	Excess heat discharge

Excess heat discharge

If the boiler temperature reaches the set maximum value, excess heat discharge is activated. This forces the connected consumers to draw heat from the solid fuel boiler. At the same time, the boiler pump is activated.

Limitation of return temperature

<i>Line no.</i>	<i>Operating line</i>
4153	Return setpoint min
4158	Flow influence return ctrl Off On

Return setpoint min

The controller prevents the return temperature from falling below the level set here by adding hot flow water.

Flow influence return ctrl

If desired, the return temperature controller can help reach the flow temperature setpoint. Influence of the flow on the control of the return temperature can be switched on or off.

NOTE

For both functions (4153 and 4158), a return sensor B72 must be connected.

Maintained boiler return temperature

<i>Line no.</i>	<i>Operating line</i>
4163	Actuator running time
4164	Mixing valve Xp
4165	Mixing valve Tn

Actuator running time

Setting the running time for the actuator used with the mixing valve.

Parameters Xp and Tn

By setting the right proportional band Xp and integral action time Tn, the control action can be matched to the type of plant (controlled system).

Xp and Tn can be determined using common methods, e.g. the step response method depicted in Section "Xp, Tn, Tv – Step response method".

Brochure BT_0098_EN provides additional notes on control technology in buildings.

Frost protection

Line no.	Operating line
4170	Frost prot plant boiler pump

The solid fuel boiler pump is activated depending on the current outside temperature, even if there is no request for heat.

CAUTION	"Frost prot plant boiler pump" works only if "Frost protection plant" (line 6120) is activated.
----------------	---

Below, the overriding settings resulting from "Frost protection plant" (line 6120) are summarized:

Outside temperature	Pump	Diagram
$\leq -4 \text{ °C}$	Continuously on	ON
$-5 \dots 1.5 \text{ °C}$	10 minutes on at an interval of about 6 hours	takt (cycle)
$\geq 1.5 \text{ °C}$	Continuously off	OFF

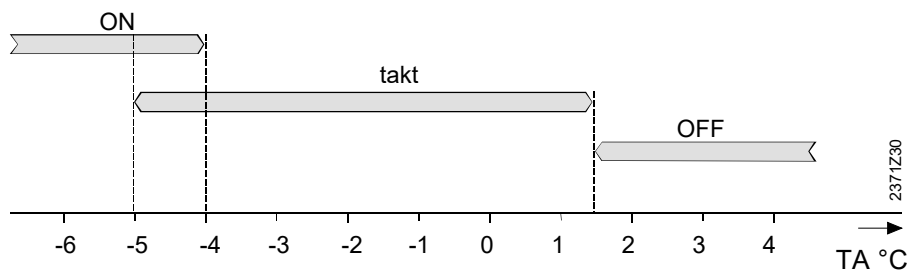

"Residual heat" function

Line no.	Operating line
4190	Residual heat fct dur max
4192	Residual heat fct trigg Once Several times

Overrun of the boiler pump ensures that the boiler circuit's residual heat is dissipated. This makes certain that overtemperatures will not occur, preventing the safety limit thermostat from tripping.

Residual heat fct dur max The "Residual heat" function is aborted after the set maximum time at the latest.

Residual heat fct trigg The "Residual heat" function can be performed once or, if required, several times.

Once

When ended, the "Residual heat" function remains deactivated.

Several times

The "Residual heat" function is resumed when the switch-on criteria are fulfilled.

<i>Line no.</i>	<i>Operating line</i>
4201	Pump speed min
4203	Pump speed max

Using these settings, minimum and maximum limitation of the pump speed is provided.

<i>Line no.</i>	<i>Operating line</i>
4203	Speed Xp
4204	Speed Tn

The speed of the solid fuel boiler pump can be controlled.

Parameters Xp and Tn

By setting the right proportional band Xp and integral action time Tn, the control action can be matched to the type of plant (controlled system).

Xp and Tn can be determined using common methods, e.g. the step response method depicted in Section "Xp, Tn, Tv – Step response method".

Brochure BT_0098_EN provides additional notes on control technology in buildings.

6.16 Buffer storage tank

Summary

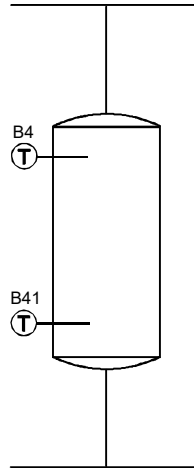

A buffer storage tank can be integrated in the plant. It can be charged via the heat pump, by solar energy or by an electric immersion heater.

In the case of active cooling, it can also be used for storing cooling energy.

The controller controls heating / cooling and forced charging of the buffer storage tank, protects it against overtemperatures and maintains stratification whenever possible.

Forced charging

Line no.	Operating line
4705	Forced charging
4706	Charging prio photovoltaics None Priority 1 Priority 2 Priority 3
4708	Forced charging setp cooling
4709	Forced charg setp heat min
4710	Forced charg setp heat max
4711	Forced charging time
4712	Forced charg duration max

To benefit from low electricity tariffs, forced charging of the buffer storage tank usually can be triggered. As a result, operation of the heat pump is maintained until the required setpoint for forced buffer storage tank charging is reached, or until forced charging is no longer released.

Off

Forced charging of the buffer storage tank is not possible.

Demand

In summer operation, or when all heating circuits are in Protection mode, forced charging is locked.

Always

Forced charging of the buffer storage tank is always possible.



- When the plant operates in cooling mode, "Forced charging setp cooling" is used.
- In heating mode, the slave pointer is used as the setpoint. It can be limited via operating lines "Forced charg setp heat min" and "Forced charg setp heat max".
- If forced charging is triggered by smart grid state "Draw forced", "Charging temp max" (line 4750) is used as the setpoint.

Forced charging can be triggered either via low-tariff input E5 (one of the Ex inputs) or "Forced charging time" (line 4711).

 Smart grid states "Draw wish" and "Draw forced" are considered like low-tariff.

If forced charging is stopped because the heat pump had to be switched off, it will be resumed as soon as the buffer storage tank temperature drops by 5 Kelvin (heating) or rises by 5 Kelvin (cooling). At this point in time, forced charging must still be released, and the number of permissible charging abortions must not be exceeded (line 2893). Otherwise, the controller waits until forced charging is regularly triggered the next time.

 In summer operation, or when all heating circuits are in protection mode, forced charging is locked.

Charging prio
photovoltaics

A photovoltaics plant can operate the heat pump via the EX input E64 (Line 5980...) and charge the storage tank using the generated thermal energy. The storage tank charging sequence is per the set priorities. Priorities can be set for the following storage tanks:

- Swimming pool, line 2066
- Buffer storage tank, line 4706
- DHW storage tank, line 5018

None

No buffer storage tank charging.

Priority 1

Buffer storage tank charging is priority 1.

Priority 2

The buffer storage tank charging is priority 2 (after DHW storage tank, prior to swimming pool, or after swimming pool, prior to DHW storage tank).

Priority 3

Buffer storage tank charging has the lowest priority (after DHW storage tank and swimming pool).

 Charging occurs as per the predefined sequence if storage tanks are set at the same priorities: DHW storage tank, buffer storage tank, swimming pool.

Forced charging
setp cooling

Forced charging of the buffer storage tank is completed when "Forced charging setp cooling" (4708) is reached. When using setting "---", forced charging for cooling is deactivated. For forced charging to start, the storage tank temperature at the bottom must lie at least 2 Kelvin above the adjusted setpoint. If there is no sensor at the bottom, the storage tank sensor at the top is used.

Forced charge setp heat min/Forced charge setp heat max

The slave pointer used as setpoint with forced charging heating can be limited at a minimum and a maximum.

The slave pointer collects the maximum values of the temperature requests from the heating circuit and stores them. Every midnight, the slave pointer setpoint is reduced by 10%.

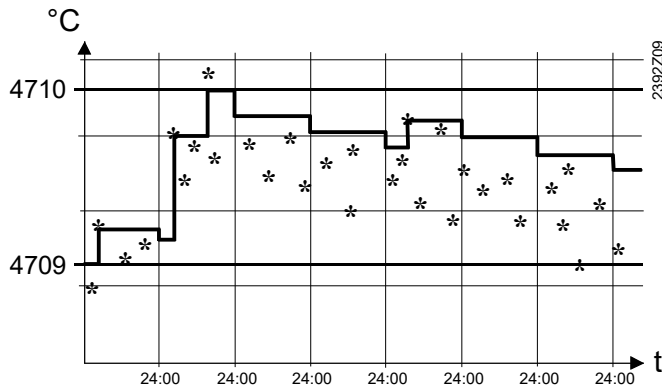

* = individual temperature requests
 4709 Forced charge setp heat min
 4710 Forced charge setp heat max

Forced charging time

Forced charging starts every day at the time of day set here (00:00...24:00). Setting "- - -", deactivates forced charging.

Forced charge duration max

Forced charging is aborted when the required setpoint has not been reached on completion of the period of time set here.

Automatic locks

If the buffer storage tank is able to satisfy the heat request it receives, the request is **not** passed on to the producer.

Line no.	Operating line
4720	Auto generation lock None With B4 With B4 and B42/B41 With B42 With B42 and B41 With B4 and B71
4721	Auto heat gen lock SD
4722	Temp diff buffer/HC
4723	Temp diff buffer/CC
4724	Min st tank temp heat mode
4726	Max st tank temp cool mode
4728	Rel temp diff buffer/HC
4735	Setpoint reduction B42/B41

If the temperature level of the buffer storage tank is high enough, the consumers draw the heat they require from the buffer storage tank. The heat sources are locked via "Auto generation lock".

Auto generation lock

None

There will be no generation lock due to the buffer storage tank temperature. A heat request from the consumers is passed on directly to the heat sources.

With B4

If the temperature at sensor B4 is high enough, the heat source is locked. The consumers draw the heat they require from the buffer storage tank.

If the temperature at sensor B4 is too low, a heat request is passed on to the producers.

With B4 and B42/B41

If the temperature at both sensors B4 and B42 (or B41) is high enough, the heat source is locked. The consumers draw the heat they require from the buffer storage tank.

If the temperature at both sensors B4 and B42 (or B41) is too low, a heat request is passed on to the producers.

With B42

If the temperature at sensor B42 is high enough, the heat source is locked. The consumers draw the heat they require from the buffer storage tank.

If the temperature at sensor B42 is too low, a heat request is passed on to the producers.

With B42 and B41

If the temperature at both sensors (B42 and B41) is high enough, the heat source is locked. The consumers draw the heat they require from the buffer storage tank.

If the temperature at both sensors (B42 and B41) is too low, a heat request is passed on to the producers.

With B4 and B71

If the temperature at both sensors (B4 and B71) is high enough, the heat source is locked. The consumers draw the heat they require from the buffer storage tank.

Exception: If the temperature at sensor B4 is too low, a heat request is passed on to the producers.



For release of the producer with this setting, only the sensor in the buffer storage tank is considered (the return temperature sensor delivers a valid temperature only when the pump is in operation).

When there are no sensors, the following backup order applies:

<i>Selection</i>	<i>Sensors</i>	<i>Backup 1</i>	<i>Backup 2</i>	<i>Backup 3</i>
With B4 and B42/B41				Only B4
	B42	B41*	B71	
With B42	B42	B4		
With B42 and B41	B42	B4		
	B41*	B71		
With B4 and B71		Only B4		
	B71			

* With solar integration, B41 cannot be used or cannot replace a missing sensor

The heat/refrigeration source is put into operation only if the buffer storage tank is no longer capable of satisfying the current heat/cooling demand.

Auto heat gen lock SD

The switching differential can be adjusted. If there is only one sensor (B4) in the buffer storage tank, a minimum switching differential of 2 Kelvin applies, even if a smaller value is parameterized.
If 2 or more sensors are used, the parameterized value applies (see graph shown with lines 4720 and 4722) .

Temp diff buffer/HC

In plants with great switching differentials, a mixing valve boost is usually set to switch producers on and off. This mixing valve boost is not required when drawing heat from a storage tank and can be readjusted via parameter "Temp diff buffer/HC".

Temp diff buffer/CC

If the temperature differential ΔT between the buffer storage tank and the cooling request from the cooling circuit is sufficiently large, the cooling energy required by the cooling circuit is drawn from the buffer storage tank. The refrigeration source is locked.

- The refrigeration source is released as soon as the temperature at both buffer storage tank sensors exceeds the required flow temperature by "Temp diff buffer/CC" plus 1 Kelvin
- The refrigeration source is locked as soon as the temperature at both buffer storage tank sensors exceeds the required flow temperature by less than "Temp diff buffer/CC"

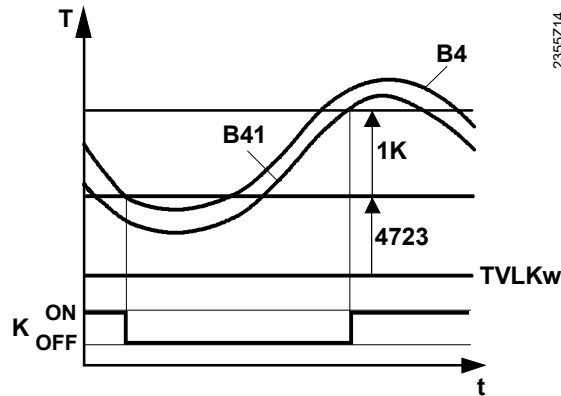

TVLKw Flow temperature setpoint in cooling mode
K Refrigeration source

Min st tank temp
heat mode

If the buffer storage tank temperature falls below the set value, the heating circuits are shut down, if no heat source is available, meaning that lockout occurred.

Max st tank temp
cool mode

If the storage tank temperature lies above the set "Max st tank temp cool mode", cooling mode is locked. The cooling circuit pumps are switched off and the mixing valves close. The cooling request to the refrigeration sources is maintained. If the storage temperature falls below the maximum storage temperature minus 1 Kelvin, cooling will be enabled again.

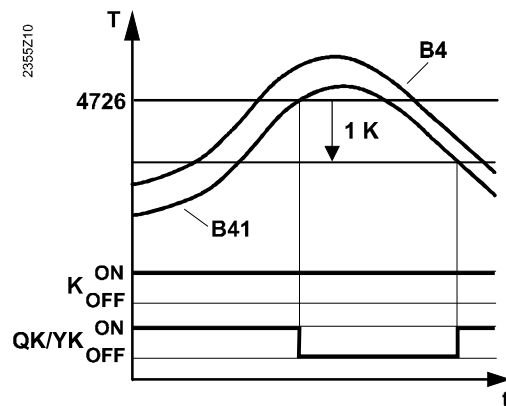

K Refrigeration source
QK / YK Cooling circuit pumps/cooling circuit mixing valves

Rel temp diff buffer/HC

"Rel temp diff buffer/HC" (parameter 4728) can be used to parameterize an undersupply in relation to the setpoint (as a percentage). This means that higher temperature requests allow greater deviations than lower requests.

The reduction is calculated as follows, based on the entered percentage value (-50...50%):

$$\text{Reduction} = (\text{TVLw} - \text{Ts}) * [\text{Rel temp diff buffer/HC \%}] / 100$$

TVLw Flow temperature setpoint
Ts Basic request 20°C
% Percentage value (-50...50%)

Example

TVLw = 60 °C or 40 °C and a tolerance of -10% each:

$$\text{Reduction}^{60^\circ} = (60-20) * (-10)/100 = -4 \text{ Kelvin}$$

$$\text{Reduction}^{40^\circ} = (40-20) * (-10)/100 = -2 \text{ Kelvin}$$

Generation lock active/inactive

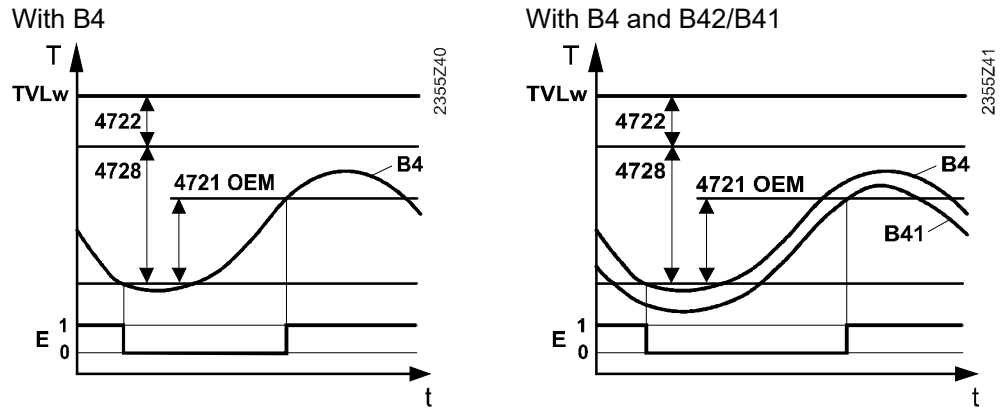

TVLw Flow temperature setpoint (Buffer setpoint, line 8981)
 B4 Buffer or combi storage tank sensor at the top
 B41 Buffer or combi storage tank sensor at the bottom
 4721 Auto heat gen lock SD
 4722 Temp diff buffer/HC
 4728 Rel temp diff buffer/HC
 E 1 = active, 0 = inactive

Generation lock inactive

As soon as the temperature at the selected buffer storage tank sensor(s) lies by "Temp diff buffer/HC" (line 4722) **plus** "Rel temp diff buffer/HC" (line 4728) below the required flow temperature setpoint, the generation lock is deactivated. The heat sources are released.

Generation lock active

When the temperature at the selected buffer storage tank sensor(s) lies less than "Temp diff buffer/HC" (line 4722) **plus** "Rel temp diff buffer/HC" (line 4728) **minus** "Auto heat gen lock SD" (line 4721) below the required flow temperature setpoint, the generation lock is active. The heat sources are locked.

Setpoint reduction B42/B41

When using a storage tank sensor at the bottom (B41, B42) or B71 (heat pump return), a setpoint reduction can be parameterized for it via "Setpoint reduction B42/B41".
 The permissible differential of setpoint and sensor at the bottom is increased by the set value.

Line no.	Operating line
4721	Auto heat gen lock SD
4723	Temp diff buffer/CC
4724	Min st tank temp heat mode
4726	Max st tank temp cool mode

The heat/refrigeration source is put into operation only if the buffer storage tank is no longer capable of satisfying the current heat/cooling demand.

Auto heat gen lock SD

The switching differential can be adjusted. If there is only one sensor (B4) in the buffer storage tank, a minimum switching differential of 2 Kelvin applies, even if a smaller value is parameterized.
 If 2 or more sensors are used, the parameterized value applies (see graph shown with lines 4720 and 4722) .

Temp diff buffer/CC

If the temperature differential ΔT between the buffer storage tank and the cooling request from the cooling circuit is sufficiently large, the cooling energy required by the cooling circuit is drawn from the buffer storage tank. The refrigeration source is locked.

- The refrigeration source is released as soon as the temperature at both buffer storage tank sensors exceeds the required flow temperature by "Temp diff buffer/CC" plus 1 Kelvin
- The refrigeration source is locked as soon as the temperature at both buffer storage tank sensors exceeds the required flow temperature by less than "Temp diff buffer/CC"

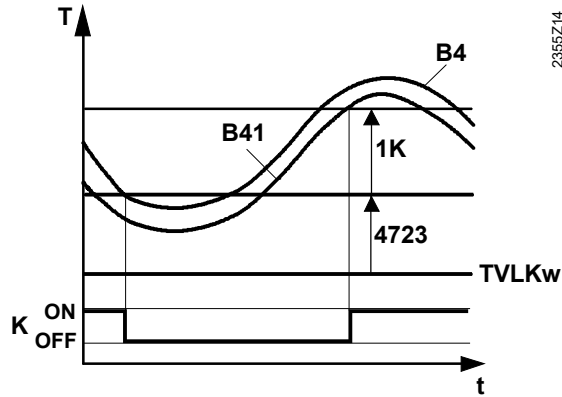

TVLKw Flow temperature setpoint in cooling mode
K Refrigeration source

Min st tank temp heat mode

If the buffer storage tank temperature falls below the set value, the heating circuits are shut down, if no heat source is available, meaning that lockout occurred.

Max st tank temp cool mode

If the storage tank temperature lies above the set "Max st tank temp cool mode", cooling mode is locked. The cooling circuit pumps are switched off and the mixing valves close. The cooling request to the refrigeration sources is maintained. If the storage temperature falls below the maximum storage temperature minus 1 Kelvin, cooling will be enabled again.

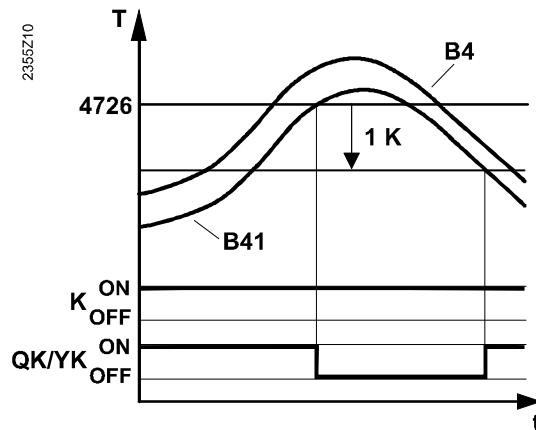

K Refrigeration source
QK / YK Cooling circuit pumps/cooling circuit mixing valves

Frost protection for the buffer storage tank

Frost protection for the buffer storage tank acts differently in heating and cooling mode.

In heating mode

If the temperature at the coldest buffer storage tank sensor drops below 5 °C, frost protection generates a temperature request to the heat sources and puts the electric immersion heater – if installed – into operation, until the storage tank temperature returns to a level above 10 °C.

In cooling mode

If, in cooling mode, one of the 2 storage tank temperatures (B4 or B41) drops below 5 °C, the refrigeration sources are shut down. They are released again when the temperature at both sensors exceeds 6 °C and the locking time of 15 minutes has elapsed.

For Eco function

Eco function is cancelled if the temperature in the buffer storage tank drops below the requested frost protection level while the Eco function is enabled. The generators are released until the temperature on the buffer storage tank exceeds the frost protection level by at least 5 °C.

Stratification protection

<i>Line no.</i>	<i>Operating line</i>
4739	Stratification protection Off Always
4740	Strat prot temp diff max
4743	Strat prot anticipation time
4744	Strat protection Tn

The buffer storage tank's "Stratification protection" function provides for hydraulic balancing between consumers and producer without the need for additional shutoff valves for the buffer storage tank.

When the function is active, the volume of water on the consumer side is adjusted so that the addition of colder water from the buffer storage tank is avoided whenever possible.

Off

The "Stratification protection" function is deactivated.

Always

The "Stratification protection" function is active when the heat source is in operation.

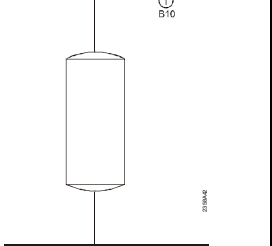
NOTE	The function requires a common flow sensor B10.	
-------------	---	---

The buffer storage tank's "Stratification protection" function provides for hydraulic balancing between consumers and producer without the need for additional shutoff valves for the buffer storage tank.

When the function is active, the volume of water on the consumer side is adjusted such that the addition of colder water from the buffer storage tank is minimized. The function is active only if at least one of the heat sources delivers heat.

If the temperature acquired by the common flow sensor (B10 downstream from the buffer storage tank) drops below the heat source temperature by more than the parameterized temperature differential, the volume of water on the consumer side is reduced via locking signals (reduction of setpoints). If the locking signal reaches 100% for more than 10 minutes, it is canceled and recalculated after 1 minute. This prevents the water flow on the consumer side from being fully throttled in which case there would be no flow passing sensor B10.

Note: If a primary controller is configured downstream from the buffer storage tank, the function is calculated with the help of sensor B15 (if no sensor B10 is connected).

Solar charging/solid fuel boiler

Line no.	Operating line
4749	Min charging setpoint solar
4750	Charging temp max

Min charging setpoint solar

For charging the buffer storage tank via solar energy, an additional "Min charging setpoint solar" can be defined.

This minimum setpoint only applies to solar charging and is always active. This means that solar energy charges the buffer storage tank also when the slave pointer is invalid (in summer mode or when the buffer storage tank receives no request for heat).



If the current slave pointer is greater than the parameterized "Min charging setpoint solar", the setpoint used is the slave pointer value.

Charging temp max

Solar energy charges the buffer storage tank up to the set "Charging temp max".



Function "Overtemperature protection for the collector" can reactivate the collector pump until the maximum storage tank temperature is reached.

Overtemperature protection

Line no.	Operating line
4751	Storage tank temp max

Storage tank temp max

If the storage tank reaches the maximum set here, the collector pump is deactivated. It is released again when the storage tank temperature drops 1 Kelvin below its maximum.

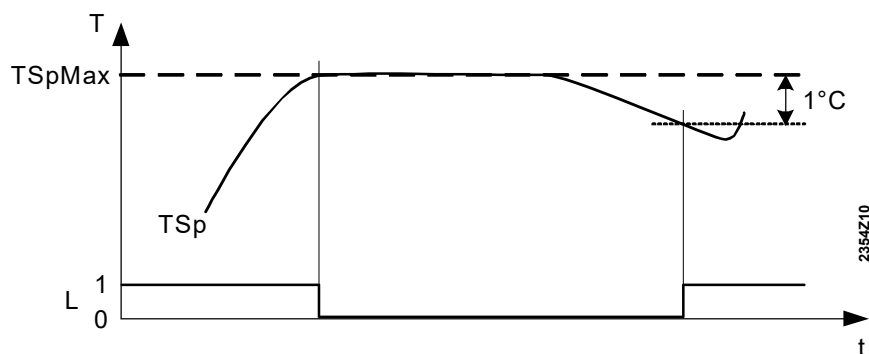

TSpMax Storage tank temp max, operating line 4751
TSp Current storage tank temperature
L Storage tank charging: 1 = on, 0 = off

Recooling

<i>Line no.</i>	<i>Operating line</i>
4755	Recooling temp
4756	Recooling DHW/HCs
4757	Recooling collector Off Summer Always

Recooling temp If the buffer storage tank was charged via "Recooling temp" (e.g. with solid fuel boiler or solar), recooling to the recooling temperature set here is effected as soon as possible.

To recool the buffer storage tank, the 2 following functions are available:

Recooling DHW/HCs The heat can be drawn either by space heating or the DHW storage tank. The function is activated or deactivated via this operating line. The drawing of heat can be selected separately for each heating circuit (operating page "Heating circuit 1, ...").

Recooling collector When the collector is cold, the energy can be emitted to the environment via the collector's surfaces.

Off

Recooling via the collector is deactivated.

Summer

Recooling via the collector is permitted in summer only.

Always

Recooling via the collector is activated throughout the year.

Electric immersion heater

<i>Line no.</i>	<i>Operating line</i>
4760	Charg sensor el imm heater
4761	Forced charging electric No Yes Smart grid, draw forced

The electric immersion heater **in the buffer storage tank** is released:

- For forced charging.
- When none of the heat sources is able to deliver heat.
- When frost protection for the buffer storage tank is active.

Charg sensor el
imm heater

Defines the sensor to be used for charging with an electric immersion heater.

B4

The electric immersion heater is switched on and off via sensor B4.

B42/B41

The electric immersion heater is switched on via sensor B41 and off via sensor B42.

Forced charging electric

If, within 1 minute after triggering forced charging, none of the heat sources in the system is put into operation for forced charging of the buffer storage tank, the electric immersion heater can do it.

No

Electric immersion heater K16 is not used for forced charging.

Yes

If no other heat source provides forced charging, electric immersion heater K16 is used.

Smart grid, draw forced

Forced charging always takes place via electric immersion heater K16 when the smart grid state is "Draw forced".

Solar integration

<i>Line no.</i>	<i>Operating line</i>
4783	With solar integration

Select here whether the buffer storage tank can be charged by solar energy.

Diversion of flow

<i>Line no.</i>	<i>Operating line</i>
4830	Flow diversion temp
4831	Swi diff flow diversion
ACS	Delay flow diversion

If the heat pump's condenser is integrated directly in the combi storage tank, the storage tank temperature in the tank section intended for DHW can considerably rise, the reason being the high temperatures of the hot-gas.

To prevent this, common flow valve Y13 can be used to switch the supply for the heating circuit to the upper section of the storage tank.



For this function, "Special temp sensor 1" must be configured and located at the very top of the storage tank.

Principle of operation

If the temperature at "Special temp sensor 1" exceeds the set "Flow diversion temp", first the heating circuit mixing valves are temporarily closed; then, after "Delay flow diversion", common flow valve Y13 is driven to the position "Top of storage tank".

If the temperature drops by "Swi diff flow diversion" below the setpoint, common flow valve Y13 is driven back to the position "Middle of storage tank".

6.17 DHW storage tank

Release

Line no.	Operating line
5007	Charging request Setpoint With B3 With B31

Charging request

Parameter "Charging request" is used to select the flow temperature setpoint for charging by the generator:

Setpoint

The current DHW temperature setpoint is used as the flow temperature setpoint.

With B3

The temperature at the DHW sensor B3 is used as the flow temperature setpoint.

With B31

The temperature at the DHW sensor B31 is used as the flow temperature setpoint. If sensor B31 is not installed, sensor B3 is used as a substitute.



The flow temperature setpoint request (DHW request) to the generator is made up of the value selected via the charging request plus the adjustable charging boost (line 5020, "Flow setpoint boost").

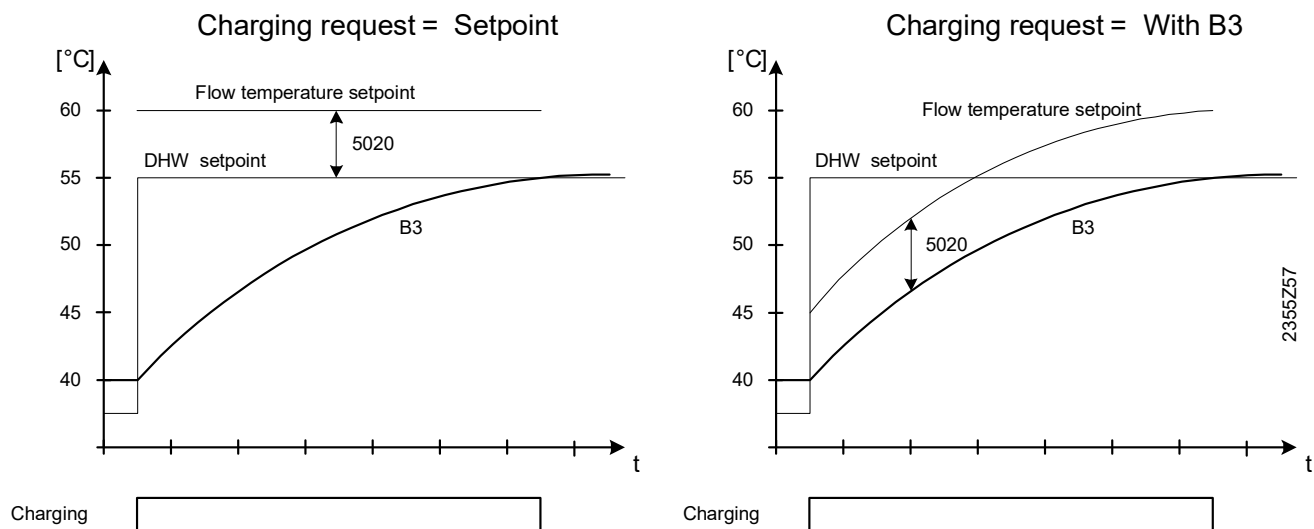

A comparison of the 2 graphs shows that in the case of a charging request "With B3", the setpoint increases continuously (applies analogously to "With B31"). This improves the performance from an energy efficiency point of view, if a modulating heat pump is used.

Line no.	Operating line
5008	Charging request timed
ACS	Heating output reduction per degree

The objective of this function is to make full use of the charging time and to keep the output of the generator at the lowest possible level. For that, the flow temperature setpoint to be delivered by the generator is calculated such that the DHW storage tank will reach its setpoint at the end of the charging time.

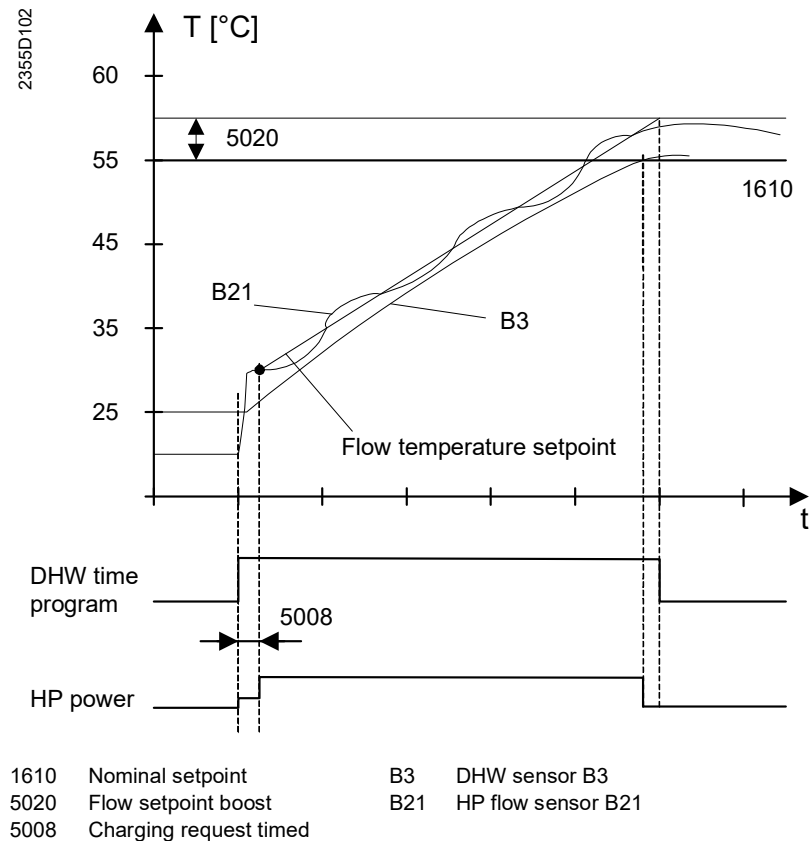

Charging request timed

The initial value of the flow temperature setpoint is calculated while giving consideration to the charging return (B71) and the minimum output of the generator. From the initial value, the flow temperature setpoint progresses as a straight line until the point of intersection of charging time and increased DHW temperature setpoint is reached.

The calculated time during which the generator is released at its minimum output is the adjustable time "Charging request timed" (line 5008).

In the following cases, the flow temperature setpoint for DHW storage tank charging is changed, that is, function "Charging request timed" is aborted:

- The heating circuit also demands heat from the generator.
- DHW charging push will be activated (automatically or manually).

The change is made according to the parameterized charging strategy (parameter 5007).

Heating output reduction per degree (ACS)

The background for the function "Heating output reduction per degree" (ACS) is that when charging with a heat pump, the heating output is reduced (at the same amount of energy), the greater the difference between the flow temperature and the source inlet temperature (in other words, reduction is in line with the charging time).

The reduction to heating output can be configured with this parameter to compensate for losses.

The request for DHW charging is adapted using this correction so that the heating output remains unchanged throughout storage tank charging despite the drop in heating output.

Setting tips

- Increase the parameter if compressor output must be increased toward the end of DHW charging.
- The parameter can be decreased if DHW charging ends before the charging time expires or the compressor output is less than at the start of DHW charging.

Line no.	Operating line
5010	Charging Once/day Several times/day

Charging

Selection of "Once/day" or "Several times/day" is active only if DHW heating release is set according to the heating circuits' time programs.

Once/day

Release of DHW charging is given 2.5 hours before the first heat request from the heating circuit is received. Then, the reduced DHW setpoint applies for the whole day..

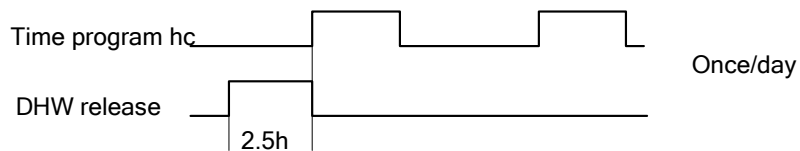

In the case of continuous heating (with no setback periods), release of DHW charging takes place at 0:00. This is also the case if the first request for heat from the heating circuit is received before 02:30. If a request for heat is made exactly at midnight, DHW charging is released after the first setback period, but no earlier than 2.5 hours before midnight.

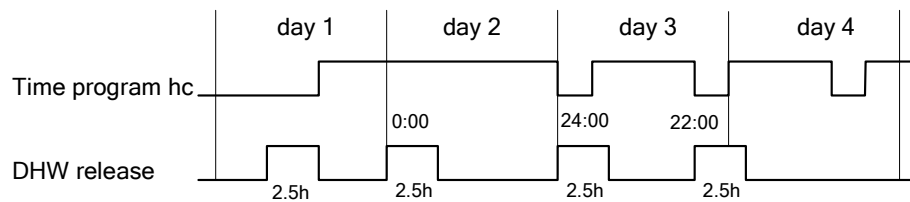

Several times/day

When selecting "Several times/day", release of DHW charging is put forward in time by 1 hour against the periods of time the heating circuit calls for heat, and is then maintained during these periods of time.

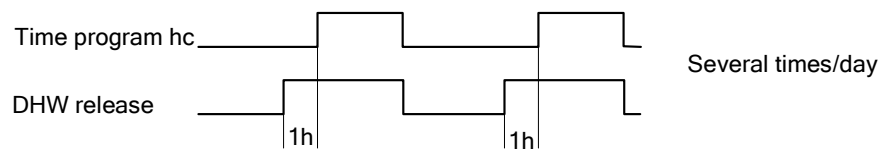

Line no.	Operating line
5013	Charging opt energy Off ; Current setpoint ; Nominal setpoint
5016	Charging opt energy contact Off ; Nominal setpoint ; Legionella funct setpoint

Charging opt energy

In connection with generators delivering optimum efficiency (condensing boilers, heat pumps, etc.), the DHW storage tank can make a non-compelling charging request.

This request can only be satisfied by generators supporting the function "Heat sources with optimum efficiency" (selectable via parameter 2867, "Output optimum").

- Generally, this request is made before the normal request. If the storage tank reaches its required setpoint as a result of this conditioned charging request, normal charging is no longer required.
- If the setpoint cannot be attained within the period of time the conditioned charging request is active, the charging process is ended by normal charging which is subsequently released.



In the case of heat transfer (with Q3 or Q11), or if a wood-fired boiler is used for charging the DHW storage tank, "Charging opt energy" is switched off.

Off

The function is deactivated (release of contact E5 still possible; see line 5016).

Current setpoint

The function is activated. If required, the DHW storage tank is heated up in "Charging opt energy" mode until the current setpoint is reached. The change from the reduced to the nominal setpoint is dependent on the release of normal charging.

Nominal setpoint

The function is activated. If required, the DHW storage tank is always heated up in "Charging opt energy" mode until the nominal setpoint is reached (independent of the release time for normal charging).

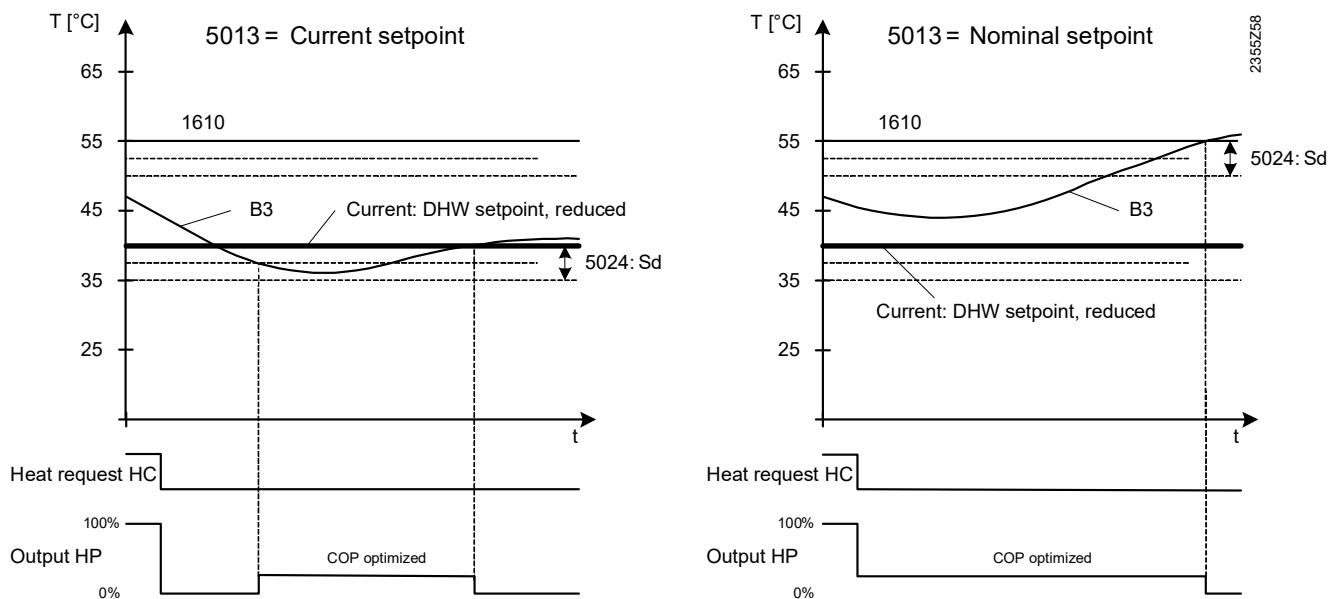

Charging opt energy contact

To perform DHW charging with optimum efficiency via contact release("Low-tariff E5"), setting "Charging opt energy contact" is required (see line 5013).



Smart grid states "Draw wish" and "Draw forced" are considered like low-tariff.

Off

No charging when contact is active.

Nominal setpoint

The DHW storage tank is charged to the nominal setpoint while observing optimum efficiency.

Legionella funct setpoint

The DHW storage tank is charged to the legionella setpoint while observing optimum efficiency.



If the normal release of DHW heating is also set to low-tariff, the DHW is charged with full capacity.

Photovoltaics

Line no.	Operating line
5018	Charging prio photovoltaics None Priority 1 Priority 2 Priority 3

Charging prio photovoltaics

A photovoltaics plant can operate the heat pump via the EX input E64 (Line 5980...) and charge the storage tank using the generated thermal energy. The storage tank charging sequence is in accordance with the set priorities. Priorities can be set for the following storage tanks:

- Swimming pool, line 2066
- Buffer storage tank, line 4706
- DHW storage tank, line 5018

None

No DHW storage tank charging.

Priority 1

DHW storage tank charging is priority 1.

Priority 2

The DHW storage tank charging is priority 2 (after buffer storage tank, prior to swimming pool, or after swimming pool, prior to buffer storage tank).

Priority 3

DHW charging has the lowest priority (after buffer storage tank and swimming pool).



Charging occurs as per the predefined sequence if storage tanks are set at the same priorities: DHW storage tank, buffer storage tank, swimming pool.

Charging control

Line no.	Operating line
5020	Flow setpoint boost
5021	Transfer boost
5022	Type of charging Recharging Full charging Full charging legio Full charg 1st time day Full charg 1st time legio
5023	Setpoint reduction B31
5024	Switching diff

Flow setpoint boost

The DHW request to the generator is made up of the current DHW setpoint and the adjustable setpoint boost.

Transfer boost

Heat transfer makes it possible to transport energy from the buffer storage tank to the DHW storage tank. For that, the current buffer storage tank temperature must exceed the current DHW storage tank temperature by the amount of the transfer boost.

The respective temperature differential can be set here.

Type of charging

DHW charging can be effected with 1 or 2 sensors.

If only 1 sensor is configured (installed), selection "Recharging" applies.

Recharging

The DHW storage tank is charged until the sensor at the top (B3) reaches its setpoint. The sensor at the bottom (B31) is not taken into consideration.

Full charging

The DHW storage tank is fully charged. Storage tank sensors B3 and B31 must reach their setpoints.

Full charging legio

The storage tank is charged with sensor B3 only.

For the "Legionella" function, both sensors (B3 and B31) must reach their setpoints.

Full charg 1st time day

The first DHW storage tank charging in the morning means full charging with sensors B3 and B31. Further chargings and the "Legionella" function are performed with B3 only.

Full charg 1st time legio

The first DHW storage tank charging in the morning and the "Legionella" function mean full charging with sensors B3 and B31. Further chargings are effected with B3.

Setpoint reduction B31

When using stratification storage tanks with external heat exchanger and charging pump Q33, the DHW temperature setpoint for the lower storage tank section (B31) might have to be reduced (prerequisite: B3 and B31 are installed). For thermal reasons in the case of full charging, the charging temperature of the lower storage tank section remains below that of the upper storage tank section.

The factors that have an impact on the adjustment of "Setpoint reduction B31" are storage tank size, charging boost, and the location of sensor B31.

Switching diff

If the DHW temperature is lower than the current setpoint minus the "Switching diff" set here, DHW charging is started.

DHW charging is ended when the temperature reaches the current setpoint.



The first DHW storage tank charging cycle in the morning is also started when the DHW temperature lies within the switching differential, provided it does not lie less than 1K below the setpoint.

Charging time limitation

Line no.	Operating line
5030	Charging time limitation
5031	Heating time limitation
5032	Max charg abortion temp
5033	Dynamic switching diff Off On

Charging time limitation

During DHW charging, space heating may receive no or too little heat (depending on the selected charging priority (line 1630) and the type of hydraulic circuit). For this reason, it is often practical to set a time limit for DHW charging.

- - -

Charging time limitation and the heating time limitation (line 5031) are deactivated. The DHW is heated up until the current DHW temperature setpoint is reached.

10...600

DHW charging is stopped after the set period of time in minutes and then locked for the same time before it is resumed. During this time period, the heat produced is made available for space heating. This cycle repeats itself until the nominal DHW setpoint is reached.



When space heating is off (summer operation, "Eco" function, etc.), DHW charging is not interrupted, irrespective of the setting made. - {} -

Abortion of DHW charging by the heat pump

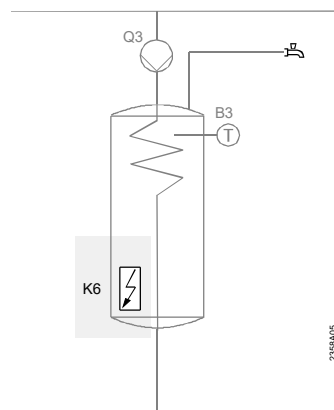



If DHW charging is interrupted because the heat pump exceeded the permissible number of charging attempts (line 2893), the electric immersion heater (K6) – if installed – completes the charging process.

If no electric immersion heater is installed, DHW charging is resumed as soon as the DHW storage tank temperature drops by the preset DHW switching differential.

The following criteria can lead to abortion of DHW charging by the heat pump:

- The heat pump cannot end DHW charging due to a high-pressure fault.
- The heat pump must stop DHW charging because the hot-gas or flow temperature approaches its maximum value. The permissible approach to the maximum value is preset.

Heating time limitation	<p>The controller switches to heating mode, if a heat request exists, after DHW charging is cancelled by the DHW charging time limitation (line 5030).</p> <p>The parameter "Heating time limitation" (line 5031) can set the maximum time for heating mode before the controller switches again to DHW charging.</p> <p style="text-align: center;">- - -</p> <p>Heating time limitation is switched off. The DHW charging lock occurs as per charging time limitation on line 5030.</p> <p>10...600</p> <p>Heating mode is stopped after the set time in minutes and DHW charging can resume until the time set in charging time limitation (line 5030) expires again. The cycle is repeated until the DHW nominal setpoint is achieved.</p>
Max charge abortion temp	<p>When the DHW storage tank reaches "Max charge abortion temp", DHW charging is aborted, but then ended by the electric immersion heater or the supplementary source. If, when DHW charging is started, the temperature at sensor B3 lies less than 1 °C below "Max charge abortion temp", charging is directly provided by the electric immersion heater or the supplementary producer.</p> <p> Function "Max charge abortion temp" is only available when both the DHW storage tank and the heat pump are controlled by the same controller.</p>
Dynamic switching diff	<p>In the event the maximum DHW charging temperature is less than the DHW storage tank setpoint minus the switching differential, the next charging request becomes active before the heat pump can be switched on as per the function "Max charge abortion temp" (line 5032).</p> <p>Any available electric immersion heater DHW (K6) or supplementary generator would continue the charging.</p> <p>The start to DHW charging can be delayed to first charge the storage tank with the heat pump. It can only take place if the storage tank actual value at B3 is at least 2 °C under the function "Max charge abortion temp".</p> <p>Off</p> <p>Charging at the present setpoint at B3 minus switching differential.</p> <p>On</p> <ul style="list-style-type: none"> • Charging at the present setpoint at B3 minus the switching differential • At the earliest, however, at "Max charge abortion temp" minus 2 °C <p> The present switch-on point can be viewed in ACS in the Diagnostics menu in ACS: "DHW switch-on point" (ACS).</p>

Discharging protection

<i>Line no.</i>	<i>Operating line</i>
5040	Discharging protection Off Always Automatically
5041	Discharging prot sensor With B3 With B31

Discharging protection

This function ensures that the DHW charging pump (Q3) is activated only when the temperature of the generator is sufficiently high.

The charging pump is only activated when the temperature of the heat source lies by half the charging boost above the DHW temperature. If, during the charging process, the temperature of the generator drops to a level below the DHW temperature plus 1/8 the charging boost, the charging pump is deactivated again. If 2 DHW sensors are parameterized for DHW charging, the lower temperature is considered for the "Discharging protection" function (usually sensor B31).

Off

The function is deactivated.

Always

The function is always active.

Automatically

The function is active only if the generator is not able to deliver heat, or is not available (fault, heat generation lock).

Discharging prot sensor

If 2 DHW sensors are parameterized for DHW charging, the sensor intended for discharging protection can be selected via "Discharging prot sensor" (B3 or B31).

Overtemperature protection

Line no.	Operating line
5050	Charging temp max

The DHW storage tank is charged by the solar collector until the set "Charging temp max" is reached.



Function "Overtemperature protection for the collector" can reactivate the collector pump until the maximum storage tank temperature is reached.

NOTE	"Charging temp max" also applies to the "Legionella" function: "Charging temp max" must be set at least as high as the setpoint of the "Legionella" function plus switching differential.
-------------	---

Overtemperature protection

Line no.	Operating line
5051	Storage tank temp max

Storage tank temp max

If the storage tank reaches the maximum set here, the collector pump is deactivated. It is released again when the storage tank temperature drops 1 Kelvin below "Storage tank temp max".

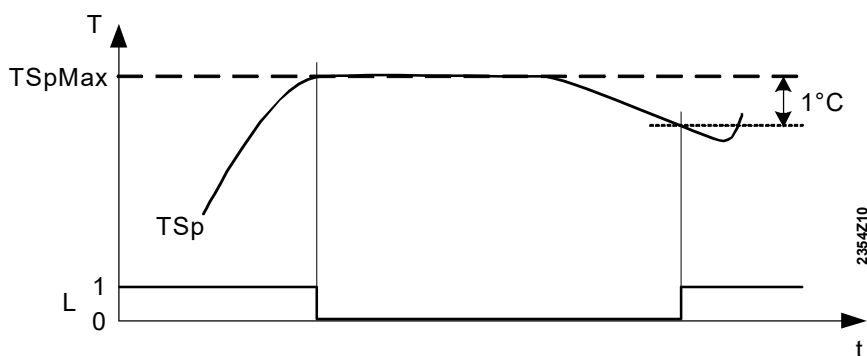

TSpMax Storage tank temp max, line 5051
 TSp Current storage tank temperature
 L Storage tank charging: 1 = on, 0 = off

Recooling

Line no.	Operating line
5055	Recooling temp
5056	Recooling heat gen/HCs Off On
5057	Recooling collector Off Summer Always

Recooling temp	An activated "Recooling" function remains active until the set recooling temperature in the DHW storage tank is reached.
Recooling heat gen/HCs /consumer circuit	Surplus energy can be drawn off either by the heating circuits/consumer circuits or the generator. This can be selected separately for each heating circuit/consumer circuit (operating page "Heating circuit/Consumer circuit X ...").
Recooling collector	When the collector is cold, surplus energy can be emitted to the environment via the collector's surfaces

Electric immersion heater

Line no.	Operating line
5060	EI imm heater optg mode Substitute Summer Always Cooling mode Emergency operation Legionella function
5061	EI immersion heater release 24h/day DHW release Time program 4/DHW
5062	EI immersion heater control External thermostat DHW sensor
5066	EI imm heater in legio funct According to operating mode Alone

 WARNING	Electric immersion heaters must be fitted with a safety limit thermostat.
--	---

NOTE	The DHW operating mode button  also acts on the electric immersion heater. For the DHW to be heated, the DHW operating mode button must be pressed.
-------------	--

El imm heater optg mode	<p>Substitute</p> <p>The electric immersion heater provides DHW charging should the heat pump go to lockout, should it be off, or should DHW charging be aborted by the heat pump. If the electric immersion heater needs to provide DHW charging because the heat pump was not able to end the charging process, the controller stores the DHW temperature at which the electric immersion heater took over via "Curr DHW charg temp HP" (line 7093).</p> <p>Also, at the changeover point, the switch-on temperature is adapted. If the DHW temperature increases due to the electric immersion heater or some other generator (e.g. solar), the switch-on point also increases according to the slave pointer principle. The switch-on point increases to a maximum of current DHW setpoint minus switching differential. If the DHW temperature falls below the switch-on point, the heat pump is put into operation.</p>
-------------------------	--

Summer

When all heating circuits have switched to summer operation, the electric immersion heater ensures DHW charging from the next day. This means that the heat pump remains deactivated during summer operation.

DHW heating via the heat pump is resumed only when at least one of the heating circuits has switched to heating mode.

In heating mode, the electric immersion heater is operated as described under setting "Substitute".

Always

DHW charging is always effected by the electric immersion heater.

When using this setting, an electric immersion heater **must** be available. There will be no DHW charging by the heat pump!

Cooling mode

DHW charging is effected by the electric immersion heater when the producers operate in cooling mode.

Also, when using this setting, the electric immersion heater is released under the conditions mentioned under "Substitute".

Emergency operation

The electric immersion heater is used only when emergency operation is selected on the controller.

Legionella function

The electric immersion heater is only used when the DHW storage tank must be heated up to the legionella setpoint and the generators are not able to end the charging process ("Heat pump" function).

The electric immersion heater is also released in the event the heat pump has gone to lockout.

For all settings, following applies:

- If the electrical utility lock for the electric immersion heater is active, the heater remains locked for all applications.
- The electric immersion heater is used for the "Storage tank frost protection" function, irrespective of the parameterized operating mode.

The table below shows the changeover to the electric immersion heater:

Event	El imm heater optg mode					
	Substitute	Summer	Always	Cooling mode	Legionella function	Emergency operation
Electrical utility lock active	No release					
High-tariff active	With DHW push					No release
Wood-fired boiler, "Eco" function or transfer active	With frost protection.					
Generator, end of charging	Every request				With legionella	No release
Cooling mode active	With frost protection.			Every request	No release	
Source locked, fault	With every request					No release
Summer operation	No release	Every request		No release		
Emergency operation	No release					Every request

El immersion heater release

24h/day

The electric immersion heater is always released, independent of time programs.

DHW release

The electric immersion heater is switched on/off according to setting "Release" (line 1620).

Time program 4/DHW

The electric immersion heater is released according to the setting made on operating page "Time program 4/DHW" of the local controller.



The release is effected only if the electric immersion heater may be operated according to setting "El imm heater optg mode" (line 5060).

El immersion heater control

In the case of DHW heating with electric immersion heater, the storage tank temperature can be monitored either with an external thermostat in the heater or the controller's inbuilt sensors.

Control with external thermostat

The controller releases constantly DHW heating with the electric immersion heater within the release period, **regardless** of the storage tank temperature. The controller's current DHW setpoint has no impact.

The required storage tank temperature must be adjusted on the external thermostat. The manual push cannot be activated. The "Legionella" function is deactivated.

Control with DHW sensor

The controller releases constantly DHW heating with the electric immersion heater within the release period, **regardless** of the storage tank temperature. The controller's current DHW setpoint is maintained.

The manual push can be activated. When the "Legionella" function is activated, charging to the legionella setpoint takes place.



To ensure that setpoint compensation operates as required, the external thermostat must be set to the minimum storage temperature.

El imm heater in legio
funct

The electric immersion heater DHW K6 can be used alone for the legionella
function.

According to operating mode

The electric immersion heater DHW is enabled as per the settings at parameter "El
imm heater optg mode" (line 5060).

Alone

The electric immersion heater is released immediately for active legionella function.
No other generator is released for the legionella function.

DHW push

<i>Line no.</i>	<i>Operating line</i>
5070	Automatic push Off ; On
5071	Charging prio time push

Automatic push

The DHW push can be triggered either manually or automatically.
As a result, the DHW is charged once until the nominal setpoint is reached.

Off

No automatic push.

On

If the DHW temperature falls by more than two switching differentials (line 5024)
below the reduced setpoint (line 1612), one-time charging to the nominal DHW
setpoint (line 1610) is effected again.



The automatic DHW push works only when the DHW heating is activated.

Notes on manual push

- An operator unit initiates a manual DHW push.
- A triggered manual push is cancelled by switching the operating mode to Eco or
OFF.

Charging prio time push

With a DHW push, the DHW storage tank is charged with absolute priority for the
set period of time.

Configuration

Line no.	Operating line
5085	Excess heat draw Off On

Excess heat draw

Excess heat draw can be triggered by the following functions:

- Inputs Hx.
- Storage tank recooling.
- Excess heat draw by the solid fuel boiler.

When dissipation of excess heat is activated, it can be discharged to the DHW storage tank.

Plant hydraulics

Line no.	Operating line
5090	With buffer No Yes
5092	With prim contr/system pump No Yes
5093	With solar integration No Yes

With buffer

If a buffer storage tank is installed, enter whether the DHW storage tank can draw heat from it.

With prim contr/system pump

It must be selected whether the DHW storage tank shall be charged via the primary controller or the system pump.

With solar integration

It must be selected whether the DHW storage tank can be charged by solar energy.

Speed-controlled pumps, controlled mixing valve

Heat exchanger in the storage tank and sensor B36 in the return.

The controller calculates the charging pump speed such that the return temperature acquired by sensor B36 is 2 Kelvin above the storage tank temperature (B3).

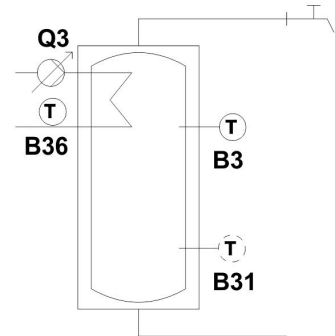

Heat exchanger outside the storage tank, with primary controller.

The controller calculates the charging pump speed such that the DHW setpoint plus charging boost at sensor B35 is achieved.

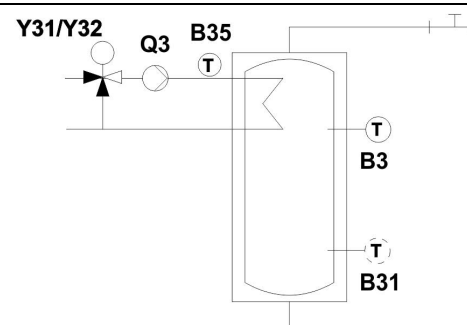

Heat exchanger outside the DHW storage tank and sensor B36 in the flow.

The controller calculates the speed of the speed-controlled pump such that the charging temperature at sensor B36 exceeds the DHW setpoint by "Intermediate circuit boost" (line 5140, and partial diagrams 22 and 23).

If the sensor fails, Q33 delivers the parameterized maximum speed.

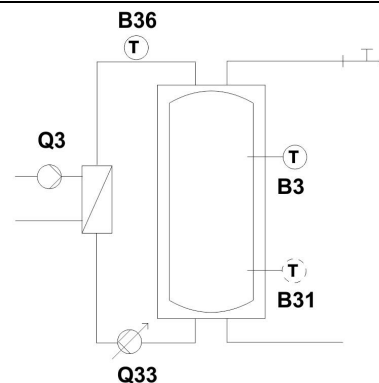

Heat exchanger outside the storage tank, with primary controller.

Without B36

The controller calculates the speed of the speed-controlled pump such that the charging temperature at sensor B35 exceeds the DHW setpoint by "Intermediate circuit boost" (line 5140). In this case, primary controller sensor B35 must be located in the intermediate circuit.

With B36

If B36 is connected as well, B35 must be positioned as the primary controller sensor. The controller calculates the speed of charging pump Q3 such that the temperature acquired by sensor B35 represents the DHW setpoint plus charging boost.

The controller calculates the speed of intermediate circuit pump Q33 such that the charging temperature at sensor B36 exceeds the DHW setpoint by "Intermediate circuit boost" (line 5140).

If the sensor fails, Q33 delivers the parameterized maximum speed.

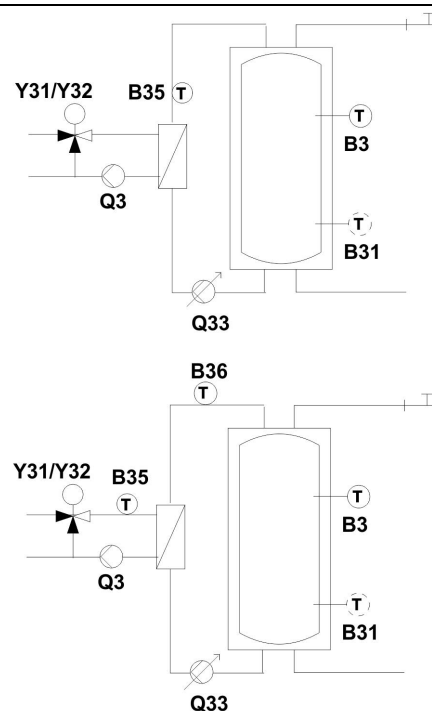

Heat exchanger outside the storage tank, with intermediate circuit mixing valve.

The controller controls the mixing valve such that the charging temperature at sensor B36 exceeds the DHW setpoint by "Intermediate circuit boost" (line 5140). If the current DHW charging temperature at B36 is lower than the required setpoint plus intermediate circuit boost, the mixing valve is closed until the temperature at sensor B36 reaches the required level.

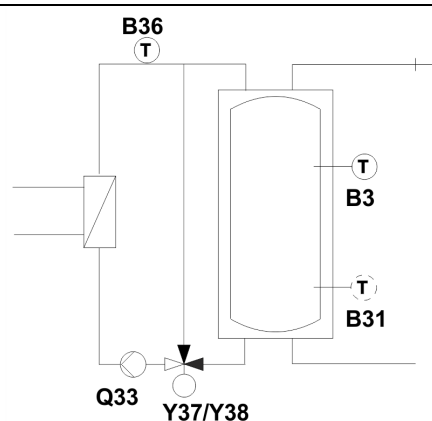

Acting direction of speed-controlled pumps

Q3

- Charging temperature (B35/B36) below setpoint: Speed is increased
- Charging temperature (B35/B36) above setpoint: Speed is reduced

Q33

- Charging temperature (B35/B36) below setpoint: Speed is reduced
- Charging temperature (B35/B36) above setpoint: Speed is increased

<i>Line no.</i>	<i>Operating line</i>
5101	Pump speed min
5102	Pump speed max

Pump speed min/max

The speed range of the DHW pump is limited by the minimum and maximum permissible speed.

To ensure that the pump operates reliably on startup, it is operated at maximum speed for the first 10 seconds.

<i>Line no.</i>	<i>Operating line</i>
5103	Speed Xp
5104	Speed Tn
5105	Speed Tv
5108	Starting speed charg pump
5109	St speed interm circ pump

Pump speed; parameter

Parameters can be set to define a minimum and maximum pump speed. The PID controller's control action can be influenced by parameters Xp, Tn, and Tv. The controller operates with a neutral zone of +/-1 Kelvin. The resulting speed is output via the configured speed output (ZX4 or DC 0...10 V).

Parameters Xp, Tn, and Tv

By setting the right proportional band Xp, integral action time Tn, and the derivative action time Tv, the control action can be matched to the type of plant (controlled system).

Xp, Tn and Tv can be determined using common methods, e.g. the step response method depicted in Section "Xp, Tn, Tv – Step response method".

Brochure BT_0098_EN provides additional notes on control technology in buildings.

Starting speed charg pump, St speed interm circ pump

When the plant is put into operation, the respective pump is started with the starting speed set here before being driven to the speed level demanded by speed control.

Precontrol of mixing valve

<i>Line no.</i>	<i>Operating line</i>
5120	Mixing valve boost
5124	Actuator running time
5125	Mixing valve Xp
5126	Mixing valve Tn

Mixing valve boost	To ensure proper mixing valve flow temperature control, the flow temperature must be higher than the demanded setpoint of the mixing valve flow temperature. The set value is added to the request.
Actuator running time	Setting the valve running time. Parameters Xp and TnBy setting the right proportional band Xp and integral action time Tn, the control action can be matched to the type of plant (controlled system).
Parameters Xp and Tn	By setting the right proportional band Xp and integral action time Tn, the control action can be matched to the type of plant (controlled system). Xp and Tn can be determined using common methods, e.g. the step response method depicted in Section "Xp, Tn, Tv – Step response method". Brochure BT_0098_EN provides additional notes on control technology in buildings.

Transfer of heat

Line no.	Operating line
5130	Transfer strategy Off Always DHW release
5131	Comparison temp transfer With B3 With B31 With B3 and B31

Transfer strategy

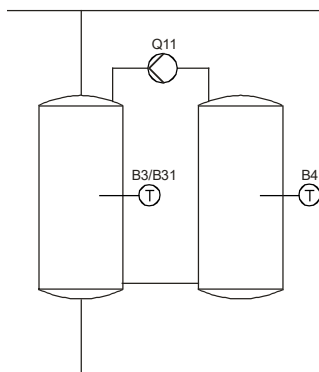

If the temperature level of the buffer storage tank is high enough, the DHW storage tank can be charged by the buffer storage tank.

Depending on the hydraulic circuit, the transfer of heat can be effected either with charging pump Q3 or transfer pump Q11, which is specifically parameterized for this function.

When DHW heating is deactivated, the transfer of heat is switched off as well.

The following transfer strategies are available:

Off

The transfer of heat is deactivated.

Always

When DHW heating is activated, the buffer storage tank always charges the DHW storage tank until the nominal setpoint is reached. If the "Legionella" function is activated and due, the heat is transferred until the legionella setpoint is reached.

DHW release

When DHW heating is activated, the buffer storage tank always charges the DHW storage tank until the current setpoint according to the DHW release times is reached (line 1620). If the "Legionella" function is activated and due, the heat is transferred until the legionella setpoint is reached.



For charging with Q3 from the buffer storage tank, function "With buffer" (line 5090) needs to be activated (setting "Yes").

If Q3 was parameterized as a diverting valve (line 5731), or a specific transfer pump Q11 is installed, Q3 is not used for the transfer of heat.



In the case of a manual DHW push during heat transfer, normal DHW charging to the nominal DHW setpoint is triggered.

If the buffer storage tank satisfies this temperature request as well (buffer storage tank temperature > nominal setpoint + charging boost), the transfer of heat remains active and the generator will not be put into operation.

Heat transfer with combi storage tank

If a specific transfer pump Q11 is installed, the transfer of heat is also effected when using a combi storage tank.

If only Q3 is used and heat transfer is in progress, the controller waits until the DHW section is heated up again by the surrounding storage tank; during this period of time, neither the generator nor Q3 is put into operation.

If this waiting time is not desired, the "Transfer" function must be deactivated.

Comparison temp transfer

For the transfer of heat, the desired DHW sensor can be selected to get a comparative temperature.

With B3

Heat transfer is effected when the temperature at sensor B3 lies at least 1 Kelvin below the current transfer setpoint and the temperature at buffer storage tank sensor B4 exceeds the temperature at sensor B3 by at least the amount of the transfer boost.



If sensor B3 is not installed, there will be no transfer of heat.

Charging by the generator and simultaneous heat transfer are not possible.

With B31

Heat transfer is effected when the temperature at sensor B31 lies at least 1 Kelvin below the current transfer setpoint and the temperature at buffer storage tank sensor B4 exceeds the temperature at sensor B31 by at least the amount of the transfer boost.



If B31 is not installed, sensor B3 is used for the transfer of heat.

Charging by the generator and simultaneous transfer of heat are possible, provided the transfer is effected via the separate transfer pump Q11.

With B3 and B31

Both sensors B3 and B31 are considered for the transfer of heat.

Heat transfer is effected when the temperature at sensor B3 lies at least 1 Kelvin below the current transfer setpoint and the temperature at buffer storage tank sensor B4 exceeds the temperature at sensor B3 by at least the amount of the transfer boost.

The transfer of heat is ended when the temperature at sensor B31 reaches the current transfer setpoint.



If B31 is not installed, sensor B3 is used for the transfer of heat.

Charging by the generator and simultaneous heat transfer are not possible.

Stratification storage tank/intermediate circuit

Line no.	Operating line
5140	Intermediate circuit boost

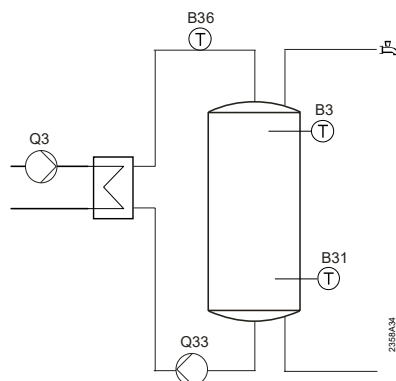

Intermediate circuit boost

For charging, the flow temperature in the intermediate circuit (B36) needs to exceed the required DHW setpoint by the value set here because the heat exchanger is not able to transfer all energy.

The set value is added to the request.

Flow temperature setpoint compensation

Line no.	Operating line
5142	Flow setp compensation delay
5143	Flow setp compensation Xp
5144	Flow setp compensation Tn
5145	Flow setp compensation Tv

Flow temperature setpoint compensation

Setpoint compensation adapts the heat request such that the intermediate circuit temperature at B36 reaches its setpoint (storage tank temperature setpoint plus intermediate circuit boost).

If the intermediate circuit temperature is too low, the request to the generator is increased.

The maximum increase of the setpoint is limited to half the setpoint boost (line 5020).

If the intermediate circuit temperature is too high, the request to the generator is reduced. The minimum temperature level to which the request to the generator can be reduced is the storage tank temperature setpoint.

Setpoint compensation can be switched on and off via parameter "Flow setp compensation delay" (line 5142) (off or value between 0...60 seconds).

Setpoint compensation with speed-controlled pump Q33

If, in addition to setpoint compensation, speed control of pump Q33 is active, the setpoint is increased only when speed control reached the allowed minimum and the temperature at B36 still lies below the setpoint.

Also, the request for heat is reduced only when speed control reaches the allowed maximum and the temperature at sensor B36 is still too high.

If the request had to be updated, the pump runs at the minimum or maximum speed.

This function is performed automatically and cannot be deactivated.

Flow setp compensation delay
 After switching on the intermediate circuit pump, short-time temperature fluctuations in the intermediate and primary circuit can occur. These are ignored, due to the delay of setpoint compensation. Setpoint compensation is released when intermediate circuit pump Q33 runs for at least the time set here. Operation of pump Q33 is started with the setpoint plus charging boost.

Flow setp compensation Xp /Tv/Tv
 The PID controller's control action can be influenced by parameters Xp, Tn, and Tv. The controller operates with a neutral zone of +/- 1 Kelvin. The resulting speed is delivered via the speed output selected according to the configuration (triac ZX4 or DC 0...10 V).

Parameters Xp, Tn and Tv
 By setting the right proportional band Xp, the integral action time Tn, and the derivative action time Tv the control action can be matched to the type of plant (controlled system).
 Xp, Tn and Tv can be determined using common methods, e.g. the step response method depicted in Section "Xp, Tn, Tv – Step response method".
 Brochure BT_0098_EN provides additional notes on control technology in buildings.

<i>Line no.</i>	<i>Operating line</i>
5146	Full charging with B36 No Yes

Full charging with B36
 To fully charge the DHW storage tank, DHW charging sensor B36 can be used in place of sensor B31. The charging process is completed when sensor B36 reaches the required temperature (DHW setpoint **plus** line 5140 **plus** 3 Kelvin) and, at the same time, sensor B3 reaches the required setpoint.
 When starting DHW storage tank charging, the intermediate circuit sensor is considered only if the intermediate circuit pump has been in operation for at least 30 seconds.

<i>Line no.</i>	<i>Operating line</i>
5147	Min overrun time Q33
5148	Min start temp diff Q33

Min overrun time Q33

For the intermediate circuit pump, a minimum overrun time can be set. The time starts to lapse as soon as the request for heat to the generator drops.

The intermediate circuit pump always runs 10 seconds longer than charging pump Q3.

Using this parameter, it can be made certain that intermediate circuit pump Q33 always overruns for a minimum period of time.

Q33 and discharging protection

If "Discharging protection" (line 5040) is parameterized, it must be performed for intermediate circuit pump Q33 to start.



When discharging protection is complied with, DHW charging pump Q3 is in operation or, with diverting valve Q3, the charging temperature reached the discharging protection level.

Min start temp diff Q33

Another condition for intermediate circuit pump Q33 to start can be a parameterized minimum temperature differential of storage setpoint and generator temperature (B21, B10, B35, B15).

This function ensures that when starting intermediate circuit pump Q33, no cold water will reach the upper section of the stratification storage tank.

Special cases with regard to the minimum temperature differential:

- "Charging request" (line 5007) = "With B3", "Min start temp diff Q33" of storage tank sensor (B3) and generator temperature applies.
- "Charging request" (line 5007) = "With B31", "Min start temp diff Q33" of storage tank sensor (B31) and generator temperature applies.
- Intermediate circuit pump Q33 is activated – independently of the set temperature differential – when the generator temperature approaches from below the flow temperature setpoint demanded by the generator by less than 2 Kelvin (line 8951). This ensures activation of the intermediate circuit pump in the different charging modes.

Intermediate circuit controller

Line no.	Operating line
5156	Int circuit actuator run time
5157	Int circuit mixing valve Xp
5158	Int circuit mixing valve Tn
5159	Use int circuit mixing valve Always Only hi-temp charging

The charging temperature can be controlled with the help of a mixing valve installed in the intermediate circuit. For that, a mixing group or an extension module must be parameterized as "DHW interm circuit controller".

Mixing valve settings

If the charging temperature in the intermediate circuit is controlled with a mixing valve, its "Int circuit actuator run time" as well as P- and I-action of PI control can be set (see below).



If an immediate circuit controller and a speed-controlled intermediate circuit pump are installed, the speed of intermediate circuit pump Q33 is increased only after the mixing valve has fully opened.

Int circuit actuator run time

Setting the running time for the actuator used with the mixing valve.

Parameters Xp and Tn

By setting the right proportional band Xp and integral action time Tn, the control action can be matched to the type of plant (controlled system).

Xp and Tn can be determined using common methods, e.g. the step response method depicted in Section "Xp, Tn, Tv – Step response method".

Brochure BT_0098_EN provides additional notes on control technology in buildings.

Use int circuit mixing valve

For high-temperature charging of the heat pump, the use of the intermediate circuit mixing valve can be specifically adapted. For more detailed information about high-temperature charging, refer to parameter 5170 ff.

Behavior with high-temperature charging

When using high-temperature charging of the heat pump and parameter 5159, "Use int circuit mixing valve", with setting "Only hi-temp charging", following applies:

- In the case of normal DHW charging, the intermediate circuit pump operates at maximum speed.
- The mixing valve is only controlled in connection with high-temperature charging.
With normal DHW charging, the mixing valve is fully opened.

Mixing pump Q35/restratification

The mixing pump can be used either as a mixing pump in connection with the "Legionella" function or as a restratification pump.

Line no.	Operating line
5160	Legionella funct mixing pump Off With charging With charging and duration
5165	Restratification No Yes
5166	Restrat temp min
5167	Restrat temp diff min
5169	Functions Q35 with Q33 No Yes

Legionella funct mixing pump

Off

With setting "Off", the mixing pump is not used when the "Legionella" function is active.

With charging

Mixing pump Q35 is put into operation while the "Legionella" function is active.

With charging and duration

Mixing pump Q35 is put into operation while the "Legionella" function is active and during the time that follows (line 1646).

Restratification

The "Restratification" function can be activated/deactivated.

No

There will be no restratification with the mixing pump.

Nevertheless, restratification can be activated during the time the "Legionella" function is active.

Yes

The "Restratification" function compares the 2 DHW storage tank sensors B3 and B31.

Restrat temp min

For the "Restratification" function to be performed, storage tank sensor B31 at the bottom must have reached the set level.

Restrat temp diff min

When the temperature at sensor B31 at the bottom of the storage tank exceeds the temperature at sensor B3 at the top by more than the adjustable restratification temperature differential (line 5167), mixing pump Q35 is put into operation. The switching differential is 2 Kelvin.

The function for Q35 can be fulfilled with the intermediate circuit pump Q33 if the mixing pump Q35 is not available.

No

Q33 is only used as the intermediate circuit pump.

Yes

Q33 is used as an intermediate circuit pump and also assumes the tasks of the mixing pump Q35 in accordance to settings on lines 5160, 5165, 5166, and 5167.

The following are differences to a separate mixing pump Q35:

- The intermediate circuit pump is only started once the start conditions are met during DHW charging using a generator to the legionella level.
- On a variable speed controlled intermediate circuit pump Q33, the minimum speed is outputted during the linger period for legionella function as well as restratifications.

High-temperature charging with heat pump

High-temperature and normal charging

With high-temperature charging, an extra hot-gas heat exchanger integrated in the heat pump is used to extract at a high temperature level part of the produced heat. This way, high DHW temperatures can be reached with good efficiency .

With high-temperature charging, the DHW storage tank is charged **along** with normal heating or cooling mode (not on request).

High-temperature charging runs along with heating or cooling mode, provided this is permitted by the plant's operating state.

If the storage tank temperature, the time program, etc., call for storage tank charging, normal DHW charging is started.



High-temperature charging has no impact on charging by the generator as described in this document. With normal DHW charging, following applies:

- High-temperature charging will be interrupted.
- The controlling elements (pump and mixing valve) are controlled based on the logic of normal DHW charging.

Configuration and makeup

To control high-temperature charging, a "DHW interm circuit controller" or a speed-controlled "DHW interm circ pump Q33" is required.

Normally, a DHW intermediate circuit is used to make a separation between system and DHW. In the case of the hot-gas heat exchanger, this is not a mandatory requirement as shown by the plant examples illustrated below.



The electric immersion heater can also be installed in the flow of the hot-gas heat exchanger. The position is selected via parameter 5805, "Location el imm heater flow".

Plant diagram 1: Mixing valve

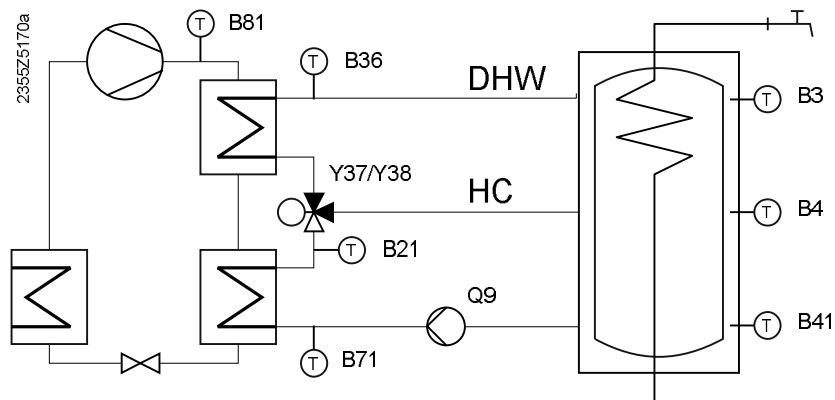

This type of plant requires a mixing group.



The associated pump relay can no longer be used.

Plant diagram 2: Mixing circuit

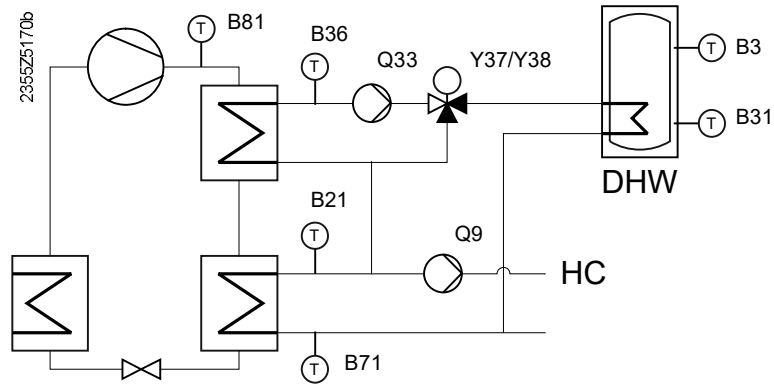

A pump and a mixing valve are required.
Benefit of this solution: There is always circulation around sensor B36.

Plant diagram 3: Speed-controlled pump

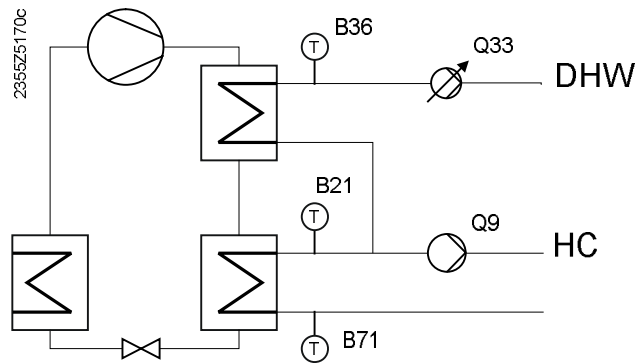

Only an extra pump is required, but it must be speed-controlled.

Plant diagram 4: Usage in active cooling mode also

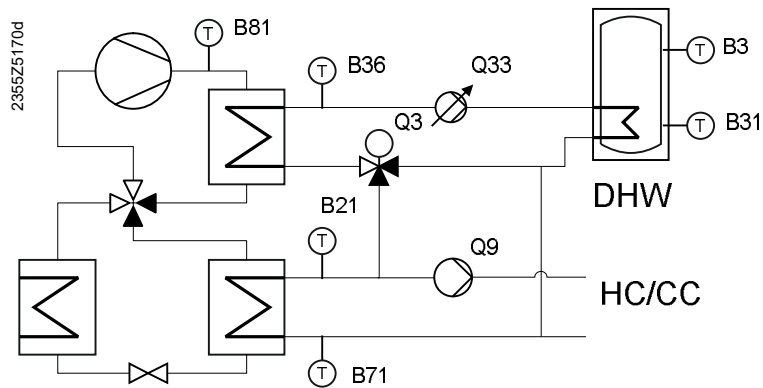

This solution represents an extension of plant diagram 2: High-temperature charging is also possible in active cooling mode.



The same extension is also possible with plant diagram 3.

Plant diagram 5: With explicit DHW intermediate circuit

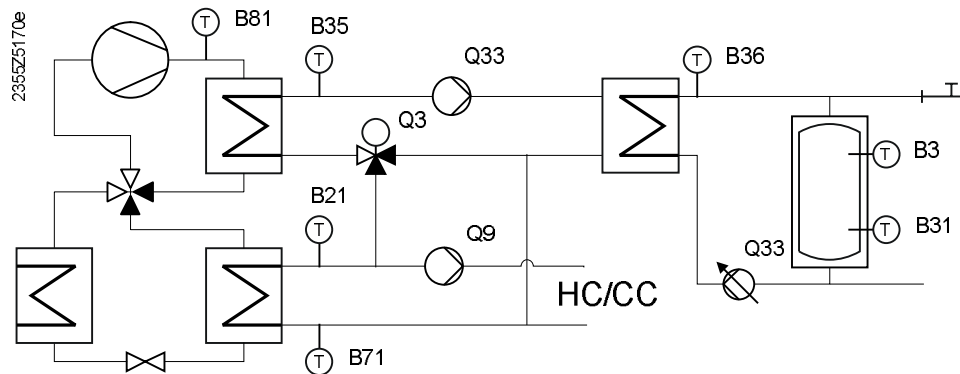

If, in addition, sensor B35 is installed, the speed-controlled pump can be activated with a delay.



Physically speaking, Q33 in the plant diagram are 2 pumps which, logically, are configured as the same "Pump Q33".

Here, the relay output is already energized while speed control still remains deactivated. Speed-controlled intermediate circuit pump Q33 is activated only when the temperature at B35 is high enough.

High-temperature charging

Line no.	Operating line
5170	Hi-temp charging Off Own source, heating mode Own source heat/cool mode All sources, heating mode

Activating high-temperature charging

Parameter "Hi-temp charging" is used to activate the function and, at the same time, the configuration is adapted to the different types of usage resulting from the system hydraulics.

Off

No high-temperature charging

Own source, heating mode (Plant diagrams 1...3)

High-temperature charging is only effected by (own) heat pump. High-temperature charging in heating mode is possible. Heat pump and DHW storage tank are connected to the same controller.

Own source heat/cool mode (plant diagrams 4 and 5)

High-temperature charging is only effected by (own) heat pump. High-temperature charging is possible in heating, cooling and defrost mode. Heat pump and DHW storage tank are connected to the same controller.

All sources, heating mode

High-temperature charging is effected by all installed generators.



DHW storage tank and heat pump can be connected to separate controllers. The same criterion applies to generator cascades: Several controllers are used.

In the case of separate controllers or a cascade, following applies:

- The function can only be used in heating mode (not in cooling mode).
- No consideration can be given to the hot-gas temperature (see parameter 5173).

Setpoint(s) with high-temperature charging

Fixed setpoint

Line no.	Operating line
5171	Hi-temp charging setpoint

For high-temperature charging, a separate setpoint can be parameterized.

In this case, high-temperature charging charges the DHW storage tank to the set value: The charging setpoint at B36 is the "Hi-temp charging setpoint" plus "Intermediate circuit boost" (line 5140).

High-temperature charging is effected only when the set charging setpoint at B36 is reached.

Automatic generation of setpoint

Line no.	Operating line
5172	Hi-temp min ch diff flow

Charging setpoint, basic

If no specific setpoint for high-temperature charging is parameterized (Hi-temp charging setpoint = "- - -"), the nominal DHW setpoint (line 1610) plus "Intermediate circuit boost" (line 5140) is **basically** used as the charging setpoint for high-temperature charging.

Additional criteria

But depending on the plant's operating state (storage tank temperature B3/B31, hot-gas temperature B81, flow temperature B21), the charging temperature may also be higher or lower. In addition, the following 2 criteria apply:

1. The charging setpoint must always be higher than the heat pump's flow temperature (B21). Otherwise, in the case of plants without Q3, this may lead to undesired normal charging. For this reason, a downward limitation of the charging setpoint at flow temperature (B21) plus "Hi-temp min ch diff flow" is made.
2. To prevent mixing or even discharging of the DHW storage tank, the charging setpoint must not be lower than the current storage tank temperature. If 2 storage tank sensors are installed, parameter "Discharging prot sensor" (line 5041) can be used to select the sensor to be considered.

Storage tank setpoint

The storage tank setpoint used for high-temperature charging is the nominal DHW setpoint (line 1610), and "Legionella funct setpoint" (line 1645) when the "Legionella" function is activated.

When the temperature at storage tank sensor B3 reaches the setpoint, high-temperature charging is ended. This prevents the storage tank from exceeding a certain temperature level.

If 2 storage tank sensors are installed, the lower sensor (B31) is considered.

Exceptions:

- Solar integration
- "Discharging prot sensor" (line 5041) = "B3"



In the case of a combi storage tank, high-temperature charging is also continued when the setpoint is reached. When the DHW section of the storage tank is fully charged, the hot water is fed to the tank's heating section.

Start behavior with high-temperature charging

Line no.	Operating line
ACS	DHW high-temp charging, duration start kick
5173	Hi-temp min ch diff hot-gas

Start kick

Depending on the type of plant (e.g. plant diagram 1), there is no circulation around control sensor B36 when the mixing valve is fully closed.

Or intermediate circuit pump Q33 is not allowed to run continuously run when the setpoint is not reached (plant diagram 3).

If, in addition, there is no hot-gas sensor, there is no criterion for the mixing valve to open or for the pump to switch on. In this case, the start kick enables high-temperature charging to start correctly.

After a delay time of 2 minutes upon the compressor's activation, the pump for "DHW high-temp charging, duration start kick" (ACS) is switched on and the mixing valve opens by 5%. If the setpoint is not reached after this period of time, the mixing valve is closed and the pump is switched off again.

A new start kick is made as soon as the temperature differential of the generator's current flow and the storage tank has dropped by 5 Kelvin.

Without start kick, with charging temperature

If the start kick is deactivated ("DHW HighT dur kick"= - - -), high-temperature charging is started as soon as the charging temperature is high enough.

In this case, it must be made certain that the temperature at charging sensor B36 reaches the required level automatically.

Impact of hot-gas temperature

The hot-gas temperature of the heat pump is the hottest point in this system and determines the maximum charging temperature in the current operating state. If hot-gas sensor B81 is installed, its information is used to start and stop high-temperature charging.

High-temperature charging is released as soon as the hot-gas temperature lies by at least "Hi-temp min ch diff hot-gas" (ACS) above "Hi-temp charging setpoint" (line 5171). High-temperature charging is locked as soon as the hot-gas temperature lies by less than half "Hi-temp min ch diff hot-gas" (ACS) below "Hi-temp charging setpoint" (line 5171).

In the case of 2-stage heat pumps with 2 hot-gas sensors, the higher value is used.



- The use of a hot-gas sensor (B81) is not mandatory, but recommended.
- If DHW and the heat pump are connected to different controllers, or in the case of high-temperature charging with several generators ("Hi-temp charging" (BZ 5170) = "All sources, heating mode"), the hot-gas temperature is not taken into consideration.

DHW heat pump

This function releases an autonomous DHW heat pump for charging the DHW storage tank and frost protection for the DHW heat pump.

The additional and autonomous DHW heat pump obtains its energy from the return of a heating/cooling circuit.

Line no.	Operating line
5177	DHW HP off time min
5178	DHW HP source temp min
5179	DHW HP source pump None Heat circuit pump HC1 Q2 Heat circuit pump HC2 Q6 Heat circuit pump HC3 Q20 Condenser pump Q9 Cooling circ pump CC1 Q24 Cooling circ pump CC2 Q28

Enable

Prerequisites for activating the function:

- A "Common return sensor B73" is connected and configured.
- A release relay for the DHW heat pump ("DHW heat pump K33") is connected and configured.
- Parameter 5179 "DHW HP source pump" has been used to determine which of the installed pumps shall be the source pump for the DHW heat pump.



Setting "None" (source pump) is possible too. In that case, the source pump is controlled by the DHW heat pump itself.

Control

If DHW charging is required, the source pump of the DHW heat pump is activated and the DHW heat pump is released (K33 = on).



- The DHW heat pump cannot send a heat request to the RVS61 controller.
- From the perspective of the RVS61 controller, the DHW heat pump behaves like an electric immersion heater with regard to switching program, setpoints and operating state.

Frost protection for the return

If the return temperature (B73) drops below "DHW HP source temp min" (line 5178), the DHW heat pump is locked (K33 = off). The DHW source pump remains activated. This means:

- Circulation around the return sensor (B73) is maintained.
- As soon as the DHW heat pump extracts no more energy, the return temperature rises again.

If the return temperature drops further, the consumer associated with the source pump of the DH heat pump (e.g. heating circuit 1) sends a frost protection request to the generator, thus ensuring frost protection.



If the return temperature signal is missing or if its value is invalid, the source pump of the DHW heat pump and the DHW heat pump itself are shut down.

Minimum off time

If the DHW heat pump and/or the source pump of the DHW heat pump are switched off by the RVS61 controller or are locked by a protection function, they will be released again only when "DHW HP off time min" (line 5177) has elapsed.

6.18 Instantaneous water heater

Summary

The controller supports DHW heating via an external heat exchanger. In that case, the heat is delivered by the buffer, DHW or combi storage tank.

A speed-controlled pump (left) or pump with mixing valve (right) are used to supply heat to the instantaneous water heater, depending on demand:

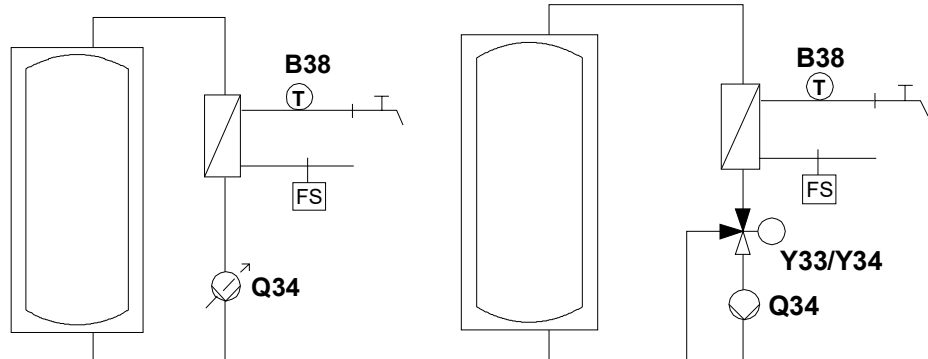

When the DHW flow switch (FS) detects flow, sensor B38 provides control to the nominal setpoint (line 1610).

When the flow switch detects no more flow, pump Q34 is deactivated.

Configuration

Speed-controlled (left)

When using a speed-controlled pump without mixing valve (left), the outputs and inputs need to be configured individually:

- Pump Q34 is configured to a multifunctional ZX or Ux output
- Water outlet sensor B38 is to be configured to a multifunctional Bx input
- The DHW flow switch (FS) is to be configured to a multifunctional input Hx

Mixing valve (right)

When using a mixing valve and a pump with a fixed speed (right), 2 configuration choices are available:

- "Function mixing group 1" (line 6014) is configured as "Instantaneous water heater"
- Function extension module 1...3 (line 7300, 7375 or 7450) is configured as "Instantaneous water heater"

In that case, pump Q34, mixing valve Y33/Y34, water outlet sensor B38 and the DHW flow switch (FS) are assigned to fixed inputs and outputs.



For assignment tables, refer to parameters 6014, 6455 and 7300, 7375 and 7450.

Control with storage tank

Line no.	Operating line
5406	Min setp diff to tank temp
5407	Storage tank setpoint incr

Min setp diff to tank temp

The maximum DHW tap temperature setpoint controlled is the current storage tank temperature minus the adjustable setpoint differential. The function can be switched off with setting "- - -".

Storage tank setpoint incr

Charging of the storage tank is effected such that the nominal setpoint will be exceeded by an adjustable differential ("Storage tank setpoint incr"), thus ensuring that the DHW temperature will not drop below the parameterized setpoint.



"Storage tank setpoint incr" should be parameterized **above** the setpoint differential (line 5406).

Speed-controlled pump

Line no.	Operating line
5530	Pump speed min
5531	Pump speed max
5532	Speed Xp
5533	Speed Tn
5534	Speed Tv

Pump speed min

The minimum permissible speed limits the permissible speed range of the instantaneous heater pump at the bottom.

Pump speed max

The maximum speed for the pump of the instantaneous water heater can be set. The highest pump speeds can be locked. The speed of the pump for the instantaneous water heater can be controlled.

Parameters Xp, Tn and Tv

By setting the right proportional band Xp, the integral action time Tn, and the derivative action time Tv the control action can be matched to the type of plant (controlled system).

Xp, Tn and Tv can be determined using common methods, e.g. the step response method depicted in Section "Xp, Tn, Tv – Step response method".

Brochure BT_0098_EN provides additional notes on control technology in buildings.

Control of mixing valve

<i>Line no.</i>	<i>Operating line</i>
5544	Actuator running time
5545	Mixing valve Xp
5546	Mixing valve Tn
5547	Mixing valve Tv

Setting the running time of the actuator used with the mixing valve for the instantaneous water heater.

Parameters Xp, Tn,
and Tv

By setting the right proportional band Xp, integral action time Tn, and derivative action time Tv, the control action can be matched to the type of plant (controlled system).

Mixing valve Xp

See parameter 5532.

Mixing valve Tn

See parameter 5533.

Mixing valve Tv

See parameter 5534.

6.19 General functions

Delta-T-controller

Line no.		Operating line
5570	5580	Temp diff on dT contr 1, 2
5571	5581	Temp diff off dT contr 1, 2
5572	5582	On temp min dT contr 1, 2
5573	5583	Sensor 1 dT controller 1, 2 None Buffer sensor B4 Buffer sensor B41 Collector sensor B6 DHW sensor B31 DHW circulation sensor B39 Swimming pool sensor B13 Collector sensor 2 B61 Buffer sensor B42 Common flow sensor B10 Cascade return sensor B70 Special temp sensor 1 Special temp sensor 2 DHW sensor B3 HP flow sensor B21 HP return sensor B71 Outside sensor B9 Source inlet sensor B91 Source outl sens B92/B84 Room sensor B5 Room sensor B52 Room sensor B53 Flue gas temp sensor B8 Solid fuel boiler sensor B22 Solid fuel boil ret sens B72 Primary contr sensor B15
5574	5584	Sensor 2 dT controller 1, 2 None Buffer sensor B4 Buffer sensor B41 Collector sensor B6 DHW sensor B31 DHW circulation sensor B39 Swimming pool sensor B13 Collector sensor 2 B61 Buffer sensor B42 Common flow sensor B10 Cascade return sensor B70 Special temp sensor 1 Special temp sensor 2 DHW sensor B3 HP flow sensor B21 HP return sensor B71 Outside sensor B9 Source inlet sensor B91 Source outl sens B92/B84 Room sensor B5 Room sensor B52 Room sensor B53 Flue gas temp sensor B8 Solid fuel boiler sensor B22 Solid fuel boil ret sens B72 Primary contr sensor B15
5575	5585	On time min dT contr 1, 2

The "Delta-T-controller" function offers 3 choices:

- Monitoring of maximum temperature limit crossings
- Monitoring of minimum temperature limit crossings
- Differential temperature controller

Two delta-T-controllers are available which can be independently configured and used.

The following graphs and explanations use the operating lines of delta-T-controller 1 as an example (parameters 5570...5575). All interrelationships apply analogously to delta-T-controller 2 (parameters 5580...5585).

Exceeding the temperature limit

This function can be used to compare a freely selectable temperature value with an adjustable limit value. "Sensor value 2" (line 5574) must be deactivated ("None"). Here, the relay is energized when the temperature exceeds the limit value.

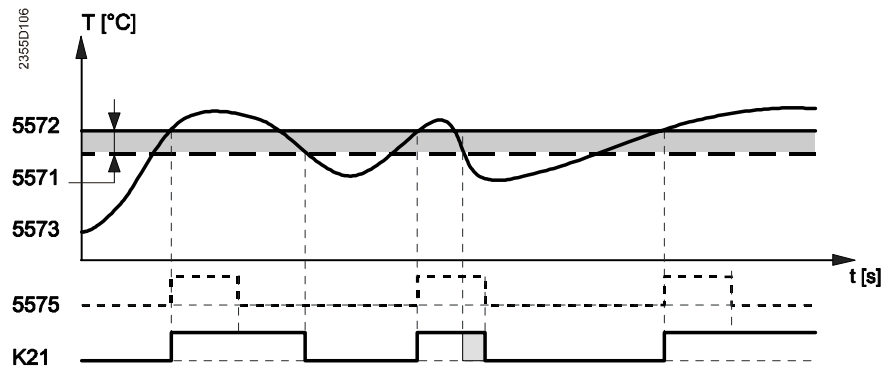

5573	Sensor 1 dT controller 1	5572	On temp min dT contr 1
5571	Temp diff off dT contr 1	5575	On time min dT contr 1

Relay energized

Relay K21 is energized when the following condition is satisfied:

- "Sensor value 1" (line 5573) exceeds "On temp min dT contr 1" (line 5572)

Relay deenergized

Relay K21 is deenergized when the following condition is satisfied:

- "Sensor value 1" (line 5573) drops below "On temp min dT contr 1" (line 5572) by more than "Temp diff off dT contr 1" (line 5571)

If "On time min dT contr 1" (line 5575) is parameterized, the relay will not be deenergized before this time has elapsed.

Falling below the temperature limit

This function can be used to compare a freely selectable temperature value with an adjustable limit value. "Sensor value 1" (line 5573) must be deactivated ("None"). Here, the relay is energized when the temperature falls below the limit value.

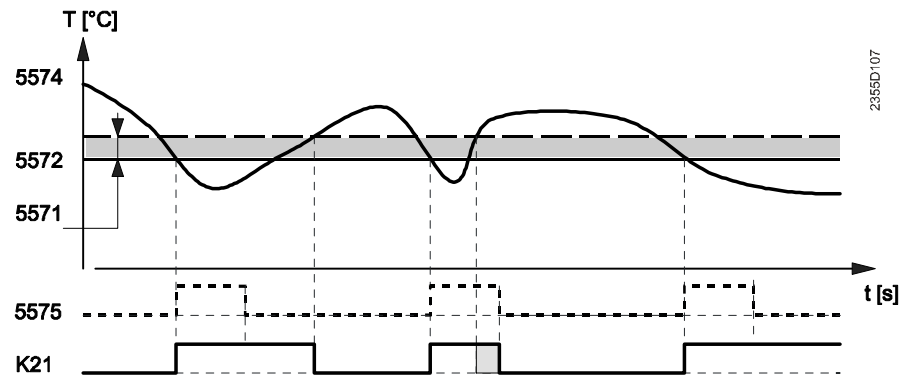

5574	Sensor 2 dT controller 1	5572	On temp min dT contr 1
5571	Temp diff off dT contr 1	5575	On time min dT contr 1

Relay energized

Relay K21 is energized when the following condition is satisfied:

- "Sensor value 2" (line 5574) falls below "On temp min dT contr 1" (line 5572)

Relay deenergized

Relay K21 is deenergized when the following condition is satisfied:

- "Sensor value 2" (line 5574) exceeds "On temp min dT contr 1" (line 5572) by more than "Temp diff off dT contr 1" (line 5571)

If "On time min dT contr 1" (line 5575) is parameterized, the relay will not be deenergized before this time has elapsed.

Differential temperature controller

This function can be used to compare 2 freely selectable temperature values. At the same time, an absolute minimum value is monitored.

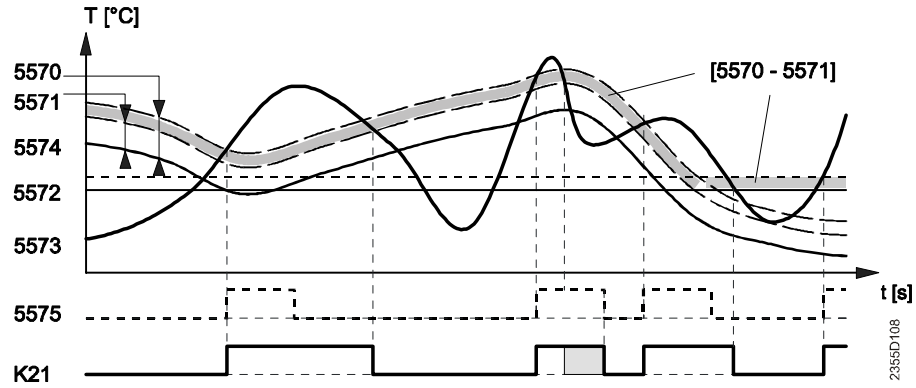

5573	Sensor 1 dT controller 1	5571	Temp diff off dT contr 1
5574	Sensor 2 dT controller 1	5572	On temp min dT contr 1
5570	Temp diff on dT contr 1	5575	On time min dT contr 1

Relay energized

Relay K21 is energized when the following condition is satisfied:

- "Sensor value 1" (line 5573) exceeds "Sensor value 2" (line 5574) by more than "Temp diff on dT contr 1" (line 5570), **and**
- "Sensor value 1" (line 5573) exceeds "On temp min dT contr 1" (line 5572) by more than ["Temp diff on dT contr 1" minus "Temp diff off dT contr 1"] (5570 minus 5571).

Note: Compare the last switch-on point in the graph.

Relay deenergized

Relay K21 is deenergized when the following condition is satisfied:

- "Sensor value 1" (line 5573) approaches "Sensor value 2" (line 5574) from above by more than "Temp diff off dT contr 1" (line 5571), **or**
- "Sensor value 1" (line 5573) falls below "On temp min dT contr 1" (line 5572).

Note: Compare the last switch-off point in the graph.

If "On time min dT contr 1" (line 5575) is parameterized, the relay will not be deenergized before this time has elapsed.

Line no.	Operating line
5577	5587
Pump/valve kick K21, K22	
Off On	

Pump/valve kick K21, K22

For relays K21 and K22, it can be selected whether they shall be included in the "Pump/valve kick" function ("On" per default).

For description of the "Pump/valve kick" function, refer to chapter 6.28.

Line no.	Operating line	
5578	5588	Off temp max dT contr 1 und 2

Off temp max dT contr 1 and 2

For the Delta T controller, in addition to:

- Temp diff on dT contr 1, 2,
- Temp diff off dT contr 1, 2
- On temp min dT contr 1, 2 for sensor value1

a maximum permitted value for sensor 2 can also be configured.

As soon as sensor value 2 is warmer than the set value, relay K21 or K22 is switched off.

The switching differential for switching on again is fixed at 2K.

Outside air temperature control

Outside temperature control via a water-air heat exchanger is possible if a brine or water source is available.

The outside air is preheated or precooled via the heat exchanger prior to the inlet.

Preheating protects against icing of heat recovery in winter, while precooling permits passive cooling in summer.

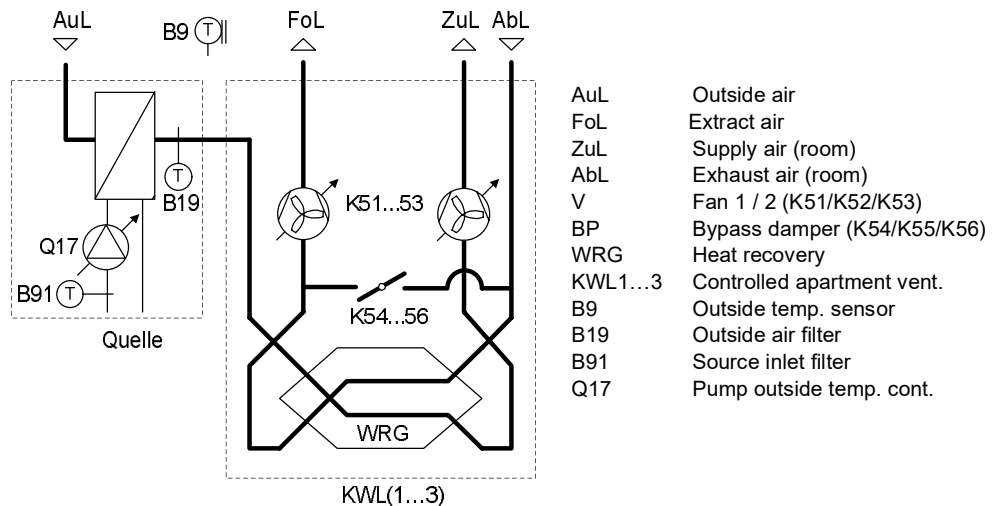

Requirements

The following temperature sensors required for full functionality:

- Outside temperature sensor B9
- Outside air sensor B19
(value for B9 is used if unavailable)
- Source inlet sensor B91
(as an operation to prevent cooling if the source is too warm)
- Room temperature sensor

Line no.	Operating line
L1...L3	
ACS	Outside air temp control Off Summer only Winter only Summer and Winter
ACS	Outside air temp control below outside temp
ACS	Outside air temp control, temp diff
ACS	Outside air temp control, on time min
ACS	Outside air temp control, off time min

Out side air temp control

Off

Outside air temperature control is switched off.

In summer only

Outside air temperature control only occurs during summer operation.

The warm outside air is precooled through the brine-air heat exchanger, enabling passive cooling. This reduces energy demand for any active cooling.

Precooling of outside air is locked if a heat circuit demands heat.

Precooling of outside air is activated if the room temperature and the temperature at the outside air sensor B19 is above the comfort setpoint (ACS).

It is switched off if the outside temperature B9 and all room temperatures in all zones is below the comfort setpoint (ACS).

In winter only

Outside air temperature control only occurs in winter operation.

The outside air is preheated through the brine-air heat exchanger and prevents formation of ice in heat recover when outside temperature are too low.

As soon as the outside temperature B9 and the temperature at the outside air sensor B19 are located below the switching setpoint (outside air temperature under TA), preheating of outside air is activated.

It is switched off if both temperatures exceed the switching setpoint and the outside temperature has changed by at least 0.5 K.

Summer and winter

Outside air temperature control occurs throughout the entire year.

In summer, the outside air is precooled; in winter preheated.

Outside air temperature below TA

Outside air temperature control is enabled and locked in winter based on this switching setpoint. The setting should be a few degrees lower than the temperature at source inlet sensor B91.

Outside air temperature difference

In winter mode (preheating), the temperature at source inlet sensor B91 must at a minimum be higher by the temperature difference entered here than the temperature at outside air sensor B19.

Outside air temperature on time min.

The activated outside air temperature control and thus pump Q17 remain on for at least the period entered here.

Outside air temperature pause min.

The function can only be reenabled after the period entered here after canceling.

Air dehumidifier

Line no.	Operating line
5600	Air dehumidifier Off On
5602	Air dehumidifier r.h. on
5603	Air dehumidifier r.h. SD
5606	Release air dehumidifier 24h/day Time program HC Time program 5
5608	Acquisition rel air humidity None With input H1 With input H2 module 1 With input H2 module 2 With input H2 module 3 With input H21 module 1 With input H21 module 2 With input H21 module 3 With input H22 module 1 With input H22 module 2 With input H22 module 3 With input H3

An external air dehumidifier is to be connected as follows:

- Configure one of the Qx relays as "Air dehumidifier K29".
- Set one of the inputs Hx to "Humidity measurement 10V".
- Set "Acquisition rel air humidity" (line 5608) to this input Hx.

Air dehumidifier

Parameter "Air dehumidifier" switches the external air dehumidifier on and off.

Off

Off.

On

According to parameter "Release air dehumidifier".

Release air dehumidifier

24h/day

The air dehumidifier is released 24 hours a day.

Time program HC

The air dehumidifier is released according to "Time prog heating/cooling 1".

Time program 5

The air dehumidifier is released according to "Time program 5".

Air dehumidifier
r.h. on

If the relative humidity acquired via the input Hx exceeds the setpoint adjusted here, the air dehumidifier is switched on.

Air dehumidifier
r.h. SD

If the relative humidity falls by the switching differential set here below "Air dehumidifier r.h. on", the air dehumidifier is switched off again.

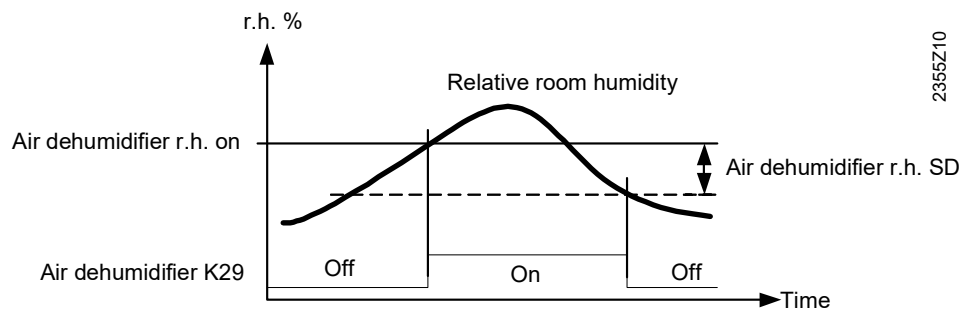

2355Z10

Acquisition rel air
humidity

The relative humidity is acquired via one of the inputs Hx using setting "Humidity measurement 10V".

"Acquisition rel air humidity" must refer to this input Hx.

6.20 Configuration

Procedure

First, make use of the preselection and enter the plant diagram that comes closest to the plant in question. Then, modify manually the individual partial diagrams to match them to your requirements.

Select the extra functions only then and make the fine-tuning via the operating lines of the individual parameters.

Presetting

<i>Line no.</i>	<i>Operating line</i>
5700	Presetting
ACS	Plant diagram selection validity Changed Unchanged

Presetting

The diagrams in chapter "Plant diagrams" can be preselected by entering a diagram number. The plant diagram is the result of presetting plus the connected sensors.



For more information about the selection of plant diagrams, refer to chapter "Application diagrams".

Manual setting / adaption of partial diagrams

A plant diagram is made up of several partial diagrams.

The partial diagrams needed can be used to manually produce the required final plant diagram.

It is also possible to adapt partial diagrams of a plant diagram that were generated via "Presetting" (line 5700).

A separate catalog with partial diagrams contains the partial diagrams implemented in the controller (classified according to groups). Also listed in the catalog are the required operating lines which must be set to produce the respective partial diagrams, plus the sensors required for the relevant partial diagram.



On operating lines 6212...6217, it can be checked whether the adjustments led to the right partial diagram. The check number shown there must accord with the relevant components group.

Plant diagram selection validity (ACS)

Display if the plant diagram selected with parameter 5700 was subsequently changed ("Changed") or not ("Unchanged").

Heating circuits/cooling circuits

Line no.			Operating line
1	2	3	
5710	5715	5721	Heating circuit 1, 2, 3 Off On
5711	5716	5722	Cooling circuit 1, 2, 3 Off 4-pipe system cooling 2-pipe system cooling
5712	5717	5723	Use of mixing valve 1, 2, 3 None Heating Cooling Heating and cooling

Heating circuit 1, 2, 3

Using this setting, heating circuit 1/2/3 can be switched on and off.

Cooling circuit 1, 2, 3

Off

Cooling circuit 1/2/3 is switched off.

4-pipe system cooling

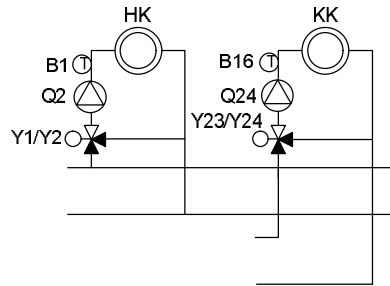

Cooling and heating circuit draw their cooling energy/heat from separate common flows.

2-pipe system cooling

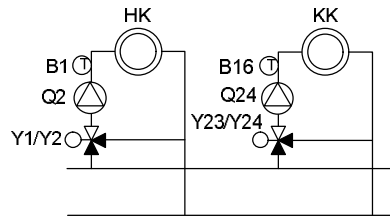

Cooling and heating circuit draw their cooling energy/heat from the same common flow.

Use of mixing valve 1, 2, 3

The parameter is active under 2 conditions:

- Only with a 4-pipe system.
- If a relay output Qx is used as a diverting valve Y21 for cooling.

Heating

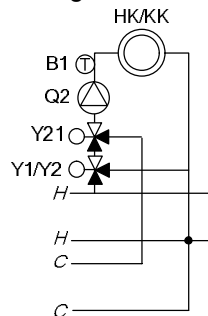

Cooling

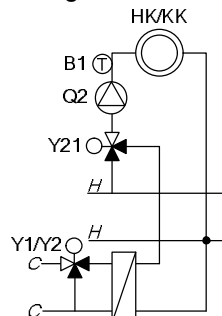

Heating and cooling

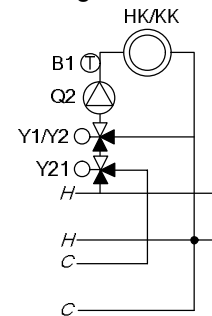

HC Heating circuit
 KK Cooling circuit
 H Common heating flow
 C Common cooling flow

DHW

<i>Selection</i>	<i>Operating line</i>
5728	DHW storage tank Off On
5731	DHW ctrl elem Q3 No charging request Charging pump Diverting valve
5734	Basic position DHW div valve Last request Heating circuit DHW

DHW storage tank

The parameter switches on and off the partial diagram DHW storage tank.

Off

The partial diagram DHW storage tank is switched off. The DHW menu and the DHW operating mode button are hidden. All DHW sensors are no longer monitored (B3, B31, B35, B36, B39).

On

The partial diagram DHW storage tank becomes active, if the required sensors and actuators are available. All configured functions for the DHW storage tank are activated.

DHW ctrl elem Q3

No charging request

No DHW charging via Q3.

Charging pump

DHW charging is effected with a pump connected to terminal Q3.

Diverting valve

DHW charging is effected with a diverting valve connected to terminal Q3.

Basic position DHW div valve

Defines the basic position of the diverting valve (Q3) in the waiting state:

Last request

The diverting valve maintains the position assumed last.

Heating circuit

When there is no request for heat, the diverting valve assumes the "Heating circuit" position.

DHW

When there is no request for heat, the diverting valve assumes the "DHW" position.



The function acts only if "DHW ctrl elem Q3" is configured as "Diverting valve".

Separate DHW circuit

<i>Line no.</i>	<i>Operating line</i>
5736	DHW separate circuit

In the case of multiboiler plants (cascades), one of the boilers can temporarily be used for DHW charging only. When DHW charging is activated, that boiler disconnects itself hydraulically from the system by means of the so-called separate circuit and is not available for space heating during that period of time.

On completion of DHW charging, the boiler is again available for space heating, which means that it informs the cascade about it.

Off

The separate DHW circuit is off. Every available generator can charge the DHW storage tank.

On

The separate DHW circuit is on. DHW charging takes place solely by the generator selected for it.

Electric immersion heater

<i>Selection</i>	<i>Operating line</i>
5740	Output el imm heater K6

Defines the output of the electric immersion heater installed in the DHW storage tank.

The output entered is used for calculating the yearly performance factor.

<i>Selection</i>	<i>Operating line</i>
5742	Restart lock pump Q34 Off On

Restart lock pump Q34

Per default, pump Q34 of the instantaneous water heater is exempted from the restart lock (line 6123) (short response time).

This parameter can be used to include the pump.

<i>Selection</i>	<i>Operating line</i>
5743	Cooling during DHW charging Off On

Cooling during DHW charging

Without "Div valve cooling flow Y29", cooling via the common cooling flow (1) is locked during DHW charging.

With "Div valve cooling flow Y29", the behavior during DHW charging can be selected:

- **Off:**
Cooling via the common consumer cooling flow (1) is locked during DHW charging.
- **On:**
Cooling via the common consumer cooling flow (1) is permitted during DHW charging.

Consumer circuits

Consumer circuits 1 and 2 can be used to operate as heating or cooling circuits (e.g. for a warm air curtain or cooling chamber).

The consumer circuit is activated when the demand signal (contact or DC 0...10 V) is parameterized at one of the Hx inputs **and** usage of the consumer circuit is selected. Usage of a pump is optional.

Line no.		Operating line
VK1	VK2	
5750	5751	Consumer circuit 1, 2 Off Heating 4-pipe system cooling 2-pipe system cooling

Off

The consumer circuit is off.

Heating

The respective consumer circuit is used for heating purposes only.

4-pipe system cooling

The respective consumer circuit draws its cooling energy from the common cooling flow.

2-pipe system cooling

The respective consumer circuit draws its cooling energy from the common heating flow.

Swimming pool

Line no.	Operating line
5752	Swimming pool Off On

The parameter switches on and off the swimming pool partial diagram.

Off

The swimming pool partial diagram is switched off. The swimming pool menu is hidden. The swimming pool sensor B13 is no longer monitored.

On

The swimming pool partial diagram becomes active if the required sensors and actuators are available. All configured functions for the swimming pool become active.

Heat pumps, cooling

Active and passive cooling

With heat pumps supporting both passive and active cooling, the controller switches automatically from passive to active cooling, and vice versa.



Simultaneous active and passive cooling is not possible.

As long as the temperature acquired by the source inlet sensor (B91) lies below the cooling request, cooling is passive. If the source inlet temperature exceeds the cooling request, the controller switches to active cooling.



If no source inlet sensor (B91) is installed, the source outlet sensor (B92) is used as the changeover criterion.

Active cooling

With active cooling, the heat pump operates as a refrigeration machine by reversing the process in the summer. A heat pump with a 4-way valve (Y22) is required for reversing the process.

Plant example

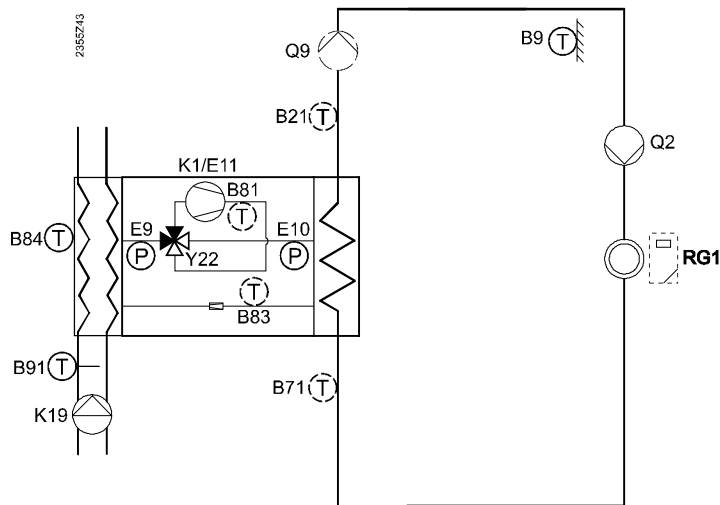

Passive cooling

In the case of passive cooling, cooling is effected by letting the cold water circulate through the system without putting a refrigeration source into operation. For that, the heat pump's source pump and the cooling circuit are switched on.



With air-water heat pumps passive cooling is only possible with a source intermediate circuit.

Plant example

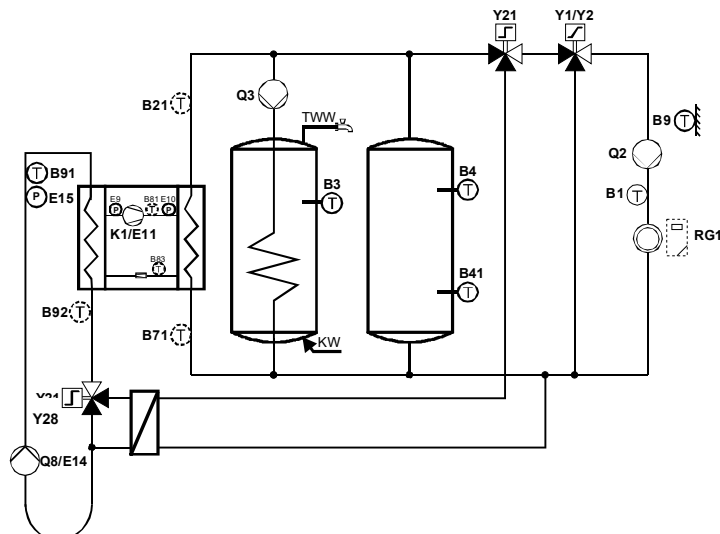

Parameterizing cooling

Line no.	Operating line
5807	Refrigeration Off Active and passive cooling Active cooling Passive cooling
5808	Cooling system 4-pipe system cooling 2-pipe system cooling

Refrigeration

The setting defines the way the heat pump produces refrigeration.

Off

No generation of refrigeration.

Active and passive cooling

Refrigeration is produced actively or passively.

Active cooling

Refrigeration is always produced actively (process reversal).

Passive cooling

Refrigeration is always produced actively (source).

Cooling system

The setting defines the common flow over which the cooling energy reaches the consumer.

4-pipe system cooling

Cooling takes place via the separate common cooling flow (common flow 2).

If a DHW request is pending, it is satisfied by the heat pump via the common heating/cooling flow. If there is a refrigeration request pending at the same time, it can simultaneously be satisfied via the common cooling flow.

2-pipe system cooling

Cooling takes place via the common heating/cooling flow (common flow 1).

If a DHW request is pending, it is satisfied by the heat pump via the common heating/cooling flow. If, at the same time, there is a refrigeration request pending, it cannot be satisfied.



If passive cooling is effected via the common heating/cooling flow, parameter "In passive cooling mode" (line 3007) can be used to define whether condenser pump Q9 shall be switched on or off.

The following cooling choices are provided:

1. Refrigeration: "Active and passive cooling"

"Cooling system" (line 5808):	4-pipe system cooling	2-pipe system cooling	2-pipe system cooling
"In passive cooling mode" (line 3007):	n/a	Condenser pump on	Condenser pump off

The functions of the common flows are then as follows:

Common flow (1)	Heating	Heating/active or passive cooling	Heating/active or passive cooling
Common flow (2)	Active or passive cooling	n/a	n/a

2. Refrigeration: "Active cooling"

"Cooling system" (line 5808):	4-pipe system cooling	2-pipe system cooling	
"In passive cooling mode" (line 3007):	n/a	n/a	

The functions of the common flows are then as follows:

Common flow (1)	Heating	Heating/active cooling	
Common flow (2)	Active cooling	n/a	

3. Refrigeration: "Passive cooling"

"Cooling system" (line 5808):	4-pipe system cooling	2-pipe system cooling	2-pipe system cooling
"In passive cooling mode" (line 3007):	n/a	Condenser pump on	Condenser pump off

The functions of the common flows are then as follows:

Common flow (1)	Heating	Heating/passive cooling	Heating/passive cooling
Common flow (2)	Passive cooling	n/a	n/a

General configuration rules

- For changeover of the refrigeration flow, the 2 valves Y27 and Y28 are available. Configuration of these outputs is optional; if omitted, there will be no configuration error.
Y27: Switches in active cooling mode
Y28: Switches in passive cooling mode
- For active cooling, process reversing valve Y22 must be installed and configured. If that is not the case, a configuration error will be reported.
- The cooling energy consumers must be set to the same type of cooling system (2-pipe or 4-pipe) as the heat pump.

Cooling with hydraulic changeover

Heat pumps without built-in process reversing valve in the refrigeration circuit can also be used for passive and active cooling by implementing hydraulic changeover outside the heat pump unit (see parameter 2941).

Reversal of direction of flow

In active cooling mode, process reversal causes the direction of flow of the refrigerant through the heat exchanger to change.

To enable the heat exchanger to continue its operation with the more efficient counterflow, the direction of flow on the consumer side can be reversed as well.

If a buffer storage tank is integrated, a positive side-effect is that, when in cooling mode, the buffer storage tank is correctly charged from below.

The following hydraulic diagram shows one possibility how reversal of the direction of flow can be implemented.

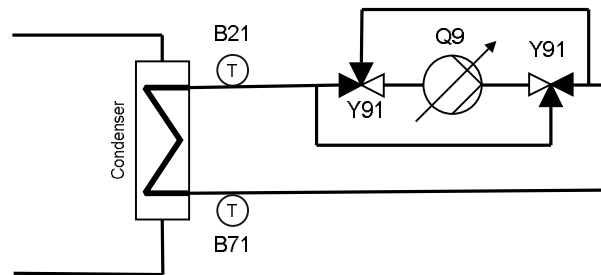

If reversal of the direction of flow is accomplished with a "Cond reversing valve Y91", following applies:

- "Cond reversing valve Y91" is activated as soon as the heat pump operates in active cooling mode.

Heat pump

Line no.	Operating line
5800	Heat source Brine Water Air Externally brine Externally water Externally air
5803	Device address ext source
5804	Source prot sens brine HP

Heat source

Selecting the generator used by the heat pump.

This selection defines the number and types of sensors required and matches functionality to the respective type of heat pump.

Brine

When using geothermal energy, for example.

Water

When using ground, lake or river water, for example.

Air

When using air.

Externally brine | Externally water | Externally air

When using a generator with external control. The external heat pump can be controlled via the X75 outputs.

The connection of heat pump sensors to the RVS... controller is optional. Sensors connected to the controller are used and the associated functions are enabled.

Device address ext source

Within a cascade, all heat pumps may use the same source pump. The source intermediate circuit pump is excluded from this.

But a common heat pump is only possible within the same cascade. The function supports both heat and refrigeration generators.

Selection

The LPB address of the heat pump to which the source pump is connected is to be entered in "Device address ext source".



In addition, the own generator (line 5800) must be switched off or must be set to "Externally brine" or "Externally water". "Externally Air" cannot be selected, since defrost is not available for selection.

Configuration errors

If, by mistake, reference is made to a heat pump or own source pump, a configuration error appears ("499:External source missing").

Source prot sens brine HP

This selection defines whether the source inlet sensor (B91) or the source outlet sensor (B92) is used for the source protection function.

Line no.	Operating line
5810	Differential HC at OT -10°C

Differential HC at OT -10°C

For the heat pump to be controlled according to the return temperature setpoint, the latter needs to be determined first.

For that, the flow temperature setpoint (according to the heating curve) is reduced by the expected temperature differential across the condenser to be used as the return temperature setpoint.

The temperature differential at an outside temperature of -10 °C that is entered on this operating line is transformed to the current composite outside temperature.

At an outside temperature of -10 °C, the flow temperature setpoint is reduced by the set value. At an outside temperature of 20 °C, there will be no more reduction.

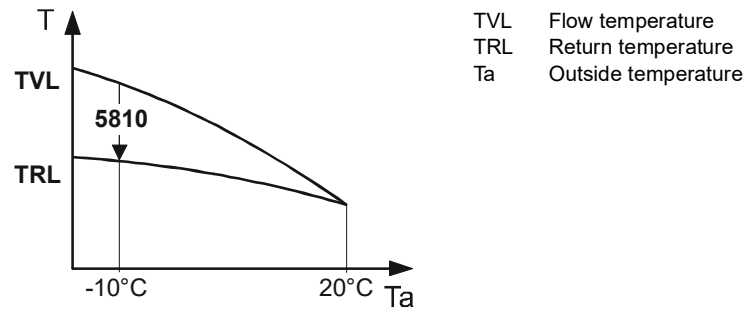

- Important: Instead of entering the correct temperature differential at -10 °C, it is also possible to enter "0" as the temperature differential. In that case, the heating curve must be set for the return temperature setpoint. But this choice only exists for plant without mixing heating circuit.
- Parameter 5810 is only active if there is no buffer storage tank.
- In cooling mode, the parameter has no impact. In the case of control to the return temperature, the cooling curve must be set based on the return temperature setpoint.

Electric immersion heater and heat pump

Selection	Operating line
5805	Location el imm heater flow After flow sensor B21 Before flow sensor B21 Flow desuperheater
5806	Type el imm heater flow None 3-stage 2-stage excluding 2-stage complementary 1-stage
5811	Output el imm heater K25
5813	Output el imm heater K26

Location el imm heater flow

To be able to ensure control and monitoring of the heat pump, parameter "Location el imm heater flow" is to be used to inform the controller about the location of the electric immersion heater.

After flow sensor B21

The electric immersion heater is installed downstream from flow sensor B21. The electric immersion heater has no impact on the information provided by flow sensor B21. If possible, preference should be given to the following layout.

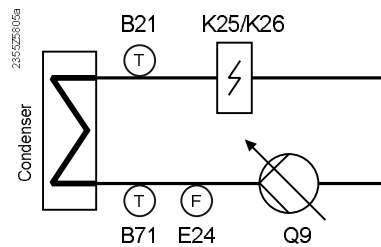

Before flow sensor B21

The electric immersion heater is installed upstream of flow sensor B21. Operation of the electric immersion heater has no impact on the information delivered by flow sensor B21.

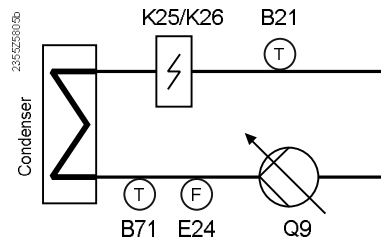

With this layout, flow sensor B21 cannot and will not be used to monitor the heat pump (e.g. maximum switch-off temperature) when the electric immersion heater is on.

For this reason, this variant should be used only if – due to plant layout – the sensor cannot be installed between condenser and electric immersion heater.

Overview enable/switching points for electric immersion heaters K25/K26

	Sensors			5810 ¹⁾	Control of elec. Immersion heaters K25/K26				
	B21	B71	B10		Fühler	Sollwert	Switching differential for... Release integr electric flow (OL2882) and Reset integr electric flow (OL2883)	Location el imm heater flow (OL5805)	Switching differential for... switching points
No demand from storage tank	No	No	No	x	n/a	n/a	n/a	x	n/a
	No	No	Yes	x	B10	TVw	±1°K	After flow sensor B21	±1°K
	No	Yes	No	x	B71	TRLw	±SD/2	Before flow sensor B21	Integral electrical
	No	Yes	Yes	= 0	B71	TRLw	±SD/2	x	±SD/2
				> 0	B10	TVw	±1°K	After flow sensor B21	±1°K
	Yes	No	x	x	B21	TVw	±1°K	Before flow sensor B21	Integral electrical
								= 0	B71
	Yes	Yes	x	> 0	B21	TVw	±1°K	After flow sensor B21	±1°K
Before flow sensor B21								Integral electrical	
Demand from storage tank ²⁾	No	No	No	x	n/a	n/a	n/a	x	Ein
	Yes	x	x	x	B21	TVw	±1°K	After flow sensor B21	±1°K
								Before flow sensor B21	Integral electrical
	No	Yes	No	x	B71	TRLw	±SD/2	x	±SD/2
No	x	Yes	x	B10	TVw	±1°K	After flow sensor B21	±1°K	
							Before flow sensor B21	Integral electrical	

¹⁾"Differential HC at OT -10°C" (OL5810)

²⁾ Heat demand comes from the storage tank (DHW, heating circuit via buffer, forced charging)

TVw = Flow setpoint

TRLw = Return setpoint

SD = "Switching diff return temp" (OL2840)

Sensor states: yes (Sensor available), no (Sensor not available), x (no influence)

Parameter setting: x (no influence)

Result: n/a (not applicable)

Flow desuperheater

When using a hot-gas heat exchanger for DHW charging (see high-temperature charging, parameter 5170 ff.), it is possible to install the electric immersion heater in the flow of the hot-gas heat exchanger. In this case, the electric immersion heater can be used for DHW charging only.

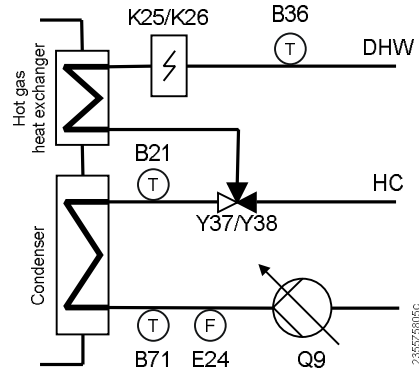

Installation of the electric immersion heater in the flow of the hot-gas heat exchanger (configured with "Flow hot-gas heat exchanger") is possible, but not mandatory. The 2 first positions are possible too (see following layouts).

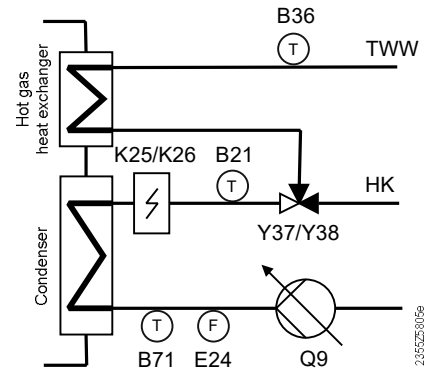
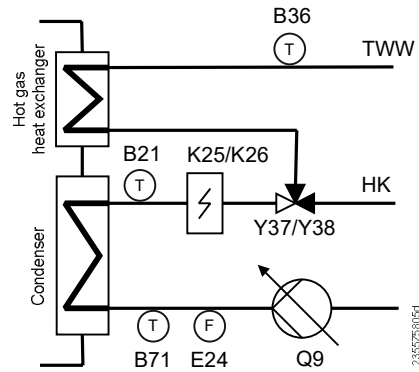

Type el imm heater flow

If both electric immersion heaters (K25/K26) are installed in the flow, "Type el imm heater flow" can be used to select how they shall be controlled.

None

No electric immersion heater available.

(On QX, can be configured as electric immersion heating, but cannot be connected).

3-stage

Used when ...

- the electric immersion heaters have different capacities,
- the electric immersion heaters may be operated simultaneously.

2-stage excluding

Used when ...

- the electric immersion heaters have different capacities,
- the electric immersion heaters must not be operated simultaneously.

2-stage complementary

Used when ...

- both electric immersion heaters have the same capacity,
- the electric immersion heaters may be operated simultaneously.

1-stage

Only one electric immersion heating available.

Must be connected to K25; K26 is switched off.



In the electric immersion heaters are of different capacity, the heater with the greater capacity must be connected to output K26.

Type el imm heater flow	3-stage		2-stage excluding		2-stage complementary		1-stage	
	K25	K26	K25	K26	K25	K26	K25	K26
Output stage								
0	0	0	0	0	0	0	0	0
1	1	0	1	0	1	0	1	0
2	0	1	0	1	1	1	---	---
3	1	1	---	---	---	---	---	---



With "2-stage excluding", both outputs (K25 and K26) are deactivated for 5 seconds when changing from one output stage to the next.

If only one electric immersion heater (K25) is parameterized, it is always considered 1-stage as long as the parameter setting is not set to "none". Even with a setting, for example, of "3-stage", the electric immersion heater is operated a 1-stage, if only K25 is parameterized.

Output el imm heater K25, K26

Defines the output of the electric immersion heaters installed in the heat pump's flow.

The output entered is used to calculate the yearly performance factor.

Acquisition of pressure, acquisition of humidity

<i>Line no.</i>	<i>Operating line</i>
5822	Press acquisition evap H82 None ; With input H1 ; With input H21 module 1 ; With input H21 module 2 ; With input H21 module 3 ; With input H22 module 1 ; With input H22 module 2 ; With input H22 module 3 ; With input H3
5823	Press acquisition cond H83 None ; With input H1 ; With input H2 module 1 ; With input H2 module 2 ; With input H2 module 3 ; With input H21 module 1 ; With input H21 module 2 ; With input H21 module 3 ; With input H22 module 1 ; With input H22 module 2 ; With input H22 module 3 ; With input H3
5826	Press acquisition EVI H86 Same as 5822
5827	Hum acquis air inlet H91 Same as 5823

Press acquisition evap H82

Selection of input Hx to be used for acquiring the evaporation pressure for the superheat controller and for (minimum and maximum) pressure supervision.

Press acquisition cond H83

Selection of Hx input to be used for acquiring the condensation pressure.

Press acquisition EVI H86

Selection of Hx input to be used for acquiring the evaporation pressure for vapor injection.

Hum acquis air inlet H91

Selection of input Hx to be used for acquiring the humidity at the air inlet.

Solar

<i>Line no.</i>	<i>Operating line</i>
5840	Solar controlling element Charging pump Diverting valve
5841	External solar exchanger Jointly DHW storage tank Buffer storage tank

Solar controlling element In place of a collector pump and diverting valves for integrating the storage tanks, the solar plant can also be operated with charging pumps.

When using a diverting valve, the flow can only pass through one heat exchanger at a time. Only alternative operation is possible.

When using a charging pump, the flow can pass through all heat exchangers at the same time. Parallel or alternative operation is possible.

External solar exchanger In the case of solar plants with 2 storage tanks, it must be selected whether the external heat exchanger shall be used for DHW and as a buffer storage tank, or for one of the two only.

Buffer storage tank

<i>Line no.</i>	<i>Operating line</i>
5870	Combi storage tank No Yes

No

If, hydraulically speaking, a combi storage tank is used, a partial diagram "Buffer" and partial diagram "DHW" become active in the device software. This means that with the combi storage tank, the functions are performed the same way as if buffer storage tank and DHW storage tank were separate.

Yes

The DHW request is always forwarded to the buffer storage tank, regardless of the setting for DHW storage tank with buffer storage tank. DHW pump Q3 is activated only when the temperature at buffer storage tank sensor B4 also lies under the DHW setpoint minus the switching differential.

During heat transfer, the DHW controlling element (Q3) is not switched on. The system allows a certain waiting time for the temperatures to level out.

Electric immersion heater and buffer storage tank

<i>Selection</i>	<i>Operating line</i>
5872	Output el imm heater K16

Defines the output of electric immersion heater K16 installed in the buffer or combi storage tank. The output entered is used to calculate the yearly performance factor.

The use of relay outputs 1...5 and triac output ZX6 can be individually defined.

Line no.	Operating line
5890... 5903	<p>Relay output QX1...3, Triac output ZX4, QX5...13</p> <p>None Compressor 2 K2 Process revers valve Y22 Hot-gas temp K31 EI imm heater 1 flow K25 EI imm heater 2 flow K26 Div valve cool source Y28 System pump Q14 Cascade pump Q25 Heat gen shutoff valve Y4 EI imm heater DHW K6 Circulating pump Q4 St tank transfer pump Q11 DHW interm circ pump Q33 DHW mixing pump Q35 Collector pump Q5 Collector pump 2 Q16 Solar pump ext exch K9 Solar ctrl elem buffer K8 Solar ctrl elem swi pool K18 EI imm heater buffer K16 Cons circuit pump VK1 Q15 Cons circuit pump VK2 Q18 Swimming pool pump Q19 Heat circuit pump HC3 Q20 2nd pump speed HC1 Q21 2nd pump speed HC2 Q22 2nd pump speed HC3 Q23 Div valve HC/CC1 Y21 Air dehumidifier K29 Heat request K27 Refrigeration request K28 Alarm output K10 Time program 5 K13 Heat circuit pump HC1 Q2 DHW ctrl elem Q3 Source pump Q8/fan K19 Condenser pump Q9 Compressor stage 1 K1 Suppl source control K32 Heat circuit pump HC2 Q6 Instant WH ctrl elem Q34 Common flow valve Y13 Div valve HC/CC2 Y45 Div valve HC/CC3 Y46 Cooling circ pump CC1 Q24 Cooling circ pump CC2 Q28 Cooling circ pump CC3 Q29 Solid fuel boiler pump Q10 Flue gas relay K17 Assisted firing fan K30 Crankcase heater K40 Drip tray heater K41 Valve evaporator K81 Valve EVI K82 Valve injection capillary K83 dT controller 1 K21 dT controller 2 K22 Ventilation fan 1 K51 Ventilation fan 2 K52 Ventilation fan 3 K53 Ventilation bypass 1 K54 Ventilation bypass 2 K55 Ventilation bypass 3 K56 Outside air temp contr Q17 Source int circ pump Q81 Source int circ div Y81 DHW heat pump K33 System pump 2 Q44 Div valve cooling cond Y27 Div valve cooling flow Y29 Cond reversing valve Y91 Buffer reversing valve Y47 Status info heating K42 Status info cooling K43 Status info DHW charg K44 Heat/cool circ pump 1 Q2 Heat/cool circ pump 2 Q6 Heat/cool circ pump 3 Q20 Status info generation K45 Fault info generation K46</p>

Relay outputs QX...None

The relay output is not assigned any function. The relay is deenergized.

Compressor 2 K2

The signal is used to control a diverting valve.

Process revers valve Y22

Control of process reversing valve Y22. The process reversing valve is required for changeover from heating to cooling mode and for the heat pump's "Defrost" function.

Hot-gas temp K31

The relay is energized when a connected hot-gas temperature sensor (B81 or B82) exceeds "Setpoint hot-gas temp" (line 2849), and is deenergized when the temperature drops by one switching differential (line 2850) below the setpoint. The type of contact (line 2851) can be selected.

EI imm heater 1 flow K25

 WARNING	Electric immersion heaters must be fitted with a safety limit thermostat.
--	---

The relay is used to control an electric immersion heater installed in the flow (K25) or, in the case of a 2-stage electric immersion heater, to control the first stage.

EI imm heater 2 flow K26

 WARNING	Electric immersion heaters must be fitted with a safety limit thermostat.
--	---

The relay is used to control the second stage of an electric immersion heater installed in the flow (K26).

Div valve cool source Y28

Control of optional diverting valve Y28 in the source circuit. For changeover to passive cooling.

System pump Q14

The connected pump serves as a system pump for supplying heat to other consumers.

The system pump is put into operation when one of consumers calls for heat. If there is no request for heat, the pump is deactivated followed by overrun.

Cascade pump Q25

Common pump for all generators in a cascade.

Heat gen shutoff valve Y4

If the buffer storage tank holds a sufficient amount of heat, the consumers can draw their heat from it (no need to put the heat sources into operation).

Automatic generation lock locks the generators and hydraulically disconnects them from the rest of the plant with the help of a diverting valve Y4.

This means that the heat consumers draw the energy they require from the buffer storage tank and wrong circulation through the generators is prevented.

EI imm heater DHW K6



WARNING

Electric immersion heaters must be fitted with a safety limit thermostat.

Using the connected electric immersion heater, the DHW can be charged according to "EI imm heater optg mode" (line 5660) and "EI immersion heater release" (line 5061).



"EI imm heater optg mode" must be appropriately set.

(DHW) Circulating pump Q4

The connected pump serves as a DHW circulating pump. The time schedule for the circulating pump can be set and adjusted via "Circulating pump release" (line 1660). "Circulating pump cycling" (line 1661) and "Circulation setpoint" (line 1663) can be set.

St tank transfer pump Q11

If the temperature level of the buffer storage tank is high enough, the DHW storage tank can be charged by the buffer storage tank.

Depending on the hydraulic circuit, the transfer of heat can be effected either with charging pump Q3 or transfer pump Q11, which is specifically parameterized for this function.

The parameter settings for "Transfer strategy" (line 5130), "Comparison temp transfer" (line 5131) and "Transfer boost" (line 5021) apply to both plant configurations.

If a transfer pump Q11 is installed, charging pump Q3 is only used for recharging by the generator.



Heat transfer with Q11 is effected independently of function "With buffer" (line 5090).



If a combi storage tank is used (see line 5870) and a transfer pump Q11 is defined, the "Transfer" function is active as well.

DHW interm circ pump Q33

Charging pump with DHW storage tank using an external heat exchanger.

DHW mixing pump Q35

Separate pump for storage tank circulation during the time the "Legionella" function is active.

Collector pump Q5

For control of the collector pump of the solar collector circuit.

Collector pump 2 Q16

For control of the circulating pump of a second solar collector circuit.

Solar pump ext exch K9

For the external heat exchanger, "Solar pump ext exch K9" must be selected at the multifunctional relay output (QX).

If both a DHW and a buffer storage tank are installed, "External solar exchanger" (line 5841) must be set as well.

Solar ctrl elem buffer K8

If several heat exchangers are used, the buffer storage tank must be set at the respective relay output and, in addition, the type of solar controlling element must be defined ("Solar controlling element", line 5840).

Solar ctrl elem swi pool K18

If several heat exchangers are used, the swimming pool must be set at the respective relay output and, in addition, the type of solar controlling element needs to be defined ("Solar controlling element", line 5840).

EI imm heater buffer K16

 WARNING	Electric immersion heaters must be fitted with a safety limit thermostat.
--	---

The relay is used for control of an electric immersion heater installed in the buffer storage tank.

Cons circuit pump VK1 Q15

Consumer circuit pump 1 can be used for an additional consumer.

Together with the respective external request for heat/cooling energy at input Hx, the application is suited for an air heating coil/air cooling coil, for instance.

Cons circuit pump VK2 Q18

Consumer circuit pump 2 can be used for an additional consumer.

Together with the respective external request for heat/cooling energy at input Hx, the application is suited for an air heating coil/air cooling coil, for instance.

Swimming pool pump Q19

The connected pump is used for the swimming pool circuit. The respective heat request is made via one of the Hx inputs.

Heat circuit pump HC3 Q20

The relay is used for the control of heating circuit pump 3.

2nd pump speed HC1 Q21 /HC2 Q22/HC3 Q23

This function facilitates the control of a 2-speed heating circuit pump, allowing the pump's capacity to be lowered in "Reduced" mode (e.g. during night setback). In that case, after pump speed 1, pump speed 2 is switched on as follows:

<i>1.Speed</i> <i>Output Q2/Q6/Q20</i>	<i>2.Speed</i> <i>Output Q21/Q22/Q23</i>	<i>Pump state</i>
Off	Off	Off
On	Off	Part load
On	On	Full load

Div valve HC/CC1 Y21 / HC/CC2 Y45 / HC/CC3 Y46

Control of the diverting valve for cooling. This necessitates a 4-pipe system.

The diverting valve for cooling is required in the case of a jointly used heating and cooling flow for changeover from heating to cooling when the heat pump is used not only for heating but also and **simultaneously** for cooling.

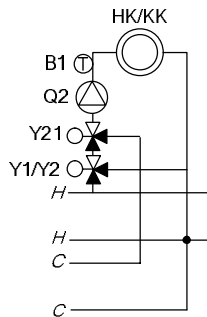

Example:
4-pipe system

Air dehumidifier K29

When room humidity rises, an external dehumidifier can be switched on. In this case, a humidity sensor must be connected to input Hx.

Heat request K27

Release relay K27 is used together with control relay K32 for flow temperature control of the supplementary source (see lines 3690...3755).

Refrigeration request K28

Output K28 is activated whenever there is a request for refrigeration. This can be used to switch on an external refrigeration machine. .

In the case of the device with address 1, a request for refrigeration from the system can also activate output K28. For that, on operating page "LPB system", "Refrigeration request" (line 6627) must be set to "Centrally".

Alarm output K10

If a fault occurs in the controller or the system, one of the alarm relays delivers a signal. The relevant contact makes with a delay (line 6612).

When the fault is corrected, that is, when the error message is no longer pending, the contact opens with no delay.



If the fault cannot immediately be rectified, it is still possible to reset the alarm relay. This is made via operating line 6710.

Time program 5 K13

The relay switches any connected plant component at the points in time set in time program 5 (lines 601...616).

Heat circuit pump HC1 Q2

The connected pump serves as a circulating pump for heating circuit 1.

DHW ctrl elem Q3

Depending on the hydraulic system in use, output Q3 serves for control of a connected DHW charging pump or diverting valve.

Source pump Q8/fan K19

Source pump for brine-to-water or water-to-water heat pumps.
Fan for air-to-water heat pumps.

Condenser pump Q9

The relay is used to control the condenser pump.

Compressor stage 1 K1

The relay is used for control of the first compressor stage.

Suppl source control K32

Control relay K32 is used together with release relay K32 for control of the supplementary source (see lines 3690...3755).

The control relay provides 2-position control of the supplementary source to the setpoint of the selected control sensor.

Heat circuit pump HC2 Q6

The connected pump serves as circulating pump for heating circuit 2.

Instant WH ctrl elem Q34

The connected pump serves as circulating pump for the instantaneous water heater.

Common flow valve Y13

Switches the heating circuit connection at the combi storage tank between top and middle.

Cooling circ pump CC1 Q24/CC2 Q28 / CC3 Q29

The connected pump serves as a circulating pump for heating circuit 1/2.

Solid fuel boiler pump Q10

Connection of a solid fuel boiler requires a circulating pump for the boiler circuit.

Crankcase heater K40

The relay is used for the crankcase heater of the compressor.

Drip tray heater K41

The relay is used for the drip tray heater of the evaporator.

Valve evaporator K81

The relay is used for the magnetic valve of the superheat controller.

Valve EVI K82

The relay is used for the magnetic valve of vapor injection.

Valve injection capillary K83

The relay is used for the magnetic valve of saturated vapor injection.

dT controller 1 K21, K22

Relays K21 and K22 are used for the delta-T-controllers.

Ventilation fan for zone 1 / 2 / 3

The relay switches ventilation fan 1 / 2 / 3 (K51 / K52 / K53)

Ventilation bypass for zone 1 / 2 / 3

The relay switches ventilation bypass 1 / 2 / 3 (K54 / K55 / K56)

Outside air temp contr Q17

The relay is used for outside air temperature cont Q17.

Source int circ pump Q81

Circulating pump in the source intermediate circuit. Provides extra functionality in connection with:

- The defrost process with air-to-water heat pumps: When defrosting with the compressor (process reversal), Q81 remains activated while the fan (K19) is switched off.
- Brine-water and water-water heat pumps with common source pump Q8: Q81 is controlled individually by each HP.

Source int circ div Y81

Diverting valve in the source intermediate circuit. For plants using extraneous heat to defrost (see parameter 2955).

Y81 is activated during the defrost phase (see diagram below) where in the other cases defrosting is ensured by the compressor (process reversal).

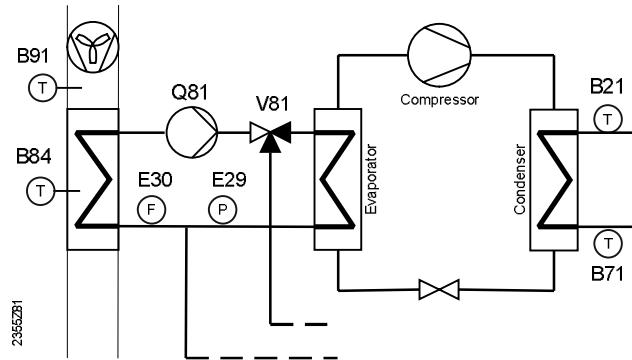

Another application are plants that use both geothermal energy and air as a source. In this type plant, Y81 is used to disconnect the geothermal probe during the defrost process with the compressor (no diagram).

DHW heat pump K33

For the control of an external DHW heat pump.

System pump 2 Q44

The connected pump serves as a system pump for the supply of cooling energy to other consumers in a 4-pipe system.

The system pump is put into operation when one of consumers calls for cooling energy. If there is no request for refrigeration, the pump is deactivated followed by overrun.

Div valve cooling cond Y27

If the heat pump is configured for active cooling (process reversal), a 4-pipe system requires a "Div valve cooling cond Y27" to divert the cooling energy to common flow 2. The valve is switched on as soon as the heat pump switches to cooling mode, and is switched off again when there is a request for heat.

Div valve cooling flow Y29

Common diverting valve of all cooling circuits between heating and cooling.

To switch over consumers with a 2-pipe cooling system to the common cooling flow (2) of the generators, a free relay for function "Div valve cooling flow Y29" must be configured.

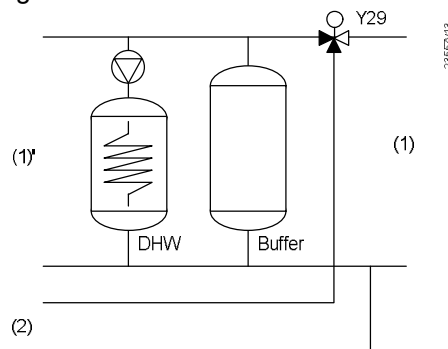

(1) Common heating/cooling flow (1)' Common heating flow (2) Common cooling flow

Diverting valve Y29 is switched on when there is at least one valid refrigeration request on the consumer side (common heating and cooling flow) and when at least one valid refrigeration generator is able to supply cooling energy via the common cooling flow.



The diverting valve must be installed on the consumer side, upstream of the buffer storage tank and upstream of the DHW storage tank.

Cond reversing valve Y91

Changes the direction of flow in cooling mode through the heat pump's condenser.

Buffer reversing valve Y47

Switches over the connections of the buffer storage tank in cooling mode (top/bottom).

Status info heating K42

Output of current operating state for heating mode (space heating), e.g. to an external energy allocation system.

Status info cooling K43

Output of current operating state for cooling mode, e.g. to an external energy allocation system.

Status info DHW charg K44

Output of current operating state for DHW charging, e.g. to an external energy allocation system.

Heating circuit/cooling circuit pumps HC/CC 1 Q2, HC/CC2 Q6, HC/CC3 Q20

The connect pump is the heating circuit/cooling circuit pump for heating circuit/cooling circuit 1 / 2 / 3.

Status info generation K45

Output of present operating message from the heat pump to K45.

Relay K45 is switched on, if the HP is operating (regardless of compress state).

Fault info generation K46

Output of the present fault message from the heat pump to K46.

Relay K46 is switched on, if the HP has a fault.

Invalid settings

The following settings are invalid and do not provide any functions:

Flue gas relay K17, Assisted firing fan K30

Function output
ZX4-Mod

Line no.	Operating line
5909	Function output ZX4-Mod None Source pump Q8/fan K19 DHW pump Q3 DHW interm circ pump Q33 Heat circuit pump HC1 Q2 Heat circuit pump HC2 Q6 Heat circuit pump HC3 Q20 Collector pump Q5 Solar pump ext exch K9 Solar pump buffer K8 Solar pump swi pool K18 Collector pump 2 Q16 Instant WH pump Q34 Solid fuel boiler pump Q10 Condenser pump Q9 Heat/cool circ pump 1 Q2 Heat/cool circ pump 2 Q6 Heat/cool circ pump 3 Q20 Compressor modulation Ventilation fan 1 K51 Ventilation fan 2 K52 Ventilation fan 3 K53

This setting determines the pump or fan to be modulated.
Modulation is effected via triac control (full-wave control).

CAUTION	Observance of the minimum and maximum loads according to the technical data is mandatory.
----------------	---

The settings made via parameter 5909 take priority over those made via parameter 5894.

BX basic unit

Line no.	Operating line
5930, 5931, 5942, 5943	Sensor input BX1, BX2, BX13, BX14 None Buffer sensor B4 Buffer sensor B41 Collector sensor B6 DHW sensor B31 Hot-gas sensor B82 Refrig sensor liquid B83 DHW charging sensor B36 DHW outlet sensor B38 DHW circulation sensor B39 Swimming pool sensor B13 Collector sensor 2 B61 Solar flow sensor B63 Solar return sensor B64 Buffer sensor B42 Common flow sensor B10 Cascade return sensor B70 Special temp sensor 1 Special temp sensor 2 DHW sensor B3 HP flow sensor B21 HP return sensor B71 Hot-gas sensor B81 Outside sensor B9 Source inlet sensor B91 Source outl sens B92/B84 Room sensor B5 Room setp readjustment 1 Room sensor B52 Room setp readjustment 2 Room sensor B53 Room setp readjustment 3 Flue gas temp sensor B8 Solid fuel boiler sensor B22 Solid fuel boil ret sens B72 ---Suction gas sensor B85 Suction gas sensor EVI B86--- Evaporation sensor EVI B87 DHW prim contr sensor B35 Outside air sensor B19 Common flow sensor 2 B11 Common return sensor B73 Source int circ flow B93 Source int circ return B94 Suction gas sensor cool B88

The settings for the sensor inputs determine the basic plant diagrams and extra functions. Refer to chapter "Application diagrams".

Line no.	Operating line
5932 ... 5941	Sensor input BX3...12 None Buffer sensor B4 Buffer sensor B41 Collector sensor B6 DHW sensor B31 Hot-gas sensor B82 Refrig sensor liquid B83 DHW charging sensor B36 DHW outlet sensor B38 DHW circulation sensor B39 Swimming pool sensor B13 Collector sensor 2 B61 Solar flow sensor B63 Solar return sensor B64 Buffer sensor B42 Common flow sensor B10 Cascade return sensor B70 Special temp sensor 1 Special temp sensor 2 DHW sensor B3 HP flow sensor B21 HP return sensor B71 Hot-gas sensor B81 Outside sensor B9 Room sensor B5 Room setp readjustment 1 Room sensor B52 Room setp readjustment 2 Room sensor B53 Room setp readjustment 3 Flue gas temp sensor B8 Solid fuel boiler sensor B22 Solid fuel boil ret sens B72 DHW prim contr sensor B35 Outside air sensor B19 Common flow sensor 2 B11 Common return sensor B73

The settings for the sensor inputs determine the basic plant diagrams and extra functions. Refer to chapter "Application diagrams".

The operating lines determine the function of input H1 or H3.

Line no.	Operating line
5950	Function input H1
5960	None Op'mode change zones+DHW Optg mode changeover DHW Op'mode changeover zones Op'mode changeover zone 1 Op'mode changeover zone 2 Op'mode changeover zone 3 Error/alarm message Consumer request VK1 Consumer request VK2 Release swi pool source heat Release swi pool solar Operating level DHW Operating level HC1 Operating level HC2 Operating level HC3 Room thermostat HC1 Room thermostat HC2 Room thermostat HC3 DHW flow switch Pulse count Dewpoint monitor Flow temp setp incr hygro Swi-on command HP stage 1 Swi-on command HP stage 2 Status info suppl source Charg prio DHW sol fuel boil Ventilation switch 1 Ventilation switch 2 Ventilation switch 3 Flow measurement Hz Consumer request VK1 10V Consumer request VK2 10V Pressure measurement 10V Humidity measurement 10V Room temp 10V Flow measurement 10V Temp measurement 10V Air quality measurement 10V

Zones 1, 2, 3

Changeover of operating mode (digital)

The current operating mode of the respective zone is changed to the setting made under "Operating mode changeover" (Protection, Reduced, Comfort, Automatic) when contact Hx closes.

For heating and cooling, the changeover is possible to one of the following operating modes: Protection, reduced, comfort, automatic.

For ventilation, changeover is possible to the following operating modes: Off, stage 1, stage 2, stage 3.

The settings are made on the following operating lines:

- Line 900 "Optg mode changeover" for heating circuit 1.
- Line 969 "Optg mode changeover" for cooling circuit 1.
- Line 995 "Optg mode changeover" for ventilation 1
- Line 1200 "Optg mode changeover" for heating circuit 2.
- Line 1269 "Optg mode changeover" for cooling circuit 2
- Line 1295 "Optg mode changeover" for ventilation 2
- Line 1500 "Optg mode changeover" for heating circuit 3.
- Line 1569 "Optg mode changeover" for cooling circuit 3
- Line 1595 OL 1295 "Optg mode changeover" for ventilation 3 line
- Line 1680 "Optg mode changeover" for DHW heating.

When the contact opens, the various consumers resume the operating mode initially selected.



The contact serves for remote control of the operating mode (e.g. via a remote telephone switch). When the contact is closed, local operation of the operating mode is locked.

DHW

The current operating mode of DHW charging changes to the setting made under "Optg mode changeover" (off, on) when contact Hx is closed. DHW charging is only changed when using setting "HCs+DHW" or "DHW". When DHW charging is deactivated, frost protection remains ensured.

Error/alarm message (digital)

By closing input Hx, an external error message can be forwarded and displayed.

Consumer request VK1 and VK2 (digital)

When input Hx closes, a consumer request (heating or cooling) is forwarded to the controller. The value of the request is set on operating line 1859 or 1909.



A voltage-proportional temperature request is made with settings "Consumer request VK1 10V" and "VK2 10V".

Release swi pool source heat (digital)

When input Hx closes (e.g. via a manual switch), swimming pool heating is released. Heating is provided by the generator.

Release swi pool solar (digital)

When using **1** Hx input, solar swimming pool heating can be released from a remote location (e.g. via a manual switch).

When using **2** Hx inputs, the charging priority of swimming pool heating against the storage tanks can be defined (for function description, refer to "Charging priority solar", line 2065).

Operating level DHW

When the contact closes, the operating level changes to "Nominal".

The settings can be used, for example, for control by an external time switch.

Operating level HC1, HC2, HC3 (digital)

If the selected heating circuit operates in Automatic mode and the respective contact is closed, a change to the Reduced level is made.

The setting can be used to control the heating circuits via an external time switch, for instance.

Room thermostat HC1, HC2, HC3

A connected room thermostat sends the Hx input a signal "Demand" or "No demand".

If there is demand for heat in Comfort mode, the room thermostat forwards a heat request for the respective heating circuit to ensure control to the flow temperature setpoint selected under "Flow temp setpoint room stat" (line 742 for HC1, 1042 for HC2, and 1342 for HC3).

DHW flow switch (digital)

A DHW flow switch is connected to the respective input; it detects flow to the point of consumption.

This enables the controller to detect the start and end of DHW consumption.

Pulse count (pulse input)

Pulse count input for the connection of electricity, gas, heat or flow meters.



Parameter "Contact type Hx" has no meaning in terms of pulse counting.

Dewpoint monitor (digital)

To detect the formation of condensation in the cooling circuit, a dewpoint monitor can be connected to input Hx.

If the dewpoint monitor trips, the cooling circuit is immediately switched off.

The cooling circuit is released when the dewpoint monitor becomes inactive and an adjustable locking time (line 946) has elapsed.

Flow temp setp incr hygro (digital)

To prevent the formation of condensation due to high indoor air humidity, a hygostat can be connected to input Hx.

If the hygostat trips, the flow temperature setpoint is increased by the fixed value of "Flow temp setp incr hygro" (line 947).

Swi-on command HP stage 1 and stage 2 (digital) (heating only)

By closing a contact connected to this input (e.g. by an external controller or a superposed building automation and control system), the heat pump is put into operation. It remains in operation until contact Hx opens again or until the heat pump is shut down by a safety function (e.g. due to high-pressure, low-pressure, or hot-gas temperature).



Internal requests and requests forwarded via bus are suppressed. Minimum off times are observed. The prerun and overrun times of the condenser pump and source pump are taken into account. Defrosting is normally possible.

Status info suppl source (digital)

The contact's closing informs the controller that the supplementary source has been successfully started. Also refer to setting "Delay lockout position" (line 3755).

Charg prio DHW sol fuel boil

When the contact closes, the DHW storage tank is charged by the solid fuel boiler.

Ventilation switch 1, 2, 3

By closing the contact, ventilation of the corresponding zone is driven to a predefined stage (OL 997, 1297, 1597).

The state is maintained as long as the switch is active, at a minimum for the "Period ventilation switch" (OL 996, 1296, 1596).

Flow measurement Hz (frequency input)

The controller receives a signal for the flow measured.

The respective flow is calculated via the linear characteristic which is defined by 2 fixed points (input value 1/function value 1 and input value 2/function value 2).

Consumer request VK1 10V and **Consumer request VK2 10V** (analog input)

The controller receives a voltage signal (DC 0...10 V) for the heat/refrigeration demand (flow temperature) of consumer circuit 1 or 2.

The required flow temperature is calculated via the linear characteristic which is defined by 2 fixed points (input value 1/function value 1 and input value 2/function value 2).



A constant temperature request via contact is made with settings "Consumer request VK1" and "VK2".

Pressure measurement 10V (analog input)

The controller receives a voltage signal (DC 0...10 V) for the pressure.

The respective flow is calculated via the linear characteristic which is defined by 2 fixed points (input value 1/function value 1 and input value 2/function value 2).

Humidity measurement 10V (analog input)

The controller receives a voltage signal (DC 0...10 V) for the relative humidity.

The respective humidity is calculated via the linear characteristic which is defined by 2 fixed points (input value 1/function value 1 and input value 2/function value 2).

Room temp 10V (analog input)

The controller receives a voltage signal (DC 0...10 V) for the room temperature.

The room temperature (together with the relative room humidity) is used primarily to calculate the dewpoint in the cooling circuit.

If there is no room unit with a room sensor connected for heating/cooling circuit 1 (via BSB), the room temperature acquired via Hx is also used for space heating/space cooling 1 (compensation variant and room influence).

The respective room humidity value is calculated via the linear characteristic which is defined by 2 fixed points (input value 1/function value 1 and input value 2/function value 2).

Flow measurement 10V (analog input)

The controller receives a voltage signal (DC 0...10 V) for the flow measured.

The respective flow is calculated via the linear characteristic which is defined by 2 fixed points (input value 1/function value 1 and input value 2/function value 2).

Temp measurement 10V (analog input)

The controller receives a voltage signal (DC 0...10 V) for the acquired temperature.

The respective temperature is calculated via the linear characteristic which is defined by 2 fixed points (input value 1/function value 1 and input value 2/function value 2).



Usage of the acquired temperature is defined via parameter "Temperature sensor H1 or H3" (lines 5957 and 5967) of the controller.

Air quality measurement 10V

The controller receives a voltage signal (DC 0...10 V) for measured air quality.



The use of measured air quality is described at OL 6296.

Contact type: Contacts H1, H3

Line no.	Operating line
5951	Contact type H1, H3
5961	NC NO

Contact type H1, H3

NC

The contact is normally closed and must be opened to activate the selected function.

NO

The contact is normally open and must be closed to activate the selected Hx function.

Input/function value H1, H3

Line no.	Operating line
5953, 5963	Input value 1 H1, H3
5954, 5964	Function value 1 H1, H3
5955, 5965	Input value 2 H1, H3
5956, 5966	Function value 2 H1, H3

Input value 1
 Function value 1
 Input value 2
 Function value 2
 Example of consumer circuit request VK1 10V

These settings are available for each Hx input.

The linear characteristic is defined via 2 fixed points. The setting is made with 2 pairs of parameters for input value and function value.

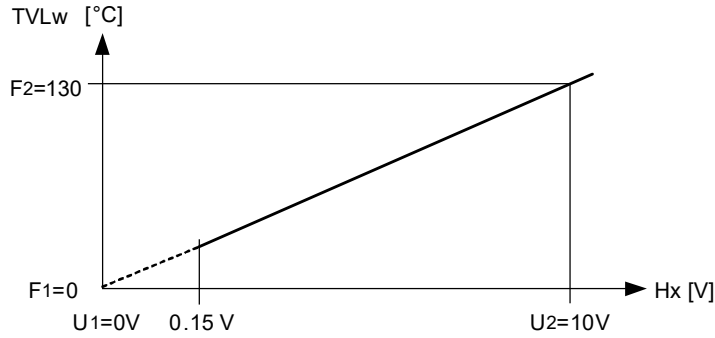

TVLw Flow temperature setpoint
 Hx Input value at Hx
 U1 Input value 1
 F1 Function value 1
 U2 Input value 2
 F2 Function value 2

i If the input signal drops below the limit value of 0.15 V, the heat request is invalid and therefore inactive.

Example of pressure measurement 10 V

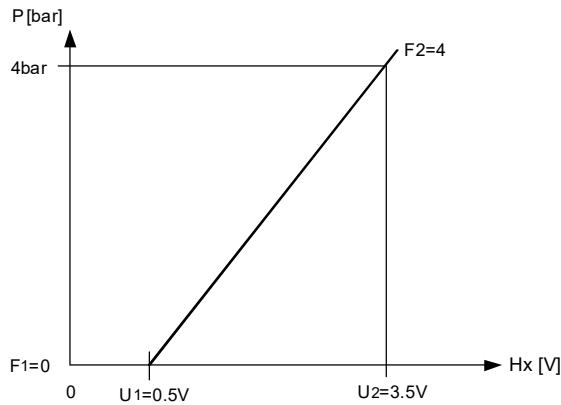

B Pressure value
 Hx Input value at Hx
 U1 Input value 1
 F1 Function value 1
 U2 Input value 2
 F2 Function value 2

i If the measured value lies below 0.15 V, it is regarded invalid.

Example of Humidity measurement 10V

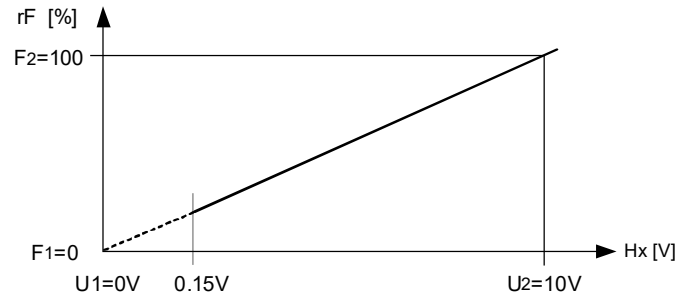

- r.h. Relative humidity
- Hx Input value at Hx
- U1 Input value 1
- F1 Function value 1
- U2 Input value 2
- F2 Function value 2



If the measured value lies below 0.15 V, it is regarded invalid.

Example of flow measurement Hz

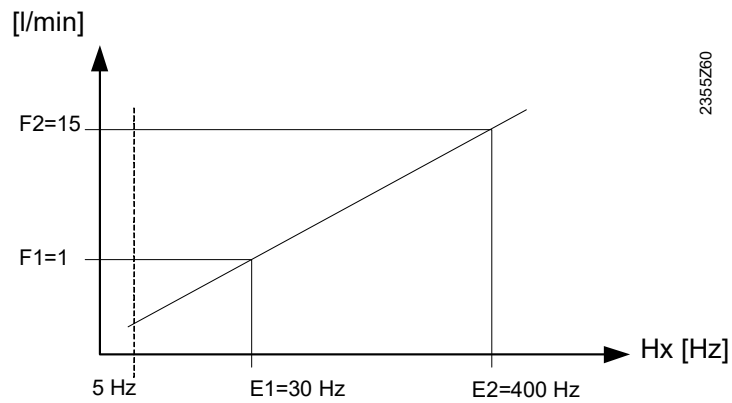

- l/min Flow rate in liters/minute
- Hx Input value at Hx
- E1 Input value 1 [Hz]
- F1 Function value 1
- E2 Input value 2 [Hz]
- F2 Function value 2

Example of flow measurement 10 V

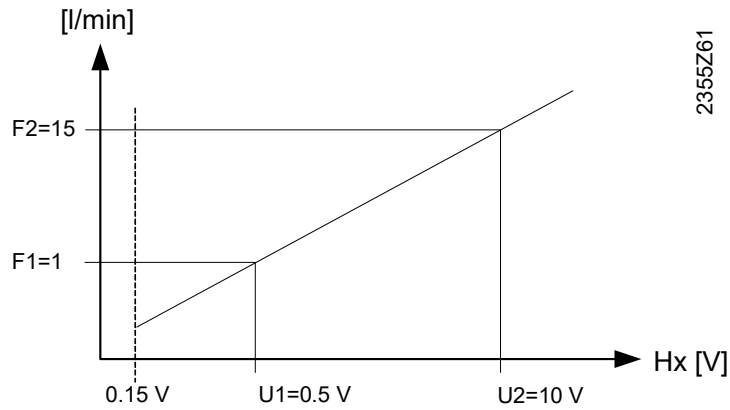

2355Z61

- l/min Flow rate in liters/minute
- Hx Input value at Hx
- E1 Input value 1
- F1 Function value 1
- E2 Input value 2
- F2 Function value 2



If the measured value lies below 0.15 V (or 5 Hz), it is seen as "No flow".

Temperature sensors at H1 and H3

Line no.	Operating line
5957, 5967	Temperature sensor H1, H3 None Solar flow sensor B63 Solar return sensor B64 HP flow sensor B21 HP return sensor B71

Defines the temperature acquired by the sensor connected to input H1 or H3. The controller uses the acquired temperature to control the respective plant component.

EX basic unit

This operating line is used to define the function of inputs Ex (230 V).

Input EX1...EX4, EX9...EX11

Line no.	Operating line
5980... 5986, 5996... 5998	Function input EX1...4, Function input EX9...11 None Electrical utility lock E6 Low-tariff E5 Overload compressor 2 E12 Overload source E14 Pressure switch source E26 Flow switch source E15 Flow switch consumers E24 Manual defrost E17 Common fault HP E20 Fault soft starter E25 Low-pressure switch E9 High-pressure switch E10 Overload compressor 1 E11 Error/alarm message Mains supervision E21 Fault soft starter 2 E27 Pressure diff defrost E28 Pres sw source int circ E29 Flow sw source int circ E30 Smart grid E61 Smart grid E62 Low-pressure switch 2 E31 High-pressure switch 2 E32 Defrost message E33 Photovoltaics E64 SHC error message E34 SHC 2 error message E35

Input EX5...EX7

Line no.	Operating line
5988... 5992	Function input EX5...7 None Electrical utility lock E6 Low-tariff E5 Overload compressor 2 E12 Overload source E14 Pressure switch source E26 Flow switch source E15 Flow switch consumers E24 Manual defrost E17 Common fault HP E20 Fault soft starter E25 3-phase current Low-pressure switch E9 High-pressure switch E10 Overload compressor 1 E11 Error/alarm message Mains supervision E21 Fault soft starter 2 E27 Pressure diff defrost E28 Pres sw source int circ E29 Flow sw source int circ E30 Smart grid E61 Smart grid E62 Low-pressure switch 2 E31 High-pressure switch 2 E32 Defrost message E33 Photovoltaics E64 SHC error message E34 SHC 2 error message E35

None

Activation of input Ex has no impact.

Electrical utility lock E6

Takes an external locking signal (e.g. from the electrical utility) for the heat pump and locks the heat pump. If, in the case of air-to-water heat pumps, locking occurs during defrost, the controller completes the defrost process before locking the heat pump. Electric immersion heaters are locked during the electrical utility lock.

Low-tariff E5

The low-tariff signal delivered by the electrical utility can be routed via an Ex input. When the input is activated, forced charging of the buffer storage tank is triggered.



The point in time for forced storage tank charging can also be set as a fixed time on operating lines 4711 and 4712.

Overload source E14

Takes the overload message delivered by the source pump/fan. When the contact closes, the controller switches the heat pump off. For the heat pump to resume operation, the minimum off time must have elapsed.

If "Overload source" responds several times within the preset "Duration error repetition", the controller locks the heat pump. Operation can only be resumed by making a reset.

Pressure switch source E26

Takes the signal delivered by pressure switch source. If, during source pump operation, the contact closes for at least 3 seconds, preselected monitoring (Always | With source operation | According to heat source) is active and the prerun time has elapsed, the heat pump is shut down.

When "Min off time" has elapsed, the heat pump is switched on again. If the pressure switch trips again within "Duration error repetition", the heat pump initiates lockout and operation can only be resumed by making a reset.

Flow switch source E15

Takes the signal delivered by flow switch source. If, during source pump operation, the contact closes for at least the preset delay time (line 2895), preselected monitoring (always or in heating mode only) is active and the prerun time has elapsed, the heat pump is shut down.

When "Min off time" has elapsed, the heat pump is switched on again. If the flow switch trips again within "Duration error repetition", the heat pump goes to lockout and can only resume operation with a reset.

Flow switch consumers E24

Takes the signal delivered by flow switch consumers.

The flow switch is active only when the condenser pump runs and the prerun time has elapsed. The compressor is not switched on when, on completion of the prerun time and the preset delay time (line 2895), the flow switch signal is pending.

When "Min off time" has elapsed, the heat pump is switched on again. If the flow switch trips again within "Duration error repetition", the heat pump goes to lockout. Operation can only be resumed by making a reset.

Manual defrost E17

Manual defrost is triggered by activating the appropriately defined Ex input.

Common fault HP E20

Takes a common fault and sets the heat pump to the fault state.

For the heat pump to be switched on again, the common fault must disappear and "Min off time" (line 2843) must have elapsed.

Fault soft starter E25

Takes the fault status signal delivered by an external compressor soft starter.

In the event of an active fault, the controller switches the compressor off.

When the fault status message is no longer present, the heat pump is released again.

3-phase current

For monitoring the 3-phase current, the 3 phases must be connected to inputs Ex5, Ex6 and Ex7 in the correct order (L1, L2, and L3).

The controller monitors the correct temporal order of the 3 phases. Any phase asymmetry, phase interruption or too low rated voltage of one or several phases is regarded as a 3-phase error.

If the 3-phase error is continuously present during the period of time set under "Delay mains fault" (line 2894), the compressor is shut down for the minimum off time. The controller delivers status message "355:3-ph curr asymmetric".

If the 3-phase error occurs again within "Duration error repetition" (line 2889) for at least the delay time, the heat pump initiates lockout, if the preselected permitted number of faults have been exceeded. The controller delivers error message "355:3-ph curr asymmetric". The heat pump must be manually reset.

Low-pressure switch E9

Input of a low-pressure switch (AC 230 V) upstream of the compressor.

High-pressure switch E10

Input of a high-pressure switch (AC 230 V) downstream from the compressor.

Overload compressor 1 E11

Input of an overload protection signal (AC 230 V) at compressor 1.

Error/alarm message

Input of an external error/alarm signal (AC 230 V).

Mains supervision E21

For mains supervision, the phase needs to be connected to the appropriately defined Ex input. Mains supervision monitors power supply to the compressor.

If a mains fault is continuously present during the period of time set under "Delay mains fault" (line 2894), the compressor is shut down for the minimum off time. The controller delivers error message "Mains fault".

If the mains fault occurs again within "Duration error repetition" (line 2889) for at least the delay time, the heat pump initiates lockout, if the preselected permitted number of faults have been exceeded.

The controller delivers error message 385:Mains undervoltage.

The heat pump must be manually reset.

Pressure diff defrost E28

Receives the signal delivered by a differential pressure switch. Due to the pressure differential across the evaporator, the switch detects the formation of ice and triggers defrosting.

Pres sw source int circ E29

Takes the signal delivered by the pressure switch of the source intermediate circuit. If, during source pump operation, the contact closes for at least 3 seconds, preselected monitoring (Always | With source operation) is active and the prerun time has elapsed, the heat pump is shut down.

When "Min off time" has elapsed, the heat pump is switched on again. If the pressure switch trips again within "Duration error repetition", the heat pump initiates lockout and operation can only be resumed by making a reset.

Flow sw source int circ E30

Takes the signal delivered by the flow switch of the source intermediate circuit. If, during source pump operation, the contact closes for at least the preset delay time (line 2895), preselected monitoring (always or in heating mode only) is active and the prerun time has elapsed, the heat pump is shut down.

When "Min off time" has elapsed, the heat pump is switched on again. If the flow switch trips again within "Duration error repetition", the heat pump goes to lockout and can only resume operation with a reset.

Smart grid E61, Smart grid E62

Smart grid information can be read in via inputs E61 and E62:

<i>E61</i>	<i>E62</i>	<i>Operating state "SG Ready"</i>	<i>Smart grid state</i>
1	0	1	Draw locked
0	0	2	Draw free
0	1	3	Draw wish
1	1	4	Draw forced

Low-pressure switch 2 E31

Input from a low pressure switch (230 V) upstream of compressor 2.

Monitoring acts on both compressors, if only E9 is configured on a two-staged heat pump. Each input acts on only the applicable compressor if error inputs E9 and E31 are configured.

High-pressure switch 2 E32

Input from an high-pressure switch (230 V) downstream of compressor 2.

Monitoring applies to both compressors if only E10 is configured for a two-staged heat pump. Each input acts on only the applicable compressor if error inputs E10 and E32 are configured.

Defrost message E33

The defrost message from an outside unit (split) can be read via input Ex.

On these types of plants, defrost is not controlled by a RVS, but rather by an external refrigeration circuit controller. Returning this status information guarantees flow at the condenser and, with it, the required heat supply, during defrost.

The condenser could be at risk of freezing and destroyed without this return loop.

Photovoltaics E64

Technical principal

The photovoltaic plant can force heat pump switch-on, even without a present request, via input E64.

The energy generated by the photovoltaic plant, is converted by the heat pump to thermal energy and used to charge the DHW storage tank, buffer storage tank, or swimming pool.

Priority

The charging priority can be selected for charging with photovoltaic through the following operating lines:

- Swimming pool charging priority photovoltaics (line 2066)
- Buffer storage tank charging priority photovoltaics (line 4706)
- DHW storage tank charging priority photovoltaics (line 5018)

It switches to the next consumer, once a consumer is charged to its permitted setpoint or does not exist.

Prerequisites

- A DHW storage tank, buffer storage tank, or swimming pool is required that is not already charged beyond the setpoint permitted for photovoltaic.
- The maximum permissible heat pump output is defined with the settings "Producers with optimum efficiency" (line 2867). It is the same for all producers.

The overview below details the consumer setpoints and the corresponding heat pump requests. The following applies:

- Charging occurs up to the entered setpoint for the applicable consumer
- The flow temperature setpoints for the heat pump are based on the consumer for charging

	<i>DHW storage tank *</i>	<i>Buffer storage tank (heating mode)</i>	<i>Buffer storage tank (cooling mode)</i>	<i>Swimming pool</i>
Setpoint of applicable consumer	line 1610 + line 5024	line 4750	line 4708, if not switched off	line 2055
Request on heat pump	line 1610 + line 5020	line 4750	line 4708, if not switched off	line 1959

*The DHW storage tank is charged to the Legionella setpoint if the legionella function is enabled for this day

Notes on heat pump request

- Upon reaching the setpoint, the heat pump may, if modulated, control output back to the minimum basic level output.
- It switches to the next consumer once the heat pump reaches the switch off limit (switch off temperature max., line 2844, high pressure, etc.).
- Charging continues until the compressor is switched off (switch off temperature max.), if no other consumer can be charged. A renewed charging can be started at the earliest the next day (after 00:00 am).

SHC error message E34

Error message input for the internal SHC.

SHC 2 error message E35

Error message input for external SHC 2.

If only E34 is configured on one of the 2-stage heat pumps, the monitoring applies to both SHCs. If error inputs E34 and E35 are configured, each input acts only on the applicable SHC.

**Inputs EX1, EX2, EX3,
EX4, EX5, EX6, EX7, E9,
E10, E11**

<i>Line no.</i>	<i>Operating line</i>
5981	Cont type input EX1, EX2, EX3, EX4, EX5, EX6, EX7, EX9, EX10, EX11 NC NO
5983	
5985	
5987	
5989	
5991	
5993	
5999	
6000	
6001	

Contact type

The type of contact can be selected:

NC

The input's function is active when voltage is not present.

NO

The input's function is active when voltage is present.



The descriptions of the functions of the EX contact apply when an NO contact is selected.

Mixing group 1 basic unit

Line no.	Operating line
6014	Function mixing group 1 Multifunctional Heating circuit 1 Heating circuit 2 Heating circuit 3 Primary contr/system pump DHW primary controller Instantaneous water heater Cooling circuit 1 Heating circ/cooling circ 1 Ret temp contr sol fuel boil Cooling circuit 2 Heating circ/cooling circ 2 Cooling circuit 3 Heating circ/cooling circ 3 DHW interm circuit controller

Terminals BX11, QX10, QX11 and QX9 are assigned as follows, depending on the setting of parameter 6014:

Function mixing group 1	Terminal BX11	Terminal QX10	Terminal QX11	Terminal QX9
None	Without function	Without function	Without function	Without function
Multifunctional	BX4	QX1	QX2	QX5
Heating circuit 1	B1	Y1	Y2	Q2
Heating circuit 2	B12	Y5	Y6	Q6
Heating circuit 3	B14	Y11	Y12	Q20
Primary contr/system pump	B15	Y19	Y20	Q14
DHW primary controller	B35	Y31	Y32	Q3
Instantaneous water heater *	B38	Y33	Y34	Q34
Cooling circuit 1	B16	Y23	Y24	Q24
Heating circ/cooling circ 1	B1	Y1	Y2	Q2
Ret temp contr sol fuel boil	B72	Y9	Y10	Q10
Cooling circuit 2	B17	Y41	Y42	Q28
Heating circ/cooling circ 2	B12	Y5	Y6	Q6
Cooling circuit 3	B18	Y43	Y44	Q29
Heating circ/cooling circ 3	B14	Y11	Y12	Q20
DHW interm circuit controller	B36	Y37	Y38	Q33

* DHW flow switch (FS) ready connected to H1

Multifunctional

With setting "Multifunctional", the terminals intended for use with the mixing group (BX11, QX10, QX11 and QX9) can be used for other applications.

Heating circuit 1...3

According to the settings in chapter "Heating circuits".

Primary contr/system pump

According to the settings in chapter "Primary controller/system pump".

DHW primary controller

According to the settings in chapter "DHW".

Instantaneous water heater

According to the settings in chapter "Instantaneous water heater".

Cooling circuit 1, 2, 3

According to the settings in chapter "Cooling circuits".

Heating circ/cooling circ 1, 2, 3

According to the settings in chapters "Heating circuits" and "Cooling circuits".

Ret temp contr sol fuel boil

According to the settings in chapter "Solid fuel boiler".

DHW interm circuit controller

According to the settings in chapter "DHW".

UX1, 2 (10V/PWM) basic unit

Line no.		Operating line
UX1	UX2	
6070	6078	Function output UX1 und UX2 None Source pump Q8/fan K19 DHW pump Q3 DHW interm circ pump Q33 Heat circuit pump HC1 Q2 Heat circuit pump HC2 Q6 Heat circuit pump HC3 Q20 Collector pump Q5 Solar pump ext exch K9 Solar pump buffer K8 Solar pump swi pool K18 Collector pump 2 Q16 Instant WH pump Q34 Solid fuel boiler pump Q10 Condenser pump Q9 Heat/cool circ pump 1 Q2 Heat/cool circ pump 2 Q6 Heat/cool circ pump 3 Q20 HP setpoint Output request Heat request Refrigeration request Compressor modulation Expansion valve evapor V81 Expansion valve EVI V82 Ventilation fan 1 K51 Ventilation fan 2 K52 Ventilation fan 3 K53
6071	6079	Signal logic output UX1 and UX2 Standard Inverted
6072	6080	Signal output UX1 and UX2 0..10V PWM
6075	6084	Temp value 10V UX1 and UX2
6076	6087	Output voltage UX1 and UX2

Function output UX1/2

Voltage- or PWM-modulated output for speed control of pumps and fans or for temperature and/or output requests.

Speed-controlled pumps

The output signal at UX corresponds to the speed required for the selected pump.

CAUTION

If the pump is controlled in a way that voltage output UX modulates while a triac output (ZX4) switches power on and off, it must be made certain that modulation of the triac output is switched off ("None", see line 5909).

Ventilation fans

3-stage ventilation fans can be controlled via output UX.

This is typically accomplished using a fan box, that receives the voltage signal UX and operates the fan at the desired stage accordingly.

The voltage signal corresponding to the desired fan stage is outputted at output UX:

- for "off" 0 V
- for stage 1 3.3 V
- for stage 2 6.7 V
- for stage 3 10 V

HP setpoint

The output signal at UX corresponds to the heat pump setpoint for heating or cooling.

Output request

The output signal at UX is proportional to the demand via the common flow.

Heat request and Refrigeration request

The output signal at UX corresponds to the common flow temperature setpoint.

Compressor modulation

The output signal at UX corresponds to the required compressor output.

Expansion valve evapor V81

The output signal at UX corresponds to the required position of the electronic expansion valve for superheat control.

Expansion valve EVI V82

The output signal at UX corresponds to the required position of the electronic expansion valve for vapor injection.

Signal logic output UX1/2	The voltage signal can be inverted. This means that inverted signal logic can also be used to control variable speed pumps or equipment receiving the temperature request.
Signal output UX1/2	Determines whether the signal shall be delivered as a DC 0...10 V signal or pulse width-modulated signal (PWM).
Temp value 10V UX1/2	This operating line is used to define the temperature for the maximum output voltage of 10 V or for the value set with "Output voltage UX1/2".
Output voltage UX1/2	"Output voltage UX1/2" is used to set the maximum output voltage. This value is reached when the positioning signal is 100% or when the temperature equals the value set on line BZ 6075/6084. This enables the control range to be mapped on a smaller voltage range (e.g. on DC 0...5 V in place of DC 0...10 V).

Sensor types/readjustments

<i>Line no.</i>	<i>Operating line</i>
6096	Sensor type device NTC 10k/1k NTC 5k
6097	Sensor type collector
6098	Readjustm collector sensor
6099	Readjustm coll sensor 2
6100	Readjustm outside sensor
6101	Sensor type flue gas temp
6102	Readjustm flue gas sensor
6104	Sensor type solar flow/ret

Sensor type device	Setting the NTC sensor characteristic used by the controller (see chapter 8.5).
Sensor type collector and flue gas temperature	<p>Selecting the type of sensor for B6, B61 and B8. The controller uses the respective temperature characteristic.</p> <p>For tables showing the temperatures and corresponding resistances, refer to chapter "Sensor characteristics" at the end of the document.</p>
Sensor readjustments	The measured value of the temperature sensors can be corrected.
Sensor type solar flow/ret	<p>Selection of the type of sensor for B63 and B64. The controller uses the respective temperature characteristic.</p> <p>For tables showing the temperatures and corresponding resistances, refer to chapter "Sensor characteristics" at the end of the document.</p>

Building and room model

<i>Line no.</i>	<i>Operating line</i>
6110	Time constant building

As the outside temperature varies, the room temperature changes at different rates, depending on the type of building construction .

The above setting is used to adjust the rate of response of the flow temperature setpoint when the outside temperature varies.

Example	> 20	Room temperature responds more slowly to outside temperature variations
	10...20	This setting is suited for most types of buildings
	< 10	Room temperature responds more quickly to outside temperature variations

Setting "0"	The function is deactivated. The attenuated and the composite temperature are the same as the current outside temperature.
-------------	--

Setpoint compensation

Line no.	Operating line
6114	Setp compensation Xp
6115	Setp compensation Tn
6116	Time constant setp compens
6117	Central setp compensation
6119	Central setp compens cooling

Setting the attenuation

As long as only one generator is released, the attenuated common flow temperature (B10) is calculated. To calculate the attenuation, the following settings can be made:

- Setp compensation Xp
- Setp compensation Tn
- Time constant setp compens

Central setp compensation Central setp compens cooling

In the case of cascades, the common flow temperature may be too low (with cooling cascades too high), the reason being larger water volumes on the consumer side, although all generators have reached their required setpoints. Too low (with cooling loads too high) common flow temperatures can also occur when – due to their own maximum temperature or output limitation – released generators do not reach the required generator setpoint.

Function "Central setp compensation"/"Central setp compens cooling" increases/decreases with cooling cascades the setpoints to the individually released generators in a way that the common flow temperature at sensor B10 (with cooling cascades B10 or B11) will be reached.

The controller calculates the difference between the current heat request sent to the generator and the common flow temperature currently acquired by sensor B10.

The previous heat request is adjusted upward by this differential and sent to the generators as the new heat request.

Line no.	Operating line
6118	Setpoint drop delay

Setpoint drop delay

Multistage sources are prevented from being switched off too quickly or freely modulating sources from being switched off promptly due to their output control. The entered value determines the slope of the drop off. The setpoint follows the actual value if the actual value drops faster than the calculated ramp.

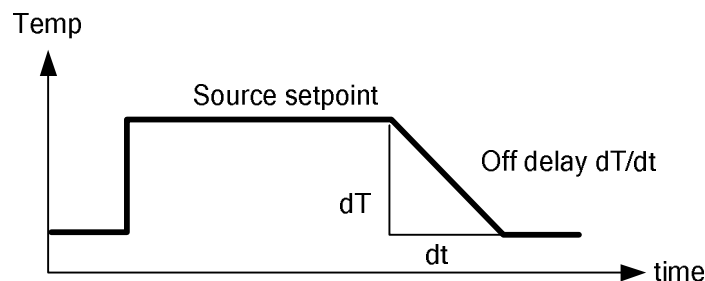

The drop off delay acts only when there is a setpoint change, but not when there is no more request for heat.

Pump/valve

Line no.	Operating line
6120	Frost protection plant Off On

The following pumps can be activated depending on the current outside temperature, even if there is no request for heat.



The pumps' behavior can be individually selected.

Heating circuit pumps	Q2, Q6, Q20
Cooling circuit	Q24, Q28, Q29
Consumer circuits	Q15, Q18
Swimming pool circuit	Q19
System pump	Q14
Condenser pump	Q9
Solid fuel boiler pump	Q10

Outside temperature	Pump	Diagram
... -4 °C	Continuously on	ON
-5...10.5 °C	10 minutes on at intervals of about 6 hours	takt (cycle)
1.5 °C...	Continuously off	OFF

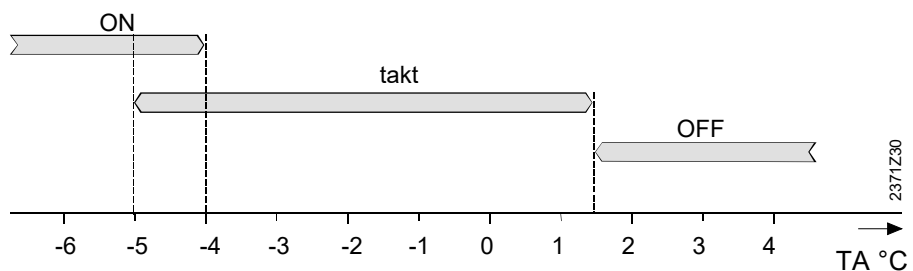

Line no.	Operating line
6123	Restart lock pumps

For high-efficiency pumps with high starting currents that might reduce the life of the relays or even damage them in the long-term, the "Restart lock pumps" function is available.

To make use of the pump's built-in current limitation, this type of pump needs to be deactivated for about 2 minutes before it is switched on again (cooling down of NTC resistor). This is accomplished by the "Restart lock pumps" function.

- If the function is activated, the "Restart lock pumps" function applies to all relays configured for pumps.
- The function has no impact on relays configured for valves.
- It also covers handling of power failures (process as described above).

The function secures the following plant states:

- Heat or refrigeration requests from the consumers are delivered only when the pump can be activated again.
- Heat or refrigeration sources are switched on again only when the pump is again allowed to be activated.

Static monitoring of pressure 1...3

Line no.			Operating line
1	2	3	
6140	6150	6180	Water pressure max
6141	6151	6181	Water pressure min
6142	6152	6182	Water pressure critical min

Water pressure max

If the water pressure acquired via input Hx exceeds the limit value set here, the respective error message is delivered:

- 117:Water pressure too high
- 176:Water press 2 too high
- 322:Water press 3 too high

If the pressure drops by one switching differential below the limit value, the error is cleared.

Water pressure min

If the water pressure acquired via input Hx drops below the set limit value, an appropriate maintenance message is delivered:

- 5:Water pressure too low
- 18:Water pressure 2 too low
- 22:Water pressure 3 too low

If the water pressure exceeds the limit value by one switching differential, the message is cleared.

Water pressure critical min

If the water pressure acquired via input Hx drops below the limit value set here, the respective error message is delivered and the heat pump switched off.

- 118:Water pressure too low
- 177:Water press 2 too low
- 323:Water press 3 too low

If the water pressure exceeds the limit value by one switching differential, the error is cleared.

Line no.			Operating line
1	2	3	
6148	6154	6184	Static press supervision 1, 2, 3 None With input H1 With input H2 module 1 With input H2 module 2 With input H2 module 3 With input H21 module 1 With input H21 module 2 With input H21 module 3 With input H22 module 1 With input H22 module 2 With input H22 module 3 With input H3

Static press supervision 1, 2, 3



Defines the Hx input to be used for the respective static pressure supervision.

The Hx input needs to be appropriately defined and a pressure sensor must be connected.

Parameter reset

<i>Line no.</i>	<i>Operating line</i>
6200	Save sensors

Using this setting, the sensors can immediately be stored. This is necessary when, for instance, a sensor is removed because it is no longer needed.



At midnight, the controller stores the states at the sensor terminals, provided the controller has previously been in operation for at least 2 hours.
If, after storage, a sensor fails, the controller delivers an error message.

<i>Line no.</i>	<i>Operating line</i>
6201	Reset sensors

This setting is used to clear the stored state of the sensors.



The sensors are read in again using function "Save sensors" (line 6200), or automatically at midnight, provided the controller was previously in operation for at least 2 hours.

Parameter reset

<i>Line no.</i>	<i>Operating line</i>
6204	Save parameters

The current parameter settings can be stored as new default settings. Exempted from this are the settings made on the OEM level, the time of day and date, the operator section, wireless and all time programs, plus the number of hours run and the various meters.

CAUTION

With this process, the factory settings are overwritten and can no longer be retrieved! This might cause damage, depending on the plant's operating state.

<i>Line no.</i>	<i>Operating line</i>
6205	Reset to default parameters

The parameters can be reset to their default values. Exempted from this are the following operating pages: "Time of day and date", "Operator section", "Wireless", and all time programs, plus the number of hours run and the various meters.

Plant diagram

<i>Line no.</i>	<i>Operating line</i>
6212	Check no. heat source 1
6213	Check no. heat source 2
6215	Check no. storage tank
6217	Check no. heating circuits

Check numbers

To identify the current plant diagram, the controller generates a check number. The check number is made up of the lined up partial diagram numbers (without the preceding zeros).

Structure of check number Every check number consists of 3 columns, each representing the application of a plant section. Every column is shown with 2 digits. All preceding zeros before the first numeral deviating from zero are hidden.

	<i>1st column 2 digits</i>	<i>2nd column 2 digits</i>	<i>3rd column 2 digits</i>
Line 6212	Blank	Solar	00
Line 6213	Blank	Solid fuel boiler	Heat pump
Line 6215		Buffer storage tank	DHW storage tank
Line 6217	Heating/cooling circuit 3	Heating/cooling circuit 2	Heating/cooling circuit 1

The following tables show the meaning of the numbers on the lines:

Check no. heat source 1

Solar							
	One collector field with sensor B6 and collector pump Q5	2 collector fields with sensors B6 and B61 and collector pumps Q5 and Q16	Storage tank charging pump buffer K8	Solar diverting valve buffer K8	Solar charging pump swimming pool K18	Solar diverting valve swimming pool K18	External solar heat exchanger pump K9 DHW = domestic hot water, P = buffer
0							No solar plant
1							*
3							DHW/B
5			x				
6				x			
8			x				DHW+B
9				x			DHW/B
10			x				DHW
11				x			DHW
12			x				B
13				x			B
14					x		
15						x	
17					x		DHW/B
18						x	DHW/B
19			x		x		
20				x		x	
22			x				DHW+B
23				x		x	DHW/B
24			x		x		DHW
25				x		x	DHW
26			x		x		B
27				x		x	B
	31						*
	33						DHW/B
	35			x			
	37		x				DHW+B
	38			x			DHW/B
	39		x				DHW
	40			x			DHW
	41			x			B
	42					x	
	44				x		DHW/B
	45					x	DHW/B
	46			x		x	
	48		x		x		DHW+B
	49			x		x	DHW/B
	50		x		x		DHW
	51			x		x	DHW
	52			x		x	B

* The DHW storage tank is charged via collector pump Q5

Check no. heat source 2:
Solid fuel boiler

Solid fuel boiler	
0	No solid fuel boiler
1	Solid fuel boiler, boiler pump
2	Solid fuel boiler, boiler pump, integration DHW storage tank

Check no. heat source 2:
Heat pump

Heat pump	
0	No heat pump
10	Brine-to-water heat pump, 1-stage
14	Brine-to-water heat pump, 1-stage, with passive cooling
18	Brine-to-water heat pump, 1-stage, with process reversing valve
22	Brine-to-water heat pump, 1-stage, with process reversing valve and passive cooling
30	Water-to-water heat pump, 1-stage
34	Water-to-water heat pump, 1-stage, with passive cooling
38	Water-to-water heat pump, 1-stage, with process reversing valve
42	Water-to-water heat pump, 1-stage, with process reversing valve and passive cooling
50	Air-to-water heat pump, 1-stage, with process reversing valve
60	Heat pump, 1-stage, for external monitoring

Check no. storage tank

Buffer storage tank		DHW storage tank	
0	No buffer storage tank	00	No DHW storage tank
1	Buffer storage tank	01	Electric immersion heater
2	Buffer storage tank, solar connection	02	Solar connection
4	Buffer storage tank, generator shutoff valve	04	charging pump
5	Buffer storage tank, solar connection, generator shutoff valve	05	Charging pump, solar connection
		13	Diverting valve
		14	Diverting valve, solar connection
		16	Primary controller, without heat exchanger
		17	Primary controller, 1 heat exchanger
		19	Intermediate circuit, without heat exchanger
		20	Intermediate circuit, 1 heat exchanger
		22	Charging pump/intermediate circuit, without heat exchanger
		23	Charging pump/intermediate circuit, 1 heat exchanger
		25	Diverting valve/intermediate circuit, without heat exchanger
		26	Diverting valve/intermediate circuit, 1 heat exchanger
		28	Primary controller/intermediate circuit, without heat exchanger
		29	Primary controller/intermediate circuit, 1 heat exchanger

Check no. heating circuits/cooling circuits

Heating circuit 3	Heating circuit 2	Heating circuit 1
0	00	00
2	02	01
3	03	02
5..7	05..07	03
8..10	08..10	05..07
12	12	08..10
14..16	14..16	12
20..27	20..27	14..16
30..38	30..38	20..27
40..42	40..42	30..38
		40..42

Example

Source 2: Water-to-water heat pump, 1-stage
 Storage tank: Buffer storage tank
 Heating circuit 1: Heating circuit pump and mixing valve

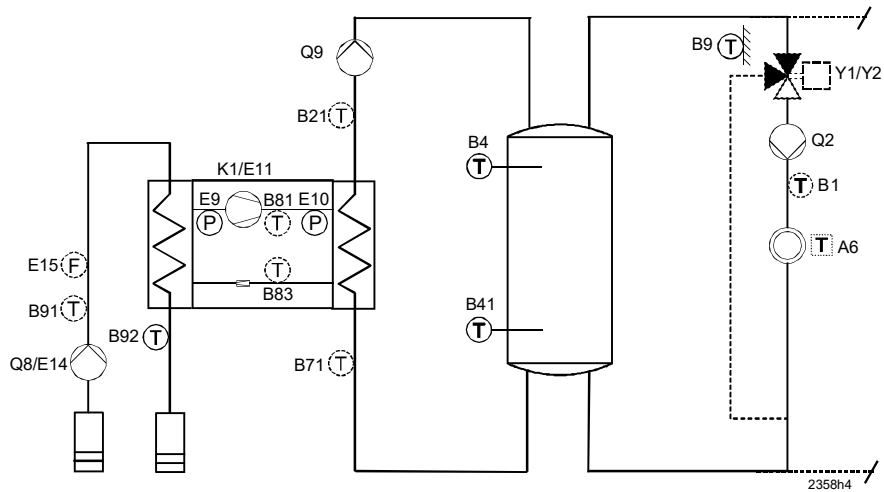

Displays on the operator unit:

Line 6213	Check no. generator 2	30
Line 6215	Check no. storage tank	100
Line 6217	Check no. heating circuit	3

Device data

Line no.	Operating line
6220	Software version

The software version installed represents the state of the software available at the time the unit was produced.

The first 2 digits denote the software version, the third digit indicates the software upgrade (e.g. 01.0).

Line no.	Operating line
6221	Development index
6222	Device hours run
6228	Bootloader version
6229	Eeprom version

Development index

Controller's firmware version.

Device hours run

Shows the total number of operating hours since the controller was first commissioned.

Bootloader version

Controller's firmware update version.

Eeprom version

Device data version.

Codes of operating levels

Line no.	Operating line
6345	Code commissioning 0..99999
6346	Code engineer 0..99999

Operating levels "Commissioning", and "Heating engineer" can be assigned individual codes between 0 and 99999. These operating levels can only be accessed after entering the respective code.

The codes can only be changed at the OEM level.

The code for the OEM cannot be changed on its own.



Setting "0" requires no code entry.

Room sensors 10V to Hx

Measurement room temperature 1, 2, 3

Line no.			Operating line
L1	L2	L3	
6290	6291	6292	Acquisition room temp 1, 2, 3 None With input H1 With input H2 module 1 With input H2 module 2 With input H2 module 3 With input H21 module 1 With input H21 module 2 With input H21 module 3 With input H22 module 1 With input H22 module 2 With input H22 module 3 With input H3 With input H31 With input H32 With input H33

Instead of or in addition to the temperature sensor in the room unit (BSB or B5/B52/B53), a room temperature sensor with 0...10V signal can be connect to an Hx input. The following also must be configured:

- The "Room temp 10V" function is assigned to the Hx input.

The value at the Hx input and the value of the room unit sensor are used for the various functions as per the following priority:

Room temperature		Use of room temperature	
From Hx	From RU	For dewpoint	For cooling circuit
No	No	-	-
No	Yes	Value room unit	Value room unit
Yes	Yes	Value Hx	Value RU
Yes	No	Value Hx	Value Hx

Measurement of relative room humidity

Line no.			Operating line
HC/CC1	HC/CC2	HC/CC3	
6293	6294	6295	Acquisition room rh 1, 2, 3 None With input H1 With input H2 module 1 With input H2 module 2 With input H2 module 3 With input H21 module 1 With input H21 module 2 With input H21 module 3 With input H22 module 1 With input H22 module 2 With input H22 module 3 With input H3 With input H31 With input H32 With input H33

A humidity sensor with 0...10 V signal can be connected to an Hx input. The following must also be configured:

- The "Humidity measurement 10V" function is assigned to the Hx input.

The measured relative humidity is used to calculate the dewpoint and the flow increase of the cooling circuit.

During active humidity measurement, ventilation is controlled to the set limit values as per the relative room humidity (OL 985 and 987).

The value at the Hx input and the value of the room unit sensor are used in accordance with the following priority:

Relative room humidity		Use of room humidity	
from Hx	from RU	For dewpoint	Other room functions
No	No	-	-
No	Yes	Value RU	Value RU
Yes	Yes	Value Hx	Value RU
Yes	No	Value Hx	Value Hx

Air quality measurement

Line no.			Operating line
L1	L2	L3	
6296	6297	6298	Acquis room air quality 1, 2, 3 None With input H1 With input H2 module 1 With input H2 module 2 With input H2 module 3 With input H21 module 1 With input H21 module 2 With input H21 module 3 With input H22 module 1 With input H22 module 2 With input H22 module 3 With input H3

Activate the air quality measurement by selecting the H input to which the air quality sensor is used for measurement.

There is no air quality measurement with setting "none".

For active air quality measurement, ventilation is controlled to the entered setpoints according to air quality (OL 974 and 975).

The controller measures air quality of the air quality sensor connected to the H input or assumes the air quality provided by the room unit.



The higher measured value is taken if the measured values are available from both sources.

The following Siemens air quality sensors are supported:

- QPA10.../QPA20... (room sensor)
- QPM11.../QPM21... (duct sensor)

Depending on type, there is either a CO₂, a VOC (volatile, carbon elements) or a mixed measurement. The measured values are converted into a 0...10 V signal based on the following output curve:

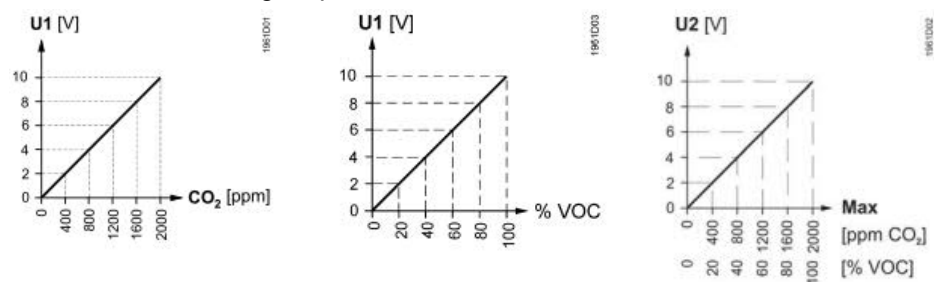

The current room air load (ppm) is displayed on operating lines 8935 / 8940 / 8945.

Partial diagrams

<i>Line no.</i>	<i>Operating line</i>
ACS	Partial diagram heat circuit 1
ACS	Partial diagram cooling circuit 1
ACS	Partial diagram heat circuit 2
ACS	Partial diagram cooling circuit 2
ACS	Partial diagram heat circuit 3
ACS	Partial diagram cooling circuit 3
ACS	Partial diagram ventilation 1
ACS	Partial diagram ventilation 2
ACS	Partial diagram ventilation 3
ACS	Partial diagram Consumer circuit 1
ACS	Partial diagram Consumer circuit 2
ACS	Partial diagram swimming pool circuit
ACS	Partial diagram swimming pool
ACS	Partial diagram converter
ACS	Partial diagram converter 2
ACS	Selection of partial diagram heat pump
ACS	Partial diagram suppl source
ACS	Partial diagram hydraulic balancing
ACS	Partial diagram solar collector
ACS	Partial diagram solid fuel boiler
ACS	Partial diagram buffer
ACS	Partial diagram dhw storage
ACS	Partial diagram instantaneous heater

Indicates the number of the active partial diagram.

<i>Line no.</i>	<i>Operating line</i>
ACS	Cascade status Inactive Active

Indicates the current state of cascade detection.

Inactive

Only one generator installed.

Active

Several generators installed.

<i>Line no.</i>	<i>Operating line</i>
ACS	LPB interface available
ACS	Modbus interface available

Information whether LPB or Modbus interface is available.

6.21 LPB

Address/power supply

Line no.	Operating line
6600	Device address
6601	Segment address
6604	Bus power supply function Off ; Automatic
6605	Bus power supply state Off ; On

Device address and Segment address

The controller's LPB address consists of two 2-digit numerals.

Example

14	16
Segment address	Device address

Bus power supply function

Bus power supply enables the bus system to be powered directly by the individual controllers (no central bus power supply). The type of bus power supply can be selected.

Off

No bus power supply via the controller.

Automatic

The bus power supply (LPB) via the controller is automatically switched on and off depending on the power requirements of the LPB.

Bus power supply state

The display shows whether the controller currently supplies power to the bus:

Off

The bus power supply via controller is currently inactive.

On

The bus power supply via controller is currently active. At the moment, the controller supplies some of the power required by the bus.

Errors/maintenance/alarms

Line no.	Operating line
6610	Display system messages
6612	Alarm delay

Display system messages

This setting allows system messages transmitted via LPB to be suppressed at the connected operator unit.

Alarm delay

Delivery of an alarm to the OCI can be delayed in the basic unit by setting a delay. This ensures that unnecessary notifications by a service center resulting from short-time errors (e.g. temperature limiter tripped, communication error) will be suppressed.



- The alarm delay also applies to "Alarm output K10"
- It is to be noted that in this case, errors occurring for a short time and recurring constantly and rapidly will be filtered as well

Central functions

Line no.	Operating line
6620	Action changeover functions Segment System
6621	Summer changeover Locally Centrally
6623	Optg mode changeover Locally Centrally
6625	DHW assignment All HC/CC locally All HC/CC in segment All HC/CC in system
6627	Refrigeration request Locally Centrally
6630	Cascade master Always Automatically
6632	Note OT limit ext source No Yes



These settings only apply to device address 1.

Action changeover functions

The range of action for the central changeover functions can be defined. This applies to the following changeover actions:

- Operating mode changeover via input Hx (with setting "Centrally" on operating line 6623)
- Summer changeover (when selecting "Centrally" on operating line 6621)

Choice of settings:

Segment

Changeover takes place with all controllers in the same segment.

System

Changeover takes place with all controllers in the entire system (that is, in all segments). For that, the controller must be located in segment "0".

Summer changeover

The range of action of summer changeover is as follows:

Locally

Local action; the local heating circuit is switched on and off according to operating lines 730, 1030, and 1330.

Centrally

Central action; depending on the setting made on operating line "Action changeover functions", either the heating circuits in the segment or those of the entire system are switched on and off according to operating line 730.

Optg mode changeover

The range of action of operating mode changeover via input Hx is as follows:

Locally

Local action; the local heating circuit is switched on and off

Centrally

Central action; depending on the setting made on operating line "Action changeover functions", either the heating circuits in the segment or those of the entire system are switched on and off.

DHW assignment	<p>DHW assignment defines the heating/cooling circuits of which the operating state for the control of DHW heating (forward shift for charging, operation of circulating pump, "Holiday" function) shall be considered.</p> <p>All HC/CC locally DHW heating only considers own, controller-internal heating/cooling circuits.</p> <p>All HC/CC in segment DHW heating considers the heating/cooling circuits of the controllers in the same segment.</p> <p>All HC/CC in system DHW heating considers the heating/cooling circuits of all controllers in the system.</p>
Refrigeration request	<p>A QX output parameterized as "Refrigeration request K28" delivers a refrigeration request. Depending on setting "Refrigeration request", the request is delivered by the local cooling circuit or all cooling circuits in the system.</p> <p>Locally Only cooling circuit 1 is considered. The refrigeration request is not forwarded to the system.</p> <p>Centrally Consideration is given to the refrigeration requests from the entire system.</p>
Cascade master	<p>The "Cascade" menu (lines 3510....3590) can always be shown, or only under certain conditions.</p> <p>Always The "Cascade" menu is always shown, irrespective of the number of producers installed.</p> <p>Automatically The "Cascade" menu is only shown when several producers are installed and the controller cascade is the master (device address 1).</p>
Note OT limit ext source	<p>Additional producers connected via LPB can be locked or released according to their own parameters based on the outside temperature (e.g. air-to-water heat pump). This state is distributed via LPB. In a cascaded system, the master therefore knows whether or not an additional producer (slave) according to own operating limits (outside temperature) is available so that it can be switched on, if required.</p> <p>No The Ecobit of the external producer is not considered.</p>

NOTE	If some other heat source with an LMU boiler management unit (slave) is connected as an additional producer, this parameter must be set to "No".
-------------	--

Yes
The Ecobit of the external producer is considered and the cascade is controlled according to the available producers.

Clock

6640	Clock mode Autonomously Slave without remote setting Slave with remote setting Master
6650	Outside temp source

Clock mode

This setting defines the action of the system time on the controller's time settings. The effects are as follows:

Autonomously

The time of day can be readjusted on the controller.

The controller's time of day is not matched to the system time.

Slave without remote setting

The time of day on the controller cannot be readjusted.

The controller's time of day is constantly and automatically matched to the system time

Slave with remote setting

The time of day can be readjusted on the controller; at the same time, the system time is adapted since the change is adopted from the master.

Nevertheless, the controller's time of day is automatically and continuously matched to the system time.

Master

The time of day can be readjusted on the controller.

The time of day on the controller is used for the system: The system time is adapted.

Outside temp source

The LPB plant requires only 1 outside sensor. This sensor is connected to any controller and delivers via LPB the signal to the controllers with no sensor.

The first numeral that appears on the display is the segment number followed by the device number.

Loss of communication, error recognition

Error "489:No cascade master" is issued if the RVS61, as the cascade slave in the LPB linked system, does not receive a telegram from the cascade master after a timeout of 11 minutes.

Error "81:LPB short-circuit/comm" is detected without delay in the event of a short circuit.

Note

The response to errors is described in Section 6.25 "Maintenance/special operation".

6.22 Modbus

Modbus-compatible

Modbus clip-in OCI351.01 makes the RVS61 Modbus-compatible.

Modbus applications

The RVS61 supports 3 applications via the Modbus interface:

#	Application		RVS is
1	Actuators	Controls pumps, fans, and compressors <ul style="list-style-type: none"> • For select manufacturers, preconfigured Modbus settings are available (see section "Apply preconfigured Modbus settings for select manufacturers"). • All other actuators addressable over Modbus can be self-configured (see section "Actuators self-configuration " in section "Modbus expert"). 	Modbus master
2	Controller grouping	Exchanges process data with a third-party controller	Modbus slave
3	Control system/Operator unit	Exchanges process data, parameters, operating values	Modbus slave

Important note

With applications "Controller network" and "BACS/operating unit", the simultaneous control of actuators is not possible – and vice versa – the reason being this assignment.

Specification of Modbus

The table below shows the Modbus specification for the RVS61:

Mode	RTU
Protocol	Master or slave (depending on the application)
Slave addresses	1...247
Number of slave ports	8
Broadcast (as master)	No
Baud rate	1'200, 2'400, 4'800, 9'600, 19'200 , 38'400, 57'600, 76'800, 115'200 baud
Start bit	1 (fix)
Data bit	8 (fix)
Stop bit	1 or 2
Parity	Even, Odd, None
Function codes	<ul style="list-style-type: none"> • 0x01 Read Coils • 0x02 Read Discrete Inputs • 0x03 Read Holding Registers • 0x04 Read Input Registers • 0x05 Write Single Coils • 0x06 Write Single Register (not for structured data types) • 0x10 Write multiple Register*
Data register	2 byte
Data types	<ul style="list-style-type: none"> • Boolean • Signed/Unsigned integer 16 bit • Structured (across several registers)*
Byte order	Big-Endian, Little-Endian
Telegram length	Max. 44 data byte
Response Timeout	Default: 300 ms. Setting: 100...10'000 ms

* only if RVS.. is slave

Recommended settings

- Baud rate: 19200 baud (when cable length < 500 m)
- Parity: Even
- Stop bit: 1

Topology

The Modbus devices should be interconnected in the form of a line structure. The 2 line ends must have a terminating resistor fitted.

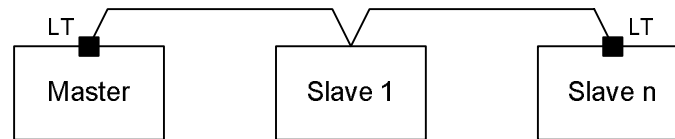

LT: Line termination)

Modbus settings

Line no.	Operating line
6651	Slave address
6652	Baud rate 1'200 2'400 4'800 9'600 19'200 38'400 57'600 76'800 115'200
6653	Parity Even Odd None
6654	Stop bit
6655	Modbus OV version

Master or slave via
"Slave address"

Every device in the Modbus network must be assigned a communication role.

- One of the devices in the network is the master. The master has no address.
- All other devices are slaves and are assigned an unambiguous slave address, enabling them to be distinguished.

Whether the RVS61 is to be configured as a master or slave depends on the type of application.

- "Slave address" = "----"
RVS61 is the master. This setting is required for the control of actuators (pumps, fans and compressors).
- "Slave address" = 1...247
RVS61 is a slave with the set address. This setting is required with the applications "Controller network" and "BACS/operating unit".

Baud rate

All devices in the Modbus network must use the same setting for the rate of transmission.

The higher the rate of transmission, the shorter the lines between the devices must be.



Rule of thumb: When baud rate is doubled, line length needs to be cut in half. For more information, refer to "Technical data".

Parity

Parity identifies erroneously transmitted data bytes.

All devices in the Modbus network must use the same parity setting.

Stop bit

All devices in the Modbus network must use the same setting for the number of stop bits.

If 2 stop bits are set, parity must be set to "None".

Modbus OV version

The controller supports object from the Modbus parameter list up to and including "Modbus OV version". The Modbus parameter list is an integral part of document A6V11625981.

Loss of communications

Line no.	Operating line
6658	Master loss detection

Error recognition

Error 495 "No communication on Modbus" is issued if the RVS43 (Modbus slave) does not receive a telegram addresses to it (read or write) over a configured time (OL 6658).

The error is delete one a telegram is receive again. Error recognition is only enabled if there is a Modbus interface (OCI350/351 excluded).

Note

The error response is described in 6.25 "Maintenance/special operation".

1. Actuators: Pumps, fans and compressors

The RVS61 is capable of controlling up to 8 actuators via Modbus.

The RVS61 must be configured as the master, the actuators as slaves.

Each actuator/slave is assigned a virtual port on the RVS61. A total of 8 ports are available.

The following documented parameters are set for each port in use:

<i>Line no.</i>	<i>Operating line</i>
6660...6695	Slave address port 1...8

Slave address port 1...8

"---"

No actuator/slave connected. If the port is not used, a slave address must not be set. If not observed, an error message is delivered.

1...247

Communication address of an actuator/slave controlled by the RVS61.

If the RVS61 (being the master) at this address receives no reply after several queries (after a total of about 1 minute), an error message is delivered.

Apply preconfigured Modbus settings for select manufacturers

<i>Line no.</i>	<i>Operating line</i>
6661..6696	Device port 1...8 None OEM Pump Grundfos Pump Wilo Fan Ebm-papst Inverter Invertek
6662...6697	Function port 1...8 None ... Heat/cool circ pump 3 Q20 (see next page)

Device port 1...8

Data formats and data addressing of Modbus actuators are not standardized and therefore supplier-specific. The RVS61 provides a list of actuators from certain suppliers:

<i>Selection</i>	<i>Type</i>
Pump Grundfos	Grundfos E-pumps with CIM/CIU200 Modbus interface
Pump Wilo	Wilo pumps with DigiCon IF module
Fan Ebm-papst	Ebm-papst fans of the 84/112/150 line
Inverter Invertek	Invertek VSD OPTIDRIVE
OEM *	Setting for "Actuators self configuration"

Selecting the use or the function of the actuator in the field.

The RVS61 does not provide a speed control signal for all types of pumps. These pumps are then only controlled as single speed pumps (on/off).

<i>Function</i>	<i>Speed-controlled</i>
System pump Q14	No
Cascade pump Q25	No
Circulating pump Q4	No
St tank transfer pump Q11	No
DHW interm circ pump Q33	Yes
DHW mixing pump Q35	No
Collector pump Q5	Yes
Collector pump 2 Q16	Yes
Solar pump ext exch K9	Yes
Solar ctrl elem buffer K8	Yes
Solar ctrl elem swi pool K18	Yes
Cons circuit pump VK1 Q15	No
Cons circuit pump VK2 Q18	No
Swimming pool pump Q19	No
Heat circuit pump HC3 Q20	Yes
Heat circuit pump HC1 Q2	Yes
DHW ctrl elem Q3	Yes
Source pump Q8/fan K19	No
Condenser pump Q9	Yes
Compressor stage 1 K1	Yes
Heat circuit pump HC2 Q6	Yes
Instant WH ctrl elem Q34	Yes
Cooling circ pump CC1 Q24	No
Cooling circ pump CC2 Q28	No
Cooling circ pump CC3 Q29	No
Solid fuel boiler pump Q10	Yes
Ventilation fan 1 K51	Yes
Ventilation fan 2 K52	Yes
Ventilation fan 3 K53	Yes
Outside air temp contr Q17	No
Source int circ pump Q81	No
System pump 2 Q44	No
Heat/cool circ pump 1 Q2	Yes
Heat/cool circ pump 2 Q6	Yes
Heat/cool circ pump 3 Q20	Yes



For every port, menu "Input/output test" offers 4 ACS parameters used to check the functioning of an actuator.

For description of the test parameters and display values, refer to the respective chapter.

Important note

Parameters "Devices Port 1..." and "Function Port 1..." write setting **Sets** to the same Modbus expert parameters (ACS), they are **individually** documented in section "Actuators self configuration".

In other words, for your engineering going back and forth between setting sets and individual settings is possible and even makes sense. Note that the settings cannot be saved so that the "last wins" principle applies.

2. Controller network

Using Modbus, the RVS61 can be connected to a controller of other manufacture. The RVS61 must be configured as the slave with a "Slave address" (line 6651), the controller of other manufacture is the master.

Settings

The parameters to be set are Slave address, Baud rate, Parity and Stop bit.

With no meaning or function:

- Port parameter.
- Input/output test parameter.



- The RVS61 is either a generator or consumer controller, depending on the controller's configuration.
- Interconnected RVS controllers cannot be connected via Modbus.



The list and description of possible data points that are available can be found in document A6V11625981.

3. BACS/operating unit

Using Modbus, the RVS61 can be connected to a BACS or operating unit. The RVS61 must be configured as the slave with a "Slave address" (line 6651), BACS or the operating unit is the master.

Settings

The parameters to be set are Slave address, Baud rate, Parity and Stop bit.

With no meaning or function:

- Port parameter.
- Input/output test parameter.



The majority of operating parameters and display values of the RVS61 can be read and written via the Modbus.



The list and description of possible data points that are available can be found in document A6V11625981.

6.23 Modbus expert

Line no.	Operating line
ACS	Modbus response timeout
ACS	Source error by Modbus error

Modbus response timeout Response time to a query.

Source error by Modbus error The impacted source is switched to fault if Modbus fails (setting "Yes", default).

Byte order (per port)

Line no.	Operating line
ACS	Byte order

Transmission format or byte sequence on the bus.

Actuators self configuration

The Modbus expert menu offers access to the following virtual inputs and output for each port:

ACS parameter	Type of input/output	Description
Modbus function QX	Virtual multifunctional digital output	The function of the virtual QX output can be defined (dito OL6070).
Modbus function UX	Virtual multifunctional output (modulating)	The function of the virtual UX output can be defined (dito OL5890). For speed-controlled pumps and fans or for temperature and/or power demands.
'Status'	Feedback from Modbus function QX	State (ON/OFF) of the defined Modbus actuator.
'UX feedback'	Feedback from Modbus function UX	Modulation actual value of the defined Modbus actuators.
Modbus function BX	Virtual sensor input	Note: The settings of the sensor inputs determine the basic diagrams and auxiliary functions. See Section "".
Modbus function EX *	Virtual multifunctional digital input	The function of the virtual EX input can be defined (dito OL5980).
Modbus function output 1	Virtual multifunctional output	Sends a freely defined or internal Modbus register value**
'Input 1'	Virtual input	Pure display value

*) The 'Modbus compare EX' parameter offers a compare query for non-boolean values

***) The internal Modbus register addresses can be found in document A6V11625981 (Albatros2_Modbus_Paralist)

The menu Modbus experts is relevant for actuator applications (RVS as master) and only displayed in the ACS tool. The setpoint is designed for users who know Modbus specifications and protocols.

Data points / Register format & addressing

The parameters described below permit the RVS controller to set the various formats and addressing of the Modbus registers. This permits also connecting actuators under certain circumstances that are not predefined on the controller.

ACS-Parameter	Kürzel	Einstellungen
Modbus function code ...	FnCode	<ul style="list-style-type: none">For virtual inputs: No function Read Coils Read Discrete Inputs Read Holding Registers Read Input RegistersFor virtual outputs: No function Write Single Coil Write Single Register
Modbus register address ...	RegAdr	0...65535
Modbus data type ...	DataTyp	Boolean sign 16 bit unsign 16 bit
Modbus bit mask ...	BitMask	0...65535
Modbus multiplier ...	Mul	-32768...32767
Modbus divisor ...	Div	-32768...32767
Modbus offset ...	Offset	-32768...32767 (for Modbus data type = unsigned: Positive values only)

Important note

The individual parameters described here are the same settings as described in section "Preconfigured Modbus settings for select manufacturers " (descriptions "Devices Port 1..." and "Function Port 1..."). The latter write the entire setting **Sets**. In other words, for your engineering going back and forth between setting sets and individual settings is possible and even makes sense. Note that the settings cannot be saved so that the "last wins" principle applies.

6.24 Errors

Pending errors are displayed with the Alarm symbol  together with a brief description. Additional information is available on the Info pages.

Reset

<i>Line no.</i>	<i>Operating line</i>
6710	Reset alarm relay No Yes
6711	Reset HP No Yes

Reset alarm relay

When a fault is pending, an alarm can be set off via relay Qx. Relay Qx must be configured accordingly.

This setting is used to reset the relay, but the alarm is maintained.

Reset HP

Pending error messages from the heat pump are reset via this operating line. The preset switch-on delay is bridged, thus avoiding undesirable waiting times during commissioning or fault tracing. This function should not be used in normal operation.

Temperature alarms

<i>Line no.</i>	<i>Operating line</i>
6740	Flow temp 1 alarm
6741	Flow temp 2 alarm
6742	Flow temp 3 alarm
6745	DHW charging alarm
6746	Flow temp cooling 1 alarm
6747	Flow temp cooling 2 alarm
6748	Flow temp cooling 3 alarm

The temperatures are constantly monitored. If an actual value deviates from the setpoint for a period of time exceeding the time set here, an alarm is delivered, including display of the associated error message.

Error code 121: Flow temperature heating circuit 1 too low (line 6740).

Error code 122: Flow temperature heating circuit 2 too low (line 6741).

Error code 371: Flow temperature heating circuit 3 too low (line 6742).

Error code 126: Monitoring DHW charging (line 6745).

Error code 357: Flow temperature cooling circuit 1 not reached (line 6746).

Error code 474: Flow temperature cooling circuit 2 not reached (line 6747).

Error code 475: Flow temperature cooling circuit 3 not reached (line 6748)

The flow temperature is regarded as having been maintained if the deviation from the setpoint is less than 1 Kelvin. If the flow temperature setpoint is reduced by more than 4 Kelvin, the monitoring function will be deactivated until the flow temperature has dropped to the new setpoint.

The function is also passive when the heating circuit pump is off due to an "Eco" function or quick setback.

Error history

<i>Line no.</i>	<i>Operating line</i>
6800...6819	[Time stamp and error history 1....10]

The controller stores the last 10 errors in a nonvolatile error memory. Any additional entry clears the oldest entry in the memory.

For each error entry, error code and time of occurrence are stored.



The ACS tool can be used to display the relevant actual values, setpoints and relay outputs for each error.

Error codes

A list of possible error codes is available in section 6.34.1.

History 1...10

<i>Line no.</i>	<i>Operating line</i>
6820	Reset history No Yes

Reset history

The error history with the last 10 errors, the associated actual values and setpoints and the relay output states will be deleted.

Number of error repetitions

<i>Line no.</i>	<i>Operating line</i>
ACS	Repetition Error 107:Hot-gas compressor 1
ACS	Repetition Error 108:Hot-gas compressor 2
ACS	Repetition Error 134:Disturbance heat pump
ACS	Repetition Error 204:Fan fault (overload)
ACS	Repetition Error 222:High-pressure HP
ACS	Repetition Error 225:Low-pressure HP
ACS	Repetition Error 226:Compressor 1 overload
ACS	Repetition Error 227:Compressor 2 overload
ACS	Repetition Error 228:Flow switch heat source
ACS	Repetition Error 229:Pressure switch heat source
ACS	Repetition Error 230:Source pump overload
ACS	Rep Error 355/385:Three-phase current/undervolt
ACS	Repetition Error 356:Flow switch consumers
ACS	Repetition Error 358/483: Soft starter
ACS	Repetition Error 491:Max evaporation temp
ACS	Repetition error 504:Press diff process reversal
ACS	Repetition error 529/530: Superheat controller

Number of error repetitions (only via ACS tool)

When the set value is exceeded, the heat pump shuts down and can only be unlocked by making a reset.

6.25 Maintenance/special operation

"Maintenance" functions

"Maintenance" functions can be used as a preventive measure to ensure periodic monitoring of plant. All "Maintenance" functions can be switched individually. The controller generates maintenance messages automatically should maintenance function settings be violated.

Line no.	Operating line
7070	HP interval
7071	HP time since maint
7072	Max starts compr1/hrs run
7073	Cur starts compr1/hrs run
7074	Max starts compr2/hrs run
7075	Cur starts compr2/hrs run
7076	Diff condens max/week
7077	Cur diff condens max/week
7078	Diff condens min/week
7079	Cur diff condens min/week
7080	Diff evap max/week
7081	Cur diff evap max/week
7082	Diff evap min/week
7083	Cur diff evap min/week
7084	Maint interval ventilation 1
7085	Time since maint vent'n 1
7086	Maint interval ventilation 2
7087	Time since maint vent'n 2
7088	Maint interval ventilation 3
7089	Time since maint vent'n 3
7090	DHW storage tank interval
7091	DHW stor tank since maint
7092	DHW charg temp HP min
7093	Curr DHW charg temp HP

HP interval

Setting the interval (in months) at which the heat pump requires service.

HP time since maint

Display of the period of time (in months) since the last service visit. If the value lies above setting "HP interval", ...

- symbol  appears on the display, and
- a maintenance message on the info level: 17:HP interval (priority 6).

Reset

This parameter can be reset, provided the respective access right is granted.

Maximum number of starts of compressors 1, 2 per hour run

Max starts compr1/hrs run

Setting the maximum permissible number of starts of compressor 1 or 2 per hour run.

Max starts compr2/hrs

Cur starts compr1/hrs run

Cur starts compr2/hrs run

Average number of starts of compressor 1 or 2 per hour run reached over the last 6 weeks. If the value lies above setting "Max starts compr1/hrs run" or "Max starts compr2/hrs run"...

- symbol  appears on the display, and
- on the info level maintenance message 8:Too many starts compr1 or 9:Too many starts compressor 2 (both having priority 9).

Reset

This parameter can be reset, provided the respective access right is granted.

Number of times per week the temperature differential across the condenser exceeded the maximum

Diff condens max/week Setting the number of times within a 7-day period the temperature differential across the condenser may exceed the maximum.

Cur diff condens max/week Number of times within a 7-day period the temperature differential across the condenser exceeded the maximum. If the value lies above setting "Diff condens max/week", ...

- symbol  appears on the display, and
- a maintenance message on the info level: 13:Diff condenser max (priority 3).

Reset This parameter can be reset, provided the respective access right is granted.

Number of times per week the temperature differential across the condenser dropped below the minimum

Diff condens min/week Indicates how many times within a 7-day period the temperature differential across the condenser may drop below the minimum.

Cur diff condens min/week Number of times within a 7-day period the temperature differential across the condenser dropped below the minimum. If the value lies above setting "Diff condens min/week", ...

- symbol  appears on the display, and
- a maintenance message on the info level: 14:Diff condenser min (priority 3).

Reset This parameter can be reset, provided the respective access right is granted.

Number of times per week the temperature differential across the condenser exceeded the maximum.

Diff evap max/week Indicates how many times within a 7-day period the maximum temperature differential across the evaporator may be exceeded.

Cur diff evap max/week Number of times within a 7-day period the temperature differential across the condenser exceeded the maximum. If the value lies above setting "Diff evap max/week", ...

- symbol  appears on the display, and
- a maintenance message on the info level: 15:Diff evaporator max (priority 3).

Reset This parameter can be reset, provided the respective access right is granted.

Number of times per week the temperature differential across the evaporator dropped below the minimum

Diff evap min/week Indicates how many times within a 7-day period the temperature differential across the evaporator may drop below the minimum.

Cur diff evap min/week Number of times within a 7-day period the temperature differential across the evaporator dropped below the minimum. If the value lies above setting "Diff evap min/week", ...

- symbol  appears on the display, and
- a maintenance message on the info level: 16:Diff evaporator min (priority 3).

Reset This parameter can be reset, provided the respective access right is granted.

Time interval for ventilation maintenance

Maintenance interval ventilation	Setting of the time interval (in hours) in which the ventilation must be maintained.
Time since maintenance ventilation	Expired time (in hours) since the last maintenance. If the value is above the setting "Maintenance interval ventilation", ... <ul style="list-style-type: none"> • On the display, the symbol  displays and • On the info level, the corresponding maintenance message: <ul style="list-style-type: none"> 26: Maintenance interval ventilation 1 expired (priority 6) 27: Maintenance interval ventilation 2 expired (priority 6) 28: Maintenance interval ventilation 3 expired (priority 6)
Reset	The parameter can be reset with the appropriate access rights.



Interval for maintenance of DHW storage tank

DHW storage tank interval	Setting the interval (in months) at which the DHW storage tank must be serviced.
DHW stor tank since maint	Period of time (in months) since the last service visit. If the value lies above setting "DHW storage tank interval", ... <ul style="list-style-type: none"> • symbol  appears on the display, and • a maintenance message on the info level: 11: DHW stor tank interval (priority 6).
Reset	This parameter can be reset, provided the respective access right is granted.

Minimum DHW charging temperature

DHW charg temp HP min	Minimum temperature level to which the DHW storage tank needs to be charged by the heat pump without aborting charging.
Curr DHW charg temp HP	The controller stores the DHW temperature at which charging by the heat pump was aborted last because the heat pump reached the limitation for high-pressure, hot-gas, or the maximum switch-off temperature. If the value lies below setting "DHW charg temp HP min", ... <ul style="list-style-type: none"> • symbol  appears on the display, and • a maintenance message on the info level: 12: DHW charg tempHP low (priority 6).
Reset	This parameter can be reset, provided the respective access right is granted. If the minimum DHW charging temperature is exceeded again next time the DHW storage tank is charged, the "Maintenance" function is canceled. But if not reached again, the maintenance message is maintained.

Line no.	Operating line
ACS	Maintenance message
ACS	Responsibility for message No display of responsibility Only display phone no Service Customer service Installer Janitor Administration Refrigeration engineer Hotline
ACS	Telephone responsibility for message
ACS	Displ event message electr immers heater Yes No

Maintenance message	Display of the currently pending maintenance message.
Responsibility for message	Display of responsibility for the currently pending maintenance message.
Telephone responsibility for message	Display of phone number of individual responsible for the currently pending maintenance message.
	<p> Display of text and phone number of the responsible individual are entered on operating lines 7180 through 7189.</p>
Displ event message electr immers heater	<p>An activated electric immersion heater (K6, K16, K25, K26) can be displayed on the connected operator unit with "EI imm heater on".</p> <p> Older operator units display the text "Event 5" rather than EI imm heater on".</p> <p>Yes The message is displayed on the operator unit.</p> <p>No The message is not displayed on the operator unit.</p>
Maintenance messages	A list of maintenance messages is available in Section 6.34.2.

Special operating functions

Economy mode

During intermediate seasons, the demand for heat can possibly be met by ecological heat sources, such as solar or wood-fired boilers. In that case, conventional producers such as heat pumps or electrical immersion heaters are locked. This option can be released or locked via "Economy function" (line 7119). Using operating line "Economy function", the enduser can switch off the heat pump or electrical immersion heaters for any desired period of time.

<i>Line no.</i>	<i>Operating line</i>
7119	Economy function Locked Released
7120	Economy mode Off On

Economy function

Locked

"Economy" mode is not possible.

Released

"Economy" mode can be activated.

Economy mode

Off

Economy mode is deactivated.

On

Economy mode is activated; all electric immersion heaters are locked and the heat pump is put into operation only if DHW charging is required.

Error response

Line no.	Operating line
7124	Substitute setpoint source
7125	Modbus T'out sub setpsourc
7126	Modbus T'out sub setpcasc
7127	LPB T'out sub setp source

Modbus

The error response can be configured. Parameters are available for souce and cascade master.

Note

Error recognition is described in section 6.22 "Modbus" at parameter 6658.

Source

Modbus T'out sub
setpsourc

The souce is and/or remains switched off.

0...600 min

For a Modbus communications error, the substitute value (OL 7124: "Substitute setpoint source") is enabled after the timeout.

Cascade master

Modbus T'out sub
setpcasc

The casecade is and/or remains switched off ausgeschaltet.

0...600 min

For a Modbus communications error, the substitute value (OL 7124: "Substitute setpoint source") is enabled after the timeout.

LPB

The error response can be configured. One parameter is available for the source and predefined response for the cascade master.

Note

Error recognition is described at the end of section 6.21 "LPB".

Source

LPB T'out sub setp
source

The source is and/or remains switched off.

0...600 Min

The substitute value (OL 7124: " Substitute setpoint source") is enabled after timeout and the source is enabled.

Cascade master

For local heat request (internal device requests) from the cascade master, the internal souce is enabled inspite of the LPB error.

No error response can be enabled for cascade slaves in the event of an LPB error, since the master no longer has access to these participants.

Heat requests, sent via LPB, become invalid after a timeout of 11 minutes.

Chimney sweep function

<i>Line no.</i>	<i>Operating line</i>
7130	Chimney sweep function Off On

The parameter or the chimney sweep function can trigger the chimney sweep function for the supplementary generator.

The heating oil or natural gas boiler, integrated as a supplementary generator, starts operation. All other heat generators are switched off.

Control occurs in one of the following variants:

- 2-position control to the setpoint on the selected control sensor via control relay K32 and the release relay K27 (see Line 3690...3755).
- Output of a 0..10V signal for a heat or temperature request via a Ux output. The signal corresponds to the setpoint for the common flow temperature setpoint (see Line 6070 / 6078).



The setting -.- on this operating line or the chimney sweep button switches off this function, or automatically after a timeout of 1 hour.

Relay states and Ux for a chimney sweep function

Configuration			Response on chimney sweep function	
			Burner output (preset via HW parameter 7131)	
K27	K32	Ux	Off	On
Yes	-	-	K27 =Off	K27 = On
-	Yes	-	K32=Off	K32 = On
-	-	Yes	Output Ux = 0	Output Ux = Setpoint Chimney sweep (line 3712)
Yes	Yes	-	K27 = On K32 = Off	K27 = On K32 = On
Yes	-	Yes	K27 = On Output Ux = 0	K27 = On Output Ux = Setpoint Chimney sweep (line 3712)
Yes	Yes	Yes	K27 = On K32 = Off Output Ux = 0	K27 = On K32 = On Output Ux = Setpoint Chimney sweep (Line 3712)

Manual interventions/simulations

Emergency operation

If the heat pump does not operate properly, emergency operation can be started. Emergency operation allows the plant to be operated with the available electric immersion heaters (flow, buffer storage tank, DHW storage tank). In that case, the compressor remains off.

Line no.	Operating line
7141	Emergency operation Off On
7142	Emergency op function type Manually Automatically

Emergency operation

Emergency operation can be manually switched on and off.

Off

Emergency operation is off.

On

Emergency operation is on.

Emergency op function type

Manually

Emergency operation can only be switched on and off via parameter "Emergency operation" (line 7141).

Automatically

- Emergency operation switches itself on whenever the heat pump becomes faulty. It switches itself off again when the fault is rectified and – if required – a reset is made.
- The functionality described under "Manual" is also available

Simulation

<i>Line no.</i>	<i>Operating line</i>
7150	Simulation outside temp

Simulation outside temp

To facilitate commissioning and fault tracing, outside temperatures in the range from -50...50 °C can be simulated. During simulation, the current, the composite and the attenuated outside temperature are overridden by the set simulated temperature.

During the simulation, calculation of the 3 mentioned outside temperatures continues and the temperatures are available again when the simulation is completed.

The function is deactivated by setting "-" on this operating line, or automatically after a timeout of 5 hours.

Defrosting, refrigerant

<i>Line no.</i>	<i>Operating line</i>
7152	Triggering defrost No Yes
7153	Pumping off refrigerant Off On

Triggering defrost

The heat pump's "Defrost" function can be manually triggered via this operating line.

Pumping off refrigerant

Pumping off the refrigerant can be manually triggered via this operating line.

Release wo source prot

Line no.	Operating line
7154	Release without source protection

The heat pump can be released without source monitoring as an exception.

The function allows plants to operate during a defined time until the necessary repairs can be made.

CAUTION

Only a properly trained heating technician may trigger this function. Switching on the heat pump without source protection can damage the pump depending on present operating conditions.

Triggering the function

The desired release time can be set to between 1 and 240 h with this parameter. The heat pump can be released without source protection as needed during this period.

Incorrect values or an interruption/short circuit of the source protection sensor is ignored.

The remaining time for heat pump operation without source protection is displayed at parameter 7154.

Ending the function

The function ends automatically after the set time expires.

The function ends immediately if parameter 7154 is manually set to 0 h.

Commissioning wizard

Line no.	Operating line
7167	Commissioning wizard On Off

The setting "on" starts the commissioning wizard when the controller is powered up. It permits a guided configuration of the basis unit (plant configuration, functions, system settings, and backup).

The commissioning wizard is only available on the UI operator units.

Definition of responsibilities

Line no.	Operating line
7180	Text responsibility No display of responsibility Only display of phone no. Service Customer service Installer Janitor Administration Refrigeration engineer Hotline
7181	Phone no. responsibility 1
7182	Text responsibility 2
7183	Phone no. responsibility 2
7184	Text responsibility 3
7185	Phone no. responsibility 3
7186	Text responsibility 4
7187	Phone no. responsibility 4
7188	Text responsibility 5
7189	Phone no. responsibility 5

Text responsibility...5

These operating lines are used to select the responsibility for text display of the relevant error and maintenance messages..

Phone no. responsibility 1...5

These operating lines are used to enter the phone nos. of personnel responsible for the relevant error and maintenance messages.



The assignment of error and maintenance messages to the 5 optional responsibilities is made via the ACS tool (parameter not documented).

Commissioning

Line no.	Operating line
7202	Commissioning heat pump Off Heating Cooling
7207	Outp selection HP modulating
7212	Outp selection HP multistage Off Compressor 1 Compressor 2 Compressor 1+2

Commissioning function

The commissioning function permits heat pump operations based on consumer requirements. Setting 7202 determines whether the heat pump is used for heating or cooling.

But the heat pump only turns on if the output selection (OL 7207 or 7212) was made.

The commissioning function ends for a power loss (7202 = Off).

The compressor does not automatically switch back on if the heat pump achieves a safety limit value during active commissioning. The output selection is reset in this case (7207 = 0%, 7212 = Off), but the actual commissioning function (OL 7202 = e.g. heating) remains active.

The commissioning function automatically switches off after 2 hours without manual changes to parameters 7202-7212.

Settings 7207, 7212, and 7226 are reset to default values after cancellation or manually switching off the commissioning function.

The parameters must be re-entered to reactivate the commissioning function.

Outp selection HP modulating

The setting defines the output (0...100 %) of a modulating heat pump during active commissioning. The heat pump is operated during active commissioning function at a set output.

Outp selection HP multistage

The setting defines the compressor stages of a staged heat pump during active commissioning function.

Special operating codes

A list of special operating codes is available in section 6.34.3.

Disable heat pump

<i>Line no.</i>	<i>Operating line</i>
7223	Disable heat pump Inactive Active

The heat pump can be disabled. This prevents, for example, the heat pump from operating before configuration is completed.

The function disables all components on the heat pump (compressor, pumps, valves). The "Manual disabled" appears in the "Status heat pump".

The consumers are no restricted by the parameter.

Exception

The heat pump or components thereof can be switched on in the following special operations despite active disable:

- **Emergency operation, manual** (OL 7141)
Permits temporary commissioning of the heat pump (pre-commissioning) to supply the plant with heat to protect the plant against frost. The automatic emergency mode is not released.
- **Commissioning heat pump**
- **Relay test, output test**

CAUTION

Improper use of special operations can damage the plant. Special operations may only be undertaken by heating engineers after ensuring that all requirements are met.

Heat pump monitoring

<i>Line no.</i>	<i>Operating line</i>
7226	Monitoring heat pump On, Critical only

A portion of the monitoring functions are disabled with parameter 7226 for the final check. The reduced monitoring only acts during active commissioning function (OL 7202).

The monitoring functions are active with **On**, only the most important monitoring functions are active with **Critical only**.

Sensor	OL	Monitoring function	OL 7226	
			On	Critical only
-	6123	Restart lock pumps	Active	Active
E9	-	Low pressure	Active	Active
E10	-	High pressure	Active	Active
E11, E12	-	Overload compressor 1	Active	Active
E14	-	Overload source	Active	Active
E20	-	Common fault HP	Active	Active
E21-E23	-	Network monitoring, Three phase monitoring	Active	Active
E25, E27	-	Fault soft starter	Active	Active
E26, E29	-	Pressure detector source	Active	Active
Hx	6142	Water pressure critical min (critical limit)	Active	Active
E15, E30	-	Flow detector source	Active	Inactive
E24	-	Flow detector consumer	Active	Inactive
Hx	2898	Min flow switch source	Active	Inactive
Hx	2899	Min flow switch consumers	Active	Inactive
B21, B71	2810	Condenser frost protection	aktiv ¹⁾	Inactive
B21	2809	Temp frost alarm	Active	Inactive
B21, B71	2970	Switch-off temp min	Active	Inactive
B21, B71	2844	Switch-off temp max	Active	Inactive
B91, B92	2815	Source temp min water	Active	Inactive
B91, B92	2814	Source temp max	Active	Inactive
B9	2812	Operation limit OT min air	Active	Inactive
B9	2813	Operation limit OT max air	Active	Inactive
B81, B82	2846	Hot-gas temp max	Active	Inactive
H82	2825	Min evaporation temp	Active	Inactive
H82	2826	Max evaporation temp	Active	Inactive
H83	2785	Max condensation temp	Active	Inactive

- 1) Only switching off actions are active during cooling. During active commissioning function, the compressor and electrical immersion heating are no switched on by the frost protection function.

6.26 Configuring the extension modules

Function of extension modules

Line no.	Operating line
7300	Function extension module 1, 2 und 3
7375	None Multifunctional Heating circuit 1 Heating circuit 2 Heating circuit 3 Solar DHW Primary contr/system pump DHW primary controller Instantaneous water heater Cooling circuit 1 Heating circ/cooling circ 1 Solid fuel boiler Cooling circuit 2 Heating circ/cooling circ 2 Cooling circuit 3 Heating circ/cooling circ 3 DHW interm circuit controller
7450	

When selecting a function, the extension module's inputs and outputs are assigned functions according to the following table:

Electrical connections

Connection terminal on the module	QX21	QX22	QX23	BX21	BX22	H2/H21	H22
Multifunctional	*	*	*	*	*	*	*
Heating circuit 1	Y1	Y2	Q2	B1	*	*	*
Heating circuit 2	Y5	Y6	Q6	B12	*	*	*
Heating circuit 3	Y11	Y12	Q20	B14	*	*	*
Solar DHW	*	*	Q5	B6	B31	*	*
Primary contr/system pump	Y19	Y20	Q14	B15	*	*	*
DHW primary controller	Y31	Y32	Q3	B35	*	*	*
Instantaneous water heater	Y33	Y34	Q34	B38	B39	FS	*
Cooling circuit 1	Y23	Y24	Q24	B16	*	*	*
Heating circ/cooling circ 1	Y1	Y2	Q2	B1	*	*	*
Solid fuel boiler	Y9	Y10	Q10	B72	B22	*	*
Cooling circuit 2	Y41	Y42	Q28	B17	*	*	*
Heating circ/cooling circ 2	Y5	Y6	Q6	B12	*	*	*
Cooling circuit 3	Y43	Y44	Q29	B18	BX22	*	*
Heating circ/cooling circ 3	Y11	Y12	Q20	B14	BX22	*	*
DHW interm circuit controller	Y37	Y38	Q33	B36	*	*	*

* Freely selectable in QX.../BX...

FS = DHW flow switch; AVS75.390 = H2; AVS75.370 = H21

QX extension module Defines usage of the Qx relay outputs.

Line no.	Operating line
7301 7376 7451	Relay output QX21 module 1, 2, 3
7302 7377 7452	Relay output QX22 module 1, 2, 3
7303 7378 7453	Relay output QX23 module 1, 2, 3
	None Compressor 2 K2 Process revers valve Y22 Hot-gas temp K31 El imm heater 1 flow K25 El imm heater 2 flow K26 Div valve cool source Y28 System pump Q14 Cascade pump Q25 Heat gen shutoff valve Y4 El imm heater DHW K6 Circulating pump Q4 St tank transfer pump Q11 DHW interm circ pump Q33 DHW mixing pump Q35 Collector pump Q5 Collector pump 2 Q16 Solar pump ext exch K9 Solar ctrl elem buffer K8 Solar ctrl elem swi pool K18 El imm heater buffer K16 Cons circuit pump VK1 Q15 Cons circuit pump VK2 Q18 Swimming pool pump Q19 Heat circuit pump HC3 Q20 2nd pump speed HC1 Q21 2nd pump speed HC2 Q22 2nd pump speed HC3 Q23 Div valve HC/CC1 Y21 Air dehumidifier K29 Heat request K27 Refrigeration request K28 Alarm output K10 Time program 5 K13 Heat circuit pump HC1 Q2 DHW ctrl elem Q3 Source pump Q8/fan K19 Condenser pump Q9 Compressor stage 1 K1 Suppl source control K32 Heat circuit pump HC2 Q6 Instant WH ctrl elem Q34 Common flow valve Y13 Div valve HC/CC2 Y45 Div valve HC/CC3 Y46 Cooling circ pump CC1 Q24 Cooling circ pump CC2 Q28 Cooling circ pump CC3 Q29 Solid fuel boiler pump Q10 Flue gas relay K17 Assisted firing fan K30 Crankcase heater K40 Drip tray heater K41 Valve evaporator K81 Valve EVI K82 Valve injection capillary K83 dT controller 1 K21 dT controller 2 K22 Ventilation fan 1 K51 Ventilation fan 2 K52 Ventilation fan 3 K53 Ventilation bypass 1 K54 Ventilation bypass 2 K55 Ventilation bypass 3 K56 Outside air temp contr Q17 Source int circ pump Q81 Source int circ div Y81 DHW heat pump K33 System pump 2 Q44 Div valve cooling cond Y27 Div valve cooling flow Y29 Cond reversing valve Y91 Buffer reversing valve Y47 Status info heating K42 Status info cooling K43 Status info DHW charg K44 Heat/cool circ pump 1 Q2 Heat/cool circ pump 2 Q6 Heat/cool circ pump 3 Q20 Status info generation K45 Fault info generation K46

Refer to the function descriptions, operating line "Relay output QX1".

BX extension module

Defines usage of the BX sensor inputs.

Line no.			Operating line
Mod. 1	Mod. 2	Mod. 3	
7307	7382	7457	Sensor input BX21 module 1, 2, 3
7308	7383	7458	Sensor input BX22 module 1, 2, 3 None Buffer sensor B4 Buffer sensor B41 Collector sensor B6 DHW sensor B31 Hot-gas sensor B82 Refrig sensor liquid B83 DHW charging sensor B36 DHW outlet sensor B38 DHW circulation sensor B39 Swimming pool sensor B13 Collector sensor 2 B61 Solar flow sensor B63 Solar return sensor B64 Buffer sensor B42 Common flow sensor B10 Cascade return sensor B70 Special temp sensor 1 Special temp sensor 2 DHW sensor B3 HP flow sensor B21 HP return sensor B71 Hot-gas sensor B81 Outside sensor B9 Source inlet sensor B91 Source outl sens B92/B84 Room sensor B5 Room setp readjustment 1 Room sensor B52 Room setp readjustment 2 Room sensor B53 Room setp readjustment 3 Flue gas temp sensor B8 Solid fuel boiler sensor B22 Solid fuel boil ret sens B72 Suction gas sensor B85 Suction gas sensor EVI B86 Evaporation sensor EVI B87 DHW prim contr sensor B35 Outside air sensor B19 Common flow sensor 2 B11 Common return sensor B73 Source int circ flow B93 Source int circ return B94 Suction gas sensor cool B88

Refer to function descriptions, operating line "Sensor input BX1".

H2 on extension - modules 1, 2 and 3

Line no.			Operating line
Mod. 1	Mod. 2	Mod. 3	
7311	7386	7461	Function input H2 module 1, 2, 3 None Op'mode change zones+DHW Optg mode changeover DHW Op'mode changeover zones Op'mode changeover zone 1 Op'mode changeover zone 2 Op'mode changeover zone 3 Error/alarm message Consumer request VK1 Consumer request VK2 Release swi pool source heat Release swi pool solar Operating level DHW Operating level HC1 Operating level HC2 Operating level HC3 Room thermostat HC1 Room thermostat HC2 Room thermostat HC3 DHW flow switch Dewpoint monitor Flow temp setp incr hygro Swi-on command HP stage 1 Swi-on command HP stage 2 Status info suppl source Charg prio DHW sol fuel boil Ventilation switch 1 Ventilation switch 2 Ventilation switch 3 Consumer request VK1 10V Consumer request VK2 10V Pressure measurement 10V Humidity measurement 10V Room temp 10V Flow measurement 10V Temp measurement 10V
7312	7387	7462	Contact type H2 module 1, 2, 3 NC NO
7314	7389	7464	Voltage value 1 H2 module 1, 2, 3
7315	7390	7465	Funct value 1 H2 module 1, 2, 3
7316	7391	7466	Voltage value 2 H2 module 1, 2, 3
7317	7392	7467	Funct value 2 H2 module 1, 2, 3

The settings for input H2 on the extension module correspond to a large extent to those for the HX inputs on the basic unit (without pulse count, flow measurement Hz). For descriptions, refer to operating line "Function input H1, H3" and following.

Temperature sensor H2

Line no.			Operating line
Mod. 1	Mod. 2	Mod. 3	
7318	7393	7468	Temp sensor H2 module 1, 2, 3 None Solar flow sensor B63 Solar return sensor B64 HP flow sensor B21 HP return sensor B71

Defines the temperature acquired by the sensor connected to "Input H2 module 1....3" (solar flow/return or heat pump flow/return). The controller uses the acquired temperature to control the respective plant component.



If, for temperature acquisition, the same sensor is defined at Bx and Hx, the sensor connected to Bx is given priority.

Function input H21

Line no.			Operating line
Mod. 1	Mod. 2	Mod. 3	
7321	7396	7471	Function input H21 module 1, 2, 3 None Op'mode change zones+DHW Optg mode changeover DHW Op'mode changeover zones Op'mode changeover zone 1 Op'mode changeover zone 2 Op'mode changeover zone 3 Error/alarm message Consumer request VK1 Consumer request VK2 Release swi pool source heat Release swi pool solar Operating level DHW Operating level HC1 Operating level HC2 Operating level HC3 Room thermostat HC1 Room thermostat HC2 Room thermostat HC3 DHW flow switch Pulse count Dewpoint monitor Flow temp setp incr hygro Swi-on command HP stage 1 Swi-on command HP stage 2 Status info suppl source Charg prio DHW sol fuel boil Ventilation switch 1 Ventilation switch 2 Ventilation switch 3 Flow measurement Hz Consumer request VK1 10V Consumer request VK2 10V Pressure measurement 10V Humidity measurement 10V Room temp 10V Flow measurement 10V Temp measurement 10V Air quality measurement 10V
7322	7397	7472	Contact type H21 module 1, 2, 3 NC NO
7324	7399	7474	Input value 1 H21 module 1
7325	7400	7475	Funct value 1 H21 module 1
7326	7401	7476	Input value 2 H21 module 1
7327	7402	7477	Funct value 2 H21 module 1
7328	7403	7478	Temp sensor H21 module 1 None Solar flow sensor B63 Solar return sensor B64 HP flow sensor B21 HP return sensor B71

The settings for input H21 on the extension module correspond to those for the Hx inputs on the controller. For descriptions, refer to operating line "Function input H1, H3" and following.

Function input H22

Line no.			Operating line
Mod. 1	Mod. 2	Mod. 3	
7331	7406	7481	Function input H22 module 1, 2, 3 Ditto 7321
7332	7407	7482	Contact type H22 module 1, 2, 3
7334	7409	7484	Input value 1 H22 module 1, 2, 3
7335	7410	7485	Funct value 1 H22 module 1, 2, 3
7336	7411	7486	Input value 2 H22 module 1, 2, 3
7337	7412	7487	Funct value 2 H22 module 1, 2, 3
7338	7413	7488	Temp sensor H22 module 1, 2, 3 None Solar flow sensor B63 Solar return sensor B64 HP flow sensor B21 HP return sensor B71

The settings for input H22 on the extension module correspond to those for the Hx inputs on the controller. For descriptions, refer to operating line "Function input H1, H3" and following.

Voltage output GX21

Line no.			Operating line
Mod. 1	Mod. 2	Mod. 3	
7341	7416	7491	Voltage out GX21 module 1, 2, 3 5 Volt 12 Volt

Defines the voltage used by the extension module for powering the external sensor.

Function input EX21

Line no.			Operating line
Mod. 1	Mod. 2	Mod. 3	
7342	7417	7492	Funct input EX21 module 1, 2, 3 None Electrical utility lock E6 Low-tariff E5 Overload compressor 2 E12 Overload source E14 Pressure switch source E26 Flow switch source E15 Flow switch consumers E24 Manual defrost E17 Common fault HP E20 Fault soft starter E25 Low-pressure switch E9 High-pressure switch E10 Overload compressor 1 E11 Error/alarm message Mains supervision E21 Fault soft starter 2 E27 Pressure diff defrost E28 Pres sw source int circ E29 Flow sw source int circ E30 Smart grid E61 Smart grid E62 Low-pressure switch 2 E31 High-pressure switch 2 E32 Defrost message E33 Photovoltaics E64 SHC error message E34 SHC 2 error message E35

The settings for input EX21 on the extension module correspond to those for the EX inputs on the controller. For descriptions, refer to operating line "Function input EX1".

Contact type EX21

Line no.			Operating line
Mod. 1	Mod. 2	Mod. 3	
7343	7418	7493	Cont type inp EX21 module 1, 2, 3 NC NO

The type of contact can be selected:

NC

The input's function is active when voltage is not present.

NO

The input's function is active when voltage is present.



The descriptions of the functions of the EX contact apply when an NO contact is selected.

Function output UX21

Line no.			Operating line
Mod. 1	Mod. 2	Mod. 3	
7348	7423	7498	Funcnt output UX21 module 1, 2, 3 None Source pump Q8/fan K19 DHW pump Q3 DHW interm circ pump Q33 Heat circuit pump HC1 Q2 Heat circuit pump HC2 Q6 Heat circuit pump HC3 Q20 Collector pump Q5 Solar pump ext exch K9 Solar pump buffer K8 Solar pump swi pool K18 Collector pump 2 Q16 Instant WH pump Q34 Solid fuel boiler pump Q10 Condenser pump Q9 Heat/cool circ pump 1 Q2 Heat/cool circ pump 2 Q6 Heat/cool circ pump 3 Q20 HP setpoint Output request Heat request Refrigeration request Compressor modulation Expansion valve evapor V81 Expansion valve EVI V82 Ventilation fan 1 K51 Ventilation fan 2 K52 Ventilation fan 3 K53
7349	7424	7499	Sign logic out UX21 module1, 2, 3 Standard Inverted
7350	7425	7500	Signal output UX21 module 1, 2, 3 0..10V PWM
7354	7429	7504	Temp val 10V UX21 module1, 2, 3

The settings for output UX21 on the extension module correspond to those for the UX outputs on the controller. For descriptions, refer to operating line "Function output UX1 and UX2" and following.

Function output UX22

Line no.			Operating line
Mod. 1	Mod. 2	Mod. 3	
7355	7430	7505	Funcnt output UX22 module 1, 2, 3 Ditto 7348
7356	7431	7506	Sign logic out UX22 module1, 2, 3 Standard Inverted
7357	7432	7507	Signal output UX22 module 1, 2, 3 0..10V PWM
7361	7436	7511	Temp val 10V UX22 module1, 2, 3

The settings for output UX22 on the extension module correspond to those for the Ux outputs on the controller. For descriptions, refer to operating line "Function output UX1 and UX2" and following.

Electronic expansion valves

The RVS61 heat pump controller (including its extension modules) is capable of controlling electronic expansion valves for 2 different applications:

1. Expansion valve evapor V81: Control valve for the superheat controller (SHC).
2. Expansion valve EVI V82: Control valve for vapor injection (EVI).

The electronic expansion valves are controlled either via a stepper motor (output WX) or a voltage signal DC 0...10 V (output UX).

For both applications, 2 additional sensors are required, 1 for pressure (input HX) and 1 for temperature (input BX).



For DC 0...10 V signal control, parameter "Expansion valve run time" (line 3046) is required, for control with the stepper motor, a number of settings are required; for description, refer to line 7362 ("Funct output WX21 module 1").

Restrictions in connection with extension modules

When controlling electronic expansion valves via extension modules (connected to outputs UX21, UX22, WX21), the following restrictions should be considered:

- Per extension module, only 1 electronic expansion valve for application 1 (V81 or V82) can be controlled
- Valve and sensor of an application must be connected to and configured for the same extension module (no split between basic unit and extension module or several extension modules)

Function of output WX21

Line no.			Operating line
Mod. 1	Mod. 2	Mod. 3	
7362	7437	7512	Funct output WX21 module 1, 2, 3 None Expansion valve evapor V81 Expansion valve EVI V82

- "Expansion valve evapor V81" for superheat control (SHC).
- "Expansion valve EVI V82" for vapor injection (EVI).

**Connection WX21 for
stepper motors**

Output WX21 controls valves driven by stepper motors.

The controller's standard settings are suited for use with Siemens valves VEL 71.xx and coils SRA91.xx (refer to chapter "Summary").



The parameters required for stepper motor control are accessible via the ACS tool.

Connections of extension module AVS75.370:

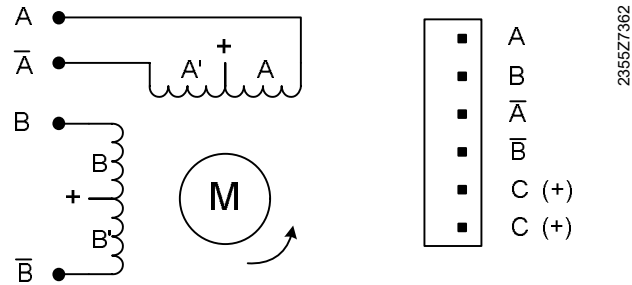

The stepper motor is excited via 8 successive cyclic electrical states. Each change of state performs a single step.

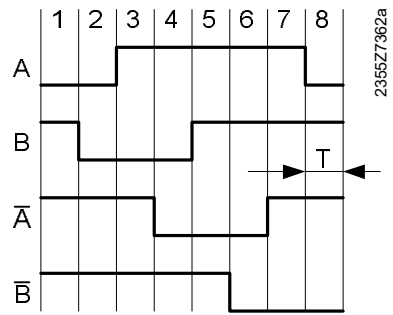

$T [s] = 1/\text{step rate}$

For the other direction of rotation, the states are run through in the reverse order.

Basic settings

Line no.	Operating line
ACS	Rotating direction WX21 module 1, 2, 3 Standard Inverted
ACS	Operating mode WX21 module 1, 2, 3 Halbschritt Vollschritt 1-phasig
ACS*	Step rate WX21 module 1, 2, 3

* Number of steps are always calculated as half-steps

Rotating direction WX21 module 1, 2, 3 (ACS)

The direction of rotation required to open or close a valve depends on the valve supplier.

Parameter "Rotating direction WX21 module 1..3" (ACS) can be used to adjust the step sequence and thus the direction of rotation.

Standard

Closing: Steps 1...8, opening: Steps 8...1

Inverted

Closing: Steps 8...1, opening: Steps 1...8

Operating mode WX21 module 1, 2, 3 (ACS)

The step sequence is run through depending on the selected operating mode.

Halbschritt

All steps 1...8 are run through.

Vollschritt 1-phasig

Only steps 1, 3, 5, and 7 are run through. This leads to a smaller resolution and lower power consumption.



Usually, electronic expansion valves (EEV) use the half-step mode.

Step rate WX21 module 1, 2, 3 (ACS)

The step rate (number of steps per second) can be set via parameter "Step rate WX21 module 1...3" (ACS). It defines the temporal output of the step sequence.

Position model

Line no.	Operating line
ACS*	Number of steps WX21 module 1, 2, 3
ACS*	Steps at setpoint 0% WX21 module 1, 2, 3
ACS*	Steps at setpoint 100% WX21 module 1, 2, 3
ACS*	Steps overdrive WX21 module 1, 2, 3

* Number of steps are always calculated as half steps

To map the actual behavior of a valve under control conditions, the controller uses a position model.

Usually, in the valve's lower positioning range, the flow rate is close to zero and only the valve's closing force changes.

Even in the upper positioning range, the flow rate changes only slightly.

The position model takes this into consideration and shifts the control range (stroke setpoint 0...100%) to the step range ($S_{0\%}$... $S_{100\%}$), where the flow rate changes significantly.

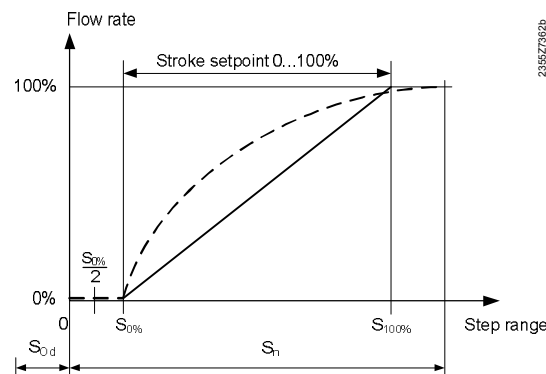

- - - : Real valve characteristic

—: Valve model

Number of steps WX21 module 1, 2, 3

Steps at setpoint 0% WX21 module 1, 2, 3

Steps at setpoint 100% WX21 module 1, 2, 3

- The valve can travel in both directions by a maximum number of steps S_n
- Setting the number of steps reached when the stroke setpoint is 0%
- Setting the number of steps reached when the stroke setpoint is 100%

$$\text{Step position} = (S_{100\%} - S_{0\%})/100 [\%] * \text{stroke setpoint} [\%] + S_{0\%}$$

- If the stroke setpoint becomes invalid (control off), the valve is not fully closed, but only until position $S_{0\%}/2$ is reached, which extends the valve's life considerably
- If the valve is operated in reverse mode (process reversal), the valve is pushed open at high pressure differentials. For this reason, when in reverse mode and closing, the valve is always driven to position 0 to ensure tightness at maximum pressure
- In the control range, the valve's characteristic is assumed to be linear

Steps overdrive WX21 module 1, 2, 3

Overdriving means to go through additional steps (S_{0d}) starting from position 0. This ensures that the valve is securely closed, which means that it has reached its mechanical end position.

The number of overdrive steps can be set via "Steps overdrive WX21 module 1...3" (ACS).

Calibration

Stepper motors can lose steps. This means that, over time, the actual position deviates from the calculated position. And, in the event of a power failure, the valve's position is lost altogether. For this reason, the valve must be calibrated.

There are 2 types of calibration methods available:

1. The valve is driven toward its mechanical end position 0 by the total number of steps S_n , **regardless of its position** and, in addition, overdriven by the number of steps S_{Od} .
 2. **Starting from the calculated position**, the valve is driven to its mechanical end position 0 and, in addition, overdriven by the number of steps S_{Od} .
- Calibration method (1) is only used after a power failure, with Power-Up, calibration method (2) is used periodically
 - After calibration, the mechanical valve position accords again with the internally stored step position (end position 0)

Calibration WX21 module
1, 2, 3

Line no.	Operating line
ACS	Calibration WX21 module 1, 2, 3

"Calibration WX21 module 1...3" (ACS) is used to set the time for the next periodic calibration.



For periodic calibration, calibration method (2) is always used.

The overview below shows events and settings as well as the associated calibration methods and valve behaviors:

Event/setting	Calibration/method	Response
Periodic calibration		
Compressor off and calibration period not reached	No	Closing to position $S_{0\%}/2$
Compressor off and calibration period reached	Yes, method 2	Closing to position $S_{0\%} + S_{Od}$
Compressor off and calibration period = "0 h"	Yes, method 2 with each off	Closing to position $S_{0\%} + S_{Od}$
Compressor off and calibration period = "- -"	Never	Closing to position $S_{0\%}/2$
Non-periodic calibration		
Power up upon power down	Yes, method 1	Closing by $S_n + S_{Od}$
Quit output test	Yes, method 2	Closing to position $S_{0\%} + S_{Od}$

6.27 Diagnostics Modbus slave

<i>Line no.</i>	<i>Operating line</i>
Port 1	
7610	Input signal BX port 1
7611	Input signal UX port 1
7612	Input state QX port 1
7613	Input state EX port 1
7614	Input signal 1 port 1
7616	Output signal UX port 1
7617	Output state QX port 1
7618	Output signal 1 port 1
Port 2...8	
7620	dito
...	
7688	dito

Display of virtual Modbus inputs/outputs. See section "6.23".

6.28 Input/output test

The input/output test is used to check the correct functioning of the connected plant components.

Output test relays

When selecting a setting from the relay test, the relevant relay is energized, thus putting the connected component into operation.

Line no.	Operating line
7700	Relay test No test Everything off Relay output QX1 Relay output QX2 Relay output QX3 Output QX4/ZX4 Relay output QX5 Relay output QX6 Relay output QX7 Relay output QX8 Relay output QX9 Relay output QX10 Relay output QX11 Relay output QX12 Relay output QX13 Relay output QX21 module 1 Relay output QX22 module 1 Relay output QX23 module 1 Relay output QX21 module 2 Relay output QX22 module 2 Relay output QX23 module 2 Relay output QX21 module 3 Relay output QX22 module 3 Relay output QX23 module 3

CAUTION	When making the relay test, limitations are not active.
----------------	---



- When using a multifunctional output for compressor K1, the output will be deactivated for about 1 to 2 seconds.
- After 8 minutes, the relay test switches itself automatically off (timeout).

Triac output test (ZX4 modulated)

By selecting a setting from output test ZX4, an appropriate signal is delivered, allowing checking.

Line no.	Operating line
7705	Mod setpoint ZX4 relay test
7708	Modulation signal ZX4

Mod setpoint ZX4 relay test

When the relay test is active ("Relay test" = "Output QX4/ZX4"), the modulation value set here is delivered via triac output ZX34.

Modulation signal ZX4

Shows the modulation value currently delivered via triac output ZX4.

Output test: UX1/UX2

By selecting a setting from output test UX1 or UX2, an appropriate signal is delivered or displayed, allowing checking.

Line no.	Operating line
7710	Output test UX1
7711	Output signal UX1
7711	[Output signal UX1] Voltage V PWM %
7716	Output test UX2
7717	Output signal UX2
7717	[Output signal UX2] Voltage V PWM %

Output test UX1/UX2

The value entered here is delivered via output UX.

"---": Test is not active. Controller sets the value.

Output signal UX1/UX2,
[Output signal UX1/UX2]

Shows the value currently delivered and its type of signal.

Output test UX21/UX22

By selecting a setting from output test UX21 or UX22, an appropriate signal is delivered or displayed, allowing checking.

Line no.			Operating line
Mod. 1	Mod. 2	Mod. 3	
7780	7784	7788	Output test UX21 module 1, 2, 3
7781	7785	7789	Output signal UX21 module 1, 2, 3
7781	7785	7789	[Output signal UX21 module 1, 2, 3] Voltage V PWM %
7782	7786	7790	Output test UX22 module 1, 2, 3
7783	7787	7791	Output signal UX22 module 1, 2, 3
7783	7787	7791	[Output signal UX22 module 1, 2, 3] Voltage V PWM %



See operating line 7710 ff.

Stepper motor output test

By selecting a setting from the stepper motor output test, an appropriate signal is delivered or displayed.

Line no.			Operating line
Mod. 1	Mod. 2	Mod. 3	
7796	7798	7800	Output test WX21 module 1, 2, 3
7797	7799	7801	Pos step motor WX21 mod 1, 2, 3

Output test WX21

The stepper motor is driven to the position set here.

Pos step motor WX21

Shows the current position of the stepper motor.

Sensor input test

By selecting a setting from the sensor input test, the relevant input is displayed, allowing checking.

Line no.	Operating line
7804	Sensor temp BX1
7805	Sensor temp BX2
7806	Sensor temp BX3
7807	Sensor temp BX4
7810	Sensor temp BX7
7811	Sensor temp BX8
7812	Sensor temp BX9
7813	Sensor temp BX10
7814	Sensor temp BX11
7815	Sensor temp BX12
7816	Sensor temp BX13
7817	Sensor temp BX14
7830	Sensor temp BX21 module 1
7831	Sensor temp BX22 module 1
7832	Sensor temp BX21 module 2
7833	Sensor temp BX22 module 2
7834	Sensor temp BX21 module 3
7835	Sensor temp BX22 module 3

Sensor temperature Bx

Shows the temperature acquired by the sensor. The selected sensor values are refreshed within a maximum of 5 seconds. The display is made with no measured value correction.

Input test Hx

By selecting a setting from the Hx input test, the respective input is displayed.

Line no.	Operating line
7844	Input signal H1
7844	[Output signal H1] None Closed (ooo), Open (---) Pulse Frequency Hz Voltage V
7858	Input signal H3
7858	[Output signal H3] None Closed (ooo), Open (---) Pulse Frequency Hz Voltage V

Input signal H1/H3
[Output signal H1/H3]

Shows the current input value and its type of signal.

By selecting a setting from the Hx input test, the respective input is displayed.

Line no.			Operating line
Mod. 1	Mod. 2	Mod. 3	
7845	7847	7849	Input signal H2 module 1, 2, 3
7845	7847	7849	[Output signal H2 module 1, 2, 3] None Closed (ooo), Open (---) Frequency Hz Voltage V
7845	7847	7849	Input signal H21 module 1, 2, 3
7845	7847	7849	[Output signal H21 module 1, 2, 3] None Closed (ooo), Open (---) Pulse Frequency Hz Voltage V
7846	7848	7850	Input signal H22 module 1, 2, 3
7846	7848	7850	[Output signal H22 module 1, 2, 3] None Closed (ooo), Open (---) Pulse Frequency Hz Voltage V



H2 and H21 never occur at the same time.

Input signal H2/H21/H22,
[signal type H2/H21/H22]

Shows the current input value and its type of signal.

Input test EX...

By selecting a setting from the sensor input test, the relevant input is displayed, allowing checking.

Line no.	Operating line
7911	Input EX1
7912	Input EX2
7913	Input EX3
7914	Input EX4
7915	Input EX5
7916	Input EX6
7917	Input EX7
7919	Input EX9
7945	Input EX10
7946	Input EX11
7950	Input EX21 module 1
7951	Input EX21 module 2
7952	Input EX21 module 3

The display of "0 V" means that no voltage is applied. "230 V" means that AC 230 V is available at the respective input.

Modbus test parameters

Line no.	Operating line
ACS	Output test Modbus Port 1...8
ACS	Output state Modbus Port 1...8
ACS	Output signal Modbus Port 1...8
ACS	Input signal Modbus Port 1...8

Every Modbus port offers the following test parameters and display values:

Output test Modbus Port 1...8

0...100

The actuator is controlled with the degree of modulation set here (in %), regardless of the current control state.

"_ _ _"

The output test is deactivated. The control determines the output value.

Output state Modbus Port 1...8

0 or 1

Shows the positioning command currently output to the actuator (0: off, 1: on).

Output signal Modbus Port 1...8

0...100

Shows the degree of modulation (in %) currently output to the actuator.

Input signal Modbus Port 1...8

0...100

Shows the degree of modulation (in %) currently fed back by the actuator.

Putting Modbus in operation

Steps to be taken to put Modbus in operation:

1. Connect Modbus clip-in OCI350.01/OCI351.01 via the enclosed 6-pole connecting cable to the RVS61 (socket X60).
2. Interconnect the Modbus devices (A+, B-, REF).
3. Switch on the terminating resistor at the first and last Modbus device (on OCI350.01/OCI351.01 via DIP switches).
4. Perform Power Up on the RVS61.
5. Make the parameter settings ("Modbus" menu).

Function test

1. Check LED (yellow) on the OCI350.01/OCI351.01:
 - Off: No communication (e.g. no connection).
 - Flashing: Telegrams are received or sent.
2. The following error messages must no longer appear:
 - "495:Modbus no comm'cation"; e.g. actuator missing.
 - "500:Modbus configuration"; e.g. device other than the selected connected.
3. Check actuator functions using the "Modbus test parameters".



Also, the Modbus actuators might offer additional test choices.

6.29 State

The current operating state of the plant is visualized in the form of state displays. Usually, this takes place in the form of info texts.

Messages

Line no.	Operating line
8000	State heating circuit 1
8001	State heating circuit 2
8002	State heating circuit 3
8003	State DHW
8004	State cooling circuit 1
8006	State heat pump
8007	State solar
8008	State solid fuel boiler
8010	State buffer
8011	State swimming pool
8022	State supplementary source
8025	State cooling circuit 2
8026	Status cooling circuit 3
8027	State ventilation 1
8028	State ventilation 2
8029	State ventilation 3
8030	State consumer circuit 1
8031	State consumer circuit 2

The following state messages (all tables) represent messages of the Albatros2 range which do not necessarily apply to all types of controllers.

State heating circuit 1...3

End-user (info level)	Commissioning, heating engineer	State code*
Limiter has tripped	Limiter has tripped	3
Manual control active	Manual control active	4
Floor curing function active	Floor curing function active	102
Heating mode restricted	Overtemp prot active	56
	Restricted, boiler protection	103
	Restricted, DHW priority	104
	Restricted, buffer	105
		106
Forced draw	Forced draw buffer	107
	Forced draw DHW	108
	Forced draw source	109
	Forced draw	110
	Overrun active	17
		110
Party function active	Party function active	236
Warmer function active	Warmer function active	298
Cooler function active	Cooler function active	299
Comfort heating mode	Opt start ctrl+boost heating	111
	Optimum start control	112
	Boost heating	113
	Comfort heating mode	114
Reduced heating mode	Optimum stop control	115
	Reduced heating mode	116
Frost protection active	Frost prot room active	101
	Frost protection flow active	117
	Frost prot plant active	23
		24
Continuous pump operation	Continuous pump operation	248
Summer operation	Summer operation	118
Off	24-hour Eco active	119
	Setback reduced	120
	Setback frost protection	121
	Room temp limitation	122
	Locking time after cooling	288
	Off	25

State DHW

End-user (info level)	Commissioning, heating engineer	State code*
Limiter has tripped	Limiter has tripped	3
Manual control active	Manual control active	4
Consumption	Consumption	199
Keep hot mode on	Keep hot mode active	222
	Keep hot mode on	221
Recooling active	Recooling via collector	77
	Recooling via heat gen/HCs	78
		53
Charging lock active	Discharging prot active	79
	Charg time limitation active	80
	Charging locked	81
	El imm heater locked	271
	Limit source temp min	28
		82
Forced charging active	Forced, max st tank temp	83
	Forced, max charging temp	84
	Forced, legionella setp	85
	Forced, nominal setp	86
		67
Charg opt energy, nominal	Charg opt energy, nominal	249
Charg opt energy, legio	Charg opt energy, legio	250
Charg opt energy EU, nom	Charg opt energy EU, nom	251
Charg opt energy EU, legio	Charg opt energy EU, legio	252
Charg el imm heater	El charging, legionella setp	87
	El charging, nominal setp	88
	El charging, reduced setp	89
	El charging, frost prot setp	90
	El imm heater released	91
		66
Push active	Push, legionella setp	92
	Push, nominal setp	93
		94
Charging active	Charging, legionella setp	95
	Charging, nominal setp	96
	Charging, reduced setp	97
		69
Frost protection active	Frost protection active	24
Overrun active	Overrun active	17
Transfer active	Transfer, legionella setpoint	237
	Transfer, nominal setpoint	238
	Transfer, reduced setpoint	239
	Frost protection active	24
		240
Hi-temp charging active	Hi-temp charging active	272
Restratification active	Restratification active	242
Standby charging	Standby charging	201
Charged	Charged, max st tank temp	70
	Charged, max charging temp	71
	Charged, legionella temp	98
	Charged, nominal temp	99
	Charged, reduced temp	100
		75
Off	Keep hot mode released	243
	Off	25
Ready	Ready	200

State cooling circuit 1...2

End-user (info level)	Commissioning, heating engineer	State code*
Dewpoint monitor active	Dewpoint monitor active	133
Manual control active	Manual control active	4
Fault	Fault	2
Frost protection active	Frost protection flow active	117 24
Cooling mode locked	Locked, heating mode Locked, heating mode Locked, source Locked, buffer	204 135 205 206 146
Cooling mode restricted	Temp drop protection active Flow temp setp incr hygro Limit flow min dewpoint Limit flow min OT	247 136 177 178 144
Cooler function active	Cooler function active	299
Warmer function active	Warmer function active	298
Cooling mode Comfort	Cooling mode Comfort Overrun active	150 17 150
Cooling mode Reduced	Cooling mode Reduced	285
Protection mode cooling	Protection mode cooling	149
Frost protection active	Frost prot plant active	23 24
Cooling limit OT active	Cooling limit OT active	134
Off	24-hour Eco active Room temp limitation Flow limit reached	119 122 179 25
Cooling mode off	Cooling mode off	138

State heat pump

End-user (info level)	Commissioning, heating engineer	Statuscode*
Emergency operation	Emergency operation	26
Fault	Fault	2
Water pressure too low	Water pressure too low	235
Locked	Locked, manual Locked, outside temp Locked, externally Locked, Economy mode Locked, solid fuel boiler Disabled, COP min Disabled, energy price Operation limit OT min Operation limit OT max Mains undervoltage 3-ph current asymmetric Low-pressure Limitation evap temp min Limitation evap temp max Fan overload Fault soft starter 1 Fault soft starter 2 Compressor 1 overload Compressor 2 overload Limit pres diff proc revers Source pump overload Flow switch consumers Limit source temp min water Limit source temp min brine Limit source temp max High-press HP in operation Limitation cond temp max Flow switch heat source Press switch heat source Flow switch source int circ Press switch source int circ Limit hot-gas compr1 Limit hot-gas compr2	8 176 27 198 172 294 295 187 188 10 246 180 181 268 270 182 273 274 183 184 289 185 186 189 190 191 29 269 30 31 275 276 32 33

	Limit switch-off temp max	34
	Limit swi-off temp max cool	145
	Limit switch-off temp min	139
	Compr off time min active	35
	Compens surplus heat	36
Limitation time active		37
Pumping off refrig, man	Pumping off refrig, man	254
	Frost protection HP	48
Frost protection active		24
	Forced defrost compressor	192
	Forced defrost fan	193
	Dripping	126
	Defrost with compressor	194
	Defrost with fan	195
Defrost active	Defrost active	125
	Pumping off refrigerant	256
	Comp run time min activ,cool	207
	Compr 1 and 2 on, cooling	208
	Compr 1 on, cooling mode	209
	Compr 2 on, cooling mode	210
Active cooling mode		127
	Cooling down evaporator	129
	Start delay defrost	257
	Compr run time min active	38
	Compensation heat deficit	39
	Preheating for defrost	130
	Pumping off refrigerant	256
	Limit diff condens max	40
	Limit diff condens min	41
	Limit diff evap max	42
	Limit diff evap min	43
	Compr and electric on	44
	Compressors 1 and 2 on	45
	Compressor 1 on	46
	Compressor 2 on	47
	Electric on	197
Heating mode		137
	Locked, source temp max	259
	Locked, source temp min	260
	Locked, return temp max	261
	Locked, return temp min	262
	Locked, flow temp max	263
	Locked, flow temp min	264
	Locked, cond temp max	265
	Locked, evap temp min	266
	Locked, hot-gas temp max	267
Compressor locked		258
	Limit source temp min cooling	196
Passive cooling mode	Passive cool mode disabled	296
	Passive cooling mode	128
	Frost prot plant active	23
Frost protection active		24
	Flow active	49

State solar

End-user (info level)	Commissioning, heating engineer	State code*
Manual control active	Manual control active	4
Fault	Fault	2
Frost prot collector active	Frost prot collector active	52
Recooling active	Recooling active	53
Max st tank temp reached	Max st tank temp reached	54
Evaporation prot active	Evaporation prot active	55
Overtemp prot active	Overtemp prot active	56
Max charging temp reached	Max charging temp reached	57
Charg DHW+buffer+swi pool	Charg DHW+buffer+swi pool	151
Charging DHW+buffer	Charging DHW+buffer	152
Charging DHW+swi pool	Charging DHW+swi pool	153
Charging buffer+swi pool	Charging buffer+swi pool	154
Charging DHW	Charging DHW	58
Charging buffer	Charging buffer	59
Charging swimming pool	Charging swimming pool	60
	Min charg temp not reached	61
	Temp diff insufficient	62
Radiation insufficient	Radiation insufficient	63

State solid fuel boiler

End-user (info level)	Commissioning, heating engineer	State code*
Manual control active	Manual control active	4
Fault	Fault	2
Overtemp prot active	Overtemp prot active	56
Assisted firing active	Assisted firing active	163
Protective start	Protective start	11
Return limitation	Return limitation	13
Overrun active	Overrun active	17
Residual heat usage	Residual heat usage	241
Charging DHW	Charging DHW	58
Charging buffer	Charging buffer	59
In operation	In operation	18
	Frost prot plant active	23
	Boiler frost prot active	141
Frost protection active		24
Off	Off	25

State buffer

End-user (info level)	Commissioning, heating engineer	State code*
Frost prot cooling active	Frost prot cooling active	202
	Locking time after heating	135
	Charging locked	81
Charging restricted		124
	Forced charging active	67
	Full charging active	203
Charging active		69
	Charged, forced temp	72
	Charged, required temp	73
	Charged, min charging temp	143
Charged		75
Hot	Hot	147
No request	No request	51
Frost protection active	Frost protection active	24
	Electric charging, forced	164
	Electric charging, substitute	165
Charg el imm heater		66
	Charging locked	81
	Restricted, DHW priority	104
Charging restricted		124
	Forced charging active	67
	Full charging active	203
Charging active		69
Source released	Source released	244
	Recooling via collector	77
	Recooling via DHW/HCs	142
Recooling active		53
	Charged, max st tank temp	70
	Charged, max charging temp	71
	Charged, forced temp	72

Charged	Charged, required temp	73
	Charged, min charging temp	143
		75
Cold	Cold	76
No request	No request	51

State swimming pool

End-user (info level)	Commissioning, heating engineer	State code*
Manual control active	Manual control active	4
Fault	Fault	2
Heating mode restricted	Heating mode restricted	106
Forced draw	Forced draw	110
Heating mode	Heating mode source	155
		137
Heated, max swi pool temp	Heated, max swi pool temp	156
	Heated, setpoint solar	158
	Heated, setpoint source	157
Heated		159
Heating mode off	Heating mode solar off	160
	Heating mode source off	161
		162
Cold	Cold	76

State supplementary source

End-user (info level)	Commissioning, heating engineer	State code*
Fault	Fault	2
Flow switch suppl source	Flow switch suppl source	297
Locked	Locked, solid fuel boiler	172
	Locked, outside temp	176
	Locked, Economy mode	198
	Locked	10
Charging buffer	Charging buffer	59
In op for HC, DHW	In op for HC, DHW	170
Released for HC, DHW	Released for HC, DHW	173
In operation for DHW	In operation for DHW	168
Released for DHW	Released for DHW	174
In operation for HC	In operation for HC	166
Released for HC	Released for HC	175
Overrun active	Overrun active	17
Off	Off	25

* HMI Basic (without text)

Status ventilation 1...3

End user (Info level)	Commissioning, heating engineer	Statuscode*
Ventilation switch	Ventilation switch	279
Boost ventilation	Boost ventilation	284
Manual operation	Manual operation	293
Humidity limitation	Humidity limitation	278
Air quality control	Air quality control	277
Night cooling	Night cooling	280
Automatic operation	Automatic operation	292

State consumer circuit



End-user (info level)	Commissioning, heating engineer	Statuscode*
---	---	
Manual control active	Manual control active	4
Heating mode restricted	Heating mode restricted	106
Cooling mode restricted	Cooling mode restricted	144
Forced draw	Forced draw	110
Heating mode	Heating mode	137
Cooling mode	Cooling mode	301
Frost prot plant active	Frost prot plant active	24
Off	Off	25

History

<i>Line no.</i>	<i>Operating line</i>
8050...8069	History 1...10, State code 1...10

The last 10 status messages are stored or displayed together with their state codes.

History 1 keeps the latest message, history 10 the oldest.

-  The status displays currently valid for the end-user can be retrieved directly via the room unit's info level.
-  Using the ACS 700 PC tool, the relevant actual values, setpoints and relay outputs can be displayed for each status message.

History

<i>Line no.</i>	<i>Operating line</i>
8070	Reset history No Yes

Reset historyThe state history with the last 10 status messages and the relevant status codes, actual values and setpoints plus the relay output states is cleared.

6.30 Diagnostics cascade

List of generators

<i>Line no.</i>	<i>Operating line</i>
8100, 8102, 8130	Priority/state source 1 ... Priority/state source 16
8101, 8103, 8131	Status producer 1 ... Status producer 16
ACS	Priority cooling source 1...16

Display of state and priority of the generators.

Setpoints/actual values

<i>Line no.</i>	<i>Operating line</i>
8138	Cascade flow temp
8139	Cascade flow temp setp
8140	Cascade return temp
8141	Cascade return temp setp
8144	Cooling casc flow temp
8145	Cooling casc flow temp setp

Display of setpoints and actual values of the cascade.

 Line 8144

Common cooling flow 1 uses common flow temperature sensor B10.
Common cooling flow 2 uses common flow temperature sensor B11.

 Line 8145

The currently valid setpoint is displayed. The displayed value is not influenced by any setpoint compensation.

Operating mode/strategy

<i>Line no.</i>	<i>Operating line</i>
8150	Source seq ch'over current
8155	Source seq ch'ov cool, curr

Display of operating mode and strategy of the cascade.

<i>Line no.</i>	<i>Operating line</i>
ACS	State cascade pump (Q25)
ACS	Switching sequence actual
ACS	Number of cooling sources
ACS	Number of sources with active cooling
ACS	Number of sources with passive cooling
ACS	Number of cooling sources with optimum energy
ACS	Common cooling

State cascade pump (Q25) (ACS)

Present state for Q25.

Switching sequence actual (ACS)

Displays the actual switching sequence.

Number of cooling sources (ACS)

Displays the number of cooling sources that can supply refrigeration on the valid common cooling (active or / and passive).

Number of sources with active cooling (ACS)

Displays the number of cooling source that can supply active cooling on the valid common cooling.

Number of sources with passive cooling (ACS)

Displays the number of cooling source that supply passive cooling on the valid common cooling.

Number of cooling sources with optimum energy (ACS)

Displays the number of cooling sources that can supply cooling with optimum energy on valid common cooling.

Common cooling (ACS)

Displays the common cooling valid for the source.

0

No valid common cooling. No available cooling source can cool.

1

No cooling source can supply cooling on common 2, but at least one cooling source can supply cooling on common coolin 1.

2

At least one cooling source can supply cooling on common cooling 2.



Common 2 has priority. Only common cooling 2 is valid if at least one cooling source is available on common cooling 2. Cooling sources on common cooling 1 are not considered.

6.31 Diagnostics heat generation

Heat pump brine-water-air

<i>Line no.</i>	<i>Operating line</i>
8395	Heat delivered
8396	Heat draw source
8397	Power consumption
8398	Coefficient of performance

COP based on measurement of output

The measuring equipment used to determine the yearly performance factor can also be used to determine the coefficient of performance (COP). At the same time, the current output is calculated.

These output values are displayed together with the COP.

COP based on characteristic

Alternatively, the COP can be roughly calculated based on the COP characteristic entered by the heat pump supplier (chapter 6.9, section "Output data").



The COP can be determined only if the required measured values are acquired or if the COP characteristic is defined. If the COP cannot be determined, line 8398 displays "---".

Components

<i>Line no.</i>	<i>Operating line</i>
8400	Compressor 1 On Off
8401	Compressor 2 On Off
8402	El imm heater 1 flow On Off
8403	El imm heater 2 flow On Off
8404	Source pump On Off
8405	Speed of source pump
8406	Condenser pump On Off
8407	Speed condenser pump
8408	Diverting valve cool source On Off

These operating lines can be used to check the operating states of the plant components controlled via the heat pump relays.

Setpoints and actual values

<i>Line no.</i>	<i>Operating line</i>
8410	Return temp HP
8411	Setpoint HP
8412	Flow temp HP
8413	Compressor modulation
8415	Hot-gas temp 1
8417	Hot-gas temp 2
8420	Refrig temp liquid
8423	Condensation temp
8423	Condensation pressure
8425	Temp diff condenser
8426	Temp diff evaporator
8427	Source inlet temp
8427	Switch-off threshold
8428	Source inlet temp min
8429	Source outlet temp
8429	Switch-off threshold
8430	Source outlet temp min
8431	Source int circ flow temp
8432	Source int circ return temp

These operating lines can be used to query the different setpoints and actual values of the heat pump.

Superheat controller

8434	Suction gas temp
8435	Evaporation temp
8435	Evaporation pressure
8436	Superheat
8436	Superheat setpoint
8437	Expansion valve
8438	Magnetic valve

Shows the current values of superheat control.

Remaining times

<i>Line no.</i>	<i>Operating line</i>
8440	Remain stage 1 off time min
8441	Remain stage 2 off time min
8442	Remain stage 1 on time min
8443	Remain stage 2 on time min

If the "Min off time" or "Min on time" of stage 1 or 2 is active, these operating lines show the remaining off time/on time.

"- - -" is displayed only when the minimum off times have elapsed so that the heat pump can be released again.

<i>Line no.</i>	<i>Operating line</i>
8444	Remain limit source temp

If the source inlet temperature (B91) is too low, the pumps and the compressor are locked for the period of time "T'limit source temp min brine" (line 2822). This operating line shows the remaining time for pumps and the compressor to be released again.

Compressor

<i>Line no.</i>	<i>Operating line</i>
8446	Compressor sequence 1 – 2 2 – 1

Shows the current compressor sequence, that is, the order in which the compressors are put into operation:

1 – 2

First, compressor 1 is put into operation, then compressor 2.

2 – 1

First, compressor 2 is put into operation, then compressor 1.

Hours run/start counter

<i>Line no.</i>	<i>Operating line</i>
8448	Optg hours ext evap temp
8449	Operating hours refrig circ
8450	Hours run compressor 1
8451	Start counter compressor 1
8452	Hours run compressor 2
8453	Start counter compressor 2

Optg hours ext evap temp Meters the time the heat pump operated in the extended range (see parameter 2829).

Operating hours refrig circ Meters the period of time during which at least one compressor is in operation.

Hours run compressor 1,2/ Start counter compressor 1,2 These operating lines show the total number of hours run and the number of starts of compressor 1 and 2 since they were first commissioned.

<i>Line no.</i>	<i>Operating line</i>
8454	Locking time HP

This operating line shows the total number of heat pump locking hours enforced by the electrical utility (via E6) since the plant was first commissioned.

<i>Line no.</i>	<i>Operating line</i>
8455	Counter number of locks HP

This operating line shows the total number of heat pump locking actions enforced by the electrical utility (via E6) since the plant was first commissioned.

<i>Line no.</i>	<i>Operating line</i>
8456	Hours run el flow
8457	Start counter el flow

The hours run and the number of starts of the electric immersion heater installed in the flow can be read out here.

<i>Line no.</i>	<i>Operating line</i>
8458	State smart grid Draw disabled Draw free Draw wish Draw forced

To read in smart grid information, inputs "Smart grid E61" and "Smart grid E62" are used. Meaning of the 4 smart grid states:

Draw disabled

Same behavior as with the active electrical utility lock (E6): Heat pump and all electric immersion heaters are locked.

Draw free

Normal operation, no measures to be taken.

Draw wish

Same behavior as with low-tariff (E5).

Draw forced

- Buffer storage tank
 - Forced charging is activated (see parameter 4705 ff.).
 - Optionally with electric immersion heater K16 (see parameter 4761).
- DHW storage tank
 - Charging with optimum efficiency (see parameter 5016), or
 - Release of charging with DHW release (see parameter 1620).

<i>Line no.</i>	<i>Operating line</i>
8460	Heat pump throughput

This operating line shows the current volumetric flow through the heat pump in [l/min].

Vapor injection

<i>Line no.</i>	<i>Operating line</i>
8462	Suction gas temp EVI
8463	Evaporation temp EVI
8463	Evaporation pressure EVI
8464	Superheat EVI
8464	Superheat setpoint EVI
8465	Expansion valve EVI
8466	Magnetic valve EVI Off On
8467	Magn valve injection cap Off On

Shows the current values of vapor injection.

Air-to-water heat pumps

<i>Line no.</i>	<i>Operating line</i>
8469	Fan speed
8470	Fan On Off
8471	Process revers valve On Off
8475	Evaporator temp

- Fan K19 Shows the current operating state of fan K19 for the air-to-water heat pump (off/on).
- Process revers valve Y22 Shows the current state of the process reversing valve (on: process reversed, off: process runs normally).
- Evaporator temp Shows the current evaporator temperature at sensor B84.

<i>Line no.</i>	<i>Operating line</i>
8477	Temp diff defrost act value
8478	Temp diff defrost setpoint
8480	Remain time defrost lock
8481	Remain time forced defrost
8482	Remain time defrost settling
8485	Number defrost attempts
8487	Defrost state
8488	Relative humidity air inlet

- Temp diff defrost act value Shows the present temperature differential between source inlet (B91) and evaporator temperature (B84).
- Temp diff defrost setpoint This shows the setpoint of the temperature differential of source inlet (B91) and evaporator temperature (B84) to be reached for the evaporator to become completely defrosted (ΔT defrosted).
- Remain time defrost lock Shows after successful or unsuccessful defrosting, for what period of time the "Defrost" function is locked until a new defrost attempt may be started/new defrost process may be performed.
- Remain time forced defrost Shows the period of time to elapse until the next forced defrost process is due if automatic or manual defrosting is not triggered before.
- Remain time defrost settling Shows the period of time to elapse until the defrost settling process is completed. For a description of the defrost settling time, refer to operating line 2959.
- Number defrost attempts Shows the maximum number of defrost attempts required until defrosting was successful or until the heat pump was locked.
- Defrost state Shows the current state of the "Defrost" function.
- Relative humidity air inlet Shows the current humidity of air at the source inlet.

<i>Line no.</i>	<i>Operating line</i>
ACS	Zustand Ölsumpfeheizung (K40)
ACS	Drip tray heater K41
ACS	State of source interm circuit pump (Q81)
ACS	State of source interm circuit div valve (Y81)
ACS	State of diverting valve cooling condenser (Y27)
ACS	State of condenser reversing valve (Y91)
ACS	State status information heating (K42)
ACS	State status information cooling (K43)
ACS	State status information DHW (K44)

Shows the current state of the outputs.

Solar collector field

<i>Line no.</i>	<i>Operating line</i>
8499	Collector pump 1
8505	Speed collector pump 1
8506	Speed solar pump ext exch
8507	Speed solar pump buffer
8508	Speed solar pump swi pool
8510	Collector temp 1
8511	Collector temp 1 max
8512	Collector temp 1 min
8513	dT collector 1/DHW
8514	dT collector 1/buffer
8515	dT collector 1/swimming pool
8519	Solar flow temp
8520	Solar return temp
8521	Solar throughput
8526	24-hour yield solar energy
8527	Total yield solar energy
8530	Hours run solar yield
8531	Hours run collect overtemp
8542	Collector pump 2
8543	Speed collector pump 2
8547	Collector temp 2
8548	Collector temp 2 max
8549	Collector temp 2 min
8550	dT collector 2/DHW
8551	dT collector 2/buffer
8552	dT collector 2/swimming pool
ACS	Status solar pump ext. Exchanger K9
ACS	Status solar actuator buffer (K8)
ACS	Status solar actuator pool (K18)

Collector pump 1 and 2

Shows the current state of the collector pumps.

Speed collector pump 1 and 2

Shows the current speed of collector pumps 1 and 2.

Speed solar pump ext exch

Shows the current speed of the solar pump of an external heat exchanger 1.

Speed solar pump buffer

Shows the current speed of the solar pump for buffer storage tank charging.

Speed solar pump swi pool

Shows the current speed of the solar pump used for heating the swimming pool.

Collector temp 1 and 2

Current collector temperature at sensor B6/B61

Collector temp 1 max and 2 max	Display of the maximum temperature acquired by sensor B6/B61.
Collector temp 1 min and 2 min	Display of the minimum temperature acquired by sensor B6/B61.
dT collector 1/DHW and 2/DHW	Display of the temperature differential of collector sensor B6/B61 and DHW sensors B3 and B31.
dT collector 1/buffer and 2/buffer	Display of the temperature differential of collector sensor B6/B61 and buffer storage tank sensors B4 and B41.
dT collector 1/swimming pool and 2/swimming pool	Display of the temperature differential of collector sensor B6/B61 and swimming pool sensor B13.
Solar flow temp	Display of the solar flow temperature acquired by sensor B63.
Solar return temp	Display of the solar return temperature acquired by sensor B64.
Solar throughput	Display of the current flow through the solar circuit in [l/min].
24-hour yield solar energy	Display of the energy input to the plant by the solar collector in the course of the day.
Total yield solar energy	Display of the total of all 24-hour solar yields since the controller was reset last.
Hours run solar yield	Display of the number of hours the solar plant produced energy (hours run).
Hours run collect overtemp	Display of the number of hours during which overtemperature protection for the collector was active.
Status solar pump ext. Exchanger K9 (ACS)	Current state of output K9.
Status solar actuator buffer (K8) (ACS)	Current state of output K8.
Status solar actuator pool (K18) (ACS)	Current state of output K18.

Solid fuel boiler

<i>Line no.</i>	<i>Operating line</i>
8560	Solid fuel boiler temp
8561	Solid fuel boiler setpoint
8563	Solid fuel boiler return temp
8564	Solid fuel boiler return setp
8565	Flue gas temp
8567	Flue gas temp max
8568	Speed solid fuel boiler pump
8570	Hours run solid fuel boiler
ACS	Status Solid fuel boiler pump (Q10)
ACS	Solid fuel boiler mixing valve opens (Y9)
ACS	Solid fuel boiler mixing valve closes (Y10)

Displays the current values of the solid fuel boiler.

Supplementary generator

<i>Line no.</i>	<i>Operating line</i>
8585	Control temperature
8586	Suppl source setpoint
8590	Hours run suppl source
ACS	Status heat demand (K27)
ACS	State suppl source control (K32)

Displays the current values of the supplementary generator.

6.32 Diagnostics consumers

For diagnostic purposes, the various setpoints, actual values, relay switching states and meter readings can be displayed.

Meteo

<i>Line no.</i>	<i>Operating line</i>
8700	Outside temp
8701	Outside temp min
8702	Outside temp max
8703	Outside temp attenuated
8704	Outside temp composite

Display of the actual, minimum, maximum, attenuated and composite outside temperature.

The minimum, the maximum and the attenuated outside temperature can be reset directly on the operating lines.

Definitions

- The composite outside temperature is the outside temperature filtered by the "Time constant building" (line 6110). Also, a 50% direct impact of the outside temperature is considered. Temperature variations are slightly averaged
- The attenuated outside temperature is the outside temperature filtered twice by the "Time constant building" (line 6110). Temperature variations are strongly averaged

Dehumidifier

<i>Line no.</i>	<i>Operating line</i>
8723	Relative air humidity
ACS	State air dehumidifier (K29) On Off

Display of the measured relative air humidity and of the state of a connected external dehumidifier.

Heating circuits/cooling circuits

Heating circuit 1, 2, 3

<i>Line no.</i>	<i>Operating line</i>
8730, 8760, 8790	Heating circuit pump 1, 2, 3 On Off
8731, 8761, 8791	Heat circ mix valve 1 open Heat circ mix valve 2 open HC mixing valve 3 open On Off
8732, 8762, 8792	Heat circ mix valve 1 close Heat circ mix valve 2 close HC mixing valve 3 closed On Off

The display of "Off" means that the relevant plant component is currently off. The display of "On" means that the relevant plant component is currently on.

Setpoints / actual values

Line no.	Operating line
8735, 8765, 8795	Speed heating circuit pump 1, 2, 3
8739, 8769, 8799	Relative room humidity 1, 2, 3
8740, 8770, 8800	Room temp 1, 2, 3
8741, 8771, 8801	Room setpoint 1, 2, 3
8742, 8772, 8802	Room temp 1 model, 2, 3
8743, 8773, 8803	Flow temp 1, 2, 3
8744, 8774, 8804	Flow temp setpoint 1, 2, 3
8747, 8777, 8807	Dewpoint temp 1, 2, 3
8749, 8779, 8809	Room thermostat 1, 2, 3 No demand Demand
ACS	State 2nd speed heating circuit pump (Q21),(Q22), (Q23) Off On
ACS	Operating mode changeover zone 1, 2, 3 Inactive Active

Speed heating circuit pump 1...3

Display of the speed of the relevant heating circuit pump as a percentage of maximum speed.

Relative room humidity 1...3

Displays the relative room humidity.

Room temp 1...3

Displays the room temperature.

Room setpoint 1...3

"Room setpoint 1...3, is used for the display of both setpoints, for heating and cooling.

In heating mode, the setpoint for heating is displayed, in cooling mode, the setpoint for cooling. If neither heating nor cooling takes place, the setpoint used last is displayed.

Room temp 1 model...
Room temp 3 model

The room model calculates a fictive room temperature for rooms without room sensor. The value calculated for each heating circuit appears on these operating lines.

This allows boost heating, quick setback, and optimum start and stop control to be implemented with no need for using a room sensor.

The calculation takes into account the "Outside temp composite" (OL 8704), the room model gradient (lines 794, 1094, and 1394) to switch to a higher setpoint, and the building time constant (line 6110) to switch to a lower setpoint.

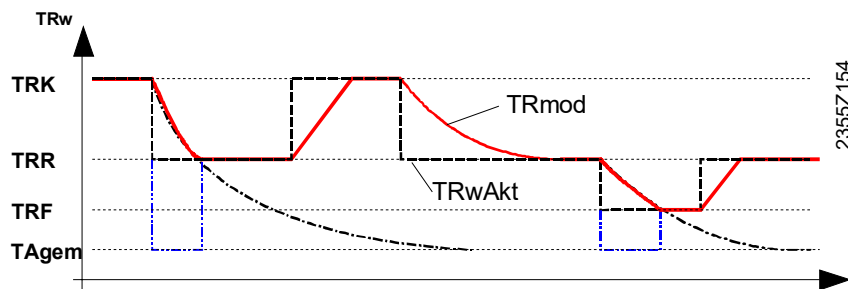

- TRwAkt Current room temperature setpoint
- TRmod Room temperature model
- TRK Comfort setpoint
- TRR Reduced setpoint
- TRF Frost protection setpoint

Flow temp 1...3	Displays the flow temperature.
Flow temp setpoint 1...3	Displays the flow temperature setpoint.
Dewpoint temp 1...3	Displays the dewpoint temperature.
Room thermostat 1...3	Shows whether or not there is currently a demand from the respective room thermostat.
State 2nd speed heating circuit pump (Q21), (Q22), (Q23) (ACS)	Displays the state of the second speed of the heating circuit pump.
Operating mode changeover heating circuit 1, 2, 3/P (ACS)	Shows whether operating mode changeover of the heating circuit is active.

Cooling circuit 1...3

<i>Line no.</i>	<i>Operating line</i>
8751, 8781, 8811	Cooling circuit pump 1, 2, 3
8752, 8782, 8812	Cool circ mix valve 1 open, 2 Auf, 3 Auf
8753, 8783, 8813	Cool circ mix valve 1 close, 2 Zu, 3 Zu
8754, 8784, 8814	Diverting valve cooling 1, 2, 3
8756, 8786, 8816	Flow temp cooling 1, 2, 3
8757, 8787, 8817	Flow temp setp cooling 1, 2, 3

Show the states of the cooling circuit pump, the cooling circuit mixing valve and the diverting valve, plus the actual value and the setpoint of the flow temperature for cooling 1...3.

The room temperature setpoint for cooling mode is displayed on operating line 8741.

DHW

<i>Line no.</i>	<i>Operating line</i>
8820	DHW pump Off On
8821	El imm heater DHW Off On
8825	Speed DHW pump
8826	Speed DHW interm circ pump
8827	Speed inst DHW heater pump
8830	DHW temp 1
8831	DHW temp setpoint
8832	DHW temp 2
8835	DHW circulation temp
8836	DHW charging temp
8837	DHW charging setpoint
8840	Hours run DHW pump
8841	Start counter DHW pump
8842	Hours run el DHW
8843	Start counter el DHW
8850	DHW primary controller temp
8851	DHW primary controller setp
8852	DHW consumption temp
8853	Instant WH setpoint

Display of the actual values and setpoints of DHW, the current speed of the DHW pumps as percentages, the DHW circulation and charging temperature, plus the hours run and start counters and temperatures and setpoints of the primary controller and instantaneous water heater.

<i>Line no.</i>	<i>Operating line</i>
ACS	State DHW circulating pump (Q4)
ACS	State of DHW precontr mix valve Open (Y31)
ACS	State of DHW precontr mix valve Closed (Y32)
ACS	Status instantaneous heater opens (Y33)
ACS	Status instantaneous heater closes (Y34)
ACS	State storage transfer pump (Q11)
ACS	State DHW stirring pump (Q35)
ACS	DHW intermediate circuit pump (Q33)
ACS	Zustand TWW-Zwischenkreismischer Auf (Y37)
ACS	Zustand TWW-Zwischenkreismischer Zu (Y38)
ACS	State DHW Heatpump (K33)
ACS	Operating mode changeover DHW
ACS	Flowswitch

Shows various states of DHW.

Consumer circuits

<i>Line no.</i>	<i>Operating line</i>
8875	Flow temp setp VK1
8885	Flow temp setp VK2
8895	Flow temp setp swimming pool
ACS	State CC1 pump (Q15)
ACS	State CC2 pump (Q18)

Display of the flow temperature setpoints for consumer circuits 1 and 2 and the swimming pool circuit.

Swimming pool

<i>Line no.</i>	<i>Operating line</i>
8900	Swimming pool temp
8901	Swimming pool setpoint
ACS	Swimming pool pump (Q19)

Display of the current swimming pool temperature and setpoint.

Primary controller

<i>Line no.</i>	<i>Operating line</i>
8930	Primary controller temp
8931	Primary controller setpoint
ACS	Status primary pump (Q14)
ACS	Status precontroller mixing valve opens (Y19)
ACS	Status precontroller mixing valve closes (Y20)
ACS	Status primary pump 2 (Q44)

Display of the current primary controller temperature and setpoint.

Preheating/precooling outside air (ventilation 1...3)

<i>Line no.</i>	<i>Operating line</i>
8932	Outside air temp
ACS	State of outside air temp control (Q17) On Off
8935	Indoor air quality 1
8937	Ventilation stage 1 Off Stage 1 Stage 2 Stage 3
ACS	State of ventilation fan 1 (K51) On Off
ACS	State of ventilation bypass 1 (K54) On Off
ACS	Room temp setpoint air cooling 1
8940	Indoor air quality 2
8942	Ventilation stage 2 Off Stage 1 Stage 2 Stage 3
ACS	State of ventilation fan 2 (K52) On Off
ACS	State of ventilation bypass 2 (K55) On Off
ACS	Room temp setpoint air cooling 2
8945	Indoor air quality 3
8947	Ventilation stage 3 Off Stage 1 Stage 2 Stage 3
ACS	State of ventilation fan 3 (K53) On Off
ACS	State of ventilation bypass 3 (K56) On Off
ACS	Room temp setpoint air cooling 3

Display of outside temperature, state of outside status control, ventilation stages, and states of ventilation fans and bypasses, room setpoints air cooling and room air quality.

Common flow values

<i>Line no.</i>	<i>Operating line</i>
8950	Common flow temp
8951	Common flow temp setpoint
8952	Common return temp
8956	Common flow temp 2
8957	Common flow setp refrig
ACS	Status heat demand (K27)
ACS	Status cool demand (K28)
ACS	State of diverting valve cooling, flow (Y29)

Display of the current common flow temperature and of the setpoints for heating and cooling mode.

Buffer storage tank

<i>Line no.</i>	<i>Operating line</i>
8970	EI imm heater buffer Off On
8980	Buffer temp 1
8981	Buffer setpoint
8982	Buffer temp 2
8983	Buffer temp 3
8990	Hours run el buffer
8991	Start counter el buffer
ACS	Output heat generation lock (Y4)

Display of the buffer storage tank's actual values and setpoints. Also displayed are the operating state, the number of hours run and the start counter of the electric immersion heater.

Inputs H

<i>Line no.</i>	<i>Operating line</i>
9005	Water pressure 1
9006	Water pressure 2
9009	Water pressure 3

Display of the water pressure of static pressure monitoring, measured via the assigned Hx input with setting "Pressure measurement 10V".

Room temperature

<i>Line no.</i>	<i>Operating line</i>
9010	Measurement room temp 1
9011	Measurement room temp 2
9012	Measurement room temp 3

Display of the room temperature, acquired at the assigned Hx input with setting "Room temp 10V".

Special temperature

<i>Line no.</i>	<i>Operating line</i>
9016	Special temp 1
9017	Special temp 2
9018	Special temp 3
9019	Special temp 4
9020	Special temp 5
9021	Special temp 6
9022	Special temp 7
9023	Special temp 8

Display of the measured values if, at one of the sensor inputs Bx, a "Special temp sensor 1" to 8 is configured.

States of relays/triac QX/ZX

<i>Line no.</i>	<i>Operating line</i>
9031	Relay output QX1
9032	Relay output QX2
9033	Relay output QX3
9034	Triac output ZX4
9035	Relay output QX5
9036	Relay output QX6
9037	Relay output QX7
9038	Relay output QX8
9039	Relay output QX9
9040	Relay output QX10
9041	Relay output QX11
9042	Relay output QX12
9043	Relay output QX13

The switching states of each of the multifunctional relays 1...13 can be queried via these operating lines.

- The display of "Off" means that the plant component assigned to the output is currently off
- The display of "On" means that the relevant plant component is currently on

Relay states of extension modules 1, 2 and 3

<i>Line no.</i>	<i>Operating line</i>
9050	Relay output QX21 module 1
9051	Relay output QX22 module 1
9052	Relay output QX23 module 1
9053	Relay output QX21 module 2
9054	Relay output QX22 module 2
9055	Relay output QX23 module 2
9056	Relay output QX21 module 3
9057	Relay output QX22 module 3
9058	Relay output QX23 module 3

The switching states of each of the relays on extension modules 1 and 2 can be queried via these operating lines.

- The display of "Off" means that the plant component assigned to the output is currently off
- The display of "On" means that the relevant plant component is currently on

Other relays

<i>Line no.</i>	<i>Operating line</i>
ACS	State alarm relay (K10)
ACS	Status time program 5 relais (K13)
ACS	Status delta-T controller 1 K21
ACS	Status delta-T controller 2 K22

States of other relays.

6.33 Pump and valve kick

To ensure that pumps and valves do not suffer from standstill damage, they are operated for a short time at regular intervals ("Kick" function).

The table below lists the relays controlled by the "Kick" function and the associated pumps or valves.

- The "Kick" function is performed every Friday morning at 10:00 o'clock (non-adjustable)
- The "Kick" function is performed only if the pump or the valve has not been operated since the last "Kick" function
- The "Kick" function activates the pump or the valve one by one, the interval being 30 seconds. The pumps and valves are kicked for 20 seconds
- In the case of speed-controlled pumps, modulation output ZX or UX used is set to the parameterized start speed, together with the relay. If no starting speed is parameterized, the maximum speed is used
- UX outputs that have no relay assigned use the starting speed or maximum speed for the kick
- Mixing valves are driven to their fully open and then back to their fully closed position. They are kicked only if, at the time of kicking, they receive no valid request

<i>Relay</i>	<i>Type of pump or valve</i>	<i>Note</i>
Heat pump		
Q8	Source pump Q8/fan K19	
Q9	Condenser pump Q9	
Q81	Source int circ pump Q81	
Y27	Div valve cooling cond Y27	
Y28	Div valve cool source Y28	When no request is pending
Y81	Source int circ div Y81	
Y91	Cond reversing valve Y91	
Cascade		
Q25	Cascade pump Q25	
Q26	Cascade bypass pump	
Y25	Return mixing valve open	
Y26	Return mixing valve close	
Y13	Common flow valve	
Solar		
Q5	Collector pump Q5	
Q16	Collector pump 2 Q16	
K9	Solar pump ext exch K9	
K8	Solar ctrl elem buffer K8	
K18	Solar ctrl elem swi pool K18	
Solid fuel boiler		
Q10	Solid fuel boiler pump Q10	
Y9	Return mixing valve open	
Y10	Return mixing valve close	

<i>Relay</i>	<i>Type of pump or valve</i>	<i>Note</i>
Buffer storage tank		
Y4	Heat gen shutoff valve Y4	
Y15	Return valve	
Y47	Buffer reversing valve Y47	
DHW		
Q3	DHW ctrl elem Q3	When no request is pending
Y31	Primary controller mixing valve open	
Y32	Primary controller mixing valve close	
Q35	DHW mixing pump Q35	
Q33	DHW interm circ pump Q33	
Y37	Intermediate circuit mixing valve open	
Y38	Intermediate circuit mixing valve close	
Q11	St tank transfer pump Q11	
Instantaneous water heater		
Q34	Instant WH ctrl elem Q34	When no request is pending
Y33	Instantaneous water heater mixing valve open	
Y34	Instantaneous water heater mixing valve close	
Q4	Circulating pump Q4	
General functions		
K11	Overtemperature protection K11	
K21	Delta-T-controller 1 K21	Depending on parameter 5577
K22	Delta-T-controller 2 K22	Depending on parameter 5587
Precontroller		
Q14	System pump Q14	
Q44	System pump 2 Q44	
Y19	Status precontroller mixing valve opens (Y19)	
Y20	Status precontroller mixing valve closes (Y20)	
Heating circuit 1...3		
Q2	Heat circuit pump HC1 Q2	
Q6	Heat circuit pump HC2 Q6	
Q20	Heat circuit pump HC3 Q20	
Y1	Heating circuit mixing valve 1 open	
Y5	Heating circuit mixing valve 2 open	
Y11	Heating circuit mixing valve 3 open	
Y2	Heating circuit mixing valve 1 close	
Y6	Heating circuit mixing valve 2 close	
Y12	Heating circuit mixing valve 3 close	

<i>Relay</i>	<i>Type of pump or valve</i>	<i>Note</i>
Cooling circuit 1...3		
Q24	Cooling circ pump CC1 Q24	
Q28	Cooling circ pump CC2 Q28	
Q29	Cooling circ pump CC3 Q29	
Y23	Cooling circuit mixer openCC1	
Y41	Cooling circuit mixer openCC2	
Y43	Cooling circuit mixer openCC3	
Y24	Cooling circuit mixer closedCC1	
Y42	Cooling circuit mixer closedCC2	
Y44	Cooling circuit mixer closedCC3	
Y21	Div valve HC/CC1 Y21	
Y45	Diverting valve HC/CC2	
Y46	Diverting valve HC/CC3	
Consumer circuit 1...2		
Q15	Cons circuit pump VK1 Q15	
Q18	Cons circuit pump VK2 Q18	
Q19	Swimming pool pump Q19	
Ventilation		
Q17	Outside air temp contr Q17	

6.34 Display lists

Error codes are assigned priorities. As of priority 5 (also priorities 5...9, alarm messages are sent out that are used for remote monitoring (OCI). The alarm relay is also set.

6.34.1 Error codes

The following error codes may occur:

No.:Error text	Place	Error	Acknowledgement	Function "Error repetition"		Heat pump operation	Responsibility
				prio	manually		
10:Outside sensor	B9	6	No	No	---	Yes	1 (Installer)
25:Boiler sensor solid fuel	B22	6	No	No	---	Yes	1 (Installer)
26:Common flow sensor	B10	6	No	No	---	Yes	1 (Installer)
27:Common flow sensor 2	B11	6	No	No	---	Yes	1 (Installer)
28:Flue gas temp sensor	B8	6	No	No	---	Yes	1 (Installer)
30:Flow sensor 1	B1	6	No	No	---	Yes	1 (Installer)
31:Flow sensor cooling 1	B16	6	No	No	---	Yes	1 (Installer)
32:Flow sensor 2	B12	6	No	No	---	Yes	1 (Installer)
33:Flow sensor HP	B21	6	No	No	---	Yes	1 (Installer)
35:Source inlet sensor	B91	9	No	No	---	No (param.)	1 (Installer)
36:Hot-gas sensor 1	B81	6	No	No	---	Yes	1 (Installer)
37:Hot-gas sensor 2	B82	6	No	No	---	Yes	1 (Installer)
38:Flow sensor prim contr	B15	6	No	No	---	Yes	1 (Installer)
39:Evaporator sensor	B84	9	No	No	---	No (air-HP)	1 (Installer)
43:Return sensor solid fuel	B72	6	No	No	---	Yes	1 (Installer)
44:Return sensor HP	B71	6	No	No	---	Yes	1 (Installer)
45:Source outlet sensor	B92	9	No	No	---	No (param.)	1 (Installer)
46:Return sensor cascade	B70	6	No	No	---	Yes	1 (Installer)
47:Common return sensor	B73	6	No	No	---	Yes	1 (Installer)
48:Refrigerant sensor liquid	B83	6	No	No	---	Yes	1 (Installer)
50:DHW sensor 1	B3	6	No	No	---	Yes	1 (Installer)
52:DHW sensor 2	B31	6	No	No	---	Yes	1 (Installer)
54:DHW flow sensor	B35	6	No	No	---	Yes	1 (Installer)
57:DHW circulation sensor	B39	6	No	No	---	Yes	1 (Installer)
60:Room sensor 1		6	No	No	---	Yes	1 (Installer)
65:Room sensor 2		6	No	No	---	Yes	1 (Installer)
68:Room sensor 3		6	No	No	---	Yes	1 (Installer)
70:Storage tank sensor 1	B4	6	No	No	---	Yes	1 (Installer)
71:Storage tank sensor 2	B41	6	No	No	---	Yes	1 (Installer)
72:Storage tank sensor 3	B42	6	No	No	---	Yes	1 (Installer)
73:Collector sensor 1	B6	6	No	No	---	Yes	1 (Installer)
74:Collector sensor 2	B61	6	No	No	---	Yes	1 (Installer)
76:Special sensor 1	Bx	3	No	No	---	Yes	1 (Installer)
81:LPB short-circuit/comm		6	No	No	---	Yes	5 (None)
82:LPB address collision		3	No	No	---	Yes	5 (None)
83:BSB short-circuit		8	No	No	---	Yes	5 (None)
84:BSB address collision		3	No	No	---	Yes	5 (None)
85:BSB Radio communication		8	No	No	---	Yes	5 (None)
98:Extension module 1		8	No	No	---	Yes	5 (None)
99:Extension module 2		8	No	No	---	Yes	5 (None)
100:2 clock time masters		3	No	No	---	Yes	5 (None)
102:Clock without backup		3	No	No	---	Yes	5 (None)
105:Maintenance message		5	No	No	---	Yes	1 (Installer)
106:Source temp too low		6	Yes	No	---	No	1 (Installer)
107:Hot-gas compressor 1		9	Yes	Num*	Limit hot-gas compr1	No	2 (Customer service)
108:Hot-gas compressor 2		9	Yes	Num*	Limit hot-gas compr2	No	2 (Customer service)
117:Water pressure too high	Hx	6	No	No	---	Yes	1 (Installer)
118:Water pressure too low	Hx	6	No	No	---	No	1 (Installer)

No.:Error text	Place	Error	Acknowledgement	Function "Error repetition"		Heat pump operation	Responsibility
				active	1st status message		
		prio	manually				No.
121:Flow temp HC1 (too low)		3	No	No	---	Yes	1 (Installer)
122:Flow temp HC2 (too low)		3	No	No	---	Yes	1 (Installer)
126:DHW charg temp		6	No	No	---	Yes	1 (Installer)
127:Legionella temp		6	No	No	---	Yes	1 (Installer)
134:Common fault HP	E20	9	Yes	Num*	Fault	No	1 (Installer)
138:No control sensor HP		1	No	No	---	No	1 (Installer)
146:Configuration error		3	No	No	---	Yes	5 (None)
171:Alarm contact 1 active	H1/H31	6	No	No	---	Yes	1 (Installer)
172:Alarm contact 2 active	H2/H21/H22/H32	6	No	No	---	Yes	1 (Installer)
173:Alarm contact 3 active	Ex	6	No	No	---	Yes	1 (Installer)
174:Alarm contact 4 active	H3/H33	6	No	No	---	Yes	1 (Installer)
176:Water press 2 too high	Hx	6	No	No	---	Yes	1 (Installer)
177:Water press 2 too low	Hx	6	No	No	---	No	1 (Installer)
178:Limit thermostat HC1		3	No	No	---	Yes	1 (Installer)
179:Limit thermostat HC2		3	No	No	---	Yes	1 (Installer)
201:Frost alarm	B21	9	Yes	No	---	No	1 (Installer)
204:Fan overload	E14	9	Yes	Num*	Fan overload	No	1 (Installer)
222:Hi-press on HP op	E10	9	Yes	Num*	High-press HP in operation	No	1 (Installer)
223:Hi-press on start HC	E10	9	Yes	No	---	No	1 (Installer)
224:Hi-press on start DHW	E10	9	Yes	No	---	No	1 (Installer)
225:Low-pressure	E9	9	Yes	Num*	Low-pressure	No	2 (Customer service)
226:Compressor 1 overload	E11	9	Yes	Num*	Compressor 1 overload	No	2 (Customer service)
227:Compressor 2 overload	E12	9	Yes	Num*	Compressor 2 overload	No	2 (Customer service)
228:Flow swi heat source	E15	9	Yes	Num*	Flow switch heat source	No	1 (Installer)
229:Press swi heat source	E15	9	Yes	Num*	Press switch heat source	No	1 (Installer)
230:Source pump overload	E14	9	Yes	Num*	Source pump overload	No	1 (Installer)
241:Flow sensor yield	B63	6	No	No	---	Yes	1 (Installer)
242:Return sensor yield	B64	6	No	No	---	Yes	1 (Installer)
243:Swimming pool sensor	B13	6	No	No	---	Yes	1 (Installer)
247:Defrost fault		9	Yes	Num*	Preheating for defrost	No	1 (Installer)
260:Flow sensor 3	B14	6	No	No	---	Yes	---
320:DHW charging sensor	B36	6	No	No	---	Yes	---
321:DHW outlet sensor	B38	6	No	No	---	Yes	---
322:Water press 3 too high	Hx	6	No	No	---	Yes	---
323:Water press 3 too low	Hx	6	No	No	---	No	---
324:BX same sensors		3	No	No	---	Yes	---
325:BX/e'module same sens		3	No	No	---	Yes	---
326:BX/m'grp same sens		3	No	No	---	Yes	---
327:E'module same funct		3	No	No	---	Yes	---
328:Mix group same funct		3	No	No	---	Yes	---
329:E'mod/m'grp same funct		3	No	No	---	Yes	---
330:BX1 No function		3	No	No	---	Yes	---
331:BX2 No function		3	No	No	---	Yes	---
332:BX3 No function		3	No	No	---	Yes	---
333:BX4 No function		3	No	No	---	Yes	---
334:BX5 No function		3	No	No	---	Yes	---
335:BX21 No function		3	No	No	---	Yes	---
336:BX22 No function		3	No	No	---	Yes	---
337:B1 No function		3	No	No	---	Yes	---
338:B12 No function		3	No	No	---	Yes	---
339:Coll pump Q5 missing		3	No	No	---	Yes	---
340:Coll pump Q16 missing		3	No	No	---	Yes	---
341:Coll sensor B6 missing		3	No	No	---	Yes	---
342:Solar DHW B31missing		3	No	No	---	Yes	---
343:Solar integration missing		3	No	No	---	Yes	---
344:Solar buffer K8 missing		3	No	No	---	Yes	---
345:Sol swi pool K18 missing		3	No	No	---	Yes	---
346:Boiler pump Q10 missing		3	No	No	---	Yes	---
347:Solid fuel boil comp sens		3	No	No	---	Yes	---
348:Solid fuel boil addr err		3	No	No	---	Yes	---
349:Buff valve Y15 missing		3	No	No	---	Yes	---
350:Buffer address error		3	No	No	---	Yes	---
351:Prim/sys pump addr err		3	No	No	---	Yes	---

No.:Error text	Place	Error	Acknowledgement	Function "Error repetition"		Heat pump operation	Responsibility
				active	1st status message		
		prio	manually				No.
352:Pr'less header addr err		3	No	No	---	Yes	---
353:Casc sens B10 missing		3	No	No	---	Yes	---
354:Special sensor 2	Bx	3	No	No	---	Yes	---
355:3-ph curr asymmetric	E21/E22/E23	9	Yes	Num*	3-ph current asymmetric	No	---
356:Flow switch consumers	E24	9	Yes	Num*	Flow switch consumers	No	---
357:Flow temp cooling 1 (not achieved)		6	No	No	---	Yes	---
358:Soft starter	E25	9	Yes	Num*	---	No	---
359:Div valve cool Y21 miss		3	No	No	---	Yes	---
360:Proc rev va Y22 miss		3	No	No	---	Yes	---
361:Source sens B91 miss		3	No	No	---	Yes	---
362:Source sens B92 miss		3	No	No	---	Yes	---
363:Compr sens B84 miss		3	No	No	---	Yes	---
364:Cool system HP wrong		3	No	No	---	No	---
365:Inst heater Q34 miss		3	No	No	---	Yes	---
366:Room temp sensor Hx		6	No	No	---	Yes	---
367:Room humidity sens Hx		6	No	No	---	Yes	---
368:Flow temp setp readjHx		6	No	No	---	Yes	---
370:Thermodynamic source		9	No	No	---	No	---
369:External		9	No	No	---	No	---
371:Flow temp HC3 (too low)		3	No	No	---	Yes	---
372:Limit thermostat HC3		3	No	No	---	Yes	---
373:Extension module 3		3	No	No	---	Yes	---
385:Mains undervoltage	E21	9	Yes	Num*	Mains undervoltage	Yes	---
388:DHW sensor No function		3	No	No	---	Yes	---
441:BX31 No function		3	No	No	---	Yes	---
442:BX32 No function		3	No	No	---	Yes	---
443:BX33 No function		3	No	No	---	Yes	---
444:BX34 No function		3	No	No	---	Yes	---
445:BX35 No function		3	No	No	---	Yes	---
446:BX36 No function		3	No	No	---	Yes	---
447:BX6 No function		3	No	No	---	Yes	---
452:HX1 No function		3	No	No	---	Yes	---
453:HX3 No function		3	No	No	---	Yes	---
454:HX31 No function		3	No	No	---	Yes	---
455:HX32 No function		3	No	No	---	Yes	---
456:HX33 No function		3	No	No	---	Yes	---
457:BX7 No function		3	No	No	---	Yes	---
462:BX8 No function		3	No	No	---	Yes	---
463:BX9 No function		3	No	No	---	Yes	---
464:BX10 No function		3	No	No	---	Yes	---
465:BX11 No function		3	No	No	---	Yes	---
466:BX12 No function		3	No	No	---	Yes	---
467:BX13 No function		3	No	No	---	Yes	---
468:BX14 No function		3	No	No	---	Yes	---
469:HX21 No function		3	No	No	---	Yes	---
470:HX22 No function		3	No	No	---	Yes	---
472:Flow sensor cooling 2	B17	6	No	No	---	Yes	---
473:Flow sensor cooling 3	B18	6	No	No	---	Yes	---
474:Flow temp cooling 2 (not achieved)		6	No	No	---	Yes	---
475:Flow temp cooling 3 (not achieved)		6	No	No	---	Yes	---
476:Suction gas sensor	B85	6	No	No	---	No	---
477:Evapor press sensor	H82	6	No	No	---	No	---
479:No refrigerant selected		3	No	No	---	No	---
480:Suction gas sensor EVI	B86	6	No	No	---	No	---
481:Evap press sensor EVI	H86	6	No	No	---	No	---
482:Evapor temp sensor EVI	B87	6	No	No	---	No	---
483:Soft starter 2		9	Yes	Num*	---	No	---
484:Div valve cool Y45 miss		3	No	No	---	Yes	---
488:Condens press sensor	H83	8	No	No	---	No	---
489:No cascade master		3	No	No	---	Yes	---
490:Cascade source miss		3	No	No	---	Yes	---
491:Max evaporation temp		9	Yes	Num*	Limitation evap temp max	No	---

No.:Error text	Place	Error	Acknowledgement	Function "Error repetition"		Heat pump operation	Responsibility
				active	1st status message		
		prio	manually				No.
492:K2/modulat incompatible		3	No	No	---	No	---
493:Outside air sensor	B19	6	No	No	---	Yes	---
496:Flow sw source int circ	Q17	3	No	No	---	Yes	---
495:Modbus No comm'cation		6	No	No	---	Yes	---
496:Flow sw source int circ		9	Yes	Num*	Flow switch source int circ	No	---
497:Pres sw sourc int circ		9	Yes	Num*	Press switch source int circ	No	---
498:Air quality sensor Hx	Hx	6	No	No		Yes	---
499:External source missing		3	No	No	---	No	---
500:Modbus configuration		3	No	No	---	Yes	---
501:Suction gas sensor 2	B88	6	No	No	---	No	---
502:Sourc int circ flow sens	B93	6	No	No	---	No	---
503:Sourc int circ ret sens	B94	6	No	No	---	No	---
504:Pres diff proc reversal		6	Yes	Yes	Limit pres diff proc revers	No	1 (Installer)
505:Expansion valve evap		6	Yes	No	---	No	---
506:Suppl source missing		6	No	No	---	Yes	---
511:Leg temp circ pipe		6	No	No	---	Yes	---
517:Room humidity sensor 1		6	No	No	---	Yes	---
518:Room humidity sensor 2		6	No	No	---	Yes	---
519:Room humidity sensor 3		6	No	No	---	Yes	---
521:Modbus slave port 1		6	No	No	---	Yes/No**	---
522:Modbus slave port 2		6	No	No	---	Yes/No**	---
523:Modbus slave port 3		6	No	No	---	Yes/No**	---
524:Modbus slave port 4		6	No	No	---	Yes/No**	---
525:Modbus slave port 5		6	No	No	---	Yes/No**	---
526:Modbus slave port 6		6	No	No	---	Yes/No**	---
527:Modbus slave port 7		6	No	No	---	Yes/No**	---
528:Modbus slave port 8		6	No	No	---	Yes/No**	---
529:Superheat controller		6	No	No	---	No	---
530:Superheat controller 2		6	No	No	---	No	---
531:Special sensor 3		6	No	No	---	Yes	---
532:Special sensor 4		6	No	No	---	Yes	---
533:Special sensor 5		6	No	No	---	Yes	---
534:Special sensor 6		6	No	No	---	Yes	---
535:Special sensor 7		6	No	No	---	Yes	---
536:Special sensor 8		6	No	No	---	Yes	---

* Num: These plant states do not directly lead to an error message, but first deliver a status message upon initial startup. An error message is delivered only if the error recurs the number of times set for an adjustable period of time

** Yes/No: As per ACS Parameter "Source fault for Modbus failure" in menu "Setup for Modbus experts" (see section 6.23).

The LPB system displays the following error messages only as collective errors:

No.:Error text	Place	Error	Acknowledgement	Function error repetition		Heat pump operation	Responsibility
				active	1. 1st status message		
		prio	manually				No.
103:Communication failure	LPB	---	---	---	---	---	1 (Installer)
207:Fault cooling circuit	LPB	---	---	---	---	---	1 (Installer)
208:Flow supervision	LPB	---	---	---	---	---	1 (Installer)
209:Fault heating circuit	LPB	---	---	---	---	---	1 (Installer)
212:Internal comm failure	LPB	---	---	---	---	---	1 (Installer)
216:Boiler fault	LPB	---	---	---	---	---	1 (Installer)
217:Sensor fault	LPB	---	---	---	---	---	1 (Installer)
218:Pressure supervision	LPB	---	---	---	---	---	1 (Installer)
219:Fault DHW	LPB	---	---	---	---	---	1 (Installer)
244:Fault source cascade	LPB	---	---	---	---	---	1 (Installer)

Notes relating to the tables

Error text The error text in the tables corresponds to the clear-text on the display of the operator unit.

Place

Sensor or contact or bus in connection with the error message.

Reset

The errors are reset either manually or automatically, depending on the type of error.

Manual reset

With error displays on the info level where "Reset?" appears, the error can be reset manually.

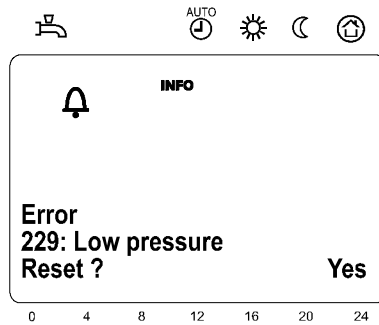

After pressing the OK button once, "Yes" is displayed flashing. Pressing the OK button a second time confirms the "Yes" and resets the error.

Automatic reset

Automatic acknowledgement takes place when the minimum compressor off time has elapsed (line 2843). On completion of this period of time, the controller tries to reset the error.

If the table indicates "Number", it can be selected how many times the error shall be reset before the heat pump goes to lockout.

Heat pump operation

This indicates whether or not the heat pump can continue to operate should a fault occur.

Yes

Heat pump operation is continued although an error message was delivered.

No

Error causes the heat pump to shut down.

Error messages, alarm messages

The errors are assigned priorities. From priority 5 (priorities 5...9), alarm messages are delivered, which are used for remote monitoring (OCI). In addition, the alarm relay is set.

6.34.2 Maintenance codes

<i>Maintenance text</i>	<i>Prio</i>	<i>Cause</i>
0:No maintenance message pending	0	
5:Water pressure too low	9	Water pressure 1 in heating circuit is below the set limit
6:Heat pump hours run	6	Hours of operation since maintenance
7:Number heat pump starts exceeded	6	Number of starts since maintenance
8:Too many starts compressor 1	9	Ratio of heat pump starts to runtime is too high
10:Change battery outside sensor	6	Battery is nearly empty
11:DHW storage tank time interval exceeded	6	Time since maintenance
12:DHW charging temp heat pump too low	6	Minimum DHW temperature is not reached with the heat pump
13:Differential condenser max / week exceeded	3	Too little flow in heating circuit (e.g. due to a closed thermostatic valve)
14:Differential condenser min / week exceeded	3	Too much flow in the heating circuit or heat pump does not supply sufficient output (e.g. loss of refrigerant)
15:Differential evaporator max / week exceeded	3	Too little flow in source circuit (e.g. dirty heat exchanger)
16:Differential evaporator min / week exceeded	3	Too much flow in source circuit or heat pump does not supply sufficient output (e.g. loss of refrigerant)
17:Heat pump time interval exceeded	6	Time since maintenance
18:Water pressure 2 too low	9	Water pressure 2 in heating circuit is under the set limit
21:Flue gas temp too high	6	Maximum flue gas temperature is exceeded
22:Water pressure 3 too low	9	Water pressure 3 in the heating circuit is below the set limit
26:Maintenance interval ventilation 1 expired	6	The set maintenance interval for ventilation 1 was exceeded
26:Ventilation 1		
27:Maintenance interval ventilation 2 expired	6	The set maintenance interval for ventilation 2 was exceeded
27:Ventilation 2		
28:Maintenance interval ventilation 3 expired	6	The set maintenance interval for ventilation 3 was exceeded
28:Ventilation 3		

6.34.3 Special operating codes

<i>Special operating text</i>	<i>Code</i>	<i>Cause</i>
303:Chimney sweep function	303	Chimney sweep function activated by parameter 7130
307:Emergency operation	307	HP emergency operation is manually activated by parameter 7141 or, if automatic emergency functions is permitted (parameter 7142= automatic), activated due to a HP fault
308:Output test	308	Output test activated by parameter 7700
309:Simulation outside temp	309	Outside air temperature simulation activated by parameter 7150
311:Commissioning function	311	Commissioning function activated
314:Economy operation	314	Eco function activated by button or parameter 7120
316:DHW Push	316	DHW push activated by button or parameter 5072
317:Release wo source prot	317	HP release without source protection activated by parameter 7154.The HP is locked and the fault displayed after the release time expires.
297:Floor curing funct HC1	297	Function activated by parameter 850
298:Floor curing funct HC2	298	Function activated by parameter 1150
299:Floor curing funct HCP	299	Function activated by parameter 1450

7 Plant diagrams

The various applications are shown in the form of basic diagrams, producer variants and auxiliary functions.

Variants of producers can be selected by making appropriate parameter settings.

To include extra functions, the multifunctional inputs and outputs must be appropriately set.



For producer variants and extra functions, refer to the separate TS catalog U2359.

7.1 Basic plant diagrams

The following plant diagrams can be preselected by entering a number (line 5700). The plant diagram is the result of preselection plus the connected sensors.

Plant diagram 1

Brine-to-water heat pump with pump heating circuit.

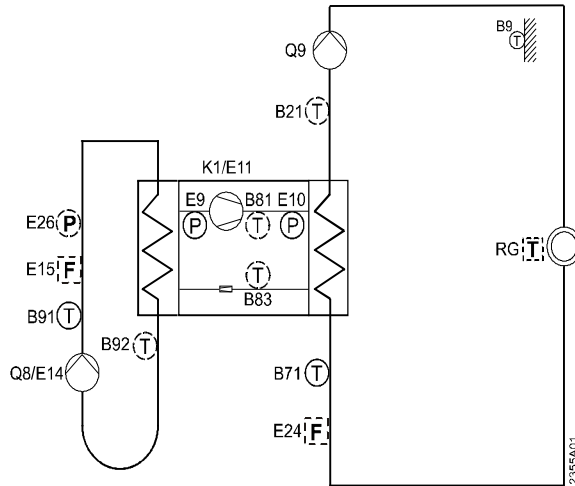

Multifunctional terminals

RVS61..	
BX1	
BX2	
BX3	
BX4	
BX7	Hot-gas sensor B81
BX8	
BX9	Outside sensor B9
BX10	HP flow sensor B21
BX11	
BX12	HP return sensor B71
BX13	Source inlet sensor B91
BX14	Source outl sens B92/B84 B92
QX1	
QX2	
QX3	
QX5	
QX6	
QX7	Compressor stage 1 K1
QX8	
QX9	
QX10	
QX11	
QX12	Source pump Q8/fan K19 Q8
QX13	Condenser pump Q9
EX9	Low-pressure switch E9
EX10	High-pressure switch E10
EX11	Overload compressor 1 E11

Plant diagram 2

Brine-to-water heat pump with pump heating circuit and DHW storage tank with DHW charging pump Q3.

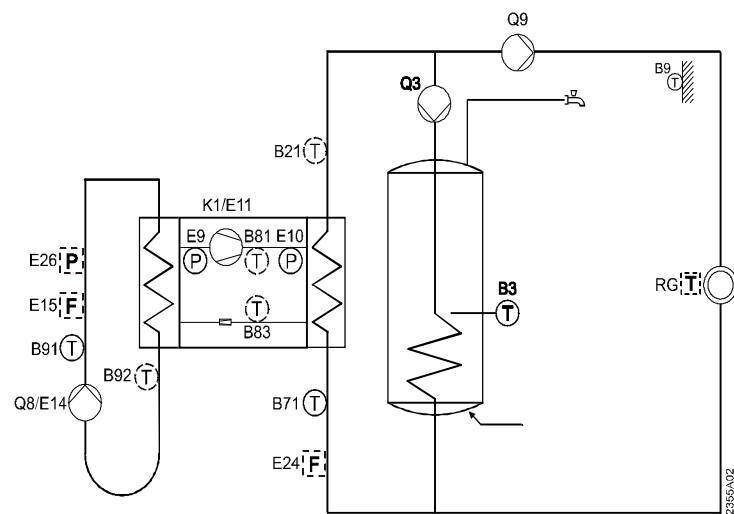

Multifunctional terminals

RVS61..	
BX1	
BX2	
BX3	
BX4	
BX7	Hot-gas sensor B81
BX8	DHW sensor B3
BX9	Outside sensor B9
BX10	HP flow sensor B21
BX11	
BX12	HP return sensor B71
BX13	Source inlet sensor B91
BX14	Source outl sens B92/B84 B92
QX1	
QX2	
QX3	
QX5	
QX6	
QX7	Compressor stage 1 K1
QX8	DHW ctrl elem Q3
QX9	
QX10	
QX11	
QX12	Source pump Q8/fan K19 Q8
QX13	Condenser pump Q9
EX9	Low-pressure switch E9
EX10	High-pressure switch E10
EX11	Overload compressor 1 E11

Plant diagram 3

Brine-to-water heat pump with pump heating circuit and DHW storage tank with DHW charging pump Q3.

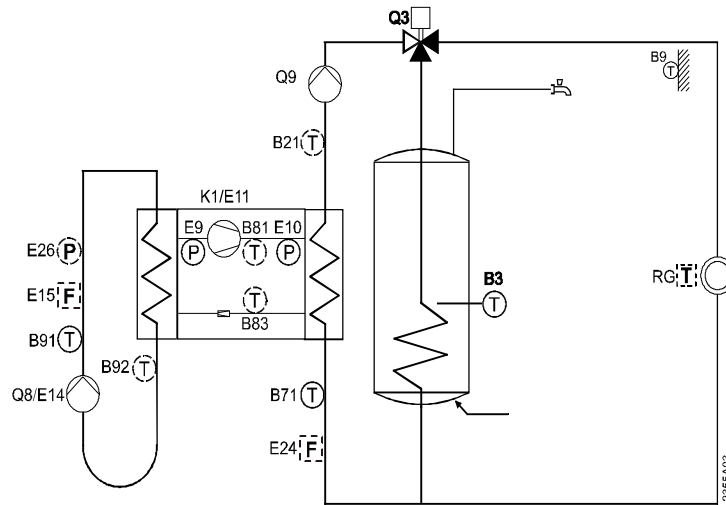

Multifunctional terminals

RVS61..	
BX1	
BX2	
BX3	
BX4	
BX7	Hot-gas sensor B81
BX8	DHW sensor B3
BX9	Outside sensor B9
BX10	HP flow sensor B21
BX11	
BX12	HP return sensor B71
BX13	Source inlet sensor B91
BX14	Source outl sens B92/B84 B92
QX1	
QX2	
QX3	
QX5	
QX6	
QX7	Compressor stage 1 K1
QX8	DHW ctrl elem Q3
QX9	
QX10	
QX11	
QX12	Source pump Q8/fan K19 Q8
QX13	Condenser pump Q9
EX9	Low-pressure switch E9
EX10	High-pressure switch E10
EX11	Overload compressor 1 E11

Plant diagram 4

Brine-to-water heat pump with buffer storage tank and mixing or pump heating circuit.

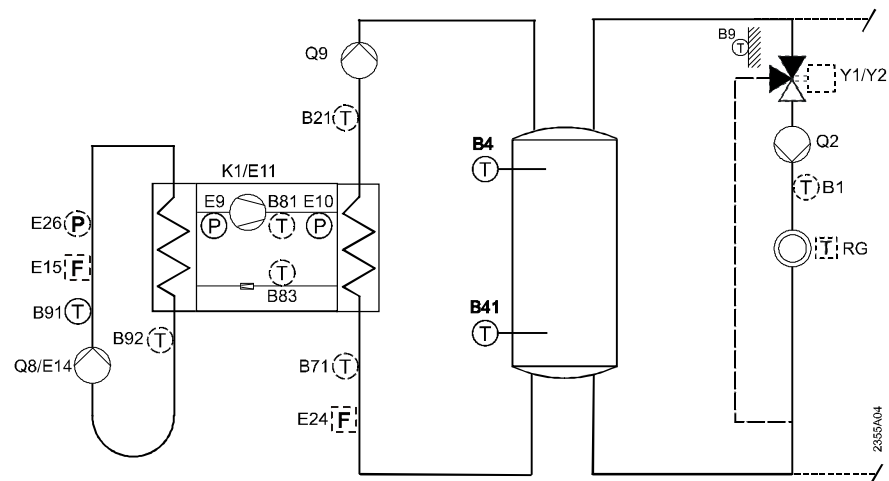

Multifunctional terminals

RVS61..	
BX1	Buffer sensor B4
BX2	Buffer sensor B41
BX3	
BX4	
BX7	Hot-gas sensor B81
BX8	
BX9	Outside sensor B9
BX10	HP flow sensor B21
BX11	B1
BX12	HP return sensor B71
BX13	Source inlet sensor B91
BX14	Source outl sens B92/B84 B92
QX1	
QX2	
QX3	
QX5	
QX6	
QX7	Compressor stage 1 K1
QX8	
QX9	Heat circuit pump HC1 Q2
QX10	Y1
QX11	Y2
QX12	Source pump Q8/fan K19 Q8
QX13	Condenser pump Q9
EX9	Low-pressure switch E9
EX10	High-pressure switch E10
EX11	Overload compressor 1 E11

Plant diagram 5

Brine-to-water heat pump with buffer storage tank, DHW storage tank with charging pump Q3 and mixing or pump heating circuit.

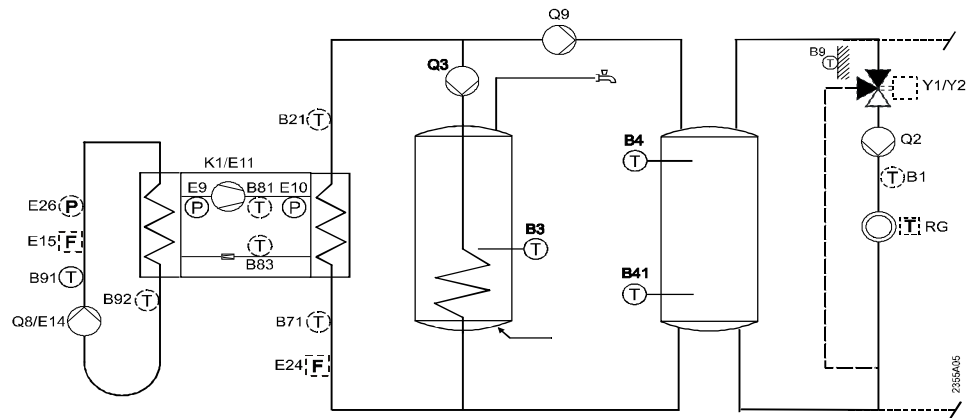

Multifunctional terminals

RVS61..	
BX1	Buffer sensor B4
BX2	Buffer sensor B41
BX3	
BX4	
BX7	Hot-gas sensor B81
BX8	DHW sensor B3
BX9	Outside sensor B9
BX10	HP flow sensor B21
BX11	B1
BX12	HP return sensor B71
BX13	Source inlet sensor B91
BX14	Source outl sens B92/B84 B92
QX1	
QX2	
QX3	
QX5	
QX6	
QX7	Compressor stage 1 K1
QX8	DHW ctrl elem Q3
QX9	Heat circuit pump HC1 Q2
QX10	Y1
QX11	Y2
QX12	Source pump Q8/fan K19 Q8
QX13	Condenser pump Q9
EX9	Low-pressure switch E9
EX10	High-pressure switch E10
EX11	Overload compressor 1 E11

Plant diagram 6

Brine-to-water heat pump with buffer storage tank, DHW storage tank with diverting valve Q3 and mixing or pump heating circuit.

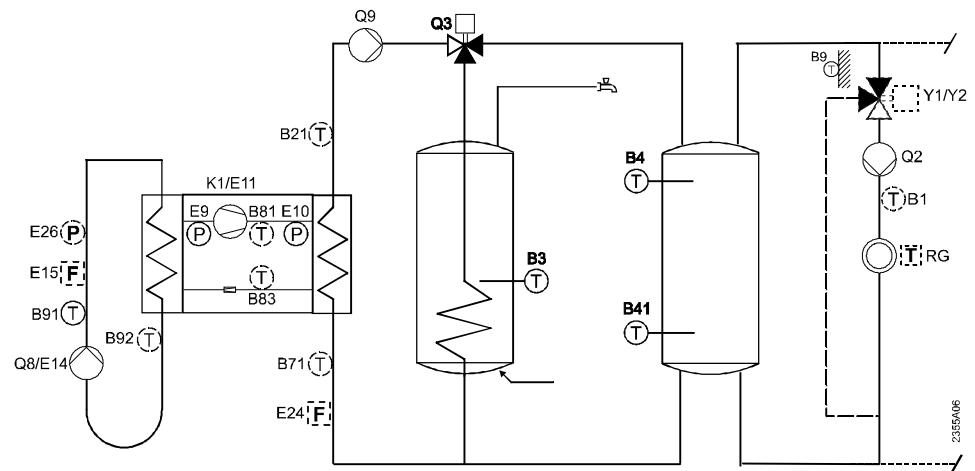

Multifunctional terminals

RVS61..	
BX1	Buffer sensor B4
BX2	Buffer sensor B41
BX3	
BX4	
BX7	Hot-gas sensor B81
BX8	DHW sensor B3
BX9	Outside sensor B9
BX10	HP flow sensor B21
BX11	B1
BX12	HP return sensor B71
BX13	Source inlet sensor B91
BX14	Source outl sens B92/B84 B92
QX1	
QX2	
QX3	
QX5	
QX6	
QX7	Compressor stage 1 K1
QX8	DHW ctrl elem Q3
QX9	Heat circuit pump HC1 Q2
QX10	Y1
QX11	Y2
QX12	Source pump Q8/fan K19 Q8
QX13	Condenser pump Q9
EX9	Low-pressure switch E9
EX10	High-pressure switch E10
EX11	Overload compressor 1 E11

Plant diagram 7

Brine-to-water heat pump with combi storage tank and DHW charging pump Q3, mixing or pump heating circuit.

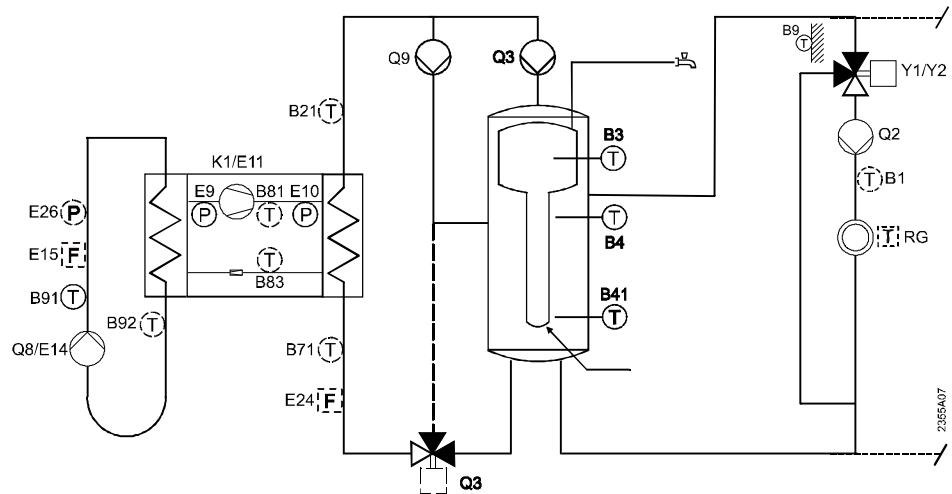

Multifunctional terminals

RVS61..	
BX1	Buffer sensor B4
BX2	Buffer sensor B41
BX3	
BX4	
BX7	Hot-gas sensor B81
BX8	DHW sensor B3
BX9	Outside sensor B9
BX10	HP flow sensor B21
BX11	B1
BX12	HP return sensor B71
BX13	Source inlet sensor B91
BX14	Source outl sens B92/B84 B92
QX1	
QX2	
QX3	
QX5	
QX6	
QX7	Compressor stage 1 K1
QX8	DHW ctrl elem Q3
QX9	Heat circuit pump HC1 Q2
QX10	Y1
QX11	Y2
QX12	Source pump Q8/fan K19 Q8
QX13	Condenser pump Q9
EX9	Low-pressure switch E9
EX10	High-pressure switch E10
EX11	Overload compressor 1 E11

Plant diagram 8

Brine-to-water heat pump with combi storage tank and DHW diverting valve Q3, mixing or pump heating circuit.

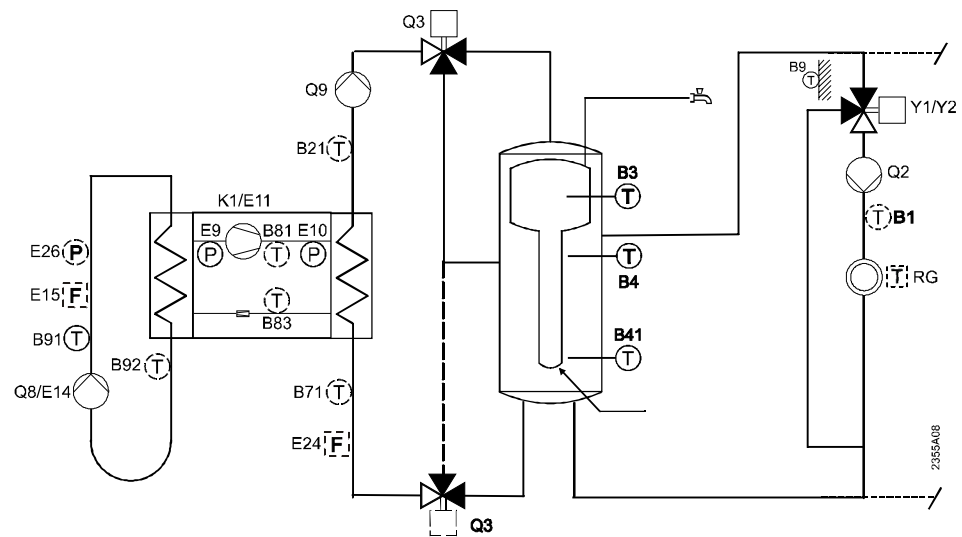

Multifunctional terminals

RVS61..	
BX1	Buffer sensor B4
BX2	Buffer sensor B41
BX3	
BX4	
BX7	Hot-gas sensor B81
BX8	DHW sensor B3
BX9	Outside sensor B9
BX10	HP flow sensor B21
BX11	B1
BX12	HP return sensor B71
BX13	Source inlet sensor B91
BX14	Source outl sens B92/B84 B92
QX1	
QX2	
QX3	
QX5	
QX6	
QX7	Compressor stage 1 K1
QX8	DHW ctrl elem Q3
QX9	Heat circuit pump HC1 Q2
QX10	Y1
QX11	Y2
QX12	Source pump Q8/fan K19 Q8
QX13	Condenser pump Q9
EX9	Low-pressure switch E9
EX10	High-pressure switch E10
EX11	Overload compressor 1 E11

Plant diagram 9

Air-to-water heat pump with pump heating circuit.

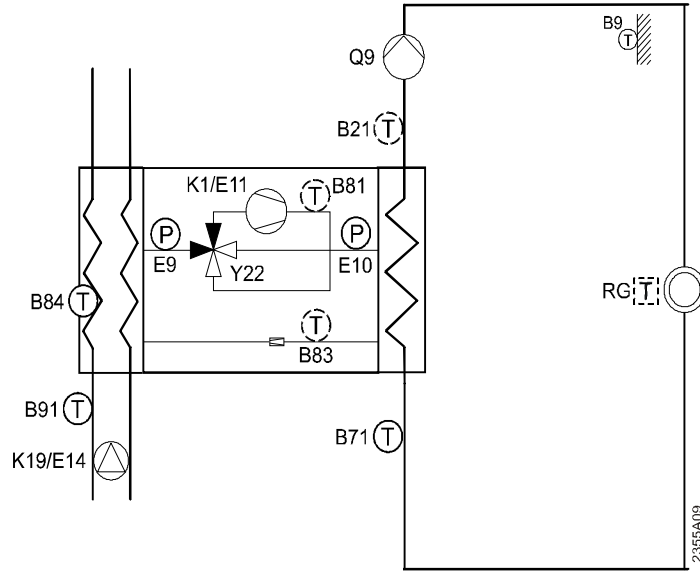

Multifunctional terminals

RVS61..	
BX1	
BX2	
BX3	
BX4	
BX7	Hot-gas sensor B81
BX8	
BX9	Outside sensor B9
BX10	HP flow sensor B21
BX11	
BX12	HP return sensor B71
BX13	Source inlet sensor B91
BX14	Source outl sens B92/B84 B84
QX1	Process revers valve Y22
QX2	
QX3	
QX5	
QX6	
QX7	Compressor stage 1 K1
QX8	
QX9	
QX10	
QX11	
QX12	Source pump Q8/fan K19 (K19)
QX13	Condenser pump Q9
EX9	Low-pressure switch E9
EX10	High-pressure switch E10
EX11	Overload compressor 1 E11

Plant diagram 10

Air-to-water heat pump with pump heating circuit and DHW storage tank with DHW charging pump Q3.

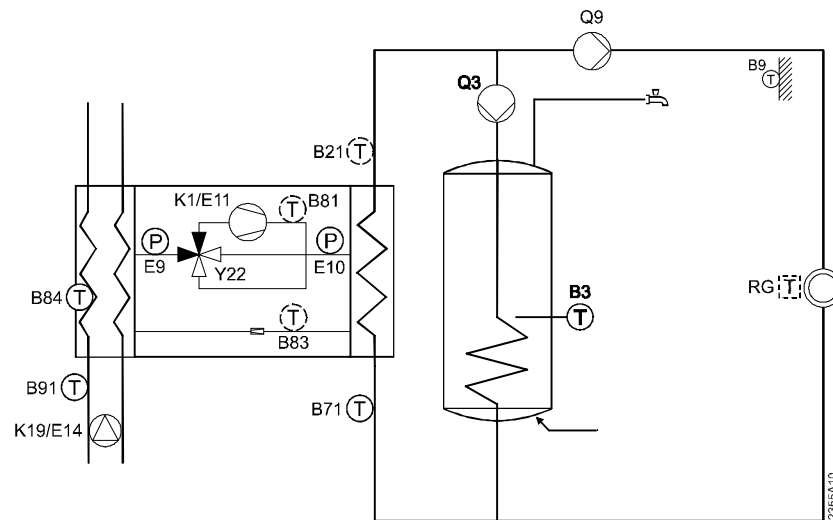

Multifunctional terminals

RVS61..	
BX1	
BX2	
BX3	
BX4	
BX7	Hot-gas sensor B81
BX8	DHW sensor B3
BX9	Outside sensor B9
BX10	HP flow sensor B21
BX11	
BX12	HP return sensor B71
BX13	Source inlet sensor B91
BX14	Source outl sens B92/B84 B84
QX1	Process revers valve Y22
QX2	
QX3	
QX5	
QX6	
QX7	Compressor stage 1 K1
QX8	DHW ctrl elem Q3
QX9	
QX10	
QX11	
QX12	Source pump Q8/fan K19 (K19)
QX13	Condenser pump Q9
EX9	Low-pressure switch E9
EX10	High-pressure switch E10
EX11	Overload compressor 1 E11

Plant diagram 11

Air-to-water heat pump with pump heating circuit and DHW storage tank with DHW diverting valve Q3.

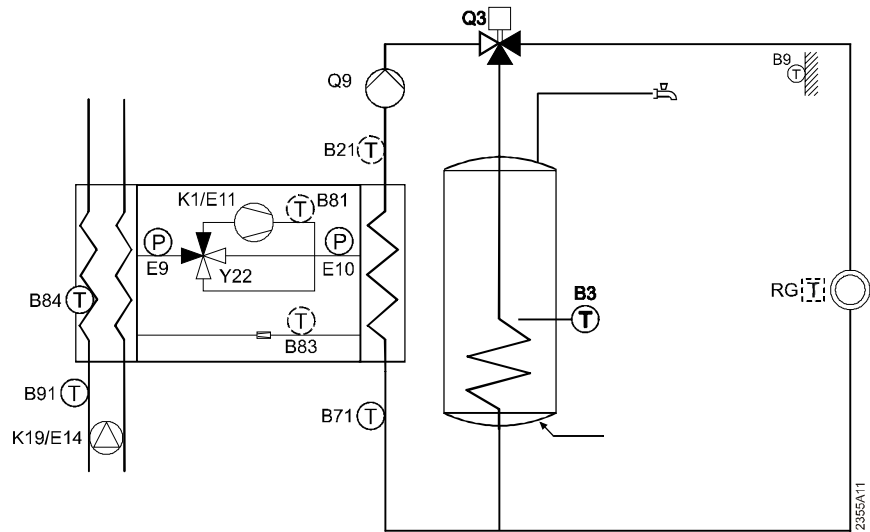

Multifunctional terminals

RVS61..	
BX1	
BX2	
BX3	
BX4	
BX7	Hot-gas sensor B81
BX8	DHW sensor B3
BX9	Outside sensor B9
BX10	HP flow sensor B21
BX11	
BX12	HP return sensor B71
BX13	Source inlet sensor B91
BX14	Source outl sens B92/B84 B84
QX1	Process revers valve Y22
QX2	
QX3	
QX5	
QX6	
QX7	Compressor stage 1 K1
QX8	DHW ctrl elem Q3
QX9	
QX10	
QX11	
QX12	Source pump Q8/fan K19 (K19)
QX13	Condenser pump Q9
EX9	Low-pressure switch E9
EX10	High-pressure switch E10
EX11	Overload compressor 1 E11

Plant diagram 12

Air-to-water heat pump with buffer storage tank and mixing or pump heating circuit.

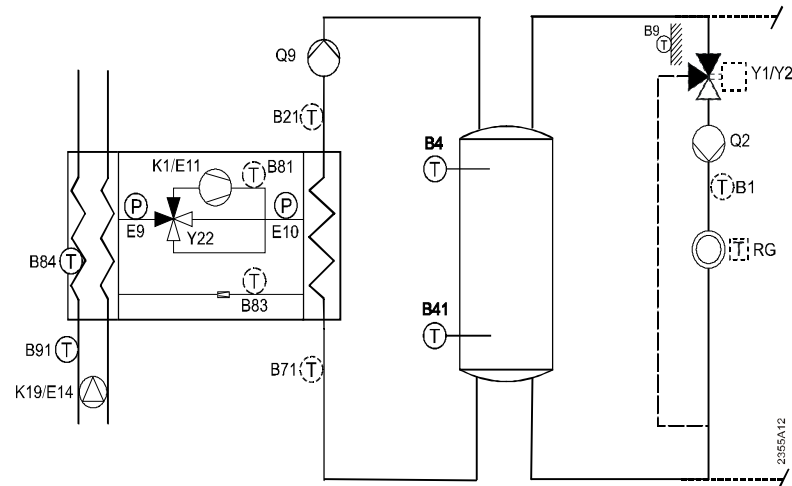

Multifunctional terminals

RVS61..	
BX1	Buffer sensor B4
BX2	Buffer sensor B41
BX3	
BX4	
BX7	Hot-gas sensor B81
BX8	
BX9	Outside sensor B9
BX10	HP flow sensor B21
BX11	B1
BX12	HP return sensor B71
BX13	Source inlet sensor B91
BX14	Source outl sens B92/B84 B84
QX1	Process revers valve Y22
QX2	
QX3	
QX5	
QX6	
QX7	Compressor stage 1 K1
QX8	
QX9	Heat circuit pump HC1 Q2
QX10	Y1
QX11	Y2
QX12	Source pump Q8/fan K19 (K19)
QX13	Condenser pump Q9
EX9	Low-pressure switch E9
EX10	High-pressure switch E10
EX11	Overload compressor 1 E11

Plant diagram 13

Air-to-water heat pump with buffer storage tank, DHW storage tank with charging pump Q3 and mixing or pump heating circuit.

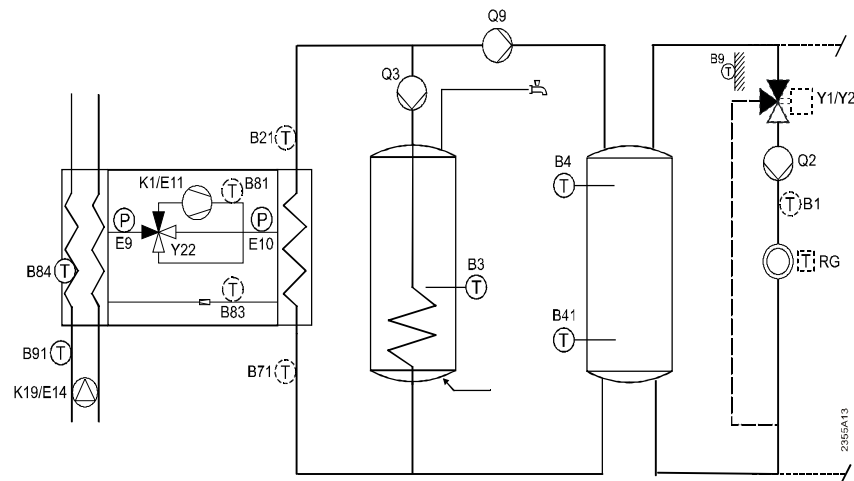

Multifunctional terminals

RVS61..	
BX1	Buffer sensor B4
BX2	Buffer sensor B41
BX3	
BX4	
BX7	Hot-gas sensor B81
BX8	DHW sensor B3
BX9	Outside sensor B9
BX10	HP flow sensor B21
BX11	B1
BX12	HP return sensor B71
BX13	Source inlet sensor B91
BX14	Source outl sens B92/B84 B84
QX1	Process revers valve Y22
QX2	
QX3	
QX5	
QX6	
QX7	Compressor stage 1 K1
QX8	DHW ctrl elem Q3
QX9	Heat circuit pump HC1 Q2
QX10	Y1
QX11	Y2
QX12	Source pump Q8/fan K19 (K19)
QX13	Condenser pump Q9
EX9	Low-pressure switch E9
EX10	High-pressure switch E10
EX11	Overload compressor 1 E11

Plant diagram 14

Air-to-water heat pump with buffer storage tank, DHW storage tank with diverting valve Q3 and mixing or pump heating circuit.

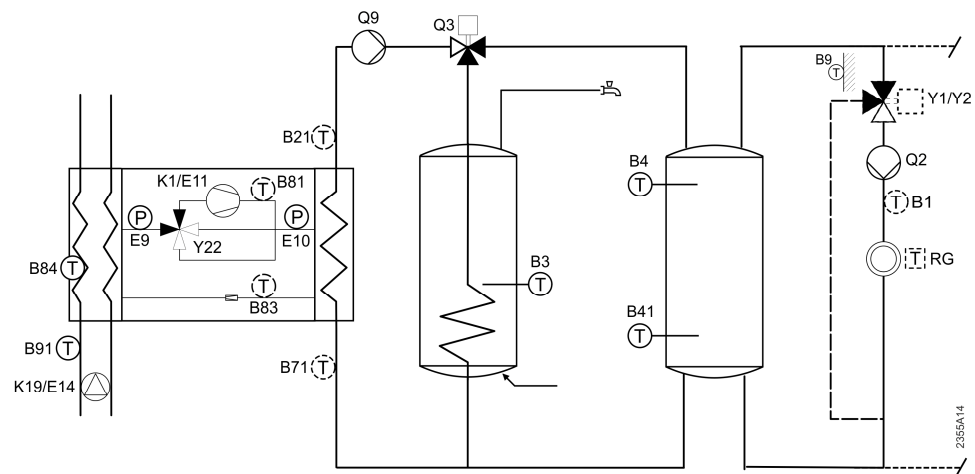

Multifunctional terminals

RVS61..	
BX1	Buffer sensor B4
BX2	Buffer sensor B41
BX3	
BX4	
BX7	Hot-gas sensor B81
BX8	DHW sensor B3
BX9	Outside sensor B9
BX10	HP flow sensor B21
BX11	B1
BX12	HP return sensor B71
BX13	Source inlet sensor B91
BX14	Source outl sens B92/B84 B84
QX1	Process revers valve Y22
QX2	
QX3	
QX5	
QX6	
QX7	Compressor stage 1 K1
QX8	DHW ctrl elem Q3
QX9	Heat circuit pump HC1 Q2
QX10	Y1
QX11	Y2
QX12	Source pump Q8/fan K19 (K19)
QX13	Condenser pump Q9
EX9	Low-pressure switch E9
EX10	High-pressure switch E10
EX11	Overload compressor 1 E11

Plant diagram 15

Air-to-water heat pump with combi storage tank and DHW charging pump Q3, mixing or pump heating circuit.

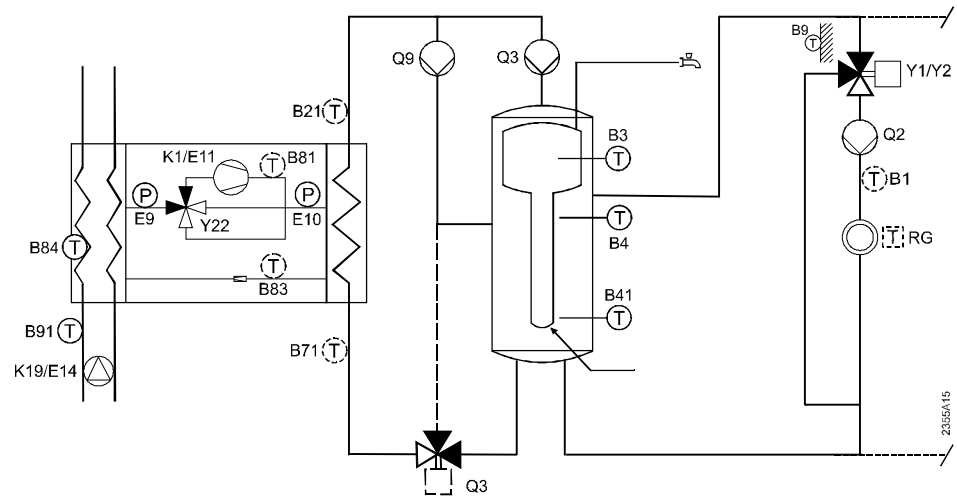

Multifunctional terminals

RVS61..	
BX1	Buffer sensor B4
BX2	Buffer sensor B41
BX3	
BX4	
BX7	Hot-gas sensor B81
BX8	DHW sensor B3
BX9	Outside sensor B9
BX10	HP flow sensor B21
BX11	B1
BX12	HP return sensor B71
BX13	Source inlet sensor B91
BX14	Source outl sens B92/B84 B84
QX1	Process revers valve Y22
QX2	
QX3	
QX5	
QX6	
QX7	Compressor stage 1 K1
QX8	DHW ctrl elem Q3
QX9	Heat circuit pump HC1 Q2
QX10	Y1
QX11	Y2
QX12	Source pump Q8/fan K19 (K19)
QX13	Condenser pump Q9
EX9	Low-pressure switch E9
EX10	High-pressure switch E10
EX11	Overload compressor 1 E11

Plant diagram 16

Air-to-water heat pump with combi storage tank and DHW diverting valve Q3, mixing or pump heating circuit.

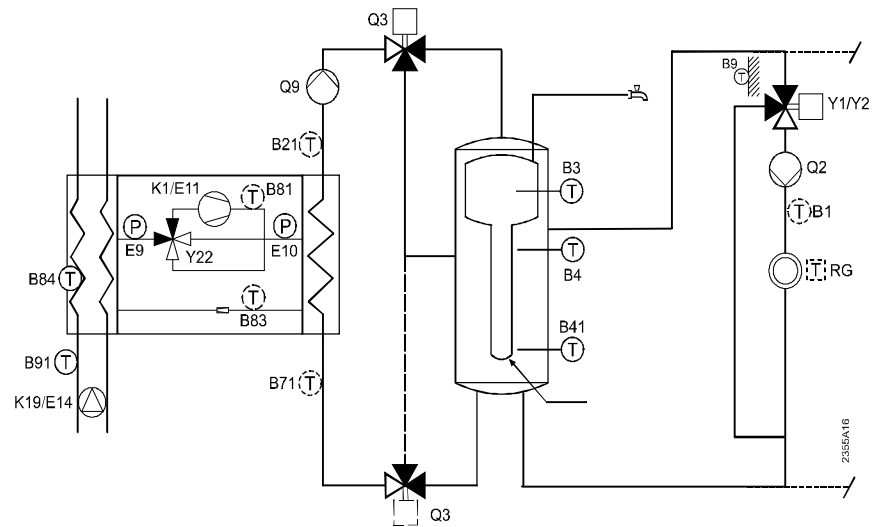

Multifunctional terminals

RVS61..	
BX1	Buffer sensor B4
BX2	Buffer sensor B41
BX3	
BX4	
BX7	Hot-gas sensor B81
BX8	DHW sensor B3
BX9	Outside sensor B9
BX10	HP flow sensor B21
BX11	B1
BX12	HP return sensor B71
BX13	Source inlet sensor B91
BX14	Source outl sens B92/B84 B84
QX1	Process revers valve Y22
QX2	
QX3	
QX5	
QX6	
QX7	Compressor stage 1 K1
QX8	DHW ctrl elem Q3
QX9	Heat circuit pump HC1 Q2
QX10	Y1
QX11	Y2
QX12	Source pump Q8/fan K19 (K19)
QX13	Condenser pump Q9
EX9	Low-pressure switch E9
EX10	High-pressure switch E10
EX11	Overload compressor 1 E11

Plant diagram 17

Brine-to-water heat pump, DHW storage tank with DHW diverting valve Q3 and solar collector, pump heating circuit.

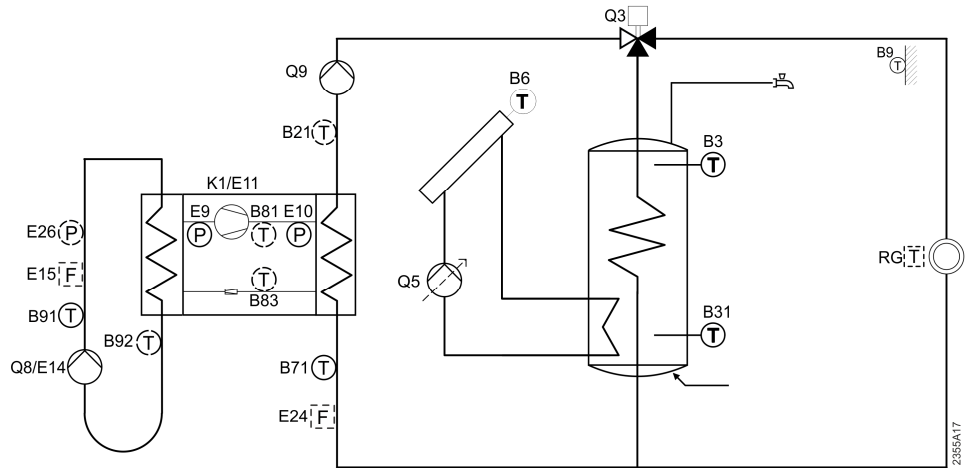

Multifunctional terminals

RVS61..	
BX1	
BX2	
BX3	Collector sensor B6
BX4	DHW sensor B31
BX7	Hot-gas sensor B81
BX8	DHW sensor B3
BX9	Outside sensor B9
BX10	HP flow sensor B21
BX11	
BX12	HP return sensor B71
BX13	Source inlet sensor B91
BX14	Source outl sens B92/B84 B92
QX1	
QX2	
QX3	
QX5	Collector pump Q5
QX6	
QX7	Compressor stage 1 K1
QX8	DHW ctrl elem Q3
QX9	
QX10	
QX11	
QX12	Source pump Q8/fan K19 Q8
QX13	Condenser pump Q9
EX9	Low-pressure switch E9
EX10	High-pressure switch E10
EX11	Overload compressor 1 E11

Plant diagram 18

Brine-to-water heat pump, combi storage tank with DHW diverting valve Q3 and solar collector, mixing or pump heating circuit.

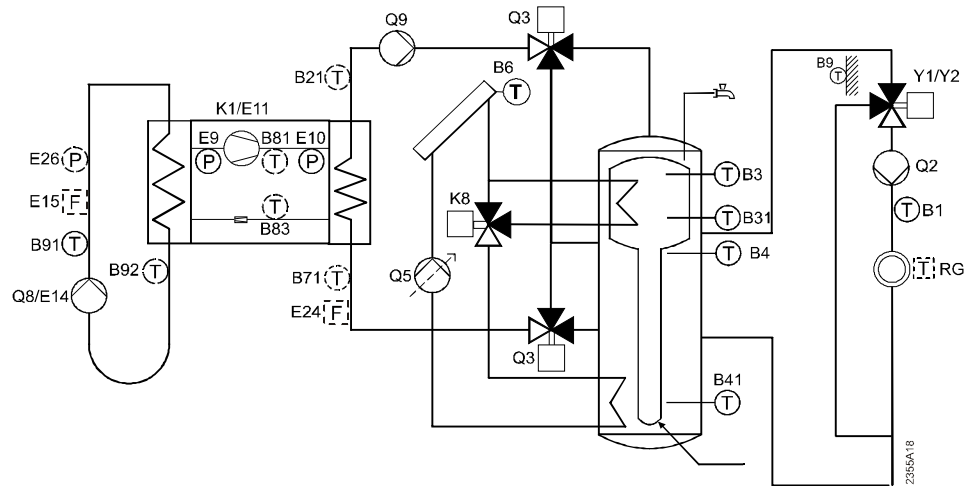

Multifunctional terminals

RVS61..	
BX1	Buffer sensor B4
BX2	Buffer sensor B41
BX3	Collector sensor B6
BX4	DHW sensor B31
BX7	Hot-gas sensor B81
BX8	DHW sensor B3
BX9	Outside sensor B9
BX10	HP flow sensor B21
BX11	B1
BX12	HP return sensor B71
BX13	Source inlet sensor B91
BX14	Source outl sens B92/B84 B92
QX1	
QX2	
QX3	
QX5	Collector pump Q5
QX6	Solar ctrl elem buffer K8
QX7	Compressor stage 1 K1
QX8	DHW ctrl elem Q3
QX9	Heat circuit pump HC1 Q2
QX10	Y1
QX11	Y2
QX12	Source pump Q8/fan K19 Q8
QX13	Condenser pump Q9
EX9	Low-pressure switch E9
EX10	High-pressure switch E10
EX11	Overload compressor 1 E11

Plant diagram 19

Air-to-water heat pump, DHW storage tank with DHW diverting valve Q3 and solar collector, pump heating circuit.

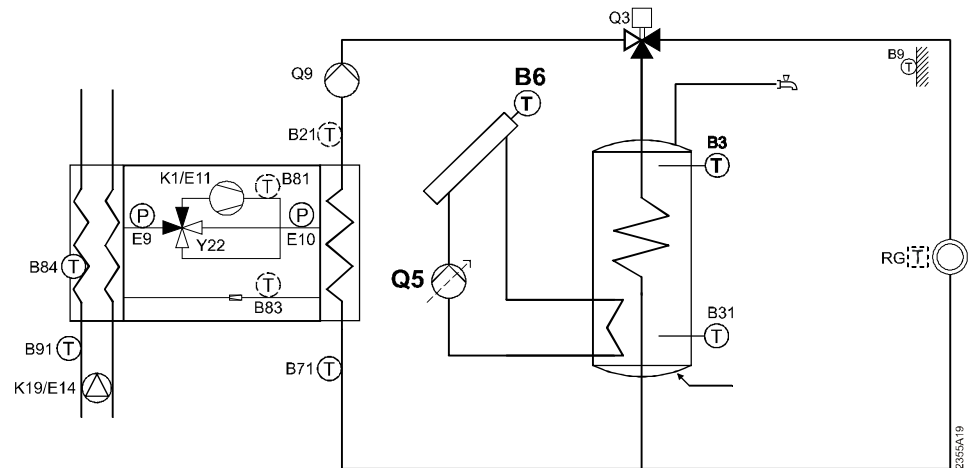

Multifunctional terminals

RVS61..	
BX1	
BX2	
BX3	Collector sensor B6
BX4	DHW sensor B31
BX7	Hot-gas sensor B81
BX8	DHW sensor B3
BX9	Outside sensor B9
BX10	HP flow sensor B21
BX11	
BX12	HP return sensor B71
BX13	Source inlet sensor B91
BX14	Source outl sens B92/B84 B84
QX1	Process revers valve Y22
QX2	
QX3	
QX5	Collector pump Q5
QX6	
QX7	Compressor stage 1 K1
QX8	DHW ctrl elem Q3
QX9	
QX10	
QX11	
QX12	Source pump Q8/fan K19 (K19)
QX13	Condenser pump Q9
EX9	Low-pressure switch E9
EX10	High-pressure switch E10
EX11	Overload compressor 1 E11

Plant diagram 20

Air-to-water heat pump, combi storage tank with DHW diverting valve Q3 and solar collector, mixing or pump heating circuit.

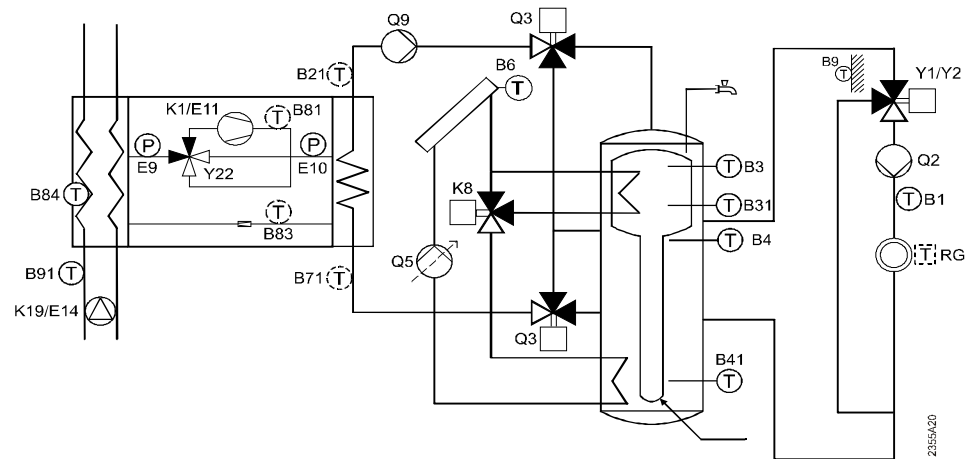

Multifunctional terminals

RVS61..	
BX1	Buffer sensor B4
BX2	Buffer sensor B41
BX3	Collector sensor B6
BX4	DHW sensor B31
BX7	Hot-gas sensor B81
BX8	DHW sensor B3
BX9	Outside sensor B9
BX10	HP flow sensor B21
BX11	B1
BX12	HP return sensor B71
BX13	Source inlet sensor B91
BX14	Source outl sens B92/B84 B84
QX1	Process revers valve Y22
QX2	
QX3	
QX5	Collector pump Q5
QX6	Solar ctrl elem buffer K8
QX7	Compressor stage 1 K1
QX8	DHW ctrl elem Q3
QX9	Heat circuit pump HC1 Q2
QX10	Y1
QX11	Y2
QX12	Source pump Q8/fan K19 (K19)
QX13	Condenser pump Q9
EX9	Low-pressure switch E9
EX10	High-pressure switch E10
EX11	Overload compressor 1 E11

Plant diagram 21

Brine-to-water heat pump, DHW storage tank with DHW charging pump Q3, pump heating circuit, mixing cooling circuit for passive cooling.

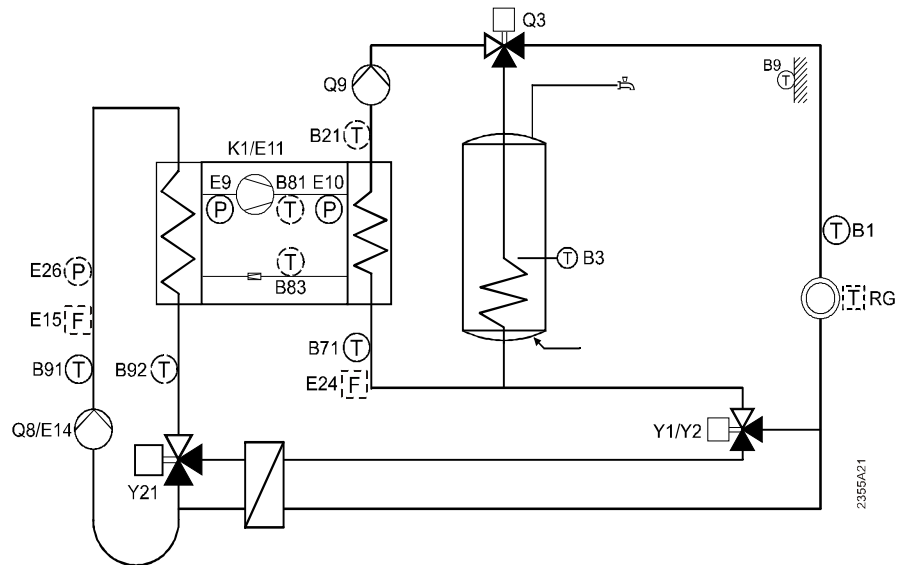

Multifunctional terminals

RVS61..	
BX1	
BX2	
BX3	
BX4	
BX7	Hot-gas sensor B81
BX8	DHW sensor B3
BX9	Outside sensor B9
BX10	HP flow sensor B21
BX11	B1
BX12	HP return sensor B71
BX13	Source inlet sensor B91
BX14	Source outl sens B92/B84 B92
QX1	
QX2	
QX3	Div valve HC/CC1 Y21
QX5	
QX6	
QX7	Compressor stage 1 K1
QX8	DHW ctrl elem Q3
QX9	Heat circuit pump HC1 Q2
QX10	Y1
QX11	Y2
QX12	Source pump Q8/fan K19 Q8
QX13	Condenser pump Q9
EX9	Low-pressure switch E9
EX10	High-pressure switch E10
EX11	Overload compressor 1 E11

Plant diagram 22

Brine-to-water heat pump, DHW storage tank with DHW charging pump Q3, buffer storage tank, mixing or pump heating circuit, mixing cooling circuit for passive cooling.

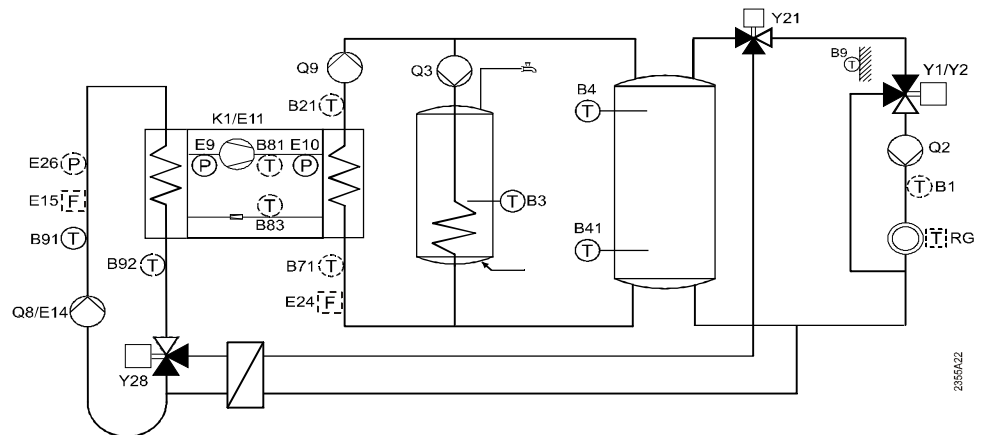

Multifunctional terminals

RVS61..	
BX1	Buffer sensor B4
BX2	Buffer sensor B41
BX3	
BX4	
BX7	Hot-gas sensor B81
BX8	DHW sensor B3
BX9	Outside sensor B9
BX10	HP flow sensor B21
BX11	B1
BX12	HP return sensor B71
BX13	Source inlet sensor B91
BX14	Source outl sens B92/B84 B92
QX1	
QX2	Div valve cool source Y28
QX3	Div valve HC/CC1 Y21
QX5	
QX6	
QX7	Compressor stage 1 K1
QX8	DHW ctrl elem Q3
QX9	Heat circuit pump HC1 Q2
QX10	Y1
QX11	Y2
QX12	Source pump Q8/fan K19 Q8
QX13	Condenser pump Q9
EX9	Low-pressure switch E9
EX10	High-pressure switch E10
EX11	Overload compressor 1 E11

Plant diagram 23

Brine-to-water heat pump, combi storage tank with DHW diverting valve Q3, mixing or pump heating circuit, mixing cooling circuit for passive cooling.

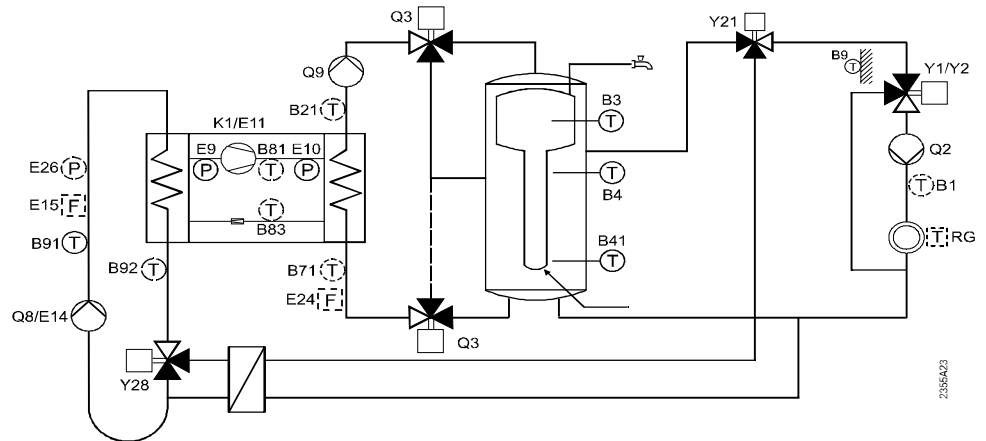

Multifunctional terminals

RVS61..	
BX1	Buffer sensor B4
BX2	Buffer sensor B41
BX3	
BX4	
BX7	Hot-gas sensor B81
BX8	DHW sensor B3
BX9	Outside sensor B9
BX10	HP flow sensor B21
BX11	B1
BX12	HP return sensor B71
BX13	Source inlet sensor B91
BX14	Source outl sens B92/B84 B92
QX1	
QX2	Div valve cool source Y28
QX3	Div valve HC/CC1 Y21
QX5	
QX6	
QX7	Compressor stage 1 K1
QX8	DHW ctrl elem Q3
QX9	Heat circuit pump HC1 Q2
QX10	Y1
QX11	Y2
QX12	Source pump Q8/fan K19 Q8
QX13	Condenser pump Q9
EX9	Low-pressure switch E9
EX10	High-pressure switch E10
EX11	Overload compressor 1 E11

Plant diagram 24

Air-to-water heat pump, DHW storage tank with DHW diverting valve Q3, mixing or pump heating circuit, mixing cooling circuit for active cooling.

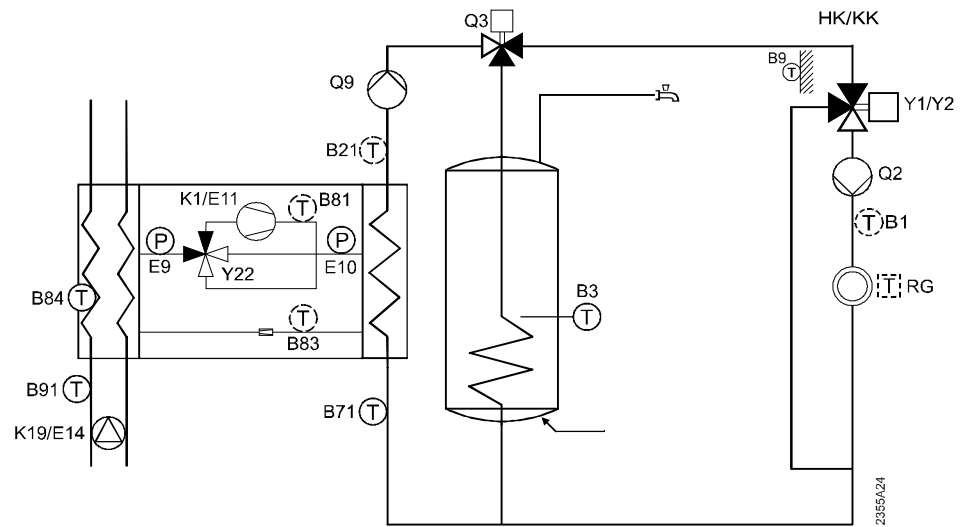

Multifunctional terminals

RVS61..	
BX1	
BX2	
BX3	
BX4	
BX7	Hot-gas sensor B81
BX8	DHW sensor B3
BX9	Outside sensor B9
BX10	HP flow sensor B21
BX11	B1
BX12	HP return sensor B71
BX13	Source inlet sensor B91
BX14	Source outl sens B92/B84 B84
QX1	Process revers valve Y22
QX2	
QX3	
QX5	
QX6	
QX7	Compressor stage 1 K1
QX8	DHW ctrl elem Q3
QX9	Heat circuit pump HC1 Q2
QX10	Y1
QX11	Y2
QX12	Source pump Q8/fan K19 (K19)
QX13	Condenser pump Q9
EX9	Low-pressure switch E9
EX10	High-pressure switch E10
EX11	Overload compressor 1 E11

8 Technical data

8.1 Basic unit RVS61.843

Power supply	Rated voltage	AC 230 V (+10%/-15%)
	Rated frequency	50/60 Hz
	Power consumption	max. 12 VA
	External supply line protection	Fuse slow max. 10 A ...or Circuit breaker max. 13 A Characteristic B, C, D according to EN 60898
Wiring of terminals	Power supply and outputs	solid or stranded wire (twisted or with ferrule): 1 core: 0.5...2.5 mm ² 2 cores: 0.5...1.5 mm ² 3 cores: not allowed.
Function data	Software class	A
	Mode of operation to EN 60730	1.B (automatic operation)
Inputs	Mains inputs EX1...EX4, EX9...EX11	max. AC 230 V
	Operating range	AC 0...253 V
	Low	< AC 95 V
	High	> AC 115 V
	Internal resistance	>100 kΩ
	Mains inputs EX5, EX6, EX7	max. AC 230 V
	Operating range	AC 0...253 V
	Low	< AC 160 V
	High	> AC 180 V
	Internal resistance	>100 kΩ
	Sensor input BX1...BX4, BX7...BX14	NTC 1k (QAC34, outside sensor), NTC 10k (QAZ36, QAD36), Pt1000 (optionally for collector and flue gas sensor) 5053...9671 ohm (readjustment of room temperature setpoint)
	Perm. sensor cables (copper)	
	– Cross-sectional area	0.25 0.5 0.75 1.0 1.5 (mm ²)
	– Max. length	20 40 60 80 120 (m)
	Digital inputs H1, H3	safety extra low-voltage for potentialfree contacts, suitable for low-voltage:
	Voltage when contact is open	DC 12 V
	Current when contact is closed	DC 3 mA
Analog inputs H1, H3	safety extra low-voltage	
Operating range	DC 0...10 V	
Internal resistance	>100 kΩ	
Pulse inputs H1, H3	safety extra low-voltage for potentialfree contacts, suitable for low-voltage:	
Voltage when contact is open	DC 12 V	
Current when contact is closed	DC 3 mA	
Pulse duration	Min. 20 ms	

Outputs	Frequency inputs H1, H3	safety extra low-voltage
	Operating range	DC 0..0.12 V
	Low	<1.7 V
	High	2.7...12 V
	Internal resistance	>100 k Ω
	Frequency	max. 500 Hz
	Relay outputs QX1...QX13	
	Rated current range	AC 0.02...2 (2) A
	Switch-on current	max.15 A for ≤ 1 s
	Total current	max. AC 10 A (all AC 230 V outputs)
	External supply line protection	Refer to section "Power supply"
	Triac output ZX4	
	Rated current range	AC 0.02...2(2) A (on/off operation) AC 0.02...1.4 (1.4) A (speed control)
Leakage current	2 mA	
Switch-on current	$I_{max} = 50$ A/ $t_p \leq 20$ ms $I_{max} = 4$ A/ $t_p \leq 1$ s	
Analog output UX1, UX2	safety extra low-voltage, output is short-circuit-proof	
Output voltage	$U_{out} = 0...10$ V	
Current load	± 2 mA RMS; ± 2.7 mA peak	
Ripple	≤ 50 mVpp	
Accuracy of zero point	$< \pm 80$ mV	
Error remaining range	≤ 130 mV	
PWM outputs UX1, UX2	safety extra low-voltage, output is short-circuit-proof	
Output voltage	high 10 V, low 0 V	
Current load	UX = min. 6 V @ 5 mA	
Frequency	3 kHz	
G+ power supply	safety extra low-voltage, output is short-circuit-proof	
Output voltage	11.3...13.2 V	
Current load	max. 88 mA	
Interfaces	BSB	2-wire connection (noninterchangeable)
	Cable length basic unit – peripheral device	max. 200 m
	Total cable length	max. 400 m (max. cable capacitance: 60 nF)
	Cross-sectional area	min. 0.5 mm ²
	LPB	copper cable 1.5 mm ² ,
	With controller bus power supply (per controller)	2-wire connection (noninterchangeable) 250 m
	With central bus power supply	460 m
	Bus loading number	E = 3
	Modbus (optionally with Modbus clip-in OCI350.01/OCI351.01 at X60)	for details, refer to Technical Data of OCI350.01/OCI351.01

Degree of protection	Protection class	If correctly installed, low-voltage live parts meet the requirements of class II according to EN 60730-1
	Overvoltage category	3 according to EN 60730-1
	Protection degree of housing	IP00 according to EN 60529
	Degree of pollution	2 according to EN 60730-1
Directives and Standards	Product standard	EN 60730-1
		Automatic electrical controls for household and similar use
	Electromagnetic compatibility (Applications)	For use in residential, commerce, light-industrial and industrial environments
	EU Conformity (CE)	CE1T2355xx2
	Environmental compatibility	The product environmental declaration CE1E2355de01 contains data on environmentally compatible product design and assessments (RoHS compliance, materials composition, packaging, environmental benefit, disposal).
Climatic conditions	Storage to EN 60721-3-1	class 1K3, -20...65 °C
	Transport to EN 60721-3-2	class 2K3, -25...70 °C
	Operation to EN 60721-3-3	class 3K5, -20...50 °C (noncondensing)
Weight	Excl. packaging	650 g

8.2 Extension module AVS75.370

Power supply	Rated voltage	AC 230 V (+10%/-15%)					
	Rated frequency	50/60 Hz					
	Power consumption	max. 6.5 VA					
	External supply line protection	Fuse slow max. 10 A ...or Circuit breaker max. 13 A Characteristic B, C, D according to EN 60898					
Wiring of terminals	Power supply and outputs	solid or stranded wire (twisted or with ferrule): 1 core: 0.5...2.5 mm ² 2 cores: 0.5...1.5 mm ² 3 cores: not allowed.					
	Software class	A					
Function data Inputs	Digital inputs H21, H22	safety extra low-voltage for potentialfree contacts, suitable for low-voltage:					
	Voltage when contact is open	DC 12 V					
	Current when contact is closed	DC 3 mA					
	Analog inputs H21, H22	safety extra low-voltage					
	Operating range	DC 0...10 V					
	Internal resistance	>100 kΩ					
	Pulse inputs H21, H22	safety extra low-voltage for potentialfree contacts, suitable for low-voltage:					
	Voltage when contact is open	DC 12 V					
	Current when contact is closed	DC 3 mA					
	Pulse duration	min. 20 ms					
	Frequency inputs H21, H22	safety extra low-voltage					
	Operating range	DC 0..0.12 V					
	Low	<1.7 V					
	High	2.7 V...12 V					
	Internal resistance	>100 kΩ					
	Frequency	max. 500 Hz					
	Mains input EX21	max. AC 230 V					
Operating range	AC 0...253 V						
Low	<95 V						
High	>115 V						
Internal resistance	>100 kΩ						
Sensor inputs BX21, BX22	NTC 10k (QAZ36, QAD36) Pt1000 (for collector) 5053...9671 ohm (readjustment of room temperature setpoint)						
Perm. sensor cables (copper)							
Cross-sectional area	0.25	0.5	0.75	1.0	1.5	mm ²	
Max. length	20	40	60	80	120	m	
Outputs	Relay outputs						
	Rated current range	AC 0.02...2 (2) A					
	Switch-on current	max. 15 A for ≤1 s					
	Total current	max. AC 6 A (all relays)					
	Rated voltage range	AC 24...230 V (for potentialfree outputs)					
External supply line protection	Refer to section "Power supply"						

	Analog outputs UX21, UX22	safety extra low-voltage, output is short-circuit-proof Output voltage $U_{out} = 0...10\text{ V}$ Current load $\pm 2\text{ mA RMS}; \pm 2.7\text{ mA peak}$ Ripple $\leq 50\text{ mVpp}$ Accuracy of zero point $< \pm 80\text{ mV}$ Error remaining range $\leq 130\text{ mV}$
	PWM outputs UX21, UX22	safety extra low-voltage, output is short-circuit-proof Output voltage high 10 V, low 0 V Current load $U_x = \text{min. } 6\text{ V @ } 5\text{ mA}$ Frequency 3 kHz
	Power supply GX21 (switchable)	safety extra low-voltage, output is short-circuit-proof Output voltage 5 V 4.75...5.25 V Output voltage 12 V 11.4...12.6 V Current load max. 20 mA
	WX21 electronic expansion valve	Type of stepper motor unipolar Control half-step full step (1 phase) Step rate 30...300 steps/s Output voltage COM 11.3...13.2 V Current load COM 260 mA per phase, max. 2 phases
Interfaces	BSB	2-wire connection (noninterchangeable)
	Cable length basic unit – peripheral device	max. 200 m
	Total cable length	max. 400 m (max. cable capacitance: 60 nF)
	Cross-sectional area	min. 0.5 mm ²
Degree of protection	Protection class	If correctly installed, low-voltage live parts meet the requirements of safety class II according to EN 60730-1
	Protection degree of housing	IP00 according to EN 60529
	Degree of pollution	2 according to EN 60730-1
Directives and Standards	Product standard	EN 60730-1
	Electromagnetic compatibility (Applications)	Automatic electrical controls for household and similar use For use in residential, commerce, light-industrial and industrial environments
	EU Conformity (CE)	CE1T2355xx11
	Environmental compatibility	The product environmental declaration CE1E2357en06 contains data on environmentally compatible product design and assessments (RoHS compliance, materials composition, packaging, environmental benefit, disposal).
Climatic conditions	Storage to EN 60721-3-1	class 1K3, -20...65 °C
	Transport to EN 60721-3-2	class 2K3, -25...70 °C
	Operation to EN 60721-3-3	class 3K5, -20...50 °C (noncondensing)
Weight	Excl. packaging	248 g

8.3 Extension module AVS75.390

Power supply	Rated voltage	AC 230 V (+10%/-15%)						
	Rated frequency	50/60 Hz						
	Power consumption	max. 4 VA						
	External supply line protection	Fuse slow max. 10 A ...or Circuit breaker max. 13 A Characteristic B, C, D according to EN 60898						
Wiring of terminals	Power supply and outputs	solid or stranded wire (twisted or with ferrule): 1 core: 0.5...2.5 mm ² 2 cores: 0.5...1.5 mm ² 3 cores: not allowed.						
Function data	Software class	A						
	Inputs	Digital input H2	safety extra low-voltage for potentialfree contacts, suitable for low-voltage:					
		Voltage when contact is open	DC 12 V					
		Current when contact is closed	DC 3 mA					
	Analog input H2	Operating range	DC 0...10 V					
		Internal resistance	>100 kΩ					
		Sensor inputs BX21, BX22	NTC 10k (QAZ36, QAD36) Pt1000 (for collector) 5053...9671 ohm (readjustment of room temperature setpoint)					
	Perm. sensor cables (copper)							
	Cross-sectional area	0.25	0.5	0.75	1.0	1.5	mm ²	
	Max. length	20	40	60	80	120	m	
Outputs	Relay outputs							
	Rated current range	AC 0.02...2 (2) A						
	Switch-on current	max. 15 A for ≤1 s						
	Total current	max. AC 6 A (all relays)						
Interfaces	External supply line protection	Refer to section "Power supply"						
	BSB	2-wire connection (noninterchangeable)						
	Cable length	max. 200 m						
	basic unit – peripheral device	max. 400 m (max. cable capacitance:						
	Total cable length	60 nF)						
Cross-sectional area	min. 0.5 mm ²							

Degree of protection	Protection class	If correctly installed, low-voltage live parts meet the requirements of safety class II according to EN 60730-1
	Protection degree of housing	IP00 according to EN 60529
	Degree of pollution	2 according to EN 60730-1
Directives and Standards	Product standard	EN 60730-1
		Automatic electrical controls for household and similar use
	Electromagnetic compatibility (Applications)	For use in residential, commerce, light-industrial and industrial environments
	EU Conformity (CE)	CE1T2357xx4
	Environmental compatibility	The product environmental declaration CE1E2357en06 contains data on environmentally compatible product design and assessments (RoHS compliance, materials composition, packaging, environmental benefit, disposal).
Climatic conditions	Storage to EN 60721-3-1	class 1K3, -20...65 °C
	Transport to EN 60721-3-2	class 2K3, -25...70 °C
	Operation to EN 60721-3-3	class 3K5, -20...50 °C (noncondensing)
Weight	Excl. packaging	293 g

8.4 Modbus clip-in OCI350.01/101

Power supply	Via basic unit RVS...	DC 5 V	
	Power consumption	max. 0.3 VA	
Interfaces	Connection to basic unit RVS... (X60) (power supply, communication)	6-pole ribbon cable (enclosed) length 0.3 m	
	Modbus		
	via RS-485 (EIA-485): A+, B-, REF	noninterchangeable	
	Protocol	Modbus RTU mode	
	Mode	master or slave	
	Electrical connection	galvanically separated	
	Cable	2-wire (twisted pair) with screening	
	Bus polarization	2 x 680 Ω	
	Bus termination	120 Ω and 1 nF	
	Baud rates	1200 / 2400 / 4800 / 9600 / 19200 / 38400 / 57600 / 76800 / 115200	
Cable lengths and cross-sectional areas	according to Modbus specification, e.g. max. 1000 m at 9600 baud and 0.13 mm ²		
Degree of protection	Protection class	If correctly installed, low-voltage live parts meet the requirements of safety class III according to EN 60730-1	
	Protection degree of housing	IP00 according to EN 60529	
	Degree of pollution	2 according to EN 60730-1	
Directives and Standards	Product standard	EN 60730-1	
		Automatic electrical controls for household and similar use	
	Electromagnetic compatibility (Applications)	For use in residential, commerce, light- industrial and industrial environments	
	EU Conformity (CE)	CE1T2355xx12	
	Environmental compatibility	The product environmental declaration CE1E2357en12 contains data on environmentally compatible product design and assessments (RoHS compliance, materials composition, packaging, environmental benefit, disposal).	
	Climatic conditions	Storage to EN 60721-3-1	class 1K3, -20...65 °C
		Transport to EN 60721-3-2	class 2K3, -25...70 °C
Operation to EN 60721-3-3		class 3K5, temp. -20...50 °C (noncondensing)	
Weight	Excl. packaging	35 g	

8.5 Modbus clip-in OCI351.01/101

Power supply	Via basic unit RVS... / LMS...	DC 5 V
	Power consumption	max. 0.3 VA
Interfaces	Connection to basic unit RVS../LMS.. (X60) (power supply, communication)	6-pole ribbon cable (enclosed) length 0.3 m
	Modbus	
	via RS-485 (EIA-485): A+, B-, REF	noninterchangeable
	Protocol	Modbus RTU mode
	Mode	master or slave
	Electrical connection	galvanically separated
	Cable	2-wire (twisted pair) with screening
	Bus polarization	2 x 680 Ω
	Bus termination	120 Ω and 1 nF
	Baud rates	1200 / 2400 / 4800 / 9600 / 19200 / 38400 / 57600 / 76800 / 115200 LMS...: max. 19200
Degree of protection	Cable lengths and cross-sectional areas	according to Modbus specification, e.g. max. 1000 m at 9600 baud and 0.13 mm ²
	Protection class	If correctly installed, low-voltage live parts meet the requirements of safety class III according to EN 60730-1
	Protection degree of housing	IP00 according to EN 60529
Directives and Standards	Degree of pollution	2 according to EN 60730-1
	Product standard	EN 60730-1
		Automatic electrical controls for household and similar use
	Electromagnetic compatibility (Applications)	For use in residential, commerce, light-industrial and industrial environments
	EU Conformity (CE)	CE1T2355xx12
	Environmental compatibility	The product environmental declaration CE1E2357en12 contains data on environmentally compatible product design and assessments (RoHS compliance, materials composition, packaging, environmental benefit, disposal).
	Climatic conditions	Storage to EN 60721-3-1
Transport to EN 60721-3-2		class 2K3, -25...70 °C
Operation to EN 60721-3-3		class 3K5, temp. -20...50 °C (noncondensing)
Weight	Excl. packaging	35 g
	With packaging	<ul style="list-style-type: none"> OCI351.01/101: 45 g OCI351.01/109: 4 kg (72 devices)
Device variants	Device variants	<ul style="list-style-type: none"> OCI351.01/101: Devices individually packed in cardboard boxes, suitable for mounting on the plant. OCI351.01/109: Packed in groups of 72 devices, suitable for mounting at the OEM factory.

8.6 Sensor characteristics

8.6.1 NTC 1k

T [°C]	R[ohm]	T [°C]	R[ohm]	T [°C]	R[ohm]
-30.0	13,034	0.0	2,857	30.0	827
-29.0	12,324	1.0	2,730	31.0	796
-28.0	11,657	2.0	2,610	32.0	767
-27.0	11,031	3.0	2,496	33.0	740
-26.0	10,442	4.0	2,387	34.0	713
-25.0	9,889	5.0	2,284	35.0	687
-24.0	9,369	6.0	2,186	36.0	663
-23.0	8,880	7.0	2,093	37.0	640
-22.0	8,420	8.0	2,004	38.0	617
-21.0	7,986	9.0	1,920	39.0	595
-20.0	7,578	10.0	1,840	40.0	575
-19.0	7,193	11.0	1,763	41.0	555
-18.0	6,831	12.0	1,690	42.0	536
-17.0	6,489	13.0	1,621	43.0	517
-16.0	6,166	14.0	1,555	44.0	500
-15.0	5,861	15.0	1,492	45.0	483
-14.0	5,574	16.0	1,433	46.0	466
-13.0	5,303	17.0	1,375	47.0	451
-12.0	5,046	18.0	1,320	48.0	436
-11.0	4,804	19.0	1,268	49.0	421
-10.0	4,574	20.0	1,218	50.0	407
-9.0	4,358	21.0	1,170		
-8.0	4,152	22.0	1,125		
-7.0	3,958	23.0	1,081		
-6.0	3,774	24.0	1,040		
-5.0	3,600	25.0	1,000		
-4.0	3,435	26.0	962		
-3.0	3,279	27.0	926		
-2.0	3,131	28.0	892		
-1.0	2,990	29.0	859		

8.6.2 NTC 5k

T [°C]	R [ohm]	T [°C]	R [ohm]	T [°C]	R [ohm]
-30.0	87,602	50.0	1,803	130.0	149
-25.0	64,645	55.0	1494	135.0	131
-20.0	48,180	60.0	1,245	140.0	116
-15.0	36,251	65.0	1,042	145.0	103
-10.0	27,524	70.0	877	150.0	91
-5.0	21,079	75.0	740		
0.0	16,277	80.0	628		
5.0	12,670	85.0	535		
10.0	9,936	90.0	458		
15.0	7,849	95.0	393		
20.0	6244	100.0	339		
25.0	5,000	105.0	293		
30.0	4,030	110.0	254		
35.0	3,267	115.0	221		
40.0	2,665	120.0	193		
45.0	2,186	125.0	169		

8.6.3 NTC 10k

T [°C]	R[ohm]	T [°C]	R[ohm]	T [°C]	R[ohm]
-30.0	175203	50.0	3605	130.0	298
-25.0	129289	55.0	2989	135.0	262
-20.0	96360	60.0	2490	140.0	232
-15.0	72502	65.0	2084	145.0	206
-10.0	55047	70.0	1753	150.0	183
-5.0	42158	75.0	1481	155.0	163
0.0	32555	80.0	1256	160.0	145
5.0	25339	85.0	1070	165.0	130
10.0	19873	90.0	915	170.0	117
15.0	15699	95.0	786	175.0	105
20.0	12488	100.0	677	180.0	95
25.0	10000	105.0	586	185.0	85
30.0	8059	110.0	508	190.0	77
35.0	6535	115.0	443	195.0	70
40.0	5330	120.0	387	200.0	64
45.0	4372	125.0	339		

8.6.4 Pt1000

T [°C]	R[ohm]	T [°C]	R[ohm]	T [°C]	R[ohm]
-30	882.2	50	1194.0	130	1498.3
-25	901.9	55	1213.2	135	1517.1
-20	921.6	60	1232.4	140	1535.8
-15	941.2	65	1251.6	145	1554.6
-10	960.9	70	1270.8	150	1573.3
-5	980.4	75	1289.9	155	1591.9
0	1000.0	80	1309.0	160	1610.5
5	1019.5	85	1328.0	165	1629.1
10	1039.0	90	1347.1	170	1647.7
15	1058.5	95	1366.1	175	1666.3
20	1077.9	100	1385.1	180	1684.8
25	1097.3	105	1404.0	185	1703.3
30	1116.7	110	1422.9	190	1721.7
35	1136.1	115	1441.8	195	1740.2
40	1155.4	120	1460.7	200	1758.6
45	1174.7	125	1479.5		

8.6.5 Room setpoint readjustment

T [°K]	R [ohm]
-3	5053
-2.5	5736
-2	6329
-1.5	6849
-1	7308
-0.5	7717
0	8083
0.5	8413
1	8712
1.5	8984
2	9233
2.5	9461
3	9671

8.7 Xp, Tn, Tv – Step response method

Setting rule for Xp Tn and Tv via control system step response

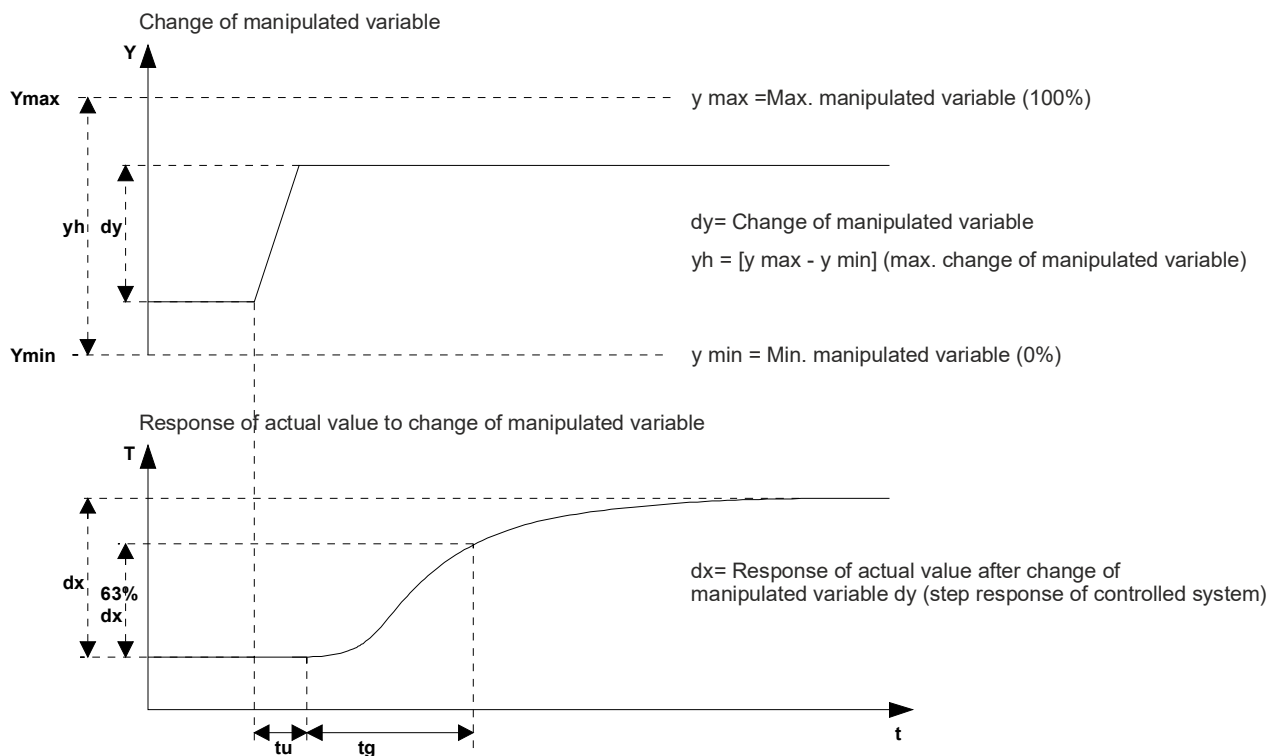

P-band Xp: $X_p = 1.5 * (t_u/t_g) * y_h * dx / dy$

Integral action time Tn: $T_n = 1.5 * t_g$

Derivative action time Tv: $T_v = t_u / 2$

Index

2	
24-hour cooling limit.....	125
24-hour heating limit	103
24-hour yield solar energy.....	463
2nd pump speed.....	373
3	
3-phase current	387
3-phase current controller	387
A	
Absolute priority	145
Acknowledgements.....	419
Acting direction	
Input Ex.....	386
Action changeover functions	408
Actual value	
Heat pump	458
Primary controller temperature.....	468
Swimming pool.....	468
Actual value buffer storage tank.....	470
Actual values DHW.....	467
Actuator	
DHW	329
Instantaneous water heater	346
Running time	115, 155
Type.....	115
Actuator running time	
Return mixing valve.....	296
Actuators self configuration.....	417
Adaption	
Heating curve	103
Adaption of partial diagrams.....	354
Adaptive superheat setpoint.....	240
Air quality	
Measurement	405
Setpoints.....	136
Air-to-water heat pumps.....	491
Alarm.....	407
Temperatures	419
Alarm message.....	388
Alarm message ext.	379
Alarm output.....	374
Antifreeze agents.....	291
Applications	482
Auto generation lock	301, 305
Automatic DHW push.....	325
Automatic mode.....	99, 121, 140
AVS75.39x.....	99

B	
B36.....	333
Basic plant diagrams	482
Boost heating	111
Boost ventilation.....	136
Brine-to-water heat pump	483
Buffer storage tank	300
Cooling	134
Frost protection.....	307
Frost protection for Eco.....	307
Full charging	212
Temp max cooling	304, 306
Buffer storage tank function.....	119, 134, 326
Buffer storage tank temperature	
Min/max.....	304, 306
Building and room model.....	395
Building mass.....	395
Building time constant	466
Bus power supply	
Function.....	407
State.....	407
BX1...BX14	378
BX21, 22	435
C	
Cascade.....	270
Cascade master	408
Cascade pump	372
Changeover of operating mode.....	379
Charge time limitation Heating circuit.....	319
Charging	
Once/day	314
Several times/day	314
Charging controller solar (dT)	287
Charging DHW	314
Charging prio photovoltaics	
Buffer.....	153
Charging priority	145
DHW.....	316
Charging priority DHW.....	294
Charging pump	
Solar	370
Charging temp max	321
Charging temperature	
Buffer storage tank maximum.....	308
Charging temperature solar	287
Charging temperature, minimum.....	287
Charging time.....	288
Charging time limitation DHW.....	318
Check numbers	400

Chimney sweep function	427	Consumer circuit pump.....	373
Circulating pump	148, 372	Consumer circuits.....	150
Legionella function.....	147	Contact type	
Clearing sensors	399	Input EX21	437
Clock mode.....	410	Setp hot-gas temp.....	185
Codes	404	Contact type:Contacts H1, H3.....	382
Error.....	475	Control condenser pump	165
Maintenance.....	480	Control of mixing valve	115, 346
Special operating.....	480	Cooling	
Collector		Diverting valve	371, 374
dT	287	SD ch'over cooling pas/act.....	227
Sensor type	395	Source off	229
Start function	289	Source temp min.....	227
Collector frost protection	290	Speed control.....	230
Collector overtemperature protection.....	290, 463	Speed control locking time	232
Collector overtemperature protection function ...	152	Speed max.....	232
Collector pump.....	373	Speed min.....	232
Minimum running time	289	Switching diff source off.....	230
Collector start function	289	Switch-off temp max.....	227
Collector temperature 1, 2.....	462	Temperature differential.....	228
Comfort setpoint	101, 124, 141	Cooling circuit 1, 2.....	355
Comfort setpoint max.....	102	Cooling circuit mixing valve.....	467
Comfort setpoint min.....	124	Cooling circuit pump 1	467
Commissioning	25	Cooling curve	125
Commissioning code.....	404	Cooling down	
Commissioning function	431	dT cooling down end	221
Commissioning wizard	430	Cooling limit.....	125
Common fault heat pump.....	387	COP	193
Common flow info values	469	Crankcase heater	179
Compensation heat deficit.....	205	Curing heating	116
Compensation variants	108, 128	Curve	102
Complementary operation	202	Curve correction pump	120
Compressor		Curve for cooling	125
Off time	181	D	
Settings	181	Default values	98
Switch-off temperature.....	182	Defrost	
Compressor 2	190, 196, 371	dT fan	225
Compressor control.....	177, 178	Duration lock.....	221
Compressor modulation	197	Forced defrosting	222
Compressor power.....	194, 261	Function.....	216, 217
Compressor run time min.....	181	Number of attempts.....	220
Compressor sequence	459	Release	216, 217
Compressor sequence changeover.....	190	Defrost end.....	220
Compressor stage 1.....	375	Defrost function	429
Concentration of antifreeze agents.....	291	Defrost lock	461
Condenser overtemperature protection	213	Defrost manual.....	387
Condenser pump	165	Defrost manual E17.....	387
Condenser pump Q9.....	374	Defrost message	389
Configuration	354	Defrost settling, remaining time.....	461
Connection of storage tank		Defrost state.....	461
Solid fuel boiler.....	295	Defrosting	
Connection terminals		dripping time evaporator.....	222
AVS75.391	22	Fan above.....	225
Connection terminals AVS75.370	17	Fan min/max	225
Connection terminals AVS75.390	20	Min switch-off temp	224
Connection terminals RVS61.843.....	13		

Settling time	222	Buffer/cooling circuit relative.....	304
Temperature differential max.....	220	Collector 1, 2.....	463
Dehumidifier	353	Condenser	166
Delay		Defrosting	220
Lockout position	286	End of defrost fan.....	225
Mains fault.....	207	Evaporator	174
Delay 3-pase current error	207	Generation lock.....	303, 305
Delay secondary pump	288	Solar charging controller	287
Delta-T controller	347	Duration	
Device address.....	407	Error repetition	206
Device address ext source.....	363	Duration legionella.....	147
Device data	403	E	
Device hours run.....	403	E10	388
Dewpoint monitor.....	380	E14	386
Dewpoint monitoring	132	E15	387
DHW.....	423	E17	387
Charging attempts	207	E20	387
Charging priority	155	E21	388
Charging priority VK	150	E21-23	387
Discharging protection	320	E24	387
Diverting valve.....	356	E25	387
Electric immersion heater	372	E29	388
Nominal setpoint.....	143	E30	388
Operating mode.....	143	E31	389
Overtemperature protection	321	E32	389
Reduced setpoint	143	E33	389
Release.....	144	E34	390
Transfer.....	330	E35	390
DHW assignment.....	408	E5	386
DHW charging	314	E6	386
Buffer storage tank	326	E61	389
Primary controller/system pump.....	326	E64	390
Solar integration	326	E9	388
DHW charging priority.....	145	Eco function	
DHW controlling element	356	Frost protection	307
DHW controlling element Q3.....	374	Eco functions.....	104, 105, 125, 126
DHW push.....	325	Eco selection.....	143
DHW request.....	318	Economy mode	425
DHW storage tank		Electric compressor power	194
Maximum temperature.....	321	Electric immersion heater	201
Switch on and off.....	356	Buffer storage tank.....	373
DHW switching differential	317	DHW.....	372
Digital scroll compressor.....	199	Flow.....	201
Dimensions.....	12	Flow K25.....	371
Direction of control action		Flow K26.....	371
Input EX.....	391	For legionella function	322
Disable		Operating mode	322
Heat pump	432	Release	324
Discharging protection		Type/location.....	365
DHW	320	Electric immersion heating	
Diverting valve	371	On	424
Solar	370	Electrical utility lock	386
Diverting valve cooling	371, 374, 467	Electronic expansion valves.....	439
Drilling plan.....	12	Emergency op function type	428
dT		Emergency operation	428
Buffer/cooling circuit	303, 306		

Energy, brought in.....	256	Flow temperature setpoint compensation.....	332
Engineer's code.....	404	Flow temperature setpoint cooling 1	467
Error codes.....	475	Flow temperature setpoint increase hygro.....	381
Error list.....	479	Forced buffer storage tank charging.....	212
Error message.....	379, 388	Forced charging	268
Error repetition.....	206	Forced charging buffer storage tank.....	299
Error repetitions	420	Forced defrosting	222, 461
Error reset	420	Frost protection	102
Errors	419	Buffer.....	307
Evapor temp defrost end.....	220	For Eco function.....	307
Evaporation heat carrier.....	290	HC-pump	114
Evaporator temperature	461	Plant.....	397
EX1...EX11.....	391	Frost protection for the heating circuit.....	120
EX21	437	Frost protection for the plant.....	397
EX5-7	386	CC pump	130
Excess heat draw	118, 326	Condenser pump	165
Extension modul		Solid fuel boiler	297
H21	436	Frost protection setpoint	101, 102
Extension module	99	Full charging	
Bx	435	With B36.....	333
EX21	437	Full charging of buffer storage tank.....	212
GX21.....	437	Function	
H22	436	Input H2.....	435
Qx	434	Function extension module.....	18, 21, 23
UX21	438	Function extension module 1, 2 and 3.....	434
UX22.....	438	Function input Hx	379
Extension module AVS75.370	16	Function Minimum flow.....	118
Extension modules 1, 2, 3.....	434	Function output UX.....	393
F		Functional heating	116
Factory setting.....	400	G	
Fan K19.....	461	Gas energy content.....	255
Fault		Generation lock	301, 305
3-phase current	387	Gradient collector start func.....	289
Soft starter.....	387	GX21.....	437
Fault message heat pump K46.....	377	H	
Fixed day storage	258	H2.....	435
Floor		H21	436
Curing function	116	H22	436
Function	116	Heat deficit/surplus heat	205
Setp manually.....	116	Heat generation lock	
Floor heating.....	116	By solid fuel boiler.....	294
Flow detector		Heat pump	156
Consumer.....	387	Disable.....	432
Flow measurement	253, 263	Monitoring.....	433
Heat	293	Setpoints and actual values.....	458
Flow measurement Hz.....	381	Heat pump fault.....	173
Flow switch		Heat pump lock	459
Source intermediate circuit	388	Heat pump without source protection.....	430
Flow switch source.....	206, 386	Heat request.....	374
Flow temperature cooling 1	467	Heat source.....	363
Flow temperature setpoint		Heat source DHW charging	326
Limitations	106	Heat source shutoff valve	372
Maximum	106, 154	Heat up gradient.....	113
Minimum	106, 154	Heat, delivered	256
Room thermostat.....	106		

Heating circuit		K25/26	365, 370
Configuration	355	K26	371
Heating circuit 1, 2	355	K27	374
Heating circuit information	465	K28	374
Heating circuit pump HC1	374	K31	371
Heating circuit pump HC2	375	K32	375
Heating circuit pump Q20	373	K45	377
Heating curve	102	K46	377
Adaption	103	K6	322, 372
Displacement	103	K8	373
Slope	102	K9	373
Heating limit room controller	109		
Heating output / Degree	313	L	
Heating up time	111	Lead strategy	266
High-pressure supervision	157	Legionella function	146
High-pressure switch	388, 389	Mixing pump	336
History reset	420, 455	Limit value TA	194, 261
Holiday mode ventilation	98, 140	Limitation	
Holiday program	98	Flow temperature setpoint	127
Holidays		Limitation of charging time	318
End	98	Limitation of flow temperature setpoint	127
Start	98	Lock electrical utility	386
Hot-gas temp max	184	Lock heat pump	459
Hot-gas temperature	184, 371	Lock stage 2 with DHW	190
Hours run	459	Lock supplementary generator	281
Hours run collect overtemp	463	Lock time at end of heat/cool	125
Hours run device	403	Locking criteria	190, 196
Hours run solar yield	463	Locking time stage 2	190, 196
Humidity		Lockout position	286
Measurement	404	Low-pressure	186
Humidity limit	138	Low-pressure supervision	175
Humidity limit value	138	Low-pressure switch	184, 388, 389
Hx	379	Low-tariff	386
Hygro	381	LP delay	186
Hz	381	LP delay on startup	184
		LP supervision	186
I		LPB	407
Increase of "Reduced" setpoint	113		
Increase source temperature floor	172	M	
Input Ex	386	Magro pump	372
Input H2	435	Mains fault	207
Input Hx	379	Mains supervision	388
Installation	11	Maintenance codes	480
Intermediate circuit boost	332	Manual control	428
Internal output control		Manual defrost	387
SHC	243	Manual defrost E17	387
		Manual defrosting	429
K		Max dev temp diff cond	166
K1	375	Max dev temp diff evap	174
K10	374	Maximum condensation temperature	158
K13	374	Maximum evaporation temperature	176
K16	373	Maximum nominal setpoint	144
K18	373	Maximum pump speed	291, 328
K19	461	Maximum switch off temperature dT	351
K2	371	Measurement	
K25	371	Air quality	405

Room humidity	404	Optimum stop control	112
Room temperature.....	404	OT max air	170
Minimum charging temperature.....	287	OT min air	170
Minimum evaporation temperature	175	Output	
Minimum flow.....	118	Electric immersion heater flow	365, 370
Minimum off time.....	458	Relays Qx	371
Minimum pump speed.....	291, 328	ZX4-Mod.....	378
Minimum running time.....	458	Output band	266
Minimum superheat	239	Output test relays	445
Mixing pump	336, 372	Output test:UX1/UX2.....	445
Mixing valve 1, 2.....	355	Output UX	393
Mixing valve boost	115, 155	Outside temp source	410
DHW storage tank	329	Outside temperature displays	465
Mixing valve control cooling	131	Overrun time source.....	173
Mixing valve decrease.....	155	Overtemperature protection	321
Mixing valve group 1	392	Condenser	213
Modbus.....	411	DHW storage tank.....	321
Modbus expert.....	417	Solid fuel boiler	296
Mode changeover		Overtemperature protection function for collector	
Ventilation.....	139	308, 321
Modulation		Overtemperature protection pump heating circuit	
Compressor.....	197	114
Monitoring.....	187		
Dewpoint	132	P	
Monitoring heating pump.....	433	Parallel displacement	102
Monitoring pressure	398	Parameter list.....	28
Mounting.....	11	Performance factor.....	256
		Phone no. responsibility.....	430
N		Photovoltaics.....	153, 316, 390
Night cooling.....	137	Photovoltaics E64.....	390
No priority	145	Plant diagram	400
Nominal setpoint		Manual selection	354
Maximum	144	Presetting	354
NTC 10k	517	Plant diagrams	482
NTC 1k	516, 517	Power Compressor.....	261
Number		Preconfigured Modbus setting	414
DHW charg attempts	207	Prerun time cond pump	165
Error repetitions.....	420	Prerun time source	173
		Pressure measurement	381
O		Pressure switch	
Operating level.....	98	Source	386
Holidays	98	Pressure switch source.....	388
Operating lines.....	28	Primary controller	
Operating message heating pump K45	377	Cooling	134
Operating mode		Process reversal	
Air cooling	140	Settling time	180
Cooling.....	121	Process reversing valve.....	371
Cooling circuits	121	Process reversing valve Y22.....	461
Eco.....	143	Protection mode	99, 102, 121, 124, 140, 141
Heating circuits.....	99	Protection setpoint.....	141
Ventilation.....	135	Pulse count	252, 262
Ventilation stages	139	Yield.....	292
Operating mode changeover	120, 148, 408	Pulse measurement solar	292
Operating mode changeover	379	Pump capacity.....	292
Operation limit air.....	170	Pump heating circuit.....	114
Optimum start control.....	112	Pump kick	472

Pump off function.....	245	Release according to OT.....	212
Pump overrun time		Release integral	
Solid fuel boiler.....	296	Electric immersion heater.....	203
Pump speed		Release of swimming pool.....	380
DHW.....	328	Remain time defrost settling.....	461
Instantaneous water heater.....	345	Remaining time defrost lock.....	461
Pump speed Min / Max.....	119	Remaining time forced defrosting.....	461
Pump speed solar.....	291	Remaining times.....	458
Push.....	325	Reset.....	400, 419
PWM signal.....	445	Alarm relay.....	419
		Error history.....	420
		State history.....	455
Q		Reset integral	
Q11.....	372	Electric immersion heater.....	204
Q14.....	372	Reset to default parameters.....	400
Q15.....	373	Residual heat function.....	297
Q16.....	373	Responsibility phone no.....	430
Q18.....	373	Responsibility text.....	430
Q19.....	373	Restratification.....	336
Q2.....	374, 375	Return mixing valve	
Q20.....	373	Solid fuel boiler.....	296
Q21...Q23.....	373	Room compensation alone.....	108
Q25.....	372	Room frost protection for room model.....	114
Q3.....	326, 328, 374	Room influence.....	108
Q33.....	326, 337, 372	Room influence cooling.....	128
Q35.....	336, 337, 372	Room temperature.....	124, 141, 382
Q35 with Q33.....	337	Measurement.....	404
Q4.....	148, 372	Room temperature limitation cooling.....	129
Q44.....	376	Room temperature limitation SD.....	110
Q5.....	373	Room temperature model.....	466
Q8.....	374	Running time	
Q9.....	374	Instantaneous water heater.....	346
Quick increase.....	130	Return mixing valve.....	296
Quick setback.....	112	Running time actuator.....	115
Quick setback/boost heating.....	466		
QX21...QX23.....	434		
		S	
R		Saturated vapor injection.....	248
Readjustm outside sensor.....	395	Save parameters.....	399
Recooling.....	322	SD	
Recooling temp.....	322	Setp hot-gas temp.....	185
Reduced mode.....	99, 122, 140	SD ch'over cooling pas/act.....	227
Reduced setpoint.....	101, 102, 124, 141	Segment address.....	407
Reduced setpoint increase.....	113	Selection temperature request.....	146
Reduction Heating output/degree.....	313	Sensor calibration.....	293
Reduction hot-gas gas temperature.....	185	Sensor characteristics.....	516, 517
Reference room.....	108, 128	Sensor input test.....	446
Refrigeration request.....	374	Sensor inputs BX1...BX14.....	378
Refrigeration requests.....	408	Sensor readjustment.....	293
Relay test.....	445	Sensor readjustments.....	395
Relays QX1...QX13.....	371	Sensor test.....	446
Release.....	144, 190, 196	Sensor type.....	395
Air cooling.....	141	Sensors	
For source lock.....	282	Save.....	399
HP without source protection.....	430	State.....	399
Supplementary generator for DHW.....	281	Setpoint	
Swimming pool.....	380	Air quality.....	136

Heat pump.....	458	Speed control locking time.....	232
Hot-gas temp.....	185	Speed max fan/source pump.....	232
Humidity.....	138	Speed min fan/source pump.....	232
Legionella function.....	146	Stage assignment ventilation.....	139
Primary controller temperature.....	468	Stage selection.....	135
Room.....	124	Stage sequence.....	266
Room.....	141	Stage setpoint night cooling.....	137
Solar heating.....	152	Stage setpoints.....	139
Solid fuel boiler.....	294, 295	Standard.....	98
Swimming pool.....	468	Start counter.....	459
Setpoint buffer storage tank.....	470	Start function collector.....	289
Setpoint compensation, time constant.....	396	Start temperature differential.....	332
Setpoint DHW.....	467	Starting speed.....	119
Setpoint differential to storage tank.....	345	State	
Setpoint drop.....	396	Defrost.....	461
Setpoint for protection.....	124	Relay heat pump.....	457
Setpoint increase.....	126, 141	State reset.....	455
Settings.....	28	States multifunctional relays.....	471
Compressor.....	181	States relays extension modules.....	471
Settling time.....	222	Status	
SHC error message.....	390	Outside temperature control.....	469
Shifting priority.....	145	Room air quality.....	469
Shutoff valve.....	372	Ventilation bypass.....	469
Simulation of outside temperature.....	429	Ventilation fans.....	469
Simulations.....	429	Status messages.....	455
Smart grid.....	389	Storage tank transfer pump.....	372
Soft starter.....	387	Storing the parameter settings.....	399
Software version.....	403	Stratification protection.....	307
Solar.....	287	Summer changeover.....	408
Solar controlling element.....	370, 373	Summer compensation.....	126, 141
Solar energy yield.....	463	Summer/winter heating limit.....	103
Solar heat exchanger, external.....	370	Superheat control (SHC).....	237
Solar pump external heat exchanger.....	373	Supplementary generator.....	279, 375
Solar yield.....	463	Lock for DHW.....	281
Solid fuel boiler.....	294	Release DHW.....	281
Frost protection for the plant.....	297	Setpoint max.....	283
Source off below temp B83.....	229	Supplementary source	
Source output.....	255	DHW charging.....	280
Source protection.....	171, 363, 430	For source lock.....	282
Source protection sensor.....	363	Neutral zone integral.....	285
Source protection with substitute sensor.....	172	Source type.....	286
Source pump.....	170	Swimming pool circuit pump.....	373
Source pump Q8.....	374	Swimming pool	
Source sequence.....	273	Heating through heat source.....	152
Source startup time max.....	173	Solar heating.....	152
Source temp min cooling mode.....	227	Switch on and off.....	358
Source type.....	286	Swimming pool circuit.....	150
Special operating codes.....	480	Switch off temperature max. dT.....	351
Speed		Switch ventilation.....	139
Collector pump.....	462	Switching diff source off.....	230
Solar pumps.....	462	Switching differential	
Speed control.....	230	Defrosting.....	220
Collector pump.....	291	Hot-gas temp max.....	184
DHW pump.....	326, 328	Switching differential 2-pos.....	115
Instantaneous water heater.....	345	Switching differential DHW.....	317
Q3.....	326	Switching differential return temperature.....	181

switching differential source protection	172
Switching points	97
Switching times	97
Switch-off temp max	182
Switch-off temp max cooling	227
Switch-off temp min	224
Switch-on command heat pump	381
System messages	407
System pump	372
Cooling	134
System pump 2	376

T

Technical data	
AVS75.390	512
RVS61.843	507
Temp diff defrost	461
Temperature	
Solar circuit	463
Temperature alarms	419
Temperature differential	
Buffer storage tank/cooling circuit	303, 306
Cascade	277
Collector	287
Cooling mode	228
Evaporator	174
Restratification	336
Solid fuel boiler	294
Temperature differential condenser	364
Temperature differential:Condenser	166
Temperature request selection	146
Terminal markings	
AVS75.370	18
AVS75.390	21
AVS75.391	23
RVS61.843	14
Text responsibility	430
Thermostatic radiator valves	108
Time constant building	395
Time constant setp compens.	396
Time holiday mode	98
Time of day legionella function	146
Time program 5	374
Time programs	97
Tn	296

Topology	9
Total solar yield	463
Transfer pump storage tank	372
Transfer strategy	330
Type of building construction	395

U

Use of mixing valve 1, 2	355
UX1/UX2	445
UX21	438
UX22	438

V

Valve kick	472
Vapor injection (EVI)	246
Ventilation settings	135
Ventilation stages	
Assignment	139
Ventilation switch	139, 381

W

Waiting time priority	288
Warmer/cooler function	100, 123
Water pressure	398
Weather compensation alone	108, 128
Weather compensation with room influence	108, 128
With buffer	119

X

Xp	296
----------	-----

Y

Y21, Y45	374
Y22	371
Y28	371
Y4	372
Yearly performance factor	258
Yield measurement	291

Z

Z4-Mod	378
ZX4	393

Siemens Switzerland Ltd
Smart Infrastructure
Global Headquarters
Theilerstrasse 1a
6300 Zug
Switzerland
Tel. +41 58 724 24 24
<http://www.siemens.com>

© Siemens Switzerland Ltd, 2009
Subject to change