

Heavy Duty Safety Switch

Type VBII, 60 Amp, Type 4X with Non-metallic Enclosure

Standards and Ratings

- UL Listed under file #E4776
- Meets UL98 for switches and UL50 for enclosures
- Meets NEMA Standard KS-1 for enclosed switches (Type HD)
- Meets NEC wire bending space requirements
- Rated 10,000 AIC with Class H Fuses or 200,000 AIC with Class R or J Fuses
- Quick make and break mechanism
- Visible blade double break construction
- Voidable dual cover interlock
- Suitable for use as service equipment
- Non-metallic 4X Enclosure

General Information

Amp Rating	Catalog Number	Shipping Wt (lbs.) (Std Pkg)	Horsepower Ratings ¹							
			3 Phase, 240V AC		3 Phase, 480V AC		3 Phase, 600V AC		HP Rating	
			Std	Max	Std	Max	Std	Max	250V DC	600V DC
240 Volt AC, 250 Volt DC Max Fusible - 3 Pole, 4 Wire										
60	HF322NX	21 (1)	7½	15	—	—	—	—	10	—
600 Volt AC & DC Max Fusible - 3 Pole, 4 Wire										
60	HF362NX	21 (1)	7½	15	15	30	15	50	10	25
60	HF362NXL ²	21 (1)	7½	15	15	30	15	50	10	25
600 Volt AC & DC Max Non-Fusible - 3 Pole, 3 Wire										
60	HNF362X ³	20 (1)	—	20	—	50	—	60	10	25
60	HNF362XL ²	20 (1)	—	20	—	50	—	60	10	25

Accessories

Catalog Number	Description
HN623 ⁴	600 Volt Neutral Kit
HR612	60 Amp, 240 Volt, Class R Fuse Clip Kit
HR62	60A, 600V Class R Fuse Clip Kit
HLC612	Copper Body Lug Kit (#14-6)
HG61234 ⁵	Equipment Ground Kit (2 pc. Wire Range #14-4 AWG Cu/Al)
HA161234	Auxiliary Switch (1-NO & 1 NC)
HA261234	Auxiliary Switch (2-NO & 2 NC)
HA361234	PLC Auxiliary Switch with 1-NO & 1-NC Gold Plated Contacts
SSH075	0.75" Type 4, 4X Hub
SSH100	1.00" Type 4, 4X Hub
SSH125	1.25" Type 4, 4X Hub
SSH150	1.50" Type 4, 4X Hub
HFB22	Replacement Line Base Fusible 240V
HFB62	Replacement Base (Line Side) Fusible 600V
HBB22	Replacement Base (Load Side) 240V
HBB62	Replacement Base Fusible (Load Side) 600V
HBB623	Replacement Base Non-Fusible (Line Side)

¹ Dual horse ratings: Std - applies when non-time delay fuses are installed.

Max - applies when time-delay fuses are installed.

² Line and load lugs are omitted. Provided with mounting hardware for crimp type or copper body lugs.

³ Suitable for use as Service Entrance Equipment. Order and install field addable groundable neutral kit.

⁴ Factory installed as standard on fusible switches.

⁵ Factory installed as standard.

Product Specification Sheet HD60.12

Answers for industry.

SIEMENS

Product Specification Sheet #HD60.12 (page 2 of 2)

Mechanical Lug Wire Ranges (60/75°C, Cu/Al)

Description	Wire Range
Line, Load, Neutral	#14-3 AWG (Cu/Al)
Ground	#14-4 AWG

Compression Lugs¹

Wire Size	Burdny		Thomas-Betts		IlSCO	
	CU Only	CU/AL	CU Only	CU/AL	CU Only	CU/AL
#14-10			256-30695-1352	60097		
#8	YA8C-L1 BOX	YA8CA3	54130	60102		ACL-8
	YA8C-TC14		54930BE	61102		
#6	YA6C-L BOX	YA6CA1	54105	60107	CRB-6	ACL-6
	YA6C		54905BE	61107	CRB-6L	
#4			54106	61112	CRB-4	

¹ If compression lugs are used for the neutral, order compression lug neutral barrier kit HCL623.

Dimension Drawing

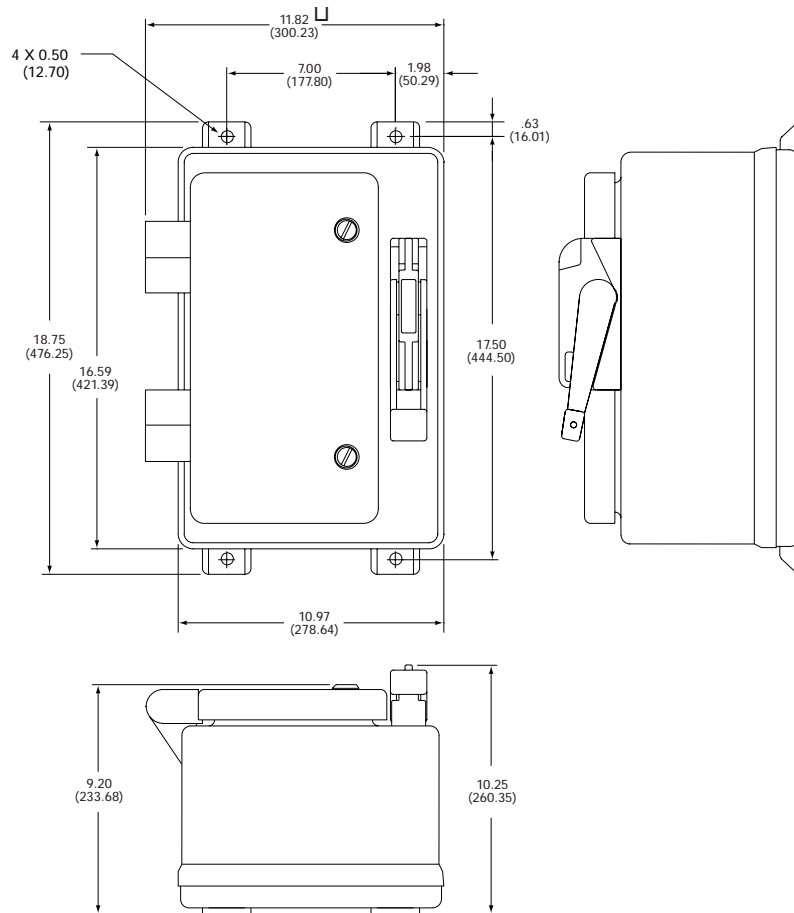

Dimensions shown in inches and millimeters ().
Dimension shown accurate to ± 1/8 inch.

Note: Enclosure is constructed from fiberglass reinforced polyester with non-metallic hinges and cover latches. Finish – gray.