

AS-Interface

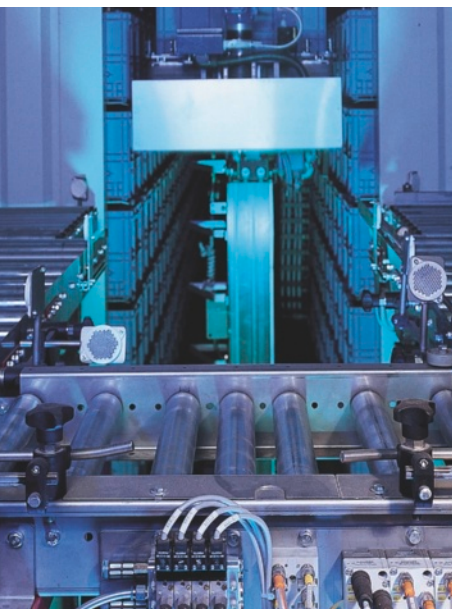

6/2	Introduction	6/68	<u>Special integrated solutions</u>
6/2	System overview	6/68	AS-Interface communication modules
6/4	AS-Interface specification	6/70	<u>Modules with special functions</u>
6/6	ASIsafe	6/70	Counter modules
6/6	Introduction	6/71	Ground-fault detection modules
6/8	AS-Interface safety monitors	6/71	Overvoltage protection module
6/11	AS-Interface safety modules	6/73	AS-Interface connection for LOGO!
6/14	3SF1 position switches	6/74	<u>Contactors and contactor assemblies</u>
6/15	– Plastic enclosures	6/74	SIRIUS 3RT20 contactors
6/17	– Metal enclosures	6/75	SIRIUS 3RA24 contactor assemblies for wye-delta starting
6/21	3SF1 position switches with separate actuator	6/76	SIRIUS 3RA27 function modules for AS-Interface
6/22	– Plastic enclosures	6/78	<u>Motor starters for operation in the control cabinet</u>
6/23	– Metal enclosures	6/78	SIRIUS 3RA6 compact feeders
6/24	– Accessories	6/81	– 3RA61 direct-on-line starter
6/25	3SF1 position switches with solenoid interlocking	6/82	– 3RA62 reversing starter
6/26	– Plastic enclosures	6/83	– Accessories
6/27	– Metal enclosures	6/88	– Add-on modules for AS-Interface
6/28	3SF1 hinge switches	6/90	– Infeed system for 3RA6
6/28	– Plastic enclosures	6/97	<u>Motor starters for operation in the field, high degree of protection</u>
6/29	– Metal enclosures	6/97	SIRIUS M200D motor starters
6/30	3SF2 cable-operated switches for AS-Interface	6/97	– General data
6/31	SIRIUS EMERGENCY-STOP mushroom pushbuttons for AS-Interface	6/98	– M200D motor starters for AS-Interface
6/34	AS-Interface F adapters for EMERGENCY-STOP devices	6/103	– Accessories
6/35	Masters	6/107	SIRIUS MCU motor starters
6/35	<u>Masters for SIMATIC S7</u>	6/107	– General data
6/35	CP 243-2	6/109	– MCU motor starters for AS-Interface
6/36	CP 343-2P, CP 343-2	6/114	Motor starters for AS-Interface, 24 V DC
6/38	Network transitions	6/117	<u>SINAMICS G110D distributed converters</u>
6/38	DP/AS-i LINK Advanced	6/121	<u>3SF5 pushbuttons and indicator lights</u>
6/41	DP/AS-Interface Link 20E	6/121	Enclosures and front panel modules for AS-Interface
6/43	DP/AS-i F-Link	6/121	– General data
6/47	IE/AS-i LINK PN IO	6/122	– With standard fittings
6/50	Slaves	6/123	– Components
6/50	<u>I/O modules for operation in the field, high degree of protection</u>	6/124	– Customized equipment
6/50	Digital I/O modules, IP67 – Introduction	6/125	– Front panel module
6/51	Digital I/O modules, IP67 – K60	6/130	<u>8WD4 signaling columns</u>
6/53	Digital I/O modules, IP68/IP69K – K60R	6/135	Power supply units and data couplings
6/55	Digital I/O modules, IP67 – K45	6/135	AS-Interface power supply units
6/57	Digital I/O modules, IP67 – K20	6/136	S22.5 data decoupling modules
6/59	Digital I/O modules, IP67 – User modules	6/138	Transmission media
6/60	Analog I/O modules, IP67 – K60	6/138	AS-Interface shaped cables
6/63	<u>I/O modules for operation in the control cabinet</u>	6/139	System components and accessories
6/63	Introduction	6/139	Repeater
6/64	SlimLine	6/140	Extension Plug
6/66	F90 module	6/141	Addressing units
6/67	Flat module	6/143	Analyser
		6/146	Other accessories
		6/149	Software
		6/149	AS-Interface Function Block Library for SIMATIC PCS 7

AS-Interface

Introduction

System overview Transmission technology

Overview

AS-Interface is an open, international standard according to EN 50295 and IEC 62026-2 for process and field communication. Leading manufacturers of actuators and sensors all over the world support the AS-Interface. Interested companies are provided with the electrical and mechanical specifications by the AS-Interface Association.

AS-Interface is a single master system. For automation systems from Siemens there are communication processors (CPs) and network transitions (links) which control the process or field communication as masters, and actuators and sensors which are activated as AS-Interface slaves.

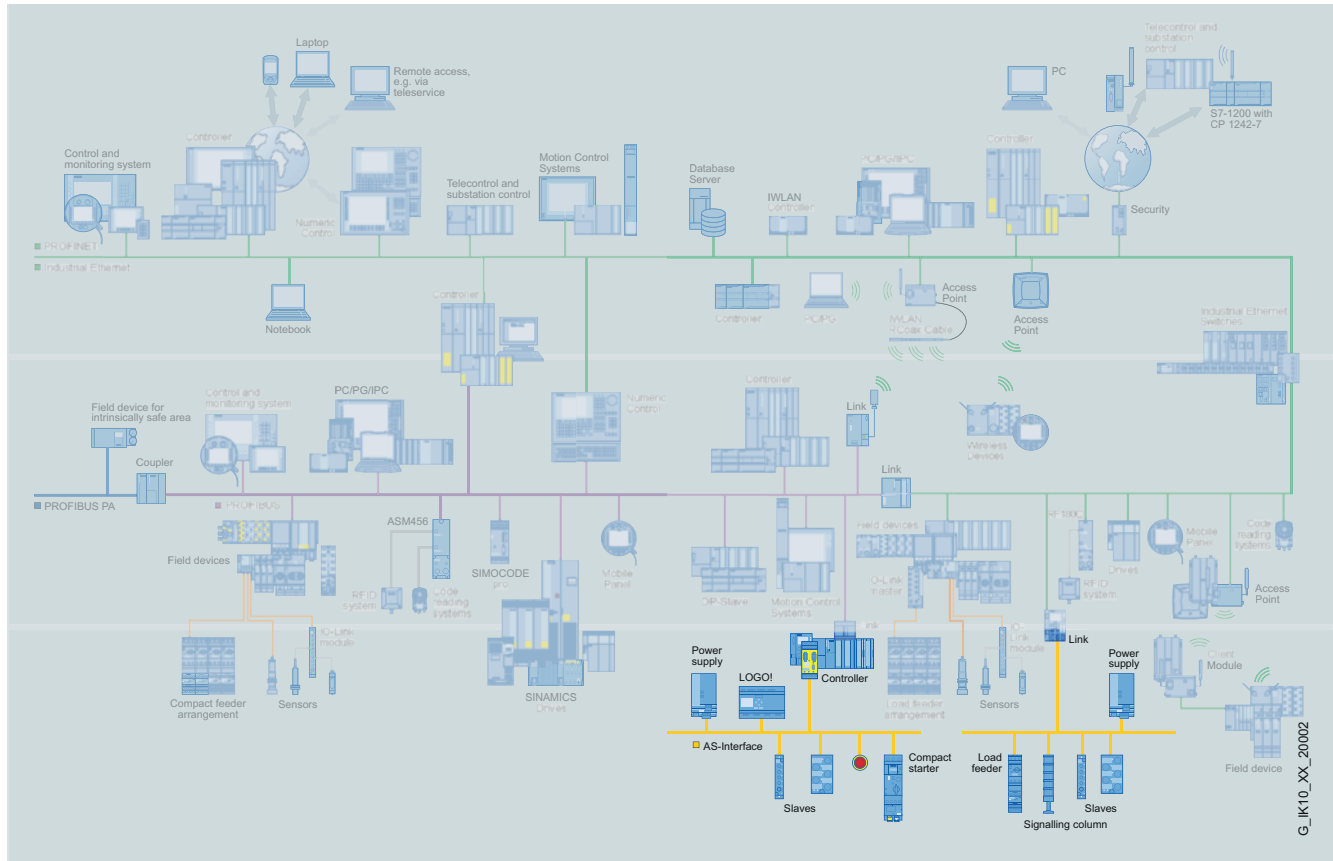

Benefits

get Designed for Industry

A key feature of AS-Interface technology is the use of a shared two-conductor cable for data transmission and the distribution of auxiliary power to the sensors/actuators. A power supply unit which meets the requirements of the AS-Interface transmission method and has an external data decoupling module if required is used for the distribution of auxiliary power. The AS-Interface cable used for the wiring is mechanically coded and hence protected against polarity reversal and can be easily contacted by the insulation piercing method.

Elaborately wired control cables in the control cabinet and marshalling racks can be replaced by AS-Interface.

The AS-Interface cable can be connected to any points thanks to a specially developed cable and connection by the insulation piercing method.

With this concept you become extremely flexible and achieve high savings.

Application

Operating modes

Generally, master interfaces have the following operating modes:

I/O data exchange

In this operating mode the inputs and outputs of the binary AS-Interface slaves are read and written.

Analog value transmission

AS-Interface masters according to the AS-Interface Specification V2.1 or V3.0 support integrated analog value processing. This means that data exchange with analog AS-Interface slaves is just as easy as with digital slaves.

Command interface

In addition to I/O data exchange with binary and analog AS-Interface slaves the AS-Interface masters provide a number of other functions through the command interface.

Hence it is possible, for example, for slave addresses to be issued, parameter values transferred or diagnostics information read out from user programs.

Overview

System components

To implement the communication, a system installation has the following main components:

- Master interface modules for central control units such as SIMATIC S7, ET 200 M distributed peripherals, or network transitions from PROFIBUS/PROFINET to AS-Interface
- Power supply units, if required in combination with a data decoupling module for the power supply to the slaves
- AS-Interface shaped cables
- Network components such as repeaters and extension plugs (cannot be used for AS-i Power24V networks)
- Modules for connection of standard sensors/actuators
- Actuators and sensors with integrated AS-i slave
- Safety modules for transmitting safety-oriented data through AS-Interface
- Addressing units for setting the slave addresses during commissioning

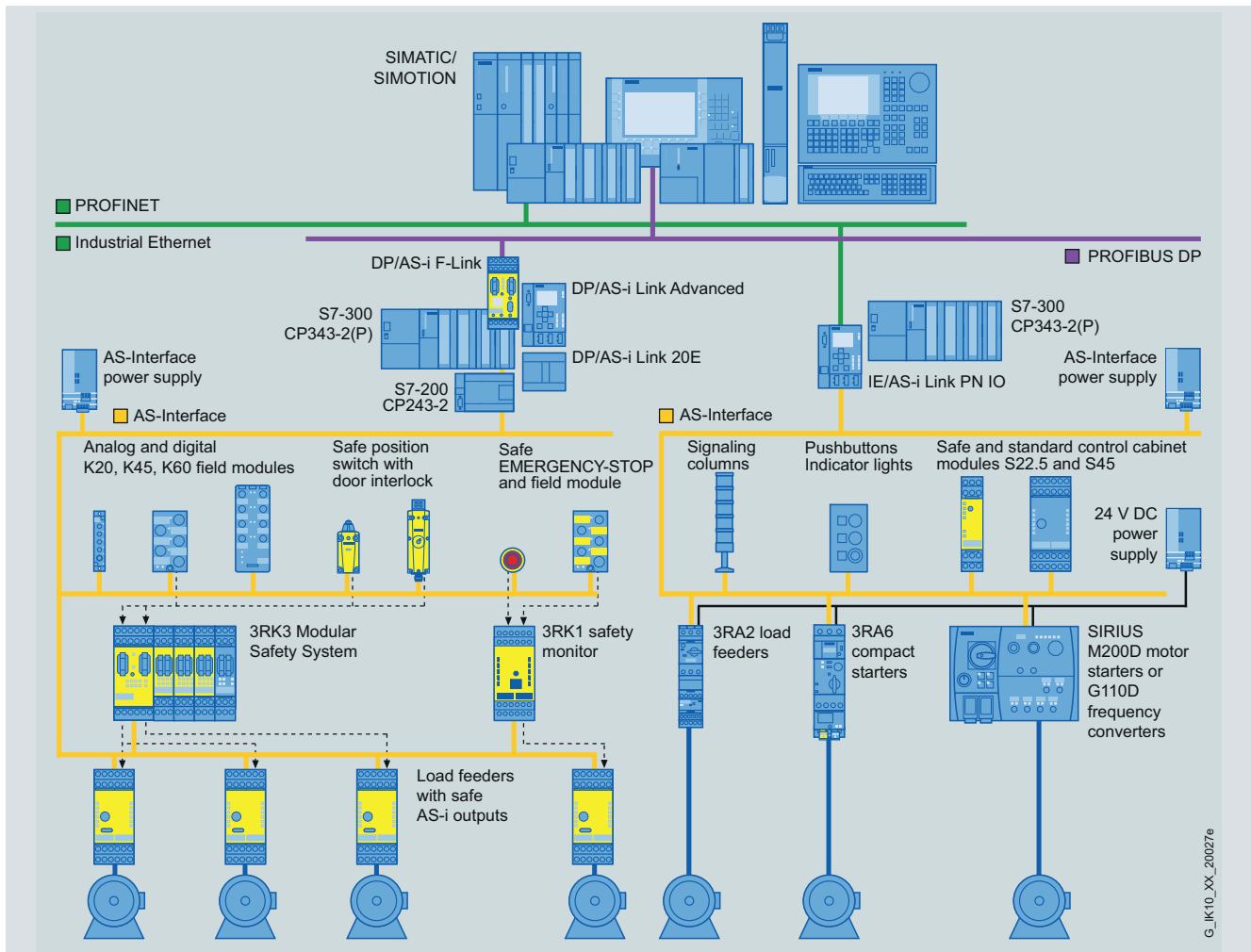

Example of a configuration with the system components

Features

Standard	EN 50295 / IEC 62026-2	Maximum cycle time	5 ms with full expansion using standard addresses, 10 ms with full expansion using A/B addresses, profile-specific for Spec. 3.0 slaves
Topology	Line, star or tree structure (same as electrical wiring)	Number of stations per AS-Interface line	31 slaves acc. to AS-Interface Spec. V2.0; 62 slaves (A/B technology) acc. to AS-Interface Spec. V2.1 and V3.0, integrated analog value transmission
Transmission medium	Unshielded two-conductor cable (2 x 1.5 mm ²) for data and auxiliary power	Number of binary sensors and actuators	Max. 124 DI/124 DO according to Spec. V2.0; max. 248 DI/186 DO according to Spec. V2.1; max. 496 DI/496 DO according to Spec. V3.0
Connection methods	Contacting of the AS-Interface cable by insulation piercing method	Access control	Cyclic polling master slave method, cyclic data transfer by host (PLC, PC)
Maximum cable length	100 m without a repeater 200 m with extension plug 300 m with two repeaters connected in series 600 m with extension plugs and two repeaters connected in parallel Larger cable lengths are possible when additional repeaters are connected in parallel	Error safeguard	Identification and repetition of faulty message frames

AS-Interface

Introduction

AS-Interface specification Specification 2.0, 2.1 and 3.0

Overview

Scope of the AS-Interface specification

AS-Interface specification	Maximum number of slaves			Number of digital inputs DI	Number of digital outputs DO
	Digital	Analog	ASIsafe		
Version 2.0	31	31	31	$31 \times 4 = 124$	$31 \times 4 = 124$
Version 2.1	62	31	31	$62 \times 4 = 248$	$62 \times 3 = 186$
Version 3.0	62	62	31	$62 \times 8 = 496$	$62 \times 8 = 496$

Basic data of AS-Interface Specification 2.0

- AS-Interface Specification 2.0 describes a fieldbus system with an AS-i master and up to 31 AS-i slaves.
- Each AS-i slave has up to 4 digital inputs and 4 digital outputs.
- With full expansion, the complete transmission of all input/output data requires max. 5 ms cycle time.

Expansions of AS-Interface Specification 2.1

AS-Interface Specification 2.1 enables the number of network stations to be doubled from 31 to 62 as follows:

- The standard slaves continue to occupy one AS-i address (1...31).
- Slaves with extended addressing divide an address into an A address (1A...31A) and a B address (1B...31B). Up to 62 A/B slaves can be connected accordingly to one AS-i network.
- Mixed operation of standard slaves and A/B slaves is possible without difficulty. The AS-i master identifies automatically which type of slave is connected. No special adjustments are required of the user.

Another function of the AS-Interface Specification V2.1 is the integrated analog value transmission function. Access to both analog values and digital values is possible without the need for any special function blocks.

Expansions of AS-Interface Specification 3.0

- AS-Interface Specification 3.0 enables the connection of a nearly 1000 digital inputs/outputs (profile S-7.A.A: 8DI/8DO as A/B slave).
- New profiles have also enabled the option of expanded addressing for analog slaves.
- Acceleration of analog value transmission through "Fast Analog Profile".
- Variable use of analog modules: Optional parameterization of resolution (12/14 bit) and 1 and 2-channel capability.
- Asynchronous serial protocol 100 baud or 50 baud, bidirectional.

AS-Interface masters

To be able to operate A/B slaves on an AS-Interface network you must use master modules that meet the minimum requirements of Specification 2.1.

The AS-i masters for S7-300 / ET 200M and all DP/AS-i links and IE/AS-i links comply with AS-Interface Specification 3.0 and support all new and previous slaves.

AS-Interface specification	Available masters
Version 2.1	CP 243-2 (S7-200)
Version 3.0	CP 343-2, 343-2P (S7-300 / ET 200M), DP/AS-i Link Advanced, DP/AS-i F-Link, DP/AS-Interface Link 20E, IE/AS-i Link PN IO

The AS-Interface specification relevant for the respective slave is noted in the Selection and ordering data.

The exact slave profile can be found in the system manual for AS-Interface.

Communication cycle

AS-Interface specification	Maximum cycle time (digital signals)
Version 2.0	5 ms
Version 2.1	5 ms with 31 slaves 10 ms with 62 slaves
Version 3.0	5 ms with 31 slaves 10 ms with 62 slaves, supplementary, up to 20 ms with A/B slaves using 4DI/4DO, up to 40 ms with A/B slaves using 8DI/8DO.

Each address is queried in max. 5 ms cycle time. If two A/B slaves are operated on one basic address (e.g. 12A and 12B), a maximum 10 ms will be required for updating the data of both slaves.

Whether an AS-Interface slave is a standard slave or an A/B slave can be seen in the section "Selection and ordering data" or the system manual for AS-Interface.

All slave types can be mixed and used on a single AS-Interface network.

More information

AS-Interface system manual

More information is available in the AS-Interface system manual.

The German-language AS-Interface System Manual can be downloaded free from the Internet at:

<http://support.automation.siemens.com/WW/view/de/26250840>

The English-language AS-Interface System Manual can be downloaded free from the Internet at:

<http://support.automation.siemens.com/WW/view/en/26250840>

A print version of the AS-Interface System Manual is also available in both English and German, see page 146.

Internet

You can find more information on the Internet at:

<http://support.automation.siemens.com/WW/view/en/10805888/130000>

Overview



Symbol for AS-i Power24V

Parallel wiring often dominates still, particularly in applications with very few I/Os. Although AS-Interface is similarly well suited for small applications, its use is often prevented by the cost of the 30 V AS-Interface power supply unit which is required in addition.

Through the expansion of AS-Interface with AS-i Power24V and the resulting possibility of using existing standard 24 V DC power supply units in AS-i networks, AS-Interface is now also attractive for applications with a very tight budget.

Data and power in standard AS-Interface networks up to now

One of the great advantages of AS-Interface is the ability to convey not only data but also the power needed for the connected slaves and sensors over the same unshielded two-conductor cable. This is owed to the service-proven AS-Interface power supply units which provide integrated data decoupling as well as overload and short-circuit protection and integrated ground fault monitoring.

The new technology

Through the expansion of AS-Interface with AS-i Power24V it is now also possible to use 24 V standard power supply units in AS-i networks. The communication technology of AS-Interface works at the same high level of quality with an operating voltage of both 30 V DC and 24 V DC.

Key data of AS-i Power24V

Number of slaves	Up to 62 standard slaves and up to 31 safe slaves
Topology	Any
Range	Up to 50 m
Components	<ul style="list-style-type: none"> • 24V power supply unit with little residual ripple • AS-i Power24V-capable data decoupling with integrated ground-fault detection • AS-i Power24V-capable masters, slaves and components

Requirements for operation of an AS-i Power24V network

- The maximum range of 50 m must be observed in order to reach slaves and sensors with a sufficient level of voltage (at least 20 V).
- The power supply units must comply with the PELV Standard (Protective Extra Low Voltage) and have a residual ripple of < 250 mVpp. We recommend power supply units from the SITOP range, see Catalog IC 10.
- When used in conjunction with standard 24 V power supply units, each AS-i network requires Power24V-capable data decoupling with adapted ground fault detection.
- For reliable operation of an AS-i network with 24 V voltage it is important that the masters, slaves and other components are approved for AS-i Power24V. AS-i Power24V-capable AS-i components can also be used without restriction in standard 30 V AS-i networks.
- The use of repeaters or extension plugs in AS-i Power24V networks is not permitted.

Benefits

AS-i Power24V networks incur no additional costs for an AS-Interface power supply unit because an already existing 24 V power supply unit can be used. This brings the user several benefits:

- The level of standardization of very small applications can be increased further.
- The additional advantages of a modern communication system in terms of commissioning, maintenance and diagnostics can be fully exploited.

Application

Construction of an AS-i Power24V network

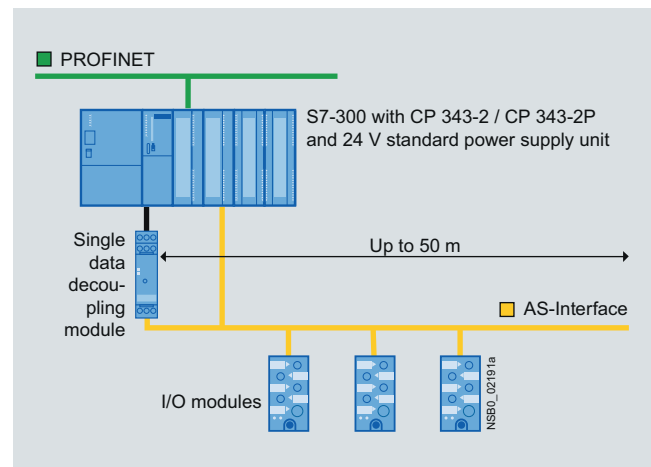

Construction of an AS-i Power24V network with an AS-Interface S22.5 data decoupling module (simple network)

More information

A complete overview of AS-i Power24V-capable units currently available from Siemens can be found at <http://support.automation.siemens.com/WW/view/en/42806066>

Details of AS-i Power24V can be found in the AS-Interface System Manual at <http://support.automation.siemens.com/WW/view/en/26250840>

AS-Interface

ASIsafe

Introduction

Overview

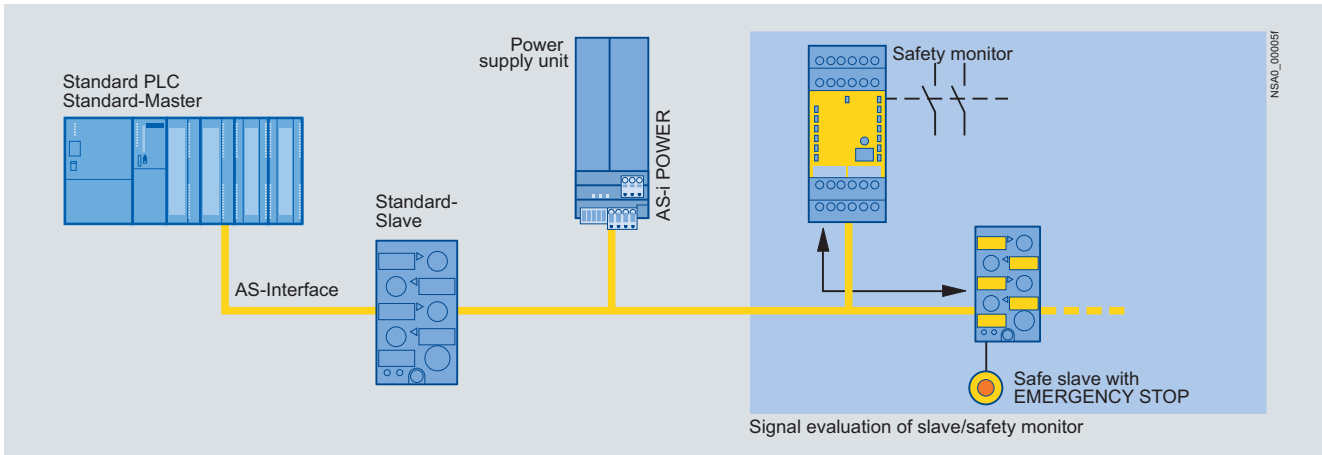

Secure communication and standard communication on AS-Interface

Safety is included

The ASIsafe concept supports the integration of safety-related components, such as EMERGENCY-STOP switches, protective door switches or safety light arrays, in the AS-Interface network. These are fully compatible with the familiar AS-Interface components (masters, slaves, power supplies, repeaters, etc.) in accordance with IEC 62026 and are operated in conjunction with them on the yellow AS-Interface cable.

A failsafe controller or a special master is not required. The master regards safety slaves like all other slaves and receives the safety data solely for information purposes. All existing AS-Interface networks can thus be expanded. ASIsafe makes sure that a maximum response time of 40 ms can be achieved. This is the time between the signal being applied to the input of the safe slave and the output on the safety monitor being switched off. With distributed disconnection through a safe AS-i output, the response time is extended by the time (30 ms) which the safe AS-i output requires in addition to the disconnection to a total of 70 ms (worst case).

Tested safety

The system was tested and approved by TÜV (Germany), NRTL (USA) and INRS (France). The transmission procedure for safety-oriented signals is configured for implementing applications up to Category 4 according to EN 954-1, up to PL e according to EN ISO 13849-1 and up to SIL 3 according to IEC 62061/IEC 61508.

Design

The design of the safety systems is identical to the wiring of AS-Interface as it is known today.

The family of safe AS-Interface products includes the safety monitor which monitors or disconnects the safe stations. The range of safe stations comprises the safety modules and the safety-related sensors with integrated interface. Sensors, monitors and safe AS-i outputs can be connected to any points of the AS-Interface network. Also, several monitors can be used on one network.

6

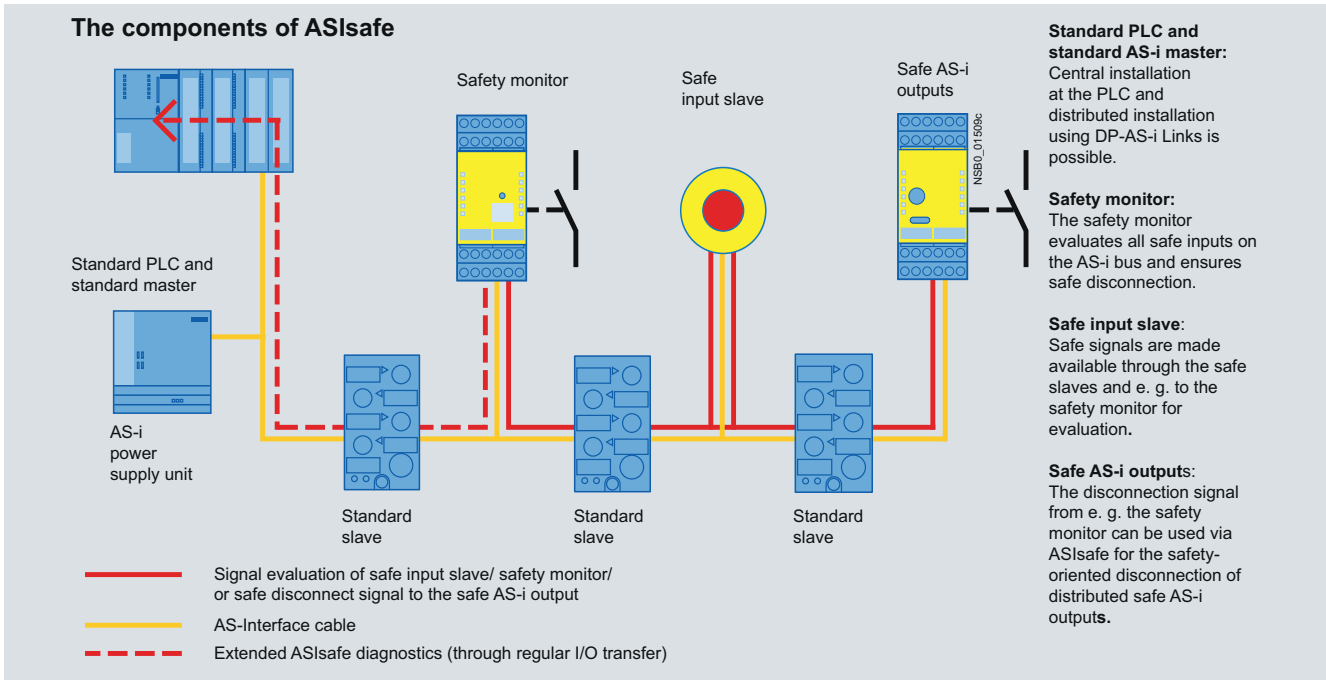

The ASIsafe components and their signal flows

Overview (continued)**Function**

Like the standard stations, the safe stations send their information to the master after master calls.

The safety monitor monitors this transmission from the safe stations to the master and switches to the safe state or sends a disconnect signal to one or more distributed safe AS-i outputs which switch in turn to the safe state.

The safety monitor provides OR logic, AND logic, timer functions, buffer storage, etc.

Software

With the ASIMON configuration software you can configure safety-oriented applications and transfer them into the monitor. The configuration comprises the input signals of the safe stations and the internal functions of the safety monitor.

The software also enables online diagnostics.

Integration

The existing infrastructure such as the master and the power supply unit can be used as before for integrating the safety systems in AS-Interface. For the safety systems the safety monitor is integrated as monitoring element and the safe stations as interface between the safe sensors and the system. The safe sensors can be used as before.

A detailed diagnosis of all parameterized modules of the safety monitor can be obtained using the PLC. The STEP 7 function blocks for the S7-200 and S7-300/400 are available on the internet at

<http://support.automation.siemens.com/WW/view/en/25239870/130000>

In addition an AS-i address should be set for the safety monitor via the configuration software. Evaluation is performed by means of function blocks in the PLC. With the aid of prefabricated WinCC flexible function units this evaluation can be visualized across the system on the existing SIMATIC HMI devices.

The screenshot shows a diagnostics interface titled "Permanent Fenster (Header)". At the top, there is a dropdown menu for "Anwahl ASI Monitor" set to "Monitor 2". Below this, the "Master Status" section displays: "Monitor: Schutzbetrieb, alles ok", "LED Kreis 1: grün, eingeschaltet", and "LED Kreis 2: grün, eingeschaltet".

Two "Device Status" sections are shown, "Kreis 1, Device Status" and "Kreis 2, Device Status". Each contains a 4x4 grid of status indicators for addresses 32-41. In Kreis 1, addresses 35, 36, 38, and 39 are highlighted in green, indicating they are "eingeschaltet". In Kreis 2, all addresses are grey, indicating they are "keine Kommunikation".

A legend at the bottom explains the status indicators:

- Green box: eingeschaltet
- Yellow box: eingeschaltet, Abschalttimer läuft
- Yellow box with 'XX': bereit, warte auf Quittbierung
- Green box with 'XX': Test (aus->ein) erforderlich
- Red box: ausgeschaltet
- Red box with 'XX': Fehler
- Grey box with 'XX': keine Kommunikation
- Blue box with 'XX': Konfigurationsbetrieb
- Grey box with 'XX': unbekannt / nicht benutzt

At the bottom, there are buttons for "AS-I Diagnose" and "Hauptmenü".

Diagnostics interface for ASIsafe components via S7-200 or S7-300

Benefits

- No failsafe PLC or special master is required for the ASIsafe Solution local (safety monitor)
- Alternatively integration in SIMATIC / SINUMERIK safety architectures with the aid of DP/AS-i F-Link (ASIsafe Solution PROFIsafe)
- Simple system structure thanks to standardized AS-Interface technique
- Safety-related and standard data on the same bus
- Existing systems can be expanded quickly and easily
- Optimum integration in TIA (Safety Diagnostics) and Safety Integrated
- Safe signals can be combined in groups
- Inclusion of the safety signals in the plant diagnostics, also on existing HMI panels
- Approved to Category 4 according to EN 954-1 or PL e according to EN ISO 13849-1 or SIL 3 according to IEC 61508
- ASIsafe is certified by TÜV (Germany), NRTL (USA) and INRS (France)

Application

Integrated safety technology in the AS-Interface system is used wherever EMERGENCY-STOP pushbuttons, protective door interlocks, stop Category 0 and 1, two-hand operator controls and light arrays now installed.

More information

More information and circuit examples for safety systems with AS-Interface Safety Monitor and DP/AS-i F-Link can be found on the Internet at

<http://support.automation.siemens.com/WW/view/en/24509484>

AS-Interface

ASIsafe

AS-Interface safety monitors

Overview



Safety monitor with screw terminals (removable terminals)

The safety monitor is the centerpiece of ASIsafe Solution local. It enables safety-orientated responding to signals from the ASIsafe (input) slaves on the same AS-i network and has 1-2 enabling circuits. A safe application is configured using a PC. Various application-specific operating modes can be selected for this. They include, for example, an EMERGENCY-STOP function, door tumbler and selection of stop Category 0 or Category 1.

To be able to make full use of the AS-Interface diagnostics options, the monitor can also be operated with an AS interface address if required. With the aid of the diagnostics module for STEP 7, which is included on the ASIsafe CD, the full diagnostics spectrum can be processed further in the higher-level PLC.

The AS-Interface safety monitor is currently offered in the latest Version 3 (Firmware V3.x) and is available in three expansion levels.

Both basic/expanded expansion levels are available with one or two-channeled configured enabling circuits.

The expanded safety monitor is also available as a version with integrated safe slave which can be used for the control of a safe AS-i output or for safe coupling of a switch signal on another safety monitor or F-Link.

The safety monitor is used in an AS-Interface bus system to monitor protective devices, e. g. protective doors, EMERGENCY-STOP switches, etc.

The safety monitor can be used up to Category 4 according to EN 954-1, to PL e according to EN ISO 13849-1 and to SIL 3 according to IEC 62061/IEC 61508.

Note:

Depending on the choice of safety components used, the complete safety system may also be classified in a lower safety category.

The safety monitor is mounted on the standard mounting rail. Disassembly from the standard mounting rail is quick and easy and requires no tools. With an additional accessory (push-in lugs), the safety monitor can also be screwed on.

Application

The safety monitor acts as a "bus-based safety relay". It provides a user-friendly introduction to safety-orientated communication over fieldbuses thanks to its simple configuration using the graphic PC software ASIMON. The standard infrastructure of the AS-i network (AS-i master under standard PLC, AS-i power supply unit) can still be used without restriction.

The monitor comes in three expansion levels:

- Basic safety monitor with starter set of modules and basic functionality
- Expanded safety monitor with expanded features and functionality
- The expanded safety monitor is also available as a version with integrated safe slave which can be used for the control of a distributed safe AS-i output or for safe coupling of a switch signal on another safety monitor or F-Link.

Basic safety monitor versus expanded safety monitor

	Basic	Expanded
Number of monitoring modules	32	48
Number of OR gates (inputs)	2	6
Number of AND gates (inputs)	--	6
Wildcards for monitoring modules	✓	✓
Deactivating of monitoring modules	✓	✓
Fault release	✓	✓
Diagnostics hold	✓	✓
A/B slaves for acknowledgment	✓	✓
Safe time functions	--	✓
"Button" function	--	✓
Debouncing of contacts	--	✓
Filtering out of brief disconnections	--	✓ (as of Version 3)
Control of safe AS-i output/safe coupling	--	✓ (in version with integrated safe slave)

✓ Available

-- Not available

Number of monitoring modules

The number of devices which the safety monitor can process is increased with the expanded safety monitor from 32 to 48. Applications of greater complexity and size can thus be simulated in the safety monitor.

Logic OR operation

At the logic operation level two elements can be linked by OR operations in the basic version and up to six in the expanded version.

Logic AND operation

In addition to the standard AND operation in the main path of an enabling circuit, an AND operation can also be inserted in an OR operation on the expanded safety monitor. More than two elements can be linked in this AND.

Application (continued)**Features of the basic safety monitor**

- Wildcards and deactivating of monitoring modules
Wildcards are available for the configuration. They are integrated in the configuration and diagnostics and can be easily activated if required. User-friendly configuring is thus possible even when system configurations change.
- Fault release:
If a module detects a fault, the AS-Interface safety monitor goes into fault status. A differentiated fault release (reset) is now possible for this scenario. The fault release can be activated by an AS-Interface standard slave, e. g. a pushbutton, and is effective only on module level. The great advantage of this is that the entire safety monitor is no longer reset but only the module which is locked in the fault.
- Diagnostics hold:
Disconnections can be "frozen" until an acknowledgment comes through a standard slave. This function provides valuable help in the event of short-time causes of disconnection.
- Also from Version 3 upwards:
The standard output data bits of safe input slaves can be processed for acknowledgment, fault release and other non-safety-oriented signals.

Additional features of the expanded safety monitor

The following additional features are provided by only the expanded safety monitor:

- Safe time functions:
Timers with the following functions are available:
 - ON-delay
 - OFF-delay and
 - Pulse
- "Button" function:
Additional acknowledgment option for restarting the system using an additional button. The button function can be assigned to any input or output signal of a standard slave through configuration in the ASIMON software.
- Debouncing of contacts:
For debouncing the contacts it is possible to set a bounce time after which a system restart takes place.
- Also from Version 3 upwards:
Filtering out of brief single-channel interruptions in the sensor circuit. A tolerance time can be set during which the brief opening of a safety-oriented input contact is ignored in order to increase plant availability.

Additional features of the expanded safety monitor with integrated safe slave

This new safety monitor type offers the additional features of the expanded safety monitor plus the following features:

- Filtering out of brief single-channel interruptions in the sensor circuit.
- Actuating a safe distributed actuator (safe output module of e.g. safe valves or motor starters) in parallel to the 2nd enabling circuit.
- Alternatively: Use as a "safe coupler" between two ASIsafe networks. A safe input signal on network 1 can thus act on an enabling circuit of network 2. A detour via a hard-wired safe input module on network 2 is not required in this case.

Configuration software ASIMON V3: New features

- Multi-window system
- Creation of the safety logic in graphic function diagram form, with changeover to former tree presentation possible
- No "preprocessing" of the safety logic
- Management of user-specific modules
- Downward compatibility:
 - Existing ASIMON V2 projects can be loaded
 - Can also be used on all former versions of the safety monitor – with the corresponding scope of functions
- Graphic printout of the safety logic
- Easier system start-up:
 - Teaching the code sequences of safe AS-i Slaves step-by-step
 - Manual input of code sequences also possible in addition
 - Selectable number of simulated slaves
- Simpler diagnostics using AS-Interface through assignment of a diagnostics index to the software function block
- Signaling the switching state of the signaling and relay outputs to higher-level PLCs using a simulated AS-Interface slave
- New functions for filtering out brief interruptions and for controlling a safe AS-i output or for safe coupling of two AS-i networks

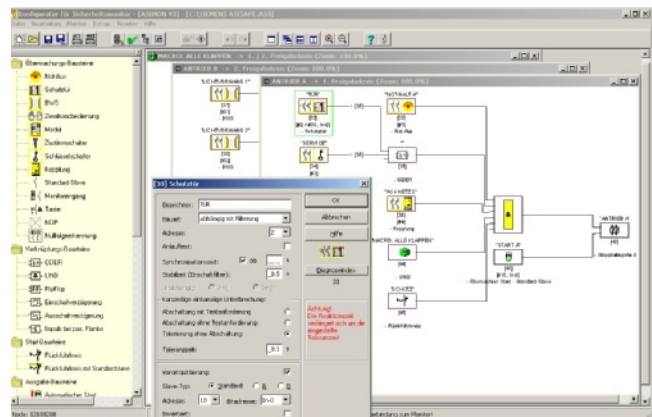



Interface of the configuration software ASIMON V3

AS-Interface

ASIsafe

AS-Interface safety monitors

Selection and ordering data

Version	Order No.	
 <p>3RK1 105-1BE04-0CA0</p>	Basic safety monitors Version 3 With screw terminals, removable terminals, width 45 mm <ul style="list-style-type: none"> • One enabling circuit (monitor type 1) • Two enabling circuits (monitor type 2) 	Screw terminals  3RK1 105-1AE04-0CA0 3RK1 105-1BE04-0CA0
	Expanded safety monitors Version 3 With screw terminals, removable terminals, width 45 mm <ul style="list-style-type: none"> • One enabling circuit (monitor type 3) • Two enabling circuits (monitor type 4) 	3RK1 105-1AE04-2CA0 3RK1 105-1BE04-2CA0
	Expanded safety monitor with integrated safe slave Version 3 With screw terminals, removable terminals, width 45 mm <ul style="list-style-type: none"> • Two enabling circuits including control of a safe AS-i output/ safe coupling (monitor type 6) 	3RK1 105-1BE04-4CA0
	Basic safety monitors Version 3 With spring-type terminals, removable terminals, width 45 mm <ul style="list-style-type: none"> • One enabling circuit (monitor type 1) • Two enabling circuits (monitor type 2) 	Spring-type terminals  3RK1 105-1AG04-0CA0 3RK1 105-1BG04-0CA0
	Expanded safety monitors Version 3 With spring-type terminals, removable terminals, width 45 mm <ul style="list-style-type: none"> • One enabling circuit (monitor type 3) • Two enabling circuits (monitor type 4) 	3RK1 105-1AG04-2CA0 3RK1 105-1BG04-2CA0
	Expanded safety monitor with integrated safe slave Version 3 With spring-type terminals, removable terminals, width 45 mm <ul style="list-style-type: none"> • Two enabling circuits including control of a safe AS-i output/ safe coupling (monitor type 6) 	3RK1 105-1BG04-4CA0

Accessories

 <p>3RK1 901-5AA00</p>	ASIsafe CD Included in the scope of supply: <ul style="list-style-type: none"> • ASIMON V3 configuration software on CD ROM, for PC with the 32-bit operating systems Windows XP, Windows Vista Business / Ultimate, Windows 7 	3RK1 802-2FB06-0GA1
	Cable sets Included in the scope of supply: <ul style="list-style-type: none"> • PC configuration cable for communication between PC (serial interface) and safety monitor, length approx. 1.50 m • Transfer cable between two safety monitors, length approx. 0.25 m 	3RK1 901-5AA00
	USB/serial adapters To connect a serial PC cable (for connection to serial PC interface/ RS 232) to the USB port of a PC, recommended for use in conjunction with AS-i safety monitor	3UF7 946-0AA00-0
	Sealable covers For securing against unauthorized configuration of the safety monitor	3RP1 902
	Push-in lugs For screw fixing	3RP1 903

Overview

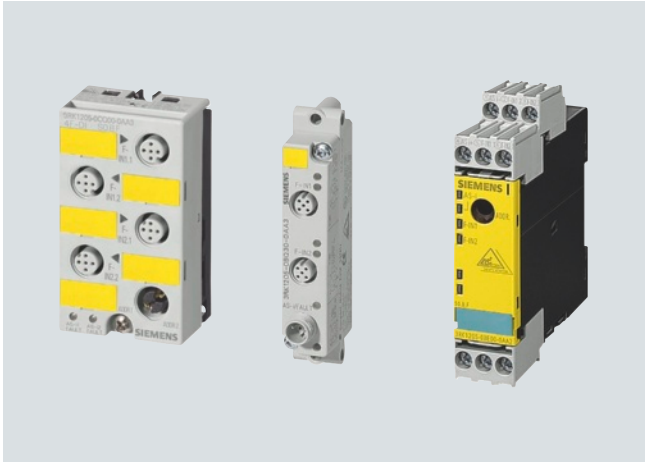

AS-Interface safety modules: K45F (left), K20F (center) and S22.5F (right)



S45F SlimLine module, safe AS-i output

Safety modules for AS-Interface (ASIsafe modules) are available for field use in degree of protection IP67 (K20F and K45F compact modules) and for the control cabinet (S22.5F SlimLine modules) in degree of protection IP20.

A very compact module with an optimum price /performance ratio is thus available for very application.

All modules for the connection of (mechanical) switches and safety sensors with contacts feature crossover monitoring of the connected sensor lead. On versions for the connection of solid-state switches and safety sensors (e. g. light arrays) the crossover monitoring must be performed by the sensor.

Following modules are available for selection:

K20F compact safety modules for operation in the field

Being only 20 mm wide, the K20F module is particularly well suited for applications where modules need to be arranged in an extremely confined space. The K20F modules are connected to the AS-Interface with a round cable with M12 cable box instead of with the AS-Interface flat cable. This enables extremely compact installation. The flexibility of the round cable means that it can also be used on moving machine parts without any problems. The K20 modules are also ideal for such applications as their non-encapsulated design makes them particularly light in weight.

K45F compact safety modules for operation in the field

The platform of the K45F modules covers the following variations:

- Connection of ("mechanical") switches/safety sensors with contacts:
 - K45F 2F-DI: Two safety-oriented inputs in operation up to Category 2 according to EN ISO 13849-1. If Category 4 is required, a two-channel input is available on the module.
 - K45F 2F-DI/2DO: There are also two standard outputs in addition to the safe inputs. Supplied from the yellow AS-i cable
 - K45F 2F-DI/2DO U_{aux} : same as K45F 2F-DI/2DO, but supplied from the black 24 V DC cable
 - K45F 4F-DI: four safety-oriented inputs in operation up to Category 2, two for Category 4. Extremely compact double slave (uses two full AS-i addresses).
 - Connection of solid-state switches/safety sensors (non-contact protective devices, BWS):
 - K45F LS (light sensor): Safe input module for the connection of electronic safety sensors with testing semiconductor outputs (OSSD)
- In particular non-contact protective devices (BWS) such as active, optoelectronic light arrays and light curtains for Type 2 and Type 4 according to IEC/EN 61496 Transmitters as well as receivers are supplied with power from the yellow AS-i cable. Matching sensor cables and optionally a separate transmitter supply module are available as accessories.

S22.5F SlimLine safety modules for operation in control cabinets and local control cabinets

The S22.5F SlimLine safety module has two safety inputs. The safe connection of signals to ASIsafe networks in the control cabinet is also possible therefore.

For operation up to Category 2, both inputs can be assigned separately; if Category 4 is required, a two-channel input is available on the module.

In addition there are two S22.5F module versions which have two standard outputs in addition to the two safety inputs; power is supplied either from only the yellow AS-Interface cable or as auxiliary voltage from the black 24 V DC cable.

S45F SlimLine safety modules with safe outputs for the safe distributed disconnection of actuators

With the safe SlimLine-Module S45F, the shutdown signal, for example from the safety monitor, can be used through the ASIsafe for distributed safety-oriented deactivation.

To this end, the module has a dual-channel relay output with which an enabling circuit up to safety category 4 and Performance Level e according to EN ISO 13849-1 and SIL 3 according to EN 62061 / IEC 61508 can be deactivated safely. The response time for the entire system (safety monitor, S45F module, etc.) from the moment of the disconnect request to the actual disconnection is max. 70 ms.

As an additional possibility the module offers normal switching of the output using an AS-i standard output bit.









The module has 3 digital inputs and 2 digital outputs for the additional connection of sensors and actuators. These can be used, inter alia, for the necessary monitoring of the downstream contactors of the feedback circuit.

AS-Interface

ASIsafe

AS-Interface safety modules





Selection and ordering data

Version			Order No.	
	K20F compact safety modules			
	I/O type	U_{aux} 24 V		
	2 F-DI	--	3RK1 205-0BQ30-0AA3	
	K45F compact safety modules			
	Modules supplied without mounting plate			
	I/O type	U_{aux} 24 V		
	2 F-DI	--	3RK1 205-0BQ00-0AA3	
	4 F-DI	--	3RK1 205-0CQ00-0AA3	
	2 F-DI/2 DO	--	3RK1 405-0BQ20-0AA3	
	2 F-DI/2 DO	✓	3RK1 405-1BQ20-0AA3	
	2 F-DI LS type 2 ¹⁾	--	3RK1 205-0BQ21-0AA3	
2 F-DI LS type 4 ²⁾	--	3RK1 205-0BQ24-0AA3		
	S22.5F SlimLine safety modules			
	Connection	I/O type	U_{aux} 24 V	
	Screw		2 F-DI	--
			2 F-DI/2 DO	--
			2 F-DI/2 DO	✓
	Spring		2 F-DI	--
			2 F-DI/2 DO	--
			2 F-DI/2 DO	✓
		S45F SlimLine safety modules		
Connection		I/O type	U_{aux} 24 V	
Screw			1F-RO/3DI/2DO	✓
			1F-RO/3DI/2DO	✓
Spring			1F-RO/3DI/2DO	✓

¹⁾ Connection of Siemens light curtain FS 400 3RG7843 (type 2) through socket 1/3

²⁾ Connection of Siemens light curtain FS 400 3RG7846 (type 4) through socket 1/3, other makes through socket 2/3

Accessories

	Version	Order No.
 3RK1 901-2EA00	K45 mounting plates For mounting K45F <ul style="list-style-type: none"> • For wall mounting • For standard rail mounting 	3RK1 901-2EA00 3RK1 901-2DA00
	24 V supply modules for K45F LS (light sensor) <ul style="list-style-type: none"> • optional, for transmitter power supply for large protective field widths • Modules supplied without mounting plate 	3RK1 901-1NP00
 3RK1 901-1AA00	Input bridges for K45F <ul style="list-style-type: none"> • Black version • Red version 	3RK1 901-1AA00 3RK1 901-1AA01
 3RK1 901-1KA00	AS-Interface sealing caps M12 For free M12 sockets	3RK1 901-1KA00
 3RK1 901-1KA01	AS-Interface sealing caps M12, tamper-proof For free M12 sockets	3RK1 901-1KA01

AS-Interface

ASIsafe

3SF1 position switches

Overview

The 3SF1 position switches with safety-oriented communication can be directly connected using the AS-Interface bus system. The safety functions no longer have to be conventionally wired up.

With the 3SF1 position switches the ASIsafe electronics are integrated in the switch enclosure.



Examples of selection options in the modular system

Modular system

The 3SF1 1.4 and 3SF1 2.4 position switches are built as a modular system, which consists of the basic switch in different versions and a drive, which must be ordered separately. Thanks to the modular design of the switch the end user can select the right solution for his application from numerous versions and install it himself in a very short time.

Design

The 3SF1 switches are available in four different enclosure sizes:

- Plastic and metal enclosures according to EN 50047, 31 mm wide, with M12 plug
- Metal enclosures according to EN 50041, 40 mm wide, with M12 plug
- Plastic enclosures, 50 mm wide, with M12 plug and M12 socket
- Metal enclosures, 56 mm wide, with M12 plug and M12 socket

Display

The switches have a status display with three LEDs:

- LED 1 (yellow): F-IN1
- LED 2 (yellow): F-IN2
- LED 3 (green/red): AS-i/FAULT

Connection

Connection to the AS-Interface is connected to the yellow AS-Interface bus cable by means of a 4-pole M12 plug (plastic version).

The wide enclosures (50 or 56 mm) also have an M12 socket for connecting a second position switch. Category 4 according to EN 954-1 is thus achieved.

Benefits

The new generation of 3SF1 position switches offers:

- ASIsafe Electronics integrated in the enclosure, with low power consumption < 60 mA
- An extensive range of actuators
- Status display with three LEDs

Operating conditions

With the standard position switches, mechanical positions of moved machine parts are converted into electrical signals. Through their modular and uniform design and large number of versions, the devices can meet practically all requirements in industry.

Devices are available with enclosure versions to suit the particular ambient conditions. Different control tasks can be performed with the best contact blocks suited for the particular purpose. And many different actuator versions are available to match the mechanical configuration of the moved machined parts. Dimensions, fixing points and characteristics are largely in accordance with the EN 50041 or EN 50047 standards.

The devices are suitable for use in any climate.

Standards

The switches comply with the standards IEC 60947-1 (Low-Voltage Switchgear and Controlgear, General) and IEC 60947-5-1 (Electromechanical Control Circuit Devices).

The mechanical design of the switch corresponds to the requirements of the failsafe principle according to EN 1088.

Approvals

AS-Interface according to EN 50295 and IEC 62026-2.

With a 3SF1 position switch it is possible to achieve category 2 according to ISO 13849-1 (EN 954-1) or SIL 1 according to IEC 61508.

Categories 3 or 4 according to ISO 13849-1 (EN 954-1) or SIL 2 or 3 according to IEC 61508 can be achieved by using a second 3SE5 position switch.

The 3SF1 position switches are approved according to UL 508, UL 50 and UL 746-C.

Selection and ordering data

Modular system

For the ASIsafe version of the position switch, the basic switch and actuator must be ordered separately.

1 or 2 contacts · 3 LEDs · Degree of protection IP65 (31 mm) or IP66/IP67 (50 mm) · M12 plug

Version	Contacts	LEDs	Order No.	
<i>Basic switches (with rounded plunger¹⁾) · Enclosure width 31 mm according to EN 50047</i>				
 <p>ASIsafe basic switch</p>	With teflon plunger, with M12 plug, 4-pole; channel 1 on NC contact, channel 2 on NC contact			
	<ul style="list-style-type: none"> • Slow-action contacts 	2 NC		24 V DC
	<ul style="list-style-type: none"> • Snap-action contacts 	2 NC	24 V DC	⊕ 3SF1 234-1LC05-1BA1

Basic switches (with rounded plunger¹⁾) · Enclosure width 50 mm

 <p>ASIsafe basic switch</p>	With teflon plunger, with M12 plug, 4-pole, channel 1 on NC contact, channel 2 on M12 socket, right			
	<ul style="list-style-type: none"> • Slow-action contacts 	1 NC		24 V DC
	<ul style="list-style-type: none"> • Snap-action contacts 	1 NC	24 V DC	⊕ 3SF1 244-1LC05-1BA2

⊕ Positive opening according to IEC 60947-5-1, Appendix K, or positive drive for use in safety circuits.





¹⁾ For enclosures with widths of 31mm and 50mm, the basic switch is a complete unit with rounded plungers.

AS-Interface

ASIsafe

3SF1 position switches Plastic enclosures

Selection and ordering data (continued)

	Version	Diameter mm	Order No.
<i>Operating mechanisms</i>			
 Roller plungers	Roller plunger, type C according to EN 50047		
	<ul style="list-style-type: none"> • Plastic rollers • High-grade steel rollers 	10 10	<ul style="list-style-type: none"> ➔ 3SE5 000-0AD03 ➔ 3SE5 000-0AD04
 With central fixing	Roller plungers with central fixing		
	<ul style="list-style-type: none"> • Plastic rollers • High-grade steel rollers 	10 10	<ul style="list-style-type: none"> ➔ 3SE5 000-0AD10 ➔ 3SE5 000-0AD11
 Roller levers	Roller lever, type E according to EN 50047		
	<ul style="list-style-type: none"> • Metal lever, plastic roller • Metal lever, high-grade steel roller • High-grade steel lever, plastic roller • High-grade steel lever, high-grade steel roller 	13 13 13 13	<ul style="list-style-type: none"> ➔ 3SE5 000-0AE10 ➔ 3SE5 000-0AE11 ➔ 3SE5 000-0AE12 ➔ 3SE5 000-0AE13
	Angular roller levers		
	<ul style="list-style-type: none"> • Metal lever, plastic roller • Metal lever, high-grade steel roller • High-grade steel lever, plastic roller • High-grade steel lever, high-grade steel roller 	13 13 13 13	<ul style="list-style-type: none"> ➔ 3SE5 000-0AF10 ➔ 3SE5 000-0AF11 ➔ 3SE5 000-0AF12 ➔ 3SE5 000-0AF13
 Twist actuator	Twist actuator, plastic (without lever) switching right or left, adjustable		➔ 3SE5 000-0AK00
	Levers for twist actuators		
	Twist lever, type A acc. to EN 50047		
	<ul style="list-style-type: none"> • Metal lever, plastic roller • Metal lever, high-grade steel roller • Metal lever, roller with ball bearing • Metal lever, plastic roller • High-grade steel lever, plastic roller • High-grade steel lever, high-grade steel roller 	19 19 19 30 19 19	<ul style="list-style-type: none"> ➔ 3SE5 000-0AA21 ➔ 3SE5 000-0AA22 ➔ 3SE5 000-0AA23 ➔ 3SE5 000-0AA25 ➔ 3SE5 000-0AA31 ➔ 3SE5 000-0AA32
	Twist lever, length 30 mm, straight¹⁾		
	<ul style="list-style-type: none"> • Metal lever, plastic roller • Metal lever, plastic roller 	19 30	<ul style="list-style-type: none"> ➔ 3SE5 000-0AA24 ➔ 3SE5 000-0AA26
	Twist lever, adjustable length, with grid hole		
<ul style="list-style-type: none"> • Metal lever, plastic roller • Metal lever, high-grade steel roller • Metal lever, plastic roller • Metal lever, rubber roller • High-grade steel lever, plastic roller • High-grade steel lever, high-grade steel roller 	19 19 50 50 19 19	<ul style="list-style-type: none"> ➔ 3SE5 000-0AA60 ➔ 3SE5 000-0AA61 ➔ 3SE5 000-0AA67 ➔ 3SE5 000-0AA68 ➔ 3SE5 000-0AA62 ➔ 3SE5 000-0AA63 	
 Twist lever, adjustable length			

➔ Positive drive, for use in safety circuits.

¹⁾ Can be clinch mounted (turned through 180°, rear of lever).

Selection and ordering data**Modular system**

For the ASIsafe version of the position switch, the basic switch and actuator must be ordered separately.

2 contacts · 3 LEDs · Degree of protection IP66/IP67 · M12 plug

Version	Contacts	LEDs	Order No.	
<i>Basic switches (with rounded plunger¹⁾ · Enclosure width 31 mm according to EN 50047</i>				
 <p>ASIsafe basic switch</p>	With teflon plunger, with M12 plug, 4-pole; channel 1 on NC contact, channel 2 on NC contact			
	• Slow-action contacts	2 NC	24 V DC →	3SF1 214-1KC05-1BA1
	• Snap-action contacts	2 NC	24 V DC →	3SF1 214-1LC05-1BA1

ASIsafe basic switch

→ Positive opening according to IEC 60947-5-1, Appendix K, or positive drive for use in safety circuits.









¹⁾ For enclosures with widths of 31mm, the basic switch is a complete unit with rounded plungers.

AS-Interface

ASIsafe

3SF1 position switches Metal enclosures

Selection and ordering data (continued)

	Version	Diameter mm	Order No.
<i>Operating mechanisms</i>			
 Plain plungers	Plain plungers • High-grade steel plungers	10	⊕ 3SE5 000-0AB01
 Roller plungers	Roller plunger, type C according to EN 50047 • Plastic rollers	10	⊕ 3SE5 000-0AD03
	• High-grade steel rollers	10	⊕ 3SE5 000-0AD04
 With central fixing	Roller plungers with central fixing • Plastic rollers	10	⊕ 3SE5 000-0AD10
	• High-grade steel rollers	10	⊕ 3SE5 000-0AD11
 Roller levers	Roller lever, type E according to EN 50047 • Metal lever, plastic roller	13	⊕ 3SE5 000-0AE10
	• Metal lever, high-grade steel roller	13	⊕ 3SE5 000-0AE11
	• High-grade steel lever, plastic roller	13	⊕ 3SE5 000-0AE12
	• High-grade steel lever, high-grade steel roller	13	⊕ 3SE5 000-0AE13
 Angular roller levers	Angular roller levers • Metal lever, plastic roller	13	⊕ 3SE5 000-0AF10
	• Metal lever, high-grade steel roller	13	⊕ 3SE5 000-0AF11
	• High-grade steel lever, plastic roller	13	⊕ 3SE5 000-0AF12
	• High-grade steel lever, high-grade steel roller	13	⊕ 3SE5 000-0AF13
<i>Twist actuators with lever</i>			
 Twist actuator	Twist actuator, plastic (without lever) switching right or left, adjustable		⊕ 3SE5 000-0AK00
 Twist levers	Levers for twist actuators Twist lever, type A acc. to EN 50047 • Metal lever, plastic roller	19	⊕ 3SE5 000-0AA21
	• Metal lever, high-grade steel roller	19	⊕ 3SE5 000-0AA22
	• Metal lever, roller with ball bearing	19	⊕ 3SE5 000-0AA23
	• Metal lever, plastic roller	30	⊕ 3SE5 000-0AA25
	• High-grade steel lever, plastic roller	19	⊕ 3SE5 000-0AA31
	• High-grade steel lever, high-grade steel roller	19	⊕ 3SE5 000-0AA32
	Twist lever, length 30 mm, straight ¹⁾ • Metal lever, plastic roller	19	⊕ 3SE5 000-0AA24
• Metal lever, plastic roller	30	⊕ 3SE5 000-0AA26	
 Twist lever, adjustable length	Twist lever, adjustable length, with grid hole • Metal lever, plastic roller	19	⊕ 3SE5 000-0AA60
	• Metal lever, high-grade steel roller	19	⊕ 3SE5 000-0AA61
	• Metal lever, plastic roller	50	⊕ 3SE5 000-0AA67
	• Metal lever, rubber roller	50	⊕ 3SE5 000-0AA68
	• High-grade steel lever, plastic roller	19	⊕ 3SE5 000-0AA62
	• High-grade steel lever, high-grade steel roller	19	⊕ 3SE5 000-0AA63

⊕ Positive drive, for use in safety circuits.

¹⁾ Can be clinch mounted (turned through 180°, rear of lever).

Selection and ordering data (continued)**Modular system**

For the ASIsafe version of the position switch, the basic switch and actuator must be ordered separately.

1 or 2 contacts · 3 LEDs · Degree of protection IP66/IP67 · M12 plug

	Version	Contacts	LEDs	Order No.
Basic switches · Enclosure width 40 mm acc. to EN 50041				
	With M12 plug, 4-pole, channel 1 on NC contact, channel 2 on NC contact			
	<ul style="list-style-type: none"> • Slow-action contacts • Snap-action contacts 	2 NC 2 NC	24 V DC 24 V DC	⊕ ⊕
				3SF1 114-1KA00-1BA1 3SF1 114-1LA00-1BA1





ASIsafe basic switch

Basic switches · Enclosure width 56 mm

	With M12 plug, 4-pole, channel 1 on NC contact, channel 2 on M12 socket, right			
	<ul style="list-style-type: none"> • Slow-action contacts • Snap-action contacts 	1 NC 1 NC	24 V DC 24 V DC	⊕ ⊕
				3SF1 124-1KA00-1BA2 3SF1 124-1LA00-1BA2

ASIsafe basic switch

⊕ Positive opening according to IEC 60947-5-1, Appendix K, or positive drive for use in safety circuits.

	Version	Diameter mm	Order No.
Operating mechanisms			
	Plain plungers		
	High-grade steel plungers		⊕ 3SE5 000-0AB01
	Rounded plungers, type B, acc. to EN 50041		
	High-grade steel plungers		⊕ 3SE5 000-0AC02
	Roller plungers, type C acc. to EN 50041		
	High-grade steel rollers	13	⊕ 3SE5 000-0AD02
	Roller levers		
	• Metal lever, plastic roller	22	⊕ 3SE5 000-0AE01
	• Metal lever, high-grade steel roller	22	⊕ 3SE5 000-0AE02
	• High-grade steel lever, plastic roller	22	⊕ 3SE5 000-0AE03
	Angular roller levers		
	• Metal lever, plastic roller	22	⊕ 3SE5 000-0AF01
	• Metal lever, high-grade steel roller	22	⊕ 3SE5 000-0AF02
	• High-grade steel lever, plastic roller	22	⊕ 3SE5 000-0AF03
	• High-grade steel lever, high-grade steel roller	22	⊕ 3SE5 000-0AF04





⊕ Positive drive, for use in safety circuits.

AS-Interface

ASIsafe

3SF1 position switches Metal enclosures

Selection and ordering data (continued)

Version	Diameter mm	Order No.	
<i>Twist actuators with lever</i>			
 Twist actuator	Twist actuator , metal (without lever)		
	<ul style="list-style-type: none"> • Switching right or left, adjustable • For fork levers, latching 	<ul style="list-style-type: none"> ➞ 3SE5 000-0AAH00 ➞ 3SE5 000-0AT10 	
Levers for twist actuators			
 Twist levers	Twist levers 27 mm, type A, according to EN 50041		
	• Metal lever, plastic roller	19	➞ 3SE5 000-0AA01
	• Metal lever, high-grade steel roller	19	➞ 3SE5 000-0AA02
	• Metal lever, roller with ball bearing	19	➞ 3SE5 000-0AA03
	• Metal lever, 2 plastic rollers	19	➞ 3SE5 000-0AA04
	• Metal lever, plastic roller	30	➞ 3SE5 000-0AA05
	• Metal lever, plastic roller	50	➞ 3SE5 000-0AA07
	• Metal levers, rubber roller	50	➞ 3SE5 000-0AA08
	• High-grade steel lever, plastic roller	19	➞ 3SE5 000-0AA11
	• High-grade steel lever, high-grade steel roller	19	➞ 3SE5 000-0AA12
Twist lever, length 35 mm, cranked			
• Metal lever, plastic roller	19	➞ 3SE5 000-0AA15	
Twist lever, length 30 mm, straight ¹⁾			
• Metal lever, plastic roller	19	➞ 3SE5 000-0AA24	
• Metal lever, plastic roller	30	➞ 3SE5 000-0AA26	
Twist lever, adjustable length, with grid hole			
 Twist lever, adjustable length	• Metal lever, plastic roller	19	➞ 3SE5 000-0AA60
	• Metal lever, high-grade steel roller	19	➞ 3SE5 000-0AA61
	• Metal lever, plastic roller	50	➞ 3SE5 000-0AA67
	• Metal lever, rubber roller	50	➞ 3SE5 000-0AA68
	• High-grade steel lever, plastic roller	19	➞ 3SE5 000-0AA62
• High-grade steel lever, high-grade steel roller	19	➞ 3SE5 000-0AA63	
Fork lever (for switches with snap-action contacts only)			
 Fork lever	• 2 metal levers, 2 plastic rollers	19	➞ 3SE5 000-0AT01
	• 2 metal levers, 2 high-grade steel rollers	19	➞ 3SE5 000-0AT02
	• 2 high-grade steel levers, 2 plastic rollers	19	➞ 3SE5 000-0AT03
	• 2 high-grade steel levers, 2 high-grade steel rollers	19	➞ 3SE5 000-0AT04

➞ Positive drive, for use in safety circuits.

¹⁾ Can be clinch mounted (turned through 180°, rear of lever).

Overview

The 3SF1 position switches with safety-oriented communication can be directly connected using the AS-Interface bus system. The safety functions no longer have to be conventionally wired up.

With the 3SF1 position switches the ASIsafe electronics are integrated in the switch enclosure.



3SF1 position switches with separate actuator and with integrated ASIsafe electronics

3SF1 position switches with separate actuator have the same enclosures as the standard switches.

Operation

The actuator head is included in the scope of supply. For actuation from four directions it can be adjusted through $4 \times 90^\circ$. The switches can also be approached from above.

The actuators are not included in the scope of supply of the position switch and must be ordered separately from a choice of six versions to suit the application.

The actuator is encoded. Simple overruling by hand or auxiliary devices is impossible.

A high-grade steel blocking insert for attaching up to eight padlocks is available for even more safety.

A rubber cap to protect the metal enclosure from contamination is available for operation in dusty environments.

Display

The switches have a status display with three LEDs:

- LED 1 (yellow): F-IN1
- LED 2 (yellow): F-IN2
- LED 3 (green/red): AS-i/FAULT

Connection

Connection to the AS-Interface is by means of a 4-pole M12 plug (plastic version) connected to the yellow AS-Interface bus cable.

The wide enclosures (50 or 56 mm) also have an M12 socket for connecting a second position switch. Category 4 according to EN 954-1 is thus achieved.

Benefits

The new generation of 3SF1 position switches with separate actuator offers:

- ASIsafe Electronics integrated in the enclosure, with low power consumption $< 60 \text{ mA}$
- An extensive range of actuators
- Status display with three LEDs

Operating conditions

Position switches with separate actuator are used where the position of doors, covers or protective grills must be monitored for safety reasons.

The position switch can only be operated with the matching coded actuator. Simple overruling by hand or auxiliary devices is impossible.

Devices are available with enclosure versions to suit the particular ambient conditions. Different control tasks can be performed with the best contact blocks suited for the particular purpose. Dimensions, fixing points of the enclosure are in accordance with EN 50041 or EN 50047 standards.

The devices are suitable for use in any climate.

Standards

The switches comply with the standards IEC 60947-1 (Low-Voltage Switchgear and Controlgear, General) and IEC 60947-5-1 (Electromechanical Control Circuit Devices).

The mechanical design of the switch corresponds to the requirements of the failsafe principle according to EN 1088.

Approvals

AS-Interface according to EN 50295 and IEC 62026-2.

Category 3 acc. to ISO 13849-1 (EN 954-1) or SIL 2 acc. to IEC 61508 can be attained using a 3SF1 position switch.

Category 4 according to ISO 13849-1 (EN 954-1) or SIL 3 according to IEC 61508 can be achieved by using a second 3SE5 position switch.

The 3SF1 position switches are approved according to UL 508, UL 50 and UL 746-C.

AS-Interface



ASIsafe

3SF1 position switches with separate actuator Plastic enclosures

Overview

- Contacts: 1 or 2 slow-action contacts
- Status display with 3 LEDs 24 V DC;
1: F-IN1, 2: F-IN2, 3: AS-I/FAULT
- Degree of protection IP65 (31 mm) or IP66/IP67 (50 mm)

Selection and ordering data

	Version ¹⁾	Contacts	Order No.
<i>Enclosure width 31 mm according to EN 50047</i>			
	5 directions of approach M12 plug, 4-pole; channel 1 on NC contact, channel 2 on NC contact Slow-action contacts	2 NC	➔ 3SF1 234-1QV40-1BA1
<i>Enclosure width 50 mm</i>			
	5 directions of approach M12 plug, 4-pole; channel 1 on NC, channel 2 on M12 socket, right Slow-action contacts	1 NC	➔ 3SF1 244-1QV40-1BA2

ASIsafe

ASIsafe



➔ Positive opening according to IEC 60947-5-1, Appendix K.

¹⁾ Supplied without actuator. Please order separately.

Overview

- Contacts: 1 or 2 slow-action contacts
- Status display with 3 LEDs 24 V DC;
1: F-IN1, 2: F-IN2, 3: AS-I/FAULT
- Degree of protection IP66/IP67

Selection and ordering data

	Version ¹⁾	Contacts	Order No.
<i>Enclosure width 31 mm according to EN 50047</i>			
	5 directions of approach M12 plug, 4-pole; channel 1 on NC contact, channel 2 on NC contact Slow-action contacts	2 NC	➔ 3SF1 214-1QV40-1BA1
<i>Enclosure width 40 mm according to EN 50041</i>			
	5 directions of approach M12 plug, 4-pole; channel 1 on NC contact, channel 2 on NC contact Slow-action contacts	2 NC	➔ 3SF1 114-1QV10-1BA1
<i>Enclosure width 56 mm</i>			
	5 directions of approach M12 plug, 4-pole; channel 1 on NC, channel 2 on M12 socket, right Slow-action contacts	1 NC	➔ 3SF1 124-1QV10-1BA2

➔ Positive opening according to IEC 60947-5-1, Appendix K.











¹⁾ Supplied without actuator. Please order separately.

AS-Interface

ASIsafe

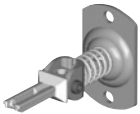
3SF1 position switches with separate actuator Accessories

Selection and ordering data

	Version	Order No.
<i>Actuators</i>		
Standard actuators		
	Standard actuators, length 75.6 mm	↻ 3SE5 000-0AV01
	With vertical fixing, length 53 mm	↻ 3SE5 000-0AV02
	With transverse fixing, length 47 mm	↻ 3SE5 000-0AV03
	With transverse fixing, plastic ¹⁾ Length 47 mm	↻ 3SE5 000-0AV11
Radius actuators		
	Approach from left, length 40 mm	↻ 3SE5 000-0AV04
	Approach from right, length 44.5 mm	↻ 3SE5 000-0AV06
	Universal radius actuator, length 69 mm	↻ 3SE5 000-0AV05
	Universal radius actuators, heavy-duty	
	• Length 67 mm	↻ 3SE5 000-0AV07-1AK2
	• Length 77 mm	↻ 3SE5 000-0AV07
<i>Optional accessories</i>		
	Protective caps made of black rubber for the actuator head, to protect the actuator openings from contamination (only for enclosure width 40 or 56 mm)	SE5 000-0AV08-1AA2
	Blocking inserts , high-grade steel, for actuator head, for up to 8 padlocks	3SE5 000-0AV08-1AA3

↻ Actuator can be used in safety circuits.

¹⁾ Not suitable for safety switches with interlocking.

Overview

The 3SF1 position switches with safety-oriented communication can be directly connected using the AS-Interface bus system. The safety functions no longer have to be conventionally wired up.

With the 3SF1 position switches the ASIsafe electronics are integrated in the switch enclosure.



3SF1 position switch with solenoid interlocking and with integrated ASIsafe electronics

Operation

The actuator head is included in the scope of supply. For actuation from four directions it can be adjusted through $4 \times 90^\circ$. The switches can also be approached from above.

The actuator is not included in the scope of supply for the position switch and must be ordered separately, with a choice of eight variations depending on application.

The actuator is encoded. Simple overruling by hand or auxiliary devices is impossible.

A high-grade steel blocking insert for attaching up to eight padlocks is available for even more safety.

A rubber cap to protect the enclosure from contamination is available for operation in dusty environments.

Solenoid interlocking

There are two versions for locking the actuator:

- Spring-actuated lock (closed-circuit principle) with various release mechanisms
- Magnetic field lock (open-circuit principle)

Display

The switches have a status display with four LEDs:

- LED 1 (green): AS-i
- LED 2 (red): FAULT
- LED 3 (yellow): F-IN1
- LED 4 (yellow): F-IN2

Connection

Connection to the AS-Interface is by means of a 4-pole M12 plug (plastic version) connected to the yellow AS-Interface bus cable (no additional supply of auxiliary power is required thanks to the low current consumption of the solenoid of max. 170 mA).

Benefits

The new generation of 3SF1 3 position switches with solenoid interlocking offers:

- More safety through higher locking forces:
 - 1300 N for the plastic version
 - 2600 N for the metal version
- Various release mechanisms: lock release, escape release and emergency release
- ASIsafe electronics integrated in the enclosure; connected through 4-pole M12 plug
- Current consumption of the solenoid max. 170 mA
- Two contact blocks as standard equipment, hence fewer versions needed
- Same dimensions for all enclosure versions: Plastic, metal
- An extensive range of actuators
- Status display with four LEDs

Operating conditions

The position switches with solenoid interlocking are exceptional safety-related devices which prevent an unforeseen or intentional opening of protective doors, protective grills or other covers as long as a dangerous situation is present (i.e. follow-on motion of the switched off machine).

The safety position switches with solenoid interlocking have the following functions:

- Enabling the machine or process with closed and locked protective device
- Locking the machine or process with opened protective device
- Position monitoring of the protective device and solenoid interlocking

Standards

The switches comply with the standards IEC 60947-1 (Low-Voltage Switchgear and Controlgear, General) and IEC 60947-5-1 (Electromechanical Control Circuit Devices).

The mechanical design of the switch corresponds to the requirements of the failsafe principle according to EN 1088.

Approvals

AS-Interface according to EN 50295 and IEC 62026-2.

The switches are approved for use with locking devices according to EN 1088 and EN 292, Parts 1 and 2.

The 3SF5 3 position switches with interlocking have a VDE test marking.

With a 3SF1 3 position switch it is possible to achieve category 3 according to ISO 13849-1 (EN 954-1) or SIL 2 according to IEC 61508.

Category 4 according to ISO 13849-1 (EN 954-1) or SIL 3 according to IEC 61508 can be achieved by using a second 3SE5 position switch.

The 3SF1 position switches are approved according to UL 508, UL 50 and UL 746-C.

AS-Interface

ASIsafe

3SF1 position switches with solenoid interlocking Plastic enclosures

Overview

5 directions of approach · Degree of protection IP66/IP67

- Slow-action contacts:
 - Version -1BA1: ASIsafe channel 1 on 1 NC contact from the actuator and channel 2 on 1 NC contact from the solenoid
 - Version -1BA3: ASIsafe channel 1 on the first NC contact from the actuator and channel 2 on the second NC contact from the actuator
 - Version -1BA4: ASIsafe channel 1 on 2 NC contacts from the actuator and channel 2 on 1 NC contact from the solenoid. A discrepancy between the two contacts of the actuator will be evaluated already in the switch.
- Solenoid: Rated operational voltage 24 V DC
- Locking force 1,300 N (1,000 N according to GS-ET 19)
- Status display with 4 LEDs 24 V DC;
 - 1: AS-i, 2: FAULT, 3: F-IN1, 4: F-IN2

Safety level

The new 3SF1 324-1S.21-1BA4 safety position switches are also suitable for several interlocks for protective doors – for secure diagnosis and fast ability to reclose the system.

They feature:

- feedback from the solenoid and
- the doors do not need to be opened after the magnet is released.



With AS-i safety monitor or in DP/AS-i F-Link it is possible to achieve SIL 2 according to IEC 61508 or PL d according to ISO 13849-1.

Comparison of versions

Version	Contacts Actuator / magnet	Attainable safety level	Diagnostics Magnet feedback	Reclose condition after the release of the magnet (depends on the type of evaluation)
3SF1 324-1S.21-1BA1	1 NC/1 NC	SIL 1 / PL c	4	Door must <u>not</u> be opened
	1 NC/1 NC	SIL 2 / PL d	4	Door must be opened
3SF1 324-1S.21-1BA3	2 NC	SIL 2 / PL d	--	Door must <u>not</u> be opened
3SF1 324-1S.21-1BA4	2 NC/1 NC	SIL 2 / PL d	4	Door must <u>not</u> be opened

6

Selection and ordering data

	Interlock ¹⁾	Contacts Actuator / magnet	Order No.
1,300 N locking force · Enclosure width 54 mm			
 3SF1 324-1SD21-...	Spring-actuated locks		
	• With auxiliary release	1 NC/1 NC	➔ 3SF1 324-1SD21-1BA1
	• With auxiliary release	2 NC / –	➔ 3SF1 324-1SD21-1BA3
	• With auxiliary release	2 NC/1 NC	➔ 3SF1 324-1SD21-1BA4
	• With auxiliary release with lock	1 NC/1 NC	➔ 3SF1 324-1SE21-1BA1
 3SF1 324-1SF21-...	• With escape release from the front		
		1 NC/1 NC	➔ 3SF1 324-1SF21-1BA1
		2 NC/1 NC	➔ 3SF1 324-1SF21-1BA4
		1 NC/1 NC	➔ 3SF1 324-1SG21-1BA1
	• With escape release from the back and auxiliary release from the front	1 NC/1 NC	➔ 3SF1 324-1SG21-1BA4
	• With emergency release from the back and auxiliary release from the front	1 NC/1 NC	➔ 3SF1 324-1SJ21-1BA1
 3SF1 324-1SB21-...	Magnetic field lock		
		1 NC/1 NC	➔ 3SF1 324-1SB21-1BA1
		2 NC / –	➔ 3SF1 324-1SB21-1BA3

➔ Positive opening according to IEC 60947-5-1, Appendix K.

¹⁾ Supplied without actuator. Please order separately.

Note:

For actuator and optional accessories, see page 6/24.

Overview



5 directions of approach · Degree of protection IP66/IP67

- Slow-action contacts:
Version -1BA1: ASIsafe channel 1 on 1 NC contact from the actuator and channel 2 on 1 NC contact from the solenoid
- Solenoid: Rated operational voltage 24 V DC
- Locking force 2600 N (2000 N according to GS-ET 19)
- Status display with 4 LEDs 24 V DC;
1: AS-i, 2: FAULT, 3: F-IN1, 4: F-IN2

Safety level

Version	Contacts Actuator / magnet	Attainable safety level	Diagnostics Magnet feedback	Reclose condition after the release of the magnet (depends on the type of evaluation)
3SF1 324-1S.21-1BA1	1 NC/1 NC	SIL 1 / PL c	4	Door must <u>not</u> be opened
	1 NC/1 NC	SIL 2 / PL d	4	Door must be opened

Selection and ordering data

Interlock ¹⁾	Contacts Actuator / magnet	Order No.
<i>2600 N locking force · Enclosure width 54 mm</i>		
 3SF1 314-1SD21-...	Spring-actuated locks	
	• With auxiliary release	1 NC/1 NC → 3SF1 314-1SD11-1BA1
	• With auxiliary release with lock	1 NC/1 NC → 3SF1 314-1SE11-1BA1
	• With escape release from the front	1 NC/1 NC → 3SF1 314-1SF11-1BA1
	• With escape release from the back and auxiliary release from the front	1 NC/1 NC → 3SF1 314-1SG11-1BA1
• With emergency release from the back and auxiliary release from the front	1 NC/1 NC → 3SF1 314-1SJ11-1BA1	
 3SF1 314-1SF21-...	Magnetic field lock	1 NC/1 NC → 3SF1 314-1SB11-1BA1
 3SF1 314-1BF21-...		

→ Positive opening according to IEC 60947-5-1, Appendix K.

¹⁾ Supplied without actuator. Please order separately.

Note:

For actuator and optional accessories, see page 6/24.

AS-Interface

ASIsafe

3SF1 hinge switches Plastic enclosures

Overview

The 3SF1 hinge switches with safety-oriented communication can be directly connected using the AS-Interface bus system. The safety functions no longer have to be conventionally wired up.

With the 3SF1 position switches the ASIsafe electronics are integrated in the switch enclosure.

The hinge switches are provided for mounting on hinges. There are two actuator versions here:

- Hollow shaft, inner diameter 8 mm, outer 12 mm
- Solid shaft, diameter 10 mm





For the ASIsafe version of the hinge switch, the basic switch and twist actuator must be ordered separately. The basic switches correspond to the position switches of the standard version (only use versions with snap-action contacts).

The standards and approvals correspond to position switches 3SF1 (see page 6/14).

Selection and ordering data

Modular system

1 or 2 contacts · 3 LEDs · Degree of protection IP65 (31 mm) or IP66/IP67 (50 mm) · M12 plug

	Version	Contacts	LEDs	Order No.
<i>Basic switches - Enclosure width 31 mm acc. to EN 50047</i>				
	With teflon plunger, with M12 plug. 4-pole; channel 1 on NC contact, channel 2 on NC contact Snap-action contacts	2 NC	24 V DC →	3SF1 234-1LC05-1BA1
ASIsafe basic switch				
<i>Basic switches - Enclosure width 50 mm</i>				
	With teflon plunger, with M12 plug. 4-pole; channel 1 on NC contact, channel 2 on M12 socket, right Snap-action contacts	1 NC	24 V DC →	3SF1 244-1LC05-1BA2
ASIsafe basic switch				
<i>Actuator heads</i>				
	With hollow shaft • Operating angle 10°			3SE5 000-0AU21
Twist actuators with hollow shaft				
	With solid shaft • Operating angle 10°			3SE5 000-0AU22
Twist actuators with solid shaft				

→ Positive opening according to IEC 60947-5-1, Appendix K.

Overview

The 3SF1 hinge switches with safety-oriented communication can be directly connected using the AS-Interface bus system. The safety functions no longer have to be conventionally wired up.

With the 3SF1 position switches the ASIsafe electronics are integrated in the switch enclosure.

The hinge switches are provided for mounting on hinges. There are two actuator versions here:





- Hollow shaft, inner diameter 8 mm, outer 12 mm
- Solid shaft, diameter 10 mm

For the ASIsafe version of the hinge switch, the basic switch and twist actuator must be ordered separately. The basic switches correspond to the position switches of the standard version (only use versions with snap-action contacts).

The standards and approvals correspond to position switches 3SF1 (see page 6/14).

Selection and ordering data**Modular system**

1 or 2 contacts · 3 LEDs · Degree of protection IP66/IP67 · M12 plug

	Version	Contacts	LEDs	Order No.
<i>Basic switches - Enclosure width 31 mm acc. to EN 50047</i>				
	With teflon plunger , with M12 plug, 4-pole; channel 1 on NC contact, channel 2 on NC contact • Snap-action contacts	2 NC	24 V DC →	3SF1 214-1LC05-1BA1
ASIsafe basic switch				
<i>Basic switches - Enclosure width 40 mm acc. to EN 50041</i>				
	With M12 plug , 4-pole, channel 1 on NC contact, channel 2 on NC contact Snap-action contacts	2 NC	24 V DC →	3SF1 114-1LA00-1BA1
ASIsafe basic switch				
<i>Basic switches - Enclosure width 56 mm</i>				
	With M12 plug , 4-pole, channel 1 on NC contact, channel 2 on M12 socket, right Snap-action contacts	1 NC	24 V DC →	3SF1 124-1LA00-1BA2
ASIsafe basic switch				
<i>Actuator heads</i>				
	Hollow shaft • Operating angle 10°			3SE5 000-0AU21
Twist actuators with hollow shaft				
	Solid shaft • Operating angle 10°			3SE5 000-0AU22
Twist actuators with solid shaft				
→ Positive opening according to IEC 60947-5-1, Appendix K.				

AS-Interface

ASIsafe

3SF2 cable-operated switches for AS-Interface

Overview

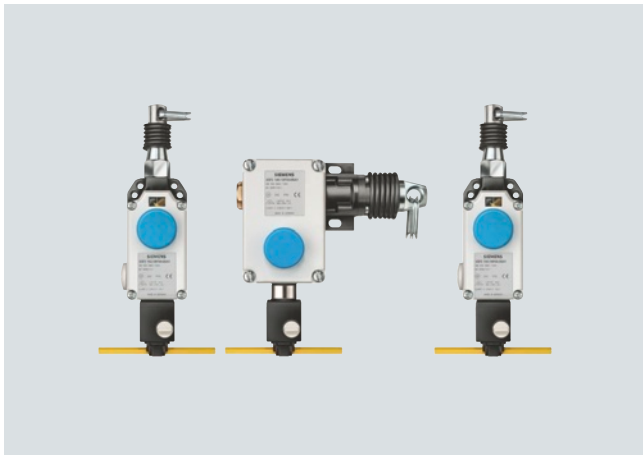

SIRIUS cable-operated switches are used for monitoring or for EMERGENCY-STOP devices on particularly endangered system sections.

AS-Interface cable-operated switches can be directly connected via the bus system AS-Interface with safety-oriented communication.



The safety functions no longer have to be conventionally wired up.

As the effective range of a cable-operated switch is only limited by the length of the trip-wire, large systems can also be protected.

Standards

The switches with positive latching are suitable for operation in EMERGENCY-STOP devices in according to ISO 13850. They can be used up to category 4 acc. to ISO 13849-1 (EN 954-1) or SIL 3 acc. to IEC 61508.

Selection and ordering data

Version	Basic switches	Contacts	Order No.
<i>Cable-operated switches with AS-i F adapter</i>			
 <p>Metal enclosure with dust protection, IP65, latching acc. to ISO 13850, with button reset, 2 NC contacts</p> <ul style="list-style-type: none"> For wire lengths up to 10 m, with alignment window 	3SE7 120-1BF00	2 NC	➔ 3SF2 120-1BF00-0BA1
 <ul style="list-style-type: none"> For wire lengths up to 25 m, with alignment window 	3SE7 150-1BF00	2 NC	➔ 3SF2 150-1BF00-0BA1
 <ul style="list-style-type: none"> For wire lengths up to 50 m 	3SE7 140-1BF00	2 NC	➔ 3SF2 140-1BF00-0BA1

➔ Positive opening according to IEC 60947-5-1, Appendix K.

Overview

EMERGENCY-STOP control devices can now be directly connected via the standard AS-Interface with safety-oriented communication. This only applies for the SIRIUS 3SB3 EMERGENCY-STOP mushroom pushbutton for front panel mounting and for mounting into an enclosure.

AS-Interface EMERGENCY-STOP enclosures



The enclosure is delivered fully equipped and wired up. It contains:



- EMERGENCY-STOP SIRIUS 3SB3 mushroom pushbutton with compulsory latching acc. to ISO 13850 and rotate-to-unlatch mechanism
- Contact blocks with two NC contacts
- F slave with 2 safe inputs
- Inscription labels

The plastic enclosures have a plastic EMERGENCY-STOP mushroom pushbutton, the metal enclosures have a metal EMERGENCY-STOP mushroom pushbutton.

The plastic enclosures are designed with a connecting terminal for the AS-Interface shaped cable (the cable is contacted using insulation piercing method and run past the outside of the enclosure). For the metal enclosures, the AS-Interface shaped cable (or round cable) is routed into the enclosure.

The enclosures can also be delivered with a M12 plug.

Selection and ordering data

	Version	Connection	Order No.
 5SF5 811-0AA08	AS-Interface EMERGENCY-STOP mushroom pushbutton in the plastic enclosure <ul style="list-style-type: none"> • Yellow top part of enclosure • Yellow top part of enclosure with protective collar • Yellow top part of enclosure 	Insulation piercing method	3SF5 811-0AA08
		Insulation piercing method	3SF5 811-0AB08
		M12 plugs	3SF5 811-0AA10
 3SF5 811-2AB08  3SF5 811-2AA10	AS-Interface EMERGENCY-STOP mushroom pushbutton in the metal enclosure <ul style="list-style-type: none"> • Yellow top part of enclosure • Yellow top part of enclosure with protective collar • Yellow top part of enclosure • Yellow top part of enclosure with protective collar 	Cable gland	3SF5 811-2AA08
		Cable gland	3SF5 811-2AB08
		M12 plugs	3SF5 811-2AA10
		M12 plugs	3SF5 811-2AB10

AS-Interface

















ASIsafe

SIRIUS EMERGENCY-STOP mushroom pushbuttons for AS-Interface

Selection and ordering data

EMERGENCY-STOP control device acc. to ISO 13850 and IEC 60947-5-5















- With holder for mounting on front plates
- Connection with F adapter AS-Interface
- Yellow backing plates are to be ordered separately

	Version	Approval	Order No.
<i>With plastic enclosure</i>			
	EMERGENCY-STOP mushroom pushbuttons, Ø 32 mm, with positive latching according to ISO 13850, with rotate-to-unlatch mechanism		3SB30 00-1FA20
Mushroom diameter 32 mm			
	EMERGENCY-STOP mushroom pushbuttons, Ø 40 mm, with positive latching according to ISO 13850, with rotate-to-unlatch mechanism		3SB30 00-1HA20 3SB30 00-1HA26
Mushroom diameter 40 mm, with rotate-to-unlatch mechanism with switch position indication	<ul style="list-style-type: none"> • Without switch position indicator • With mechanical switch position indication 		
	EMERGENCY-STOP mushroom pushbuttons, Ø 40 mm, with positive latching acc. to ISO 13850, with pull-to-unlatch mechanism		3SB30 00-1TA20
Mushroom diameter 40 mm, pull-to-unlatch mechanism			
	EMERGENCY-STOP mushroom pushbuttons, Ø 60 mm, with positive latching according to ISO 13850, with rotate-to-unlatch mechanism		3SB30 00-1AA20
Mushroom diameter 60 mm			
	EMERGENCY-STOP mushroom pushbuttons, Ø 40 mm, with RONIS key-operated switches, lock No. SB 30, with positive latching according to ISO 13850, unlocking only possible using key		3SB30 00-1BA20
Mushroom diameter 40 mm, with RONIS key-operated switch			
	EMERGENCY-STOP mushroom pushbuttons, Ø 40 mm, with CES key-operated switches, lock no. SSG 10, with positive latching according to ISO 13850, unlocking only possible using key		3SB30 00-1KA20
Mushroom diameter 40 mm, with CES key-operated switch			
	EMERGENCY-STOP mushroom pushbuttons, Ø 40 mm, with BKS key-operated switches, lock no. S1, with positive latching according to ISO 13850, unlocking only possible using key		3SB30 00-1LA20
Mushroom diameter 40 mm, with CES key-operated switch			
	EMERGENCY-STOP mushroom pushbuttons, Ø 40 mm, with O.M.R. key-operated switch, lock No. 73037, with positive latching according to ISO 13850, unlocking only possible using key		3SB30 00-1MA20
Mushroom diameter 40 mm, with CES key-operated switch			

Selection and ordering data (continued)

EMERGENCY-STOP control device acc. to ISO 13850 and IEC 60947-5-5

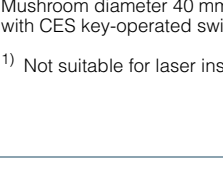
- With holder for mounting on front plates
- Connection with F adapter AS-Interface
- Yellow backing plates are to be ordered separately

	Version	Approval	Order No.
<i>With metal enclosure</i>			
	EMERGENCY-STOP mushroom pushbuttons, Ø 32 mm, with positive latching according to ISO 13850, with rotate-to-unlatch mechanism		3SB35 00-1FA20 3SB35 00-1FA20-0PA0
Mushroom diameter 32 mm	<ul style="list-style-type: none"> • Standard version • Solvent-resistant¹⁾ 		
	EMERGENCY-STOP mushroom pushbuttons, Ø 40 mm, with positive latching according to ISO 13850, with rotate-to-unlatch mechanism		3SB35 00-1HA20 3SB35 00-1HA20-0PA0 3SB35 00-1HA26
Mushroom diameter 40 mm, with rotate-to-unlatch mechanism with switch position indication	Without switch position indicator Without switch position indicator, solvent-resistant ¹⁾ With mechanical switch position indication		
	EMERGENCY-STOP mushroom pushbuttons, Ø 40 mm, with positive latching acc. to ISO 13850, with pull-to-unlatch mechanism		
Mushroom diameter 40 mm, pull-to-unlatch mechanism			3SB35 00-1TA20
	EMERGENCY-STOP mushroom pushbuttons, Ø 60 mm, with positive latching according to ISO 13850, with rotate-to-unlatch mechanism		3SB35 00-1AA20
Mushroom diameter 60 mm			3SB35 00-1BA20
	EMERGENCY-STOP mushroom pushbuttons, Ø 40 mm, with RONIS key-operated switches, lock No. SB 30, with positive latching according to ISO 13850, unlocking only possible using key		3SB35 00-1KA20
Mushroom diameter 40 mm, with RONIS key-operated switch			3SB35 00-1LA20
	EMERGENCY-STOP mushroom pushbuttons, Ø 40 mm, with BKS key-operated switches, lock no. S1, with positive latching according to ISO 13850, unlocking only possible using key		3SB35 00-1MA20
Mushroom diameter 40 mm, with CES key-operated switch			3SB35 00-1MA20
	EMERGENCY-STOP mushroom pushbuttons, Ø 40 mm, with O.M.R. key-operated switch, lock No. 73037, with positive latching according to ISO 13850, unlocking only possible using key		
Mushroom diameter 40 mm, with CES key-operated switch			

¹⁾ Not suitable for laser inscription.

AS-Interface

ASIsafe

AS-Interface F adapters for EMERGENCY-STOP devices

Overview





The AS-Interface F adapter is used to connect an EMERGENCY-STOP device according to ISO 13850 from the 3SB3 series to the AS-Interface bus system. The F adapter is suitable for control devices with mounting on front plates.

The F adapter has a safe AS-Interface 2I slave and is snapped from behind onto the EMERGENCY-STOP mushroom pushbutton. In the 2I/1O expanded version, an output is also available for actuating an indicator light with LED.

Depending on the version, screw terminals or spring-type terminals or the insulation piercing method are used for connecting to the AS-Interface bus cable. Addressing is performed using the AS-Interface connection or the integrated addressing socket.

Safety category 4 (SIL 3) is achieved with the adapter.

Selection and ordering data

	Version	Connection	Order No.	
 3SF5 402-1AA03	AS-Interface F adapter for EMERGENCY-STOP mushroom pushbutton 3SB3 For mounting on front plates	Screw terminals	• 2I	3SF5 402-1AA03
			• 2I/1O, with output for LED control	3SF5 402-1AB03
		Spring-type terminals	• 2I	3SF5 402-1AA04
			• 2I/1O, with output for LED control	3SF5 402-1AB04
		Insulation piercing method	• 2I	3SF5 402-1AA05
 3SF5 402-1AA05	• 2I/1O, with output for LED control		3SF5 402-1AB05	

Overview



CP 243-2

The CP 243-2 is the AS-Interface master for the SIMATIC S7-200 and has the following features:

- Connection of up to 62 AS-Interface slaves
- Integrated analog value transmission (Analog Profiles 7.3 and 7.4)
- Supports all AS-Interface master functions according to the extended AS-Interface specification V2.1
- Indication of the operating state and readiness for operation of connected slaves by means of LEDs in the front panel
- Fault indications (e. g. AS-Interface voltage fault, configuration fault) by means of LEDs in the front panel
- Compact enclosure in the design of the SIMATIC S7-200

Design

The CP 243-2 is connected like an expansion module to the S7-200. It has:

- Two screw terminals for direct connection of the AS-Interface cable
- LEDs in the front panel for indicating the operating state and functional readiness of all connected slaves
- Two pushbuttons for indicating the status information of the slaves, for switching over the operating state and for adopting the existing ACTUAL configuration as the DESIRED configuration.

Function

The CP 243-2 supports all specified functions of the extended AS-Interface Specification V2.1.

In the process image of the S7-200 the CP 243-2 occupies one digital input byte (status byte), one digital output byte (control byte), and 8 analog input and 8 analog output words. The CP 243-2 thus occupies two (logic) slots. The operating mode of the CP 243-2 can be set with the status byte and the control byte using the user program. Depending on the operating mode, the CP 243-2 saves either the digital or analog I/O data of the AS-Interface slaves or diagnostic values in the analog address area of the S7-200, or it enables master calls (e.g. re-addressing of the slaves).

Configuration

All connected AS-Interface slaves are configured at the press of a button. No further configuration of the CP is required.

Benefits



- More flexibility and versatility in the use of SIMATIC S7-200 as the result of the distinct increase in the number of digital and analog inputs/outputs available

- Shorter start-up times through simple configuration at the press of a button
- Reduction of standstill and servicing times in the event of a fault thanks to the LED indicators
- Status of the CP
 - Indication of all the slaves connected and their readiness for operation
 - Monitoring of the AS-Interface mains voltage

Application

The CP 243-2 is the AS-Interface master connection for the 22x CPUs of the SIMATIC S7-200. Through connection to AS-Interface the number of inputs and outputs available for S7-200 is greatly increased (max. 248 DI / 186 DO on the AS-Interface per CP).

Analog values (per CP a maximum of 31 standard analog slaves with up to 4 channels each) also become available on the AS-Interface for the S7-200 thanks to the integrated analog value processing. On the S7-200, up to two CP 243-2 communication processors can be operated simultaneously.

Selection and ordering data

Version	Screw terminals
 <p>CP 243-2 communication processors For connection of the SIMATIC S7-200 to AS-Interface; corresponds to AS-Interface Specification V2.1; dimensions (W x H x D / mm): 71 x 80 x 62 (dimensions without fixing lugs)</p>	<p>Order No. 6GK7 243-2AX01-0XA0</p>

6GK7 243-2AX01-0XA0

More information

The manuals are also available on the Internet at <http://support.automation.siemens.com/WWW/view/en/10805937/133300>

AS-Interface Masters

Masters for SIMATIC S7
CP 343-2P, CP 343-2

Overview



CP 343-2P / CP 343-2

The CP 343-2P is the AS-Interface master for the SIMATIC S7-300 and the ET 200M distributed I/O station, with user-friendly parameterizing options.

The CP 343-2 is the basic version of the same module.

The CP 343-2P / CP 343-2 has the following features:

- Connection of up to 62 AS-Interface slaves
- Integrated analog value transmission (all analog profiles)
- Supports all AS-Interface master functions according to the AS-Interface Specification V3.0
- Status displays of operating states and indication of the readiness for operation of connected slaves by means of LEDs in the front panel
- Fault indication (e.g. AS-Interface voltage fault, configuration fault) by means of LEDs in the front panel
- Compact enclosure in the design of the SIMATIC S7-300
- Suitable for AS-i Power24V (product version 2 and higher / firmware version 3.1) and standard AS-i (30 V)
- Extra with the CP 343-2P: Supports detailed configuration of the AS-Interface-network with STEP 7 V5.2 and higher

Design

The CP 343-2P / CP 343-2 is connected like an I/O module to the S7-300. It has:

- Two terminal connections for direct connection of the AS-Interface cable
- LEDs in the front panel for indicating the operating state and the readiness for operation of all connected and activated slaves
- Pushbuttons for switching over the master operating state and for adopting the existing ACTUAL configuration of the AS-i slave as the DESIRED configuration

Function

The CP 343-2P / CP 343-2 supports all specified functions of the extended AS-Interface Specification V3.0.

The CP 343-2P / CP 343-2 occupies 16 bytes each in the I/O address area of the SIMATIC S7-300. The digital I/O data of the standard slaves and A slaves are saved in this area. The digital I/O data of the B slaves and the analog I/O data can be accessed with the S7 system functions.

If required, master calls can be performed with the command interface FC ASI_3422, e. g. read/write parameters, read/write configuration. The FC including a STEP7 sample program can be downloaded from the Internet at:

<http://support.automation.siemens.com/WW/view/en/5581657>

Configuration

All connected AS-Interface slaves are configured at the press of a button. No further configuration of the CP is required.

Additional features of the CP 343-2P

The CP 343-2P also supports configuring of the AS-Interface network with STEP 7 V5.2 and higher. Specifying the AS-i configuration in HW-Config facilitates the setting of slave parameters and documentation of the plant. Uploading the ACTUAL configuration of an already configured AS-Interface network is also supported. The saved configuration cannot be overwritten at the press of a button and is therefore tamper-proof.

Benefits



- Shorter start-up times through simple configuration at the press of a button
 - Construction of flexible distributed structures by use in the DP-slave ET 200M
 - Provides diagnostics of the AS-Interface networks
 - Well suited also for complex applications thanks to connection options for 62 slaves and integral analog value processing
 - Reduction of standstill and servicing times in the event of a fault thanks to the LED indicators:
 - Status of the AS-Interface network
 - Slaves connected and their readiness for operation
 - Monitoring of the AS-Interface mains voltage
 - Lower costs for stock keeping and spare parts because the CP can be used for the SIMATIC S7-300 as well as for the ET 200M
 - Extra with the CP 343-2P: Improved plant documentation and support for service assignments thanks to a description of the AS-Interface configuration in the STEP 7 project
- No need for the AS-i power supply unit with AS-i Power24V: The AS-Interface cable is supplied through an existing 24 V DC PELV power supply unit. An AS-i data decoupling module (e.g. 3RK1 901-1DE12-1AA0) is required for the decoupling, see page 136.
 - Operation with an AS-Interface power supply unit (e.g. 3RX9 501-0BA00, see page 135) is also possible without restrictions.

Application



The CP 343-2P / CP 343-2 is the AS-Interface master connection for the SIMATIC S7-300 and the ET 200M.

Through connection to AS-Interface it is possible to access max. 248 DI/248 DO per CP, using 62 A/B slaves with 4DI/4DO each.



With the integrated analog value processing it is easy to transmit analog signals (per CP up to 62 A/B analog slaves with a maximum of two channels each or up to 31 A/B analog slaves with a maximum of 4 channels each).

The CP 343-2P is the further development of the CP 343-2 and contains its entire functionality. An existing STEP 7 user program for a CP 343-2 can thus be used without restrictions with a CP 343-2P. It is only in STEP 7 HW-Config that the two modules are configured differently, with the CP 343-2P offering additional options. This is why the CP 343-2P is recommended.

Selection and ordering data

Version	Order No.
 CP 343-2P communication processors For connection of SIMATIC S7-300 and ET 200M to AS-Interface; configuration of the AS-i network using the SET key or STEP 7 (V5.2 and higher); without front connector; corresponds to AS-Interface Specification V3.0; dimensions (W x H x D / mm): 40 x 125 x 120 6GK7 343-2AH11-0XA0	6GK7 343-2AH11-0XA0
 CP 343-2 communication processors Basic version for connection of SIMATIC S7-300 and ET 200M to AS-Interface Configuration of the AS-i network using the SET key; without front connector; corresponds to AS-Interface Specification V3.0; dimensions (W x H x D / mm): 40 x 125 x 120 6GK7 343-2AH01-0XA0	6GK7 343-2AH01-0XA0

Accessories

Version	Order No.
Front connectors, 20-pole <ul style="list-style-type: none"> • With screw terminals 	 6ES7 392-1AJ00-0AA0
Front connectors, 20-pole <ul style="list-style-type: none"> • With spring-type terminals 	 6ES7 392-1BJ00-0AA0

More information

The manuals are available on the Internet at <http://support.automation.siemens.com/WWW/view/en/14310380/133300>

The AS-i function block library for PCS 7 to easily connect an AS-Interface to PCS 7, see Catalog IC 10 or in the Industry Mall under

www.siemens.com/industrymall

"Automation technology" --> "Industrial controls" --> "Planning, Configuration and Visualizing for SIRIUS" --> "AS-Interface function block library for SIMATIC PCS 7"

AS-Interface Network transitions

DP/AS-i LINK Advanced

Overview



DP/AS-i LINK Advanced

PN	DP-M	DP-S	ASi-M		
		●	●		IK0...10195

The DP/AS-i LINK Advanced is a compact Network transition between PROFIBUS (DP Slave) and AS-Interface, with the following features:

- Single and double AS-Interface master (according to AS-Interface Specification V3.0) for connection of 62 AS-Interface slaves or 124 AS-Interface slaves (with a double master)
- Integrated analog value transmission (all analog profiles)
- Integrated ground-fault monitoring for the AS-Interface cable
- User-friendly local diagnostics and start-up by means of a full graphic display and control keys or through a web interface with a standard browser on the PC screen
- Optimum TIA integration using STEP 7
- Integration in non-Siemens engineering tools using the PROFIBUS GSD file
- Vertical integration (standard web interface) through Industrial Ethernet
- Supply voltage from the AS-Interface shaped cable or alternatively with 24 V DC (optional)
- Suitable for AS-i Power24V (product version 4 and higher / firmware version 2.1.20) and standard AS-i (30 V)
- Module exchange without entering the connection parameters (PROFIBUS address etc) using C-PLUG (optional)

Design

- Compact plastic enclosure in degree of protection IP20 for standard rail mounting
- COMBICON plug-in screw terminals
- Compact design:
 - Pixel graphics display in the front panel for detailed indication of the operating state and readiness for operation of all connected AS-Interface slaves
 - 6 pushbuttons for starting up and testing the AS-Interface line directly on the DP/AS-i LINK Advanced
 - LED indication of the operating state of PROFIBUS DP and AS-Interface
 - Integrated Ethernet port (RJ45 socket) for user-friendly start-up, diagnostics and testing of DP/AS-i LINK Advanced through a web interface using a standard browser
- Small mounting depth thanks to recessed plug mounting
- Operation without fans and batteries

Functionality

Communication

The DP/AS-i LINK Advanced enables a PROFIBUS DP master to cyclically access the I/O data of all the slaves of a lower-level AS-Interface segment. Also supported are the expanded slave types with higher I/O data volume according to AS-i Specification V3.0.

The DP/AS-i LINK Advanced occupies the following address area:

- As a single master: 32 bytes of input data and 32 bytes of output data in which the I/O data of the connected AS-Interface slaves (standard and A/B slaves) of an AS-i line are stored.
- A double master occupies twice the number of bytes.

The size of the input/output image can be compressed so that only the actually required I/O address area is occupied in the system of the DP master.

The integrated evaluation of analog signals is just as easy as access to digital values because the analog process data also lie directly in the I/O address area of the CPU.

PROFIBUS DP-V1 Masters also provide the option of triggering AS-Interface Master calls over the acyclic PROFIBUS services (e. g. write parameters, amend addresses, read diagnostic values).

Using an operating display in AS-i Link it is possible to fully commission the lower-level AS-Interface line.

DP/AS-i LINK Advanced is equipped with an additional Ethernet port which enables use of the integrated web server. The web server can be called up with any standard web browser (e. g. Internet Explorer) without additional software. It allows all diagnostics information to be shown on the PC and the bus configuration and, if applicable, any adjustments, to be displayed. Firmware updates are also possible using this port.

The optional C-PLUG supports module exchange without entering the connection parameters (IP address etc.), keeping downtimes to a minimum in the event of a fault.

Diagnostics

The following diagnostics is possible using LEDs, the display and control keys, web interface or STEP 7:

- Operating state of the DP/AS-i LINK Advanced
- Status of the link as a PROFIBUS DP slave
- Diagnostics of the AS-Interface network
- Message frame statistics
- Standard diagnostics pages in the web interface for fast diagnostics access through Ethernet using a standard browser
- For the use of the web interfaces are no network settings on the PC necessary (Zeroconf procedure).
- The reporting of diagnostic events is optional via E-Mail or SNMP Trap possible. The integrated diagnostic buffer saves the events including time stamp.

Configuration

The DP/AS-i LINK Advanced can be configured as follows:

- With STEP 7 as of V5.4: With STEP 7 configuring the AS-Interface configuration can be uploaded in STEP 7. Can also be AS-Interface slaves from Siemens conveniently configure in HW Config (slave selection dialog).
- By adopting the ACTUAL configuration of the AS-Interface on the display
- Alternatively DP/AS-i LINK Advanced can be integrated into the engineering tool over the PROFIBUS GSD file (e. g. for STEP 7 versions below V5.4 or engineering tools from third-party software houses).

DP/AS-i LINK Advanced

Benefits



- Short start-up times through simple configuration at the press of a button and testing of the AS-Interface line using the display or web interface
- Reduction of standstill and servicing times in the event of a slave failure thanks to user-friendly diagnostics using the display or web interface and through simple module exchange with the help of the C-PLUG exchange medium
- Reduced amount of engineering work thanks to user-friendly configuration of Siemens slaves using the slave catalog in HW-Config (STEP 7)

- Costs saved by the double AS-Interface master when large volumes of project data are involved
- Saves the need for AS-i power pack with AS-i Power24V: The AS-Interface cable assembly is fed through an existing 24 V DC PELV power pack. For decoupling an AS-i data decoupling module is required, see power supply units and data decoupling modules.
- Standard mode with AS-Interface power supply (see power supply units and data decoupling modules) possible without restrictions, whereby no further operating voltage is required

Application

The DP/AS-i LINK Advanced is a PROFIBUS DP-V1 slave (according to EN 50170) and an AS-Interface master (based on AS-Interface Specification V3.0 according to IEC 62026-2). It enables transparent data access to AS-Interface from PROFIBUS DP.

Exchanging data with the PROFIBUS DP master

PROFIBUS DP masters (DP-V0) can exchange I/O data with AS-Interface in cyclic mode. PROFIBUS DP masters with acyclic services (DP-V1) are able in addition to initiate AS-Interface master calls (e. g. reading/writing the AS-i configuration during normal operation). As such, the DP/AS-i LINK Advanced is particularly well suited for a decentral construction and for connection of a lower-level AS-Interface network.

Single masters

For applications with typical volumes of project data it is sufficient to use the DP/AS-i LINK Advanced in its version as an AS-Interface single master. The single master can operate up to 248 DI/248 DO, using 62 A/B slaves with 4 DI/4 DO each.

Double masters

For applications with large volumes of project data the DP/AS-i LINK Advanced in its version as an AS-Interface double master is used. In this case, twice the volume of project data can be used on two AS-Interface lines running independently of each other. The double master can operate up to 496 DI/496 DO, using 2 AS-i networks with 62 A/B slaves each with 4DI/4DO each.

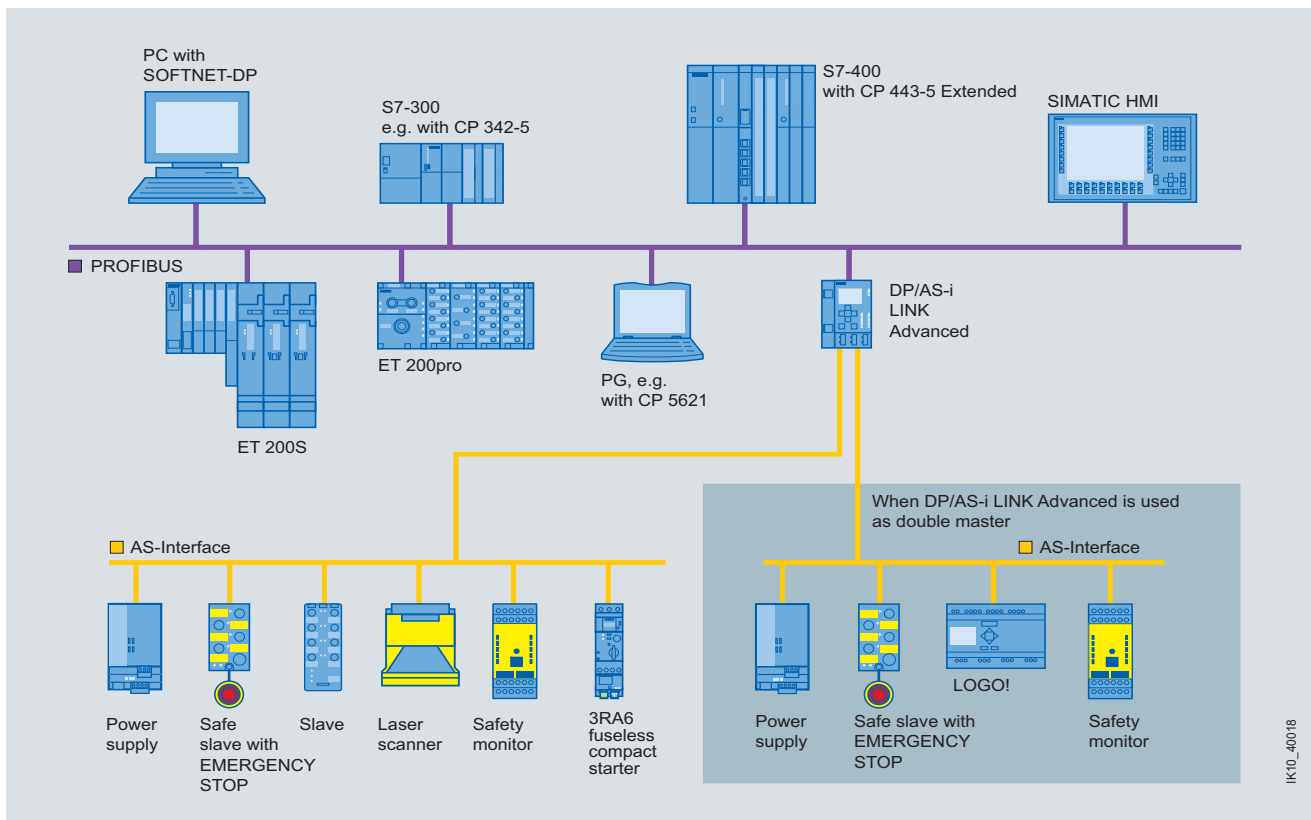

Integration of AS-Interface on PROFIBUS through DP/AS-i LINK Advanced as single/double master



AS-Interface

Network transitions

DP/AS-i LINK Advanced

Selection and ordering data

Version	Combicon connection Order No.
 <p>DP/AS-i LINK Advanced Network transition between PROFIBUS DP and AS-Interface; Degree of protection IP20; including COMBICON plug-in screw terminals for connection of an AS-Interface cable (two AS-Interface cables for double masters) and the optional 24 V supply; corresponds to AS-Interface Specification 3.0; dimensions (W x H x D / mm): 90 x 132 x 88.5</p> <ul style="list-style-type: none"> • Single master with display • Double master with display 	<p>6GK1 415-2BA10 6GK1 415-2BA20</p>

DP/AS-i LINK Advanced

Accessories

C-PLUG

Exchange medium for the simple exchange of devices in the event of a fault;
for accommodating configuration and application data; can be used in SIMATIC NET products
with a C-PLUG slot

6GK1 900-0AB00

PROFIBUS FastConnect Standard Cable GP

FastConnect standard type with special design
for fast installation, 2-core, shielded

6XV1 830-0EH10

PROFIBUS FastConnect

RS485 bus connectors with angled cable feeder (35°)

With insulation displacement connection the max. transmission rate is 12 Mbit/s
Activatable terminating resistor is integrated

- Without PG connection socket
- With PG connection socket

6ES7 972-0BA60-0XA0
6ES7 972-0BB60-0XA0

PROFIBUS FastConnect Stripping Tool

Preset stripping tool for speedy stripping of PROFIBUS FastConnect bus cables

6GK1 905-6AA00

IE FC RJ45 Plug 90

RJ45 plug-in connector for Industrial Ethernet, with robust metal enclosure and integrated
cutting and clamping contacts for connection of Industrial Ethernet FC installation cables;
with 90° cable feeder

- 1 pack = 1 units
- 1 pack = 10 units
- 1 pack = 50 units

6GK1 901-1BB20-2AA0
6GK1 901-1BB20-2AB0
6GK1 901-1BB20-2AE0

More information

The manuals are available on the Internet at
<http://support.automation.siemens.com/WWW/view/en/28602701/133300>

The AS-i function block library for PCS 7 to easily connect an
AS-Interface to PCS 7, see Catalog IC 10
or in the Industry Mall at

www.siemens.com/industrymall

"Automation technology" --> "Industrial controls" -->

"Planning, Configuration and Visualizing for SIRIUS" -->

"AS-Interface function block library for SIMATIC PCS 7"

Overview



DP/AS-Interface Link 20E

PN	DP-M	DP-S	ASi-M		
		●	●		

K10-10186

DP/AS-Interface Link 20E connects PROFIBUS DP to AS-Interface and has the following features.

- PROFIBUS DP slave and AS-Interface master
- Up to 62 AS-Interface slaves, each with 4 digital inputs and 4 digital outputs as well as analog slaves can be connected
- Integrated analog value transmission (all analog profiles)
- Supports all AS-Interface master functions according to the AS-Interface Specification V3.0
- Supply from AS-Interface cable; hence no additional power supply required
- Supports the uploading of the AS-Interface configuration in STEP 7 V5.2 and higher

Design

- Compact plastic enclosure in degree of protection IP20 for standard rail mounting
- LEDs in the front panel for indicating the operating state and functional readiness of all connected slaves
- Setting option for PROFIBUS DP address by pressing a button
- LED indication of the PROFIBUS DP slave address, DP bus faults and diagnostics
- Two pushbuttons for switching over the operating state and for adopting the existing ACTUAL configuration as the DESIRED configuration

Functionality

Communication

DP/AS-Interface Link 20E enables a DP master to access all the slaves of an AS-Interface network.

DP/AS-Interface Link 20E occupies as standard 32 bytes of input data and 32 bytes of output data in which the digital I/O data of the connected AS-Interface slaves (standard and A/B slaves) of an AS-i line are stored.

The size of the input/output image can be compressed so that only the actually required I/O address area is occupied in the system of the DP master.

The analog I/O data can be accessed with the S7 system functions for read/write data record.

Configuration

The DP/AS-Interface Link 20E is configured as follows:

- With STEP 7 as of Version V5.1 SP2:
With STEP 7 configuring the AS-Interface configuration can be uploaded in STEP 7 V5.2 and higher. Can also be AS-Interface slaves from Siemens conveniently configure in HW Config (slave selection dialog).
- By adopting the ACTUAL configuration of the AS-Interface by the using the SET pushbutton on the front panel.
- Alternatively, DP/AS-Interface Link 20E can be integrated by means of the PROFIBUS GSD file in the engineering tool (e. g. for STEP 7 V5.1 and lower or for non-Siemens engineering tools).

Benefits



- Reduction of installation costs because the power supply comes completely from the AS-Interface cable, making an additional power supply superfluous

- Short start-up times through simple configuration at the press of a button
- Reduction of standstill and servicing times in the event of a slave failure thanks to the LED indicators
- Easy and fast start-up through reading out the AS-Interface configuration

Application

The DP/AS-Interface Link 20E is a PROFIBUS DP slave (according to IEC 61158/IEC 61784) and an AS-Interface master (according to IEC 62026-2). It enables the AS-Interface to be operated on PROFIBUS DP.

DP/AS-Interface Link 20E can operate up to 248 DI / 248 DO when using 62 A/B slaves with 4DI/4DO each.

PROFIBUS DP masters (DP-V0) can exchange I/O data with AS-Interface in cyclic mode.

PROFIBUS DP masters with acyclic services (DP-V1) are able in addition to initiate AS-Interface master calls (e. g. reading/writing the AS-i configuration during normal operation).

AS-Interface Network transitions

DP/AS-Interface Link 20E

Application (continued)

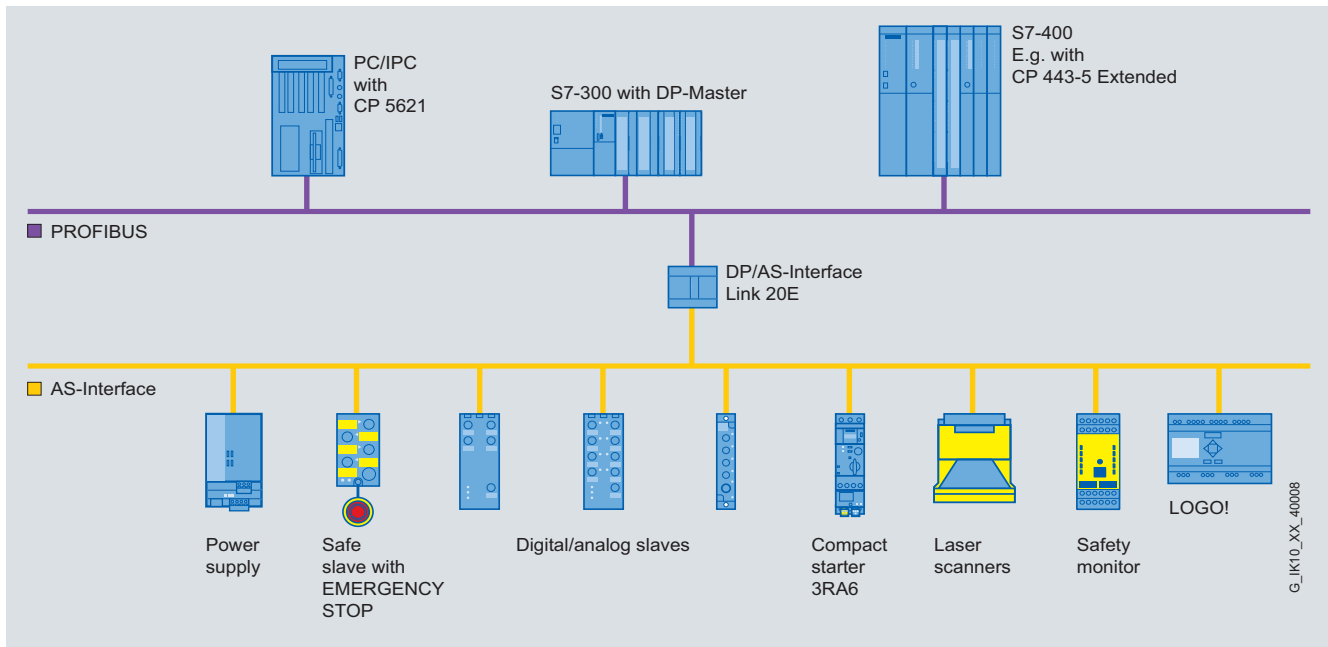

Transition from PROFIBUS DP to AS-Interface using DP/AS-Interface Link 20E

6

Selection and ordering data

Version	Screw terminals
	Order No.
 <p>DP/AS-Interface Link 20E Network transition between PROFIBUS DP and AS-Interface in degree of protection IP20; including screw terminals for connection of the AS-Interface cable; corresponds to AS-Interface Specification V3.0; dimensions (W x H x D / mm): 90 x 80 x 60 (dimensions without fixing lugs)</p> <p>6GK1 415-2AA10</p>	<p>6GK1 415-2AA10</p>
<p>Accessories</p> <p>PROFIBUS FC Standard Cable GP FastConnect standard type with special design for fast installation, 2-core, shielded</p>	<p>6XV1 830-0EH10</p>
<p>PROFIBUS FastConnect RS485 bus connectors with 90° cable feeder With insulation displacement connection the max. transmission rate is 12 Mbit/s. Activatable terminating resistor is integrated</p> <ul style="list-style-type: none"> • Without PG connection socket • With PG connection socket 	<p>6ES7 972-0BA52-0XA0 6ES7 972-0BB52-0XA0</p>
<p>PROFIBUS FastConnect RS485 bus connectors with angled cable feeder (35°) With insulation displacement connection the max. transmission rate is 12 Mbit/s. Activatable terminating resistor is integrated</p> <ul style="list-style-type: none"> • Without PG connection socket • With PG connection socket 	<p>6ES7 972-0BA60-0XA0 6ES7 972-0BB60-0XA0</p>
<p>PROFIBUS FastConnect Stripping Tool Preset stripping tool for speedy stripping of PROFIBUS FastConnect bus cables</p>	<p>6GK1 905-6AA00</p>

More information

The manuals are also available on the Internet at <http://support.automation.siemens.com/WWW/view/en/28602858/133300>

Overview



DP/AS-i F-Link

PN	DP-M	DP-S	ASi-M		
		●	●		

The DP/AS-i F-Link is a compact, safety-oriented network transition between PROFIBUS (DP Slave) and AS-Interface, with the following features:

- Monitoring the inputs of safety-oriented digital AS-i slaves (ASIsafe slaves) and forwarding of data through PROFIsafe. No additional safety-oriented components required for the AS-Interface (e. g. safety monitor)
- Can be used up to Category 4 according to EN 954-1, to PL e according to EN ISO 13849-1 and to SIL 3 according to IEC 62061/IEC 61508.
- Connection of up to 62 AS-Interface slaves
- Supports all AS-Interface master functions according to the AS-Interface Specification V3.0
- Typically easy transmission of non-safety-oriented input/output data of all AS-i slaves
- Integrated analog value transmission (all analog profiles)
- Direct integration in PROFIBUS networks.
Optional integration in PROFINET environments through PROFINET/PROFIBUS gateway (IE/PB Link PN IO) or through SIMATIC S7 315/317/319 F PN/DP or S7-416F-3 PN/DP
- Connection to ET 200S with IM-F-CPU using DP master module is possible
- Optimum TIA integration in STEP 7 using Object Manager, integration in non-Siemens engineering tools using PROFIBUS GSD file
- Local diagnostics using LEDs and display with control keys

Design

- Rugged, slim plastic enclosure, degree of protection IP20, for standard rail mounting or wall mounting (with adapter)
- Compact design:
 - LEDs in the front panel for indicating the operating state and functional readiness of all connected slaves
 - 2 buttons on the front for start-up and call up of diagnostics information
 - 4 LEDs for indication of the operating state of the device, of PROFIBUS DP and the AS-Interface network
 - Front PROFIBUS DP connection with sub D connector
 - Removable terminal blocks for connection of AS-i +/- and control supply voltage (over 24 V DC PELV power supply unit)
 - Narrow width (45 mm)
- Operation without fans and batteries
- Fast device replacement in the event of a fault

Functionality

Communication principle

The PROFIBUS DP master or the safe control communicates with the AS-Interface slaves over the DP/AS-i F-Link. The AS-Interface process data are mapped in different data areas for non-safety-oriented input and output data and safety-oriented input data.

Diagnostics

Extensive diagnostics is possible using the four LEDs, display and control keys or SIMATIC S7. Further details can be found in the manual.

Configuration

The DP/AS-i F-Link is configured as follows:

- With STEP 7 as of Version V5.4 SP1: In particular, Siemens AS-Interface slaves can be conveniently configured via the slave selection dialog.
- Uploading the actual configuration of an already configured AS-Interface network in a STEP 7 project is possible.
- Alternatively, DP/AS-i F-Link can be integrated by means of the PROFIBUS GSD file in the engineering tool
As a start-up aid, it is also possible to adopt the ACTUAL configuration in the appliance storage device directly on the appliance to activate the AS-interface slaves.

Programming

In contrast to the AS-Interface safety monitor, DP/AS-i F-Link is a pure gateway, which does not run through its own safety logic. Programming of the safety function is implemented at the level of the higher-level failsafe PLC, e. g.:

- With Distributed Safety, Version V5.4 SP1 or higher for SIMATIC S7-300F/416F
- With the SAFETY INTEGRATED "SI-Basic" or "SI-COMFORT NCU" Software for SINUMERIK 840D p/sl

The safety and standard range can access the digital and analog I/O data of the connected AS-Interface slaves directly through the I/O address area of the CPU.

AS-Interface

Network transitions

DP/AS-i F-Link

Benefits

get Designed for Industry

- Gaps in (bus-based) safety technology closed: safety-oriented signals (EMERGENCY-STOP, door tumbler, light curtains etc.) collected with AS-i and transferred to higher-level F-PLC. This enables:
 - Quick installation, easy commissioning: Use of AS-i virtues in the field now fully consistent for Safety Integrated
 - Cost-effective solution as ASIsafe is ideally suited for the collection of "fewer but more distributed failsafe bits".
- Price advantage: As a fully fledged AS-i master according to Specification V3.0, more input and outputs can be used, e. g.:
 - up to 248 DI / 248 DO when using 62 A/B slaves with 4DI/4DO each
 - up to 62 digital or analog slaves
- Investment protection:
 - Connection to PROFIBUS networks, such as DP/AS-i Link Advanced or DP/AS-Interface Link 20E
 - Downward compatibility to AS-Interface specification V2
 - Open for modern automation concepts with AS-i
- Teaching the code sequences of ASIsafe slaves is possible at the press of a button
- Reduced amount of engineering work thanks to user-friendly configuration of all AS-i slaves from Siemens using the slave selection dialog in HW-Config (STEP 7), including setting the F-parameter of the ASIsafe slaves modeled on PROFIsafe slaves
- Cost-savings thanks to programming of the safety logic with the familiar, powerful commands of the distributed safety packages from the failsafe SIMATIC PLC in F-FUP or F-FOP, incl. TUV-certified function blocks for typical safety applications
- Use in machine-tools under SINUMERIK 840 D (pl/sl) possible
- Reduction of standstill and servicing times in the event of a slave failure thanks to user-friendly diagnostics using the display and through simple module exchange (only a few settings by control keys are required, without use of the configuring tool)

Application

Links between PROFIsafe and ASIsafe

The DP/AS-i F-Link is a PROFIBUS DP-V1 slave (according to IEC 61508/ IEC 61784) and an AS-Interface master (based on AS-Interface Specification V3.0 according to IEC 62026-2). It enables transparent data access to AS-Interface from PROFIBUS DP. The DP/AS-i F-Link is also the only AS-i master with which safety-oriented input data can be passed from ASIsafe slaves via the PROFIsafe protocol to a failsafe CPU with PROFIBUS DP master. No additional safety cabling or monitoring is required (in particular no AS-Interface safety monitor). The transmission of binary values or analog values is possible depending on the slave type. All slaves according to AS-Interface Specification V2.0, V2.1 or V3.0 can be used as AS-i slaves.

PROFIBUS DP masters according to DP-V0 or DP-V1 can exchange I/O data with lower-level AS-i slaves in cyclic mode. PROFIBUS DP masters with acyclic services according to DP-V1 are able in addition to initiate AS-i command calls (e. g. reading/writing the AS-i configuration during normal operation). In addition to digital I/O data, analog data can also be saved permanently in the cyclic periphery of a failsafe S7-300/ S7-416 F-CPU.

In configuring mode the DP/AS-i F-Link reads in the configuration data of the peripherals on the AS-Interface. Slave addresses can be set using the display and the control keys, and the code sequences of safe AS-i slaves can be taught.

During operation, four display LEDs and the display provide detailed diagnostics information, which directly localizes the fault if required. Using the PLC user program it is possible to read out diagnostics data records and make them available to a higher-level operating and monitoring system (e. g. WinCC Flexible or TRANSLINE HMI).

Application (continued)

Network connectivity

The DP/AS-i F-Link can be used in PROFIBUS and PROFINET networks as follows:

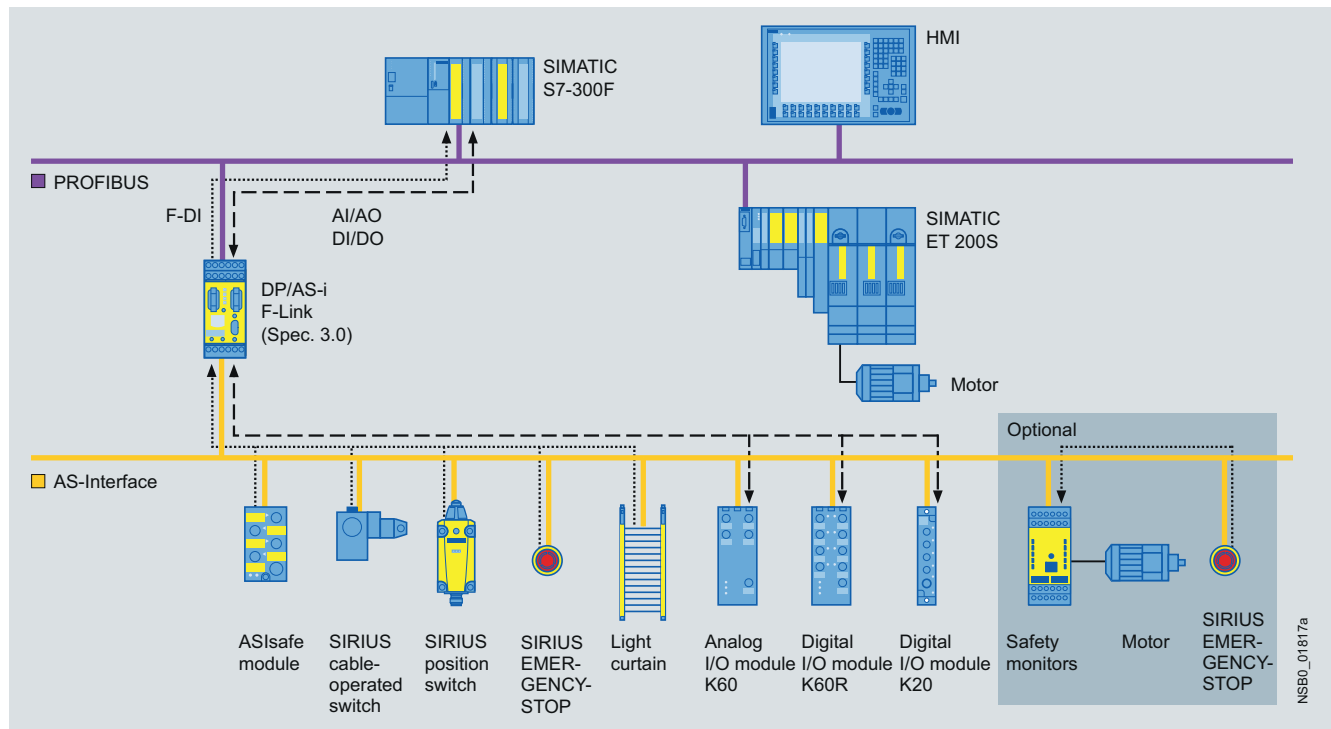

Integration in PROFIBUS networks under SIMATIC F PLC

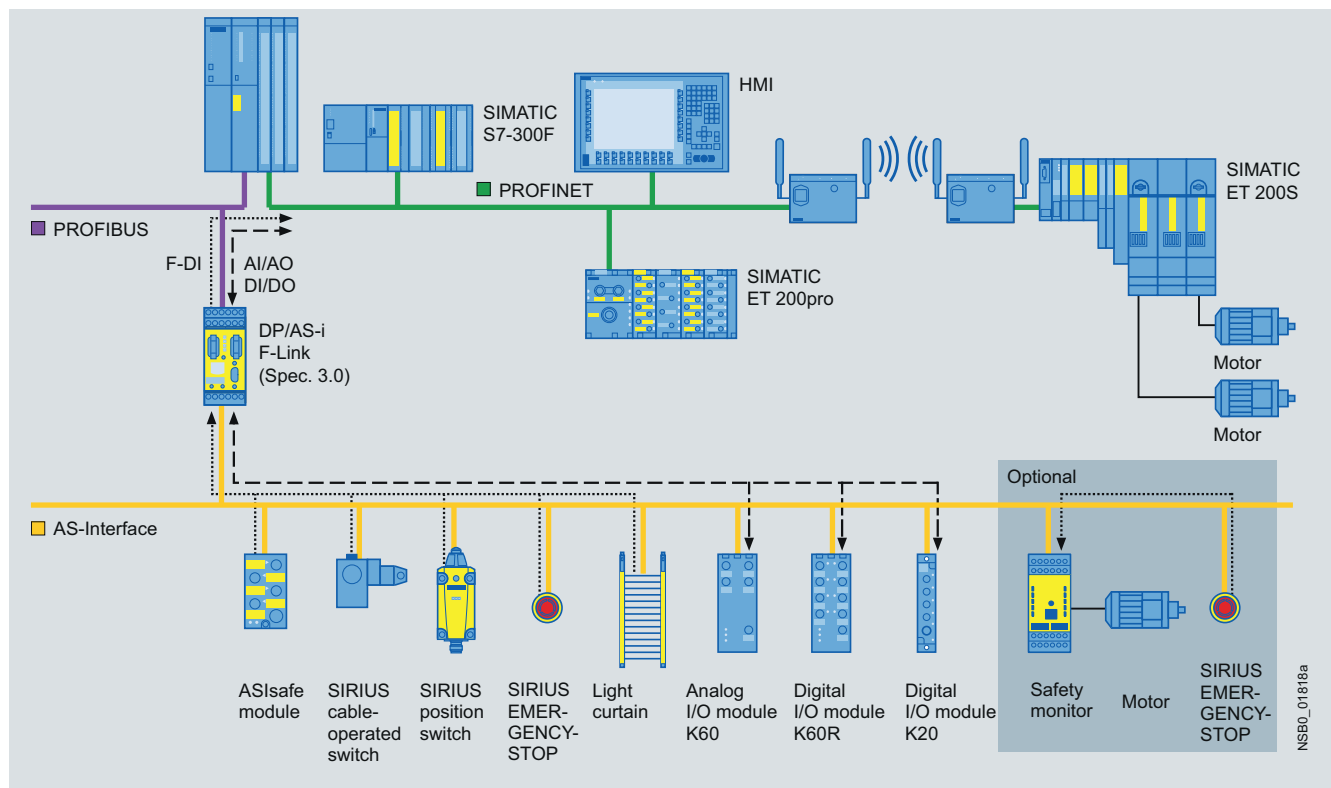

Integration in PROFINET networks under SIMATIC F-SPS (alternatively can also be integrated through IE/PB Link)

AS-Interface

Network transitions

DP/AS-i F-Link

Application (continued)

Further network connectivity options:

- Integration in PROFINET networks under SIMATIC F PLC through IE/PB Link
- Integration in SINUMERIK Power Line and Solution Line
- Integration under non-Siemens failsafe control systems using PROFIBUS GSD file, available on the Internet at <http://support.automation.siemens.com/WW/view/en/113250>

Selection and ordering data

Version		Order No.
	<p>DP/AS-i F-Link</p> <p>Network transition between PROFIBUS DP and AS-Interface for safety-oriented data transmission from ASIsafe to PROFIBUS DP – PROFIsafe in degree of protection IP20; corresponds to AS-Interface Specification V3.0; dimensions (W x H x D / mm): 45 x 104 x 120</p> <ul style="list-style-type: none"> • Screw terminals • Spring-type terminals 	<p>3RK3 141-1CD10</p> <p>3RK3 141-2CD10</p>

More information

More accessories for the PROFIBUS connection can be found on page 6/42.

The DP/AS-i F-Link manual is available at <http://support.automation.siemens.com/WW/view/en/24196041>

Circuit examples for safety systems with DP/AS-i F-Link are available at <http://support.automation.siemens.com/WW/view/en/24509484>

The F-Link Object Manager must be installed for configuring HW-Config (STEP 7). The Object Manager can be downloaded free of charge from the Internet at <http://support.automation.siemens.com/WW/view/en/24724923>

Overview



IE/AS-i LINK PN IO

PN	DP-M	DP-S	ASi-M		
●			●		

The IE/AS-i LINK PN IO is a compact network transition between PROFINET/Industrial Ethernet (PROFINET IO Device) and AS-Interface, with the following features:

- Single and double AS-Interface master (according to AS-Interface Specification V3.0) for connection of 62 AS-Interface slaves or 124 AS-Interface slaves (with a double master)
- Integrated analog value transmission (all analog profiles)
- Integrated ground-fault monitoring for the AS-Interface cable
- User-friendly local diagnostics and start-up by means of a full graphic display and control keys or through a web interface with a standard browser on the PC screen
- Optimum TIA integration using STEP 7
- Integration in non-Siemens engineering tools using the PROFINET GSD file
- Vertical integration (standard web interface) through Industrial Ethernet
- Supply via AS-Interface cable or with 24 V DC
- Suitable for AS-i Power24V (product version 2 and higher / firmware version 2.0.20) and standard AS-i (30 V)
- Module exchange without entering the connection parameters (IP address etc.) using C-PLUG (optional)
- Costs saved by the double AS-Interface master when large volumes of project data are involved

Design

- Compact plastic enclosure in degree of protection IP20 for standard rail mounting
- COMBICON plug-in screw terminals
- Compact design:
 - Pixel graphics display in the front panel for detailed indication of the operating state and readiness for operation of all connected AS-Interface slaves
 - Six pushbuttons for starting up and testing the AS-Interface line directly on the IE/AS-i LINK PN IO
 - LED indication of the operating state of PROFINET IO and AS-Interface
 - Integrated 2-port switch (RJ45 socket) for connection to Industrial Ethernet supports the line topology with an external switch
- Small mounting depth thanks to recessed plug mounting
- Operation without fans and batteries

Functionality

Communication

The IE/AS-i LINK PN IO enables a PROFINET IO controller to cyclically access the I/O data of all the slaves of a lower-level AS-Interface segment. Also supported are the expanded slave types with higher I/O data volume according to AS-i Specification V3.0.

The IE/AS-i LINK PN IO occupies the following address area:

- As a single master or IO controller with full expansion: 62 bytes of input data and 62 bytes of output data in which the I/O data of the connected AS-Interface slaves (standard and A/B slaves) of an AS-i line are stored.
- As double master, double the number of bytes.

The size of the input/output image can be compressed so that only the actually required I/O address area is occupied in the system of the DP master.

The integrated evaluation of analog signals is just as easy as access to digital values because the analog process data also lie directly in the I/O address area of the CPU.

PROFINET IO controllers are able in addition to initiate AS-Interface master calls (e. g. to write parameters, change addresses, read diagnostic values) through the acyclic PROFINET services.

Using an operating display in AS-Interface Link it is possible to fully commission the lower-level AS-i line.

The IE/AS-i LINK PN IO is equipped with two Ethernet ports which are connected by an internal switch. With the Ethernet it is possible in addition to use the integrated web server. The web server can be called up with any standard web browser (e. g. Internet Explorer) without additional software. It enables the PC to present all diagnostics information and to display the set bus configuration and parameters as well as their adaptation where applicable. Firmware updates are also possible using this port.

The optional C-PLUG supports module exchange without entering the connection parameters (IP address etc.), keeping downtimes to a minimum in the event of a fault.

Diagnostics

The following diagnostics is possible using the display and control keys, web interface or STEP 7:

- Operating state of the E/AS-i LINK PN IO
- Status of the link as a PROFINET IO device
- Diagnostics of the AS-Interface network
- Message frame statistics
- Standard diagnostics pages in the web interface for fast diagnostics access through Ethernet using a standard browser
- For the use of the web interfaces are no network settings on the PC necessary (Zeroconf procedure).
- The reporting of diagnostic events is optional via E-Mail or SNMP Trap possible. The integrated diagnostic buffer saves the events including time stamp.

Configuration

The IE/AS-i LINK PN IO is configured as follows:

- STEP 7 V5.4 or higher is required for configuring the full functional scope of the IE/AS-i LINK PN IO. With STEP 7 configuring the AS-Interface configuration can be uploaded in STEP 7 V5.4 SP2 and higher. Can also be AS-Interface slaves from Siemens conveniently configure in HW Config (slave selection dialog).
- Alternatively, E/AS-i LINK PN IO can be integrated by means of the PROFINET GSD file in the engineering tool (e. g. for STEP 7 V5.4 SP2 and lower or for non-Siemens engineering tools).

AS-Interface Network transitions

IE/AS-i LINK PN IO

Benefits



- Short start-up times through simple configuration at the press of a button and testing of the AS-Interface line using the display or web interface
- Reduction of standstill and servicing times in the event of a slave failure thanks to user-friendly diagnostics using the display or web interface

- Costs saved by the double AS-Interface master when large volumes of project data are involved
- Saves the need for AS-i power pack with AS-i Power24V: The AS-Interface cable assembly is fed through an existing 24 V DC PELV power pack. For decoupling an AS-i data decoupling module is required, see power supply units and data decoupling modules.
- Standard mode with AS-Interface power supply (see power supply units and data decoupling modules) possible without restrictions, whereby no further operating voltage is required

Application

The DP/AS-i LINK PN IO is a PROFINET IO device (according to IEC 61158/IEC 61784) and an AS-Interface master (based on AS-Interface Specification V3.0 according to IEC 62026-2). It enables transparent data access to AS-Interface from Industrial Ethernet.

Exchanging data with PROFINET IO controllers

PROFINET IO controllers can exchange I/O data with AS-Interface in cyclic mode and can perform AS-i master calls in addition with acyclic services (e. g. reading/writing the AS-i configuration during normal operation). As such, the IE/AS-i LINK PN IO is particularly well suited for a decentral construction and for connection of a lower-level AS-Interface network.

Single masters

For applications with typical volumes of project data it is sufficient to use the IE/AS-i LINK PN IO in its version as an AS-i single master. The single master can operate up to 248 DI/248 DO, using 62 A/B slaves with 4DI/4DO each.

Double masters

For applications with large volumes of project data the IE/AS-i LINK PN IO in its version as an AS-i double master is used. In this case, twice the volume of project data can be used on two AS-i lines running independently of each other. The double master can operate up to 496 DI/496 DO, using 2 AS-i networks with 62 A/B slaves each with 4DI/4DO each.

6

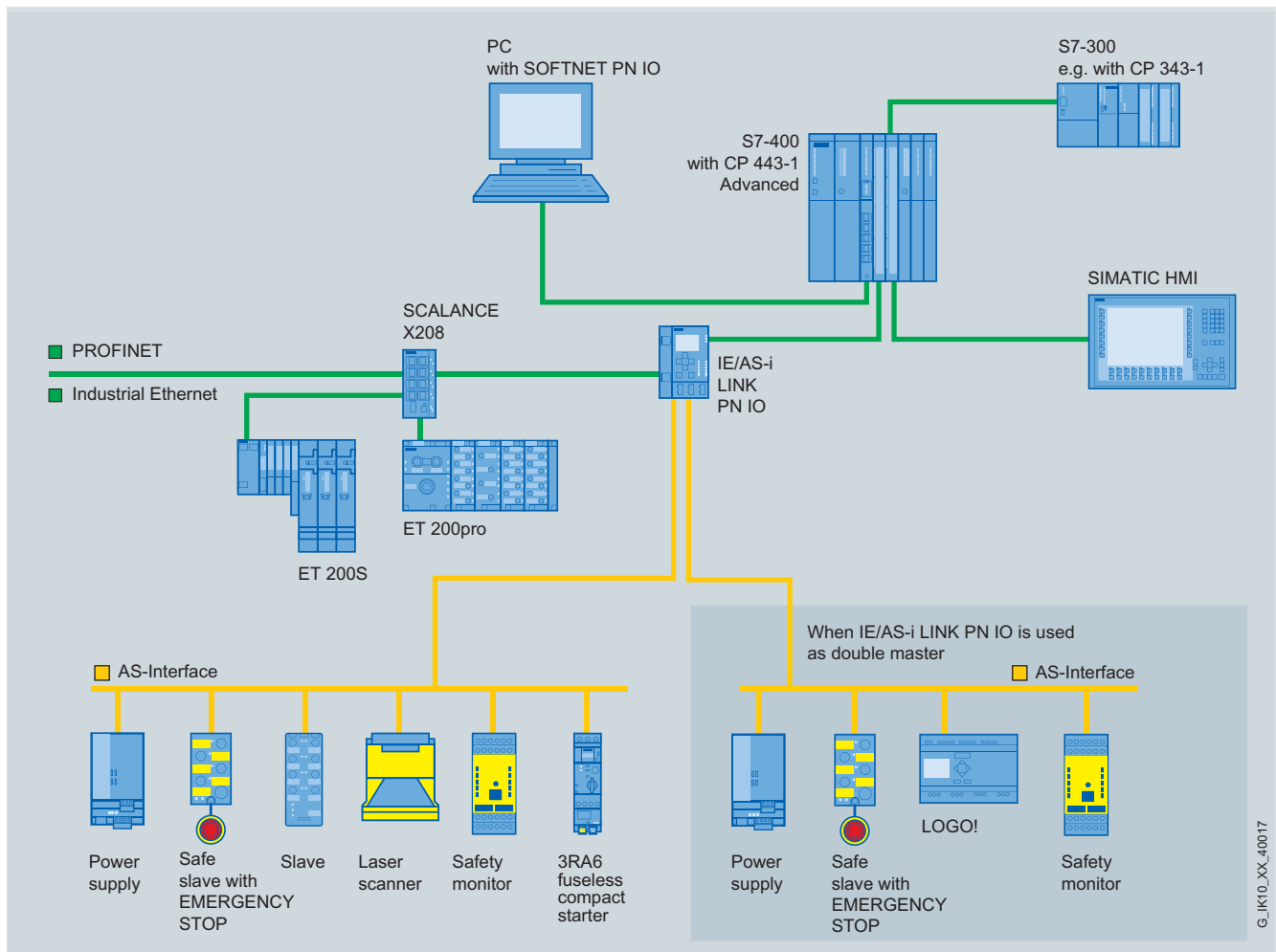

Integration of AS-Interface on PROFINET through IE/AS-i LINK PN IO as single/double master

Application (continued)

Wireless communication

Using an upstream IWLAN client module, e. g. SCALANCE W746-1PRO, an AS-Interface line can be integrated in the PROFINET world by wireless means.

Sample uses are applications which up to now have been performed with fault-prone tow chain or collector wire technology. Maintenance costs are thus reduced.

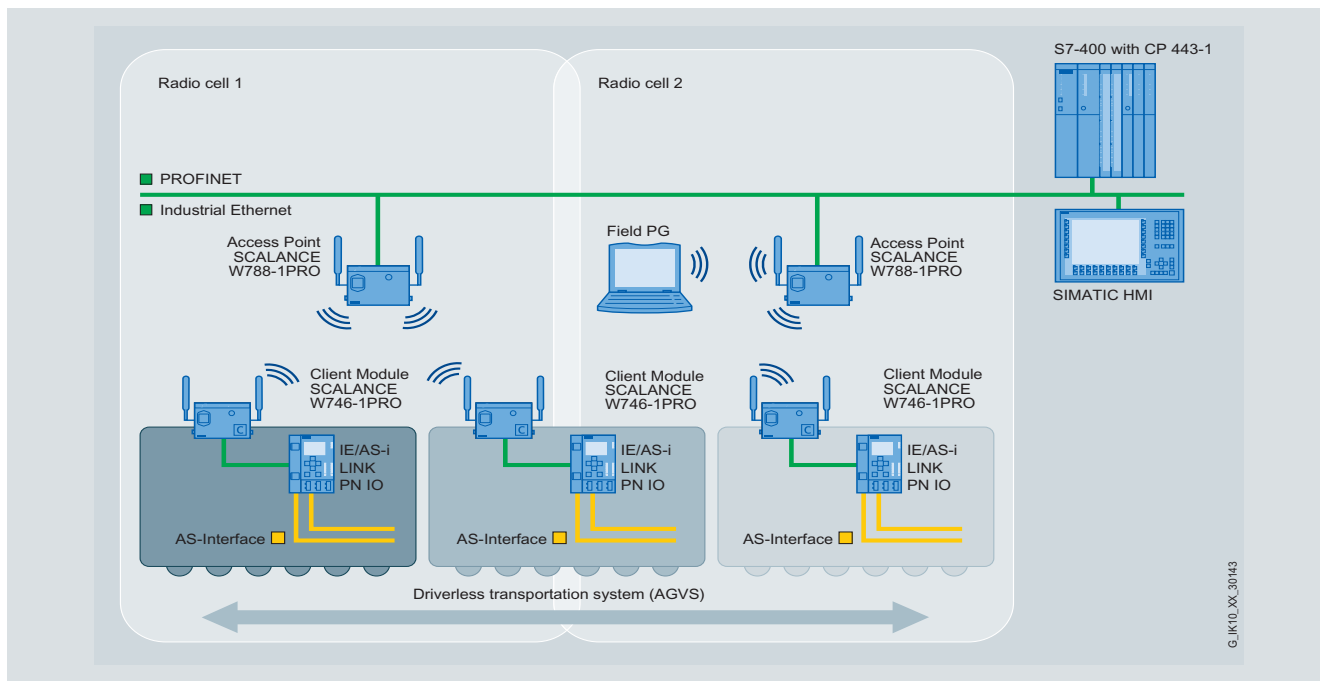

Wireless communication between Industrial Ethernet and AS-Interface components



Selection and ordering data

Version		Combicon connection Order No.
 IE/AS-i LINK PN IO <i>Accessories</i>	IE/AS-i LINK PN IO Network transition between PROFINET/Industrial Ethernet and AS-Interface in degree of protection IP20; including COMBICON plug-in screw terminals for connection of an AS-Interface cable (two AS-Interface cables for double masters) and the optional 24 V supply; corresponds to AS-Interface Specification 3.0; dimensions (W x H x D / mm): 90 x 132 x 88.5 <ul style="list-style-type: none"> • Single master with display • Double master with display 	6GK1 411-2AB10 6GK1 411-2AB20
	C-PLUG Exchange medium for the simple exchange of devices in the event of a fault; for accommodating configuration and application data; can be used in SIMATIC NET products with a C-PLUG slot	6GK1 900-0AB00
	IE FC RJ45 Plug 90 RJ45 plug-in connector for Industrial Ethernet, with robust metal enclosure and integrated cutting and clamping contacts for connection of Industrial Ethernet FC installation cables; with 90° cable feeder <ul style="list-style-type: none"> • 1 pack = 1 units • 1 pack = 10 units • 1 pack = 50 units 	6GK1 901-1BB20-2AA0 6GK1 901-1BB20-2AB0 6GK1 901-1BB20-2AE0

More information

The manuals are available on the Internet at <http://support.automation.siemens.com/WWW/view/en/29992487/13330>

AS-Interface slaves

I/O modules for operation in the field, high degree of protection

Digital I/O modules, IP67 - Introduction

Overview



K60



K20

Three coordinated series of AS-Interface compact modules with digital and analog compact modules and a high degree of protection are available for operation in the field:

- Series K60 (digital and analog)
- Series K45 (digital)
- Series K20 (digital)

All compact modules are characterized by particularly simple handling. The K60 and K45 modules are mounted with a mounting plate. The mounting plate is used to receive the AS-Interface flat cables and enables mounting on a wall or standard mounting rail.

The K20 modules are directly mounted without a mounting plate and connected to the AS-Interface using a round cable.



K45

Connection types

For flexible connection of different sensors and actuators, the following PIN assignments are available on the I/O modules with M12 sockets:

Standard assignment

With the standard assignment, one sensor/actuator is connected per M12 socket. In this case the signal for the outputs is at PIN4 while the signal for the inputs is detected at PIN4 and PIN2. As the result, sensors can be connected directly to PIN2 and PIN4.

Y assignment

With the Y assignment, two sensors or two actuators can be connected to one M12 socket. In this case, both PIN4 and PIN2 are provided for respectively one sensor/actuator signal on each M12 socket.

Y-II assignment

The Y-II assignment offers the following options:

- Individual connection of a sensor/actuator to one M12 socket
- Connection of respectively two sensors/actuators to one M12 socket as follows:
 - The signal of the first sensor/actuator is connected to PIN4 of the first socket.
 - The signal of the second sensor/actuator is connected to PIN2 of the first socket and to PIN4 of the second socket. In this case, the second socket is not required and is closed with a sealing cap.

Overview of digital compact modules

The following table provides an overview of the important features of the digital compact modules.

Version	K60	K45	K20
8 inputs/2 outputs	✓	--	--
8 inputs	✓	--	--
4 inputs/4 outputs	✓	✓	✓
4 inputs/3 outputs	✓	--	--
4 inputs/2 outputs	✓	--	--
4 inputs	✓	✓	✓
2 inputs/2 outputs	--	✓	✓
4 outputs	✓	✓	✓
3 outputs	--	✓	--
AS-Interface connection	Flat cable / round cable	Flat cable	Round cable
I/O connection method	M12	M12/M8	M12/M8
Pin assignment	Standard/Y-II/Y	Standard/Y	Standard/Y
Degree of protection	IP65/IP67/IP68/IP69K	IP65/IP67	IP65/IP67
ATEX 3D (Zone 22)	✓	--	--
Extended address mode	✓	✓	✓

✓ Available

-- Not available

Overview

The K60 digital AS-Interface compact modules are characterized by optimized handling characteristics and user-friendliness. They permit the mounting times and start-up times of AS-Interface to be reduced by up to 40 %.

Assembly of the K60 modules is performed with a mounting plate which accommodates the AS-Interface shaped cables. Two different mounting plates are offered for

- Wall mounting
- Standard rail mounting

Addressing of the K60 modules is performed using an addressing socket integrated in the compact module. The addresses can also be assigned after installed.

K60 compact modules with a maximum of four digital inputs and outputs

These compact modules contain the communication electronics and the M12 standard connections for inputs and outputs. Using M12 standard connectors, a maximum of four sensors and four actuators can be simply and reliably connected to the compact module.

The mounting plate and the compact module are joined together by means of a screw, with simultaneous contacting of the AS-Interface cable by the service-proven insulation piercing method.

K60 compact modules with a maximum of eight digital inputs

These modules have eight digital inputs for connection through M12 plugs.

The module requires two AS-Interface addresses for processing all eight inputs. As with every compact module, the addressing can be performed through a double addressing socket.

K60 compact modules with a four digital inputs and outputs according to AS-Interface Specification 3.0

The new AS-i specification 3.0 adds a number of completely new features to the AS-Interface bus system. The extended address mode (A/B addresses) enables the connection of up to 62 slaves on one AS-i network. With the extended address mode according to Specification 3.0, four outputs are now possible even with A/B slaves (instead of only three outputs possible up to now with specification 2.1). Hence with full expansion of an AS-i network, there are now 248 inputs as well as 248 outputs available on one AS-i system. Modules with four inputs and four outputs as A/B slaves according to Specification 3.0 are also available as K60 compact modules.

Please note that these modules can be used only with a new master according to AS-i specification 3.0 (e.g. the new DP/AS-i LINK Advanced or IE/AS-i LINK PN IO) and that the cycle times for the outputs can extend to max. 20 ms.

K60 data couplers

An AS-Interface data coupler has been added to the K60 compact module range. Integrated in this module are two AS-i slaves which are connected to two different AS-i networks. Each of the two integrated slaves has four virtual inputs and four virtual outputs. The bidirectional data transmission of four data bits between two AS-i networks is thus possible in a simple and cost-effective manner. The data coupler need its own address in each AS-i network.

Each AS-i network works with a different cycle time depending on the number of stations. Hence two AS-i networks are not necessarily synchronous. For this reason the AS-i data coupler can be used to transmit only standard data and no safe data.

K60 compact modules for use in hazardous areas (ATEX)

Two versions of the K60 modules are available for operation in Zone 22 hazardous areas according to Classification II 3D (dusty atmosphere, non-conductive dust). The version with four inputs and four outputs has the designation (Ex) II 3D Ex tD A22 IP65X T75°C and the version with four inputs has the designation (Ex) II 3D Ex tD A22 IP65X T60°C.

Special conditions have to be observed for the safe operation of these devices. In particular the module must be protected by suitable protective measures from mechanical damage.

More information

Other conditions for safe operation see section Technical Information at

www.siemens.com/industrial-controls/support

AS-Interface slaves

I/O modules for operation in the field, high degree of protection

Digital I/O modules, IP67 - K60

Selection and ordering data

Version	Order No.					
 3RK1 400-1DQ00-0AA3	Digital I/O modules, IP67 – K60 <ul style="list-style-type: none"> • PNP transistor • Width 60 mm • Connection method: M12 • Modules supplied without mounting plate 					
	Type	Current carrying capacity of outputs	Slave type	Pin assignment	Sensor power supply off	
	8 inputs/ 2 outputs	2 A	A/B	Special	AS-i	3RK2 400-1HQ00-0AA3
	8 inputs	--	Standard	Y-II	AS-i	3RK1 200-0DQ00-0AA3
		--	A/B	Y-II	AS-i	3RK2 200-0DQ00-0AA3
		--	A/B	Y-II	U_{aux}	3RK2 200-1DQ00-1AA3
	4 inputs/ 4 outputs	2 A	Standard	Y-II	AS-i	3RK1 400-1DQ00-0AA3
		2 A	Standard	Standard	AS-i	3RK1 400-1CQ00-0AA3
		1 A	Standard	Y-II	AS-i	3RK1 400-1DQ01-0AA3
		1 A	Standard	Standard	AS-i	3RK1 400-1DQ03-0AA3
		2 A	A/B slave (Spec. 3.0)	Y-II	AS-i	3RK2 400-1DQ00-0AA3
	4 inputs/ 3 outputs	2 A	A/B slave (Spec. 3.0)	Y-II	U_{aux}	3RK2 400-1DQ00-1AA3
		2 A	A/B	Y-II	AS-i	3RK2 400-1FQ03-0AA3
	4 inputs/ 2 outputs	2 A	Standard	Y-II	AS-i	3RK1 400-1MQ00-0AA3
	4 inputs	--	Standard	Y-II	AS-i	3RK1 200-0CQ00-0AA3
	2x2 inputs/ 2x2 outputs	1 A	Standard	Y	AS-i	3RK1 400-1DQ02-0AA3
4 outputs	2 A	Standard	Y-II	AS-i	3RK1 100-1CQ00-0AA3	
Digital I/O modules IP67 – K60, version ATEX (Ex) II 3D Ex tD A22 IP65X T75°C/60°C <ul style="list-style-type: none"> • PNP transistor • Width 60 mm • Current carrying capacity of the inputs: 200 mA • Connection method: M12 • Modules supplied without mounting plate 						
Type	Current carrying capacity of outputs	Slave type	Pin assignment			
4 inputs/ 4 outputs	2 A	Standard	Y-II		3RK1 400-1DQ05-0AA3	
4 inputs	--	Standard	Y-II		3RK1 200-0CQ05-0AA3	
Digital I/O modules IP67 – K60 data couplers <ul style="list-style-type: none"> • Modules supplied without mounting plate 						
Type	Current carrying capacity of outputs	Slave type	Pin assignment			
Data coupler 4 inputs/ 4 outputs (virtual)	--	Standard	--		3RK1 408-8SQ00-0AA3	

Accessories



K60 mounting plates

Suitable for all K60 compact modules

- Wall mounting
- Standard rail mounting

3RK1 901-0CA00
3RK1 901-0CB01



AS-Interface sealing caps M12

For free M12 sockets

3RK1 901-1KA00



AS-Interface sealing caps M12, tamper-proof

For free M12 sockets

3RK1 901-1KA01



Sealing sets

- For K60 mounting plate and standard distributor
- Cannot be used for K45 mounting plate
- One set contains one straight and one shaped seal

3RK1 902-0AR00

AS-Interface slaves

I/O modules for operation in the field, high degree of protection

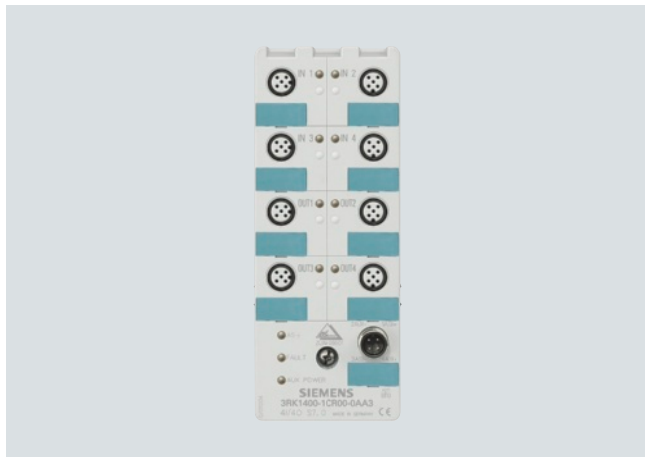
Digital I/O modules IP68/IP69K - K60R
Overview
Operation in particularly harsh environments

K60R module in degree of protection IP68/IP69K

Modules with degree of protection IP67 cannot be used in areas exposed to permanently high levels of humidity, in applications with drilling emulsions and cutting oils or when cleaning with high-pressure cleaners. The answer for these applications is provided by the expansion of the K60 compact modules with the K60R module with degree of protection IP68/IP69K.

The K60R modules are connected instead of the AS-Interface flat cable using a round cable with M12 cable box. The AS-Interface bus cable and the 24 V DC auxiliary voltage supply are routed in this case in a shared round cable.

Degree of protection IP68 permits many new applications, which were impossible with the former field modules with degree of protection IP67. In applications such as filling plants or machine-tools the K60R with degree of protection IP68 enables the module to be used directly in zones exposed to permanent loading by humidity. It is thus possible to make even more rigorous savings in wiring with AS-Interface. The IP68 test conditions can be found in the section "IP68/IP69K tests".

Cleaning with high-pressure cleaners, such as is regularly performed in the food drinks industry for instance, is possible without difficulty (IP69K).

In applications with tow chains, many users rely on placing the AS-Interface bus cable in a round cable. With the K60R module there is a round cable connection for direct connection to a round cable. No adapter is required.

Mounting

The same mounting plates are used as for the K60 modules. Instead of using flat cables the K60R is connected using a 4-pole round cable with an M12 connection. With the K60R the mounting plate thus serves only as a fixture and ground terminal.

Addressing

Addressing is performed using the same socket as for the bus connection. Connecting the module to the addressing unit takes place over a 3-pole standard M12 cable.

When the mounting is finished, the module is connected with the addressing cable to the addressing unit and addressed. The addressing cable is then removed and the module connected to the bus cable.

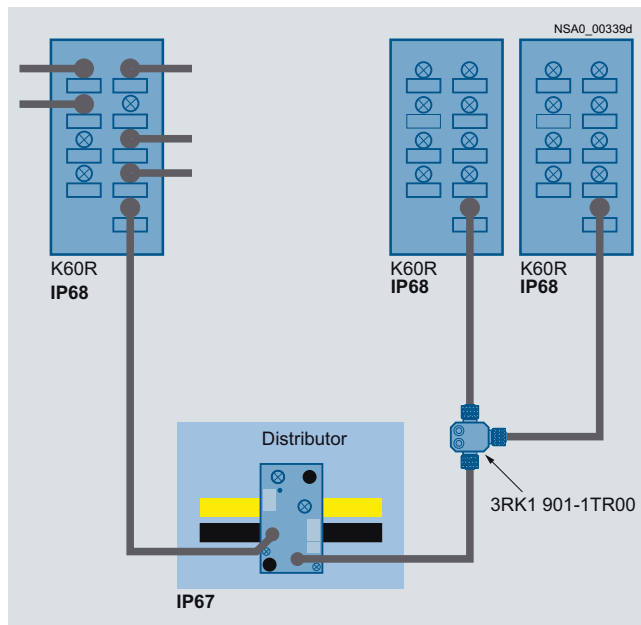
Connection

K60R connection options

In the IP67 environment the service-proven standard components are connected using flat cables. Spur lines are laid into the IP68 environment by means of an AS-Interface M12 feeder (3RK1 901-1NR...). The module is connected with a round cable to an M12 cable box. For this purpose the module has an M12 bus connection instead of the former addressing socket. The AS-Interface bus cable and the 24 V DC auxiliary voltage are routed together in a 4-pole round cable. There must be no ground conductor in this round cable. Connection to ground is made through the mounting plate.

In the IP68 environment only cables with extruded M12 plugs may be used.

To connect more than one K60R module to one spur line, the spur line can be split again using a T distributor (3RK1 901-1TR00) with degree of protection IP68.

Please note the following boundary conditions:

- The configuration guidelines for AS-Interface apply. For all M12 connecting cables the maximum permissible current is limited to 4 A. The cross-section of these cables amounts to just 0.34 mm². For connection of the K60R modules, the aforementioned M12 connecting cables can be used for the spur lines. The voltage drop caused by the ohmic resistance (approx. 0.11Ω/m) must be taken into account.
- For round cable connections with shared AS-i and U_{aux} in a single cable, the following maximum lengths apply:
 - per spur line from feeder to module: maximum 5 m
 - total of all round cable segments in an AS-Interface network: maximum 20 m

Tests IP68/IP69K

- K60R modules were tested with the following tests:
- Stricter test than IP67: 90 min at 1.8 m depth of water (IP67: 30 min at 1 m depth of water)
- Salt water test: Five months in salt water, 20 cm deep, at room temperature
- Test with particularly creepable oil: Five months completely under oil at room temperature

AS-Interface slaves

I/O modules for operation in the field, high degree of protection

Digital I/O modules IP68/IP69K - K60R

Overview (continued)







- Test with drilling emulsion: Five months at room temperature (components of the drilling emulsion: Anionic and non-ionic emulsifiers, paraffinic low-aromatic mineral oil, boric acid alkanolamines, corrosion inhibitors, oil content 40 %)
- Test in oil bath (Excelence 416 oil) with alternating oil bath temperature: 130 cycles of 15 to 55 °C, two months
- Cleaning with a high-pressure cleaner according to IP69K: 80 to 100 bar, 10 to 15 cm distance, time per side > 30 s, water temperature 80 °C

To simulate requirements as realistically as possible the modules were artificially aged prior to the tests by 15 temperature cycles of -25/+85 °C. During the test the modules were connected to 3RX1 connecting cables. Unassigned connections were closed with 3RK1 901-1KA00 sealing caps.

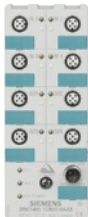
Note:

Sealing caps and M12 connections must be tightened with the correct torque.

Selection and ordering data

Version	Order No.																				
 <p>Digital I/O modules IP68/IP69K – K60R</p> <ul style="list-style-type: none"> • 4 inputs/4 outputs • Width 60 mm • IP68/IP69K • Standard assignment • Current carrying capacity: <ul style="list-style-type: none"> - 200 mA (inputs) - 2 A (outputs) • Standard slave • Modules supplied without mounting plate 	3RK1 400-1CR00-0AA3																				
<p>Accessories</p>  <p>K60 mounting plates Suitable for all K60 and K60R compact modules</p> <ul style="list-style-type: none"> • Wall mounting • Standard rail mounting 	3RK1 901-0CA00 3RK1 901-0CB01																				
 <p>AS-Interface sealing caps M12 For free M12 sockets</p>	3RK1 901-1KA00																				
 <p>AS-Interface M12 feeders</p> <table border="1"> <thead> <tr> <th>For flat cable</th> <th>For</th> <th>Cable length</th> <th>Cable end in feeder</th> <th></th> </tr> </thead> <tbody> <tr> <td>AS-i / U_{aux}</td> <td>M12 socket</td> <td>--</td> <td>Not available</td> <td>3RK1 901-1NR20</td> </tr> <tr> <td>AS-i / U_{aux}</td> <td>M12 cable box</td> <td>1 m</td> <td>Not available</td> <td>3RK1 901-1NR21</td> </tr> <tr> <td>AS-i / U_{aux}</td> <td>M12 cable box</td> <td>2 m</td> <td>Not available</td> <td>3RK1 901-1NR22</td> </tr> </tbody> </table>	For flat cable	For	Cable length	Cable end in feeder		AS-i / U_{aux}	M12 socket	--	Not available	3RK1 901-1NR20	AS-i / U_{aux}	M12 cable box	1 m	Not available	3RK1 901-1NR21	AS-i / U_{aux}	M12 cable box	2 m	Not available	3RK1 901-1NR22	
For flat cable	For	Cable length	Cable end in feeder																		
AS-i / U_{aux}	M12 socket	--	Not available	3RK1 901-1NR20																	
AS-i / U_{aux}	M12 cable box	1 m	Not available	3RK1 901-1NR21																	
AS-i / U_{aux}	M12 cable box	2 m	Not available	3RK1 901-1NR22																	
 <p>AS-Interface M12 feeders, 4-fold</p> <table border="1"> <thead> <tr> <th>For flat cable</th> <th>For</th> <th>Cable length</th> <th>Cable end in feeder</th> <th></th> </tr> </thead> <tbody> <tr> <td>AS-i / U_{aux}</td> <td>4-fold M12 socket delivery includes coupling module</td> <td>--</td> <td>Available</td> <td>3RK1 901-1NR04</td> </tr> </tbody> </table>	For flat cable	For	Cable length	Cable end in feeder		AS-i / U_{aux}	4-fold M12 socket delivery includes coupling module	--	Available	3RK1 901-1NR04											
For flat cable	For	Cable length	Cable end in feeder																		
AS-i / U_{aux}	4-fold M12 socket delivery includes coupling module	--	Available	3RK1 901-1NR04																	
 <p>M12-T distributors</p> <ul style="list-style-type: none"> • IP68 • 1 x M12 plug • 2 x M12 box 	3RK1 901-1TR00																				
 <p>M12 connecting cables</p> <ul style="list-style-type: none"> • 3-pole • For addressing AS-i slaves with M12 bus connection • Cable length 1.5 m 	3RK1 902-4PB15-3AA0																				

Overview



K45 compact modules

The K45 series of compact modules supplements the K60 large compact modules which have a proven track record in industry. They are the logical consequence for rounding off the bottom end of the existing product range.

The acclaimed advantages of the existing K60 compact modules are fully emulated by the far smaller K45 modules. Their footprint is the same as that of the user modules. However, they have a mounting depth which is only two-thirds of the user module and hence an exact match for the compact module family.

Yet in spite of these small dimensions all the modules have large labels and an integrated addressing socket.

Two mounting plates are offered for the K45 compact modules:

- The mounting plate for wall mounting has a hole pattern that is identical to that of the K60 compact modules. This means that K60 compact modules can be mounted together with K45 modules in an aligned arrangement. The flat cables can be inserted in the recesses of the mounting plates where they cause no hindrance.
- The mounting plate for standard rail mounting has a hole pattern that is identical to that of the user modules.

Mounting the flat cables is now easier than ever. The yellow and black AS-Interface flat cable can be inserted into the mounting plates from the left or right regardless of the position of the coding lug. The correct polarity of the applied voltages is always guaranteed.

Sensors/actuators are connected using M12 sockets. The 4I module can be ordered optionally with M8 connection sockets.

AS-Interface slaves

I/O modules for operation in the field, high degree of protection

Digital I/O modules, IP67 - K45

Selection and ordering data

Version						Order No.
 <p>Digital I/O modules, IP67 – K45</p> <ul style="list-style-type: none"> • PNP transistor • Width 45 mm • Current carrying capacity of the inputs: 200 mA • Modules supplied without mounting plate 						
Type	Current carrying capacity of outputs	Slave type	Pin assignment	U_{aux} 24 V	Connection methods	
4 inputs	--	Standard	Standard	--	M12	3RK1 200-0CQ20-0AA3
	--	Standard	Standard	--	M8 screw	3RK1 200-0CT20-0AA3
	--	Standard	Standard	--	M8 snap	3RK1 200-0CU20-0AA3
	--	A/B	Standard	--	M12	3RK2 200-0CQ20-0AA3
	--	A/B	Standard	--	M8 screw	3RK2 200-0CT20-0AA3
	--	A/B	Standard	--	M8 snap	3RK2 200-0CU20-0AA3
2 x 2 inputs	--	A/B	Y	--	M12	3RK2 200-0CQ22-0AA3
2 inputs/ 2 outputs	2 A ¹⁾	Standard	Standard	✓	M12	3RK1 400-1BQ20-0AA3
2 x (1 input/ 1 output)	0.2 A	Standard	Y	--	M12	3RK1 400-0GQ20-0AA3
4 x (1 input/ 1 output)	0.2 A	A/B (Spec. 3.0)	Y	--	M12	3RK2 400-0GQ20-0AA3
4 x (1 input/ 1 output)	0.5 A	A/B (Spec. 3.0)	Y	✓	M12	3RK2 400-1GQ20-1AA3
3 outputs	1 A	A/B	Standard	✓	M12	3RK2 100-1EQ20-0AA3
4 outputs	1 A	Standard	Standard	✓	M12	3RK1 100-1CQ20-0AA3
2 outputs/ 2 inputs	2 A	A/B	Standard	✓	M12	3RK2 400-1BQ20-0AA3
✓ Available -- Not available						

Accessories

 <p>3RK1 901-2EA00</p>	<p>K45 mounting plates</p> <ul style="list-style-type: none"> • For wall mounting • For standard rail mounting 	<p>3RK1 901-2EA00 3RK1 901-2DA00</p>
 <p>3RK1 901-1KA00</p>	<p>AS-Interface sealing caps</p> <ul style="list-style-type: none"> • For free M12 sockets • For free M8 sockets 	<p>3RK1 901-1KA00 3RK1 901-1PN00</p>
 <p>3RK1 901-1PN00</p>	<p>Cable terminating pieces For sealing of open cable ends (shaped AS-Interface cable) in IP67</p>	<p>3RK1 901-1MN00</p>
 <p>3RK1 901-1MN00</p>		

¹⁾ The typical current carrying capacity per output increases with version "E12" from 1.5 to 2 A (available since approx. 07/2003).

AS-Interface slaves

I/O modules for operation in the field, high degree of protection

Digital I/O modules IP67 - K20
Overview

Digital I/O modules IP67 – K20

The K20 compact module range rounds off the AS-Interface compact modules with a particularly slim design and a width of a mere 20 mm. Thanks to its extremely compact dimensions, these modules are particularly suited for handling machine applications in the field of production engineering where modules need to be arranged in the smallest of spaces.

Robotics is yet another application area. Instead of the AS-Interface flat cable, the K20 modules are connected to AS-Interface over a round cable with M12 cable box.

The AS-Interface bus cable and the 24 V DC auxiliary power supply are routed in this case in a shared round cable. This enables extremely compact installation.

The flexibility of the round cable means that it can also be used on moving machine parts without any problems. The K20 modules are also ideal for such applications as their non-encapsulated design makes them particularly light in weight.

In applications with tow chains, many users rely on placing the AS-Interface bus cable in a round cable. In this case, the K20 modules support direct connection to the round cable. No flat to round cable adapter is required.

The K20 compact module range includes standard AS-Interface modules, as well as an ASIsafe version for the connection of fail-safe sensors, such as EMERGENCY-STOP pushbuttons or protective door monitoring. All standard AS-Interface K20 modules support, as far as technically possible, the expanded address mode (A/B addresses) according to AS-Interface specification 2.1, which enables connection of 62 stations to an AS-Interface network. The K20 module with four inputs and four outputs works in expanded address mode according to AS-Interface specification 3.0 which, for the first time, supports four outputs with an A/B slave, thus enabling 248 inputs and 248 outputs in a fully expanded AS-Interface network.

For particularly space-saving dimensions, the sensors and actuators are connected over M8 plug-in connectors. Alternatively, M12 connectors with Y assignment can be used.

6
Selection and ordering data















Version						Order No.
 3RK2 200-OCT30-0AA3	Digital I/O modules, IP67 – K20					
	Width 20 mm					
	Type	Current carrying capacity of outputs	Slave type	Pin assignment	Connection methods	
	4 inputs	--	A/B	Standard	M8	3RK2 200-OCT30-0AA3
		--	A/B	Y	M12	3RK2 200-OCQ30-0AA3
	2 inputs/ 2 outputs	1	A/B	Standard	M8	3RK2 400-1BT30-0AA3
		1	A/B	Y	M12	3RK2 400-1BQ30-0AA3
	4 outputs	1	A/B (Spec. 3.0)	Standard	M8	3RK2 100-1CT30-0AA3
	4 inputs/ 4 outputs	1	Standard	Standard	M8	3RK1 400-1CT30-0AA3
	1	A/B (Spec. 3.0)	Standard	M8	3RK2 400-1CT30-0AA3	
2 safe inputs	--	Standard	Y-II	M12	3RK1 205-0BQ30-0AA3	

AS-Interface slaves

I/O modules for operation in the field, high degree of protection

Digital I/O modules IP67 - K20

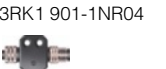
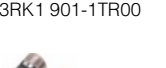
Selection and ordering data (continued)

Version		Order No.			
Accessories					
	AS-Interface sealing caps	3RK1 901-1KA00 3RK1 901-1PN00			
3RK1 901-1KA00	<ul style="list-style-type: none"> For free M12 sockets For free M8 sockets 				
					
3RK1 901-1PN00					
	AS-Interface compact distributors, for AS-Interface flat cable	3RK1 901-1NN10			
3RK1 901-1NN10	Current carrying capacity up to 8 A				
	AS-Interface M12 feeders				
3RX9 801-0AA00	For flat cable	Cable length	Cable end in feeder		
	AS-i	M12 socket	--	Available	3RK1 901-1NR10
3RK1 901-1NR10	AS-i	M12 socket	--	Not available	3RK1 901-1NR11
	AS-i	M12 cable box	1 m	Not available	3RK1 901-1NR11
	AS-i	M12 cable box	2 m	Not available	3RK1 901-1NR12
	AS-i / U _{aux}	M12 socket	--	Not available	3RK1 901-1NR20
3RK1 901-1NR11	AS-i / U _{aux}	M12 cable box	1 m	Not available	3RK1 901-1NR21
	AS-i / U _{aux}	M12 cable box	2 m	Not available	3RK1 901-1NR22
3RK1 901-1NR21					
					
3RK1 901-1NR21					
	AS-Interface M12 feeders, 4-fold				
3RK1 901-1NR04	For flat cable	Cable length	Cable end in feeder		
	AS-i / U _{aux}	4-fold M12 socket delivery includes coupling module	--	Available	3RK1 901-1NR04
	M12-T distributors				3RK1 901-1TR00
3RK1 901-1TR00	<ul style="list-style-type: none"> IP68 1 x M12 plug 2 x M12 box 				
	M12 Y-shaped coupler plugs				6ES7 194-1KA01-0XA0
6ES7 194-1KA01-0XA0	For connection of two sensors to one M12 socket with Y connector				
	M12 connecting cables				3RK1 902-4PB15-3AA0
3RK1 902-4PB15-3AA0	<ul style="list-style-type: none"> 3-pole For addressing AS-i slaves with M12 bus connection Cable length 1.5 m 				

Overview

The AS-Interface user modules are the first module generation for AS-Interface.

Today, innovated and further improved modules are available in the form of the K45 and K60 series of compact modules. We recommend replacing the user modules in future with the K45 compact module series. The user modules will be available for a limited time in order to meet the demand for replacements.

Note:

More information can be found in the Industry Mall at www.siemens.com/industrymall

Advantages of the K45 compact modules

The K45 compact modules provide extra advantages in addition to the functionality of the user modules:

- An integrated addressing socket enables the module to be addressed in the installed state
- Time is saved when mounting the module: Mounting with only one screw thanks to hinge system
- Extensive diagnostics by LED on the module (e. g. display of zero address, no communication with master, overload)
- Random insertion of the AS-Interface flat cable irrespective of the position of the profiled lug
- Smaller dimensions
- Versions with M12 and M8 connection sockets enable the direct connection of all sensors
- Modules in A/B technology enable up to 62 slaves on one AS-Interface network

Conversion table for user modules --> K45

User modules		Corresponding K45 type	
Order No.	Version	Order No.	Version
3RG9 001-0AA00	4 inputs (100 mA)	3RK1 200-0CQ20-0AA3	4 inputs (200 mA)
3RG9 001-0AG00	4 inputs (200 mA)	3RK1 200-0CQ20-0AA3	4 inputs (200 mA)
3RG9 001-0AH00	2 x 2 inputs	3RK2 200-0CQ22-0AA3	2 x 2 inputs A/B slave
3RG9 001-0AC00	2 inputs/2 outputs relay outputs	3RK1 400-1BQ20-0AA3	2 inputs/2 outputs solid-state outputs
3RG9 001-0CC00	2 inputs/2 outputs solid-state outputs	3RK1 400-1BQ20-0AA3	2 inputs/2 outputs solid-state outputs
3RG9 001-0AM00	2 inputs/2 outputs solid-state outputs U_{Aux} using M12 plug	3RK1 400-1BQ20-0AA3	2 inputs/2 outputs solid-state outputs U_{Aux} using black flat cable
3RG9 001-0AJ00	2 x (1 input/1 output) supply of I/O from AS-Interface cable	3RK1 400-0GQ20-0AA3	2 x (1 input/1 output) supply of I/O from AS-Interface cable
3RG9 001-0AB00	4 outputs relay outputs	3RK1 100-1CQ20-0AA3	4 inputs solid-state outputs
3RG9 001-0AL00	4 outputs U_{Aux} using M12 plug	3RK1 100-1CQ20-0AA3	4 outputs U_{Aux} using black flat cable
3RG9 001-0CB00	4 inputs solid-state outputs	3RK1 100-1CQ20-0AA3	4 inputs solid-state outputs

Note:

To use the K45 modules you require the 3RK1 901-2EA00 (wall mounting) or 3RK1 901-2DA00 (standard rail mounting) K45 mounting plates instead of the 3RG9 010-0AA00 and 3RG9 030-0AA00 coupling modules.

AS-Interface slaves

I/O modules for operation in the field, high degree of protection

Analog I/O modules, IP67 - K60

Overview



K60 analog compact module

AS-Interface analog modules from the K60 compact series detect or issue analog signals locally. These modules are linked to the higher-level controller through an AS-Interface master according to specification 2.1 or specification 3.0.

The analog modules are divided into five groups:

- Input module for sensors with current signal
- Input module for sensors with voltage signal
- Input module for sensors with thermal resistor
- Output module for current actuators
- Output module for voltage actuators

The input modules according to profile 7.3/7.4 are available with two or four input channels. It is possible in addition to convert the two-channel module to using only one input channel, thus enabling very short times before the analog value is available. The conversion is effected by means of a jumper plug at socket 3. The transmission times achieved with analog modules according to Profile 7.A.9 are shorter by half than those achieved with Profile 7.3/7.4. Operation is adjustable in this case, e. g. it is possible to choose with the ID1 Code whether the module is operated with one or two channels.

The output modules are configured as two-channel modules as standard.

The input and output channels are electrically separated from the AS-Interface network. If sensors with a higher power requirement are to be connected, more power can be supplied through the auxiliary voltage as an alternative to the internal supply.

In the manual the modules are presented in great detail along with their technical specifications and in-depth notes on operation. Sample function blocks round off the manual.



Benefits

- Analog modules are just as easy to integrate in AS-Interface as digital modules
- Analog values can be easily detected and issued locally
- Preprocessing of the analog value transmission in the master enables rapid evaluation of the analog values
- Up to four values can be detected using one analog module
- Faster transmission and conversion of analog values thanks to the new option for changing over to single-channel operation

In addition, Specification 3.0 now also offers:

- A/B technology, now also with analog modules
- On average, double fast transmission times (only 3 or 4 cycles, depending on the resolution selected)
- Variable adjustable mode: 12 bit or 14 bit resolution, 1 or 2-channel, selectable over the ID1 code
- Extra simple handling of analog processing with masters of Specification 3.0, the DP/AS-i LINK Advanced

Selection and ordering data





Version	Order No.			
 <p>Analog I/O modules IP67 – K60, analog profile 7.3</p> <ul style="list-style-type: none"> • Slave type: Standard • Width 60 mm • Modules supplied without mounting plate 	Inputs	Type	Measuring range	
	1 or 2 inputs (selectable using jumper plug at socket 3)	Current	4 ... 20 mA or ± 20 mA (selectable)	3RK1 207-1BQ40-0AA3
		Voltage	± 10 V or 1 ... 5 V (selectable)	3RK1 207-2BQ40-0AA3
		Thermal resistance	Pt 100 or Ni 100 or 0 ... 600 Ω (selectable)	3RK1 207-3BQ40-0AA3
	4 inputs	Current	4 ... 20 mA or ± 20 mA (selectable)	3RK1 207-1BQ44-0AA3
		Voltage	± 10 V or 1 ... 5 V (selectable)	3RK1 207-2BQ44-0AA3
		Thermal resistance	Pt 100 or Ni 100 or 0 ... 600 Ω (selectable)	3RK1 207-3BQ44-0AA3
	Outputs	Type	Output range	
	2 outputs	Current for 2-wire actuators	4 ... 20 mA or ± 20 mA or 0 ... 20 mA (selectable)	3RK1 107-1BQ40-0AA3
		Voltage for 2-wire actuators	± 10 V or 0 ... 10 V or 1 ... 5 V (selectable)	3RK1 107-2BQ40-0AA3
 <p>Analog I/O modules IP67 – K60, analog profile 7.A.9</p> <ul style="list-style-type: none"> • Slave type: A/B (Spec. 3.0) • Width 60 mm • Modules supplied without mounting plate 	Inputs	Type	Measuring range	
	1 or 2 inputs (variably adjustable)	Current	4 ... 20 mA or ± 20 mA (selectable)	3RK2 207-1BQ50-0AA3
		Voltage	± 10 V or 1 ... 5 V (selectable)	3RK2 207-2BQ50-0AA3

AS-Interface slaves

I/O modules for operation in the field, high degree of protection

Analog I/O modules, IP67 - K60

Selection and ordering data (continued)

Version	Order No.
Accessories	
<p>Manuals Only available to download on the Internet: www.siemens.com/automation/manuals</p>	
 <p>K60 mounting plates</p> <ul style="list-style-type: none"> • Wall mounting • Standard rail mounting 	<p>3RK1 901-0CA00 3RK1 901-0CB01</p>
 <p>M12 sealing caps</p>	<p>3RK1 901-1KA00</p>
 <p>Sealing sets</p> <ul style="list-style-type: none"> • For mounting plate K60 and distributor • Cannot be used for K45 mounting plate • One set contains one straight and one shaped seal 	<p>3RK1 902-0AR00</p>
 <p>Jumper plugs For changing over the 2-channel input modules</p>	<p>3RK1 901-1AA00</p>

Note:

More information can be found in the Industry Mall at www.siemens.com/industrymall

AS-Interface slaves I/O modules for operation in the control cabinet

Overview

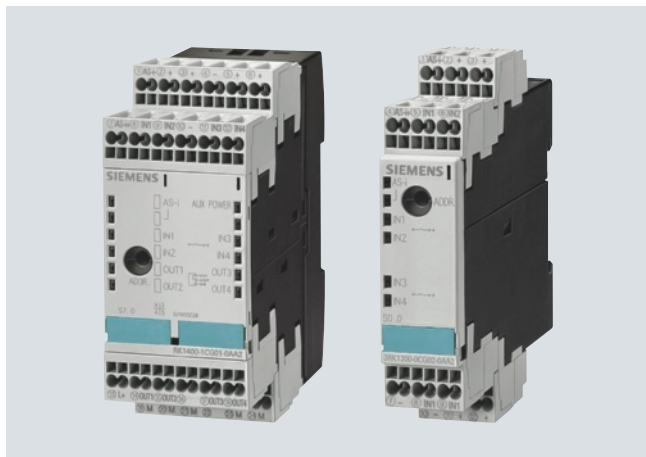

SlimLine S22.5/S45



Flat module



F90 module

For AS-Interface applications inside control cabinets there are various module series for the most diverse requirements:

- SlimLine S22.5
- SlimLine S45
- F90 module
- Flat module

All modules of these series can be snap-mounted directly on a standard mounting rail or be fastened using screws.

AS-Interface modules in IP20 have direct terminals for the AS-Interface cables and therefore do not require a base.



Series	Spectrum	Mounting on TH35 standard mounting rails according to EN 60715	Wall mounting using push-in lugs (Order No.: 3RP1 903)	Other possibilities
SlimLine S22.5	<ul style="list-style-type: none"> • 4I (standard and A/B modules) • 4O • 2I/2O (steady-state/relay outputs) • Counters ¹⁾ • Ground-fault detection modules ¹⁾ 	✓	✓	--
SlimLine S45	<ul style="list-style-type: none"> • 4I/4O (steady-state/relay outputs) • 4I/4O with floating I/Os • 4I/3O (A/B modules) • 4I/4O (A/B modules Spec. 3.0) 	✓	✓	--
F90 module	<ul style="list-style-type: none"> • 4I/4O (screw terminals) • 4I/4O (connection using Combicon connector) • 16I 	✓	--	--
Flat module	<ul style="list-style-type: none"> • 4I/4O (screw terminals) 	--	--	Integrated lugs for screw fixing

¹⁾ For more information about these modules see "Modules with Special Functions" from page 6/70

✓ Available
-- Not available

AS-Interface slaves

I/O modules for operation in the control cabinet

SlimLine

Overview

SlimLine modules of the S22.5 and S45 series

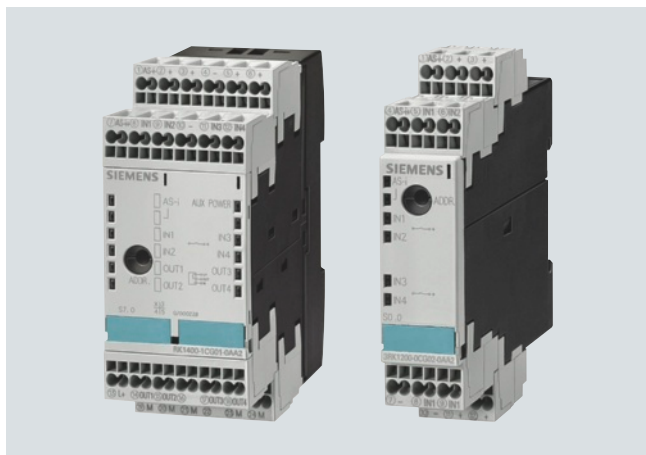

SlimLine S45 modules (left) and S22.5 modules (right)

The AS-Interface series of modules for the "SlimLine" control cabinet with degree of protection IP20 creates space in the cabinet and in distributed local boxes.

For these modules the priority was placed on a narrow type of construction. They have a width of only 22.5 mm or 45 mm.

Standard sensors/actuators and the AS-Interface cable can be connected using removable screw-type or spring-type terminals.

Integrated adapters enable mounting onto a standard mounting rail. Disassembly from the standard mounting rail is quick and easy and requires no tools.

With an additional accessory (push-in lugs), the modules can also be screwed on.

All modules are fitted at the front with LEDs which indicate the module's status.

An addressing socket integrated at the front enables the module to be addressed also when it is installed.

In addition to the digital input/output modules there are modules of design S22.5 with special functions. These include:

- Counter module
- Ground-fault detection module

More information about these modules, see

- the section "Modules with special functions" on page 6/70

• Industry Mall at:

www.siemens.com/industrymall

Section "Automation" -->

"SIRIUS Industrial Controls" --> "Industrial Communication" -->

"AS-Interface" --> "Slaves" --> "Modules with Special Functions"

The new AS-Interface Specification 3.0 adds a number of completely new features to the AS-Interface bus system. The extended address mode (A/B addresses) enables the connection of up to 62 slaves on one AS-Interface network. With the extended address mode according to specification 3.0, four outputs are now possible for the first time even with A/B slaves (instead of only three outputs possible up to now with specification 2.1). Hence with full expansion of an AS-Interface network, there are now 248 inputs as well as 248 outputs available on one AS-Interface system.

Modules with four inputs and four outputs as A/B slaves according to specification 3.0 are also available as SlimLine modules S45.

Note:

Please note that the modules according to Specification 3.0 can be used only with a new master according to AS-Interface Specification 3.0 (e.g. the new DP/AS-i LINK Advanced or IE/AS-i LINK PN IO) and that the cycle times for the outputs can extend to max. 20 ms.

AS-Interface slaves

I/O modules for operation in the control cabinet

SlimLine

Selection and ordering data

Version	Order No.
---------	-----------



3RK1 200-0CE00-0AA2



3RK1 400-0BG00-0AA2



3RK1 400-1CG00-0AA2

S22.5 SlimLine modules

- Inputs: PNP transistor
- Width 22.5 mm

Type	Connection	Slave type	Inputs	Outputs		
4 inputs	Screw	⊕	Standard	2-wire	--	3RK1 200-0CE00-0AA2
			Standard	2- and 3-wire	--	3RK1 200-0CE02-0AA2
		A/B slave	2- and 3-wire	--	3RK2 200-0CE02-0AA2	
	Spring	∞	Standard	2-wire	--	3RK1 200-0CG00-0AA2
			Standard	2- and 3-wire	--	3RK1 200-0CG02-0AA2
		A/B slave	2- and 3-wire	--	3RK2 200-0CG02-0AA2	
2 inputs/ 2 outputs	Screw	⊕	Standard	2-wire	PNP transistor 2 A	3RK1 400-0BE00-0AA2
			Standard	2-wire	Relays	3RK1 402-0BE00-0AA2
	Spring	∞	Standard	2-wire	PNP transistor 2 A	3RK1 400-0BG00-0AA2
			Standard	2-wire	Relays	3RK1 402-0BG00-0AA2
4 outputs	Screw	⊕	Standard	--	PNP transistor 1 A	3RK1 100-1CE00-0AA2
	Spring	∞	Standard	--	PNP transistor 1 A	3RK1 100-1CG00-0AA2

S45 SlimLine modules

- Inputs: PNP transistor
- Width 45 mm

Type	Connection	Slave type	Inputs	Outputs			
4 inputs/ 4 outputs	Screw	⊕	Standard	2- and 3-wire	PNP transistor 1 A	3RK1 400-1CE00-0AA2	
			Standard	2- and 3-wire	PNP transistor 2 A	3RK1 400-1CE01-0AA2	
			Standard	2- and 3-wire floating	PNP transistor 1 A floating	3RK1 402-3CE01-0AA2	
		Spring	∞	Standard	2- and 3-wire	Relays	3RK1 402-3CE00-0AA2
				A/B (Spec. 3.0)	2- and 3-wire	PNP transistor 2 A	3RK2 400-1CE01-0AA2
				Standard	2- and 3-wire	PNP transistor 1 A	3RK1 400-1CG00-0AA2
	Spring	∞	Standard	2- and 3-wire	PNP transistor 2 A	3RK1 400-1CG01-0AA2	
			Standard	2- and 3-wire floating	PNP transistor 1 A floating	3RK1 402-3CG01-0AA2	
			Standard	2- and 3-wire	Relays	3RK1 402-3CG00-0AA2	
		A/B (Spec. 3.0)	∞	Standard	2- and 3-wire	PNP transistor 2 A	3RK2 400-1CG01-0AA2
				A/B slave	2- and 3-wire	PNP transistor 2 A	3RK2 400-1FE00-0AA2
				A/B slave	2- and 3-wire	PNP transistor 2 A	3RK2 400-1FG00-0AA2

Accessories

Sealable covers

To secure against unauthorized addressing

3RP1 902

Push-in lugs

For screw fixing





3RP1 903

AS-Interface slaves

I/O modules for operation in the control cabinet

F90 module

Selection and ordering data

Version					Order No.
 <p>F90 module</p> <ul style="list-style-type: none"> • Standard slave • Width 90 mm <p>3RG9 002-0DB00</p>	4 inputs/ 4 outputs	Screw	 2- and 3-wire PNP transistor	PNP transistor 1 A	3RG9 002-0DB00
				PNP transistor 2 A	3RG9 002-0DA00
				PNP transistor 2 A	3RG9 002-0DC00
		Combicon	 2- and 3-wire PNP transistor	PNP transistor 1 A	3RG9 004-0DB00
				PNP transistor 2 A	3RG9 004-0DA00
				PNP transistor 2 A	3RG9 004-0DC00
	16 inputs	Screw	 PNP transistor	--	3RG9 002-0DE00
		Combicon	 PNP transistor	--	3RG9 004-0DE00

Accessories

Combicon connector sets

For 4I/4O modules with Combicon connection;
one set comprises:

- 4 x 5-pole plug for connection
- Standard sensors/actuators
- 2 x 4-pole plug for AS-Interface and external auxiliary voltage



3RX9 810-0AA00

AS-Interface slaves

I/O modules for operation in the control cabinet

Flat module

Selection and ordering data

Version	Screw terminals 
 <p>Flat module</p> <ul style="list-style-type: none"> • 4 inputs/4 outputs • 200 mA for all I/Os • Screw terminals <p>3RK1 400-0CE00-0AA3</p>	<p>Order No.</p> <p>3RK1 400-0CE00-0AA3</p>

AS-Interface slaves

Special integrated solutions

AS-Interface communication modules

Overview

AS-Interface communication modules for printed circuit board installation

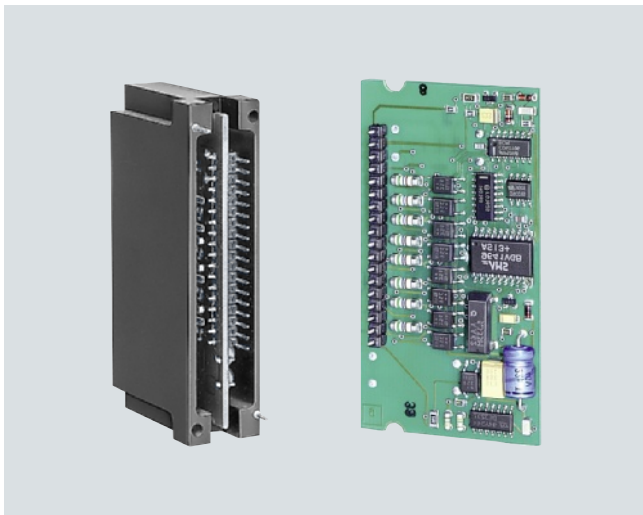

AS-Interface 3RK1 400-0CD00-0AA3 communication module (left)
AS-Interface 3RK2 400-1FD00-0AA2 communication cable (right)

3RK1 400-0CD00-0AA3 AS-Interface communication modules for printed circuit board installation

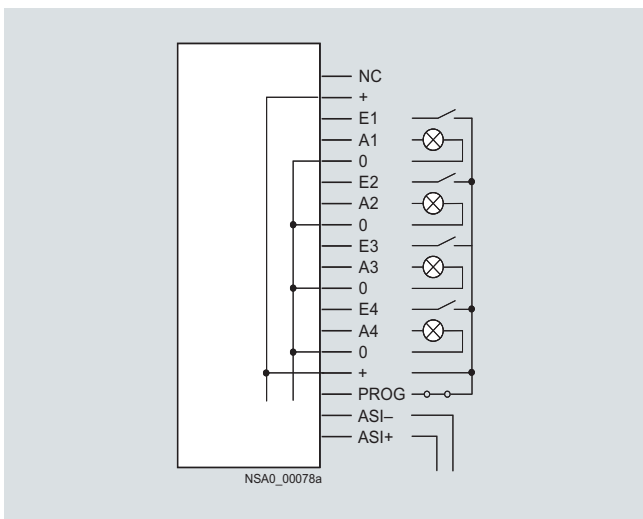

3RK1 400-0CD00-0AA3

With the 4I/4O module for printed circuit board mounting it is possible for up to four mechanical contacts to be queried or indicator lights to be operated, the necessary energy being provided by the AS-Interface system (yellow AS-Interface cable).

Note:

If the switching outputs are overloaded, the module does not respond to invoking by a master.

3RK1 400-0CD01-0AA3 AS-Interface communication modules for printed circuit board installation

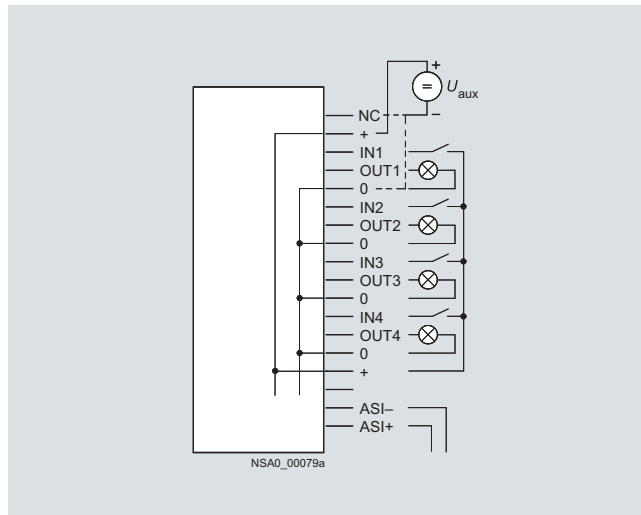

3RK1 400-0CD01-0AA3

With the 3RK1 400-0CD01-0AA3 4I/4O module for printed circuit board mounting it is possible for up to four mechanical contacts to be queried or indicator lights to be operated, the necessary energy for the inputs and outputs being provided from the auxiliary voltage (24 V PELV). If (+) is connected to U_{aux+} and (NC) to U_{aux-} , the outputs are not short-circuit and overload proof; if U_{aux-} is connected to (0), the outputs are overload and short-circuit proof (maximum summation current 200 mA). In this case the module does not respond even to invoking by a master when the switching outputs are overloaded.

3RG9 005-0SA00 AS-Interface communication modules for printed circuit board installation

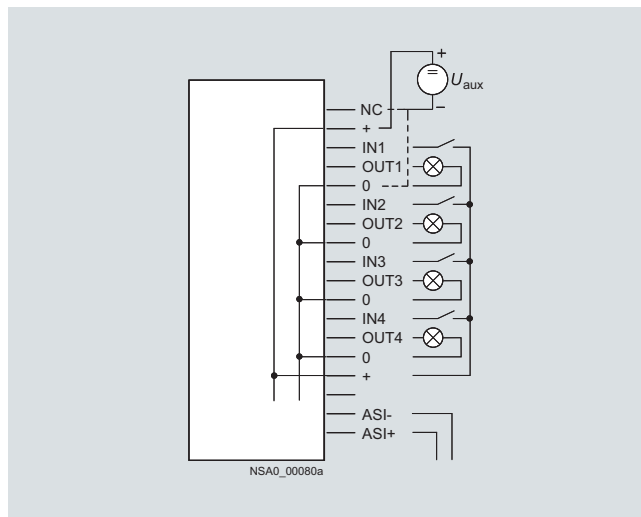

3RG9 005-0SA00

With the 4I/4O module for printed circuit board mounting it is possible for up to four mechanical contacts to be queried or indicator lights to be operated, the power for inputs and outputs being provided from an auxiliary voltage (24 V PELV). If (+) is connected to U_{aux+} and (NC) to U_{aux-} , the outputs are not short-circuit and overload proof; if U_{aux-} is connected to (0), the outputs are overload and short-circuit proof (maximum summation current 200 mA). In this case the module does not respond even to invoking by a master when the switching outputs are overloaded.

Overview (continued)

3RK1 400-1CD00-0AA2, 3RK2 400-1FD00-0AA2 AS-Interface communication modules for printed circuit board installation

Connection	Connection pad ¹⁾
AS-i +	27, 29
AS-i -	28, 30
Sensor+	17, 18, 23, 24
Sensor-	13, 14, 19, 20
IN1	21
IN2	22
IN3	15
IN4	16
U _{aux} + (L24+)	2, 4
U _{aux} - (M24)	1, 3
OUT1	9
OUT2	10
OUT3	5
OUT4	6 (not assigned for 3RK2 400-1FD00-0AA2 4I/3O module)
OUT-	7, 8
Not assigned	11, 12, 25, 26

¹⁾ Note: For pad numbering see Technical Specifications

With the 4I/4O or 4I/3O module for printed circuit board mounting it is possible for up to four mechanical contacts or 3-conductor sensors according to IEC 947-5-2 to be connected. Up to four indicator lights via the 4I/4O module or up to three indicator lights via the 4I/3O module can also be controlled. The power for short-circuit proof solid-state switching outputs is provided from an auxiliary voltage (24 V PELV).

Mounting is very easy using a "Card Edge Board-to-Board Connector". This connector can be ordered for vertical and horizontal mounting from the company AMP, for example:

- 180° version for vertical mounting (AMP): Order No. 530843-2
- 90° version for horizontal mounting (AMP): Order No. 650118-1

If the inputs are loaded with more than 200 mA, the module does not respond to invoking by a master.

3RK1 200-0CD00-0AA2 AS-Interface communication modules for printed circuit board installation

Connection	Connection pad ¹⁾
AS-i +	27, 29
AS-i -	28, 30
Sensor+	17, 18, 23, 24
Sensor-	13, 14, 19, 20
IN1	21
IN2	22
IN3	15
IN4	16
Not assigned	1, 2, 3, 4, 5, 6, 7, 8, 9, 10, 11, 12, 25, 26

¹⁾ Note: For pad numbering see Technical Specification.



With the 4I module for printed circuit board mounting it is possible for up to four mechanical contacts or 3-conductor sensors to be connected, the power for inputs being provided from AS-Interface cable.

Mounting is very easy using a "Card Edge Board-to-Board Connector". This connector can be ordered for vertical and horizontal mounting from the company AMP, for example:

- 180° version for vertical mounting (AMP): Order No. 530843-2
- 90° version for horizontal mounting (AMP): Order No. 650118-1

If the inputs are loaded with more than 200 mA, the module does not respond to invoking by a master.

Selection and ordering data

Version	Slave type	Order No.
 3RK1 400-0CD00-0AA3	4 inputs/4 outputs <ul style="list-style-type: none"> • Supply of I/Os using AS-Interface cable (max. 200 mA) <ul style="list-style-type: none"> - Printed circuit board with solder pins, protected by enclosure • Supply of I/Os using external auxiliary voltage (24 V PELV) <ul style="list-style-type: none"> - Printed circuit board with solder pins, protected by enclosure - Printed circuit board with solder pins for horizontal mounting • Supply of outputs using external auxiliary voltage (24 V PELV) <ul style="list-style-type: none"> - Printed circuit board with gold-plated direct connector for 30-pole male connector socket for simple installation with direct connector 	Standard 3RK1 400-0CD00-0AA3 Standard 3RK1 400-0CD01-0AA3 Standard 3RG9 005-0SA00 Standard 3RK1 400-1CD00-0AA2
	4 inputs/3 outputs <ul style="list-style-type: none"> • Supply of outputs using external auxiliary voltage (24 V PELV) <ul style="list-style-type: none"> - Printed circuit board with gold-plated direct connector for 30-pole male connector socket for simple installation with direct connector 	A/B 3RK2 400-1FD00-0AA2
	4 inputs <ul style="list-style-type: none"> • Printed circuit board with gold-plated direct connector for 30-pole male connector socket for simple installation with direct connector 	Standard 3RK1 200-0CD00-0AA2
	 3RG9 005-0SA00	

AS-Interface slaves

Modules with special functions

Counter modules

Overview



Counter module with spring-type terminals

The counter module is used to send hexadecimally coded count values (LSB=D0, MSB=D3) to a higher-level controller. The count value is increased by one for each valid count pulse at terminal 8. Beginning at 0, the module counts up to 15 and then begins again at 0. The controller adopts the current value and determines the number of pulses between two host invocations through subtraction from the previous value. The total number of count pulses is determined by adding these differences.

For the values sent to be unambiguous, no more than 15 count values are allowed between two host invocations or AS-Interface master invocations at terminal 8. The maximum permissible transmission frequency is calculated from these times:

$$f_{TRmax} = 15 / T_{max}$$

T_{max} : max. possible transmission time from the slave to the host

Another condition for the maximum frequency is the pulse shaped required. For the counter to accept a pulse as valid, a Low must have been applied at the input for at least 300 μ s and a High for at least 1 ms.

This results in a maximum frequency of $f_{Zmax} = 1 / 1.3 \text{ ms} = 769 \text{ Hz}$ independent of the control system (see figure).

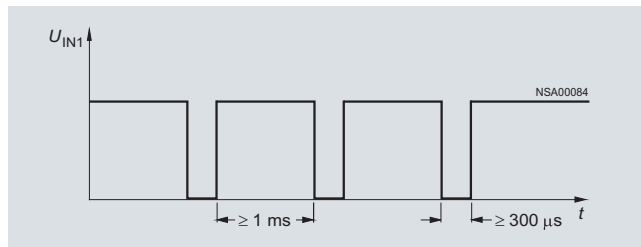

Maximum frequency for the counter module

If the time criterion stipulated in the graphic is violated, the count value is rejected.

The counter is active only for the reset parameter P2 (default). The counter is deleted when P2 is set, and the incoming count pulses are not registered until after P2 is reset again.

Note:

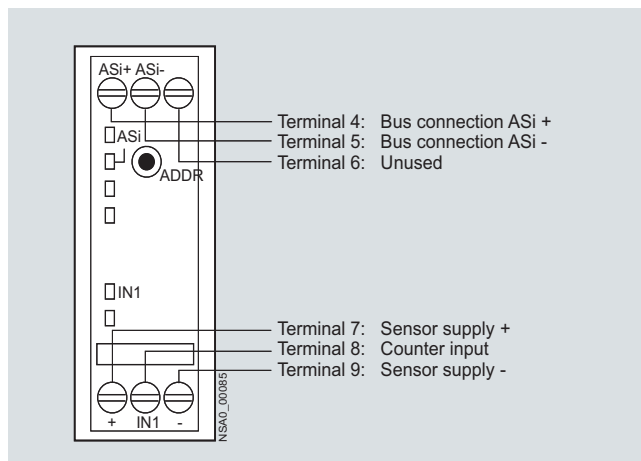

A customized function block is necessary or must be programmed.



Counter module connection options

6

Selection and ordering data

Version	Order No.
<p>Counter module</p> <p>Width 22.5 mm</p> <ul style="list-style-type: none"> • With screw terminals • With spring-type terminals 	<p>⊕ 3RK1 200-0CE03-0AA2</p> <p>∞ 3RK1 200-0CG03-0AA2</p>
<p></p> <p>3RK1 200-0CE03-0AA2</p> <p></p> <p>3RK1 200-0CG03-0AA2</p>	

AS-Interface slaves

Modules with special functions

Ground-fault detection modules

Overview

"Ground faults in any control circuit must not lead to unintentional starting or potentially hazardous movements or prevent the machine from stopping." (EN 60204-1 / VDE 0113-1).

The AS-Interface ground-fault detection module is used to meet these requirements. Using this module from the SlimLine series, ground faults in AS-Interface systems can be reliably detected and reported.



The following ground faults are detected:

- Ground fault from AS-i "+"
- Ground fault from AS-i "-"
- Ground fault from sensors and actuators which are supplied from the AS-Interface voltage.

Note:

Not suitable for AS-Interface Power24V.

Selection and ordering data

Version	Order No.
Ground-fault detection module Width 22.5 mm <ul style="list-style-type: none"> • With screw terminals • With spring-type terminals 	 3RK1 408-8KE00-0AA2  3RK1 408-8KG00-0AA2



3RK1 408-8KE00-0AA2

Overvoltage protection module

Overview



AS-Interface overvoltage protection module

The AS-Interface overvoltage protection module protects downstream AS-Interface devices or individual sections in AS-Interface networks from conducted overvoltages which can be caused by switching operations and remote lightning strikes.

The location of the overvoltage protection module forms within the lightning protection zone concept the transition from zone 1 to 2/3. Direct lightning strikes must be coped with using additional protective measures at the transitions from lightning protection zone 0A to 1.

With the AS-Interface overvoltage protection module it is now also possible to integrate AS-Interface in the overall lightning protection concept of a plant or machine.

The module has the same design and degree of protection (IP67) as the AS-Interface K45 compact modules. It is a passive module without AS-i IC and as such does not need its own address on the AS-Interface network.

The module can be used to protect the AS-Interface cable and the cable for the auxiliary voltage from overvoltage.

Overvoltages are discharged through a ground cable with a green/yellow oil-proof outer sheath. This cable is fixed in the module and must be connected with low resistance to the system's ground.

Rated discharge current I_{sn}

The rated discharge current is the peak value of a surge current with waveform 8/20 microseconds, for which the overvoltage protection module is rated in according to a specific test program.

With waveform 8/20, 100 % of the value is achieved after 8 microseconds and 50 % after 20 microseconds.

Protection level U_p

The protection level of an overvoltage protection module is the highest momentary value of the voltage at the terminals, established in individual tests.

The protection level characterizes the capability of an overvoltage protection module to limit overvoltages to a residual level.

AS-Interface slaves

Modules with special functions

Overvoltage protection module

Overview (continued)

Configuration guidelines

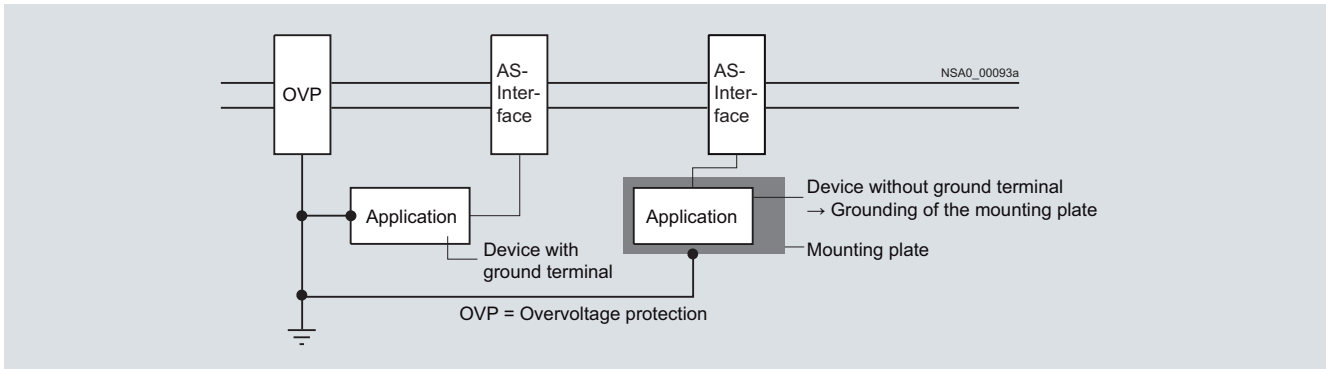

Configuration guidelines for overvoltage protection modules

The grounding of protection modules and the units to be protected must be effected through a shared grounding point

(equipotential bonding). If insulated devices are protected, their mounts must be included in the grounding points.

Sample application

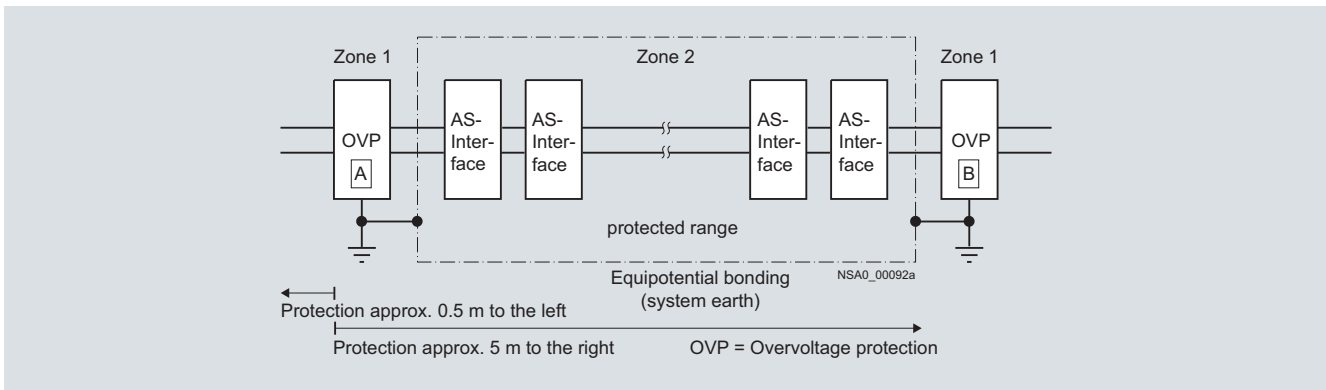

Sample application for overvoltage protection modules

6

Selection and ordering data

Version	Order No.
 <p>Overvoltage protection module</p> <p>3RK1 901-1GA00</p>	<p>3RK1 901-1GA01</p>

Overview

Every **LOGO!** can now be connected to the **AS-Interface system**



Using the AS-Interface connection for LOGO!, an intelligent slave can be integrated in the AS-Interface system. With the modular interface it becomes possible to integrate the different basic units in the system according to their functionality. Similarly, functionalities can be quickly and easily adapted to new requirements by exchanging the basic unit.

The interface module provides four inputs and four outputs on the system. These inputs and outputs do not actually exist in hardware terms, however, but are only virtually present through the interface on the bus.

AS-Interface connections for LOGO!

Selection and ordering data

Version	Order No.
<p>AS-Interface connections for LOGO!</p> <ul style="list-style-type: none"> • 4 virtual inputs • 4 virtual outputs 	3RK1 400-0CE10-0AA2

3RK1 400-0CE10-0AA2

AS-Interface slaves

Contactors and contactor assemblies – Power contactors for switching motors

SIRIUS 3RT20 contactors

Overview

Contactors with communication interface, sizes S00 and S0

Contactor versions with a communication interface are required for the connection to the controller via IO-Link or AS-Interface. The connection is made via function modules, which are mounted on to the front side of the contactors.

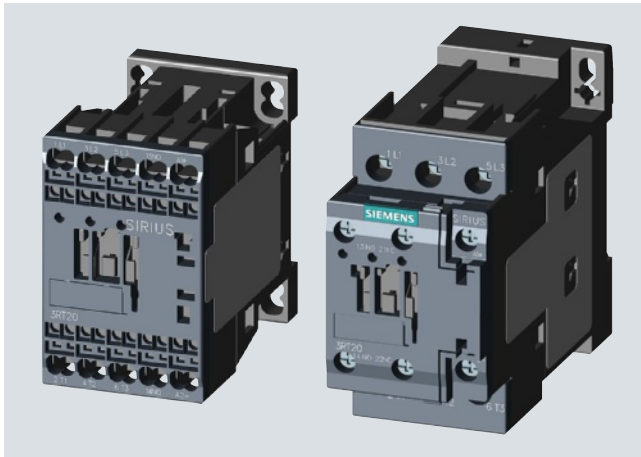

Contactors with communication interface in size S00 with spring-type terminals and size S0 with screw terminals

Standards

IEC 60947-1, EN 60947-1,
IEC 60947-4-1, EN 60947-4-1,
IEC 60947-5-1, EN 60947-5-1 (auxiliary switches)

The 3RT20 contactors for switching motors are climate-proof and are tested and suitable for use worldwide.

If the devices are used in ambient conditions which deviate from common industrial conditions (IEC 60721-3-3 "Stationary Use, Weather-Protected"), information must be obtained about possible restrictions with regard to the reliability and endurance of the device and possible protective measures. In this case contact our Technical Assistance.

The 3RT2 contactors are finger-safe according to EN 50274.

The contactors are suitable for screw fixing or for mounting on TH 35 standard mounting rails according to IEC 60715.

Contact reliability

If voltages ≤ 110 V and currents ≤ 100 mA are to be switched, the auxiliary contacts of the 3RT2 contactor or 3RH21 contactor relay should be used as they guarantee a high level of contact reliability.

These auxiliary contacts are suitable for solid-state circuits with currents ≥ 1 mA at a voltage ≥ 17 V.

Connection methods

The 3RT2 contactors are available with screw terminals or spring-type terminals.

Short-circuit protection of the contactors

For more information about short-circuit protection of contactors without overload relay, see Technical Specifications.

To assemble fuseless motor feeders you must select combinations of motor starter protector and contactor as explained in "3RA2 Load Feeders".

Motor protection

3RU21 thermal overload relays or 3RB30 solid-state overload relays can be fitted to the 3RT2 contactors for protection against overload. The overload relays must be ordered separately.

Ratings of induction motors

The quoted rating (in kW) refers to the output power on the motor shaft (according to the nameplate).

Control supply voltage

The contactors with communication interface are available with 24 V DC operation.

Note:

The selection and ordering data for 3RT10 contactors and 3RA23 reversing contactor assemblies with communication interface can be found in chapter 7, "IO-Link".

Note:

Further technical information is available at www.siemens.com/industrial-controls/support

under Product List:

- Technical specifications

under Entry List:

- Updates
- Downloads
- FAQ
- Manuals/operating instructions
- Characteristic curves
- Certificates

and at

www.siemens.com/industrial-controls/configurators

- Configurators

AS-Interface slaves

Contactors and Contactor Assemblies

SIRIUS 3RA24 contactor assemblies
for wye-delta starting

Overview

These 3RA24 contactor assemblies for wye-delta starting are designed for standard applications.

Note:

Contactor assemblies for wye-delta starting in special applications such as very heavy starting or wye-delta starting of special motors must be customized. Help with designing such special applications is available from Technical Assistance.





The 3RA24 contactor assemblies for wye-delta starting can be ordered as follows:

- complete, fully wired and tested, with electrical and mechanical interlocking
- as individual parts for customer assembly

A dead interval of 50 ms on reversing is already integrated in the function module for wye-delta starting. The auxiliary contacts used in the contactors (see Chapter 7, "IO-Link") are freely available.

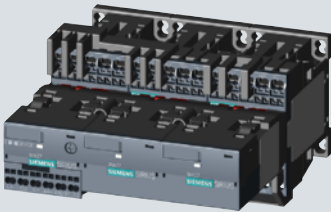
Selection and ordering data

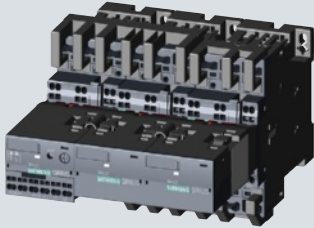
Fully connected and tested contactor assemblies

					
3RA24 1.-8XE31-2BB4		3RA24 2.-8XE32-1BB4		3RA24 2.-8XE32-2BB4	
Rated data AC-3		Rated control supply voltage U_s ¹⁾		Screw terminals 	
Operational current I_e up to		Rating of induction motors at 50 Hz and		Spring-type terminals 	
400 V		230 V 400 V 500 V 690 V		Order No.	
A	kW	kW	kW	kW	V

DC operation

Size S00

For AS-Interface connection

12	3.3	5.5	7.2	9.2	24 DC
16	4.7	7.5	10.3	9.2	24 DC
25	5.5	11	11	11	24 DC

3RA24 15-8XH31-1BB4

3RA24 15-8XH31-2BB4

3RA24 16-8XH31-1BB4

3RA24 16-8XH31-2BB4

3RA24 17-8XH31-1BB4

3RA24 17-8XH31-2BB4

Size S0

For AS-Interface connection

25	7.1	11	15.6	19	24 DC
32 / 40	11.4	15 / 18.5	19	19	24 DC
50	--	22	19	19	24 DC

3RA24 23-8XH32-1BB4

3RA24 23-8XH32-2BB4

3RA24 25-8XH32-1BB4

3RA24 25-8XH32-2BB4

3RA24 26-8XH32-1BB4

3RA24 26-8XH32-2BB4

Components for customer assembly

Assembly kits with wiring modules and mechanical connectors are available for contactor assemblies for wye-delta starting. Contactors, overload relays, function modules for wye-delta starting, auxiliary switches for electrical interlocking – and if required also feeder terminals – must be ordered separately.

The wiring kits for sizes S00 and S0 contain the top and bottom main conducting path connections between the line and delta contactors (top) and between the delta and star contactors (bottom).

Selection of the contactors for customer assembly

Rated data AC-3 at AC 50 Hz 400 V			Size	Line/delta contactor	Star contactor	Complete order no.
Rating	Operational current I_e	Motor current				
kW	A	A				
5.5	12	9.5 ... 13.8	S00-S00-S00	3RT20 15-.BB41-0CC0	3RT20 15-.BB41-0CC0	3RA24 15-8XH31-.BB4
7.5	16	12.1 ... 17		3RT20 17-.BB41-0CC0	3RT20 15-.BB41-0CC0	3RA24 16-8XH31-.BB4
11	25	19 ... 25		3RT20 18-.BB41-0CC0	3RT20 16-.BB41-0CC0	3RA24 17-8XH31-.BB4
11	25	19 ... 25	S0-S0-S0	3RT20 24-.BB40-0CC0	3RT20 24-.BB40-0CC0	3RA24 23-8XH32-.BB4
15	32	24.1 ... 34		3RT20 26-.BB40-0CC0	3RT20 24-.BB40-0CC0	3RA24 25-8XH32-.BB4
18.5	40	34.5 ... 40		3RT20 26-.BB40-0CC0	3RT20 24-.BB40-0CC0	3RA24 25-8XH32-.BB4
22	50	31 ... 43		3RT20 27-.BB40-0CC0	3RT20 26-.BB40-0CC0	3RA24 26-8XH32-.BB4

AS-Interface slaves

Contactors and Contactor Assemblies





SIRIUS 3RA27 function modules for AS-Interface

Overview

The function modules for mounting onto contactors enable the assembly of starters and contactor assemblies for direct-on-line, reversing and wye-delta starting without any additional, complicated wiring of the individual components.

These include the fundamental control functions, such as time and sealing functions, which are used for the respective branches and can be connected to the controller via the bus system.

Selection and ordering data

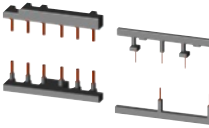
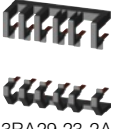
Version	Screw terminals	Spring-type terminals
Order No.	Order No.	Order No.
Function modules for direct-on-line starting		
 3RA27 12-1AA00  3RA27 12-2AA00	AS-Interface connection	3RA27 12-1AA00 3RA27 12-2AA00
Function modules for reversing starting ¹⁾		
 3RA27 12-1BA00  3RA27 12-2BA00	AS-Interface connection, comprising one basic and one coupling module	3RA27 12-1BA00 3RA27 12-2BA00
 3RA29 23-2AA1  3RA29 23-2AA2	Assembly kits for making 3-pole contactor assemblies The assembly kit contains: mechanical interlock; 2 connecting clips for 2 contactors, wiring modules on the top and bottom <ul style="list-style-type: none"> • For size S00 • For size S0 <ul style="list-style-type: none"> - For main, auxiliary and control current - Only for main current ²⁾ 	3RA29 13-2AA1 3RA29 13-2AA2 3RA29 23-2AA1 -- -- 3RA29 23-2AA2

Applicable contactors or reversing contactor assemblies with communication interface can be found in chapter 7, "IO-Link".

Note:

When using the function modules, no other auxiliary switches are allowed to be connected to the basic units.



- 1) Pre-wired contactor assemblies for reversing start with communication interface can be found in chapter 7, "IO-Link". When these contactor assemblies are used, the assembly kit for the wiring is already integrated.
- 2) Version in size S0 with spring-type terminals:
 Only the wiring modules for the main circuit are included.
 No connectors are included for the auxiliary and control circuit.

AS-Interface slaves

Contactors and Contactor Assemblies

SIRIUS 3RA27 function modules
for AS-Interface

Selection and ordering data (continued)

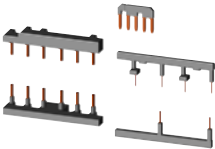
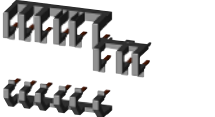
Version	Screw terminals	Spring-type terminals
Order No.	Order No.	Order No.
Function modules for wye-delta starting ¹⁾		
 3RA27 12-1CA00	AS-Interface connection , consisting of one basic module and two coupling modules	3RA27 12-1CA00
 3RA27 12-2CA00		
Assembly kits for making 3-pole contactor assemblies		
The assembly kit contains: Mechanical interlock, 4 connecting clips for 3 contactors, star jumper, wiring modules above and below ²⁾		
 3RA29 23-2BB1	<ul style="list-style-type: none"> • For size S00 • For size S0 <ul style="list-style-type: none"> - For main, auxiliary and control current - Only for main current 	3RA29 13-2BB1
 3RA29 23-2BB2		3RA29 13-2BB2
	3RA29 23-2BB1 --	-- 3RA29 23-2BB2

Applicable contactors with communication interface can be found in chapter 7, "IO-Link".

Note:

When using the function modules, no other auxiliary switches are allowed to be connected to the basic units.

¹⁾ Complete contactor assemblies for wye-delta starting, including functional modules can be found on page 6/75.

²⁾ When using the function modules for wye-delta starting, the wiring modules for the auxiliary current are not required.

Version	Order No.
---------	-----------

Accessories

 3RA29 10-0	Sealable covers for 3RA27, 3RA28, 3RA29	3RA29 10-0
	Manual Function modules for AS-Interface	3ZX1 012-0RA27-0AB0

AS-Interface slaves

Motor starters for operation in the control cabinet

SIRIUS 3RA6 compact feeders General data

Overview

3RA6 fuseless compact feeders and infeed system for 3RA6



3RA62 reversing starters

Integrated functionality

The SIRIUS 3RA6 compact feeders are a generation of innovative load feeders with the integrated functionality of a motor starter protector, contactor and solid-state overload relay. In addition, various functions of optional mountable accessories (e.g. auxiliary switches, surge suppressors) are already integrated in the SIRIUS compact feeder.

Application

The SIRIUS compact feeders can be used wherever standard induction motors up to 32 A (approx. 15 kW/400 V) are directly started.

The compact feeders are not suitable for the protection of single-phase AC or DC loads.

Approvals according to IEC, UL, CSA and CCC standards have been issued for the compact feeders.

Low equipment variance

Thanks to wide setting ranges for the rated current and wide voltage ranges, the equipment variance is greatly reduced compared to conventional load feeders.

Very high operational reliability

Through the high short-circuit breaking capacity and defined shut-down when the end of service life is reached means that the SIRIUS compact feeder achieves a very high level of operational reliability that would otherwise have only been possible with considerable additional outlay. This sets it apart from devices with similar functionality.

Safe disconnection

The auxiliary switches (NC contacts) of the 3RA6 compact feeders are designed as mirror contacts. It is thus possible to use the devices for safe disconnection, e.g. emergency-stops, up to Category 2 (EN 954-1) and together with other redundancy switching devices up to Category 3 or 4.

Communications integration through AS-Interface

To enable communications integration through AS-Interface there is an AS-i add-on module available in several versions for mounting instead of the control circuit terminals on the SIRIUS compact feeder.

The design of the AS-i add-on module permits a group of up to 62 feeders with a total of four cables to be connected to the control system. This reduces wiring work considerably compared to the parallel wiring method.

Communications integration using IO-Link

SIRIUS 3RA64, 3RA65 compact feeders for IO-Link see Chapter 7: "IO-Link".

Permanent wiring/easy replacement

Using the SIRIUS infeed system for 3RA6 it is possible to carry out the wiring in advance without a compact feeder needing to be connected.

A compact feeder is very easily replaced simply by pulling it out of the device without disconnecting the wiring.

Even with screw connections or mounting on a standard mounting rail there is no need to disconnect any wiring (on account of the removable main and control circuit terminals) in order to replace a compact feeder.

Consistent solution from the infeed to the motor feeder

The SIRIUS infeed system for 3RA6 with integrated PE bar is offered as a user-friendly possibility of feeding in summation currents up to 100 A with a maximum conductor cross-section of 70 mm² and connecting the motor cable directly without additional intermediate terminals.

Screw and spring-type connections

The SIRIUS compact feeders and the infeed system for 3RA6 are available with screw and spring-type terminals.

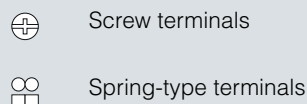

System configurator for engineering

A free system configurator is available to reduce further the amount of engineering work for selecting the required compact feeders and matching infeed.

Types of infeed for the 3RA6 fuseless compact feeders

On the whole four different infeed possibilities are available:

- Parallel wiring
- Use of three-phase busbars (combination with SIRIUS motor starter protectors and SIRIUS contactors possible)
- 8US busbar adapters
- SIRIUS infeed system for 3RA6

To comply with the clearance and creepage distances demanded according to UL 508 there are the following infeed possibilities:

AS-Interface slaves

Motor starters for operation in the control cabinet

SIRIUS 3RA6 compact feeders
General data

Overview (continued)

Type of infeed	Feeder terminal (acc. to UL 508, type E)	Type
Parallel wiring	Terminal block for "Self-Protected Combination Motor Controller (Type E)"	3RV19 28-1H
Three-phase busbars	Three-phase infeed terminal for constructing "Type E Starters", UL 508	3RV19 25-5EB
Infeed systems for 3RA6	Infeed on left, 50/70 mm ² , screw terminal with 3 sockets, outgoing terminal with screw/spring-type connections, including PE bar	3RA68 13-8AB (screw terminals), 3RA68 13-8AC (spring-type terminals)

SIRIUS 3RA6 compact feeders

The SIRIUS 3RA6 compact feeders are universal motor feeders according to IEC 60947-6-2. As control and protective switching devices (CPS) they can connect, convey and disconnect the thermal, dynamic and electrical loads from short-circuit currents up to $I_{cs} = 53$ kA, i.e. they are practically weld-free. They combine the functions of a motor starter protector, a contactor and a solid-state overload relay in one enclosure. Direct-on-line starters with 45 mm width and reversing starters with 90 mm width are available as versions.

The reversing starter version comes with not only an internal electrical interlock but also with a mechanical interlock to prevent simultaneous actuation of both directions of rotation.

The compact feeders have isolating features in accordance with IEC 60947.2 and can be used as disconnector units (main control switch according to EN 60204 or DIN VDE 0113). Isolation is effected by moving the handle into the "OFF" position; disconnection by means of the control contacts is not enough.

3RA6 fuseless compact feeders are supplied for 5 different current setting ranges. The 3RA61 and 3RA62 have 3 control voltage ranges (AC/DC), the 3RA64 and 3RA65 have one control voltage range (DC):

Current setting range	At 400 V AC for induction motors		
	Standard output P	Rated control supply voltage for	
A	kW	3RA61, 3RA62 compact feeders	3RA64, 3RA65 compact feeders for IO-Link
		V AC/DC	V DC
0.1 ... 0.4	0.09	24	24
0.32 ... 1.25	0.37	42 ... 70	
1 ... 4	1.5	110 ... 240	
3 ... 12	5.5		
8 ... 32	15		

Note:

The 3RA1 load feeders can be used for fuseless load feeders > 32 A up to 100 A.

The SENTRON 3VL circuit breakers and the SIRIUS 3RT contactors can be used for fuseless load feeders > 100 A.

Operating conditions

The SIRIUS 3RA6 compact feeders are suitable for use in any climate. They are intended for use in enclosed rooms in which no severe operating conditions (such as dust, caustic vapors, hazardous gases) prevail. Suitable covers must be provided for installation in dusty and damp locations.

The SIRIUS compact feeders are generally designed to degree of protection IP20. The permissible ambient temperature during operation is -20 to +60 °C.

The rated short-circuit current I_{CS} according to IEC 60947-6-2 is 53 kA at 400 V.

Note:

The maximum permissible short-circuit currents of the device versions for the various forms of power supply and voltages are available on request from Technical Assistance:

Tel.: +49 (9 11) 8 95-59 00

E-mail: technical-assistance@siemens.com.

Overload tripping times

The overload tripping time can be set on the device to normal starting conditions (CLASS 10) and to heavy starting conditions (CLASS 20). As the breaker mechanism still remains closed after an overload, resetting is possible by either local manual reset or auto reset after 3 minutes cooling time.

With autoreset there is no need to open the control cabinet.

Diagnostics options

The compact feeder provides the following diagnostics options:

- With LEDs
 - Connection to the control voltage
 - Position of the main contacts
- With mechanical indication
 - Tripping due to overload
 - Tripping due to short circuit
 - Tripping due to malfunction (end of service life reached because of worn switching contacts or a worn switching mechanism or faults in the control electronics)

These states can also be evaluated in the higher-level control system:

- With parallel wiring using the integrated auxiliary and signaling switches of the compact starter
- With AS-Interface or IO-Link in even greater detail using the respective communication interface

Four complement versions for 3RA6 compact feeders

- For standard mounting rail or screw fixing: basic version including 1 pair of main circuit terminals and 1 pair of control circuit terminals
- For standard mounting rail or screw fixing when using the AS-i add-on module: without control circuit terminals because the AS-i add-on module is plugged on instead
- For use with the infeed system for 3RA6: without main circuit terminals because they are supplied with the infeed system and the expansion modules
- For use with the infeed system for 3RA6 and the AS-i add-on module: without terminal complement (also for reordering when replacing the compact starter)
- The control circuit terminals are always required by the compact starters for IO-Link; the main circuit terminals depend on the use of the infeed system.

More components of the 3RA6

Already integrated in the 3RA61/3RA62 – and connectable using the two 6-pole removable control circuit terminals – in addition to the control supply voltage are the signaling contacts "overload" (1 CO) and "short circuit / malfunction" (1 NO). The 3RA61 has two auxiliary contacts (1 NO + 1 NC) for indicating the position of the main contacts. Unlike the 3RA61 direct-on-line starter, the 3RA62 reversing starter has one auxiliary contact (1 NO) per direction of rotation per main contact.

AS-Interface slaves

Motor starters for operation in the control cabinet

SIRIUS 3RA6 compact feeders General data

Overview (continued)

Available for the 3RA61 and 3RA64 direct-on-line starters is a slot for an optional auxiliary switch block (optionally 2 NO, 2 NC or 1 NO + 1 NC) and for the 3RA62 and 3RA65 reversing starters there are two slots (for auxiliary switch blocks see "Accessories" on Page 6/84).

Unlike the direct-on-line starter, the 3RA62 reversing starter has one auxiliary contact (1 NO) per direction of rotation per main contact.

Positively-driven operation of the auxiliary contacts

Positively-driven operation between individual auxiliary circuits exists for the compact feeder in the version as a direct-on-line starter for parallel wiring (3RA61) between the auxiliary circuits of the NC contacts (NC 21-22) and the NO contacts (NO 13-14) in the basic unit.

In addition the optional auxiliary switch block offers positively driven contacts in the version 3RA69 13-1A, each with one NC contact and one NO contact.

Benefits

The SIRIUS 3RA6 compact feeders offer a number of benefits:

- Compact design saves space in the control cabinet
- Little planning and assembly work and far less wiring thanks to a single complete unit with one order number
- Little variance through 3 wide voltage ranges and 5 wide setting ranges for the rated current mean low stock levels
- High plant availability through integrated functionalities such as prevention of main contact welding and shut-down at end of service life
- Greater productivity through automatic device reset in case of overload and differentiated detection of overload and short-circuit
- Easy checking of the wiring and testing of the motor direction prior to start-up thanks to optional "control kits"
- Speedy replacement of devices thanks to removable terminals with spring-type and screw connections in the main and control circuit
- Efficient power distribution through the related SIRIUS infeed system for 3RA6
- Direct connection of the motor feeder cable to the SIRIUS infeed system for 3RA6 thanks to integrated PE bar
- Connecting and looping through incoming feeders up to a cross-section of 70 mm²
- When using the infeed system for 3RA6, possibility of directly connecting the motor cable without intermediate terminals
- Integration in Totally Integrated Automation thanks to the optional connection to AS-Interface or IO-Link

The SIRIUS 3RA6 compact feeders create the basis for high-availability and future-proof machine concepts.

**3RA61, 3RA62 compact feeders
3RA61 direct-on-line starters**

Selection and ordering data



Width 45 mm
 Rated short-circuit current $I_{CS} = 53 \text{ kA}$ at 400 V
 A set of 3RA69 40-0A adapters is required for screw fixing.

Standard induction motor 4-pole at 400 V AC ¹⁾ Standard output P	Setting range for solid-state overload release	Instantaneous electronic release
---	--	-------------------------------------

kW	A	A

Order No.	Order No.
-----------	-----------

For use with the infeed system for 3RA6 and with the AS-i add-on module or as a replacement device, without main and control circuit terminals

0.09	0.1 ... 0.4	56
0.37	0.32 ... 1.25	56
1.5	1 ... 4	56
5.5	3 ... 12	168
15	8 ... 32	448

3RA61 20-0A 30	--
3RA61 20-0B 30	--
3RA61 20-0C 30	--
3RA61 20-0D 30	--
3RA61 20-0E 30	--

Screw terminals	Spring-type terminals
-----------------	-----------------------

For standard mounting rail or screw mounting, including 1 pair of main circuit terminals and 1 pair of control circuit terminals

0.09	0.1 ... 0.4	56
0.37	0.32 ... 1.25	56
1.5	1 ... 4	56
5.5	3 ... 12	168
15	8 ... 32	448

3RA61 20-1A 32	3RA61 20-2A 32
3RA61 20-1B 32	3RA61 20-2B 32
3RA61 20-1C 32	3RA61 20-2C 32
3RA61 20-1D 32	3RA61 20-2D 32
3RA61 20-1E 32	3RA61 20-2E 32

For use in the infeed system for 3RA6, without main circuit terminals with 1 pair of control circuit terminals

0.09	0.1 ... 0.4	56
0.37	0.32 ... 1.25	56
1.5	1 ... 4	56
5.5	3 ... 12	168
15	8 ... 32	448

3RA61 20-1A 33	3RA61 20-2A 33
3RA61 20-1B 33	3RA61 20-2B 33
3RA61 20-1C 33	3RA61 20-2C 33
3RA61 20-1D 33	3RA61 20-2D 33
3RA61 20-1E 33	3RA61 20-2E 33

Order No. supplements for rated control supply voltage

- 24 V AC/DC
- 42 ... 70 V AC/DC
- 110 ... 240 V AC/DC

B	B
E	E
P	P

*For standard mounting rail or screw mounting when using the AS-i add-on module with 1 pair of main circuit terminals without control circuit terminals
 Rated control supply voltage 24 V AC/DC*

0.09	0.1 ... 0.4	56
0.37	0.32 ... 1.25	56
1.5	1 ... 4	56
5.5	3 ... 12	168
15	8 ... 32	448

3RA61 20-1AB34	3RA61 20-2AB34
3RA61 20-1BB34	3RA61 20-2BB34
3RA61 20-1CB34	3RA61 20-2CB34
3RA61 20-1DB34	3RA61 20-2DB34
3RA61 20-1EB34	3RA61 20-2EB34

¹⁾ Selection depends on the concrete startup and rated data of the protected motor.



AS-Interface slaves

Motor starters for operation in the control cabinet

3RA61, 3RA62 compact feeders
3RA62 reversing starters

Selection and ordering data



3RA62 50-1CP32 3RA62 50-2DP32

Reversing duty

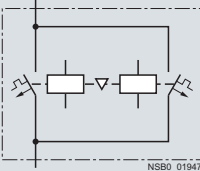



NSB0_01947

Width 90 mm

Rated short-circuit current $I_{CS} = 53 \text{ kA}$ at 400 V

Two sets of 3RA69 40-0A adapters are required for screw fixing.

Standard induction motor 4-pole at 400 V AC ¹⁾	Setting range for electronic overload release	Instantaneous electronic release	
Standard output P			
kW	A	A	Order No.

For use with the infeed system for 3RA6 and with the AS-i add-on module or as a replacement device, without main and control circuit terminals

0.09	0,1 ... 0.4	56	3RA62 50-0A 30	--
0.37	0.32 ... 1.25	56	3RA62 50-0B 30	--
1.5	1 ... 4	56	3RA62 50-0C 30	--
5.5	3 ... 12	168	3RA62 50-0D 30	--
15	8 ... 32	448	3RA62 50-0E 30	--

Screw terminals 

Spring-type terminals 

For standard mounting rail or screw mounting, including 1 pair of main circuit terminals and 1 pair of control circuit terminals

0.09	0,1 ... 0.4	56	3RA62 50-1A 32	3RA62 50-2A 32
0.37	0.32 ... 1.25	56	3RA62 50-1B 32	3RA62 50-2B 32
1.5	1 ... 4	56	3RA62 50-1C 32	3RA62 50-2C 32
5.5	3 ... 12	168	3RA62 50-1D 32	3RA62 50-2D 32
15	8 ... 32	448	3RA62 50-1E 32	3RA62 50-2E 32

For use in the infeed system for 3RA6, without main circuit terminals with 1 pair of control circuit terminals

0.09	0,1 ... 0.4	56	3RA62 50-1A 33	3RA62 50-2A 33
0.37	0.32 ... 1.25	56	3RA62 50-1B 33	3RA62 50-2B 33
1.5	1 ... 4	56	3RA62 50-1C 33	3RA62 50-2C 33
5.5	3 ... 12	168	3RA62 50-1D 33	3RA62 50-2D 33
15	8 ... 32	448	3RA62 50-1E 33	3RA62 50-2E 33

Order No. supplements for rated control supply voltage

- 24 V AC/DC
- 42 ... 70 V AC/DC
- 110 ... 240 V AC/DC

B
E
P

B
E
P

For standard mounting rail or screw mounting when using the AS-i add-on module with 1 pair of main circuit terminals without control circuit terminals
Rated control supply voltage 24 V AC/DC

0.09	0,1 ... 0.4	56	3RA62 50-1AB34	3RA62 50-2AB34
0.37	0.32 ... 1.25	56	3RA62 50-1BB34	3RA62 50-2BB34
1.5	1 ... 4	56	3RA62 50-1CB34	3RA62 50-2CB34
5.5	3 ... 12	168	3RA62 50-1DB34	3RA62 50-2DB34
15	8 ... 32	448	3RA62 50-1EB34	3RA62 50-2EB34

¹⁾ Selection depends on the concrete startup and rated data of the protected motor.

AS-Interface slaves

Motor starters for operation in the control cabinet

SIRIUS 3RA6 compact feeders
Accessories

Overview

Accessories for SIRIUS 3RA6 compact feeders

The following accessories are available specially for the 3RA6 compact feeders:

- AS-i add-on module: see from Page 6/88 "AS-interface add-on modules"
- External auxiliary switch blocks: Snap-on auxiliary switch as versions 2 NO, 2 NC and 1 NO + 1 NC with screw or spring-type connections; the contacts of the auxiliary switch block open and close jointly with the main contacts of the compact feeder. The NC contacts are designed as mirror contacts.
- Control kit: aid for manually closing the main contacts in order to check the wiring and motor direction under conditions of short-circuit protection
- Adapter for screw fixing the compact feeder, including push-in lugs
- Main circuit terminals: Available with screw and spring-type terminals
- Main circuit terminals mixed connection method: With the main circuit terminals mixed connection method it is also possible in the main circuit to switch from screw terminals on the line side to spring-type terminals on the outgoing side. This enables for example the side-by-side mounting of several compact feeders and their cost-efficient connection using 3-phase busbars on the infeed side. The motors are then connected directly by the quick and reliably contacting spring-type connection method.

Accessories for UL applications

The terminal block for "Self-Protected Combination Motor Controller", type E is available for complying with the clearance and creepage distances demanded according to UL 508.

Accessories for infeed using three-phase busbar systems

The three-phase busbars can be used as an easy, time-saving and clearly arranged means of feeding SIRIUS 3RA6 compact feeders with screw connection. Motor starter protector sizes S00 and S0 can also be integrated.

The busbars are suitable for between 2 and 5 devices. However, any kind of extension up to a maximum summation current of 63 A is possible by clamping the tags of an additional busbar (rotated by 180°) underneath the terminals of the respective last motor starter protector.

A connecting piece is required for the combination with 3RV1 motor starter protector size S00. Motor starter protectors S00 and S0 of the 3RV2 series can be combined in any way (without a special connecting piece). The motor starter protectors are supplied by appropriate feeder terminals. Special feeder terminals are required for constructing "Type E Starters" according to UL/CSA.

The three-phase busbar systems are finger-safe but empty connection tags must be fitted with covers. They are designed for any short-circuit stress which can occur at the output side of connected SIRIUS 3RA6 compact feeders or motor starter protectors.

Busbar adapters for 60 mm systems

The compact starters are mounted directly with the aid of busbar adapters on busbar systems with 60 mm center-to-center clearance in order to save space and to reduce infeed times and costs. These feeders are suitable for copper busbars with a width from 12 to 30 mm. The busbars can be 4 to 5 mm or 10 mm thick.

The 8US busbar system can be loaded with a maximum summation current of 630 A.

The "reversing starter" version requires a device holder along side the busbar adapter for lateral mounting.

The compact feeders are snapped onto the adapter and connected on the line side. This prepared unit is then plugged directly onto the busbar system, and is thus connected both mechanically and electrically at the same time.

Note:

For more accessories such as incoming and outgoing terminals, flat copper profiles etc., see Catalog LV 10.1.

Accessories for operation with closed control cabinet doors







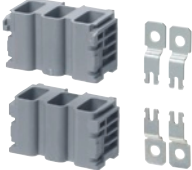

Door-coupling rotary operating mechanisms for standard and emergency-stop applications are available for operating the compact feeder with closed control cabinet doors.

AS-Interface slaves

Motor starters for operation in the control cabinet

SIRIUS 3RA6 compact feeders Accessories

Selection and ordering data

Version	Order No.
Accessories specially for 3RA6 compact feeders	
 3RA69 50-0A	Control kit For mechanical actuation of the compact feeder 3RA69 50-0A
 3RA69 40-0A	Adapters for screw fixing the compact feeder (set including push-in lugs) Direct-on-line starters require one set, reversing starters two sets. 3RA69 40-0A
 3RA69 11-1A	Auxiliary switch blocks for compact feeders <ul style="list-style-type: none"> • 2 NO • 2 NC • 1 NO +1 NC (these auxiliary contacts are positively driven.)
 3RA69 20-1A	Main circuit terminals (incoming and outgoing side) 3RA69 20-1A
 3RA69 20-1B	Control circuit terminals <ul style="list-style-type: none"> • For 3RA61 • For 3RA62
 3RA69 11-2A	Auxiliary switch blocks for compact feeders <ul style="list-style-type: none"> • 2 NO • 2 NC • 1 NO +1 NC (these auxiliary contacts are positively driven.)
 3RA69 20-2A	Main circuit terminals (incoming and outgoing side) 3RA69 20-2A
 3RA69 20-2B	Control circuit terminals <ul style="list-style-type: none"> • For 3RA61 • For 3RA62
	Screw terminals 
	3RA69 11-1A 3RA69 12-1A 3RA69 13-1A
	Spring-type terminals 
	3RA69 11-2A 3RA69 12-2A 3RA69 13-2A
	3RA69 20-2B 3RA69 20-2C

AS-Interface slaves Motor starters for operation in the control cabinet

SIRIUS 3RA6 compact feeders Accessories

Selection and ordering data (continued)

Version	Order No.
---------	-----------

Accessories specially for 3RA6 compact feeders (continued)



3RA69 20-3A

Main circuit terminals mixed connection method

- 1 set comprises:
- 1 joint block on the line side with screw terminals
 - 1 joint block on the outgoing side with spring-type terminals

3RA69 20-3A

Version	Order No.
---------	-----------

Terminals for "Self-Protected Combination Motor Controllers (Type E)" acc. to UL 508 for infeed through parallel wiring with compact feeders



3RV19 28-1H

Note:
UL 508 demands 1-inch clearance and 2-inch creepage distance at line side for "Combination Motor Controller Type E". Terminal blocks are not required for use according to CSA. These terminal blocks cannot be used in combination with 3RV19 .5 three-phase busbars.

Terminal blocks type E

For extended clearance and creepage distances (1 and 2 inch)

3RV19 28-1H

Number of compact feeders and motor starter protectors that can be connected	Modular spacing	Rated current I_n at 690 V	For motor starter protectors	Order No.
Without lateral accessories	mm	A	Size	

Three-phase busbars for infeed with 3RA6



3RV19 15-1AB



3RV19 15-1BB



3RV19 15-1CB



3RV19 15-1DB

For feeding several compact feeders and/or motor starter protectors with screw terminals, mounted side by side on standard mounting rails, insulated, with touch protection.

2	45	63	S00, S0 ¹⁾
3	45	63	S00, S0 ¹⁾
4	45	63	S00, S0 ¹⁾
5	45	63	S00, S0 ¹⁾

3RV19 15-1AB
3RV19 15-1BB
3RV19 15-1CB
3RV19 15-1DB

¹⁾ Not suitable for 3RV11/3RV21 motor starter protectors for motor protection with overload relay function and for 3RV17/3RV27 and 3RV18/3RV28 circuit breakers according to UL 489 / CSA C22.2 No.5-02. Joint clamping of 3RV1 motor starter protector sizes S00 and S0 is not possible on account of the different modular spacings and the different height of the terminals. The 3RV19 15-5DB connecting piece is available for connecting the compact feeders to the 3RV1 motor starter protector size S00. Motor starter protectors S00/S0 of the 3RV2 series can be jointly clamped; no connecting piece has to be used.

Version	Modular spacing	For motor starter protectors	Order No.
	mm	Size	

Covers for connection tags of the three-phase busbars



3RV19 15-6AB

Touch protection for empty positions

--

S00, S0

3RV19 15-6AB

AS-Interface slaves



Motor starters for operation in the control cabinet

SIRIUS 3RA6 compact feeders Accessories

Selection and ordering data (continued)

Conductor cross-section		Tightening torque	For compact feeders and motor starter protectors	Order No.
Solid or stranded	Finely stranded with end sleeve			
mm ²	mm ²	Nm	Size	

Three-phase feeder terminals for three-phase busbars

 3RV19 25-5AB	Connection from top		10-4	4	S0	3RV19 25-5AB
	2.5 ... 25	4 ... 16				
 3RV19 15-5B	Connection from below ¹⁾		10-4	Input: 4; Output: 2 ... 2.5	S00, S0	3RV19 15-5B
	2.5 ... 25	4 ... 16				

Three-phase feeder terminals for constructing "Type E Starters" according to UL 508 for three-phase busbars

Connection from top		10-4	--	S0	3RV19 25-5EB
2.5 ... 25	4 ... 16				

¹⁾ This terminal is connected in place of a switch, please take the space requirement into account.

Version	Order No.
---------	-----------

Busbar adapters for 60 mm systems

 8US12 11-1NS10	For flat copper profiles according to DIN 46433	8US12 11-1NS10
	Width: 12 ... 30 mm Thickness: 4 ... 5 mm or 10 mm	

Device holders for lateral mounting along side the busbar adapter for 60 mm systems

 8US12 50-1AA10	Required in addition to the busbar adapter for mounting a reversing starter	8US12 50-1AA10

Version	Color of handle	Version of extension shaft	Order No.
		mm	

Door-coupling rotary operating mechanisms for operating the compact feeder with closed control cabinet doors



 3RV29 26-0B	The door-coupling rotary operating mechanisms consist of a knob, a coupling driver and a 130/330 mm long extension shaft (6 mm x 6 mm). The door-coupling rotary operating mechanisms are designed to degree of protection IP65. The door interlocking prevents accidental opening of the control cabinet door in the ON position of the motor starter protector. The OFF position can be locked with up to 3 padlocks.			
	Door-coupling rotary operating mechanisms	Black	130	3RV29 26-0B
	EMERGENCY-STOP door-coupling rotary operating mechanisms	Red/yellow	130	3RV29 26-0C

AS-Interface slaves

Motor starters for operation in the control cabinet

SIRIUS 3RA6 compact feeders
Accessories

Selection and ordering data (continued)

Version	Order No.
Tools for opening spring-type terminals	
 Screwdrivers for all SIRIUS devices with spring-type terminals Length approx. 200 mm, 3.0 mm x 0.5 mm, titanium gray/black, partially insulated 3RA29 08-1A	Spring-type terminals  3RA29 08-1A
Blank labels	
 Unit labeling plates ¹⁾ for SIRIUS devices 20 mm x 7 mm, pastel turquoise 3RT 19 00-1SB20	3RT 19 00-1SB20
Documentation ²⁾	
System manual SIRIUS Compact Feeders and Accessories German	3RA69 91-0A

¹⁾ PC labeling system for individual inscription of unit labeling plates available from: murrplastik Systemtechnik GmbH www.murrplastik.com

²⁾ This manual and other language versions are currently available from the download center of the Service & Support portal at <https://support.automation.siemens.com/WW/view/en/27136554/133300>.

AS-Interface slaves

Motor starters for operation in the control cabinet

SIRIUS 3RA6 compact feeders Add-on modules for AS-Interface

Overview

Various AS-i add-on modules are available for communication of the 3RA6 compact feeder with the control system using AS-Interface:

- Standard version
- With two local inputs
- With two free external inputs
- With one free external input and one free external output
- With two free external outputs
- For local control

The AS-i add-on modules can be combined only in connection with compact feeders with a rated control supply voltage of 24 V AC/DC.

AS-i add-on module for on-site controller

With this new module it is also possible for the connected compact feeder to be operated directly using simple switches, i.e. without recourse to AS-i Communication, if required.

"Automatic" mode

NC contacts can be connected to the inputs Y2 and Y4 through the local terminals on the AS-i add-on module. If the "+" connections are connected simultaneously to both local inputs, the AS-i add-on module will be in "Automatic" mode, i.e. it will communicate with the control system through AS-Interface.

On-site control

Opening the two inputs Y2 and Y4 will result in the direct disconnection of the compact feeder. Operation through AS-i Communication is ended and the compact feeder can now be switched on and off directly using NO contacts (one NO contact per direction of rotation on the reversing starter).

"LED AUX Power" must light up green, the 24 V DC supply must be assured and the AS-i control supply voltage must no longer be applied.

Resetting to "Automatic" mode

Simultaneous application of a "1" signal at the local inputs. The availability bit DI 0 is switched to a "1" signal.

If AS-i Communication is reset, the motor is first switched off and then on again when requested by the control system.

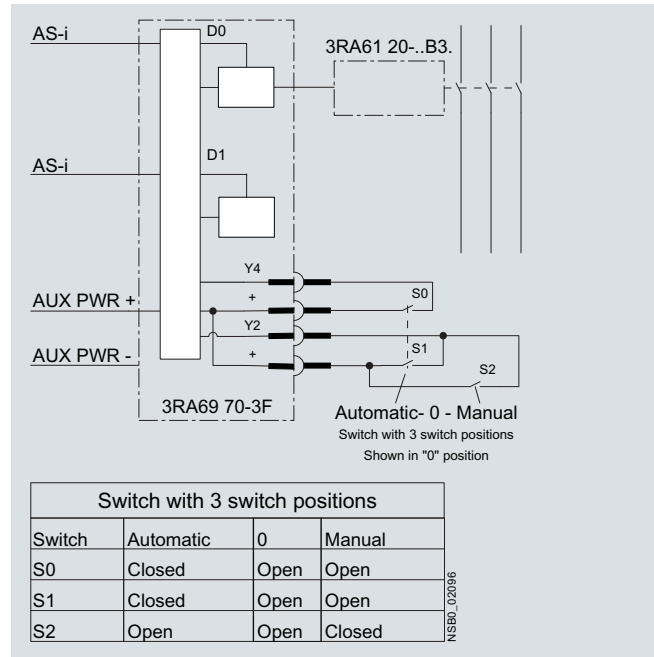

Circuit example for controlling a 3RA61 20 direct-on-line starter using an AS-i add-on module for on-site control

6

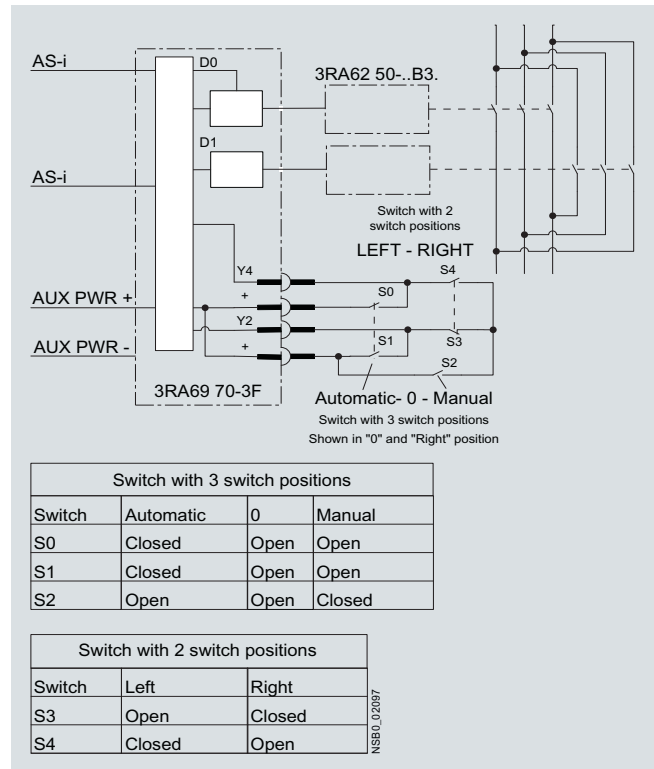





Circuit example for controlling a 3RA62 50 reversing starter using an AS-i add-on module for on-site control

AS-Interface slaves

Motor starters for operation in the control cabinet

SIRIUS 3RA6 compact feeders
Add-on modules for AS-Interface

Selection and ordering data

Version	Order No.
AS-i add-on modules	
 <p>3RA69 70-3A</p>	<p>Standard version For communication of the compact feeder with the control system using AS-Interface</p> <p>3RA69 70-3A</p>
 <p>3RA69 70-3B to -3F</p>	<p>With two local inputs For safe disconnection through local safety relays, e.g. cable-operated switches</p> <p>3RA69 70-3B</p>
	<p>With two free external inputs Replaces the digital standard inputs "Motor On" and "Group warning"</p> <p>3RA69 70-3C</p>
	<p>With one free external input and one free external output Replaces the digital standard input "Group warning"</p> <p>3RA69 70-3D</p>
	<p>With two free external outputs Only for direct-on-line starters, replaces the digital standard output "Motor left"</p> <p>3RA69 70-3E</p>
	<p>For local control Control of the compact feeder optionally using AS-Interface or local switches</p> <p>3RA69 70-3F</p>
Spare parts for AS-i add-on modules	
	<p>Connectors for data and auxiliary supply cable with 2 insulation piercing connecting devices for standard wires 2 x 0.5 ... 0.75 mm²</p> <ul style="list-style-type: none"> • flat, yellow, extender • flat, black, extender <p>3RK19 01-0NA00 3RK19 01-0PA00</p>
Accessories for AS-i add-on modules	
 <p>3RK19 04-2AB02</p>	<p>AS-Interface addressing unit V 3.0</p> <ul style="list-style-type: none"> • For AS-Interface modules and sensors and actuators with integrated AS-Interface in accordance with AS-i Specification V3.0 • For setting the AS-i address of standard slaves, and slaves with extended addressing mode (A/B slaves) • With input/output test function and many other -commissioning functions • Battery operation with 4 batteries type AA (IEC LR6, NEDA 15) • Scope of supply: <ul style="list-style-type: none"> - Addressing unit with 4 batteries - Addressing cable, with M12 plug to addressing plug (hollow plug), length 1.5m <p>3RK19 04-2AB02</p>

AS-Interface slaves

Motor starters for operation in the control cabinet

SIRIUS 3RA6 compact feeders Infeed system for 3RA6

Overview

The infeed system for 3RA6 compact feeders enables far less wiring in the main circuit and, thanks to the easy exchangeability of the compact feeders, reduces the usual downtimes for maintenance work during the plant's operating phase.

The infeed system provides the possibility of completely pre-wiring the main circuit without a compact feeder needing to be connected at the same time. As the result of the removable terminals in the main circuit, compact feeders can be integrated in an infeed system in easy manner (without the use of tools).

In addition, the integrated PE bar means it is optionally possible to connect the motor cable directly to the infeed system without additional intermediate terminals. The infeed system for 3RA6 compact feeders is designed for summation currents up to 100 A with a maximum conductor cross-section of up to 70 mm² on the feeder terminal block.

The infeed system can be mounted on a standard mounting rail or flat surfaces.

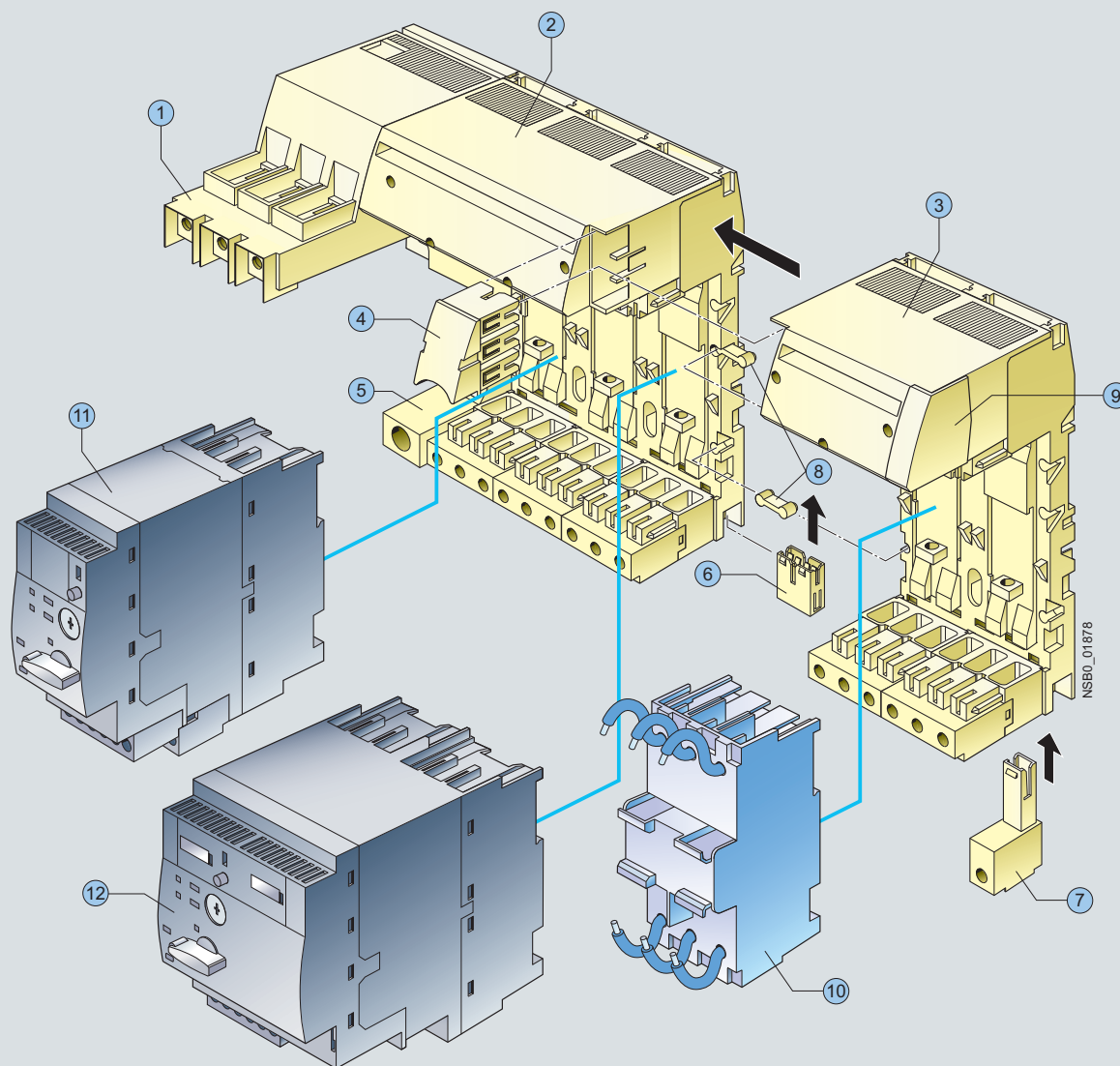

- | | |
|---------------------------------|--|
| ① Feeder terminal | ⑦ PE pick-off |
| ② Three-socket expansion module | ⑧ Connecting wedges |
| ③ Two-socket expansion module | ⑨ End cover |
| ④ Expansion plug | ⑩ 45 mm adapter for SIRIUS motor starter protector size S0 |
| ⑤ PE infeed | ⑪ 3RA61 direct-on-line starter |
| ⑥ PE expansion plug | ⑫ 3RA62 reversing starter |

Infeed system for 3RA6 compact feeders

AS-Interface slaves

Motor starters for operation in the control cabinet

SIRIUS 3RA6 compact feeders
Infeed system for 3RA6

Overview (continued)

① Infeed

The 3-phase infeed is available with screw connection (25/35 mm² up to 63 A or 50/70 mm² up to 100 A) and spring-type connection (25/35 mm² up to 63 A).

The infeed with spring-type terminal can be fitted on the left as well on as the right to an expansion module.

The infeed with screw terminal is supplied only with a 3-socket expansion module and permanently fitted on the left side.

The infeeds with screw connection enable connection of the main conductors (L1, L2, L3) either from above or from below.

The infeed with screw connection is supplied complete with 1 end cover, the infeed with spring-type connection complete with 2 end covers.

② Three-socket expansion modules

The expansion module with 3 sockets for compact feeders is available with screw connection and with spring-type connection.

Expansion modules enable the infeed system to be expanded and can be fitted to each other in any number.

Two expansion modules are held together with the help of 2 connecting wedges and 1 expansion plug. These assembly parts are included in the scope of supply of the respective expansion module.

When the infeed system for 3RA6 is used, the compact feeders (plug-in modules) are easily mounted and removed even when live.

Optional possibilities:

- PE connection on motor outgoing side
- Outfeed for external auxiliary devices
- Connection to 3RV19 infeed system
- Integration of SIRIUS 3RV1 motor starter protectors size S0 (using 3RA68 90-0BA adapter)

③ Two-socket expansion modules

If only 2 instead of 3 additional sockets are required, then the 2-socket expansion module is the right choice. It has the same functionality as the 3-socket expansion module.

④ Expansion plug

Two expansion modules can be connected together using the expansion plug. Flexible expansion of the infeed system is thus possible.

⑤ PE infeeds

This module enables a PE cable to be connected.

The PE infeed can be ordered with screw connection and spring-type connection (35 mm²) and can be fitted on the right or left to the expansion block.

⑥ PE expansion plug

The PE expansion plug is inserted from below and enables two PE bars to be connected.

⑦ PE pick-off

The PE pick-off is available with screw connection and spring-type connection (6/10 mm²). It is snapped into the infeed system from below.

⑧ Connecting wedges

Two connecting wedges are used to hold together 2 expansion modules.

⑨ End covers

On the last expansion module of a row, the socket provided for the expansion plug can be covered by inserting the end cover.

⑩ 45 mm adapters for SIRIUS 3RV1 motor starter protectors

SIRIUS 3RV1 motor starter protectors size S0 with screw connection can be fitted to the adapter, enabling them to be plugged into the infeed system.

IP20 terminal covers for increasing finger-safety

Universally configured terminal covers are available for the 3-phase infeeds with screw connection 25/35 mm² and 50/70 mm²:

- 3RA68 80-2AB terminal covers for infeeds with screw connection 25/35 mm² (3RA68 12-8AB/AC)
- 3RA68 80-3AB terminal covers for infeed with screw connections 50/70 mm² (3RA68 13-8AB/AC)

The terminal covers can be used in two ways on the feeder terminals of the infeeds with screw connection 25/35 mm² and 50/70 mm² (see illustration):

- If the terminals are connected, the cables are also covered:
 - by approx. 14 mm with the 3RA68 80-2AB
 - by approx. 18 mm with the 3RA68 80-3AB
- On clamping points without connected cables, the covers can be turned once and then pushed over the clamping points for finger-safe covering of the metal parts.

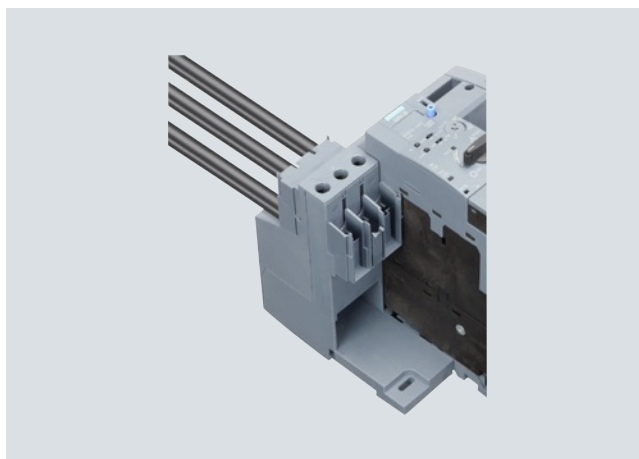

Use of the 3RA68 80-2AB terminal cover on the infeed with screw connection 25/35 mm² (3RA68 12-8AB/AC). The upper cover increases the finger-safety for the connected conductors. The identical lower cover is turned for use and prevents touching of the voltage-carrying metal parts of the feeder terminal.

Terminal blocks

Using the terminal block the 3 phases can be fed out of the system; this means that single-phase, two-phase and three-phase components can also be integrated in the system.

After the end cover is pulled out, the terminal block can be plugged onto an expansion module.

Expansion plug for SIRIUS 3RV19 infeed systems

After the end cover is pulled out, the expansion plug for the SIRIUS 3RV19 infeed system can be plugged onto an expansion module. It connects the infeed system for 3RA6 compact feeders with the SIRIUS 3RV19 infeed system.

AS-Interface slaves

Motor starters for operation in the control cabinet

SIRIUS 3RA6 compact feeders Infeed system for 3RA6

Overview (continued)

Maximum rated operational current

The following maximum rated operational currents apply for the components of the infeed system for 3RA6:

Component	Maximum rated operational current A
Infeed with screw connection 50/70 mm ²	100
Infeed with screw connection 25/35 mm ²	63
Infeed with spring-type connection 25/35 mm ²	63
Expansion plug	63

With side-by-side mounting of several expansion modules, the maximum rated operational current from the second expansion module to the end of the row is 63 A.

Proposal for upstream short-circuit protection devices

The following short-circuit data apply for the components of the infeed system for 3RA6 compact feeders:

Conductor cross-section mm ²	Inscriptions	Proposal for upstream short-circuit protection device
<i>Short-circuit protection for infeed block (25 mm²/35 mm²) with screw connection</i>		
2.5 ... 35	$I_{d, \max} = 19 \text{ kA}$, $I^2t = 440 \text{ kA}^2\text{s}$	3RV10 41-4JA10
<i>Short-circuit protection for infeed block (50/70 mm²) with screw connection</i>		
2.5 ... 70	$I_{d, \max} = \text{approx. } 22 \text{ kA}$	3RV10 41-4MA10
<i>Short-circuit protection for infeed block with spring-loaded connection</i>		
4	$I_{d, \max} = 9.5 \text{ kA}$, $I^2t = 85 \text{ kA}^2\text{s}$	3RV10 21-4DA10
6	$I_{d, \max} = 12.5 \text{ kA}$, $I^2t = 140 \text{ kA}^2\text{s}$	3RV10 31-4EA10
10	$I_{d, \max} = 15 \text{ kA}$, $I^2t = 180 \text{ kA}^2\text{s}$	3RV10 31-4HA10
16/25	$I_{d, \max} = 19 \text{ kA}$, $I^2t = 440 \text{ kA}^2\text{s}$	3RV10 41-4JA10
<i>Short-circuit protection for terminal block</i>		
1.5	$I_{d, \max} = 7.5 \text{ kA}$	5SY... 1)
2.5	$I_{d, \max} = 9.5 \text{ kA}$	
4	$I_{d, \max} = 9.5 \text{ kA}$	
6	$I_{d, \max} = 12.5 \text{ kA}$	

1) To prevent the possibility of short-circuits, the cables on the terminal block must be installed so that they are short-circuit proof according to EN 60439-1 Section 7.5.5.1.2.

AS-Interface slaves

Motor starters for operation in the control cabinet

SIRIUS 3RA6 compact feeders
Infeed system for 3RA6

Selection and ordering data

Version	Order No.
---------	-----------

Three-phase infeeds and expansion modules

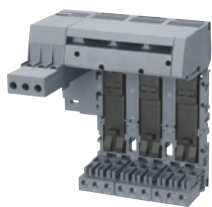

3RA68 12-8AB

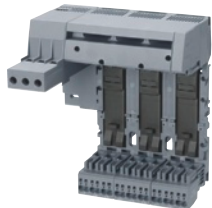

3RA68 12-8AC

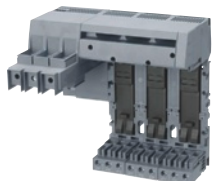

3RA68 13-8AB

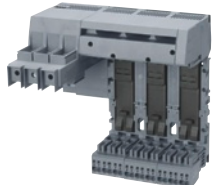

3RA68 13-8AC



3RA68 30-5AC

Infeeds with screw connection 25/35 mm² left

Infeed with screw connection at line side with a permanently fitted 3-socket expansion module with screw or spring-type connection on the outgoing side and integrated PE bar

Expansion module with 3 sockets for 3 direct-on-line starters or 1 direct-on-line starter and 1 reversing starter

- Screw terminals on the outgoing side
- Spring-type terminals on the outgoing side



Screw terminals



3RA68 12-8AB

3RA68 12-8AC

Infeeds with screw connection 50/70 mm² left

Infeed with screw connection at line side with a permanently fitted 3-socket expansion module with screw or spring-type connection on the outgoing side and integrated PE bar

Expansion module with 3 sockets for 3 direct-on-line starters or 1 direct-on-line starter and 1 reversing starter, suitable for UL operation according to UL 508 Type E

- Screw terminals on the outgoing side
- Spring-type terminals on the outgoing side



Screw terminals



3RA68 13-8AB

3RA68 13-8AC

Infeeds with spring-type connection 25/35 mm² left or right

Up to 63 A

Spring-type terminals



3RA68 30-5AC









6

AS-Interface slaves

Motor starters for operation in the control cabinet

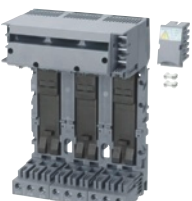
SIRIUS 3RA6 compact feeders Infeed system for 3RA6

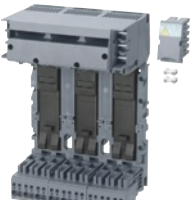
Selection and ordering data (continued)

Version		Order No.
Expansion modules		
 <p>3RA68 22-0AB</p>	<p>Two-socket expansion modules with screw or spring-type terminals and integrated PE bar with 2 sockets for 2 direct-on-line starters or 1 reversing starter Expansion plug and 2 connecting wedges are included in the scope of supply.</p> <ul style="list-style-type: none"> • Screw terminals 	<p>Screw terminals </p> <p>3RA68 22-0AB</p>
 <p>3RA68 22-0AC</p>	<ul style="list-style-type: none"> • Spring-type terminals 	<p>Spring-type terminals </p> <p>3RA68 22-0AC</p>
 <p>3RA68 23-0AB</p>	<p>Three-socket expansion modules with screw or spring-type terminals and integrated PE bar with 3 sockets for 3 direct-on-line starters or 1 direct-on-line starter and 1 reversing starter Expansion plug and 2 connecting wedges are included in the scope of supply.</p> <ul style="list-style-type: none"> • Screw terminals 	<p>Screw terminals </p> <p>3RA68 23-0AB</p>
 <p>3RA68 23-0AC</p>	<ul style="list-style-type: none"> • Spring-type terminals 	<p>Spring-type terminals </p> <p>3RA68 23-0AC</p>

6

AS-Interface slaves

Motor starters for operation in the control cabinet

SIRIUS 3RA6 compact feeders
Infeed system for 3RA6

Selection and ordering data (continued)









Version	Order No.
Accessories for infeed systems for 3RA6	
PE infeeds 25/35 mm²	
 <p>3RA68 60-6AB</p> <ul style="list-style-type: none"> • Screw terminals 	<p>Screw terminals </p> <p>3RA68 60-6AB</p>
 <p>3RA68 60-5AC</p> <ul style="list-style-type: none"> • Spring-type terminals 	<p>Spring-type terminals </p> <p>3RA68 60-5AC</p>
PE pick-offs 6/10 mm²	
 <p>3RA68 70-4AB</p> <ul style="list-style-type: none"> • Screw terminals 	<p>Screw terminals </p> <p>3RA68 70-4AB</p>
 <p>3RA68 70-3AC</p> <ul style="list-style-type: none"> • Spring-type terminals 	<p>Spring-type terminals </p> <p>3RA68 70-3AC</p>
Expansion plug	
 <p>3RA68 90-0EA</p> <p>PE expansion plugs</p>	<p>3RA68 90-0EA</p>
 <p>3RA68 90-1AB</p> <p>Expansion plugs between 2 expansion modules Is included in the scope of supply of the expansion modules.</p>	<p>3RA68 90-1AB</p>
 <p>3RA68 90-1AA</p> <p>Expansion plug for SIRIUS 3RV19 infeed system connects infeed system for 3RA6 to 3RV19 infeed system</p>	<p>3RA68 90-1AA</p>

AS-Interface slaves

Motor starters for operation in the control cabinet

SIRIUS 3RA6 compact feeders
Infeed system for 3RA6

Selection and ordering data (continued)

Version	Order No.
<i>Accessories for infeed systems for 3RA6 (continued)</i>	
 <p>45 mm adapters for SIRIUS 3RV1 motor starter protectors size S0</p> <ul style="list-style-type: none"> Screw terminals (conductor cross-section AWG 10) 	<p>Screw terminals </p> <p>3RA68 90-0BA</p>
 <p>Terminal covers for infeeds with screw connection IP 20 terminal covers for infeeds with screw connection 25/35 mm² (3RA68 12-8AB/AC) (2 units per pack)</p>	<p>3RA68 80-2AB</p>
 <p>IP 20 terminal covers for infeeds with screw connection 50/70 mm² (3RA68 13-8AB/AC) (2 units per pack)</p>	<p>3RA68 80-3AB</p>
 <p>Terminal blocks for integration of single-phase, 2-phase and 3-phase external components</p> <ul style="list-style-type: none"> Spring-type terminals 	<p>Spring-type terminals </p> <p>3RV19 17-5D</p>
<i>Tools for opening spring-type terminals</i>	
 <p>Screwdriver For all SIRIUS devices with spring-type terminals</p> <p>Length approx. 200 mm, 3.0 mm x 0.5 mm, titanium gray/black, partially insulated</p>	<p>Spring-type terminals </p> <p>3RA29 08-1A</p>

Motor starters for operation in the field, high degree of protection

SIRIUS M200D motor starters
General data

Overview



SIRIUS M200D AS-i Basic motor starters with manual on-site operation

The intelligent, highly flexible SIRIUS M200D motor starters for distributed configurations are designed to start, monitor and protect motors and loads up to 5.5 kW.

The M200D motor starters are available in four versions:

M200D AS-i Basic	M200D AS-i Standard	M200D PROFIBUS	M200D PROFINET
Motor control with AS-i Communication		PROFIBUS	PROFINET
Mechanical or electronic switching	✓	✓	✓
Electronic switching with soft starter functionality	--	✓	✓

✓ Function is available

-- Function is not available

Basic functionality

All M200D motor starter versions have the following functions:

- Available as direct-on-line and reversing starters in a rugged design
- Electromechanical or solid-state switching version
- Little variance – only 2 device versions up to 5.5 kW thanks to wide range setting
- All versions have the same enclosure dimensions
- Degree of protection IP65
- Quick and failsafe wiring of system and motor cables using ISO 23570 plug-in connector technology (Q4/2 and Q8/0)
- Robust and widely used M12 connection method for digital inputs and outputs
- Integrated feeder connector monitoring
- Full motor protection through overload protection and a temperature sensor (PTC, TC)
- Short-circuit and overload protection integrated
- Integrated repair switch lockable with 3 locks (multi-level service)
- Uniform wiring to the G110D/G120D frequency converters and to the ET 200pro distributed peripherals system
- Extensive diagnostics concept using LEDs
- Optional integrated manual on-site controller with key-operated switch (ordering option)
- Optionally available brake actuation with voltages from 180 V DC (no rectifier needed in motor) or 230/400 V AC (order versions)

6

Benefits

M200D motor starters provide the following advantages for customers:

- High plant availability through plug-in capability of the main circuit, communication and IOs – relevant for installing and replacing devices
- Cabinet-free construction and near-motor installation thanks to the high degree of protection IP65
- The motor starters record the actual current flow for the parameterizable electronic motor overload protection. Reliable messages concerning the overranging or underranging of setpoint values for comprehensive motor protection. All motor protection functions can be defined by simple parameterization
- Low stock levels and low order costs through a wide setting range for the current or a wide setting range for the electronic motor protection of 1:10 (only 2 device versions up to 5.5 kW)
- The integrated wide range for the current enables a single device to cover numerous standard motors of different sizes
- Comprehensive offering of accessories, including ready-assembled cables
- The M200D motor starters can be installed with a few manual steps. The integrated plug-in technology significantly reduces the wiring outlay: preassembled cables can be plugged directly onto the motor starter module
- Easy and user-friendly installation because all versions have the same enclosure dimensions
- Fast and user-friendly commissioning using an optional manual on-site controller
- Increase of process speed through integrated functions such as "Quick-Stop" and "Disable Quick-Stop", e.g. at points and crossings
- Optional manual on-site controller with momentary-contact and latching operation for easier start-up and easier service

Application

The high degree of protection IP65 makes the M200D motor starters suitable in particular for use on extensive conveying systems such as are found in mail sorting centers, airports, automotive factories and the packing industry.

For simple operating mechanism tasks, particularly in conveyor applications, the new SINAMICS G110D frequency converter series with a performance range from 0.75 kW to 7.5 kW and degree of protection IP65 is the ideal partner for the M200D motor starters.

The SINAMICS G110D frequency converters permit continuous speed control of three-phase asynchronous motors and meet the requirements of conveyor applications with frequency control (for more information, see Catalog D 11.1 "SINAMICS G110, G120 ...").

AS-Interface slaves

Motor starters for operation in the field, high degree of protection

SIRIUS M200D motor starters M200D motor starters for AS-Interface

Overview

For motor control using AS-Interface there are the following M200D motor starter versions: SIRIUS M200D AS-i Basic and SIRIUS M200D AS-i Standard (for details of basic functionality see Page 6/97 "M200D motor starters" --> "General data" --> "Overview").

SIRIUS M200D AS-i Basic

Functionality

- Easy and fast on-site start-up through parameterization of local setting elements (DIP switches) and rotary coding switches for adjusting the rated operational current. The rotary coding switch has an OFF position for deactivating the overload protection with the help of the thermal motor model when using a temperature sensor.

Communication

- AS-i communication with A/B addressing according to Spec V2.1
- The AS-i bus is connected cost-effectively using an M12 connection on the device. Of the 4 digital inputs, 2 are contained in the process image and can therefore be used in the PLC program. The other 2 inputs are locally effective and permanently assigned with functions.
- The LEDs can provide comprehensive diagnostics of the device on the spot. In addition to diagnostics using the PAE process image, the device can create up to 15 different diagnostic signals per slave. The message with the highest priority can be read out through the AS-i communication. This is yet another new development which distinguishes the M200D AS-i Basic motor starter from the rest of the market and adds innovative technology, maximum availability and transparency to the system.

SIRIUS M200D AS-i Standard

The intelligent, highly flexible M200D AS-i Standard motor starters in A/B technology are designed to start and protect motors and loads up to 5.5 kW. They are available in direct-on-line or reversing starter versions, in a mechanical version and also an electronic version (the latter with soft start function).

The M200D AS-i Standard motor starter is the most functional member of the SIRIUS motor starter family in the high degree of protection IP65 for AS-i Communication. Consistency with other products of the SIRIUS M200D motor starter range and with the frequency converter and ET 200pro peripherals system is assured.

Functionality

- AS-i communication with A/B addressing according to Spec 3.0
- Electronic version also with soft start function
- AS-i slave profile 7AE/7A5 with process image 6I/4O
- Full TIA integration: All digital inputs and outputs exist in the cyclic process image and are visible through AS-i, providing maximum flexibility and best adaptability to the application.
- Additionally expanded diagnostics using data record through AS-i bus
- Complete plant monitoring using statistics data record and current value monitoring by means of data records
- Parameterization through AS-i bus with the help of data records or an expanded process image from the user program
- Control of the motor starter using a command data record from the user program
- Flexible assignment of the digital inputs and outputs with all available assignable input actions
- Parameterization using Motor Starter ES at the local interface (ordering option for start-up software)
- Diagnostics with the help of Motor Starter ES (ordering option for start-up software)

Mounting and installation

The M200D motor starters can be installed with a few manual steps. The integrated plug-in technology enables far lower wiring outlay. Connecting cables can be plugged directly onto the motor starter module. Swapping of the connecting wires and malfunctions within the plant are prevented by preassembled cables. The AS-i bus is connected cost-effectively using an M12 connection on the device. All versions have identical enclosure dimensions for easier system configuration and conversion.

Parameterization and configuration

The particularly robust M200D AS-i Standard motor starter is characterized by numerous functions which can be flexibly parameterized. It enables highly flexible parameterization through the AS-i bus using data records from the user program as well as user-friendly local parameterization using the Motor Starter ES start-up software through the local point-to-point interface.

Functions can be flexibly assigned to the digital inputs and outputs, adapting them to all possible conveyor applications. All motor protection functions, limit values and reactions can be defined by parameterization. The AS-i Standard is unique. In its 6I/4O process image the motor starter sends all 4 digital inputs and the digital output via the process image to the PLC in cyclic mode. System configuration and system documentation are facilitated not least by a number of CAX data.

Operation

The new motor starter generation is characterized by high functionality, maximum flexibility and the highest level of automation.

All digital inputs and outputs exist in the cyclic process image. All limit values for monitoring functions and their reactions are parameterizable and therefore adaptable to the application. The motor starters record the actual current flow. Evaluating the current of the parameterizable solid-state overload protection increases the availability of the drives, as do reliable messages concerning the overranging or underranging of setpoint values.

Diagnostics and maintenance

The M200D sets new standards for diagnostics. In addition to diagnostics using the PAE process image and diagnostics by "parameter echo" (up to 15 different diagnostic signals per slave can be read out via AS-i Communication), the possibility of reading out diagnostic data records is unique on the market.

The AS-i Standard is recommended in particular for expansive and highly automated plant parts because the possibility of monitoring devices and systems with data records (statistical data, measured values and device diagnostics) provides an in-depth view of the plant from the control room, guaranteeing the monitoring process and increasing plant availability.

The integrated maintenance timer can be used to implement preventative maintenance and avoid plant downtimes through look-ahead servicing.

Local on-site control of a drive is possible using the ordering option with integrated manual operation. This is yet another new development which distinguishes the M200D AS-i Standard motor starter from the rest of the market and adds innovative technology, maximum availability and transparency to the plant.

AS-Interface slaves

Motor starters for operation in the field, high degree of protection

SIRIUS M200D motor starters
M200D motor starters for AS-Interface

Overview (continued)



SIRIUS M200D
AS-i Basic



SIRIUS M200D
AS-i Standard

Device functions (firmware features)

Slave on the bus

Fieldbus	✓ AS-i	
Slave type	✓ A/B acc. to Spec 2.1	✓ A/B acc. to Spec 3.0
Profile	✓ 7.A.E	✓ 7.A.E & 7.A.5
Number of assigned AS-i addresses on the bus	✓ 1	✓ 2
Number of stations per AS-i master	✓ Maximum 62 devices	✓ Maximum 31 devices
AS-i master profile	✓ M3 and higher	✓ M4 and higher

Parameterization

DIP switches	✓	--
Potentiometer for rated operational current	✓	--
ES Motor Starter	--	✓
Data records through AS-i	--	✓

Diagnostics

Diagnostics through parameter channel	✓	
Acyclic through data records	--	✓
Expanded process image PAE 4 bytes	--	✓

Process image

Process image	✓ 4I/3O	✓ 6I/4O
---------------	---------	---------

Data channels

Local optical interface (manual local)	✓	
AS-i bus	✓	
Motor Starter ES through local interface	--	✓
Motor Starter ES through bus	--	

Data records ¹⁾ (acyclic)

Parameterization	--	✓
Diagnostics	--	✓
Measured values	--	✓
Statistics	--	✓
Commands	--	✓

Inputs

Number	✓ 4	
• of these in the process image	✓ 2 through AS-i	✓ 4 through AS-i
Input action	✓ Permanently assigned functions, see manual	✓ Parameterizable: Flexible
Quick-Stop	✓ Permanent function: latching, edge-triggered	✓ Parameterizable function: latching (edge-triggered), non-latching (level-triggered)

Outputs

Number	✓ 1	
Output action	✓ Permanent function: assigned with group fault	✓ Parameterizable: Function, see manual

Brake output

180 V DC / 230/400 V AC / none	✓	
--------------------------------	---	--

Motor protection

Overload protection	✓ Electronic, wide range 1:10	
Short-circuit protection	✓	
Full motor protection	✓	
Temperature sensor	✓ Parameterizable using DIP switches: PTC or Thermoclock or deactivated	✓ Parameterizable using ES Motor Starter, data record: PTC or Thermoclock or deactivated

✓ Function is available.
-- Function not available.

¹⁾ The data records are a reduced selection compared with PROFIBUS/PROFINET.

AS-Interface slaves

Motor starters for operation in the field, high degree of protection

SIRIUS M200D motor starters M200D motor starters for AS-Interface

Overview (continued)



SIRIUS M200D
AS-i Basic



SIRIUS M200D
AS-i Standard

Device functions (firmware features)

Device functions

Repair switch	✓	
Current limit monitoring bottom	--	✓ Parameterizable
Current limit monitoring top	--	✓ Parameterizable
Zero current detection	✓ Permanent function: disconnection, less than 18.75 % of the rated operational current I_e	✓ Parameterizable
Blocking current	✓ Permanent function: Starting up of the motor: tripping limit at 800 % of the rated operational current I_e for 10 s Active operation: Threshold for tripping "blocking current" at 400 % of the rated operational current I_e	✓ Parameterizable
Unbalance	✓ Permanent function: at 30 % of the rated operational current I_e (only mechanical MS)	✓ Parameterizable
Load type	✓ Permanent function: 3-phase	✓ Parameterizable: 1- and 3-phase
Shutdown class	✓ Parameterizable using DIP switches: CLASS 10/deactivated	Parameterizable using ES Motor Starter, data record: CLASS 5, 10, 15, 20
Protection against voltage failure	✓	✓ Parameterizable: Activated/deactivated
Soft starter control function		
Soft start function	--	✓ Only electronic version
Bypass function	--	✓ Only electronic version

✓ Function is available.

-- Function not available.

Application

The M200D AS-i standard is particularly suitable for highly automated applications in conveyor systems, which require that devices and plants be monitored to prevent or limit plant downtime. The option of planning the functions of the motor starter or its interfaces also makes fine-adjustment to the function of the motor starter in the application possible and hence, provides for extreme flexibility.

Motor starters for operation in the field, high degree of protection

M200D motor starters for AS-Interface
M200D Basic motor starters

Selection and ordering data



M200D AS-i Basic without manual on-site operation



M200D AS-i Basic with manual on-site operation

Version	Order No.
<i>Electromechanical starters (with integrated contactor)</i>	3RK1 315-6 ■ S41- ■ AA ■
Setting range for rated operational current / A	
• 0.15 ... 2	K
• 1.5 ... 12	L
Direct-on-line starters/ reversing starters	
• Direct-on-line starters	0
• Reversing starters	1
• Direct-on-line starters with manual local operation	2
• Reversing starters with manual local operation	3
Brake actuation	
• Without brake actuation	0
• Brake actuation (230/400 V AC)	3
• Brake actuation (180 V DC)	5

Version	Order No.
<i>Electronic starters (with thyristors)</i>	3RK1 315-6 ■ S71- ■ AA ■
Setting range for rated operational current / A	
• 0.15 ... 2	K
• 1.5 ... 12	N
Direct-on-line starters/ reversing starters	
• Direct-on-line starters	0
• Reversing starters	1
• Direct-on-line starters with manual local operation	2
• Reversing starters with manual local operation	3
Brake actuation	
• Without brake actuation	0
• Brake actuation (230/400 V AC)	3
• Brake actuation (180 V DC)	5

AS-Interface slaves

Motor starters for operation in the field, high degree of protection

M200D motor starters for AS-Interface
M200D Standard motor starters

Selection and ordering data



M200D AS-i Standard without manual on-site operation



M200D AS-i Standard with manual on-site operation

Version	Order No.
<i>Electromechanical starters (with integrated contactor)</i>	3RK1 325-6 ■ S41- ■ AA ■
Setting range for rated operational current / A	
• 0.15 ... 2	K
• 1.5 ... 12	L
Direct-on-line starters/ reversing starters	
• Direct-on-line starters	0
• Reversing starters	1
• Direct-on-line starters with manual local operation	2
• Reversing starters with manual local operation	3
Brake actuation	
• Without brake actuation	0
• Brake actuation (230/400 V AC)	3
• Brake actuation (180 V DC)	5

Version	Order No.
<i>Electronic starters (with thyristors)</i>	3RK1 325-6 ■ S71- ■ AA ■
Setting range for rated operational current / A	
• 0.15 ... 2	K
• 1.5 ... 12	L
Direct-on-line starters/ reversing starters	
• Direct-on-line starters	0
• Reversing starters	1
• Direct-on-line starters with manual local operation	2
• Reversing starters with manual local operation	3
Brake actuation	
• Without brake actuation	0
• Brake actuation (230/400 V AC)	3
• Brake actuation (180 V DC)	5

Motor starters for operation in the field, high degree of protection

SIRIUS M200D motor starters
Accessories

Overview

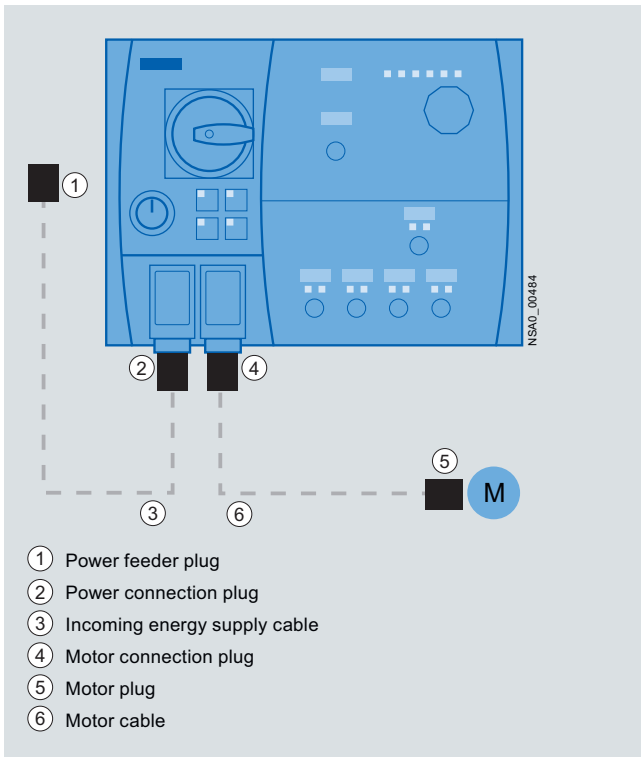
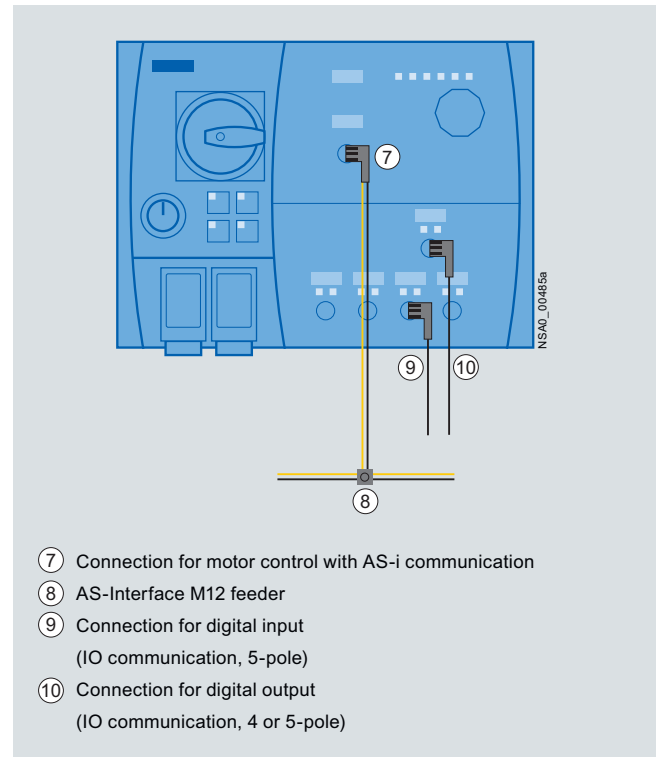
Power and motor connection on the M200D motor starter
(in this example: M200D for AS-i)Communication connection using AS-Interface and
digital inputs and outputs

AS-Interface slaves

Motor starters for operation in the field, high degree of protection

SIRIUS M200D motor starters Accessories

Selection and ordering data

The accessories listed below represent a basic selection sorted by:

- Accessories for all M200D motor starters
- Accessories for M200D motor starters for AS-interface

Note:

More connection technology products can be found at "Siemens Solution Partners Automation" under the "Distributed Field Installation System" technology.





Version	Order No.
Mountable accessories	
M200D protective brackets	3RK1 911-3BA00
Incoming energy supply	
① Power feeder plugs Connector set for energy supply, e.g. for connecting to T terminal connectors, comprising a coupling enclosure, straight outgoing feeder (with bracket), pin insert for HAN Q4/2, incl. gland <ul style="list-style-type: none"> • 5 male contacts 2.5 mm² • 5 male contacts 4 mm² • 5 male contacts 6 mm² 	3RK1 911-2BS60 3RK1 911-2BS20 3RK1 911-2BS40
② Power connection plugs Connector set for energy supply for connection to M200D motor starters, comprising a cable-end connector hood, angular outgoing feeder, female insert for HAN Q4/2, incl. gland <ul style="list-style-type: none"> • 5 female contacts 2.5 mm² 2 female contacts 0.5 mm² • 5 female contacts 4 mm² 2 female contacts 0.5 mm² • 5 female contacts 6 mm² 2 female contacts 0.5 mm² 	3RK1 911-2BE50 3RK1 911-2BE10 3RK1 911-2BE30
② + ③ Power supply cable Assembled at one end with "N" and jumper pin 11 and 12 for plug monitoring, with HAN Q4/2, angular; open at one end; 5 x 4 mm ² <ul style="list-style-type: none"> • Length 1.5 m • Length 5.0 m 	3RK1 911-0DC13 3RK1 911-0DC33
Motor cables	
④ Motor connection plugs Connector set for motor cable for connection to M200D motor starters, comprising a cable-end connector hood, angular outgoing feeder, pin insert for HAN Q8/0, incl. gland <ul style="list-style-type: none"> • 8 male contacts 1.5 mm² • 6 male contacts 2.5 mm² 	3RK1 902-0CE00 3RK1 902-0CC00
⑤ Motor plugs Connector set for motor cable for connection to motors, comprising a cable-end connector hood, straight outgoing feeder, female insert for HAN 10e, incl. star jumper, incl. gland <ul style="list-style-type: none"> • 7 female contacts 1.5 mm² • 7 female contacts 2.5 mm² 	3RK1 911-2BM21 3RK1 911-2BM22
④ + ⑥ Motor cables, assembled at one end For connection to M200D motor starter, HAN Q8/0, angled, length 5 m <ul style="list-style-type: none"> • Motor cables for motor with brake, 4 x 1.5 mm² • Motor cables for motor without brake with thermistor, 6 x 1.5 mm² • Motor cable for motor with brake actuation, braking voltage 400 V AC or 180 V DC, 6 x 1.5 mm² • Motor cable for motor with brake actuation, braking voltage 400 V AC or 180 V DC and thermistor, 8 x 1.5 mm² • Motor cable for motor with brake actuation, braking voltage 230 V AC, 6 x 1.5 mm² • Motor cable for motor with brake actuation, braking voltage 230 V AC and thermistor, 8 x 1.5 mm² 	3RK1 911-0EB31 3RK1 911-0EF31 3RK1 911-0ED31 3RK1 911-0EG31 3RK1 911-0EH31 3RK1 911-0EE31

AS-Interface slaves

Motor starters for operation in the field, high degree of protection



SIRIUS M200D motor starters
Accessories

Selection and ordering data (continued)

Version	Order No.
Motor control with IO communication ¹⁾	
 M12 plugs Screw fixing, 5-pole screw terminals, max. 0.75 mm ² , A-coded, max. 4 A 3RK1 902-4BA00-5AA0	3RK1 902-4BA00-5AA0
 ⓫ M12 plugs, angled Screw fixing, 5-pole screw terminals, max. 0.75 mm ² , A-coded, max. 4 A 3RK1 902-4DA00-5AA0	3RK1 902-4DA00-5AA0
 Ⓞ, ⓫ Control cables, assembled at one end M12 plugs, angled, screw fixing, 5-pole, 5 x 0.34 mm ² , A-coded, black PUR sheath, max. 4 A <ul style="list-style-type: none"> • Cable length 1.5 m • Cable length 5 m • Cable length 10 m 3RK1 902-4H...-5AA0	3RK1 902-4HB15-5AA0 3RK1 902-4HB50-5AA0 3RK1 902-4HC01-5AA0
 Control cable, assembled at both ends Straight M12 plug, straight M12 socket, screw fixing, 3-pole, 3 x 0.34 mm ² , A-coded, black PUR sheath, max. 4 A <ul style="list-style-type: none"> • Cable length 1.5 m 3RK1 902-4PB15-3AA0	3RK1 902-4PB15-3AA0

¹⁾ For additional plug-in connections, see Catalog ID 10.

Further accessories





 Hand-held device for M200D motor starter, (also for ET 200pro, ET 200S High Feature and ECOFAST), for on-site operation. A 3RK1 922-2BP00 serial interface cable must be ordered separately. 3RK1 922-3BA00	3RK1 922-3BA00
RS 232 interface cables for serial data circuit 3RK1 922-2BP00	3RK1 922-2BP00
Dismantling tools for HAN Q4/2 3RK1 902-0AB00	3RK1 902-0AB00
Crimping tools for pins/sockets 4 mm² and 6 mm² 3RK1 902-0CW00	3RK1 902-0CW00
Crimping tools for male contacts and sockets up to 4 mm² (HAN Q8/0) 3RK1 902-0CT00	3RK1 902-0CT00
Dismantling tools for male contacts and sockets (HAN Q8/0) 3RK1 902-0AJ00	3RK1 902-0AJ00
USB interface cables, 2.5 m long 6SL3555-0PA00-2AA0	6SL3555-0PA00-2AA0
7/8" sealing caps 6ES7194-3JA00-0AA0	6ES7194-3JA00-0AA0
 AS-Interface sealing caps M12 For sealing unused input and output sockets – not for M12-AS-i connections (one set contains 10 sealing caps) 3RK1 901-1KA00	3RK1 901-1KA00

AS-Interface slaves



Motor starters for operation in the field, high degree of protection

SIRIUS M200D motor starters Accessories

Selection and ordering data (continued)

Version	Order No.																				
Only for M200D motor starters for AS-interface																					
Motor control with AS-i communication ¹⁾																					
 ⑦ Control cables, assembled at one end Angular M12 socket, screw fixing, 4-pole, 4 x 0.34 mm ² , A-coded, black PUR sheath, max. 4 A • Cable length 5 m 3RK1 902-4GB50-4AA0	3RK1 902-4GB50-4AA0																				
 ⑦ M12 socket, angled, screw fixing, 4-pole screw terminal, max. 0.75 mm ² , A-coded, max. 4 A 3RK1 902-4CA00-4AA0	3RK1 902-4CA00-4AA0																				
⑧ AS-Interface M12 feeder																					
 3RK1 901-1NR21	<table border="1"> <thead> <tr> <th>For flat cable</th> <th>For</th> <th>Cable length</th> <th>Cable end in feeder</th> <th></th> </tr> </thead> <tbody> <tr> <td>AS-i / U_{aux}</td> <td>M12 socket</td> <td>--</td> <td>Not available</td> <td>3RK1 901-1NR20</td> </tr> <tr> <td>AS-i / U_{aux}</td> <td>M12 cable box</td> <td>1 m</td> <td>Not available</td> <td>3RK1 901-1NR21</td> </tr> <tr> <td>AS-i / U_{aux}</td> <td>M12 cable box</td> <td>2 m</td> <td>Not available</td> <td>3RK1 901-1NR22</td> </tr> </tbody> </table>	For flat cable	For	Cable length	Cable end in feeder		AS-i / U _{aux}	M12 socket	--	Not available	3RK1 901-1NR20	AS-i / U _{aux}	M12 cable box	1 m	Not available	3RK1 901-1NR21	AS-i / U _{aux}	M12 cable box	2 m	Not available	3RK1 901-1NR22
For flat cable	For	Cable length	Cable end in feeder																		
AS-i / U _{aux}	M12 socket	--	Not available	3RK1 901-1NR20																	
AS-i / U _{aux}	M12 cable box	1 m	Not available	3RK1 901-1NR21																	
AS-i / U _{aux}	M12 cable box	2 m	Not available	3RK1 901-1NR22																	
 3RK1 901-1MN00	Cable terminating pieces For sealing of open cable ends (shaped AS-Interface cable) in IP67 3RK1 901-1MN00																				

Further accessories

 3RK1 904-2AB02	AS-Interface addressing unit V 3.0 <ul style="list-style-type: none"> • For AS-Interface modules and sensors and actuators with integrated AS-Interface in accordance with AS-i Specification V3.0 • For setting the AS-i address of standard slaves, and slaves with extended addressing mode (A/B slaves) • With input/output test function and many other -commissioning functions • Battery operation with 4 batteries type AA (IEC LR6, NEDA 15) • Scope of supply: <ul style="list-style-type: none"> - Addressing unit with 4 batteries - Addressing cable, with M12 plug to addressing plug (hollow plug), length 1.5 m 	3RK1 904-2AB02
 3RK1 902-4PB15-3AA0	M12 addressing cables to M12 <ul style="list-style-type: none"> • Standard M12 cable for addressing slaves with M12 connection, e.g. K60R modules • When using the current version of the 3RK1 904-2AB01 addressing unit • 1.5 m 	3RK1 902-4PB15-3AA0

Motor starters for operation in the field, high degree of protection

SIRIUS MCU motor starters
General data

Overview



3RK43 20-3.R51-.BA0

3RK43 20-3.Q54-.BA.

3RK43 20-5.Q64-.BA.

Portfolio of the SIRIUS 3RK43 MCU motor starter family

The SIRIUS MCU motor starter family (MCU = Motor Control Unit) rounds off the bottom end of the SIRIUS motor starter range.

This series of motor starters in a high degree of protection is a system solution for the cabinet-free controlling of AC loads in the field.

The MCU product range extends from I/O-controlled motor starters – addressing a central sub-distribution board via I/O stations – in a plastic enclosure for simple applications to motor starters with AS-i communication in a rugged metal enclosure for demanding tasks. (For full range, see Catalog IC 10 --> Motor starters for operation in the field, high degree of protection)

The MCU motor starters are completely pre-wired inside, have a high degree of protection and are designed for switching and protecting any AC loads. They are mostly used on standard induction motors in direct or reversing duty up to 5.5 kW at 400/500 V AC (electromechanical switching) and 400/460 V AC (electronic switching).

The motor and short-circuit protection integrated in the MCUs consists either of an electromechanical controlgear assembly or solid-state overload protection and a motor starter protector unit for short-circuit protection.

MCUs with metal enclosure are designed for the switching of induction motors. Integrated control of the electrically operated motor brake with a braking voltage of 230 V AC or 400 V AC is a standard feature. The braking voltage is routed to the motor over the motor cable.

SIRIUS MCU motor starters have the following main features:

- Direct-on-line or reversing starters
- Up to 5.5 kW
- High degree of protection, namely IP55 on MCU motor starters in a plastic enclosure and IP54 on motor starters in a metal enclosure, enables distributed configurations in the field and saves space in the control cabinet
- Electromechanical or electronic switching
- Easy and user-friendly control and monitoring through AS-Interface bus communication
- Controlled stopping through brake control 230 V AC or 400 V AC for motor brake
- Integrated lockable repair switch
- Comprehensive motor protection thanks to integrated overload and short-circuit protection with SIRIUS 3RV motor starter protectors or integrated solid-state overload relays (solid-state starters)
- Overload protection with thermal release (bimetal) or solid-state overload relay with wide range setting
- Power and load connection by means of an M screw

- Main power loop possible (daisy chain; max. 2 x 6 mm²)
- Robust and widely used M12 connection method for digital inputs and outputs to connect I/O stations and the AS-i bus connection increase flexibility and prevent errors in the system configuration.
- The LEDs (for AS-i bus connection) can provide comprehensive diagnostics of the device on the spot.
- Simple mounting for AS-i and external auxiliary voltage (24 V DC) over an M12 connection
- Manual operation: An integrated key-operated switch "MAN-0-AUTO" and a selector button for switching on, switching off and changing the direction of rotation for control purposes during commissioning or maintenance

MCU motor starters with AS-i bus connection in a plastic enclosure

This motor starter version offers an economical solution for controlling and monitoring conveyor belts, pumps, fans or compressors.

On this MCU the control commands and the status queries are sent over the AS-i bus. The yellow cable (bus) and the black AS-i cable for 24 V DC AUX are connected through a M12 plug.

The transparent enclosure top permits monitoring of the status LEDs. These MCUs come completely pre-wired inside.

MCU motor starters with AS-i bus connection in a metal enclosure for electromechanical or electronic switching

These MCUs with their rugged metal enclosure in degree of protection IP54 are ideal in particular for controlling and monitoring induction motors in harsh ambient conditions such as are often found in conveyor systems.

A special feature of this version is the manual local operation of the motor starter.

The key-operated switch "MAN-0-AUTO" for selecting Manual, 0 or Automatic mode prevents unauthorized changes of operating mode. In automatic mode the MCU is controlled through the AS-i bus.

In manual mode a selector button is used for switching on, switching off and changing the direction of rotation.

The status/diagnostics LEDs fitted to the cover indicate the current operating state of the motor starter.

Unlike the electromechanical starter, the solid-state motor starter has wear-free solid-state switching devices which guarantee a high switching frequency.

Another highlight of the electronic switching version is the solid-state overload relay for motor protection, which has a wide setting range for the motor current.

AS-Interface slaves

Motor starters for operation in the field, high degree of protection

SIRIUS MCU motor starters General data

Overview (continued)

			
	3RK43 20-3.R51-BA0	3RK43 20-3.Q54-BA.	3RK43 20-5.Q64-BA.
Type	SIRIUS MCU motor starters for AS-Interface		
	Plastic enclosures	Metal enclosures	Metal enclosures
	Electromechanical Switching	Electromechanical Switching	Electronic Switching

Device functions (software features)

Slave on the bus

Fieldbus	✓	AS-i	
Bus connection	✓	M12	
Slave type	✓	AS-i Spec 2.0	✓ A/B acc. to Spec 2.1
AS-i Slave Profile IO.ID.ID2	✓	3.0.F	✓ 7.A.E
Number of assigned AS-i addresses on the bus	✓	1	
Number of stations	✓	Maximum 31 devices	✓ Maximum 62 devices

Diagnostics

LEDs	✓		
------	---	--	--

Process image

Process image	✓	2I/2O	✓ 4I/3O
---------------	---	-------	---------

Data channels

Manual local operation	--		✓
------------------------	----	--	---

Inputs

Number	✓	1	✓ 2
• of these in the process image	✓	DI1	✓ DI2 / DI3
Connection	✓	Screw terminal, internal	✓ M12 – A coded
Input signal	✓	Switching contact or 2-wire Bero	✓ Switching contact or 2/3-wire Bero
Input level	✓	AS-i +	

Outputs

Number	✓	1 on the direct-on-line starter 0 on the reversing starter	✓ 1
• of these in the process image	✓	DO1	✓ DO2
Connection	✓	Screw terminal, internal	✓ M12 – A coded
Output level	✓	Relay contact, floating	✓ AUX-PWR+ (24 V DC)

Motor protection

Overload protection	✓	Thermal overload releases	✓ Electronic overload releases Wide range
Short-circuit protection	✓		
Auto-RESET	--		✓
Temperature sensor	--		✓ TC (Thermoclick)

Device functions

Response when repair switch is tripped	✓	Signal through AS-i	
Plug monitoring	--		Possible (with plug option)

✓ Function is available

-- Function not available.

AS-Interface slaves

Motor starters for operation in the field, high degree of protection

MCU motor starters for AS-Interface
Plastic enclosures, electromechanical switching

Overview

MCU for AS-i, plastic enclosure

- Direct-on-line or reversing starters up to 12 A at 400 V AC (50/60 Hz)
- Repair switches (black/gray) lockable with padlocks (max. 3 units)
- Integrated overload and short-circuit protection with SIRIUS 3RV motor starter protectors Class 10 with short-circuit breaking capacity $I_{cu} = 50 \text{ kA}$ at 400 V AC
- Overload protection with thermal release (bimetal)
- Transparent plastic enclosure with LED status displays for monitoring the AS-i status
- Degree of protection IP55
- Cable connections by means of M screws
- Main power loop possible (daisy chain; max. $2 \times 6 \text{ mm}^2$)
- AS-Interface through M12 plug-in terminal
- 4 x M20 glands enclosed
- Communication: AS-Interface 2I/2O (standard slaves)

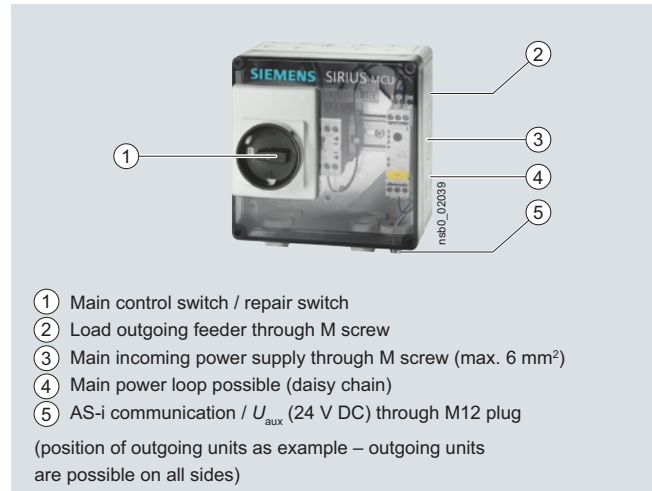

MCU for AS-i, plastic enclosure

Selection and ordering data

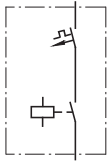
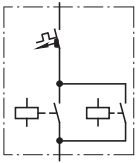
	Rated current I_e	Suitable for three-phase induction motors ¹⁾ with P	Setting range Thermal overload release	Order No.
	A	kW	A	
Direct-on-line starters				
 Direct-on-line start	0.63	0.18	0.45 ... 0.63	3RK43 20-3AR51-0BA0
	0.8	0.18	0.55 ... 0.8	3RK43 20-3BR51-0BA0
	1	0.25	0.7 ... 1	3RK43 20-3CR51-0BA0
	1.25	0.37	0.9 ... 1.25	3RK43 20-3DR51-0BA0
	1.6	0.55	1.1 ... 1.6	3RK43 20-3ER51-0BA0
	2	0.75	1.4 ... 2	3RK43 20-3FR51-0BA0
	2.5	0.75	1.8 ... 2.5	3RK43 20-3GR51-0BA0
	3.2	1.10	2.2 ... 3.2	3RK43 20-3HR51-0BA0
	4	1.50	2.8 ... 4	3RK43 20-3JR51-0BA0
	5	1.50	3.5 ... 5	3RK43 20-3KR51-0BA0
	6.3	2.20	4.5 ... 6.3	3RK43 20-3LR51-0BA0
	8	3.00	5.5 ... 8	3RK43 20-3MR51-0BA0
	10	4.00	7 ... 10	3RK43 20-3NR51-0BA0
12.5	5.50	9 ... 12.5	3RK43 20-3PR51-0BA0	
Reversing starters				
 Reversing duty	0.63	0.18	0.45 ... 0.63	3RK43 20-3AR51-1BA0
	0.8	0.18	0.55 ... 0.8	3RK43 20-3BR51-1BA0
	1	0.25	0.7 ... 1	3RK43 20-3CR51-1BA0
	1.25	0.37	0.9 ... 1.25	3RK43 20-3DR51-1BA0
	1.6	0.55	1.1 ... 1.6	3RK43 20-3ER51-1BA0
	2	0.75	1.4 ... 2	3RK43 20-3FR51-1BA0
	2.5	0.75	1.8 ... 2.5	3RK43 20-3GR51-1BA0
	3.2	1.10	2.2 ... 3.2	3RK43 20-3HR51-1BA0
	4	1.50	2.8 ... 4	3RK43 20-3JR51-1BA0
	5	1.50	3.5 ... 5	3RK43 20-3KR51-1BA0
	6.3	2.20	4.5 ... 6.3	3RK43 20-3LR51-1BA0
	8	3.00	5.5 ... 8	3RK43 20-3MR51-1BA0
	10	4.00	7 ... 10	3RK43 20-3NR51-1BA0
12.5	5.50	9 ... 12.5	3RK43 20-3PR51-1BA0	

¹⁾ Guide value for 4-pole standard motors at 50 Hz 400 V AC. The actual starting and rated data of the motor to be protected must be considered when selecting the units.

AS-Interface slaves

Motor starters for operation in the field, high degree of protection

MCU motor starters for AS-Interface
Metal enclosures, electromechanical switching

Overview

MCU for AS-i, metal enclosure, electromechanical

- Direct-on-line or reversing starters up to 12 A
- Repair switches (black/gray) lockable with padlocks (max. 3 units)
- Short-circuit protection with SIRIUS 3RV motor starter protectors CLASS 10 with short-circuit breaking capacity $I_{cu} = 50 \text{ kA}$ at 400 V AC
- Overload protection with thermal release (bimetal)
- Manual operation and key-operated switch for operating mode selection
- LED status display of the operating states
- Metal enclosures
- Degree of protection IP54
- Switched brake control 400 V or 230 V
- Cable connections by means of M screws
- Main power loop possible (daisy chain; max. $2 \times 6 \text{ mm}^2$)
- 2 x M25 glands
- 1 x M12 plug for AS-i/auxiliary voltage (24 V DC)
- 2 x M12 socket for connection of 2 sensors
- 1 x M12 socket for connection of one actuator
- Communication: AS-Interface 4I/3O (slaves in A/B technology can be addressed)

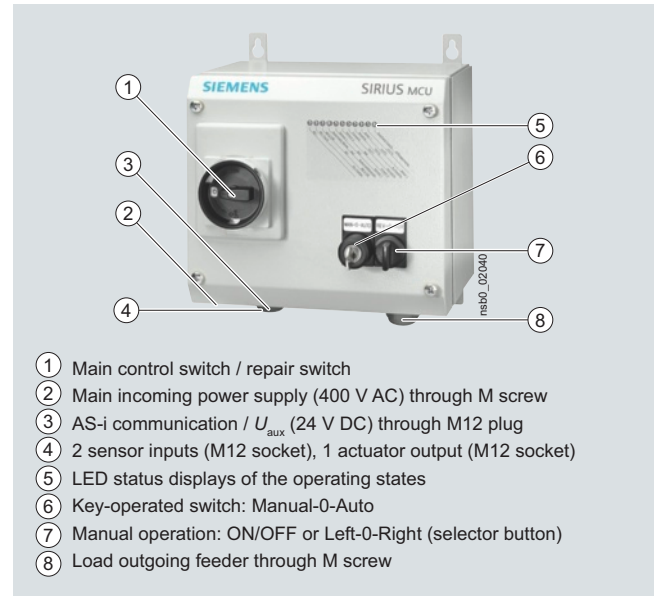

MCU for AS-i, metal enclosure, electromechanical switching

AS-Interface slaves

Motor starters for operation in the field, high degree of protection

MCU motor starters for AS-Interface
Metal enclosures, electromechanical switching

Selection and ordering data

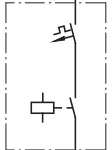
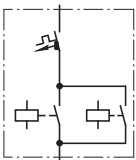
	Rated current I_e	Suitable for three-phase induction motors ¹⁾ with P	Setting range Thermal overload release	Order No.
	A	kW	A	
Direct-on-line starters				
	0.63	0.18	0.45 ... 0.63	3RK43 20-3AQ54- 0BA
	0.8	0.18	0.55 ... 0.8	3RK43 20-3BQ54- 0BA
	1	0.25	0.7 ... 1	3RK43 20-3CQ54- 0BA
	1.25	0.37	0.9 ... 1.25	3RK43 20-3DQ54- 0BA
	1.6	0.55	1.1 ... 1.6	3RK43 20-3EQ54- 0BA
	2	0.75	1.4 ... 2	3RK43 20-3FQ54- 0BA
	2.5	0.75	1.8 ... 2.5	3RK43 20-3GQ54- 0BA
	3.2	1.10	2.2 ... 3.2	3RK43 20-3HQ54- 0BA
	4	1.50	2.8 ... 4	3RK43 20-3JQ54- 0BA
	5	1.50	3.5 ... 5	3RK43 20-3KQ54- 0BA
	6.3	2.20	4.5 ... 6.3	3RK43 20-3LQ54- 0BA
	8	3.00	5.5 ... 8	3RK43 20-3MQ54- 0BA
	10	4.00	7 ... 10	3RK43 20-3NQ54- 0BA
	12.5	5.50	9 ... 12.5	3RK43 20-3PQ54- 0BA
Brake control / V				
• 230				
• 400				
Reversing starters				
	0.63	0.18	0.45 ... 0.63	3RK43 20-3AQ54- 1BA
	0.8	0.18	0.55 ... 0.8	3RK43 20-3BQ54- 1BA
	1	0.25	0.7 ... 1	3RK43 20-3CQ54- 1BA
	1.25	0.37	0.9 ... 1.25	3RK43 20-3DQ54- 1BA
	1.6	0.55	1.1 ... 1.6	3RK43 20-3EQ54- 1BA
	2	0.75	1.4 ... 2	3RK43 20-3FQ54- 1BA
	2.5	0.75	1.8 ... 2.5	3RK43 20-3GQ54- 1BA
	3.2	1.10	2.2 ... 3.2	3RK43 20-3HQ54- 1BA
	4	1.50	2.8 ... 4	3RK43 20-3JQ54- 1BA
	5	1.50	3.5 ... 5	3RK43 20-3KQ54- 1BA
	6.3	2.20	4.5 ... 6.3	3RK43 20-3LQ54- 1BA
	8	3.00	5.5 ... 8	3RK43 20-3MQ54- 1BA
	10	4.00	7 ... 10	3RK43 20-3NQ54- 1BA
	12.5	5.50	9 ... 12.5	3RK43 20-3PQ54- 1BA
Brake control / V				
• 230				
• 400				

¹⁾ Guide value for 4-pole standard motors at 50 Hz 400 V AC. The actual starting and rated data of the motor to be protected must be considered when selecting the units.

AS-Interface slaves

Motor starters for operation in the field, high degree of protection

MCU motor starters for AS-Interface Metal enclosures, electronic switching

Overview

MCU for AS-i, metal enclosure, electronic

- Direct-on-line or reversing starters up to 12 A
- Switching frequency up to 3 600/h
- Repair switches (black/gray) lockable with padlocks (max. 3 units)
- Short-circuit protection with SIRIUS 3RV motor starter protector
- Overload protection with solid-state overload relay
- Manual operation and key-operated switch for operating mode selection
- LED status display of the operating states
- Metal enclosures
- Degree of protection IP54
- Switched brake control 400 V or 230 V
- Cable connections by means of M screws
- Main power loop possible (daisy chain; max. $2 \times 6 \text{ mm}^2$)
- 2 x M25 glands
- 1 x M12 plug for AS-i/auxiliary voltage (24 V DC)
- 2 x M12 plugs for connection of 2 sensors
- 1 x M12 socket for connection of one actuator
- Communication: AS-Interface 4I/3O (slaves in A/B technology can be addressed)

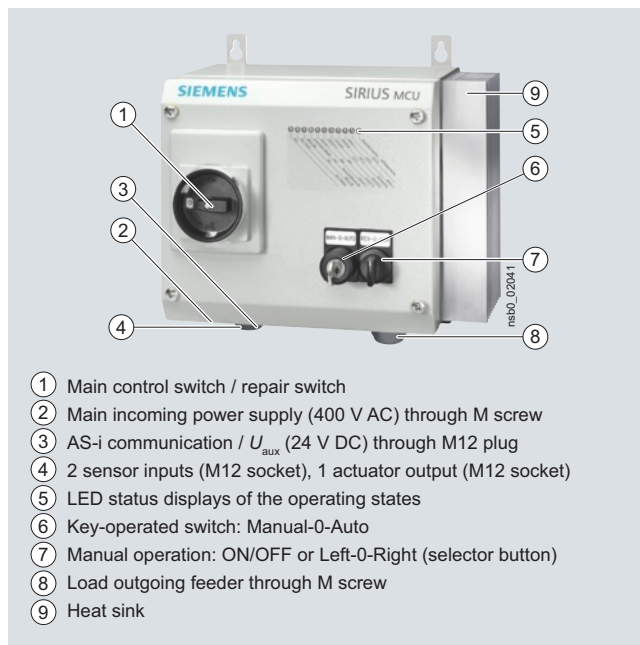

MCU for AS-i, metal enclosure, electronic switching

6

Selection and ordering data

	Rating for induction motor Rated value ¹⁾	Current setting value of the inverse-time delayed overload release I_e	Brake control	Order No.
	kW	A	V	
Direct-on-line starters				
	0.12 ... 0.37	0.32 ... 1.25	230	3RK43 20-5DQ64-0BA2
	0.55 ... 1.5	1 ... 4	230	3RK43 20-5JQ64-0BA2
	1.1 ... 5.5	3 ... 12	230	3RK43 20-5PQ64-0BA2
	0.12 ... 0.37	0.32 ... 1.25	400	3RK43 20-5DQ64-0BA3
	0.55 ... 1.5	1 ... 4	400	3RK43 20-5JQ64-0BA3
	1.1 ... 5.5	3 ... 12	400	3RK43 20-5PQ64-0BA3
Reversing starters				
	0.12 ... 0.37	0.32 ... 1.25	230	3RK43 20-5DQ64-1BA2
	0.55 ... 1.5	1 ... 4	230	3RK43 20-5JQ64-1BA2
	1.1 ... 5.5	3 ... 12	230	3RK43 20-5PQ64-1BA2
	0.12 ... 0.37	0.32 ... 1.25	400	3RK43 20-5DQ64-1BA3
	0.55 ... 1.5	1 ... 4	400	3RK43 20-5JQ64-1BA3
	1.1 ... 5.5	3 ... 12	400	3RK43 20-5PQ64-1BA3

¹⁾ Guide value for 4-pole standard motors at 50 Hz 400 V AC. The actual starting and rated data of the motor to be protected must be considered when selecting the units.

Motor starters for operation in the field, high degree of protection

MCU motor starters for AS-Interface
Accessories

Overview

The MCU motor starters are equipped with standardized interfaces for data and energy (option).

Notes:

See "Energy communication field installation system" for further information about the field and power bus methods for decentral installation in a high degree of protection.

Connection technology products coordinated with the SIRIUS MCU motor starters can be found at our

"Siemens Automation Solution Partners"

www.siemens.com/automation/partnerfinder

under "Distributed Field Installation System" technology.

AS-Interface slaves

Motor starters for operation in the field, high degree of protection

Motor starters for AS-Interface, 24 V DC General data

Overview

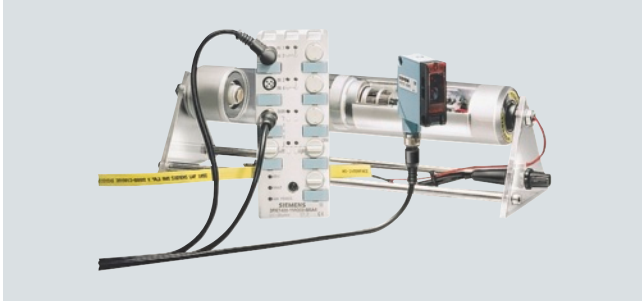

Connection of an actuator roller with integrated DC motor to an AS-Interface 24 V DC motor starter

With the K60 AS-Interface 24 V DC motor starters for the low-end performance range up to 70 W, it is now possible to connect 24 V DC motors and the associated sensors directly to the AS-Interface quickly and easily.

Three different versions are available:

- Single direct-on-line starters (without brake and reversible quick-stop function)
- Double direct-on-line starters (with brake and reversible quick-stop function)
- Reversing starters (with brake and reversible quick-stop function)

DC motors are connected to the module using M12 plug-in connections. The sensors and the module electronics can be supplied from the yellow AS-Interface cable. An auxiliary voltage (24 V DC) is only required for supplying the outputs, which can be provided via the black AS-Interface cable.

Quick-stop function

All AS-Interface 24 V DC motor starters feature a quick-stop function which can be switched on and off as required using a switch integrated into the module. The quick-stop function allows a connected motor to be disconnected immediately using an applied sensor signal (High). The switch for the quick-stop function is located alongside the input sockets and is protected by an M12 sealing cap.

Brake

The double direct-on-line starter and the single reversing starter versions feature an integrated permanently set brake function, i.e. as soon as the output signal is set to "0", the motor is braked.

Start-up using integrated buttons

Buttons integrated into the module (below the output sockets) can be used to set the motor used. The buttons are protected by an M12 sealing cap.

Note concerning double and reversing starters:

If an input with the quick-stop function receives a "High" signal, the corresponding output (e.g. quick-stop input 1 → output 1) is switched off within the device (the motor is braked). The manual key function (Key 1/2) for local operation is only permitted to be used during "CPU Stop" in the higher-level PLC.

Note concerning single direct-on-line starters:

If an input with the quick-stop function receives a "High" signal, the corresponding output (e.g. quick-stop input 1 → output 1) is switched off within the device (the motor runs down without being braked). The manual key function (Key 1) for local operation is only permitted to be used and defined during "CPU Stop" in the higher-level PLC.

Motor starters for operation in the field, high degree of protection

Motor starters for AS-Interface, 24 V DC
General data

Overview (continued)

Applications

Single direct starter without brake (with adjustable quick-stop function)

1st possibility: Connection to a maximum of four sensors without pollution indication

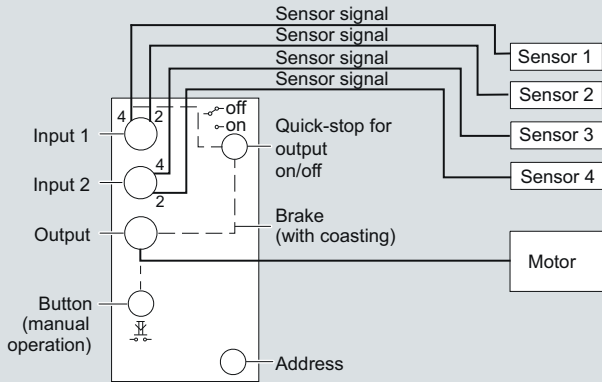

2nd possibility: Connection to a maximum of two sensors with pollution indication

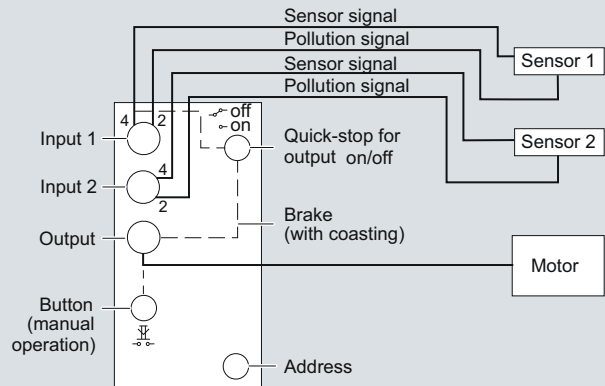

Double direct starter with brake (with adjustable quick-stop function)

1st possibility: Connection to a maximum of four sensors without pollution indication

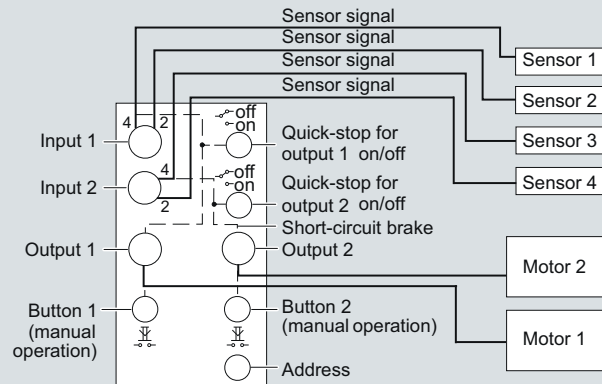

2nd possibility: Connection to a maximum of two sensors with pollution indication

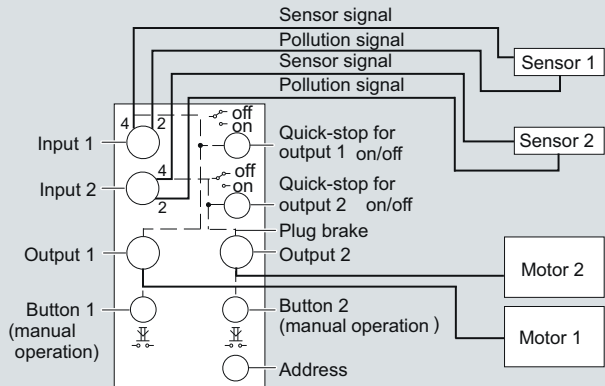

Single reversing starter with brake (with adjustable quick-stop function)

1st possibility: Connection to a maximum of four sensors without pollution indication

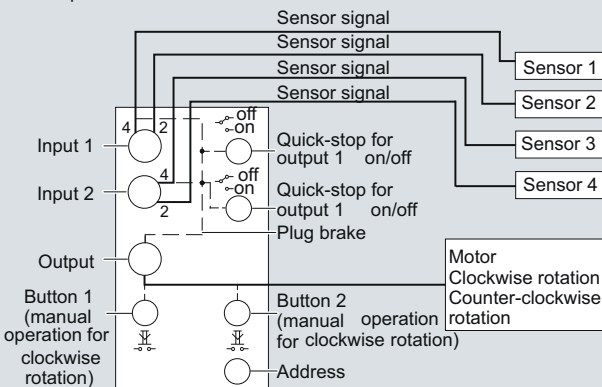

2nd possibility: Connection to a maximum of two sensors with pollution indication

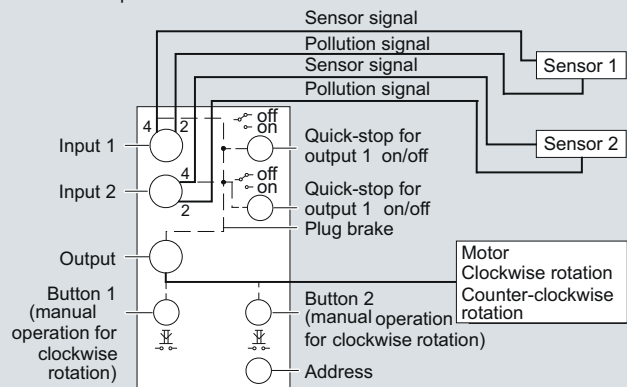

AS-Interface slaves

Motor starters for operation in the field, high degree of protection

Motor starters for AS-Interface, 24 V DC General data

Selection and ordering data

Version	Inputs/outputs	Current carrying capacity of outputs	Slave type	Order No.
---------	----------------	--------------------------------------	------------	-----------

Motor starters (width 60 mm)



Single direct-on-line starters ¹⁾	4 inputs / 1 output	2	Standard	3RK1 400-1NQ01-0AA4
Double direct-on-line starters ¹⁾	4 inputs / 2 outputs	1 x 3 or 2 x 2	Standard	3RK1 400-1MQ01-0AA4
Single reversing starters ¹⁾	4 inputs / 1 output	2.5	Standard	3RK1 400-1MQ03-0AA4

3RK1 400-1MQ01-0AA4

¹⁾ Modules supplied without mounting plate.

Version	Order No.
---------	-----------

Accessories



3RK1 901-0CA00

K60 mounting plates
Suitable for all K60 compact modules

- Wall mounting
- Standard rail mounting

3RK1 901-0CA00
3RK1 901-0CB01



3RK1 901-1KA00

AS-Interface sealing caps M12
For free M12 sockets

3RK1 901-1KA00

3RK1 901-1KA01

AS-Interface sealing caps M12, tamper-proof
For free M12 sockets

3RK1 901-1KA01

3RK1 902-0AR00

Sealing sets

- For K60 mounting plate and standard distributor
- Cannot be used for K45 mounting plate
- Set contains one straight and one shaped seal

3RK1 902-0AR00

AS-Interface slaves

SINAMICS G110D distributed frequency converters

General data

Overview

The new distributed frequency converter series SINAMICS G110D is the solution for demanding drive applications, particularly in the field of conveyor applications. The converter permits continuous speed control of three-phase asynchronous motors and meets the requirements of conveyor applications with frequency control. With its compact and flat design in IP65 degree of protection, it slots into the system optimally. The drive can be excellently linked into the Siemens TIA automation world using AS-Interface.

With its large performance range from 0.75 kW to 7.5 kW it is suitable for numerous distributed drive solutions.



Example: SINAMICS G110D size FSA

Reasons for distributed drive technology

- Modular drive solutions – and thus standardized mechatronic elements that can be tested individually
- Control cabinets are dispensed with, meaning that less space and cooling are required
- Long motor cables are dispensed with between converter and motor (less power loss, lower interference emissions and lower costs for shielded cables and additional filters)
- For conveyor applications with their large spatial range (e.g. in the automotive and logistics industries), the distributed installation methods bring great benefits

Siemens distributed drive family

For optimal realization of distributed drive solutions, Siemens offers an innovative range of frequency converters. The strengths of the individual family members permit a simple adaptation to extremely varied application requirements:

- Identical connection technology
- Identical installation dimensions of SINAMICS G110D and SINAMICS G120D
- Uniform commissioning and configuration tool

Products of the distributed drives family:

- SINAMICS G110D frequency converters
- SINAMICS G120D frequency converters
- SIMATIC ET 200S FC frequency converters
- SIMATIC ET 200pro FC frequency converters
- SIRIUS M200D motor starters

Device configuration

SINAMICS G110D is a compact converter in IP65 degree of protection which integrates the control unit (CU) and power module (PM) function units into a single device.

The control electronics controls and monitors the power electronics and the connected motor in several selectable control types. The digital and analog inputs on the device permit the simple wiring of sensors directly to the drive. The input signals can either be connected directly within the control unit and trigger autonomous local reactions, or they are passed to a central control system via AS-Interface where they are processed in the context of the system as a whole.

The power electronics supply the motor in a performance range from 0.75 kW to 7.5 kW. They are controlled by the microprocessor of the control system. For extremely reliable and flexible motor operation, the latest IGBT technology with pulse width modulation is used. Comprehensive protection functions provide a high degree of protection for the frequency converter and motor. The unusually flat mechanical design is optimized for use direct in the system. The compact frequency converter has the same hole dimensions for all powers (constant "footprint") and the dimensions are also identical to those of the SINAMICS G120D frequency converter. This makes the design, installation and conversion of the system considerably easier.

Up-to-date technical documentation (catalogs, dimensional drawings, certificates, manuals and operating instructions) are available on the Internet at:

www.siemens.com/sinamics-g110d/documentation

and offline on the DVD-ROM CA 01 in the DT configurator.

In addition, the DT configurator can be used on the Internet without installation. The DT configurator can be found in the Industry Mall at the following address:

www.siemens.com/dt-configurator

STARTER commissioning tool

The STARTER commissioning tool (from V4.1.3) makes the commissioning and maintenance of the SINAMICS G110D converter easier. It offers operator prompting for quick and easy commissioning, combined with user-friendly and comprehensive functions for the drive solution.

AS-Interface slaves

SINAMICS G110D distributed frequency converters

General data

Benefits

- Wide performance range from 0.75 kW to 7.5 kW
- Rapid commissioning and maintenance thanks to expanded diagnostics functions and communication capability with AS-Interface in accordance with Specification 3.0
 - Reduction of interfaces
 - System-wide engineering
 - Simple handling
- The design, installation and conversion of the system are made much easier by the compact and space-saving design with its very flat form and identical hole dimensions for all powers; the dimensions are also identical to those of the SINAMICS G120D converter.
- Simple commissioning and maintenance thanks to identical, standardized plug-in connections for the bus, power and I/O connections (ISO 23570) over the entire performance range of the SINAMICS G110D and SINAMICS G120 D frequency converters.
- Use of the same plug for SIRIUS M200D motor starter
- Simple, consistent realization of complete, distributed system concepts by the scalable use of the products:
 - SIRIUS M200D (motor starters)
 - SINAMICS G110D (converters for simple conveyor applications)
 - SINAMICS G120D (converters for demanding conveyor applications)
- Very user friendly thanks to the use of the Intelligent Operator Panel (IOP) for parameterization, diagnostics and control and for the copying of drive parameters in the BOP
- Easy replacement thanks to plug-in connections and excellent ease of maintenance thanks to the use of a memory card
- Simple connection, configuration, data storage and control of the converter in complex systems by consistent integration into TIA (Totally Integrated Automation)
- Thanks to the optional maintenance switch it is easy to disconnect the converter from the network for servicing without having to provide for additional components or additional wiring outlay during configuration.
- The optional manual on-site operation allows rapid spatially restricted commissioning, manual pre-testing of the application on site and validation running to be performed without expensive options
- Thanks to the option of the direct connection of up to five sensors to the device, almost all drive-related information can be managed directly; a local pre-processing of the signals relieves the field bus whilst ensuring a rapid and reproducible response time
- Integrated EMC filter Class A (according to EN 55011)
- Integrated brake actuation, supported braking voltages 400 V AC / 180 V DC and 230 V AC / 205 V DC
- Integrated motor protection thanks to thermal motor model and evaluation of PTC, Thermo-Click or KTY 84 temperature sensors
- Simple device replacement and time-saving copying of parameters to the memory card by the optional memory card holder and the optional MMC memory card
- Engineering and commissioning with uniform engineering tools such as SIZER (from V3.2), STARTER (from V4.1.3) and Drive ES ensure rapid configuration and simple commissioning – with Drive ES Basic STARTER is integrated into STEP 7 providing the benefits of central data storage and consistent communication
- Software parameters for simple adaptation to 50 Hz or 60 Hz motors (IEC or NEMA motors)
- Increased robustness and longer service life due to painting of the electronics assemblies
- Certified worldwide according to CE, UL, c-tick

AS-Interface slaves

SINAMICS G110D distributed frequency converters

General data

Application

SINAMICS G110D is perfectly suited for simple conveyor applications in an industrial environment in which a distributed drive with communication capability is required. This is particularly true for distribution logistics and for airports.

SINAMICS G110D is also suitable for many other lower-performance applications in many fields, e.g. in the automotive industry, in the food and drinks industry (without tensides) and in the packaging industry.

Selection and ordering data

Rated power ¹⁾		Rated output current ²⁾	Input current	Size	SINAMICS G110D with integrated Class A line filter	SINAMICS G110D with integrated Class A line filter and integrated maintenance switch
kW	hp	A	A		Order No.	Order No.
3 AC 380 ... 500 V ³⁾						
0.75	1	2.3	2.0	FSA	6SL3511-0PE17-5AM0	6SL3511-1PE17-5AM0
1.5	1.5 ⁴⁾	4.3	3.8	FSA	6SL3511-0PE21-5AM0	6SL3511-1PE21-5AM0
3	4	7.7	7.0	FSA	6SL3511-0PE23-0AM0	6SL3511-1PE23-0AM0
4	5	10,2	9.1	FSB	6SL3511-0PE24-0AM0	6SL3511-1PE24-0AM0
5.5	7.5	13.2	12.2	FSC	6SL3511-0PE25-5AM0	6SL3511-1PE25-5AM0
7.5	10	19.0	17.9	FSC	6SL3511-0PE27-5AM0	6SL3511-1PE27-5AM0

- ¹⁾ Rated power based upon rated output current I_N .
The rated output current I_N underlies the load alternation at high overload (HO).
- ²⁾ The rated output current I_N underlies the load alternation at high overload (HO). These current values apply at 400 V and are given on the rating plate.
- ³⁾ Outside UL operation 500 V +10 % is possible.
- ⁴⁾ No standard assignment possible.

AS-Interface slaves

SINAMICS G110D distributed frequency converters

General data

Selection and ordering data (continued)

	Order No.		Order No.
Accessories		Accessories (continued)	
Manual on-site control with key-operated switch Simple operation for local operation and commissioning	6SL3 255-0AA00-4HA0	Plug-in connector set for braking resistor For the use or connection of other braking resistors to the SINAMICS G110D	6SL3 563-4RA00-0GA00
RS232 interface cables Connection cable for the commissioning of the SINAMICS G110D frequency converter with the STARTER commissioning tool	3RK1 922-2BP00	UL plug-in connector set For power and motor for the use of SINAMICS G110D in UL-compatible applications	6SL3 563-4UA00-0GA0
USB interface cable Connection cable for the commissioning of the SINAMICS G110D frequency converter with the STARTER commissioning tool	6SL3 555-0PA00-2AA0	Memory card The parameterization of a converter can be saved on the memory card. For service purposes, e.g. after replacement of a converter and retrieval of data from the memory card, the system is ready for use again immediately.	
Braking resistors for SINAMICS G110D frequency converters For the reduction of excess power from the link		<ul style="list-style-type: none"> SINAMICS Micro Memory Card (MMC) SIMATIC Memory Card (SD card) 	6SL3 254-0AM00-0AA0 6ES7 954-8LB00-0AA0
<ul style="list-style-type: none"> Rated power 0.75 kW and 1.5 kW Rated power 3 kW and 4 kW Rated power 5.5 kW and 7.5 kW 	6SL3 501-0BE08-6AA0 6SL3 501-0BE12-1AA0 6SL3 501-0BE14-1AA0	Card holder for memory card The use of the memory card requires a card holder that can be plugged in both under the blanking cover and under the optional manual on-site controller	6SL3 555-0PM00-0AA0
Intelligent Operator Panel IOP Handheld For use with SIMATIC ET 200S FC or SIMATIC ET 200pro FC frequency converters Included in scope of supply:	6SL3 255-0AA00-4HA0	Plug-in connector set for braking resistor For the use or connection of other braking resistors to the SINAMICS G110D	6SL3 563-4RA00-0GA00
<ul style="list-style-type: none"> Intelligent Operator Panel IOP Handheld enclosure Batteries (4 × AA) Charger (international) RS232 connection cable (length 3 m, may only be used for SINAMICS G120 and SIMATIC ET 200S FC) USB cable (length 1 m) 		UL plug-in connector set For power and motor for the use of SINAMICS G110D in UL-compatible applications	6SL3 563-4UA00-0GA0
Memory card The parameterization of a converter can be saved on the memory card. For service purposes, e.g. after replacement of a converter and retrieval of data from the memory card, the system is ready for use again immediately.		Plug protection bracket To protect the plug against shearing off due to mechanical effects	
<ul style="list-style-type: none"> SINAMICS Micro Memory Card (MMC) SIMATIC Memory Card (SD card) 	6SL3 254-0AM00-0AA0 6ES7 954-8LB00-0AA0	<ul style="list-style-type: none"> For sizes FSA and FSB For size FSC 	6SL3 263-1HA20-0GA0 6SL3 263-1HC20-0GA0
Card holder for memory card Use of the memory card requires a card holder that can be plugged in both under the blanking cover and under the optional manual on-site controller	6SL3 555-0PM00-0AA0	Adapters For installation of the SINAMICS G110D instead of a SIRIUS M200D motor starter	6SL3 263-1GA20-0GA0

Note:

For further information on technical data, accessories and ordering data see Catalog D 31 and Industry Mall at www.siemens.com/industrymall

AS-Interface slaves

3SF5 pushbuttons and indicator lights

AS-Interface enclosures and front panel modules

General data

Overview



Distributed command devices of the 3SB3 series can be quickly connected to the AS-Interface using AS-Interface enclosures. Using suitable components you can make your own enclosures with integrated AS-Interface or flexibly modify existing enclosures.

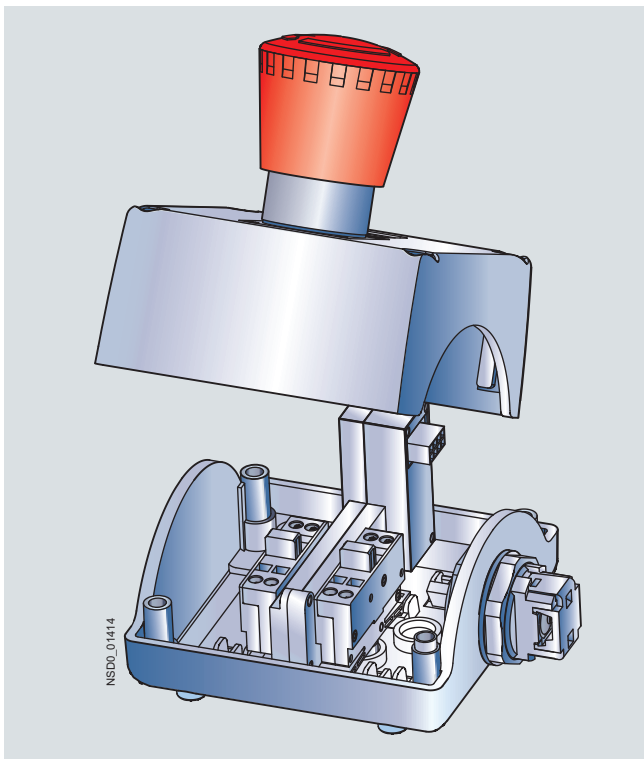

Enclosures

Color of enclosure cover:

- Gray, RAL 7035, or
- Yellow, RAL 1004, for EMERGENCY-STOP.

Color of enclosure base:

- Black, RAL 9005

Installation of AS-Interface slaves

The following slave types are available for connecting the command points:

- Slave in A/B technology with 4 inputs and 3 outputs
- Slave with 4 inputs and 4 outputs
- F Slave with two secure inputs for EMERGENCY-STOP mushroom pushbutton

The following table shows the maximum number of equippable slaves:

Enclosures for	Number of slaves for enclosures without EMERGENCY-STOP	Number of slaves for enclosures with EMERGENCY-STOP
1 command point	Not available	1 x F slave
2 command points	1 x slave 4I/4O or 4I/3O	Not available
3 command points	1 x slave 4I/4O or 4I/3O	1 x slave 4I/4O or 4I/3O + 1 x F slave
4 command points	2 x slave 4I/4O or 4I/3O ¹⁾	2 x slave 4I/4O or 4I/3O + 1 x F slave ¹⁾
6 command points	2 x slave 4I/4O or 4I/3O	2 x slave 4I/4O or 4I/3O + 1 x F slave

¹⁾ For metal enclosures with 4 command points, only 1 x slave 4I/4O or 4I/3O is possible.

Connection

For connecting a slave to contact blocks and lampholders and the connection element, one set of links is needed for each.

The connection elements are mounted in the front-end cable glands and are used for connection of the AS-Interface or for bringing unused inputs or outputs out of the enclosure.

For connection to AS-Interface can be selected between:

- Terminal for shaped AS-Interface cable.
The cable is contacted by the insulation piercing method and routed past the enclosure on the outside (possible only with plastic enclosure).
- Cable gland for the shaped AS-Interface cable or round cable. The cable is routed into the enclosure (preferable for metal enclosure).
- Connection using M12 plug.

If less than all inputs/outputs of the installed slaves in an enclosure are used for connecting the command devices, free inputs and outputs can be routed on request to the outside through an M12 socket on the top or bottom side of the enclosure.

To supply inputs with power, the S+ connection of the must be assigned to the socket, for outputs the OUT- connection must be assigned.

Addressing is performed using the AS-Interface connections or the integrated addressing socket. An external power supply is not required.

Note:

Dimensional drawings, manuals and further technical information can be found on the Internet at: www.siemens.com/industrial-controls/support

AS-Interface slaves

3SF5 pushbuttons and indicator lights

AS-Interface enclosures and front panel modules With standard fittings

Overview

Enclosures with standard fittings are available with:

- 1 to 3 command points
- Operational voltage through AS-Interface (approx. 30 V)
- Vertical mounting type
- Plastic enclosures are equipped with plastic actuators and indicators, metal enclosures are equipped with metal actuators and indicators.





The enclosures without EMERGENCY-STOP each have one user module with 4I/3O; the enclosures with EMERGENCY STOP mushroom pushbuttons have a safe AS-Interface slave integrated in the enclosure.

Enclosures with EMERGENCY-STOP mushroom pushbuttons are fitted with two NC contact blocks, which are wired to the safe slave. The contact blocks and lampholders (with spring-type terminals) of the control device, and the AS-Interface slaves, are mounted in the base of the enclosure and are cable-connected.

The plastic enclosures are designed with a connection for the AS-Interface flat cable (the cable is run passed the outside of the enclosure). For metal enclosures, the AS-Interface cable is run inside the enclosure.

The enclosures with EMERGENCY-STOP mushroom pushbuttons have a yellow top part. They are also available with an M12 plug.

Selection and ordering data

	Version	Order No.
	AS-Interface enclosures, plastic, with standard fittings	
	<i>Equipment</i> (A, B, C = identification letters of the command positions)	<i>Number of command points</i>
	With M12 plug at the top	
	A = EMERGENCY-STOP mushroom pushbutton	1
3SF5 811-0AA08		3SF5 811-0AA10
	With terminal for insulation piercing method at the top	
	A = EMERGENCY-STOP mushroom pushbutton	1
3SF5 812-0DA00	A = EMERGENCY-STOP mushroom pushbutton with protective collar	1
	B = Pushbutton green, label "I", A = Pushbutton red, label "O"	2
	B = Pushbutton white, label "I", A = Pushbutton black, label "O"	2
	C = Indicator light clear, label without inscription, B = Pushbutton green, label "I", A = Pushbutton red, label "O"	3
	C = Indicator light clear, label without inscription, B = Pushbutton white, label "I", A = Pushbutton black, label "O"	3
	C = Pushbutton black, label "II", B = Pushbutton black, label "I", A = Pushbutton red, label "O"	3
	AS-Interface enclosures, metal, with standard fittings	
	<i>Equipment</i> (A, B, C = identification letters of the command positions)	<i>Number of command points</i>
	With M12 connector socket at the top	
	A = EMERGENCY-STOP mushroom pushbutton	1
3SF5 811-2AB08	A = EMERGENCY-STOP mushroom pushbutton with protective collar	1
	With cable gland at the top	
	A = EMERGENCY-STOP mushroom pushbutton, yellow top part of enclosure	1
3SF5 812-2DA00	A = EMERGENCY-STOP mushroom pushbutton, yellow top part of enclosure, with protective collar	1
	B = Pushbutton green, label "I", A = Pushbutton red, label "O"	2
	B = Pushbutton white, label "I", A = Pushbutton black, label "O"	2
	C = Indicator light clear, label without inscription, B = Pushbutton green, label "I", A = Pushbutton red, label "O"	3
	C = Indicator light clear, label without inscription, B = Pushbutton white, label "I", A = Pushbutton black, label "O"	3
	C = Pushbutton black, label "II", B = Pushbutton black, label "I", A = Pushbutton red, label "O"	3
3SF5 813-2DA00		3SF5 813-2DC00
		3SF5 813-2DB00

AS-Interface slaves













3SF5 pushbuttons and indicator lights

AS-Interface enclosures and front panel modules

Components

Selection and ordering data

For self-equipping of the enclosures

	Version	Order No.	
	With plastic enclosure	<i>Number of command points</i>	
 3SF5 500-0BA	AS-Interface slaves		
	F slave, 2 safe inputs, for plastic enclosure, EMERGENCY-STOP, without protective collar	1 ... 6	3SF5 500-0BA
	F slave, 2 safe inputs, for plastic or metal enclosure, EMERGENCY-STOP, with protective collar	1	3SF5 500-0DA
	A/B slave, 4I/3O for plastic enclosure	2 ... 6	3SF5 500-0BB
 3SF5 500-0CB	Slave, 4I/4O, for plastic enclosure	2 ... 6	3SF5 500-0BC
	Sets of links		
 3SF5 500-0BB	For F slave		3SF5 900-0BA
	For slave 4I/4O or A/B slave 4I(3O)		3SF5 900-0BB
 3SF5 900-0CA	Connection elements		
	For AS-Interface shaped cable, connection by insulation piercing method, for plastic enclosure,	1 ... 3 4 ... 6	3SF5 900-0CA 3SF5 900-0CB
 3SF5 900-0CC	For AS-Interface connection using M12 plug, for plastic enclosure	1 ... 3 4 ... 6	3SF5 900-0CC 3SF5 900-0CD
	For bringing out unused inputs and outputs via M12 socket, for plastic enclosure	1 ... 3 4 ... 6	3SF5 900-0CE 3SF5 900-0CF
 3SF5 900-0CG	For AS-Interface shaped cable, cable is routed into the enclosure, for plastic or metal enclosure	1 ... 3 4 ... 6	3SF5 900-0CG 3SF5 900-0CH
	For round cable, cable is routed into the enclosure, for plastic or metal enclosure	1 ... 3 4 ... 6	3SF5 900-0CJ 3SF5 900-0CK
 3SF5 900-0CG			
	For metal enclosures	<i>Number of command points</i>	
 3SF5 500-0CB	AS-Interface slaves		
	F slave, 2 safe inputs, for metal enclosure, EMERGENCY-STOP, without protective collar	1 ... 6	3SF5 500-0CA
	F slave, 2 safe inputs, for plastic or metal enclosure, EMERGENCY-STOP, with protective collar	1	3SF5 500-0DA
	A/B slave, 4I/3O for metal enclosure	2 ... 6	3SF5 500-0CB
 3SF5 500-0CC	Slave, 4I/4O for metal enclosure	2 ... 6	3SF5 500-0CC
	Sets of links		
 3SF5 900-0BB	For F slave		3SF5 900-0BA
	For slave 4I/4O or A/B slave 4I(3O)		3SF5 900-0BB
 3SF5 900-0CG	Connection elements		
	For AS-Interface connection using M12 plug, for metal enclosure	1 ... 3 4 ... 6	3SF5 900-2CC 3SF5 900-2CD
 3SF5 900-0CJ	For bringing out unused inputs/outputs through an M12 socket, for metal enclosure	1 ... 3 4 ... 6	3SF5 900-2CE 3SF5 900-2CF
	For AS-Interface shaped cable, cable is routed into the enclosure, for plastic or metal enclosure	1 ... 3 4 ... 6	3SF5 900-0CG 3SF5 900-0CH
 3SF5 900-0CJ	For round cable, cable is routed into the enclosure, for plastic or metal enclosure	1 ... 3 4 ... 6	3SF5 900-0CJ 3SF5 900-0CK

Note:

Empty enclosures and elements for component arrangement can be found in the IC 10 catalog, chapter "Control and signaling devices" and in the Industry Mall under www.siemens.com/industrymall.

AS-Interface slaves

3SF5 pushbuttons and indicator lights

AS-Interface enclosures and front panel modules Customized equipment

Overview



The enclosures can be equipped with command devices as required for customized solutions to connect command devices to the AS-Interface.

Customized enclosures are available with 2 to 6 command positions.

One command point comprises:

- 1 actuator or indicator
- Up to 3 contact blocks or up to 2 contact blocks + 1 lampholder
- 1 inscription label

For plastic enclosures the command points are equipped as standard with plastic actuators and indicators, for metal enclosures they are equipped with metal actuators and indicators.

Installation of AS-Interface slaves

The following slave types are available for connecting the command points:

- Slave in A/B technology with 4 inputs and 3 outputs
- Slave with 4 inputs and 4 outputs
- F slave with 2 safe inputs for EMERGENCY-STOP

The following table shows the maximum number of equippable slaves:

Enclosures for	Number of slaves for enclosures without EMERGENCY-STOP	Number of slaves for enclosures with EMERGENCY-STOP
2 command points	1 x slave 4I/4O or 4I/3O	Version not available
3 command points	1 x slave 4I/4O or 4I/3O	1 x slave 4I/4O or 4I/3O + 1 x F slave
4 command points	2 x slave 4I/4O or 4I/3O ¹⁾	2 x slave 4I/4O or 4I/3O + 1 x F slave ¹⁾
6 command points	2 x slave 4I/4O or 4I/3O	2 x slave 4I/4O or 4I/3O + 1 x F slave

¹⁾ For metal enclosures with 4 command points, only 1 x slave 4I/4O or 4I/3O is possible.

Connection

The customized enclosure is delivered fully equipped and wired. For connection to AS-Interface can be selected between:

- Terminal for shaped AS-Interface cable.
The cable is contacted by the insulation piercing method and routed past the enclosure on the outside (possible only with plastic enclosure).
- Cable gland for the shaped AS-Interface cable or round cable. The cable is routed into the enclosure (preferable for metal enclosure).
- Connection using M12 plug.

If less than all inputs/outputs of the installed slaves in an enclosure are used for connecting the command devices, free inputs and outputs can be routed on request to the outside through an M12 socket on the top or bottom side of the enclosure. The desired pin arrangement of the M12 socket must be stated in the order documents

To supply inputs with power, the S+ connection of the must be assigned to the socket, for outputs the OUT- connection must be assigned.

Addressing is performed using the AS-Interface connections or the integrated addressing socket. An external power supply is not required.

EMERGENCY STOP

For enclosures with EMERGENCY STOP, the EMERGENCY-STOP mushroom pushbutton can be wired conventionally or via a secure AS-Interface slave, as desired.

For conventional wiring of the EMERGENCY-STOP mushroom pushbutton, up to three switching contacts can be selected for the EMERGENCY STOP. If the EMERGENCY STOP is prompted via AS-Interface, two contacts are possible for the safety circuit.

With conventional wiring, the scanning of one EMERGENCY-STOP contact block through AS-Interface is possible.

Selection and ordering data

The selection and ordering of the customized enclosure is made directly via the 3SB3/3SF5 configurator for pushbuttons and indicator lights.

An electronic order form will be generated for the additional options. The configurator is available in the electronic catalog CA 01 on CD-ROM or DVD or in the online catalog (Mall) on the Internet:

www.siemens.com/industrymall

Select the configurator for "Pushbuttons and indicator lights 3SB3, 3SF5" from the list of configurators.

Start the configuration with the list entry "Version" and select the "Customized enclosure ASI".

The list price of the complete enclosure is generated in the configurator for the customized equipment. Registration and login in the configurator is required for this.

Please send the resulting electronic order form along with your order to our Competence Center at

sirius-attach.aud@siemens.com

If you are unable to access either catalog, please contact our Technical Assistance.

AS-Interface slaves

3SF5 pushbuttons and indicator lights

AS-Interface enclosures and front panel modules

Front panel module

Overview

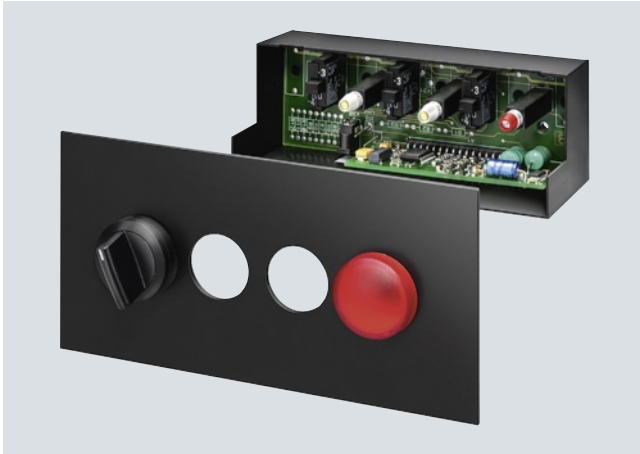

With the AS-Interface front panel module, 3SB3 control devices, which are mounted on to the front panels, can be connected to the AS-Interface bus system. Plastic or metal pushbuttons or indicator lights in round or square design can be used. Mushroom pushbuttons and acoustic signaling devices cannot be used.

The front panel module comprises:

- Slave 4I/4O
- 4 3SB3 commanding and signaling devices
- Accessories (lamps, name plates, mounting parts)

The selection of standard fittings is made through the ordering documents (see next page).

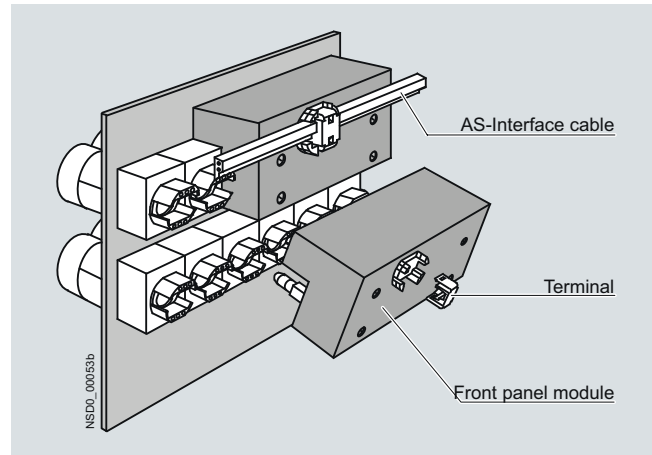

The front panel module is mounted on the back of the front panel on a group of four actuators and indicators arranged alongside or on top of each other and secured with screws. The contact blocks and lampholders are integrated in the module.

A 30 mm x 45 mm grid must be considered when mounting the control devices on to the front plate.

Connection to the AS-Interface shaped cable is by means of a terminal positioned on the rear of the module using the insulation piercing method.

Addressing is performed using the AS-Interface connections or the integrated addressing socket.

Selection and ordering data

Version	Order No.
AS-Interface front panel module for 3SB3 control devices	
4I/4O	3SF5 874-4AZ

AS-Interface slaves

3SF5 pushbuttons and indicator lights

AS-Interface enclosures and front panel modules

Front panel module

Selection and ordering data

To order the front panel module, please fill out the order form and include it with your order. These order documents cannot be generated via the 3SB3/3SF5 configurator. The electronic order form is available from our Technical Support:

Tel. +49 (0)911 895-59 00
 Fax +49 (0)911 895-59 07

Enter the desired options in the order form, e.g. type of actuators and indicators, switching contacts, lampholders or accessories (labels or the like). The codes that are to be entered in the form

can be obtained from the list of options that are subject to a surcharge.

The price of the device is made up of the basic price of the module and the additional prices for the fittings.

The additional prices include all components which depend on the selected configuration options (actuators and indicators, switching contacts, lampholders and accessories).

Order form

Front panel module order documentation		to sirius-attach.aud@siemens.com																										
Date	Purchaser's order reference	Supplier's order reference																										
1. Number of command points <input type="checkbox"/> 4 command points		2. Design of actuators <input type="checkbox"/> round, plastic <input type="checkbox"/> square, plastic <input type="checkbox"/> round, metal																										
3. Name plates <input type="checkbox"/> without <input type="checkbox"/> with name plate including glued in inscription label 12.5 mm × 27 mm <input type="checkbox"/> with name plate including glued in inscription label 27 mm × 27 mm																												
4. Equipment (top view of front side of switchboard)																												
Inscription of the name plates																												
Equipment (code)	A	B	C	D																								
Version of switching elements	<table border="1"> <tr> <td>left</td> <td>right</td> </tr> <tr> <td><input type="checkbox"/> 1 NO</td> <td><input type="checkbox"/> 1 NO</td> </tr> <tr> <td><input type="checkbox"/> 1 NC</td> <td><input type="checkbox"/> 1 NC</td> </tr> </table>	left	right	<input type="checkbox"/> 1 NO	<input type="checkbox"/> 1 NO	<input type="checkbox"/> 1 NC	<input type="checkbox"/> 1 NC	<table border="1"> <tr> <td>left</td> <td>right</td> </tr> <tr> <td><input type="checkbox"/> 1 NO</td> <td><input type="checkbox"/> 1 NO</td> </tr> <tr> <td><input type="checkbox"/> 1 NC</td> <td><input type="checkbox"/> 1 NC</td> </tr> </table>	left	right	<input type="checkbox"/> 1 NO	<input type="checkbox"/> 1 NO	<input type="checkbox"/> 1 NC	<input type="checkbox"/> 1 NC	<table border="1"> <tr> <td>left</td> <td>right</td> </tr> <tr> <td><input type="checkbox"/> 1 NO</td> <td><input type="checkbox"/> 1 NO</td> </tr> <tr> <td><input type="checkbox"/> 1 NC</td> <td><input type="checkbox"/> 1 NC</td> </tr> </table>	left	right	<input type="checkbox"/> 1 NO	<input type="checkbox"/> 1 NO	<input type="checkbox"/> 1 NC	<input type="checkbox"/> 1 NC	<table border="1"> <tr> <td>left</td> <td>right</td> </tr> <tr> <td><input type="checkbox"/> 1 NO</td> <td><input type="checkbox"/> 1 NO</td> </tr> <tr> <td><input type="checkbox"/> 1 NC</td> <td><input type="checkbox"/> 1 NC</td> </tr> </table>	left	right	<input type="checkbox"/> 1 NO	<input type="checkbox"/> 1 NO	<input type="checkbox"/> 1 NC	<input type="checkbox"/> 1 NC
left	right																											
<input type="checkbox"/> 1 NO	<input type="checkbox"/> 1 NO																											
<input type="checkbox"/> 1 NC	<input type="checkbox"/> 1 NC																											
left	right																											
<input type="checkbox"/> 1 NO	<input type="checkbox"/> 1 NO																											
<input type="checkbox"/> 1 NC	<input type="checkbox"/> 1 NC																											
left	right																											
<input type="checkbox"/> 1 NO	<input type="checkbox"/> 1 NO																											
<input type="checkbox"/> 1 NC	<input type="checkbox"/> 1 NC																											
left	right																											
<input type="checkbox"/> 1 NO	<input type="checkbox"/> 1 NO																											
<input type="checkbox"/> 1 NC	<input type="checkbox"/> 1 NC																											

NSD0 00057d

5. Lamps for illuminated actuators and indicator lights

- 24 V incandescent lamp (will be used unless otherwise specified)
- 30 V incandescent lamp
- Super-bright LED (color of LED according to color of actuator/indicator)

6

AS-Interface slaves

3SF5 pushbuttons and indicator lights

AS-Interface enclosures and front panel modules
Front panel module

Selection and ordering data (continued)

Selection of equipping options according to order documentation

Version	Code according to colors													
	Black		Red		Yellow		Green		Blue		White		Clear	
Actuators and indicators														
Pushbuttons with flat button	D	BK	D	RD	D	YE	D	GN	D	BU	D	WH	D	CL
Illuminated pushbuttons with flat button	–		DL	RD	DL	YE	DL	GN	DL	BU	DL	WH	DL	CL
Pushbuttons with raised button	DH	BK	DH	RD	DH	YE	–		DH	BU	–		–	
Illuminated pushbutton with raised button	–		DHL	RD	DHL	YE	DHL	GN	DHL	BU	–		DHL	CL
Pushbutton with raised front ring	DHF	BK	DHF	RD	DHF	YE	DHF	GN	DHF	BU	DHF	WH	–	
Pushbutton with raised front ring, castellated ¹⁾	DFZ	BK	DFZ	RD	DFZ	YE	DFZ	GN	DFZ	BU	DFZ	WH	–	
Pushbutton with flat button	DS	BK	DS	RD	DS	YE	DS	GN	DS	BU	DS	WH	–	
Illuminated pushbutton with flat button	–		DLS	RD	DLS	YE	DLS	GN	DLS	BU	DLS	WH	DLS	CL
Indicator light, smooth lens	–		L	RD	L	YE	L	GN	L	BU	L	WH	L	CL

Selector switches with 2 switch positions

Switching sequence O–I, latching

Non-illuminated	K1	BK	K1	RD	–		K1	GN	–		K1	WH	–	
Illuminated	–		BK1	RD	BK1	YE	BK1	GN	BK1	BU	–		BK1	CL

Switching sequence O–I, momentary contact

Non-illuminated	K2	BK	K2	RD	–		K2	GN	–		K2	WH	–	
Illuminated	–		BK2	RD	BK2	YE	BK2	GN	BK2	BU	–		BK2	CL

Selector switches with 3 switch positions

Switching sequence I–O–II, latching

Non-illuminated	K4	BK	K4	RD	–		K4	GN	–		K4	WH	–	
Illuminated	–		BK4	RD	BK4	YE	BK4	GN	BK4	BU	–		BK4	CL

Switching sequence I–O–II, momentary contact

Non-illuminated	K5	BK	K5	RD	–		K5	GN	–		K5	WH	–	
Illuminated	–		BK5	RD	BK5	YE	BK5	GN	BK5	BU	–		BK5	CL

Switching sequence I–O–II, latching to the right, momentary contact to the left

Non-illuminated	K6	BK	K6	RD	–		K6	GN	–		K6	WH	–	
-----------------	----	----	----	----	---	--	----	----	---	--	----	----	---	--

Switching sequence I–O–II, latching to the left, momentary contact to the right

Non-illuminated	K7	BK	K7	RD	–		K7	GN	–		K7	WH	–	
-----------------	----	----	----	----	---	--	----	----	---	--	----	----	---	--

¹⁾ Only for plastic version.

Note:

More information on the actuators and indicator lights can be found in the IC 10 catalog, chapter "Control and signaling devices" and in the Industry Mall at: www.siemens.com/industrymall.

AS-Interface slaves

3SF5 pushbuttons and indicator lights

AS-Interface enclosures and front panel modules

Front panel module

Selection and ordering data (continued)

Selection of equipping options according to order documentation

Version	Code Key can be removed in any position							
	O	I	II	O and I	O and II	I and II	I, O and II	

Key-operated switches with 2 switch positions

Switching sequence O-I, latching

RONIS type:										
Lock No. SB30	RSB	1A	RSB	1E	–	RSB	1AE	–	–	–
CES type:										
Lock No. SSG 10	CES	1A	CES	1E	–	CES	1AE	–	–	–
Lock No. LSG 1	CESL	1A	–	–	–	CESL	1AE	–	–	–
CES type with key monitoring										
Lock No. SSG 10	CES SU	1A								
BKS type:										
Lock No. S1	BKS	1A	BKS	1E	–	BKS	1AE	–	–	–
Lock No. E1 (for VW)	BKS A	1A	–	–	–	BKS A	1AE	–	–	–
Lock No. E2 (for VW)	BKS E	1A	–	–	–	BKS E	1AE	–	–	–
Lock No. E7 (for VW)	BKS C	1A	–	–	–	BKS C	1AE	–	–	–
Lock No. E9 (for VW)	BKS B	1A	–	–	–	BKS B	1AE	–	–	–
O.M.R. type										
Black, lock no. 73034	OMR BK 1A	OMR BK 1E	–	–	–	OMR BK1AE	–	–	–	–

Switching sequence O-I, momentary contact

RONIS type:										
Lock No. SB30	RSB	2A	–	–	–	–	–	–	–	–
CES type:										
Lock No. SSG 10	CES	2A	–	–	–	–	–	–	–	–
Lock No. LSG 1	CESL	2A	–	–	–	–	–	–	–	–
BKS type:										
Lock No. S1	BKS	2A	–	–	–	–	–	–	–	–
O.M.R. type										
Black, lock no. 73034	OMR BK 2A	–	–	–	–	–	–	–	–	–

Key-operated switches with 3 switch positions

Switching sequence I-O-II, latching

RONIS type:												
Lock No. SB30	RSB	4A	RSB	4E	RSB	4D	–	–	RSB	4ED	RSB	4EAD
CES type:												
Lock No. SSG 10	CES	4A	CES	4E	CES	4D	–	–	CES	4ED	CES	4EAD
CES type with key monitoring												
Lock No. SSG 10	CES SU	4A										
BKS type:												
Lock No. S1	BKS	4A	BKS	4E	BKS	4D	–	–	BKS	4ED	BKS	4EAD
O.M.R. type												
Black, lock no. 73034	OMR BK 4A	–	–	–	–	–	–	–	OMR BK 4ED	OMR BK 4EAD		

Switching sequence I-O-II, momentary contact

RONIS type:										
Lock No. SB30	RSB	5A	–	–	–	–	–	–	–	–
CES type:										
Lock No. SSG 10	CES	5A	–	–	–	–	–	–	–	–
BKS type:										
Lock No. S1	BKS	5A	–	–	–	–	–	–	–	–
O.M.R. type										
Black, lock no. 73034	OMR BK 5A	–	–	–	–	–	–	–	–	–

Note:

More information on the actuators and indicator lights can be found in the IC 10 catalog, chapter "Control and signaling devices" and in the Industry Mall at:

www.siemens.com/industrymall.

AS-Interface slaves

3SF5 pushbuttons and indicator lights

AS-Interface enclosures and front panel modules
Front panel module

Selection and ordering data (continued)

Selection of equipping options according to order documentation

Version	Code Key can be removed in any position						
	O	I	II	O and I	O and II	I and II	I, O and II

Key-operated switches with 3 switch positions

Switching sequence I–O–II, latching to the right, momentary contact to the left

RONIS type:										
Lock No. SB30	RSB	6A	–	RSB	6D	–	RSB	6AD	–	–
CES type:										
Lock No. SSG 10	CES	6A	–	CES	6D	–	CES	6AD	–	–
BKS type:										
Lock No. S1	BKS	6A	–	BKS	6D	–	BKS	6AD	–	–
O.M.R. type										
Black, lock no. 73034	OMR BK 6A	–	–	OMR BK 6D	–	–	OMR BK 6AD	–	–	–

Switching sequence I–O–II, latching to the left, momentary contact to the right

RONIS type:										
Lock No. SB30	RSB	7A	RSB	7E	–	RSB	7AE	–	–	–
CES type:										
Lock No. SSG 10	CES	7A	CES	7E	–	CES	7AE	–	–	–
BKS type:										
Lock No. S1	BKS	7A	BKS	7E	–	BKS	7AE	–	–	–
O.M.R. type										
Black, lock no. 73034	OMR BK 7A	–	OMR BK 7E	–	–	–	–	–	–	–

Note:

More information on the actuators and indicator lights can be found in the IC 10 catalog, chapter "Control and signaling devices" and in the Industry Mall at:
www.siemens.com/industrymall.

AS-Interface slaves

8WD4 signaling columns

General data

Overview

The 8WD4 signaling columns are flexible in design and versatile in use.

These are used for controlling complex processes in machines or automated processes or as visual or acoustic warning systems in emergency situations, e.g. for displaying individual stages of production.



8WD44 signaling columns with connection to AS-Interface cables

Two product series are available:

- 8WD42
 - Thermoplast enclosure, diameter 50 mm
 - Degree of protection IP54
- 8WD44
 - Thermoplast enclosure, diameter 70 mm
 - Advanced design and significantly improved illumination
 - Fast and flexible when connected through spring-type terminals (optional)
 - Integrated degree of protection IP65

Communication through AS-Interface

The 8WD4 signaling columns can be directly connected to the AS-Interface bus system through an adapter element that can be integrated in the column. Wiring outlay is reduced as the result.

Connection

8WD42:

The two-wire bus cable is fixed to the screw terminals in the connection element. The adapter element must be the first module to be mounted on the connection element. A maximum of 4 signaling elements can then be mounted on it.

The adapter element 8WD42 28-0BB is a standard slave.

8WD44:

The two-wire bus cable is fixed to the screw or spring-type terminals in the connection element. The adapter element must be the first module to be mounted on the connection element. The signaling elements can then be mounted on it.

The adapter element 8WD44 28-0BE is a standard slave. A maximum of 4 signaling elements can be mounted on it.

The adapter element 8WD44 28-0BD with A/B technology enables the connection of up to 62 slaves on one AS-Interface system. The addressing socket provides user-friendly parameterization of the AS-Interface elements. A maximum of 3 signaling elements can be mounted on it.

AS-Interface slaves

8WD4 signaling columns

8WD42 signaling columns, 50 mm diameter

Selection and ordering data

	Version	Rated voltage	Color	Order No.
Acoustic elements ¹⁾				
	Buzzer element 80 dB, Sound type pulsing or continuous tone, can be adjusted via a wire jumper	24 V AC/DC	Black	8WD42 20-0FA
Light elements for incandescent lamps/LED, base BA 15d ²⁾				
 	Continuous light elements	24 ... 230 V AC/DC	Red Green Yellow Clear Blue	8WD42 00-1AB 8WD42 00-1AC 8WD42 00-1AD 8WD42 00-1AE 8WD42 00-1AF
Light elements with integrated LED				
	Continuous light elements	24 V AC/DC	Red Green Yellow Clear ³⁾ Blue ³⁾	8WD42 20-5AB 8WD42 20-5AC 8WD42 20-5AD 8WD42 20-5AE 8WD42 20-5AF
 	Blinklight elements	24 V AC/DC	Red Green Yellow Clear Blue	8WD42 20-5BB 8WD42 20-5BC 8WD42 20-5BD 8WD42 20-5BE 8WD42 20-5BF
Adapter elements for AS-Interface				
	AS-Interface adapter elements With/without external auxiliary voltage, switchable • Standard AS-i	For 4 signaling elements	Black	8WD42 28-0BB
Connection elements ⁴⁾				
	Connection elements with cover Screw terminals • For mounting on pipes, angle mount- ing and floor mounting		Black	8WD42 08-0AA

¹⁾ One acoustic element can be mounted per signaling column.
One cover is contained in the scope of supply and permanently mounted
on the acoustic elements.

²⁾ The lamp is not included in the scope of supply. Please order separately.

³⁾ Start of delivery in October 2011.









⁴⁾ The connection element with cover is an essential part for assembling
the signaling columns.

AS-Interface slaves

8WD4 signaling columns

8WD42 signaling columns, 50 mm diameter

Selection and ordering data (continued)

Version		Order No.
Mounting		
	Feet, single	Plastic, for mounting on pipes Metal, for pipe lengths > 400 mm
		Plastic, for floor mounting (without pipe)
	Foldaway base for positioning in the grid 7.5° ¹⁾	Plastic, for mounting on pipes, incl. rubber seal
		Pipes, single
		Length 150 mm
		Length 250 mm
		Length 400 mm
		Length 1000 mm
	Sockets for feet	Side cable outlet (can also be used without feet)
		Side cable outlet, with magnetic fixing ²⁾
	Brackets for mounting with foot	
	Brackets for wall mounting (plastic)	Mounting without feet and pipe
	Adapters for single-hole mounting	Mounting without feet and pipe, with M18 thread and fixing nut
Lamps		
	Incandescent lamps, 5 W, 24 V AC/DC Base BA 15d	
	LEDs, 24 V AC/DC Base BA 15d	Red
		Green
		Yellow
		Clear
		Blue

¹⁾ Markings for 30°, 45°, 60° and 90°.

²⁾ For horizontal mounting, only 1 element is recommended.

AS-Interface slaves

8WD4 signaling columns

8WD44 signaling columns, 70 mm diameter

Selection and ordering data

Version	Rated voltage	Color	Order No.	
<i>Acoustic elements</i> ¹⁾				
	Buzzer element 85 dB, Sound type pulsing or continuous tone, can be adjusted via a wire jumper	24 V AC/DC	Black	8WD44 20-0FA
	Siren elements , multi-tone, 100 dB, 8 tones and volume are adjustable	24 V AC/DC	Black	8WD44 20-0EA2
	Siren elements 108 dB, IP40	24 V DC	Black	8WD44 20-0EA
<i>Light elements for incandescent lamps/LED, base BA 15d</i> ²⁾				
	Continuous light elements	12 ... 230 V AC/DC	Red Green Yellow Clear Blue	8WD44 00-1AB 8WD44 00-1AC 8WD44 00-1AD 8WD44 00-1AE 8WD44 00-1AF
	Blinklight elements	24 V AC/DC	Red Green Yellow Clear Blue	8WD44 20-1BB 8WD44 20-1BC 8WD44 20-1BD 8WD44 20-1BE 8WD44 20-1BF
<i>Light elements with integrated flash lamp</i> ³⁾				
	Flashlight elements with integrated electronic flash	24 V DC	Red Green Yellow Clear Blue	8WD44 20-0CB 8WD44 20-0CC 8WD44 20-0CD 8WD44 20-0CE 8WD44 20-0CF
<i>Light elements with integrated LED</i>				
	Continuous light elements	24 V AC/DC	Red Green Yellow Clear Blue	8WD44 20-5AB 8WD44 20-5AC 8WD44 20-5AD 8WD44 20-5AE 8WD44 20-5AF
	Blinklight elements	24 V AC/DC	Red Green Yellow Clear ⁴⁾ Blue ⁴⁾	8WD44 20-5BB 8WD44 20-5BC 8WD44 20-5BD 8WD44 20-5BE 8WD44 20-5BF
	Rotating light elements	24 V AC/DC	Red Green Yellow	8WD44 20-5DB 8WD44 20-5DC 8WD44 20-5DD
<i>Adapter elements for AS-Interface</i>				
	AS-Interface adapter elements With/without external auxiliary voltage, switchable			
	• A/B technology	For 3 signaling elements	Black	8WD44 28-0BD
	• Standard AS-i	For 4 signaling elements	Black	8WD44 28-0BE
<i>Connection elements</i> ⁵⁾				
	Connection elements with cover		Black	
	Screw terminals			8WD44 08-0AA 8WD44 08-0AB
	• For mounting on pipes			
	• For mounting on bracket and floor			
	Spring-type terminals			8WD44 08-0AD 8WD44 08-0AE
	• For mounting on pipes			
	• For mounting on bracket and floor			
	Cover (replacement)			8WD44 08-0XA

¹⁾ One acoustic element can be mounted per signaling column.
One cover is contained in the scope of supply and permanently mounted on the acoustic elements.

²⁾ The lamp is not included in the scope of supply. Please order separately.

³⁾ The lamp is included in the scope of supply.

⁴⁾ Start of delivery in October 2011.

⁵⁾ The connection element with cover is an essential part for assembling the signaling columns.

AS-Interface slaves

8WD4 signaling columns

8WD44 signaling columns, 70 mm diameter

Selection and ordering data (continued)

	Version	Order No.
Mounting		
	Foot with pipe Pipe length 100 mm	8WD43 08-0DA
	Feet, single Plastic, for mounting on pipes Metal, for pipe lengths > 400 mm	8WD43 08-0DB 8WD43 08-0DC
	Foldaway base for positioning in the grid 7.5° ¹⁾ Plastic, for mounting on pipes, incl. rubber seal	8WD44 08-0DF
	Pipes, single Length 100 mm Length 150 mm Length 250 mm Length 400 mm Length 1000 mm	8WD42 08-0EF 8WD43 08-0EE 8WD43 08-0EA 8WD43 08-0EB 8WD43 08-0ED
	Sockets for feet Side cable outlet (can also be used without feet) Side cable outlet, with magnetic fixing ²⁾	8WD43 08-0DD 8WD43 08-0DE
	Brackets for wall mounting (mounting without feet and pipe) For single-sided mounting For double-sided mounting	8WD43 08-0CA 8WD43 08-0CB
	Brackets for mounting with foot	8WD44 08-0CC
	Brackets for base mounting Mounting without feet and pipe	8WD44 08-0CD
	Adapter for mounting on pipes according to NPT Mounting on pipes, Ø 25 mm, with NPT 1/2" thread	8WD43 08-0DF
Lamps		
	Incandescent lamps, 5 W, 24 V AC/DC Base BA 15d	8WD43 28-1XX
	LEDs, 24 V AC/DC Base BA 15d Red Green Yellow Clear Blue	8WD44 28-6XB 8WD44 28-6XC 8WD44 28-6XD 8WD44 28-6XE 8WD44 28-6XF

¹⁾ Markings for 30°, 45°, 60° and 90°.

²⁾ For horizontal mounting, only 1 element is recommended.

AS-Interface

Power supply units and data decoupling modules

AS-Interface power supply units

Overview



AS-Interface power supply unit for 3A

AS-Interface power supply units feed 30 V DC into the AS-Interface cable and supply the AS-Interface components. They include power-optimized data decoupling for the separation of communication signals and control supply voltage. As the result, AS-Interface is able to convey both data and power along a single line. The power supply units are resistant to overloads and short circuits.

Dimensions

AS-Interface power supply units have compact dimensions in widths of 50 / 70 / 120 mm. No distances from other devices need to be observed when mounting the power supply units.

Features



- Higher rating: The power supply units deliver currents of 2.6 to 8 A.
- Integrated data decoupling: As the result, AS-Interface is able to convey both data and power along a single line.
- Integrated ground-fault detection: The power supply units perform the reliable detection and signaling of ground faults according to IEC 60204-1. The AS-Interface voltage can be disconnected automatically in the event of a ground fault.
- Integrated overload detection: An output overload is detected and reported over a diagnostics LED.
- Diagnostics memory: Any ground faults or overloads on the output side are stored in a diagnostics memory until the device is reset.
- Remote reset and remote signaling: Using relay contacts, a ground fault can be signaled and evaluated by a central controller and/or indicator light.
- Diagnostics LEDs: Three different LEDs indicate the status of the AS-Interface power supply locally at the power supply unit.
- Ultra-wide input range / two-phase connection: The ultra-wide input range of 120 to 500 V of the 8 A version means that the supply units can be used in virtually any network worldwide. In addition, this version dispenses with the need for an N conductor as the device can be connected directly between 2 phases of a network.
- Operation with 24 V DC: The 3 A power supply unit is also available as a version with a 24 V DC input. This power supply unit is suitable for use in battery-powered systems or in systems with UPS (uninterruptible power supply).
- Removable terminal blocks with spring-type connections: For easy exchanging of devices, each power supply unit has three removable terminal blocks: for the input side, for the output side and for Signal/Reset connections.

6

Benefits

- Complete solution for supplying AS-Interface networks while making full use of the maximum possible cable length of 100 m or 200 m (with an extension plug) per AS-i Segment
- Only AS-i masters and AS-i slaves need to be connected to the AS-Interface cable in order to operate AS-Interface
- Compact, space-saving dimensions
- Reliable power supply even for large numbers of AS-Interface modules with a high power requirement
- Integrated ground-fault and overload detection saves the need for additional components and enhances safety
- Fast fault detection and reduced downtimes thanks to diagnostics memory, remote signaling and remote reset
- Reduced downtimes as the result of removable terminal blocks which enable the fast exchanging of devices
- Ultra-wide input range of the 8 A version permits single-phase and two-phase operation and saves the need for an N conductor
- Can be used world-wide thanks to for example UL/CSA approval (UL 508)
- With the 2.6 A version the output power is restricted to max. 100 W for use in NEC Class 2 circuits.

Selection and ordering data

Version	Spring-type terminals	Order No.																		
 <p>AS-Interface power supply unit IP20</p> <ul style="list-style-type: none"> • AS-i single output 30 V DC • With integrated ground-fault detection • 2.6 A version with output power restricted to max. 100 W (for use in NEC Class 2 circuits) • Dimensions: Width: 50 mm (3 A / 2.6 A); 70 mm (5 A), 120 mm (8 A); Height: 125 mm; Depth: 125 mm 																				
 <p>3RX9 501-0BA00</p>	<table border="1"> <thead> <tr> <th>Output current</th> <th>Input voltage</th> <th>Order No.</th> </tr> </thead> <tbody> <tr> <td>2.6 A / max. 100 W</td> <td>120 / 230 V AC (selectable)</td> <td>3RX9 501-2BA00</td> </tr> <tr> <td>3 A</td> <td>120 / 230 V AC (selectable)</td> <td>3RX9 501-0BA00</td> </tr> <tr> <td>3 A</td> <td>24 V DC</td> <td>3RX9 501-1BA00</td> </tr> <tr> <td>5 A</td> <td>120 / 230 V AC (selectable)</td> <td>3RX9 502-0BA00</td> </tr> <tr> <td>8 A</td> <td>120/ 230 ... 500 V AC (selectable)</td> <td>3RX9 503-0BA00</td> </tr> </tbody> </table>	Output current	Input voltage	Order No.	2.6 A / max. 100 W	120 / 230 V AC (selectable)	3RX9 501-2BA00	3 A	120 / 230 V AC (selectable)	3RX9 501-0BA00	3 A	24 V DC	3RX9 501-1BA00	5 A	120 / 230 V AC (selectable)	3RX9 502-0BA00	8 A	120/ 230 ... 500 V AC (selectable)	3RX9 503-0BA00	
Output current	Input voltage	Order No.																		
2.6 A / max. 100 W	120 / 230 V AC (selectable)	3RX9 501-2BA00																		
3 A	120 / 230 V AC (selectable)	3RX9 501-0BA00																		
3 A	24 V DC	3RX9 501-1BA00																		
5 A	120 / 230 V AC (selectable)	3RX9 502-0BA00																		
8 A	120/ 230 ... 500 V AC (selectable)	3RX9 503-0BA00																		
3RX9 503-0BA00																				

AS-Interface

Power supply units and data decoupling modules

S22.5 data decoupling modules

Overview



AS-Interface S22.5 double data decoupling modules
Left: screw terminal version, Right: spring-type terminal version

With the aid of the S22.5 data decoupling module, the AS-Interface network can also be supplied with 24 V DC or 30 V DC from a standard power supply unit and the transmission of data and power can be realized along one cable. The combination of data decoupling modules and standard power supply units is therefore a cost-efficient alternative to the service-proven AS-Interface power supply units. The quality of the data signals and the reliable operation of the AS-i network are not negatively affected as the result.

Features of the S22.5 data decoupling module

- Degree of protection IP20
- Narrow design: 22.5 mm wide
- Version with screw or spring-type terminals
- Versions for single and double data decoupling
- Connection of several AS-Interface networks to one power supply unit is possible
- Operation with 24 V DC or 30 V DC, grounded or non-grounded
- Adjustable current limiting up to 2 x 4 A
- Integrated ground-fault detection with fault storage
- Diagnostics LEDs and signaling contacts
- Reset by button or remote reset

Ground-fault detection

The integrated ground-fault detection works with a grounded and non-grounded supply: The connection of negative pole and ground (upstream from the data decoupling module) customary with 24 V DC power supplies is permitted. A ground fault to the negative or positive pole on the AS-Interface network (downstream from the data decoupling module) is detected and stored as a fault and will be signaled using LEDs and a relay contact.

Benefits

- Compatible expansion of the AS-Interface system
- An existing standard power supply unit with 24 V DC or 30 V DC can be used for supplying AS-i networks
- The AS-Interface system can also be used in tightly budgeted applications because no AS-Interface power supply unit needs to be purchased
- Applications benefit in addition from the advantages of a modern bus system:
 - High level of standardization
 - Additional diagnostics and maintenance information
 - Faster commissioning
- Easy and cost-efficient construction of single and multiple networks is possible

Application

The AS-Interface data decoupling module is designed for AS-Interface networks with 30 V supply or 24 V supply (AS-Interface Power24V).

Operation of an AS-i network with the data decoupling module and a 30 V DC standard power supply unit is technically equivalent to the use of an AS-Interface power supply unit and offers the service-proven features of AS-Interface for all applications.

AS-Interface Power24V uses a 24 V DC power supply unit in conjunction with a data decoupling module and is particularly suitable for

- Compact machines using AS-Interface input/output modules
- Applications in the control cabinet for AS-Interface integration of SIRIUS Innovation contactors and compact feeders (3RT2 contactors through 3RA27 function modules or 3RA6 compact feeders through AS-i 3RA69 add-on modules)

When using the double data decoupling module or additional data decoupling modules, several AS-Interface networks can be operated with a single power supply unit. This results in an additional cost advantage.

Note:

The length of an AS-i Power24V network is restricted to 50 m in order to limit the voltage drop along the cable.

AS-i masters, AS-i slaves and the sensors and actuators supplied through the AS-i cable must be designed for the reduced voltage. Sensors and actuators for the standard voltage range of 10...30 V can be supplied with sufficient voltage.

The power supply units must comply with the PELV Standard (Protective Extra Low Voltage) and have a residual ripple of < 250 mVpp. We recommend power supply units from the SITOP range, see Catalog IC 10.

AS-Interface Power supply units and data decoupling modules

S22.5 data decoupling modules



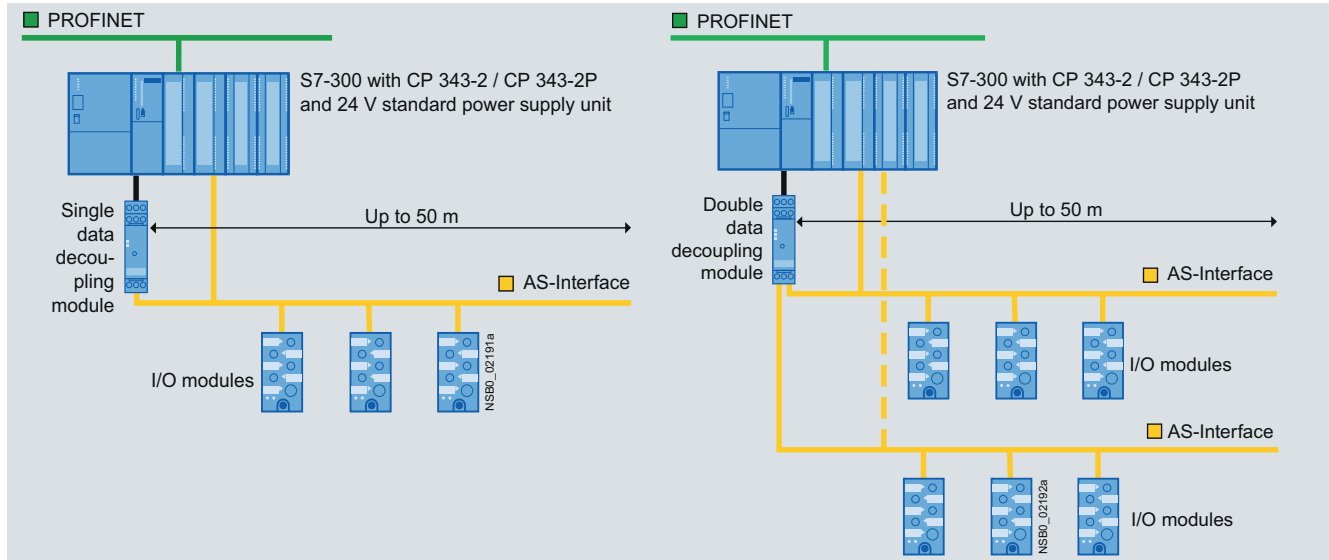

Application (continued)

Construction of an AS-i Power24V network with an AS-Interface S22.5 data decoupling module



Construction of an AS-i Power24V network with an AS-Interface S22.5 data decoupling module: Left: single network, Right: multiple network

Selection and ordering data

Version	Order No.
 S22.5 data decoupling modules With screw terminals, removable terminals, width 22.5 mm, height 101 mm, depth 115 mm <ul style="list-style-type: none"> • Single data decoupling module, 1 x 4 A • Double data decoupling module, 2 x 4 A 	Screw terminals  3RK1 901-1DE12-1AA0 3RK1 901-1DE22-1AA0
	Spring-type terminals  3RK1 901-1DG12-1AA0 3RK1 901-1DG22-1AA0
 S22.5 data decoupling modules With spring-type terminals, removable terminals, width 22.5 mm, height 105 mm, depth 115 mm <ul style="list-style-type: none"> • Single data decoupling module, 1 x 4 A • Double data decoupling module, 2 x 4 A 	

Circuit diagrams

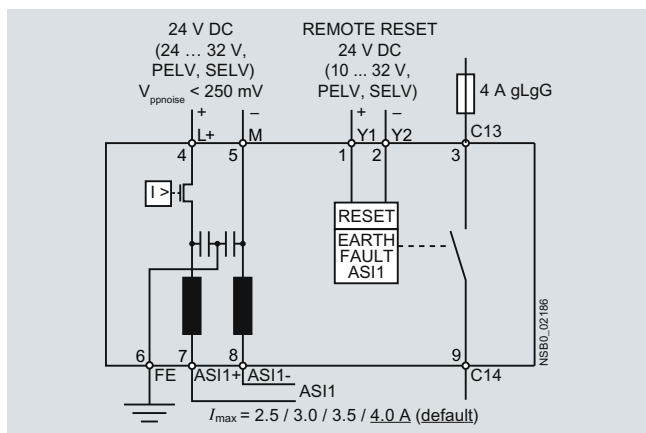

Single data decoupling module

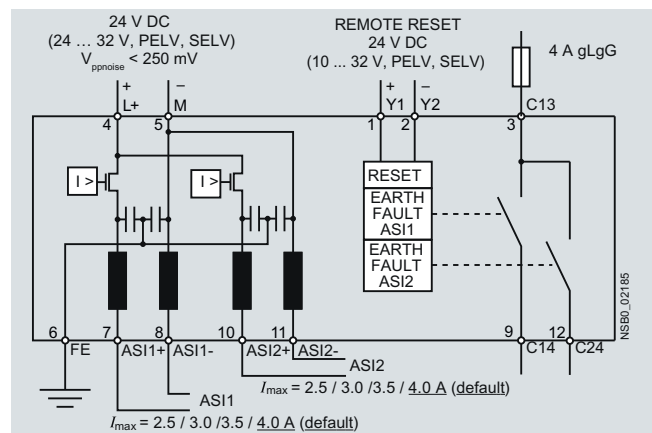

Double data decoupling module

AS-Interface

Transmission media

AS-Interface shaped cables

Overview



AS-Interface shaped cables

The actuator-sensor interface – the networking system used for the lowest field area – is characterized by very easy mounting and installation. A new connection method was developed specially for AS-Interface.

The stations are connected using the AS-Interface cable. This two-wire AS-Interface shaped cable has a trapezoidal shape, thus ruling out polarity reversal.

Connection is effected by the insulation piercing method. In other words, male contacts pierce the shaped AS-Interface cable and make reliable contact with the two wires. Cutting to length and stripping are superfluous. Consequently, AS-Interface stations (e. g. I/O modules, intelligent devices) can be connected in the shortest possible time and exchanging devices is quick.

To enable use in the most varied ambient conditions (e. g. in an oily environment), the AS-Interface cable is available in different materials (rubber, TPE, PUR).

For special applications it is also possible to use an unshielded standard round cable H05VV-F 2x1.5 mm² according to AS-i Specification. With AS-Interface, data and energy for the sensors (e.g. proximity switches BERO) and actuators (e. g. indicator lights) are transmitted over the yellow AS-Interface cable.

The black cable must be used for actuators with a 24 V DC supply (e. g. solenoid valves) and a high power requirement.

Suitable for operation in tow chains

The use of the AS-Interface shaped cables with TPE and PUR outer sheath was checked in a tow chain test with the following conditions:

Chain length	m	6
Travel	m	10
Bending radius	mm	75
Travel speed	m/s	4
Acceleration	m/s ²	4
Number of cycles		10 million
Duration of test		approx. 3 years (11000 cycles per day)

After termination of the 10 million cycles only slight wear was visible due to the lugs of the tow chain. No damage to the cores and core insulation could be detected.

Note:

When using a tow chain, the cables must be installed such that they are not subject to tensile forces. On no account may the cables be twisted, but must be routed flat through the tow chain.

Selection and ordering data

Version				Order No.	
 AS-Interface shaped cables	Material	Color	Quantity		
			Rubber	Yellow (AS-Interface)	100-m roll
			Yellow (AS-Interface)	1-km drum	3RX9 012-0AA00
			Black (24 V DC)	100-m roll	3RX9 020-0AA00
			Black (24 V DC)	1-km drum	3RX9 022-0AA00
	TPE		Yellow (AS-Interface)	100-m roll	3RX9 013-0AA00
			Yellow (AS-Interface)	1-km drum	3RX9 014-0AA00
			Black (24 V DC)	100-m roll	3RX9 023-0AA00
			Black (24 V DC)	1-km drum	3RX9 024-0AA00
	TPE special version according to UL Class 2		Yellow (AS-Interface)	100-m roll	3RX9 017-0AA00
			Black (24 V DC)	100-m roll	3RX9 027-0AA00
	PUR		Yellow (AS-Interface)	100-m roll	3RX9 015-0AA00
			Yellow (AS-Interface)	1-km drum	3RX9 016-0AA00
			Black (24 V DC)	100-m roll	3RX9 025-0AA00
			Black (24 V DC)	1-km drum	3RX9 026-0AA00

AS-Interface

System components and accessories

Repeater

Overview



AS-Interface repeater

AS-Interface repeaters are used for extending the AS-Interface cable by 100 m per repeater and have the following features:

- Maximum two repeaters in series
- Parallel switching of several repeaters possible (star configuration option)
- Maximum size increase of an AS-Interface network to up to 500 m is thus possible
- Easy mounting
- IP67 module enclosure

Design of an AS-Interface network with repeaters

- Slaves can be used on both sides of the repeater
- AS-Interface power supply is required on both sides
- Electrical separation of the two AS-Interface shaped cable lines
- Installed in K45 module enclosure with mounting plate
- Separate indication of the correct AS-Interface voltage for each side
- Maximum two repeaters in series (max. cable length 300 m)
- Parallel switching of several repeaters possible (star configuration)
- Combination of series and parallel switching possible (max. range 500 m)

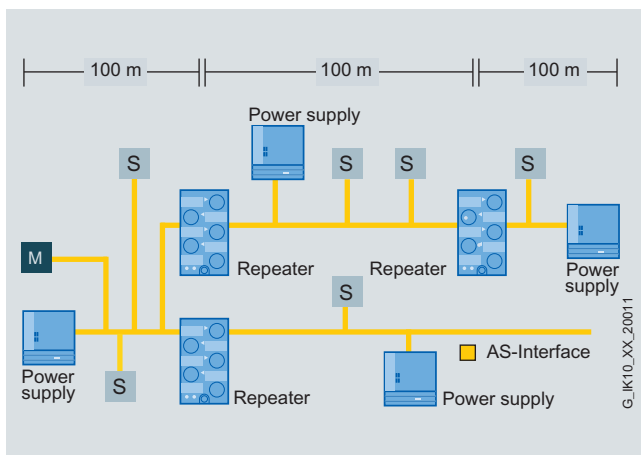

Design of an AS-Interface network with repeaters (example)

Benefits

get **Designed for Industry**

- More possibilities of use and greater freedom for plant planning through extension of the AS-Interface network
- Reduced downtime and servicing times in the event of a fault thanks to separate indication of the correct AS-Interface voltage for each side

Application

The repeater is used to lengthen the AS-Interface segment by 100 m. In this case there are AS-Interface slaves and one AS-Interface power supply on each side of the repeater.

Note:

The AS-Interface repeater is not suitable for AS-i Power24V networks. It is recommended for use in AS-Interface networks with AS-Interface power supply units (e.g. 3RX9 501-0BA00).

Selection and ordering data

Version	Order No.
 Repeaters for AS-Interface For cable extension, including mounting plate	6GK1 210-0SA01

6GK1 210-0SA01

6

AS-Interface

System components and accessories

Extension plug

Overview



AS-Interface extension plug (on AS-Interface M12 feeder)

With the extension plug/extension plug plus it is possible to double the cable length possible in an AS-Interface segment from 100 to 200 m.

The extension plug is a passive component, the extension plug plus is equipped in addition with an A/B slave.

The extension plug / extension plug plus has an M12 plug and can be connected with it to the AS-Interface M12 feeder with degree of protection IP67. Only one power supply unit is needed to supply power to the slaves on the up to 200 m long segment.

Design of an AS-Interface segment with an extension plug

To construct an AS-Interface segment with a cable length of more than 100 m and up to a maximum of 200 m, the extension plug or extension plug plus is installed at that point of the network which in a range of approx. ±10 m is furthest from the AS-Interface power supply unit. The extension plug is not allowed to be used in AS-Interface networks smaller than 100 m. As with all AS-Interface networks, any network structure (line, tree, star) is possible when using the extension plug/extension plug plus. Only one extension plug/extension plug plus is required per 200 m segment even with a tree or star structure.

Note:

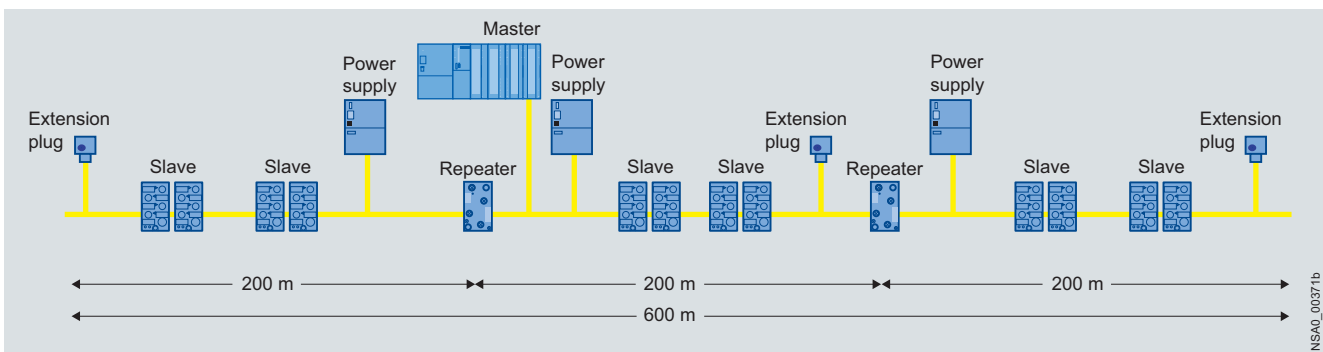

The AS-Interface extension plug and the extension plug plus are not suitable for AS-i Power24V networks. Both are recommended for use in AS-Interface networks with AS-Interface power supply units (e.g. 3RX9 501-0BA00).

6



Maximum network size with repeaters and extension plug (master at center of network)

Selection and ordering data

Version	Order No.
 <p>AS-Interface extension plug¹⁾</p> <ul style="list-style-type: none"> • Doubling of the cable length to 200 m per AS-Interface segment • Undervoltage monitoring signal by means of diagnostics LED 	3RK1 901-1MX00
<p>AS-Interface extension plug plus¹⁾</p> <ul style="list-style-type: none"> • Doubling of the cable length to 200 m per AS-Interface segment • Undervoltage monitoring signal through integrated AS-Interface slave to AS-Interface master 	3RK1 901-1MX01
<p>Accessories</p>  <p>AS-Interface M12 feeders</p> <ul style="list-style-type: none"> • For adaptation of shaped AS-Interface cable to a standard round cable • Insulation piercing method for connection of AS-Interface cable • M12 socket for connection of standard round cable • Degree of protection IP67 	3RX9 801-0AA00
 <p>AS-Interface M12 feeders</p> <ul style="list-style-type: none"> • Transition of AS-Interface cable without U_{aux}, with M12 socket • Insulation piercing method for connection of AS-Interface cable • M12 socket for connection of standard round cable • Max. 4A • Degree of protection IP67/IP68/IP69K 	3RK1 901-1NR10

¹⁾ For connection to the AS-Interface flat cable you need the AS-Interface M12 feeder, which must be ordered separately, see section "Accessories".

Overview



New addressing unit V 3.0 for AS-Interface

The addressing unit is used to each AS-Interface slave to assign an address to during commissioning. The device detects a connected slave module or a complete AS-i network and displays the found module in the LCD display. Via the on/down keys each address can be individually set. By turning the rotary switch to the setting are intuitive further commissioning functions selected. The innovative device has been to the current AS-i Specification V3.0 and can now also adapted the I/O data of the latest Slaves operator control.

Function

- Reading out and adjusting the slave address 0 to 31 or 1A to 31A, 1B to 31B, with automatic addressing aid and prevention of double addresses
- Reading out the slave profile (IO, ID, ID2)
- Reading out and adjusting the ID1 code
- Input/output test when commissioning the slaves: Input signals read and outputs write with all digital and analog slaves according to AS-Interface Specification V 3.0, including safe input slaves and complex CTT2 slaves
- Measuring the voltage on the AS-Interface cable (measuring range from 2 to 35 V)
- Indication of the operational current in case of direct connection of an AS-i slave (measuring range from 0 to 150 mA)
- Storage of complete network configurations (profiles of all slaves) to simplify the addressing
- Adjusting the Slave parameters for commissioning
- Reading out the identification and diagnostics of CTT2 slaves
- Reading out the code table of safe input slaves (ASIsafe)

Note:

The following applies to the operation of the addressing units to an AS-Interface cable assembly with connected power pack: The AS-Interface addressing unit is suitable for standard AS-i networks and AS-i Power24V networks (operational voltage on the AS-Interface cable min. 19 V).

Benefits







- Increased supply power to the slaves to 150 mA
- Better utilization of the battery capacity thanks to improved circuitry
- Support for the current AS-i Specification V3.0
- Expanded display for simultaneous displaying input and output states
- Clearly recognizable display of status digital inputs/outputs in binary format (0 / 1), optionally also available as hexadecimal values
- Intuitive display analog data either decimal, hexadecimal or as a percentage (e. g. 100 % Corresponds to input/output value 20 mA)
- I/O data of complex slaves (CTT2 profile) can be displayed
- Decoded display of the input data of safe input slaves, including code table
- Simplification of the operating steps when setting the slave address with automatic read back the set address
- Addressing cable, with even without screwing in tight into the M12 socket ready for operation, this faster availability of the addressing unit
- Proven compact housing with smooth keys and rotary switch
- Connection of standard AS-i networks with 30 V as well as networks is possible Power24V
- Complex slaves with high operating current can be addressed without external supply
- Longer operating time per battery pack
- Can be used with all types of digital and analog slaves
- Comprehensive and fast Input/Output test of plants, even if A/B modules with 4 DI / 4 DO and current analog modules with an A/B address
- Faster and more reliable commissioning of the AS-Interface modules
- One-hand operation possible, with unique selection of the functions
- Universal applicability for all AS-i networks

AS-Interface

System components and accessories

Addressing units

Selection and ordering data

	Version	Order No.
 <p>3RK1 904-2AB02</p>	<p>AS-Interface addressing unit V 3.0</p> <ul style="list-style-type: none"> For AS-Interface modules and sensors and actuators with integrated AS-Interface in accordance with AS-i Specification V3.0 For setting the AS-i address of standard slaves, and slaves with extended addressing mode (A/B slaves) With input/output test function and many other commissioning functions Battery operation with 4 batteries type AA (IEC LR6, NEDA 15) Scope of supply: <ul style="list-style-type: none"> - Addressing unit with 4 batteries - Addressing cable, with M12 plug to addressing plug (hollow plug), length 1.5 m 	<p>3RK1 904-2AB02</p>
Accessories		
 <p>3RK1 902-4PB15-3AA0</p>	<p>Addressing cable, with M12 plug to addressing plug (hollow plug) ¹⁾</p> <ul style="list-style-type: none"> Included in the scope of supply of the addressing unit Length 1.5 m 	<p>Z236A</p>
 <p>3RK1 902-4PB15-3AA0</p>	<p>Addressing cable, with M12 plug to M12 socket ²⁾</p> <ul style="list-style-type: none"> For addressing slaves with M12 connection, e.g. K20 or K60R modules or light curtains Length 1.5 m, 3-pole, 3 x 0.34 mm² 	<p>3RK1 902-4PB15-3AA0</p>
 <p>3RX9 801-0AA00</p>	<p>AS-Interface M12 feeders</p> <ul style="list-style-type: none"> For adaptation of AS-Interface cable to a standard round cable Insulation piercing method for connection of AS-Interface cable M12 socket for connection of standard round cable 	<p>3RX9 801-0AA00</p>
 <p>3RK1 901-1NR10</p>	<p>AS-Interface M12 feeders</p> <ul style="list-style-type: none"> Transition of AS-Interface cable without U_{aux}, with M12 socket Insulation piercing method for connection of AS-Interface cable M12 socket for connection of standard round cable 	<p>3RK1 901-1NR10</p>
 <p>3RK1 902-4HB50-5AA0</p>	<p>Cable plug M12 ³⁾</p> <ul style="list-style-type: none"> Extruded M12 plug (angled cable feeder 90°), other cable end open Length: 5 m, 5-pole, color: Black 	<p>3RK1 902-4HB50-5AA0</p>
 <p>3RK1 902-4BA00-5AA0</p>	<p>M12 plug straight ³⁾</p> <ul style="list-style-type: none"> For screw fixing, 5-pole screw terminal, max. 0.75 mm², A-coded, max. 4 A 	<p>3RK1 902-4BA00-5AA0</p>

¹⁾ Can be ordered only from the following address:
 GMC-I Messtechnik GmbH
 Südwestpark 15, D-90449 Nuremberg
 Tel. +49 911 8602 - 0, Fax: +49 911 8602 - 669
 Email: info@gossenmetrawatt.com
 Internet: www.gossenmetrawatt.com

²⁾ Not included in scope of supply of the 3RK1 904-2AB02 addressing unit

³⁾ For connecting the addressing unit to an AS-i network via AS-Interface M12 feeder a connecting cable (M12 plug to M12 connector) is produced and requires the following wiring:
 - M12 cable plug Pin 1 / core brown <-> M12 plug: Pin 1
 - M12 cable plug: Pin 3 / core blue <-> M12 plug: Pin 3
 - Pin 2, 4, 5 not connected

Overview



AS-Interface analyzer

The AS-Interface analyzer is used to test AS-Interface networks. It enables systematic troubleshooting and permanent monitoring.

Installation errors, e. g. loose contacts or EMC interference under extreme loads, can be revealed by this device.

Thanks to the easy-to-use software the user can assess the quality of complete networks even if he lacks detailed specialist knowledge of AS-Interface. In addition it is an easy matter with the AS-Interface analyzer to create test logs from the records produced, thus providing documentation for start-ups and service assignments.

For advanced AS-Interface users there are trigger functions for detailed diagnostics.

Connection

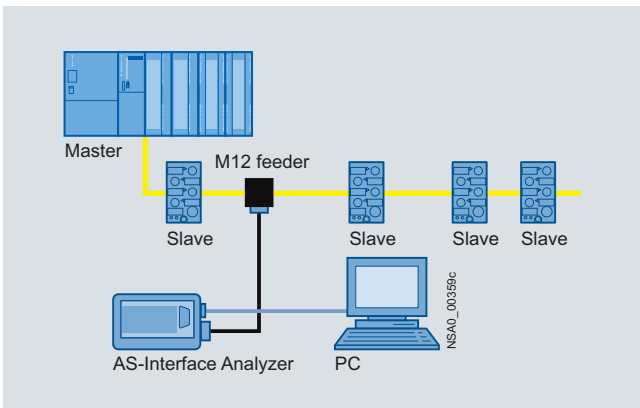

The AS-Interface analyzer follows the communication on the AS-Interface network as a passive station. The unit is supplied simultaneously from the AS-Interface cable.

This analyzer interprets the physical signals on the AS-Interface network and records the communication.

The data thus obtained are transferred through an RS 232 interface to a PC such as a notebook, for evaluation with the supplied diagnostics software.

Benefits

- Simple and user-friendly operation enables diagnostics of AS-Interface networks without help from specialists
- Speedy troubleshooting thanks to intuitive display in statistics mode
- Test logs provide verification of the state and quality of the installation for service and approval
- Recorded logs facilitate remote diagnostics by technical assistance
- Comprehensive trigger functions enable exact analysis
- Process data can be monitored online

Application

Online statistics

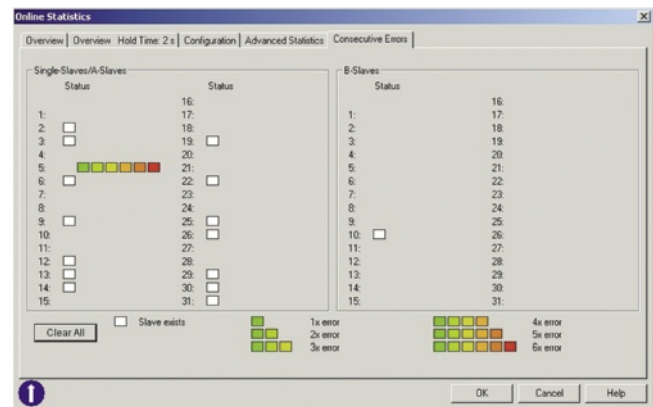
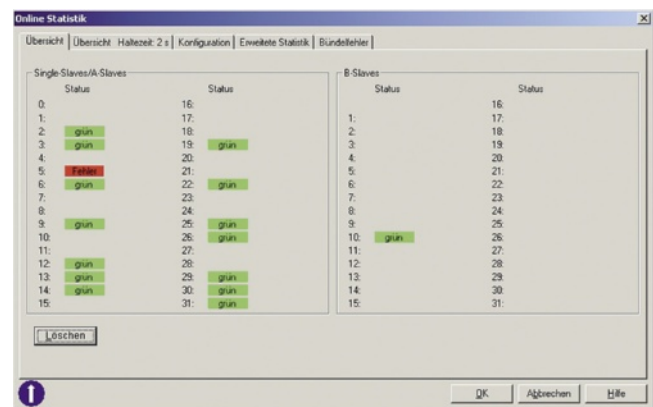

This mode provides a quick overview of the existing AS-Interface system. The error rates are presented per slave in a traffic-light function (green, yellow, red).

The bus configuration and the currently transmitted data of the slaves are shown in a well arranged presentation.

With the expanded statistics function it is possible to determine the error rates as the number of transmitted or faulty bus message frames.

The bundle error overview shows in steps how many multiple repetitions of message frames occurred in order to enable a selective and look-ahead assessment of the transmission quality.

AS-Interface

System components and accessories

Analyzer

Application (continued)

Data mode

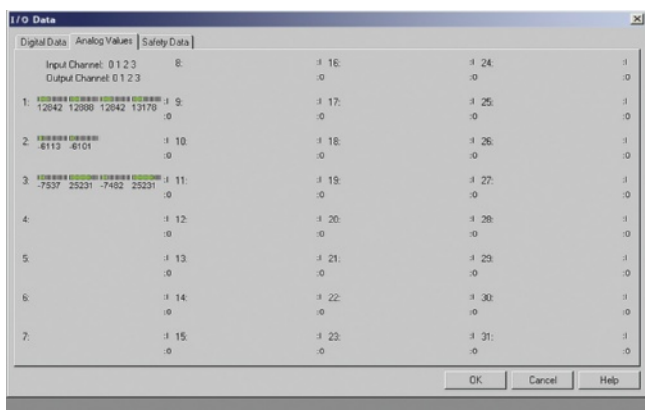
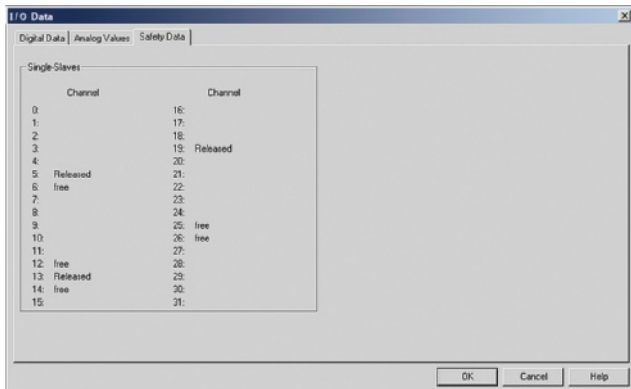

6

In this mode the analyzer now shows not only the digital input/output values but also the current analog values and the input status of the safety slaves.

Trace mode

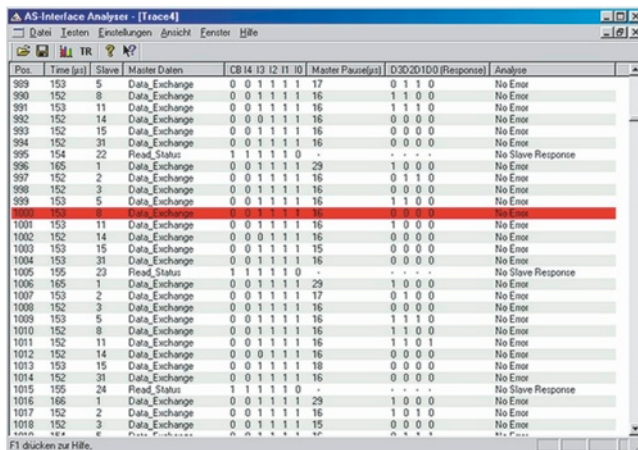

The presentation of message frames in the style of a classic field bus analyzer is indispensable for complex troubleshooting. Extensive trigger functions and recording and viewing filters are available for this purpose.

An external trigger input and trigger output round off the scope of functions in order to find even the most difficult errors.

For troubleshooting in connection with safety monitor applications, changes of status in the code tables of safety slaves are identified and assessed.

Test log







The recorded data of the online statistics are easy to output and document using a test log. Verification of the state of the plant can thus be provided for approvals or service assignments.

The new measurement assistant records the bus signals for an adjustable period, automating the creation of the test log. A standardized quality test of AS-i plants is thus possible.

Note:

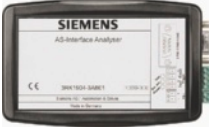
The AS-Interface Analyzer is suitable for standard AS-i networks and AS-i Power24V networks (operating voltage min. 20 V).

Selection and ordering data







Version	Order No.
 <p>3RK1 904-3AB01</p> <p>AS-Interface analyzers</p> <ul style="list-style-type: none"> • For testing actuator/sensor interface systems • For service assignments in installations and networks with AS-Interface systems • Dimensions (W x H x D): 145 x 30 x 92 mm • Scope of supply: <ul style="list-style-type: none"> - AS-Interface analyzers - RS 232 cable for connecting to PC - USB/serial adapter / RS 232 adapter - Screwdriver - Magnetic adhesive tape for fastening the analyzer to metal surfaces - Service case with foam insert, dimensions (W x H x D / mm): approx. 260 x 70 x 200 - Diagnostics software (CD-ROM) for PC (Windows 95/98, ME, 2000, NT, XP, Vista Home Basic, Home Premium, Business, Ultimate, Windows 7) 	3RK1 904-3AB01
<p>Accessories</p> <p>USB/serial adapters</p> <ul style="list-style-type: none"> • For connection to a USB port of a PC • USB/serial adapter included in scope of supply of the 3RK1 904-3AB01 analyzer 	3UF7 946-0AA00-0
 <p>3RX9 801-0AA00</p> <p>AS-Interface M12 feeders</p> <ul style="list-style-type: none"> • For adaptation of shaped AS-Interface cable to a standard round cable • Insulation piercing method for connection of AS-Interface cable • M12 socket for connection of standard round cable • Degree of protection IP67 	3RX9 801-0AA00
 <p>3RK1 901-1NR10</p> <p>AS-Interface M12 feeders</p> <ul style="list-style-type: none"> • Transition of AS-Interface cable without U_{aux}, with M12 socket • Insulation piercing method for connection of AS-Interface cable • M12 socket for connection of standard round cable • Max. 4A • Degree of protection IP67/IP68/IP69K 	3RK1 901-1NR10
 <p>3RK1 902-4HB50-5AA0</p> <p>M12 cable plugs</p> <ul style="list-style-type: none"> • Cable: PUR, 5-pole • Length: 5 m • Color: Black • Extruded M12 plug (angled cable feeder 90°), other cable end open 	3RK1 902-4HB50-5AA0

AS-Interface

System components and accessories

Miscellaneous accessories



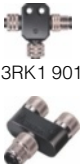





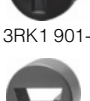

Selection and ordering data

Version	Order No.																																			
 <p>AS-Interface system manual Technical information and overview of the AS-Interface product range from Siemens, scope: approx. 600 pages</p> <ul style="list-style-type: none"> • German edition, paper version (black&white print) ¹⁾ • English edition, paper version (black&white print) ²⁾ 	<p>3RK2 703-3AB02-1AA1</p> <p>3RK2 703-3BB02-1AA1</p>																																			
 <p>AS-Interface compact distributors, for AS-Interface flat cable</p> <ul style="list-style-type: none"> • Current carrying capacity up to 8 A • Degree of protection IP67/IP68/IP69K 	3RK1 901-1NN10																																			
 <p>AS-Interface M12 feeders</p> <ul style="list-style-type: none"> • Degree of protection IP67 <table border="1"> <thead> <tr> <th>For flat cable</th> <th>For</th> <th>Cable length</th> <th>Cable end in feeder</th> <th></th> </tr> </thead> <tbody> <tr> <td>AS-i</td> <td>M12 socket</td> <td>--</td> <td>Available</td> <td>3RX9 801-0AA00</td> </tr> </tbody> </table>	For flat cable	For	Cable length	Cable end in feeder		AS-i	M12 socket	--	Available	3RX9 801-0AA00																										
For flat cable	For	Cable length	Cable end in feeder																																	
AS-i	M12 socket	--	Available	3RX9 801-0AA00																																
 <p>AS-Interface M12 feeders</p> <ul style="list-style-type: none"> • Degree of protection IP67/IP68/IP69K <table border="1"> <thead> <tr> <th>For flat cable</th> <th>For</th> <th>Cable length</th> <th>Cable end in feeder</th> <th></th> </tr> </thead> <tbody> <tr> <td>AS-i</td> <td>M12 socket</td> <td>--</td> <td>Not available</td> <td>3RK1 901-1NR10</td> </tr> <tr> <td>AS-i</td> <td>M12 cable box</td> <td>1 m</td> <td>Not available</td> <td>3RK1 901-1NR11</td> </tr> <tr> <td>AS-i</td> <td>M12 cable box</td> <td>2 m</td> <td>Not available</td> <td>3RK1 901-1NR12</td> </tr> <tr> <td>AS-i / U_{aux}</td> <td>M12 socket</td> <td>--</td> <td>Not available</td> <td>3RK1 901-1NR20</td> </tr> <tr> <td>AS-i / U_{aux}</td> <td>M12 cable box</td> <td>1 m</td> <td>Not available</td> <td>3RK1 901-1NR21</td> </tr> <tr> <td>AS-i / U_{aux}</td> <td>M12 cable box</td> <td>2 m</td> <td>Not available</td> <td>3RK1 901-1NR22</td> </tr> </tbody> </table>	For flat cable	For	Cable length	Cable end in feeder		AS-i	M12 socket	--	Not available	3RK1 901-1NR10	AS-i	M12 cable box	1 m	Not available	3RK1 901-1NR11	AS-i	M12 cable box	2 m	Not available	3RK1 901-1NR12	AS-i / U _{aux}	M12 socket	--	Not available	3RK1 901-1NR20	AS-i / U _{aux}	M12 cable box	1 m	Not available	3RK1 901-1NR21	AS-i / U _{aux}	M12 cable box	2 m	Not available	3RK1 901-1NR22	
For flat cable	For	Cable length	Cable end in feeder																																	
AS-i	M12 socket	--	Not available	3RK1 901-1NR10																																
AS-i	M12 cable box	1 m	Not available	3RK1 901-1NR11																																
AS-i	M12 cable box	2 m	Not available	3RK1 901-1NR12																																
AS-i / U _{aux}	M12 socket	--	Not available	3RK1 901-1NR20																																
AS-i / U _{aux}	M12 cable box	1 m	Not available	3RK1 901-1NR21																																
AS-i / U _{aux}	M12 cable box	2 m	Not available	3RK1 901-1NR22																																
 <p>AS-Interface M12 feeders, 4-fold</p> <p>Degree of protection IP67</p> <table border="1"> <thead> <tr> <th>For flat cable</th> <th>For</th> <th>Cable length</th> <th>Cable end in feeder</th> <th></th> </tr> </thead> <tbody> <tr> <td>AS-i / U_{aux}</td> <td>4-fold M12 socket delivery includes coupling module</td> <td>--</td> <td>Not available</td> <td>3RK1 901-1NR04</td> </tr> </tbody> </table>	For flat cable	For	Cable length	Cable end in feeder		AS-i / U _{aux}	4-fold M12 socket delivery includes coupling module	--	Not available	3RK1 901-1NR04																										
For flat cable	For	Cable length	Cable end in feeder																																	
AS-i / U _{aux}	4-fold M12 socket delivery includes coupling module	--	Not available	3RK1 901-1NR04																																
 <p>M12-T distributors</p> <ul style="list-style-type: none"> • IP68 • 1 x M12 plug • 2 x M12 box 	3RK1 901-1TR00																																			
 <p>M12 Y-shaped coupler plugs</p> <p>For connection of two sensors to one M12 socket with Y connector</p>	6ES7 194-1KA01-0XA0																																			

¹⁾ Free-of-charge download from the Internet at <http://support.automation.siemens.com/WWW/view/en/26250840>

²⁾ Free-of-charge download from the Internet at <http://support.automation.siemens.com/WWW/view/en/26250840>

Selection and ordering data (continued)







	Version	Order No.
	AS-Interface sealing caps M12 For free M12 sockets	3RK1 901-1KA00
	AS-Interface sealing caps M12, tamper-proof For free M12 sockets	3RK1 901-1KA01
	AS-Interface sealing caps M8 For free M8 sockets	3RK1 901-1PN00
	AS-Interface seals M20 • For AS-Interface cable, shaped • For insertion in M20 glands	3RK1 901-1MD00
	Cable adapters for flat cables Connection of AS-Interface cable to metric gland with insulation piercing method • Continuation using standard cable - For M16 gland - For M20 gland • Continuation using pins - For M16 gland - For M20 gland	3RK1 901-3QM00 3RK1 901-3QM10 3RK1 901-3QM01 3RK1 901-3QM11
	Cable clips for cable adapters	3RK1 901-3QA00
	Cable terminating pieces For sealing of open cable ends (shaped AS-Interface cable) in IP67	3RK1 901-1MN00
	K45 mounting plates • For wall mounting • For standard rail mounting	3RK1 901-2EA00 3RK1 901-2DA00
	K60 mounting plates Suitable for all K60 compact modules • For wall mounting • For standard rail mounting	3RK1 901-0CA00 3RK1 901-0CB01
	Sealing sets • For K60 mounting plate and standard distributor • Cannot be used for K45 mounting plate • One set contains one straight and one shaped seal	3RK1 902-0AR00
	Inscription labels • For K45 and K60 compact modules • 20 x 9 mm, pastel turquoise • 19 frames with 20 labels each	3RT1 900-1SB50

AS-Interface

System components and accessories

Miscellaneous accessories

Selection and ordering data (continued)

	Version	Order No.
 <p>3RK1 902-4GB50-4AA0</p>	<p>Control cables, assembled at one end Angular M12 socket for screw fixing, 4-pole, 4 x 0.34 mm² A-coded, black PUR sheath, max. 4 A</p> <ul style="list-style-type: none"> • Cable length 5 m 	<p>3RK1 902-4GB50-4AA0</p>
 <p>3RK1 902-4CA00-4AA0</p>	<p>Angular M12 socket for screw fixing, 4-pole screw terminals, max. 0.75 mm², A-coded, max. 4 A</p>	<p>3RK1 902-4CA00-4AA0</p>
 <p>3RK1 902-4BA00-5AA0</p>	<p>M12 plugs For screw fixing, 5-pole screw terminals, max. 0.75 mm², A-coded, max. 4 A</p>	<p>3RK1 902-4BA00-5AA0</p>
 <p>3RK1 902-4DA00-5AA0</p>	<p>M12 plugs, angled For screw fixing, 5-pole screw terminals, max. 0.75 mm², A-coded, max. 4 A</p>	<p>3RK1 902-4DA00-5AA0</p>
 <p>3RK1 902-4H...-5AA0</p>	<p>Control cables, assembled at one end M12 plugs, angled, for screw fixing, 5-pole, 5 x 0.34 mm², A-coded, black PUR sheath, max. 4 A</p> <ul style="list-style-type: none"> • Cable length 1.5 m • Cable length 5 m • Cable length 10 m 	<p>3RK1 902-4HB15-5AA0 3RK1 902-4HB50-5AA0 3RK1 902-4HC01-5AA0</p>
 <p>3RK1 902-4PB15-3AA0</p>	<p>Control cable, assembled at both ends Straight M12 plug, straight M12 socket, for screw fixing, 3-pole, 3 x 0.34 mm², A-coded, black PUR sheath, max. 4 A</p> <ul style="list-style-type: none"> • Cable length 1.5 m • Also for addressing AS-i slaves with M12 bus connection (e.g. K20, K60R compact modules, M200D motor starters) 	<p>3RK1 902-4PB15-3AA0</p>

Overview

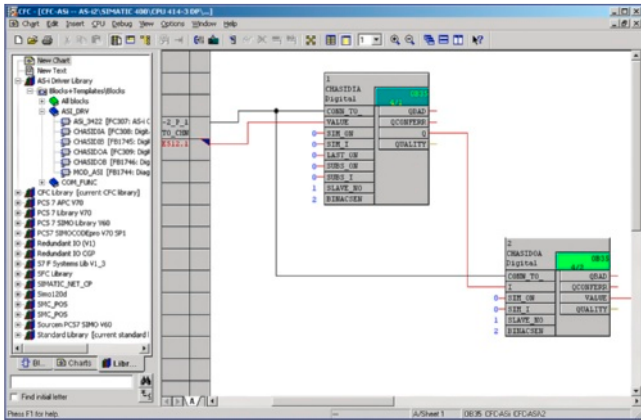

AS-Interface function block library for SIMATIC PCS 7: User interface

The AS-Interface function block library for PCS 7 is integrated in the SIMATIC PCS 7 process control system and expands it for integration of the AS-Interface system.

As the result, the advantages of AS-Interface such as the considerable reduction of wiring outlay for distributed actuators/sensors and very simple installation can also be used in a system based on PCS 7.

The library contains modules for accessing the I/O data of AS-i slaves, modules for diagnostics of the AS-i system, and a faceplate for the PCS 7 Maintenance Station.

The AS-i CP 343-2 / CP 343-2P masters are supported within an ET 200M station connected through PROFIBUS.

For direct connection to PROFIBUS it is possible to use DP/AS-i Link Advanced as an AS-i single master and double master.

Digital AS-i standard slaves and A/B slaves (according to AS-Interface Specification V 3.0) can be used on the CP 343-2 and CP 343-2P.

In combination with DP/AS-i LINK Advanced it is also possible to integrate analog AS-i slaves.

Hardware and software requirements

The library requires PCS 7 Version V 6.1, V 7.0 or V 7.1

Types of delivery and license

The function block library supplied on CD-ROM allows the user to run the required engineering software on the engineering station (single license) including the runtime software for executing the AS modules in an automation system (single license).

If the AS modules are to be used in additional automation systems, the corresponding number of runtime licenses are required which are supplied without a data carrier.

Selection and ordering data

Version	Order No.
AS-Interface function block library for PCS 7	
 <p>Scope of supply AS modules and faceplates for integrating AS-Interface into the PCS 7 process control system, for PCS 7 version V 6.1 V 7.0 or V 7.1</p> <p>Engineering software For one engineering station (single license) including runtime software for execution of the AS module in an automation system (single license), German/English/French, type of delivery: CD incl. electronic documentation</p> <p>Runtime software For execution of the AS module in an automation system (single license), type of delivery: License without software and documentation</p>	<p>3ZS1 635-1XX01-0YA0</p> <p>3ZS1 635-2XX01-0YB0</p>

3ZS1 635-1XX01-0YA0

AS-Interface

Notes

6