

Room temperature controller with large LCD

RDH100



Non-programmable, for heating (or cooling) systems

- Large LCD
- Battery-powered: 2 x alkaline batteries type AA, 1.5 v
- Two-position controller with TPI (PID) response

Use

The RDH 100 is used to control the room temperature in heating (or cooling) systems.

Typical applications:

- Homes
- Residential buildings
- Schools
- Offices

The device is used together with the following equipment:

- Thermal valves or zone valves
- Combi boilers
- Gas or oil burners
- Pumps

Functions

Function diagram

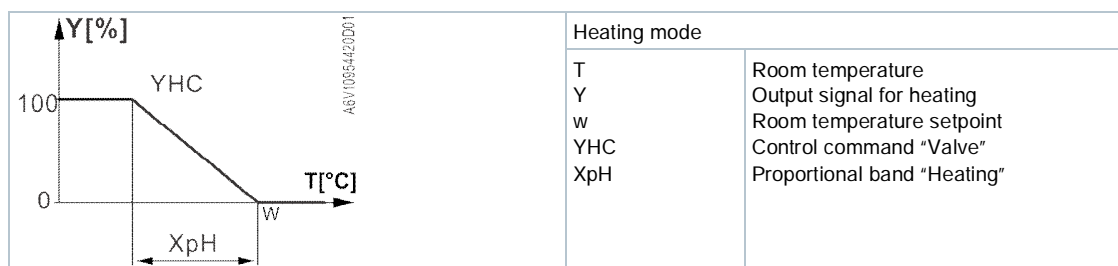

Temperature sensor

The RDH100 provides TPI (PID) control of the room temperature only.

Display



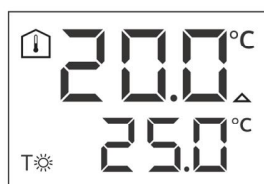



The digital display shows the actual room temperature and the comfort temperature setpoint. When the heating output is active, the triangle symbol appears.



Backup

When taking out the batteries, the setpoints and the information required for operating mode changeover are retained for maximum 2 minutes.

Equipment combinations

Description		Product number	Data sheet *)
Electromotoric actuator		SFA21..	4863
Electrothermal actuator (for radiator valves)		STA23..	4884
Electrothermal actuator (for small valves 2.5mm)		STP23..	4884
Ball valve actuator		GDB..	N6150
Ball valve actuator		GSD..	N4655
Ball valve actuator		GQD..	N4659
Rotary damper actuator		GXD	4622

*) The documents can be downloaded from <http://siemens.com/bt/download>.

Ordering

When ordering, please give name and product number. Room temperature controller RDH100. Valves and actuators are to be ordered as separated items.





Mechanical design

The device consists of 3 parts:

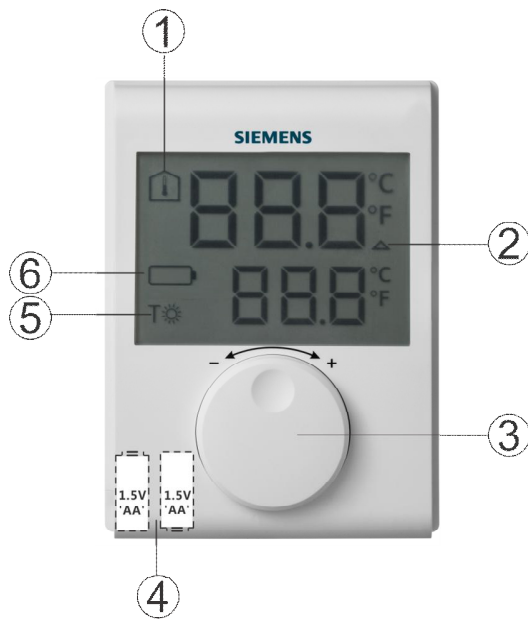
- Plastic housing with digital display accommodating the electronics, operating elements and built-in room temperature sensor
- Baseplate (mounting base)
- Battery compartment

The housing engages in the baseplate and snaps on. The baseplate carries the screw terminals. There is a reset button on the rear of the device.



Elements	1		Display of the room temperature in °C / °F
	2		Indicates a request of heat
	3		Temperature setting knob
	4		Battery compartment
	5		Comfort temperature setpoint
	6		Indicates low battery power; replace batteries

Product documentation

Topic	Title	Document ID:
Operating	Operating instructions	A6V101035984
Installation	Mounting instructions	A6V10974417
CE declaration		A6V101123354

Related documents such as CE declarations, etc., can be downloaded at the following address: <http://siemens.com/bt/download>.

Notes

Mounting

When mounting the device, fix the baseplate first. Then, make the electrical connections, and fit and secure the device (refer to the separated mounting instructions A6V10974417). Mount the device on a flat wall and in compliance with local regulations.

If there are thermostatic radiator valves in the reference room, set them to their fully open position.

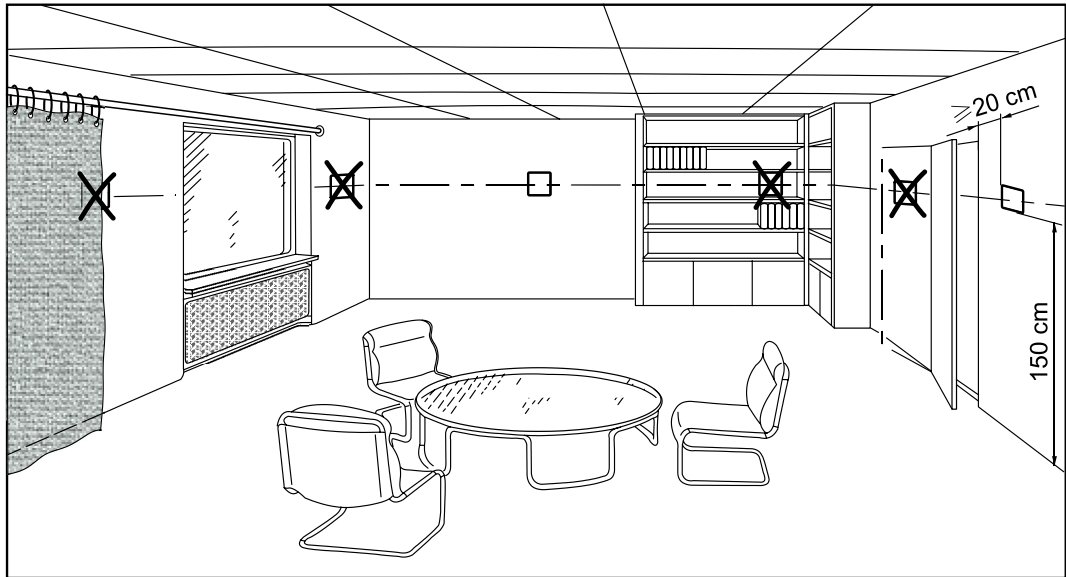

- The devices are suitable for wall mounting.
- Recommended height: 1.5 m above the floor.
- Do not mount the devices in recesses, shelves, behind curtains or doors, or above or near heat sources.
- Avoid direct solar radiation and drafts.
- Seal the conduit box or the installation tube if any, as air currents can affect sensor readings.
- Adhere to allowed ambient conditions.

Installation

	<p>⚠ WARNING</p>
	<p>No internal line protection for supply lines to external consumers. Risk of fire and injury due to short-circuits!</p> <ul style="list-style-type: none"> • Adapt the line diameters as per local regulations to the rated value of the installed overcurrent protection device. • The power supply lines must have an external circuit breaker with a rated current of no more than 10 A.

Change of batteries

If the battery symbol appears, the batteries are almost exhausted and must be replaced.

Reset

To reset, press the reset button on the rear of the device. All individual settings are then reset to their default values.

Maintenance

The device is maintenance-free.

Disposal

	<p>The device is considered an electronics device for disposal in terms of European Directive 2012/19/EU and may not be disposed of as domestic garbage.</p> <ul style="list-style-type: none"> • Dispose of the device through channels provided for this purpose. • Comply with all local and currently applicable laws and regulations.
---	--

Technical data

Power supply	
Operating voltage	DC 3 V (2 x 1.5 V AA alkaline batteries)
Battery life	>1 year (with AA alkaline batteries)

Internal sensor inputs	
Thermistor	10 kΩ ± 1% at 25 °C

Switching outputs (Lx, L1, L2)		
Relay contacts	Switching voltage	Max. AC 250 V Min. AC 24 V
	Switching current	Max. 5 A res., 2 A ind.
	At AC 250 V	Min. 200 mA
Insulating strength	Between relay contacts and coil	AC 3,750 V
	Between relay contacts (same pole)	AC 1,000 V

	<p>⚠ WARNING</p>
	<p>No internal fuse External preliminary protection with max. C 10 A circuit breaker in the supply line required under all circumstances.</p>

Operational data		
Minimum Period Time		12 min
Minimum pulse length		4 min
Setpoint setting range		5...30 °C
Factory setting comfort setpoint		20 °C
Resolution of settings and displays	Temperature setpoint	0.5 °C
	Display of actual temperature value	0.5 °C

Electrical connections	
Connections terminals (via baseplate) For solid wires For stranded wires	Screw terminals 2 x 1.5 mm ² 1 x 2.5 mm ² (min. 0.5 mm ²)

Environmental conditions	
Operation Climatic conditions Temperature Humidity	IEC 60721-3-3 Class 3K5 0...+40 °C <90% r.h.
Transport Climatic conditions Temperature Humidity Mechanical conditions	IEC 60721-3-2 Class 2K3 -25...+60 °C <95% r.h. Class 2M2
Storage Climatic conditions Temperature Humidity	IEC 60721-3-1 Class 1K3 -10...+60 °C <90% r.h.

Standards, directives and approvals	
EU conformity (CE)	A6V101123354
RCM conformity	A6V101123355
Safety class	II as per EN 60730-1
Pollution degree	2
Degree of protection of housing	IP20
Eco design and labeling directives	Based on EU Regulation 813/2013 (Eco design directive) and 811/2013 (Labeling directive) concerning space heaters, the following classes apply: PWM (TPI) room thermostat, for use with On/Off output heaters Class IV Value 2%

General	
Weight (including package)	
Color of housing front	Signal-white RAL9003
Housing material	ABS (LCD lens:PC)

Connection diagram

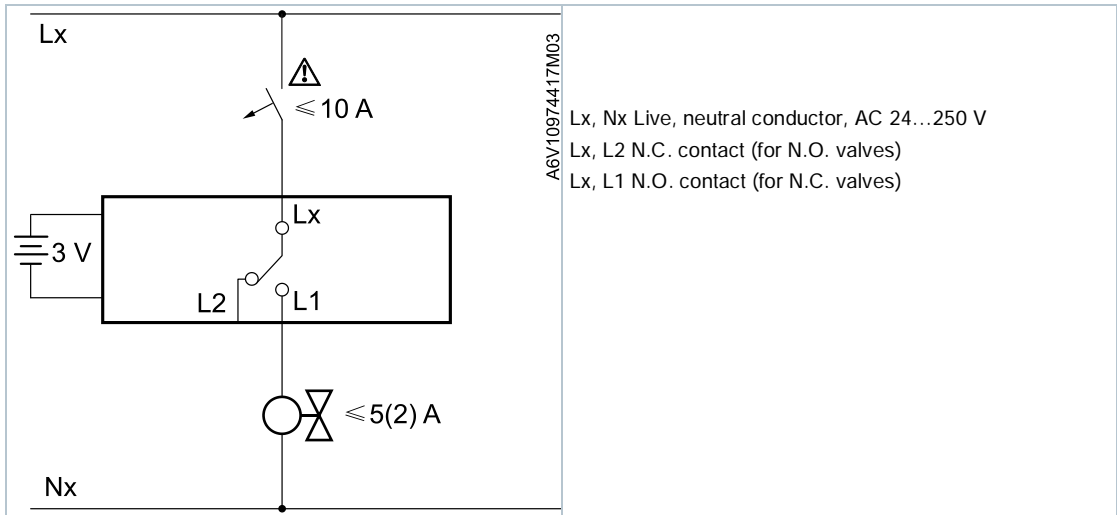

Application examples

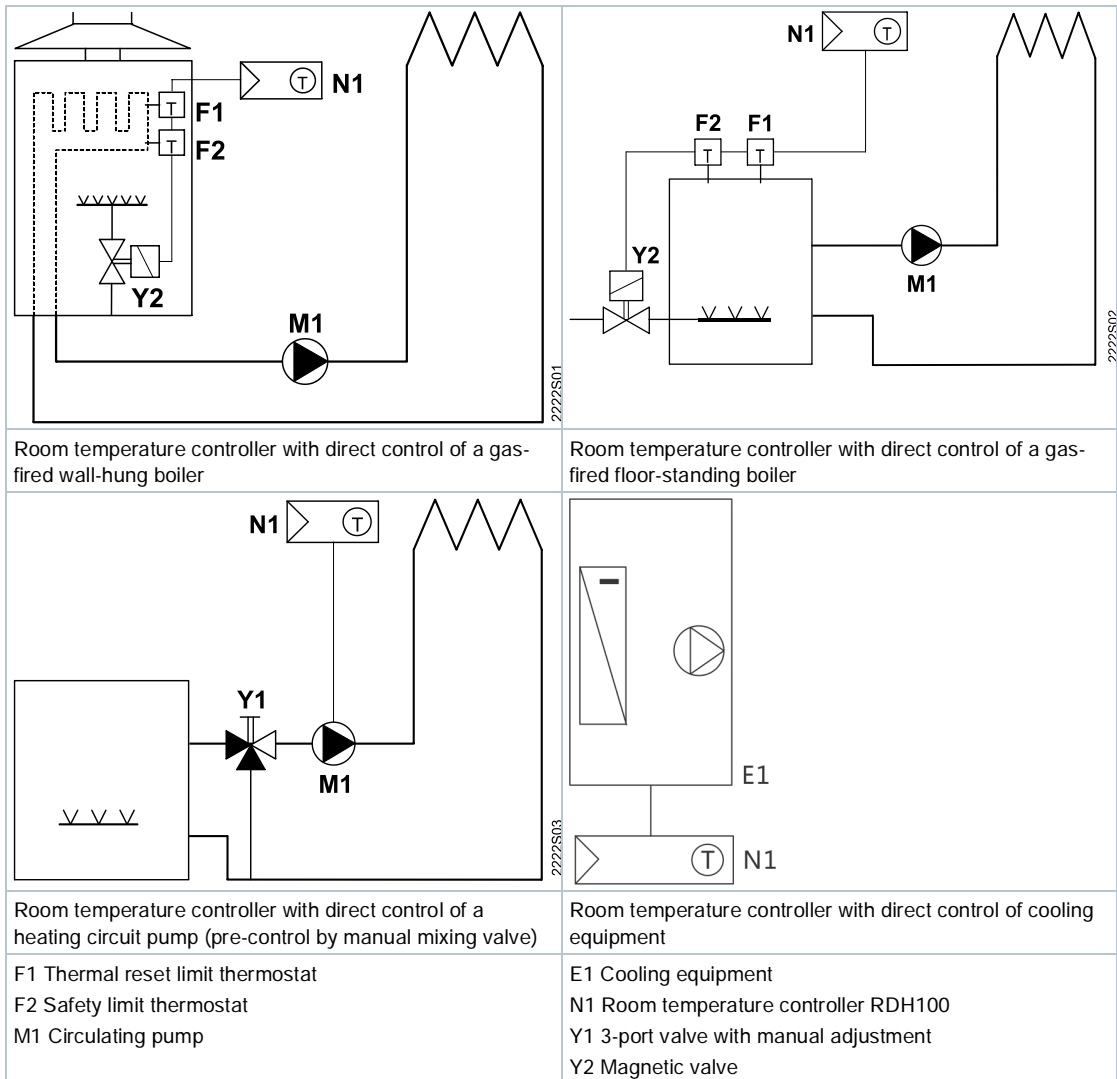

Dimensions

[mm]

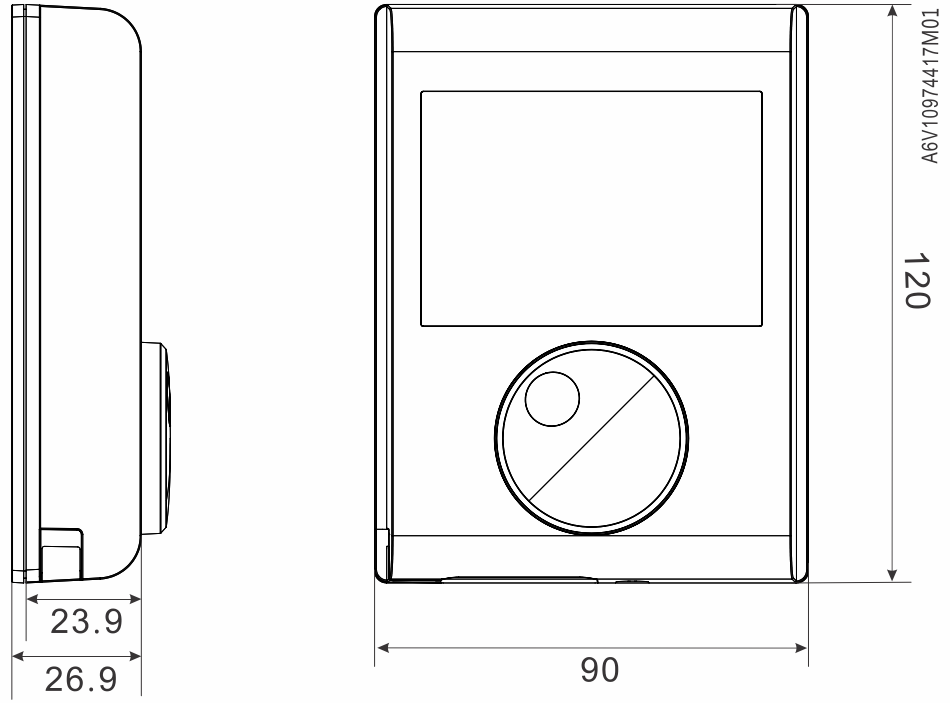

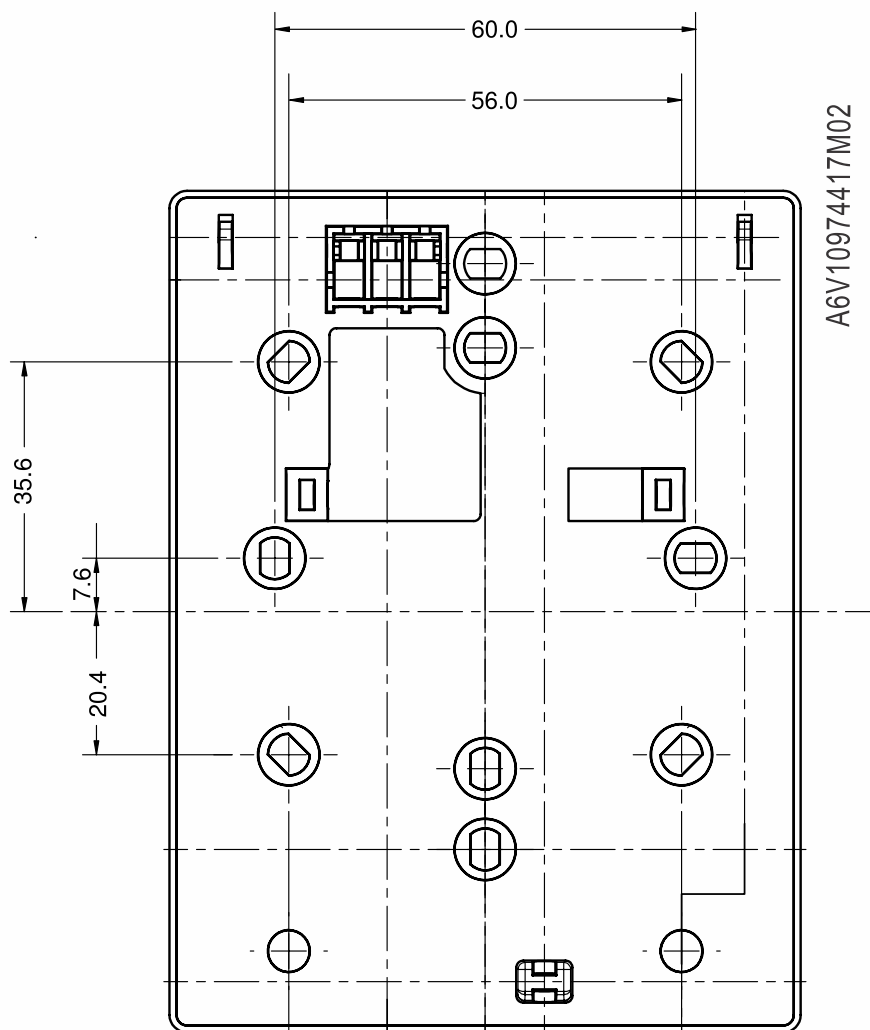

Issued by
 Siemens Switzerland Ltd
 Building Technologies Division
 International Headquarters
 Gubelstrasse 22
 CH-6301 Zug
 Tel. +41 41-724 24 24
www.siemens.com/buildingtechnologies

© Siemens Switzerland Ltd, 2017
 Technical specifications and availability subject to change without notice.