

**SIEMENS**



Catalog  
HA 40.2 ·  
Edition 2017

## Switchgear Type 8DJH for Secondary Distribution Systems up to 24 kV, Gas-Insulated

Medium-Voltage Switchgear

[siemens.com/8DJH](https://www.siemens.com/8DJH)

# Application

Typical uses

R-HA40-111.tif



R-HA40-112.tif



Application  
in public  
and industrial  
energy systems

R\_HA40-150a.tif



R\_HA40\_160.tif

R-HA40-110.tif



R-HA40-157.tif

# Switchgear Type 8DJH for Secondary Distribution Systems up to 24 kV, Gas-Insulated

Medium-Voltage Switchgear

Catalog HA 40.2 · 2017

Invalid: Catalog HA 40.2 · 2014

[siemens.com/medium-voltage-switchgear](http://siemens.com/medium-voltage-switchgear)  
[siemens.com/8DJH](http://siemens.com/8DJH)

The products and systems described in this catalog are manufactured and sold according to a certified management system (acc. to ISO 9001, ISO 14001 and BS OHSAS 18001).

<b>Application</b>	Page
Types, typical uses, ratings, approvals	4 and 5
<b>Requirements</b>	
Features, safety, technology, classification	6 to 8
<b>Technical Data</b>	
Electrical data of the switchgear	9
Switching capacity and classification of switching devices	10 and 11
<b>Product Range</b>	
Individual panels and modules	12 to 14
Air-insulated billing metering panels	15
Product range overview of panel blocks	16 and 17
<b>Design</b>	
Panel design	18 to 21
Outdoor enclosure	22
Operation	23
<b>Components</b>	
Three-position switch-disconnector	24 to 26
Vacuum circuit-breaker	27 to 29
Busbar extension, modularity	30
HV HRC fuse assembly	31
Allocation of HV HRC fuses and transformer ratings	32 to 36
Current and voltage transformers	37 to 41
Current and voltage sensors	42 and 43
Cable connections, cable plugs	44 to 50
Interlocks, locking devices	51
Indicating and measuring equipment	52 to 60
Transformer monitor system, time-fuse-link protection system	61
Intelligent transformer substation	62 and 63
Protection systems	64
Low-voltage compartment, low-voltage niche	65
<b>Dimensions</b>	
Room planning, switchgear installation	66 to 68
Individual panels and modules, panel combinations	69 to 81
Outdoor enclosure	82
Floor openings and fixing points	83 to 86
<b>Installation</b>	
Shipping data, transport	87 and 88
<b>Standards</b>	
Standards, specifications, guidelines	89 to 91



# Application Types



R-HA40-149b.tif

Individual circuit-breaker  
panel 500 mm



R-HA40-150a.eps

RRT block

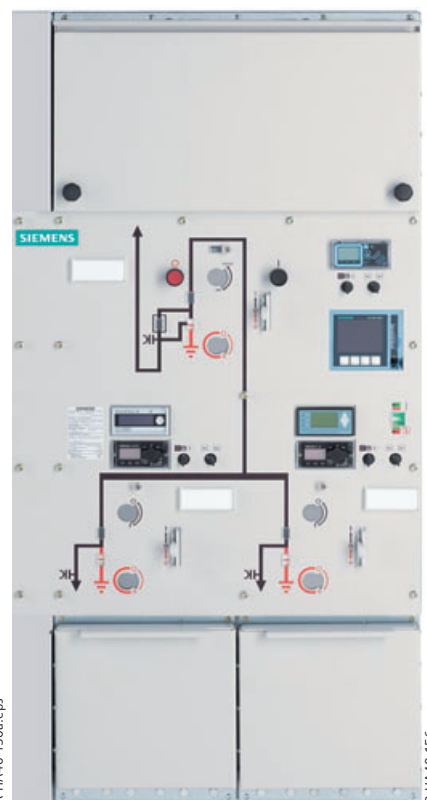

R-HA40-156.eps

8DJH Compact RRT block

8DJH switchgear is a factory-assembled, type-tested, 3-pole metal-enclosed single-busbar switchgear for indoor installation.

8DJH switchgear is used in public and industrial energy systems of the secondary distribution level, e.g. in

- Local ring-main units, customer transfer substations and switching substations of power supply and public utilities
- Wind power and solar plants, hydroelectric power plants
- Water and sewage treatment plants
- Airports, railway stations, underground railway stations
- Open-cast mining facilities
- High-rise buildings.

### National approval GOST

By certification in the system GOST R in Russia, 8DJH is approved for application at the voltage levels 6 kV, 10 kV and 20 kV.

The approval is valid in the countries Russia, Belarus, Kazakhstan and Ukraine.



### Electrical data (maximum values) and dimensions

		7.2	12	15	17.5	24
Rated voltage	kV	7.2	12	15	17.5	24
Rated frequency	Hz	50/60	50/60	50/60	50/60	50/60
Rated short-duration power-frequency withstand voltage	kV	20 <sup>1)</sup>	28 <sup>2)</sup>	36	38	50
Rated lightning impulse withstand voltage	kV	60 <sup>1)</sup>	75 <sup>2)</sup>	95	95	125
Rated peak withstand current	kA	63/65	63/65	63/65	63/65	50/55
Rated short-circuit making current	kA	63/65	63/65	63/65	63/65	50/55
Rated short-time withstand current 3 s	kA	20/21	20/21	20/21	20/21	20/21
Rated short-time withstand current 1 s	kA	25	25	25	25	20/21
Rated normal current of the busbar	A	630	630	630	630	630
Rated normal current of feeders	A	200/250/400/630 <sup>3)</sup> →				
Width (feeders)	mm	310/430/500 <sup>3)</sup> →				
Depth						
– without pressure relief duct	mm	775	775	775	775	775
– with pressure relief duct	mm	890	890	890	890	890
Height without low-voltage compartment and pressure relief duct	mm	optionally 1040/1200/1400/1700				

1) 32 kV/60 kV according to some national requirements

2) 42 kV/75 kV according to some national requirements

3) Depending on the feeder function and the selected design options

# Requirements

## Features

### Environmental independence

Hermetically tight, welded switchgear vessels made of stainless steel as well as single-pole solid insulation make the parts of the primary circuit under high voltage of 8DJH switchgear

- Insensitive to certain aggressive ambient conditions, such as:
  - Saline air
  - Air humidity
  - Dust
  - Condensation
- Tight to ingress of foreign objects, such as:
  - Dust
  - Pollution
  - Small animals
  - Humidity.

### Compact design

Thanks to the use of SF<sub>6</sub> insulation, compact dimensions are possible. Thus:

- Existing switchgear rooms and substation rooms can be used effectively
- New constructions cost little
- Costly city-area space is saved.

### Maintenance-free design

Switchgear vessels designed as sealed pressure systems, maintenance-free switching devices and enclosed cable plugs ensure:

- Maximum supply reliability
- Personnel safety
- Sealed-for-life design according to IEC 62271-200 (sealed pressure system)
- Installation, operation, extension and replacement without SF<sub>6</sub> gas work
- Reduced operating costs
- Cost-efficient investment
- No maintenance cycles.

### Innovation

The use of digital secondary systems and combined protection and control devices ensures:

- Clear integration in process control systems
- Flexible and highly simplified adaptation to new system conditions and thus cost-efficient operation.

### Service life

Under normal operating conditions, the expected service life of gas-insulated switchgear 8DJH is at least 35 years, probably 40 to 50 years, taking the tightness of the hermetically welded switchgear vessel into account. The service life is limited by the maximum number of operating cycles of the switchgear devices installed:

- For circuit-breakers, according to the endurance class defined in IEC 62271-100
- For three-position disconnectors and earthing switches, according to the endurance class defined in IEC 62271-102
- For three-position switch-disconnectors and earthing switches, according to the endurance class defined in IEC 62271-103.

## Safety

### Personal safety

- Safe-to-touch and hermetically sealed primary enclosure
- Standard degree of protection IP 65 for all high-voltage parts of the primary circuit, at least IP 2X for the switchgear enclosure according to IEC 60529 and VDE 0470-1
- Cable terminations, busbars and voltage transformers are surrounded by earthed layers. All high-voltage parts including the cable terminations, busbars and voltage transformers are metal-enclosed
- Operating mechanisms and auxiliary switches safely accessible outside the primary enclosure (switchgear vessel)
- High resistance to internal arcs by logical mechanical interlocks and tested switchgear enclosure
- Panels tested for resistance to internal faults up to 21 kA
- Capacitive voltage detecting system to verify safe isolation from supply
- Due to the system design, operation is only possible with closed switchgear enclosure
- Logical mechanical interlocks prevent maloperation
- HV HRC fuses and cable sealing ends are only accessible when outgoing feeders are earthed
- Feeder earthing via make-proof earthing switches.

### Security of operation

- Hermetically sealed primary enclosure independent of environmental effects (pollution, humidity and small animals)
- Welded switchgear vessels, sealed for life
- Maintenance-free in an indoor environment (IEC 62271-1 and VDE 0671-1)
- Operating mechanisms of switching devices accessible outside the primary enclosure (switchgear vessel)
- Metal-coated, plug-in inductive voltage transformers mounted outside the SF<sub>6</sub> switchgear vessel
- Current transformers as ring-core current transformers mounted outside the SF<sub>6</sub> switchgear vessel
- Complete switchgear interlocking system with logical mechanical interlocks
- Mechanical position indicators integrated in the mimic diagram
- Minimum fire load
- Option: Resistance against earthquakes.

### Reliability

- Type and routine-tested
- Standardized and manufactured using numerically controlled machines
- Quality assurance in accordance with DIN EN ISO 9001
- More than 500,000 switchgear panels of Siemens in operation worldwide for many years.

## General

- Three-pole primary enclosure, metal-enclosed
- Welded switchgear vessel without seals, made of stainless steel, with welded-in bushings for electrical connections and mechanical components
- Insulating gas SF<sub>6</sub> (fluorinated greenhouse gas)
- Maintenance-free components under normal ambient conditions according to IEC 62271-1 and VDE 0671-1
- Three-position switch-disconnector with load-break function and make-proof earthing function
- Vacuum circuit-breaker
- Cable connection with outside-cone plug-in system
  - In ring-main and circuit-breaker feeders with bolted contact (M16)
  - In transformer feeders with plug-in contact or optionally with bolted contact (M16)
- Wall-standing or free-standing arrangement
- Pressure relief downwards, optionally to the rear or upwards via pressure absorber systems.

## Interlocks

- According to IEC 62271-200 and VDE 0671-200
- Logical mechanical interlocks prevent maloperation
- Logical mechanical interlocks and the constructive features of the three-position switches prevent maloperation as well as access to the cable connection of the feeders and HV HRC fuses under voltage
- Impermissible and undesired operations can be prevented by means of locking devices provided at the switching devices
- A detailed description of all interlocking options is available on page 51.

## Insulating system

- Switchgear vessel filled with SF<sub>6</sub> gas
- Features of SF<sub>6</sub> gas:
  - Non-toxic
  - Odorless and colorless
  - Non-inflammable
  - Chemically neutral
  - Heavier than air
  - Electronegative (high-quality insulator)
  - Global Warming Potential GWP = 22,800
- Pressure of SF<sub>6</sub> gas in the switchgear vessel (absolute values at 20 °C):
  - Rated filling level: 150 kPa
  - Design pressure: 180 kPa
  - Design temperature of the SF<sub>6</sub> gas: 80 °C
  - Operating pressure of bursting disc: ≥ 300 kPa
  - Bursting pressure: ≥ 550 kPa
  - Gas leakage rate: < 0.1 % per year.

## Modular design

- Individual panels and panel blocks can be lined up and extended at will – without gas work on site
- Low-voltage compartment available in 4 overall heights, wiring to the panel via plug connectors.

## Panel design

- Factory-assembled, type-tested
- Metal-enclosed, with metallic partitions <sup>1)</sup>
- Hermetically tight, welded switchgear vessel made of stainless steel
- Maintenance-free
- Degree of protection
  - IP 65 for all high-voltage parts of the primary circuit in the gas-insulated panels
  - IP 2X for the switchgear enclosure
- Vacuum circuit-breaker with three-position disconnector for disconnecting and earthing
- Three-position switch-disconnector
- Cable connection with outside-cone plug-in system according to DIN EN 50181
- Wall-standing arrangement, optionally free-standing arrangement
- Installation and possible later extension of existing panels without gas work
- Replacement of instrument transformers without gas work, as they are located outside the gas compartments
- Enclosure made of sendzimir-galvanized sheet steel, front cover powder-coated in color "light basic" (SN 700)
- Low-voltage compartment removable, plug-in bus wires
- Lateral, metallic wiring ducts for control cables.

## Instrument transformers

- Current transformers not subjected to dielectric stress
- Easy replacement of current transformers designed as ring-core transformers
- Metal-coated, plug-in voltage transformers.

## Vacuum circuit-breaker

- Maintenance-free under normal ambient conditions according to IEC 62271-1 and VDE 0671-1
- No relubrication or readjustment
- Up to 10,000 operating cycles
- Vacuum-tight for life.

## Secondary systems

- Customary protection, measuring and control equipment
- Option: Numerical multifunction protection relay with integrated protection, control, communication, operating and monitoring functions
- Can be integrated in process control systems.

1) Corresponds to "metal-clad" according to former standard IEC 60298

# Requirements

## Classification

8DJH switchgear is classified according to IEC/EN 62271-200/VDE 0671-200.

### Design and construction

Partition class	PM (partition of metal)
Loss of service continuity category for panels or panel blocks	
– With HV HRC fuses (T, H)	LSC 2
– Without HV HRC fuses (R, L, ...)	LSC 2
Billing metering panel M	LSC 1
Cable panel K	
Accessibility to compartments (enclosure)	
– Busbar compartment	– Non-accessible
– Switching-device compartment	– Non-accessible
– Low-voltage compartment (option)	– Tool-based
– Cable compartment for panels or panel blocks	
– With HV HRC fuses (T)	– Interlock-controlled
– Without HV HRC fuses (R, L, ...)	– Interlock-controlled
– Only cable feeder (K)	– Tool-based
– Metering panels (air-insulated) (M)	– Tool-based

### Internal arc classification (Option)

Designation of the internal arc classification IAC	Rated voltage 7.2 kV to 24 kV
IAC class for 8DJH Standard and 8DJH Compact design for	
– Wall-standing arrangement	IAC A FL
– Free-standing arrangement	IAC A FLR
Additionally only for 8DJH Compact design for	
– Installation in substations without control aisle <sup>1)</sup>	IAC A F
Type of accessibility A	Switchgear in closed electrical service location, access “for authorized personnel only” (according to IEC/EN 62271-200)
– F	Front
– L	Lateral
– R	Rear (for free-standing arrangement)
Arc test current	Up to 21 kA
Test duration	1 s

1) Rear space required for pressure relief.

Application recommended in prefabricated substations without control aisle, tested according to IEC 62271-202.



Rated insulation level		Rated voltage $U_r$	kV	7.2	12	15	17.5	24
		Rated short-duration power-frequency withstand voltage $U_d$						
		– Phase-to-phase, phase-to-earth, open contact gap	kV	20	28/42 <sup>1)</sup>	36	38	50
		– Across the isolating distance	kV	23	32/48 <sup>1)</sup>	39	45	60
		Rated lightning impulse withstand voltage $U_p$						
		– Phase-to-phase, phase-to-earth, open contact gap	kV	60	75	95	95	125
		– Across the isolating distance	kV	70	85	110	110	145
Rated frequency $f_r$			Hz	50/60				
Rated normal current $I_r$ <sup>2)</sup>		for ring-main feeders	A	400 or 630				
		for busbar	A	630				
		for circuit-breaker feeders	A	250 or 630				
		for transformer feeders	A	200 <sup>3)</sup>				
50 Hz	Rated short-time withstand current $I_k$	for switchgear with $t_k = 1$ s	up to kA	25	25	25	25	20/21 <sup>1)</sup>
		for switchgear with $t_k = 3$ s (design option)	up to kA	20/21 <sup>1)</sup>				
	Rated peak withstand current $I_p$	up to kA	63	63	63	63	50/52.5 <sup>1)</sup>	
	Rated short-circuit making current $I_{ma}$	for ring-main feeders	up to kA	63	63	63	63	50/52.5 <sup>1)</sup>
for circuit-breaker feeders		up to kA	63	63	63	63	50/52.5 <sup>1)</sup>	
for transformer feeders		up to kA	63	63	63	63	50/52.5 <sup>1)</sup>	
60 Hz	Rated short-time withstand current $I_k$	for switchgear with $t_k = 1$ s	up to kA	25	25	25	25	20/21 <sup>1)</sup>
		or switchgear with $t_k = 3$ s (design option)	up to kA	20/21 <sup>1)</sup>				
	Rated peak withstand current $I_p$	up to kA	65	65	65	65	52/55 <sup>1)</sup>	
	Rated short-circuit making current $I_{ma}$	for ring-main feeders	up to kA	65	65	65	65	52/55 <sup>1)</sup>
for circuit-breaker feeders		up to kA	65	65	65	65	52/55 <sup>1)</sup>	
for transformer feeders		kA	65	65	65	65	52/55 <sup>1)</sup>	
Filling pressure (pressure values at 20 °C)	Rated filling level $p_{re}$ (absolute)	kPa	150					
	Minimum functional level $p_{me}$ (absolute)	kPa	130					
Ambient air temperature $T$ <sup>4)</sup>	Operation	standard	°C	-25 to +55				
		on request	°C	-40 to +70				
	Storage / transport	standard	°C	-25 to +55				
		on request	°C	-40 to +70				
Degree of protection	for gas-filled switchgear vessel		IP65					
	for switchgear enclosure		IP2X / IP3X <sup>1)</sup>					
	for low-voltage compartment		IP3X / IP4X <sup>1)</sup>					

1) Design option

2) The rated normal currents apply to ambient air temperatures of max. 40 °C.  
The 24-hour mean value is max. 35 °C (according to IEC/EN 62271-1/VDE 0671-1)

3) Depending on HV HRC fuse-link

4) Minimum and maximum permissible ambient air temperature depending on the secondary equipment used

# Technical Data

## Switching capacity and classification of switching devices

### Three-position switch-disconnector

#### Switching capacity for general-purpose switches according to IEC/EN 62271-103 (former: IEC/EN 60265-1/VDE 0670-301)

Rated voltage $U_r$		kV	7.2	12	15	17.5	24
Test duty $TD_{load}$	Rated mainly active load breaking current $I_{load}$	100 operations $I_{load} [I_1]$	A 630				
		20 operations $0.05 I_{load} [I_1]$	A 31.5				
Test duty $TD_{loop}$	Rated closed-loop breaking current $I_{loop} [I_{2a}]$		A 630				
Test duty $TD_{cc}$	Rated cable-charging breaking current $I_{cc} [I_{4a}]$		A 68				
Test duty $TD_{lc}$	Rated line-charging breaking current $I_{lc} [I_{4b}]$		A 68				
Test duty $TD_{ma}$	Rated short-circuit making current $I_{ma}$	50 Hz	up to kA 63	63	63	63	50/52.5 <sup>1)</sup>
		60 Hz	up to kA 65	65	65	65	52/55 <sup>1)</sup>
Test duty $TD_{ef1}$	Rated earth-fault breaking current $I_{ef1} [I_{6a}]$		A 200				
Test duty $TD_{ef2}$	Rated cable-charging breaking current and line-charging breaking current under earth-fault conditions $I_{ef2} [I_{6b} (\sqrt{3} \cdot I_{4a}) \text{ or } I_{6b} (\sqrt{3} \cdot I_{4b})]$		A 115				
Number of operating cycles, mechanical / Classification			n 1000/M1				
Number of operating cycles, electrical with $I_{load}$ / Classification			n 100/E3				
Number of short-circuit making operations with $I_{ma}$ / Classification			n 5/E3	5/E3	5/E3	5/E3	5/E3
C-classification for general-purpose switches (no restrikes, TD: $I_{cc}$ , $I_{lc}$ )			C2	C2	C2	C2	C2

#### Switching capacity for make-proof earthing switch according to IEC/EN 62271-102/VDE 0671-102

Rated short-circuit making current $I_{ma}$	50 Hz	up to kA 63	63	63	63	63	50/52.5 <sup>1)</sup>
	60 Hz	up to kA 65	65	65	65	65	52/55 <sup>1)</sup>
Number of operating cycles, mechanical / Classification		n 1000/M0					
Number of short-circuit making operations		n 5					
Classification		E2					

### Switch-disconnector/fuse combination

#### Switching capacity for switch-disconnector/fuse combination according to IEC/EN 62271-105/VDE 0671-105

Rated normal current	A 200 <sup>2)</sup>					
Rated transfer current $I_{transfer}$	A 1500	1500	1300	1300	1300	

#### Switching capacity for make-proof earthing switch, feeder side, in transformer feeder with HV HRC fuses

Rated short-circuit making current $I_{ma}$	50 Hz	kA 6.3				
	60 Hz	kA 6.5				
Rated short-time withstand current $I_k$ with $t_k = 1$ s		kA 2.5				

1) Design option

2) Depending on HV HRC fuse-link

### Vacuum circuit-breaker

Switching capacity according to IEC/EN 62271-100/VDE 0671-100

#### Type 1.1 with three-position disconnector

Rated voltage $U_r$		kV	7.2	12	15	17.5	24	
Rated normal current of feeders $I_r$		A	630					→
50 Hz	Rated short-time withstand current $I_k$	for switchgear with $t_k = 1$ s	up to kA	25	25	25	25	20/21 <sup>1)</sup>
		for switchgear with $t_k = 3$ s	up to kA	20/21 <sup>1)</sup>				
	Rated peak withstand current $I_p$	up to kA	63	63	63	63	50/52.5 <sup>1)</sup>	
	Rated short-circuit breaking current $I_{sc}$	up to kA	25	25	25	25	20/21 <sup>1)</sup>	
	Rated short-circuit making current $I_{ma}$	up to kA	63	63	63	63	50/52.5 <sup>1)</sup>	
60 Hz	Rated short-time withstand current $I_k$	for switchgear with $t_k = 1$ s	up to kA	25	25	25	25	20/21 <sup>1)</sup>
		for switchgear with $t_k = 3$ s	up to kA	20/21 <sup>1)</sup>				
	Rated peak withstand current $I_p$	up to kA	65	65	65	65	52/55 <sup>1)</sup>	
	Rated short-circuit breaking current $I_{sc}$	up to kA	25	25	25	25	20/21 <sup>1)</sup>	
	Rated short-circuit making current $I_{ma}$	up to kA	65	65	65	65	52/55 <sup>1)</sup>	
Number of mechanical operating cycles for disconnector		n	1000					→
Number of mechanical operating cycles for earthing switch		n	1000					→
Number of mechanical operating cycles for circuit-breaker		n	10,000					→
Classification of circuit-breaker			M2, E2, C2, S2					→
Classification of disconnector			M0					→
Classification of make-proof earthing switch			E2					→
Rated operating sequence			O – 0.3 s – CO – 3 min – CO					→
			O – 0.3 s – CO – 15 s – CO on request					→
Number of short-circuit breaking operations		n	25 or 50					→

#### Type 2 with three-position disconnector

Rated voltage $U_r$		kV	7.2	12	15	17.5	24	
Rated normal current of feeders $I_r$		A	250 A or 630 A					→
50 Hz	Rated short-time withstand current $I_k$	for switchgear with $t_k = 1$ s	up to kA	25	25	25	25	20/21 <sup>1)</sup>
		for switchgear with $t_k = 3$ s	up to kA	20/21 <sup>1)</sup>				
	Rated peak withstand current $I_p$	up to kA	63	63	63	63	50/52.5 <sup>1)</sup>	
	Rated short-circuit breaking current $I_{sc}$	up to kA	25	25	25	25	20/21 <sup>1)</sup>	
	Rated short-circuit making current $I_{ma}$	up to kA	63	63	63	63	50/52.5 <sup>1)</sup>	
60 Hz	Rated short-time withstand current $I_k$	for switchgear with $t_k = 1$ s	up to kA	25	25	25	25	20/21 <sup>1)</sup>
		for switchgear with $t_k = 3$ s	up to kA	20/21 <sup>1)</sup>				
	Rated peak withstand current $I_p$	up to kA	65	65	65	65	52/55 <sup>1)</sup>	
	Rated short-circuit breaking current $I_{sc}$	up to kA	25	25	25	25	20/21 <sup>1)</sup>	
	Rated short-circuit making current $I_{ma}$	up to kA	65	65	65	65	52/55 <sup>1)</sup>	
Number of mechanical operating cycles for disconnector		n	1000					→
Number of mechanical operating cycles for earthing switch		n	1000					→
Number of mechanical operating cycles for circuit-breaker		n	2000					→
Classification of circuit-breaker			M1, E2, C1, S1					→
Classification of disconnector			M0					→
Classification of make-proof earthing switch			E2					→
Rated operating sequence			O – 3 min – CO – 3 min – CO					→
Number of short-circuit breaking operations		n	6 or 20					→

1) Design option

# Product Range

Individual panels and modules – freely configurable for up to 4 functions in the block

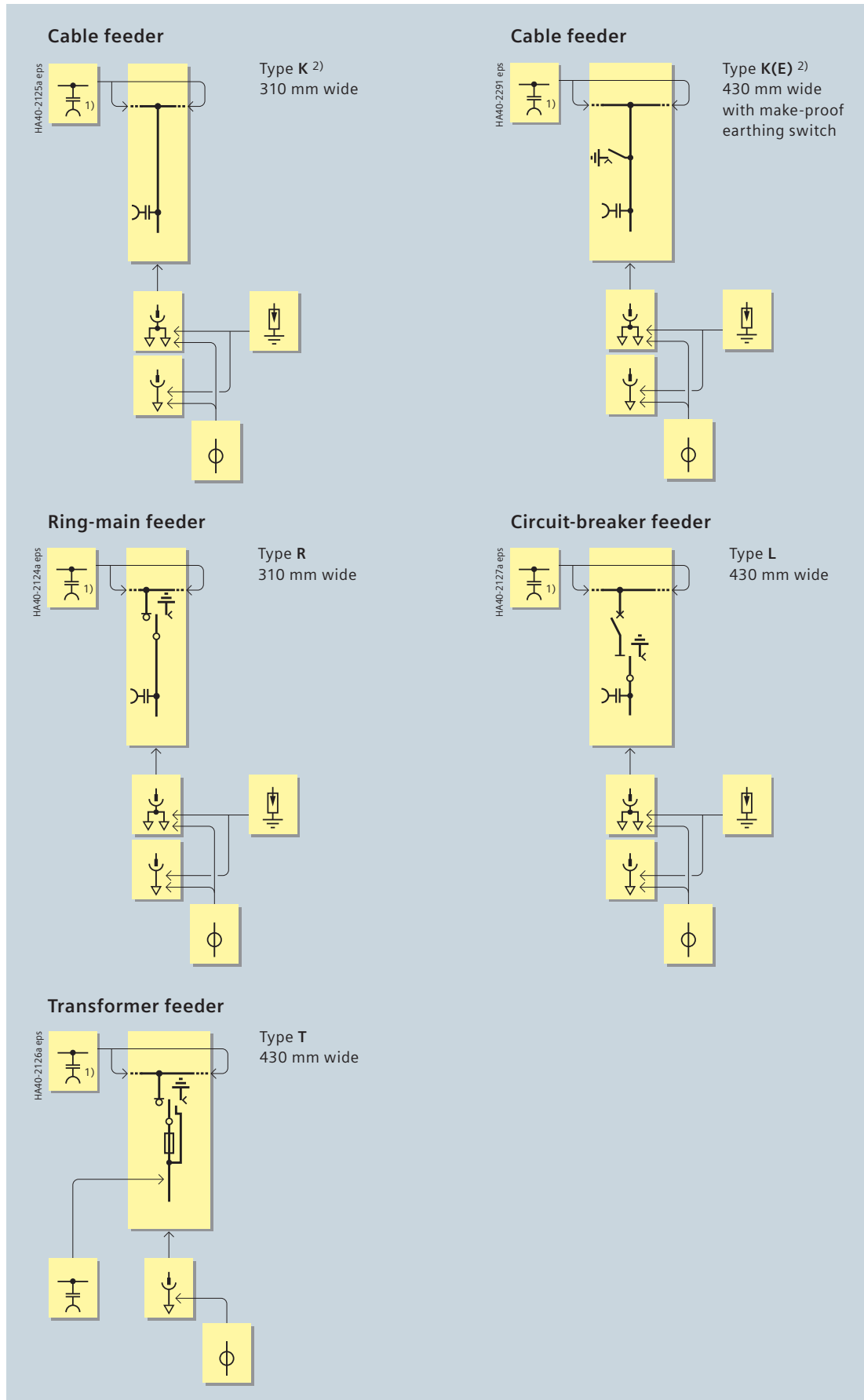

1) Only for end panel, on the free connection side of the busbar  
 2) Only as individual panel and in 2-panel blocks

**Bus sectionalizer panel  
with switch-disconnector**

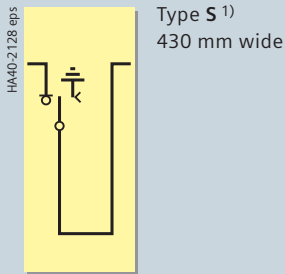

**with switch-fuse combination**

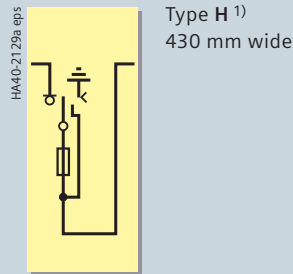

**Bus sectionalizer panel with switch-disconnector**

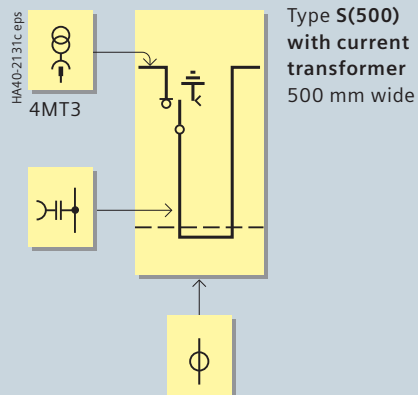
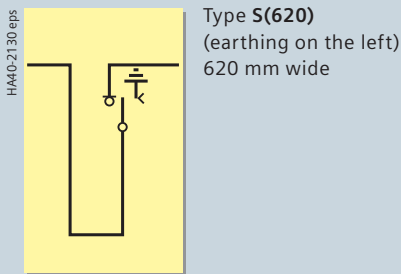

**Bus sectionalizer panel with circuit-breaker**

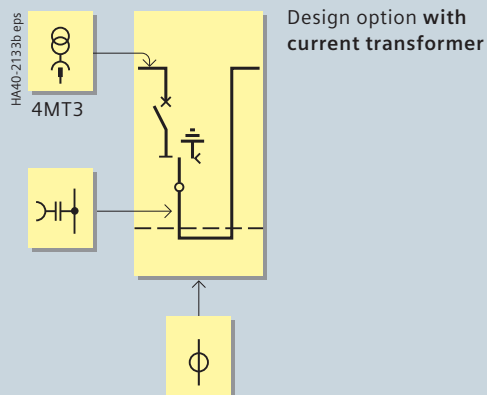
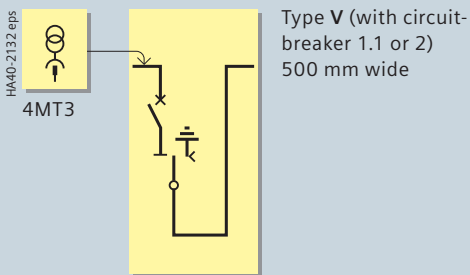

Vacuum  
circuit-breaker



Three-position  
switch-disconnector



Three-position  
disconnecter



Capacitive voltage  
detecting system



HV HRC fuse



Current transformer



Plug-in voltage  
transformer 4MT3

1) Also executable as right-hand panel in panel blocks



# Product Range

Individual panels

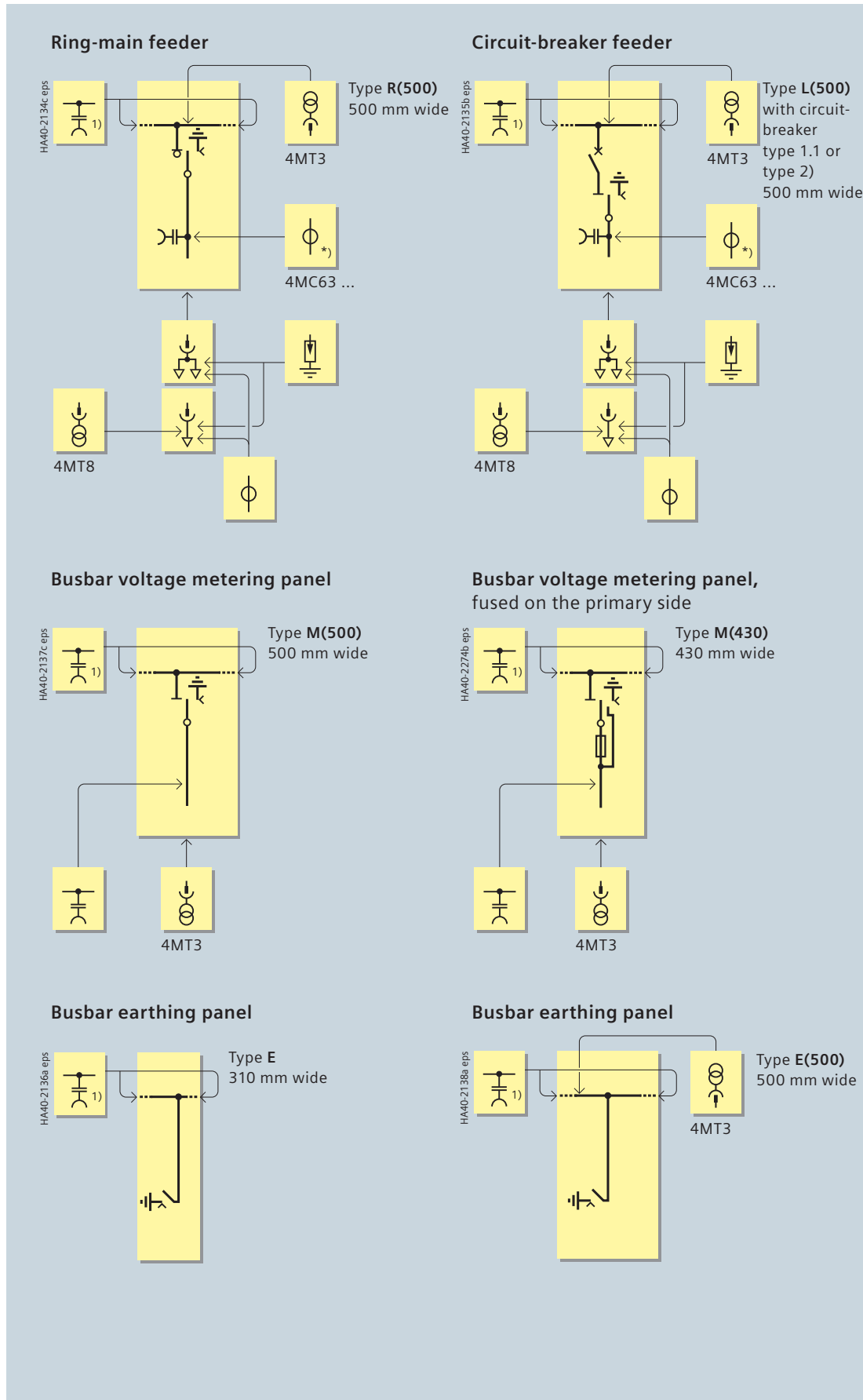

1) Only for end panel, on the free connection side of the busbar

### Billing metering panels with cable connection on the left

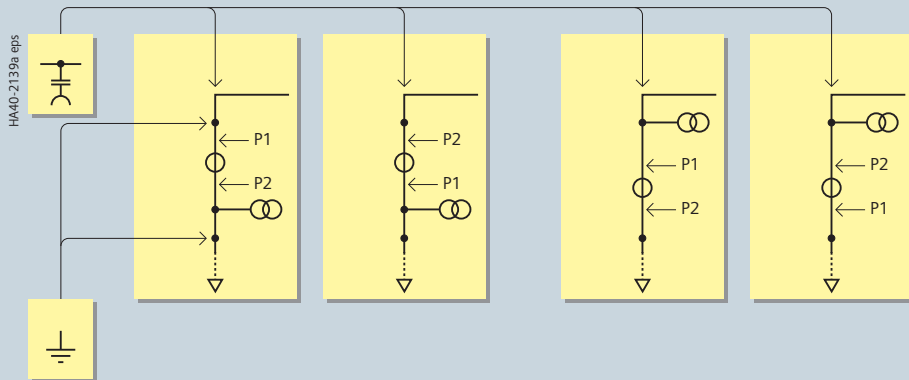

### Billing metering panels with cable connection on the right

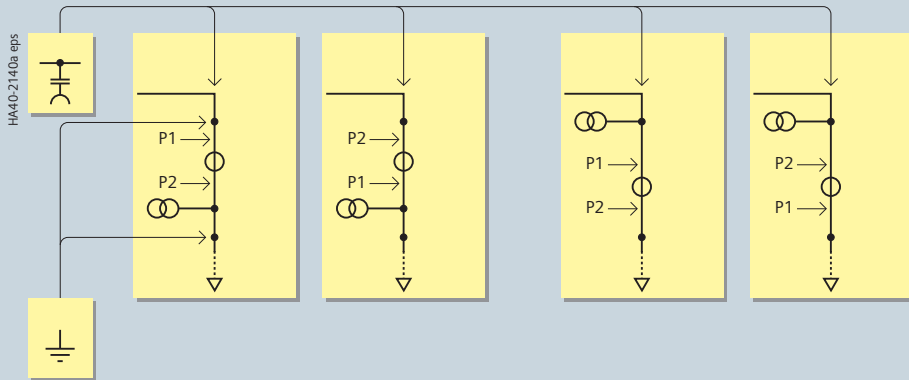

### Billing metering panels with busbar connection on both sides

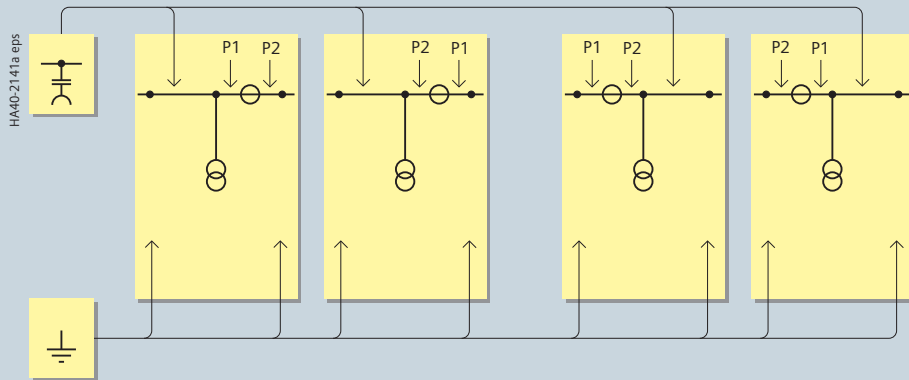

### Billing metering panels with cable connection on both sides

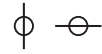
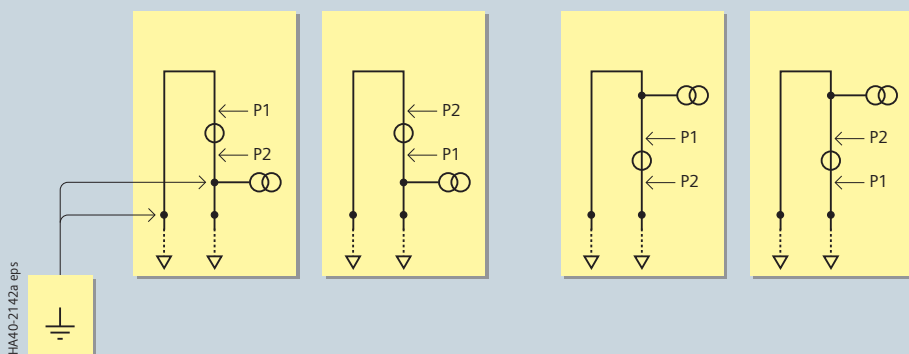

Current transformer,  
cast-resin insulated



Voltage transformer,  
cast-resin insulated



Capacitive voltage  
detecting system



Fixed earthing  
points for  
busbar earthing

P1 and P2  
are terminal  
designations of  
the current  
transformer

# Product Range

Product range overview of panel blocks (excerpt)

Panel block Components shown in dotted lines can be used optionally.	Installation dimensions		
	Width	Depth	Height
	mm	mm	mm

Panel block Components shown in dotted lines can be used optionally.	Installation dimensions		
	Width	Depth	Height
	mm	mm	mm

## Panel blocks with transformer feeders, optionally with busbar extension

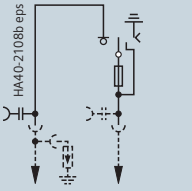
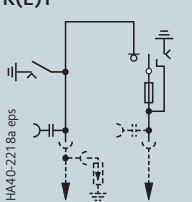
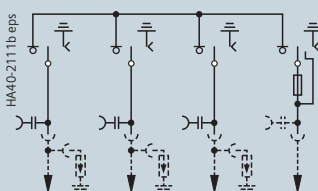
<b>KT</b> 	K Radial cable connection as incoming feeder	1 transformer feeder, 1 radial cable connection	740	775	1200 1400 1700
		1 transformer feeder, 1 radial cable connection with make-proof earthing switch	860	775	1200 1400 1700
<b>RT</b> 		1 ring-main feeder, 1 transformer feeder	740	775	1040 1200 1400 1700
		2 ring-main feeders, 1 transformer feeder	1050	775	1040 1200 1400 1700
<b>RRRT</b> 		3 ring-main feeders, 1 transformer feeder	1360	775	1200 1400 1700
		2 ring-main feeders, 2 transformer feeders	1480	775	1200 1400 1700

## Panel blocks with circuit-breaker feeders, optionally with busbar extension

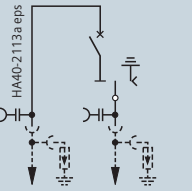
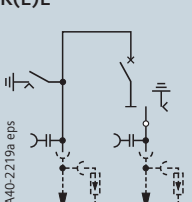
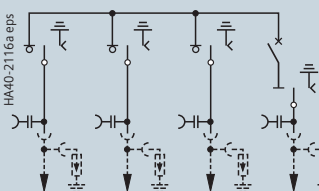
<b>KL</b> 	K Radial cable connection as incoming feeder	1 circuit-breaker feeder, 1 radial cable connection	740	775	1200 1400 1700
		1 circuit-breaker feeder, 1 radial cable connection with make-proof earthing switch	860	775	1200 1400 1700
<b>RL</b> 		1 ring-main feeder, 1 circuit-breaker feeder	740	775	1200 1400 1700
		2 ring-main feeders, 1 circuit-breaker feeder	1050	775	1200 1400 1700
<b>RRRL</b> 		3 ring-main feeders, 1 circuit-breaker feeder	1360	775	1200 1400 1700
		2 ring-main feeders, 2 circuit-breaker feeders	1480	775	1200 1400 1700

Panel block Components shown in dotted lines can be used optionally.	Installation dimensions		
	Width	Depth	Height
	mm	mm	mm

### Panel blocks with ring-main feeders, optionally with busbar extension

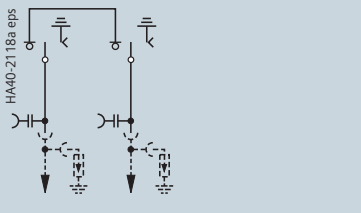
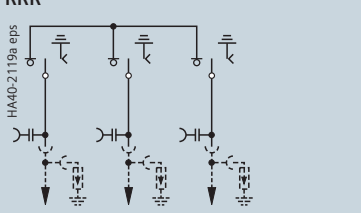
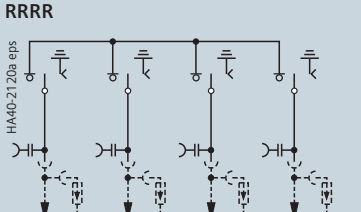
<b>RR</b> 	2 ring-main feeders		
	620	775	1040 1200 1400 1700
<b>RRR</b> 	3 ring-main feeders		
	930	775	1040 1200 1400 1700
<b>RRRR</b> 	4 ring-main feeders		
	1240	775	1200 1400 1700

Panel block Components shown in dotted lines can be used optionally.	Installation dimensions		
	Width	Depth	Height
	mm	mm	mm

### Panel blocks with transformer feeders, optionally with busbar extension

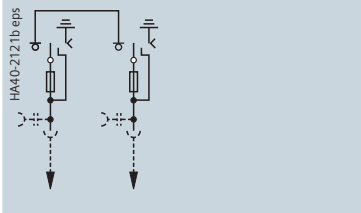
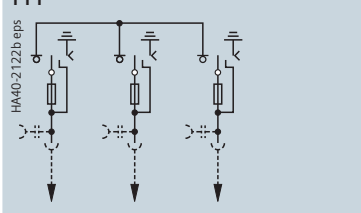
<b>TT</b> 	2 transformer feeders		
	860	775	1200 1400 1700
<b>TTT</b> 	3 transformer feeders		
	1290	775	1200 1400 1700

Panel block Components shown in dotted lines can be used optionally.	Installation dimensions		
	Width	Depth	Height
	mm	mm	mm

### Panel blocks with transformer feeders as 8DJH Compact, without busbar extension

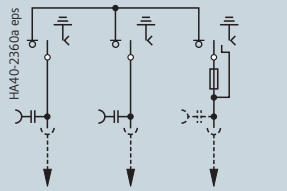
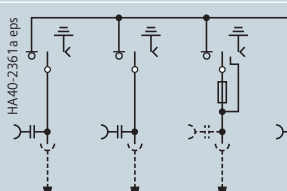
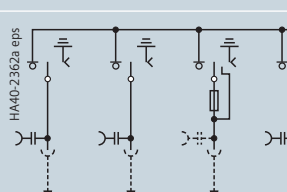
<b>RRT</b> 			
	620	775	1400 1700
<b>RRT-R</b> 			
	930	775	1400 1700
<b>RRT-RRT</b> 			
	1240	775	1400 1700
	1400	775	1400 1700

# Design

## Panel design (examples)

### Ring-main feeder

Type R

Section

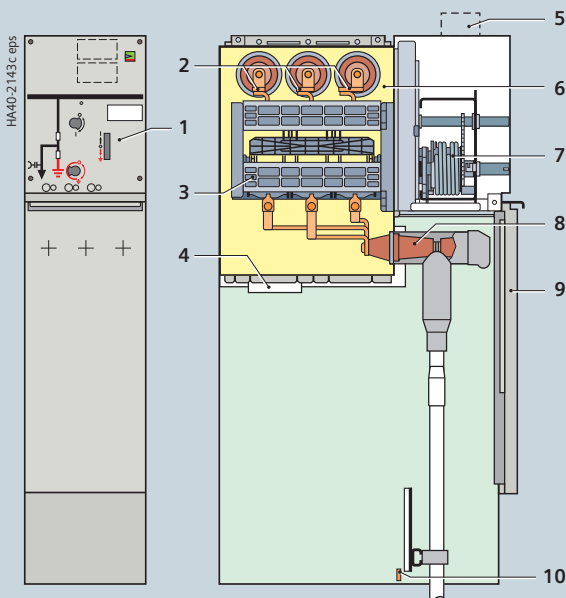

### Transformer feeder

Type T

Section

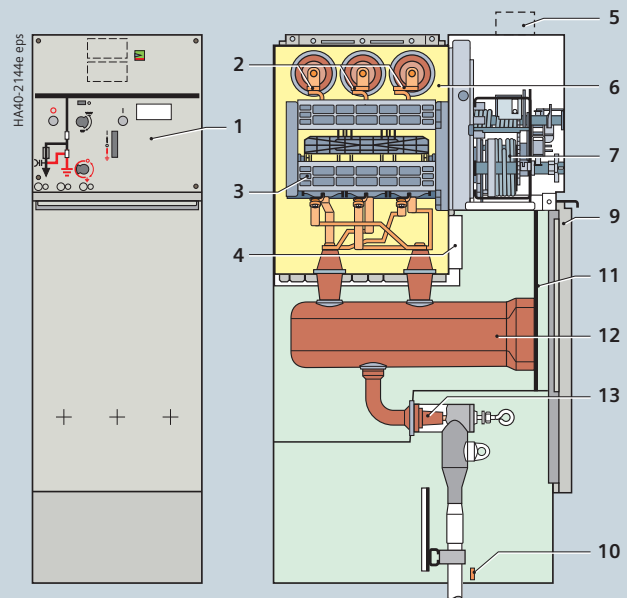

### Circuit-breaker feeder

Type L

Section

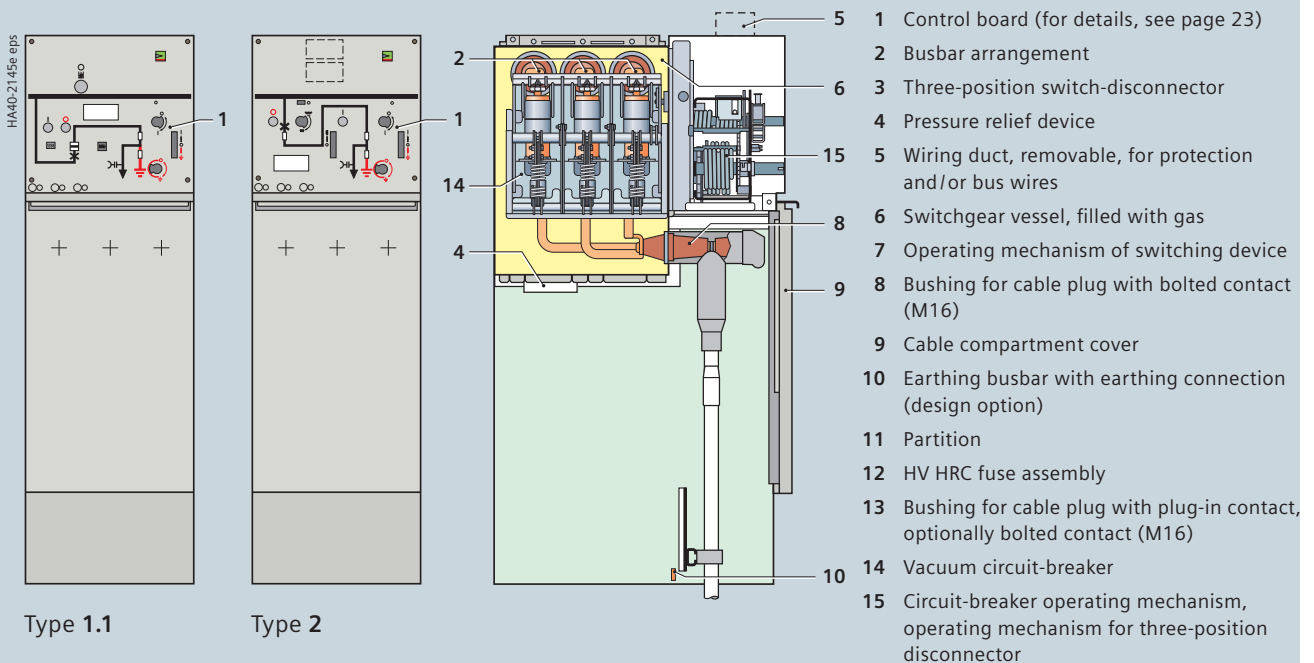

Type 1.1

Type 2

- 1 Control board (for details, see page 23)
- 2 Busbar arrangement
- 3 Three-position switch-disconnector
- 4 Pressure relief device
- 5 Wiring duct, removable, for protection and/or bus wires
- 6 Switchgear vessel, filled with gas
- 7 Operating mechanism of switching device
- 8 Bushing for cable plug with bolted contact (M16)
- 9 Cable compartment cover
- 10 Earthing busbar with earthing connection (design option)
- 11 Partition
- 12 HV HRC fuse assembly
- 13 Bushing for cable plug with plug-in contact, optionally bolted contact (M16)
- 14 Vacuum circuit-breaker
- 15 Circuit-breaker operating mechanism, operating mechanism for three-position disconnector



**Circuit-breaker feeder**  
Type L(500)

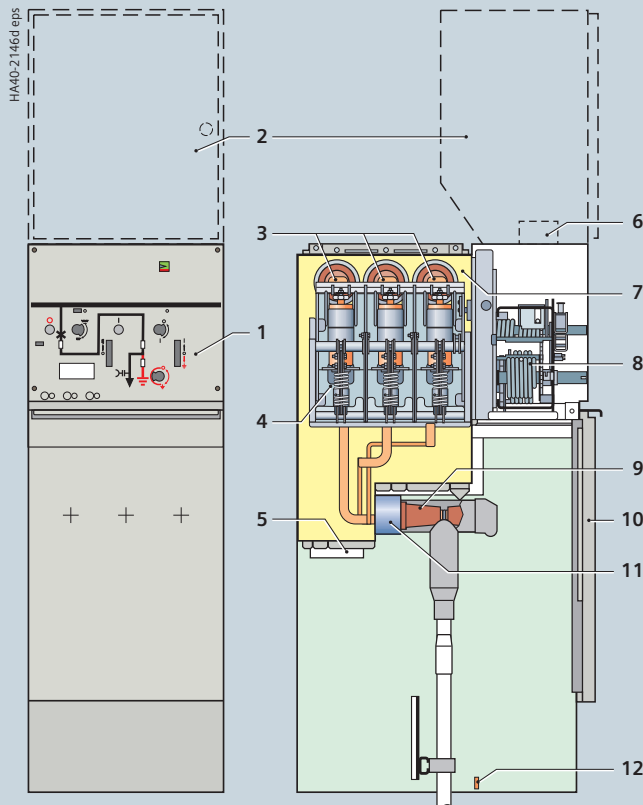

- 1 Control board (for details, see page 23)
- 2 Option: Low-voltage compartment
- 3 Busbar arrangement
- 4 Vacuum circuit-breaker
- 5 Pressure relief device
- 6 Wiring duct, removable, for protection and/or bus wires
- 7 Switchgear vessel, filled with gas
- 8 Operating mechanism of switching device
- 9 Bushing for cable plug with bolted contact (M16)
- 10 Cable compartment cover
- 11 Option: Three-phase current transformer (protection transformer)
- 12 Earthing busbar with earthing connection (design option)

**Type 2**

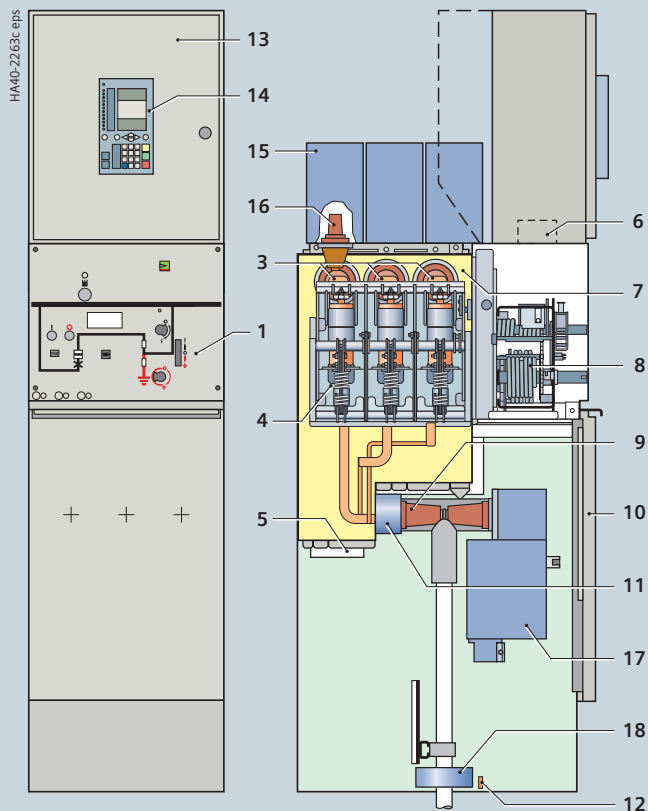

- 13 Low-voltage compartment (standard) for vacuum circuit-breaker
- 14 Option: SIPROTEC bay controller
- 15 Option: Plug-in voltage transformer type 4MT3 on the busbar
- 16 Bushing for connection of plug-in voltage transformers
- 17 Option: Plug-in voltage transformer 4MT8 at the connection
- 18 Cable-type current transformer

**Type 1.1**

# Design

## Panel design (examples)

### Billing metering panel Type M, air-insulated

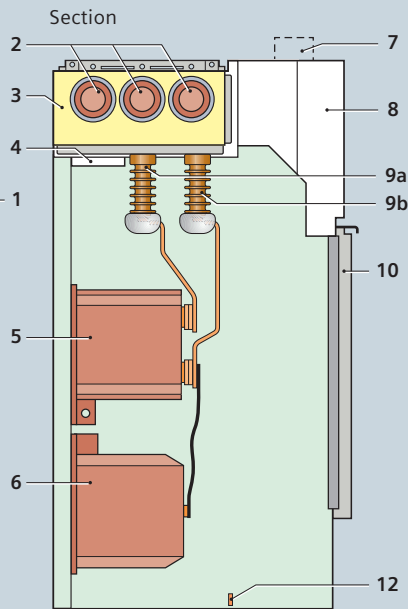
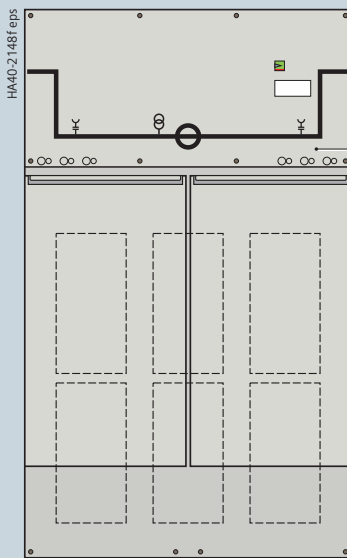

Connection: busbar – busbar

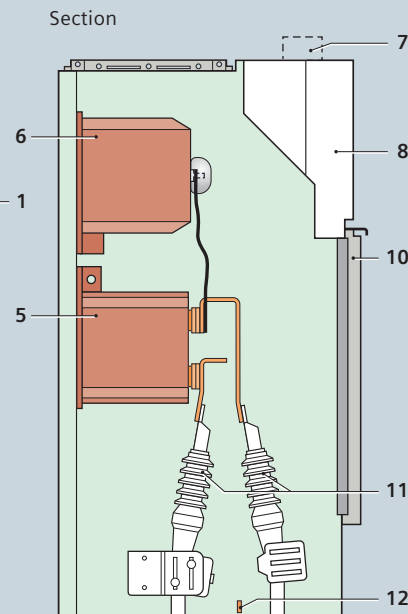
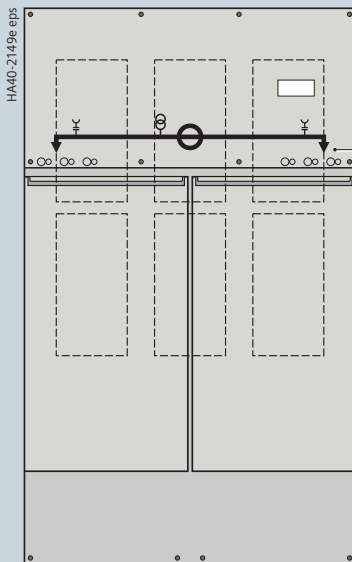

Connection: cable – cable

- 1 Sockets for voltage detecting system
- 2 Busbar connection
- 3 Busbar vessel, filled with gas
- 4 Pressure relief device
- 5 Current transformer type 4MA7
- 6 Voltage transformer type 4MR
- 7 Wiring duct, removable, for protection and/or bus wires
- 8 Niche for customer-side low-voltage equipment, screwed cover
- 9 Bushings for connection of transformer bars, connected with busbar extension on the right **9a** and on the left **9b**
- 10 Transformer compartment cover
- 11 Cable connection
- 12 Earthing busbar with earthing connection

**Panel block**  
Type 8DJH Compact RRT

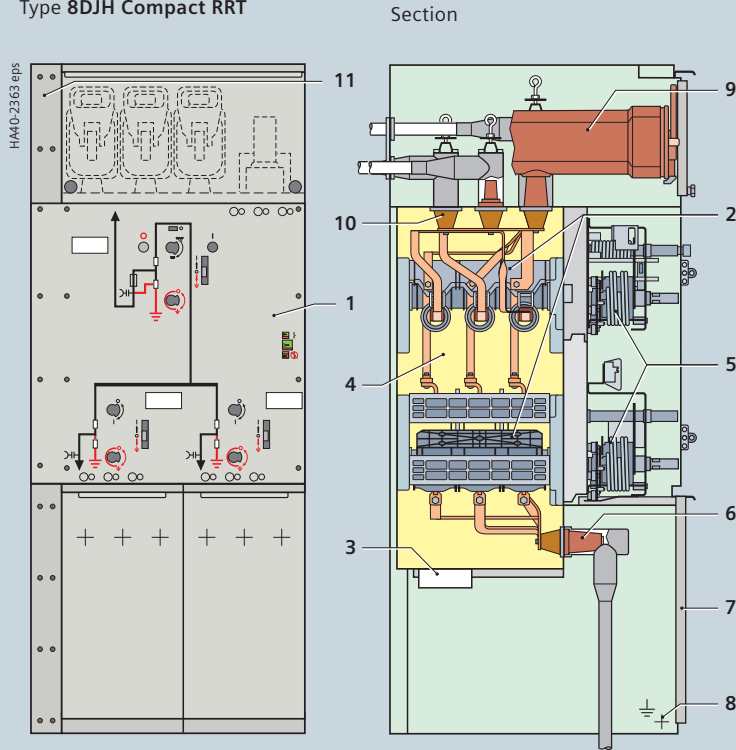

- 1 Control board (for details, see page 23)
- 2 Three-position switch-disconnector
- 3 Pressure relief device
- 4 Switchgear vessel, filled with gas
- 5 Operating mechanism of switching device
- 6 Bushing for cable plug with bolted contact (M16)
- 7 Cable compartment cover
- 8 Earthing connection
- 9 HV HRC fuse assembly
- 10 Bushing for cable plug with plug-in contact
- 11 Pressure relief duct downwards for transformer feeder (option)

# Design

## Outdoor enclosure

On request, 8DJH switchgear can be provided with an outdoor enclosure with the following features:

- For outdoor applications on company grounds
- Enclosure attached to standard indoor panels
- Enclosure with three different heights, for 1200 mm switchgear height (optionally with low-voltage compartment as a 200 mm, 400 mm or 600 mm high version), or 1400 mm switchgear height (optionally with low-voltage compartment as a 200 mm or 400 mm high version)
- Enclosure with four different widths for freely configurable, non-extendable switchgear rows up to a switchgear width of 2000 mm (for dimensions, see page 82)
- Internal arc classification IAC A FL or FLR to 21 kA/1 s according to IEC 62271-200
- Degree of protection IP 54.



R-HA40-8DJH-179.tif

Outdoor enclosure (front closed)



R-HA40-8DJH-178.tif

Outdoor enclosure (front open)

The control boards are function-related. They integrate operation, mimic diagram and position indication. Furthermore, indicating, measuring and monitoring equipment as well as locking devices and local-remote switches are arranged according to the panel type and version. The ready-for-service indicator and rating plates are fitted in accordance with the panel blocks.

Operation is identical for transformer and circuit-breaker feeders. First, the operating mechanism must be charged; then, closing/opening is done through separate pushbuttons. The condition of the energy store is indicated.

All actuating openings are functionally interlocked against each other, and are optionally lockable. Separate operating levers for the disconnecting and earthing function are optionally available.

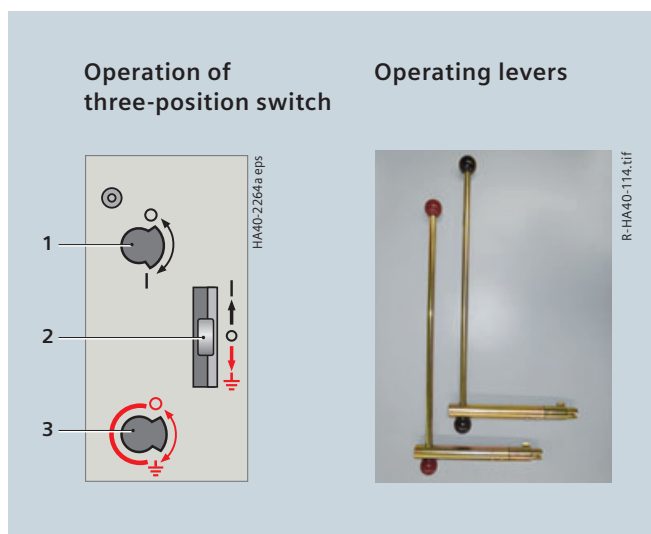

- 1 Manual operation of load-break function
- 2 Locking function (option for ring-main feeders)
- 3 Manual operation of earthing function
- 4 Panel designation label
- 5 Position indicator for switch-disconnector
- 6 Position indicator for earthing switch
- 7 Sockets of capacitive voltage detecting system
- 8 "Fuse tripped" indicator
- 9 ON pushbutton for transformer or circuit-breaker function
- 10 OFF pushbutton for transformer or circuit-breaker function
- 11 Manual spring charging
- 12 "Spring charged" indicator
- 13 Position indicator for circuit-breaker

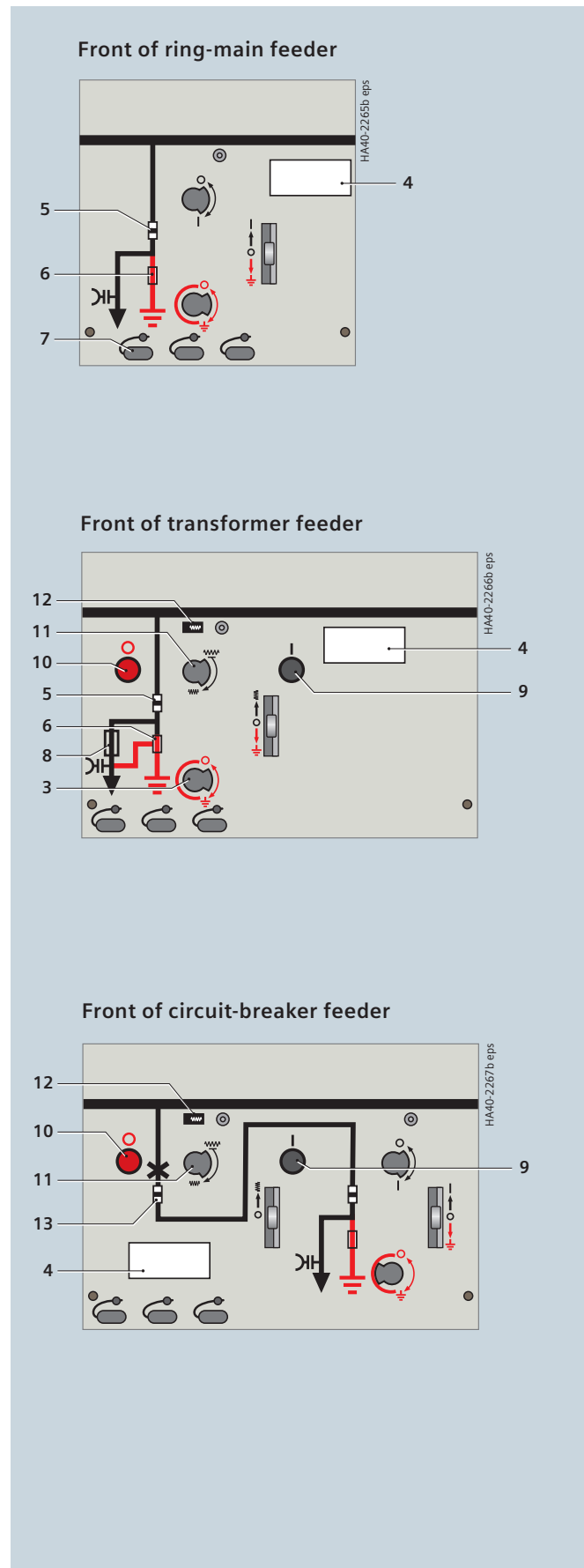



# Components

## Three-position switch-disconnector

### Features

- Switch positions:  
CLOSED – OPEN – EARTHED
- Switching functions as general-purpose switch-disconnector (class E3) according to
  - IEC/EN 62271-103/VDE 0671-103
  - IEC/EN 62271-102/VDE 0671-102
- Designed as a three-position switch with the functions
  - Switch-disconnector and
  - Make-proof earthing switch
- Operation via rotary bushing welded gas-tight into the front of the switchgear vessel
- Climate-independent contact in the gas-filled switchgear vessel
- Maintenance-free for indoor installation according to IEC/EN 62271-1/VDE 0671-1
- Individual secondary equipment.

### Mode of operation

The operating shaft forms one unit together with the three contact blades. Due to the arrangement of the fixed contacts (earth – busbar), it is not necessary to interlock the CLOSE and EARTHING functions.

### Closing operation

During the closing operation, the operating shaft with the moving contact blades changes from the “OPEN” to the “CLOSED” position.

The force of the spring-operated mechanism ensures a high operator-independent closing speed and a reliable connection of the main circuit.

### Opening operation

During the opening operation, the arc is caused to rotate by the arc-suppression system. This rotation movement prevents the development of a fixed root.

The isolating distance in gas established after breaking fulfills the conditions applicable to isolating distances in accordance with

- IEC/EN 62271-102 / VDE 0671-102
- and

- IEC/EN 62271-1 / VDE 0671-1.

Due to the arc rotation caused by the arc-suppression system, both load currents and minor no-load currents are safely interrupted.

### Earthing operation

The EARTHING operation is implemented by changing from the “OPEN” to the “EARTHED” position.

### Three-position switch-disconnector

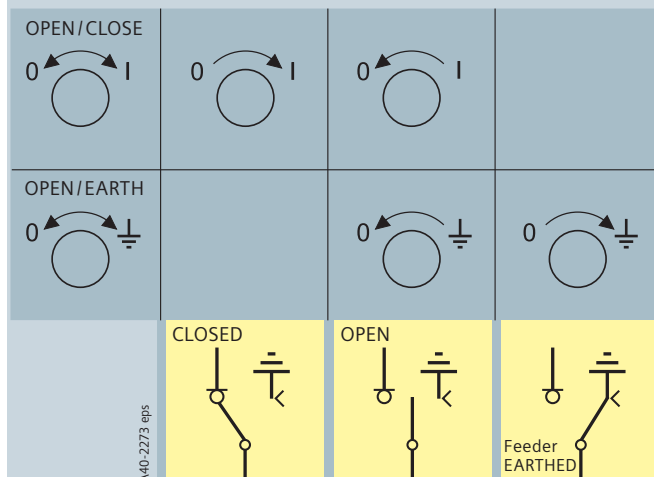
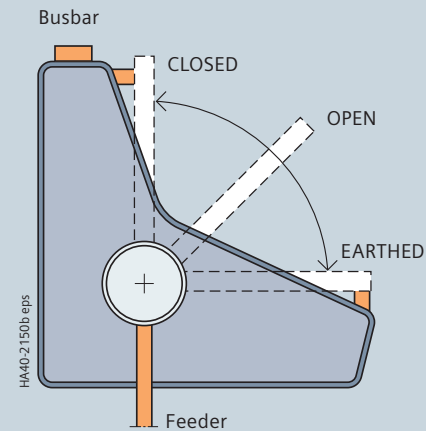

A40-2273 eps

Feeder EARTHED

### Features

- Mechanical endurance of more than 1000 operating cycles
- Parts subjected to mechanical stress are highly corrosion-proof
- Manual operation with the help of a slip-on operating lever
- Option: Motor operation
- Control board with accordingly cut-out switching gate prevents the three-position switch-disconnector from being switched directly from the "CLOSED" via the "OPEN" to the "EARTHED" position
- Two separate actuating openings are provided for unambiguous selection of the DISCONNECTING and EARTHING functions
- Operation via rotary movement, operating direction according to IEC/EN 60447/VDE 0196 (FNN recommendation, former VDN/VDEW recommendation).

### Spring-operated mechanism

The switching movements are performed independently of the operating speed.

### Spring-operated/stored-energy mechanism

The switching movements are performed independently of the operating speed.

During the charging process, the closing and opening springs are charged. This ensures that the switch-disconnector/fuse combination can switch off all types of faults reliably even during closing.

Closing and opening is done via pushbuttons, and is therefore identical with the operation of circuit-breaker operating mechanisms.

An energy store is available for tripping by means of an operating HV HRC fuse or via a shunt release (f-release). After tripping, a red bar appears on the position indicator.

### Assignment of operating mechanism type of three-position switch to panel types

Panel type	R, S, L, V, M(500)		T, H, M(430)	
Function	Switch-disconnector (R, S) Disconnecter (L, V, M(500))	Earthing switch	Switch-disconnector (T, H) Disconnecter M(430)	Earthing switch
Type of operating mechanism	Spring-operated	Spring-operated	Stored-energy	Spring-operated
Operation	Manual Motor (option)	Manual	Manual Motor (option)	Manual

#### Legend:

- R = Ring-main feeder
- S = Bus sectionalizer panel with switch-disconnector
- L = Circuit-breaker feeder
- T = Transformer feeder
- H = Bus sectionalizer panel with switch-fuse combination
- V = Bus sectionalizer panel with circuit-breaker
- M(430)/M(500) = Busbar voltage metering panel

# Components

Operating mechanisms for the three-position switch, equipment (optional)

## Motor operating mechanism (option)

The manual operating mechanisms of 8DJH switchgear can be equipped with motor operating mechanisms for the three-position switch-disconnector. Retrofitting is possible.

Operating voltages for motor operating mechanisms:

- 24, 48, 60, 110, 220 V DC
- 110 and 230 V AC, 50/60 Hz
- Motor rating: max. 80 W/80 VA.

Operation:

- Local operation by momentary-contact rotary control switch (option)
- Remote operation (standard) applied to terminal.

## Shunt release (option) (f-release)

Stored-energy mechanisms can be equipped with a shunt release. Remote electrical tripping of the three-position switch-disconnector is possible via the magnet coil of the shunt release, e.g. transformer overtemperature tripping. To avoid thermal overloading of the shunt release in the event of a continuous signal that may be applied, the shunt release is switched off via an auxiliary switch which is mechanically coupled with the three-position switch-disconnector.

## Auxiliary switch (option)

Each operating mechanism of the three-position switch-disconnector can be optionally equipped with an auxiliary switch for the position indication. Free contacts (for manual operating mechanism):

- Switch-disconnector function:  
CLOSED and OPEN: 1 NO + 1 NC + 2 changeover contacts
- Earthing switch function:  
CLOSED and OPEN: 1 NO + 1 NC + 2 changeover contacts.

## Technical data of the auxiliary switch

### Breaking capacity

AC operation at 40 Hz up to 60 Hz		DC operation		
Operating voltage	Normal current	Operating voltage	Normal current	
V	A	V	Resistive A	Inductive, T = 20 ms A
up to 230	10	24	10	10
		48	10	9
		60	9	7
		110	5	4
		240	2.5	2

### Rated switching capacity

Rated insulation voltage	250 V AC/DC
Insulation group	C acc. to VDE 0110
Continuous current	10 A
Making capacity	50 A

### Abbreviations:

NO = Normally open contact

NC = Normally closed contact

## Features

- The vacuum circuit-breaker consists of a vacuum interrupter unit with integrated three-position disconnector located in the switchgear vessel, and the associated operating mechanisms.
- According to IEC/EN 62271-100/VDE 0671-100
- Application in hermetically welded switchgear vessel in conformity with the system
- Climate-independent vacuum interrupter poles in the gas-filled switchgear vessel
- Operating mechanism located outside the switchgear vessel in the front operating mechanism box
- Maintenance-free for indoor installation according to IEC/EN 62271-1/VDE 0671-1
- Individual secondary equipment.

## Operating mechanism functions

The closing spring is charged by means of the operating lever or the hand crank supplied, or by the motor (option), until the latching of the closing spring is indicated ("spring charged" indicator). Then, the vacuum circuit-breaker can be closed manually or electrically.

In operating mechanisms provided for automatic reclosing (AR), the closing spring can be recharged by hand or automatically in case of motor operating mechanism. Thus, the "closing option" is available again.

## Operating mechanism

The operating mechanism assigned to a circuit-breaker feeder consists of the following components:

- Operating mechanism for circuit-breaker
- Operating mechanism for three-position disconnector
- Motor operating mechanism (optional)
- Position indicators
- Pushbuttons for CLOSING and OPENING the circuit-breaker
- Interlocking between circuit-breaker and disconnector.

## Assignment of operating mechanism type

Panel type	L, V		
Function	Circuit-breaker	Three-position disconnector	
		Disconnecter	Earthing switch
Type	Stored-energy	Spring-operated	Spring-operated
Operation	Manual/Motor	Manual/Motor	Manual

## Trip-free mechanism

The vacuum circuit-breaker is fitted with a trip-free mechanism according to IEC/EN 62271-100/VDE 0671-100. In the event of an opening command being given after a closing operation has been initiated, the moving contacts return to the open position and remain there even if the closing command is sustained. This means that the contacts are momentarily in the closed position, which is permissible according to the above-mentioned standard.

## Circuit-breaker

Circuit-breaker	Type 1.1	Type 2
Short-circuit breaking current	up to 17.5 kV/25 kA or 24 kV/21 kA	up to 17.5 kV/25 kA or 24 kV/21 kA
Rated operating sequence O – 0.3 s – CO – 3 min – CO O – 0.3 s – CO – 15 s – CO O – 3 min – CO – 3 min – CO	• on request –	– – •
Number of breaking operations $I_r$	10,000	2000
Short-circuit breaking operations $I_{SC}$	up to 50	up to 20
In individual panel	430 mm 500 mm	• •
In panel block	430 mm	•

### Explanations:

- Design option
- Not available

# Components

## Vacuum circuit-breaker

### Electrical service life

#### Vacuum circuit-breaker type 1.1

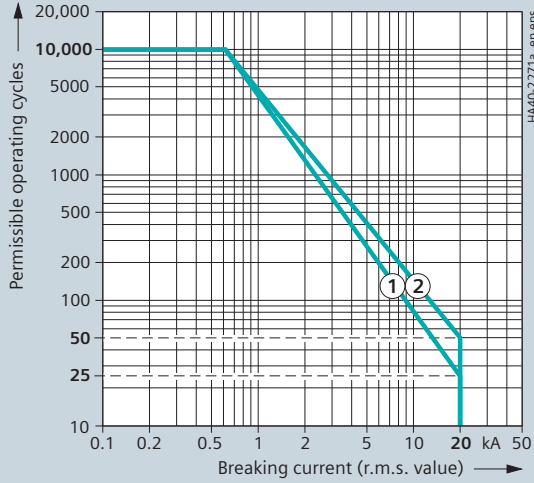

Rated short-circuit breaking current 20 kA

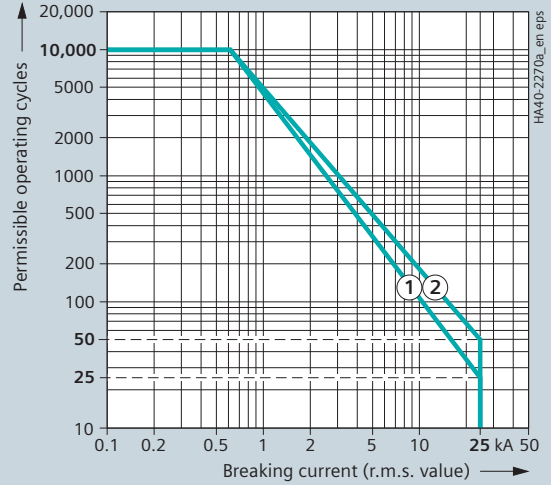

Rated short-circuit breaking current 25 kA

#### Vacuum circuit-breaker type 2

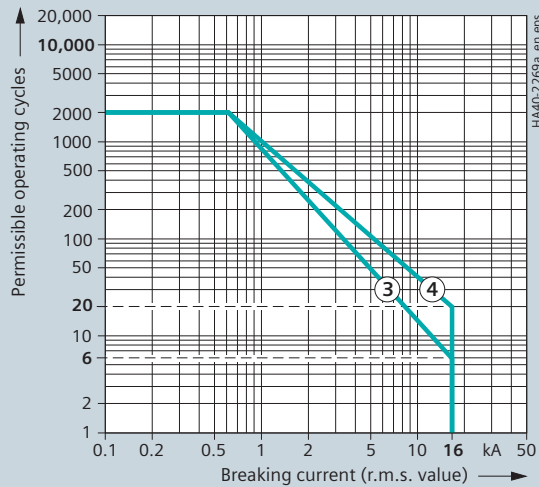

Rated short-circuit breaking current 16 kA

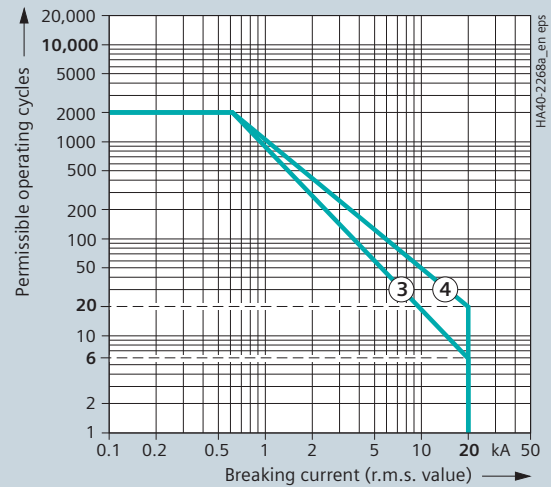

Rated short-circuit breaking current 20 kA

#### Max. number of short-circuit breaking operations

- |          |          |
|----------|----------|
| ① n = 25 | ③ n = 6  |
| ② n = 50 | ④ n = 20 |



### Motor operating mechanism

Operating voltages for motor operating mechanisms

- 24, 48, 60, 110, 220 V DC
- 110 and 230 V AC, 50/60 Hz.

Further values on request.

Motor rating for circuit-breaker operating mechanism type 1.1 at

DC: maximum 100 W

AC: maximum 250 VA.

Motor rating for disconnecter operating mechanism and circuit-breaker operating mechanism type 2 at

DC: maximum 80 W

AC: maximum 80 VA.

### Secondary components

The scope of the secondary equipment of the vacuum circuit-breaker depends on the type of application and offers a wide range of possible variations, allowing almost every requirement to be satisfied.

### Closing solenoid

- For electrical closing.

### Shunt release

- Magnet coil for tripping by protection device or electrical actuation.

### C.t.-operated release

- For tripping pulse 0.1 Ws in conjunction with suitable protection systems, e.g. protection system 7SJ45 or make Woodward/SEG type WIC; other designs on request
- Used if external auxiliary voltage is missing, tripping via protection relay.

### Low-energy magnetic release

- For tripping pulse 0.02 Ws, tripping via transformer monitor (IKI-30).

### Undervoltage release

- Comprising:
  - Energy store and unlatching mechanism
  - Electromagnetic system, which is permanently connected to voltage while the vacuum circuit-breaker is closed; tripping is initiated when this voltage drops.

### Anti-pumping

(mechanical and electrical)

- Function: If constant CLOSE and OPEN commands are present at the vacuum circuit-breaker at the same time, the vacuum circuit-breaker will return to the open position after closing. It remains in this position until a new CLOSE command is given. In this manner, continuous closing and opening (= pumping) is avoided.

1) Depending on the secondary components selected

### Circuit-breaker tripping signal

- For electrical signaling (as pulse > 10 ms), e.g. to remote control systems, in the case of automatic tripping (e.g. protection)
- Via limit switch and cutout switch.

### Varistor module

- To limit overvoltages to approx. 500 V for protection devices (when inductive components are mounted in the vacuum circuit-breaker)
- For auxiliary voltages  $\geq 60$  V DC.

### Auxiliary switch

- For electrical position indication.

### Position switch

- For signaling "closing spring charged".

### Mechanical interlocking

- Dependent on the type of operating mechanism
- Interrogation of the three-position disconnecter from the switchgear side
- Option: Operating mechanism with mechanical interlocking as
  - Stored-energy mechanism with closing solenoid and pushbutton: The pushbutton operated by the mechanical interlocking prevents a continuous command to the closing solenoid
- During operation of the three-position disconnecter from CLOSED to OPEN, the vacuum circuit-breaker cannot be closed.

### Operations counter

- As numeric indicator, 5 digits, mechanical.

### Circuit-breaker equipment

Circuit-breaker	Type 1.1	Type 2
Motor operating mechanism	○	○
Closing solenoid	●	○
Shunt release	○	○
C.t.-operated release	○	○
Low-energy magnetic release	–	○
Undervoltage release	○	○
Anti-pumping	●	o.r.
Circuit-breaker tripping signal	●	○
Varistor module	for $\geq 60$ V DC	for $\geq 60$ V DC
Auxiliary switch		
6 NO + NC	●	●
free contacts thereof <sup>1)</sup>	1 NO + 2 NC + 2 changeover	2 NO + 3 NC + 2 changeover
11 NO + 11 NC	○	–
free contacts thereof <sup>1)</sup>	6 NO + 7 NC + 2 changeover	–
Position switch	●	●
Mechanical interlocking	●	●
Operations counter	●	○

● = standard  
○ = option  
o.r. = on request

Abbreviations:

NO = Normally open contact  
NC = Normally closed contact

# Components

Busbar extension, modularity

## Features

- Busbar extension possible on all individual panels and panel blocks (ordering option)
- Plug-in unit consisting of contact coupling and screened silicone coupling
- Insensitive to pollution and condensation
- Switchgear installation, extension or panel replacement is possible without gas work
- Busbar connections to metering panels are possible.

Every panel block and every individual panel is optionally available with busbar extension on the right, on the left or on both sides. This offers a high flexibility for the creation of switchgear configurations whose functional units can be lined up in any order. Local installation and lining up is done without gas work.

Lining up takes place as follows:

- By the busbar couplings on the medium-voltage side. Tolerances between adjacent panels are compensated by spherical fixed contacts and the movable contact coupling with degrees of freedom in all axis directions.
- By safe dielectric sealing with screened silicone couplings that are externally earthed and adjustable to tolerances. These silicone couplings are pressed on with a defined pressure when the panels are interconnected.
- On free busbar ends, screened dummy plugs are inserted, each of which is pressed on through a metal cover. A common protective cover with a warning is fixed over all three covers.
- By centering bolts for easier switchgear installation and fixing of adjacent panels.
- By bolted panel joints with defined stops for the distances between adjacent panels and the associated pressure for contact pieces and silicone couplings.

Switchgear installation, extension or replacement of one or more functional units requires a lateral wall distance  $\geq 200$  mm.

## Interconnecting the panels

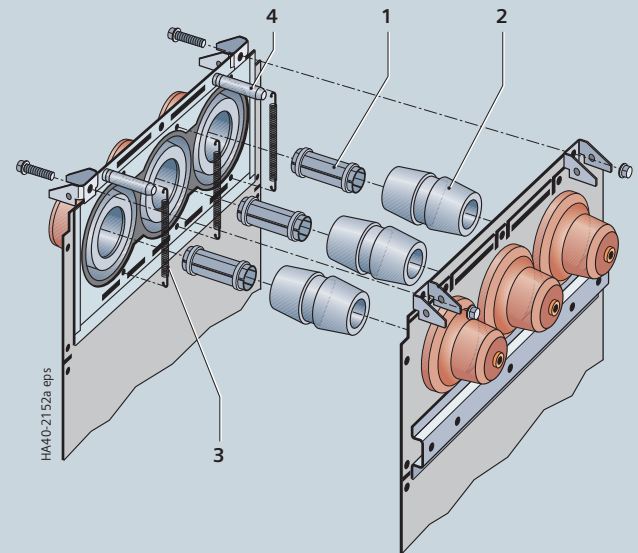

## Surge-proof termination

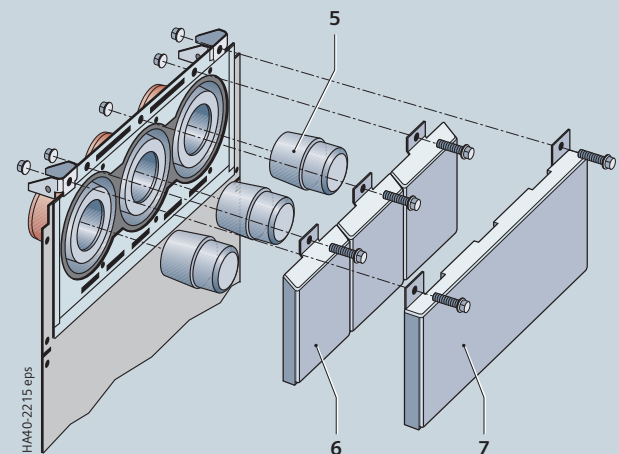

- 1 Contact piece
- 2 Silicone coupling
- 3 Tension spring for earthing
- 4 Centering bolt
- 5 Silicone dummy plug with insertable sleeve
- 6 Clamping cover for dummy plugs
- 7 Busbar termination cover

## Features

- Application in switch-disconnector/fuse combination in
    - Transformer feeders (T)
    - Bus sectionalizer with switch-fuse combination (H)
  - HV HRC fuse-links according to DIN 43625 (main dimensions) with striker; “medium” version according to IEC/EN 60282-1/VDE 0670-4
  - As short-circuit protection for transformers
  - With selectivity – depending on correct selection – to upstream and downstream connected equipment
  - 1-pole insulated
  - Requirements according to IEC/EN 62271-105/VDE 0671-105 fulfilled in high-voltage switch-fuse combinations
  - Climate-independent and maintenance-free
  - Fuse assembly connected to the three-position switch-disconnector via welded-in bushings and connecting bars
  - Arrangement of fuse assembly below the switchgear vessel
  - Fuses can only be replaced if feeder is earthed
  - Fuse slide for reference dimension 292 mm and 442 mm
- Option with three-position switch-disconnector
- Shunt release (f-release)
  - “Tripped signal” of the transformer switch for remote electrical indication with 1 normally open contact.

## Mode of operation

In the event that an HV HRC fuse-link has tripped, the switch-disconnector is tripped via an articulation which is integrated into the cover of the fuse box (see figure).

In the event that the fuse tripping fails, e.g. if the fuse has been inserted incorrectly, the fuse box is protected by thermal protection. The overpressure generated by overheating trips the switch via the diaphragm in the cover of the fuse box and via an articulation. This prevents the fuse box from incurring irreparable damage.

This thermal protection works independently of the type and design of the HV HRC fuse used. Like the fuse itself, it is maintenance-free and independent of any outside climatic effects.

Furthermore, the HV HRC fuses (e.g. make SIBA) release the striker depending on the temperature and trip the switch-disconnector as early as in the fuse overload range. Impermissible heating of the fuse box can be avoided in this way.

## Replacement of HV HRC fuse-links (without tools)

- Isolate and earth the transformer feeder
- Open the cover of the fuse access
- Replace the HV HRC fuse-link.

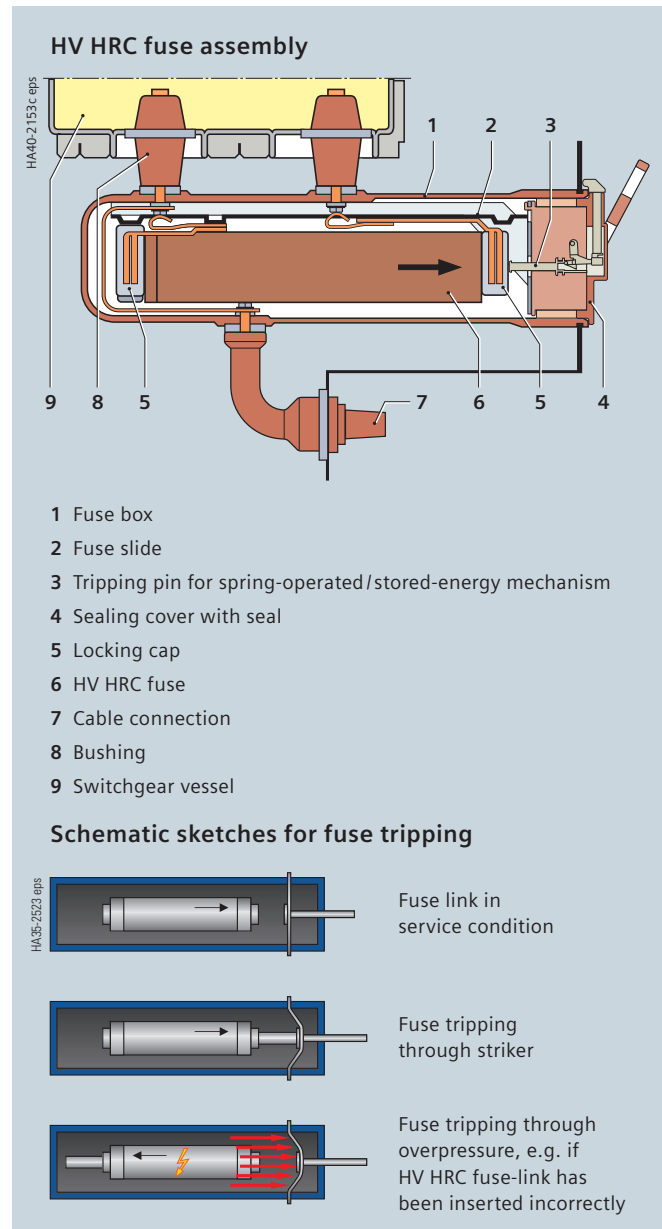

## Note to HV HRC fuse-links

According to IEC 60282-1 (2009) Clause 6.6, the breaking capacity of HV HRC fuses is tested within the scope of the type test at 87 % of their rated voltage. In three-phase systems with resonance-earthed or isolated neutral, under double earth fault and other conditions, the full phase-to-phase voltage may be available at the HV HRC fuse during breaking. Depending on the size of the operating voltage of such a system, this applied voltage may then exceed 87 % of the rated voltage. It must therefore already be ensured during configuration of the switching devices and selection of the HV HRC fuse that only such fuse-links are used, which either satisfy the above operating conditions, or whose breaking capacity was tested at least with the maximum system voltage. In case of doubt, a suitable HV HRC fuse must be selected together with the fuse manufacturer.

# Components

## Allocation of HV HRC fuses and transformer ratings

### Fuse protection table

The following table shows the recommended HV HRC fuse-links make SIBA and Mersen (electrical data valid for ambient air temperatures of up to 40 °C) for fuse protection of transformers.

The three-position switch-disconnector in panel types T and H was combined with HV HRC fuse-links and tested according to IEC 62271-105.

### Standards

HV HRC fuse-links “medium” version with striker and for tripping energy  $1 \pm 0.5$  Joule according to

- IEC/EN 60282-1/VDE 0670-4
- IEC/TR 626552/VDE 0670-402
- DIN 43625 main dimensions.

MV system	Transformer			HV HRC fuse-link				
	Rated power $S_r$ kVA	Relative impedance voltage $u_k$ %	Rated current $I_r$ A	Rated current $I_r$ A	Min. operating/ rated voltage $U_r$ kV	Dimension e mm	Order No. Make SIBA	Order No. Make Mersen
3.3 to 3.6	20	4	3.5	6.3	3 to 7.2	292	30 098 13.6,3	–
				10	3 to 7.2	292	30 098 13.10	–
	30	4	5.25	10	3 to 7.2	292	30 098 13.10	–
				16	3 to 7.2	292	30 098 13.16	–
	50	4	8.75	16	3 to 7.2	292	30 098 13.16	–
				20	3 to 7.2	292	30 098 13.20	–
	75	4	13.1	20	3 to 7.2	292	30 098 13.20	–
				25	3 to 7.2	292	30 098 13.25	–
	100	4	17.5	31.5	3 to 7.2	292	30 098 13.31,5	–
40				3 to 7.2	292	30 098 13.40	–	
125	4	21.87	31.5	3 to 7.2	292	30 098 13.31,5	–	
			40	3 to 7.2	292	30 098 13.40	–	
160	4	28	40	3 to 7.2	292	30 098 13.40	–	
			50	3 to 7.2	292	30 098 13.50	–	
200	4	35	50	3 to 7.2	292	30 098 13.50	–	
			63	3 to 7.2	292	30 099 13.63	–	
250	4	43.74	63	3 to 7.2	292	30 099 13.63	–	
			80	3 to 7.2	292	30 099 13.80	–	
4.16 to 4.8	20	4	2.78	6.3	3 to 7.2	292	30 098 13.6,3	–
				10	3 to 7.2	292	30 098 13.10	–
	30	4	4.16	10	3 to 7.2	292	30 098 13.10	–
				16	3 to 7.2	292	30 098 13.16	–
	50	4	6.93	16	3 to 7.2	292	30 098 13.16	–
				20	3 to 7.2	292	30 098 13.20	–
	75	4	10.4	20	3 to 7.2	292	30 098 13.20	–
				25	3 to 7.2	292	30 098 13.25	–
	100	4	13.87	20	3 to 7.2	292	30 098 13.20	–
25				3 to 7.2	292	30 098 13.25	–	
125	4	17.35	25	3 to 7.2	292	30 098 13.25	–	
			31.5	3 to 7.2	292	30 098 13.31,5	–	
160	4	22.2	31.5	3 to 7.2	292	30 098 13.31,5	–	
			40	3 to 7.2	292	30 098 13.40	–	
200	4	27.75	40	3 to 7.2	292	30 098 13.40	–	
			50	3 to 7.2	292	30 098 13.50	–	
250	4	34.7	50	3 to 7.2	292	30 098 13.50	–	
			63	3 to 7.2	292	30 099 13.63	–	
315	4	43.7	63	3 to 7.2	292	30 099 13.63	–	
			80	3 to 7.2	292	30 099 13.80	–	
5.0 to 5.5	20	4	2.3	6.3	3 to 7.2	292	30 098 13.6,3	–
				10	3 to 7.2	292	30 098 13.10	–
	30	4	3.4	6.3	3 to 7.2	292	30 098 13.6,3	–
				10	3 to 7.2	292	30 098 13.10	–
	50	4	5.7	10	3 to 7.2	292	30 098 13.10	–
				16	3 to 7.2	292	30 098 13.16	–
	75	4	8.6	16	3 to 7.2	292	30 098 13.16	–
				20	3 to 7.2	292	30 098 13.20	–
	100	4	11.5	16	3 to 7.2	292	30 098 13.16	–
				20	3 to 7.2	292	30 098 13.20	–
	125	4	14.4	20	3 to 7.2	292	30 098 13.20	–
				25	3 to 7.2	292	30 098 13.25	–
	160	4	18.4	31.5	3 to 7.2	292	30 098 13.31,5	–
40				3 to 7.2	292	30 098 13.40	–	
200	4	23	40	3 to 7.2	292	30 098 13.40	–	
			50	3 to 7.2	292	30 098 13.50	–	
250	4	28.8	40	3 to 7.2	292	30 098 13.40	–	
			50	3 to 7.2	292	30 098 13.50	–	
315	4	36.3	50	3 to 7.2	292	30 098 13.50	–	
			63	3 to 7.2	292	30 099 13.63	–	
400	4	46.1	63	3 to 7.2	292	30 099 13.63	–	
			80	3 to 7.2	292	30 099 13.80	–	

MV system	Transformer			HV HRC fuse-link						
	Rated power $S_r$	Relative impedance voltage $u_k$	Rated current $I_r$	Rated current $I_r$	Min. operating/ rated voltage $U_r$	Dimension e	Order No. Make SIBA	Order No. Make Mersen		
kV	kVA	%	A	A	kV	mm				
6 to 7.2	20	4	1.9	6.3	6 to 12	292	30 004 13.6,3	–		
				6.3	3 to 7.2	292	30 098 13.6,3	–		
				6.3	6 to 12	442	30 101 13.6,3	–		
	50	4	4.8	10	3 to 7.2	292	30 098 13.10	–		
				10	6 to 12	292	30 004 13.10	–		
				10	6 to 12	442	30 101 13.10	–		
				16	3 to 7.2	292	30 098 13.16	–		
				16	6 to 12	292	30 004 13.16	45DB120V16PTD		
				16	6 to 12	442	30 101 13.16	–		
	75	4	7.2	16	3 to 7.2	292	30 098 13.16	–		
				16	6 to 12	292	30 004 13.16	45DB120V16PTD		
				16	6 to 12	442	30 101 13.16	–		
	100	4	9.6	16	3 to 7.2	292	30 098 13.16	–		
				16	6 to 12	292	30 004 13.16	–		
				16	6 to 12	442	30 101 13.16	–		
				20	3 to 7.2	292	30 098 13.20	–		
				20	6 to 12	292	30 004 13.20	–		
				20	6 to 12	442	30 101 13.20	–		
				25	6 to 12	292	–	45DB120V25PTD		
	125	4	12	20	3 to 7.2	292	30 098 13.20	–		
				20	6 to 12	292	30 004 13.20	–		
				20	6 to 12	442	30 101 13.20	–		
				25	3 to 7.2	292	30 098 13.25	–		
				25	6 to 12	292	30 004 13.25	45DB120V25PTD		
				25	6 to 12	442	30 101 13.25	–		
	160	4	15.4	31.5	3 to 7.2	292	30 098 13.31,5	–		
				31.5	6 to 12	292	30 004 13.31,5	45DB120V32PTD		
				31.5	6 to 12	442	30 101 13.31,5	–		
	200	4	19.2	31.5	3 to 7.2	292	30 098 13.31,5	–		
				31.5	6 to 12	292	30 004 13.31,5	–		
				31.5	6 to 12	442	30 101 13.31,5	–		
				40	3 to 7.2	292	30 098 13.40	–		
				40	6 to 12	292	30 004 13.40	45DB120V40PTD		
250	4	24	40	6 to 12	292	30 098 13.40	–			
			40	6 to 12	292	30 004 13.40	–			
			40	6 to 12	442	30 101 13.40	–			
			50	3 to 7.2	292	30 098 13.50	–			
			50	6 to 12	292	30 004 13.50	–			
			50	6 to 12	442	30 101 13.50	–			
			63	6 to 12	292	30 012 43.63	45DB120V63PTS2			
315	4	30.3	50	3 to 7.2	292	30 098 13.50	–			
			50	6 to 12	292	30 004 13.50	45DB120V50PTD			
			50	6 to 12	442	30 101 13.50	–			
			63	6 to 12	292	30 012 43.63	45DB120V63PTS2			
			80	6 to 12	292	–	45DB120V80PTS2			
400	4	38.4	63	6 to 12	292	30 012 43.63	–			
			80	6 to 12	292	30 012 43.80	45DB120V80PTS2			
			80	6 to 12	442	30 102 43.80	–			
			63	3 to 7.2	292	30 099 13.63	–			
			63	6 to 12	292	30 012 13.63	–			
			63	6 to 12	442	30 102 13.63	–			
			100	6 to 12	292	–	45DB120V100PTS2			
			500	4	48	80	6 to 12	292	30 012 43.80	–
						80	6 to 12	442	30 102 43.80	–
						80	3 to 7.2	292	30 099 13.80	–
80	6 to 12	292				30 012 13.80	–			
80	6 to 12	442				30 102 13.80	–			
100	6 to 12	292				30 012 43.100	45DB120V100PTS2			
630	4	61	100	6 to 12	442	30 102 43.100	45DB120V100PTS3			
			125	6 to 12	292	30 020 43.125	45DB120V125PTS2			
			125	6 to 12	442	30 103 43.125	–			
800	4	77	160	6 to 12	442	–	45DB120V160PTS3			
10 to 12	20	4	1.15	4	6 to 12	292	30 004 13.4	–		
				50	4	2.9	10	6 to 12	292	30 004 13.10
	50	4	2.9	10	6 to 12	442	30 101 13.10	–		
				10	10 to 17.5	292	30 255 13.10	–		
				10	10 to 17.5	442	30 231 13.10	–		
				10	10 to 24	442	30 006 13.10	45DB240V10PTD		
				10	6 to 12	292	30 004 13.10	45DB120V10PTD		
				10	6 to 12	442	30 101 13.10	–		
	75	4	4.3	10	10 to 17.5	292	30 255 13.10	–		
				10	10 to 17.5	442	30 231 13.10	–		
				10	10 to 24	442	30 006 13.10	45DB240V10PTD		

# Components

## Allocation of HV HRC fuses and transformer ratings

MV system	Transformer			HV HRC fuse-link					
Operating voltage $U_n$	Rated power $S_r$	Relative impedance voltage $u_k$	Rated current $I_r$	Rated current $I_r$	Min. operating/rated voltage $U_r$	Dimension e	Order No. Make SIBA	Order No. Make Mersen	
kV	kVA	%	A	A	kV	mm			
10 to 12	100	4	5.8	16	6 to 12	292	30 004 13.16	–	
				16	6 to 12	442	30 101 13.16	–	
				16	10 to 17.5	292	30 255 13.16	–	
				16	10 to 17.5	442	30 231 13.16	–	
				16	10 to 24	442	30 006 13.16	45DB240V16PTD	
	125	4	7.2	7.2	16	6 to 12	292	30 004 13.16	45DB120V16PTD
					16	6 to 12	442	30 101 13.16	–
					16	10 to 17.5	292	30 255 13.16	–
					16	10 to 17.5	442	30 231 13.16	–
					16	10 to 24	442	30 006 13.16	45DB240V16PTD
	160	4	9.3	9.3	20	6 to 12	292	30 004 13.20	45DB120V20PTD
					20	6 to 12	442	30 101 13.20	–
					20	10 to 17.5	292	30 221 13.20	–
					20	10 to 17.5	442	30 231 13.20	–
					20	10 to 24	442	30 006 13.20	45DB240V20PTD
	200	4	11.5	11.5	25	6 to 12	292	30 004 13.25	45DB120V25PTD
					25	6 to 12	442	30 101 13.25	–
					25	10 to 17.5	292	30 221 13.25	–
					25	10 to 17.5	442	30 231 13.25	–
					25	10 to 24	442	30 006 13.25	45DB240V25PTD
	250	4	14.5	14.5	25	6 to 12	292	30 004 13.25	45DB120V25PTD
					25	6 to 12	442	30 101 13.25	–
					25	10 to 17.5	292	30 221 13.25	–
					25	10 to 17.5	442	30 231 13.25	–
					25	10 to 24	442	30 006 13.25	45DB240V25PTD
					31.5	6 to 12	292	30 004 13.31,5	–
					31.5	6 to 12	442	30 101 13.31,5	–
					31.5	10 to 17.5	292	30 221 13.31,5	–
					31.5	10 to 17.5	442	30 231 13.31,5	–
					31.5	10 to 24	442	30 006 13.31,5	45DB240V32PTD
	315	4	18.3	18.3	31.5	6 to 12	292	30 004 13.31,5	45DB120V32PTD
					31.5	6 to 12	442	30 101 13.31,5	–
					31.5	10 to 17.5	292	30 221 13.31,5	–
					31.5	10 to 17.5	442	30 231 13.31,5	–
					31.5	10 to 24	442	30 006 13.31,5	45DB240V32PTD
					40	6 to 12	292	30 004 13.40	–
					40	6 to 12	442	30 101 13.40	–
					40	10 to 17.5	292	30 221 13.40	–
					40	10 to 17.5	442	30 231 13.40	–
					40	10 to 24	442	30 006 13.40	45DB240V40PTD
	400	4	23.1	23.1	40	6 to 12	292	30 004 13.40	45DB120V40PTD
					40	6 to 12	442	30 101 13.40	–
					40	10 to 17.5	292	30 221 13.40	–
					40	10 to 17.5	442	30 231 13.40	–
					40	10 to 24	442	30 006 13.40	45DB240V40PTD
					50	6 to 12	292	30 004 13.50	–
					50	6 to 12	442	30 101 13.50	–
					50	10 to 17.5	292	30 221 13.50	–
50					10 to 17.5	442	30 232 13.50	–	
50					10 to 24	442	30 014 13.50	45DB240V50PTS	
500	4	29	29	50	6 to 12	292	30 004 13.50	45DB120V50PTD	
				50	6 to 12	442	30 101 13.50	–	
				50	10 to 17.5	292	30 221 13.50	–	
				50	10 to 17.5	442	30 232 13.50	–	
				50	10 to 24	442	30 014 13.50	45DB240V50PTD	
630	4	36.4	36.4	63	6 to 12	292	30 012 43.63	45DB120V63PTS2	
				63	6 to 12	442	30 014 43.63	45DB240V63PTD	
				63	10 to 24	292	30 012 43.63	–	
				63	6 to 12	442	30 012 13.63	45DB120V63PTD	
				63	10 to 17.5	442	30 102 13.63	–	
800	5 to 6	46.2	46.2	80	6 to 12	292	30 012 43.80	45DB120V80PTS2	
				80	6 to 12	442	30 012 13.63	–	
				80	10 to 17.5	442	30 232 13.63	–	
				80	6 to 12	292	30 012 43.80	45DB120V80PTS2	
				80	6 to 12	442	30 102 43.80	–	
1000	5 to 6	58	58	100	6 to 12	292	–	45DB120V100PTS2	
				100	6 to 12	442	30 102 43.100	45DB120V100PTS3	
				100	10 to 24	442	–	45DB240V100PTS	
				100	10 to 24	442	–	45DB240V100PTS	
1250	5 to 6	72.2	72.2	125	6 to 12	292	–	45DB120V125PTS2	
				125	6 to 12	442	30 103 43.125	45DB120V125PTS3	
				125	10 to 24	442	–	45DB240V125PTS	



MV system	Transformer			HV HRC fuse-link				
	Operating voltage $U_n$ kV	Rated power $S_r$ kVA	Relative impedance voltage $u_k$ %	Rated current $I_r$ A	Rated current $I_r$ A	Min. operating/ rated voltage $U_r$ kV	Dimension e mm	Order No. Make SIBA
13.8	20	4	0.8	3.15	10 to 24	442	30 006 13.3,15	–
	50	4	2.1	6.3	10 to 17.5	442	30 231 13.6,3	–
				6.3 10	10 to 24 10 to 24	442 442	30 006 13.6,3 –	45DB240V10PTD
	75	4	3.2	6.3	10 to 17.5	442	30 231 13.6,3	–
				10 10	10 to 17.5 10 to 24	442 442	30 231 13.10 30 006 13.10	45DB240V10PTD
	100	4	4.2	10	10 to 17.5	442	30 231 13.10	–
				16 16	10 to 17.5 10 to 24	442 442	30 231 13.16 30 006 13.16	45DB240V16PTD
	125	4	5.3	10	10 to 17.5	442	30 231 13.10	–
				16 16	10 to 17.5 10 to 24	442 442	30 231 13.16 30 006 13.16	45DB240V16PTD
	160	4	6.7	16	10 to 17.5	442	30 231 13.16	–
				16	10 to 24	442	–	45DB240V16PTD
	200	4	8.4	16	10 to 17.5	442	30 231 13.16	–
				20 20	10 to 17.5 10 to 24	442 442	30 231 13.20 30 006 13.20	45DB240V20PTD
	250	4	10.5	20	10 to 17.5	442	30 231 13.20	–
				25 25	10 to 17.5 10 to 24	442 442	30 231 13.25 30 006 13.25	45DB240V25PTD
	315	4	13.2	25	10 to 17.5	442	30 231 13.25	–
				25 31.5 31.5	10 to 24 10 to 17.5 10 to 24	442 442 442	– 30 231 13.31,5 30 006 13.31,5	45DB240V25PTD 45DB240V32PTD
	400	4	16.8	31.5	10 to 17.5	442	30 231 13.31,5	–
				31.5 40	10 to 24 10 to 24	442 442	30 006 13.31,5 –	45DB240V32PTD 45DB240V40PTD
	500	4	21	40	10 to 17.5	442	30 231 13.40	–
40 50				10 to 24 10 to 24	442 442	30 006 13.40 –	45DB240V40PTD 45DB240V50PTD	
630	4	26.4	50	10 to 17.5	442	30 232 13.50	–	
			50 63 80	10 to 24 10 to 24 10 to 24	442 442 442	30 014 13.50 – –	45DB240V50PTD 45DB240V63PTD 45DB240V80PTS	
800	5 to 6	33.5	63	10 to 24	442	30 014 43.63	45DB240V63PTD	
			80	10 to 24	442	–	45DB240V80PTS	
1000	5 to 6	41.9	80	10 to 24	442	30 014 43.80	45DB240V80PTD	
1250	5 to 6	52.3	100	10 to 24	442	–	45DB240V100PTS	
15 to 17.5	20	4	0.77	3.15	10 to 24	442	30 006 13.3,15	–
	50	4	1.9	6.3	10 to 17.5	442	30 231 13.6,3	–
				6.3 10	10 to 24 10 to 24	442 442	30 006 13.6,3 –	45DB240V10PTD
	75	4	2.9	6.3	10 to 17.5	442	30 231 13.6,3	–
				10 10	10 to 24 10 to 24	442 442	– –	45DB240V10PTD
	100	4	3.9	10	10 to 17.5	442	30 231 13.10	–
				10	10 to 24	442	–	45DB240V10PTD
	125	4	4.8	16	10 to 17.5	442	30 231 13.16	–
				16	10 to 24	442	30 006 13.16	45DB240V16PTD
	160	4	6.2	16	10 to 17.5	442	30 231 13.16	–
				16	10 to 24	442	–	45DB240V16PTD
	200	4	7.7	16	10 to 24	442	–	45DB240V16PTD
				20 20	10 to 17.5 10 to 24	442 442	30 231 13.20 30 006 13.20	–
	250	4	9.7	25	10 to 17.5	442	30 231 13.25	–
				25	10 to 24	442	30 006 13.25	45DB240V25PTD
	315	4	12.2	25	10 to 24	442	–	45DB240V25PTD
				31.5 31.5	10 to 17.5 10 to 24	442 442	30 231 13.31,5 30 006 13.31,5	–
	400	4	15.5	31.5	10 to 17.5	442	30 231 13.31,5	–
				31.5	10 to 24	442	30 006 13.31,5	45DB240V32PTD
	500	4	19.3	31.5	10 to 17.5	442	30 231 13.31,5	–
31.5 40 40				10 to 24 10 to 17.5 10 to 24	442 442 442	30 006 13.31,5 30 231 13.40 30 006 13.40	45DB240V40PTD	
630	4	24.3	40	10 to 17.5	442	30 231 13.40	–	
			40 50 50 63	10 to 24 10 to 17.5 10 to 24 10 to 24	442 442 442 442	30 006 13.40 30 232 13.50 30 014 13.50 30 014 43.63	45DB240V50PTD	
800	5 to 6	30.9	63	10 to 24	442	30 014 43.63	–	
1000	5 to 6	38.5	80	10 to 24	442	30 014 43.80	–	
1250	5 to 6	48.2	100	10 to 24	442	30 022 43.100	–	

# Components

## Allocation of HV HRC fuses and transformer ratings

MV system	Transformer			HV HRC fuse-link					
Operating voltage $U_n$ kV	Rated power $S_r$ kVA	Relative impedance voltage $u_k$ %	Rated current $I_r$ A	Rated current $I_r$ A	Min. operating/ rated voltage $U_r$ kV	Dimension e mm	Order No. Make SIBA	Order No. Make Mersen	
20 to 24	20	4	0.57	3.15	10 to 24	442	30 006 13.3,15	–	
	50	4	1.5	6.3	10 to 24	442	30 006 13.6,3	–	
	75	4	2.2	6.3	10 to 24	442	30 006 13.6,3	–	
	100	4	2.9	6.3	10 to 24	442	30 006 13.6,3	–	
					10	10 to 24	442	–	45DB240V10PTD
	125	4	3.6	10	10 to 24	442	30 006 13.10	45DB240V10PTD	
	160	4	4.7	10	10 to 24	442	30 006 13.10	–	
	200	4	5.8	16	10 to 24	442	30 006 13.16	45DB240V16PTD	
	250	4	7.3	16	10 to 24	442	30 006 13.16	45DB240V16PTD	
	315	4	9.2	16	10 to 24	442	30 006 13.16	–	
					20	10 to 24	442	30 006 13.20	–
					25	10 to 24	442	–	45DB240V25PTD
	400	4	11.6	20	10 to 24	442	30 006 13.20	–	
					25	10 to 24	442	30 006 13.25	45DB240V25PTD
	500	4	14.5	25	10 to 24	442	30 006 13.25	45DB240V25PTD	
					31.5	10 to 24	442	30 006 13.31,5	45DB240V32PTD
	630	4	18.2	31.5	10 to 24	442	30 006 13.31,5	45DB240V32PTD	
					40	10 to 24	442	30 006 13.40	45DB240V40PTD
	800	5 to 6	23.1	31.5	10 to 24	442	30 006 13.31,5	–	
					40	10 to 24	442	30 006 13.40	45DB240V40PTD
1000	5 to 6	29	50	10 to 24	442	30 014 13.50	45DB240V50PTS		
				63	10 to 24	442	30 014 43.63	–	
1250	5 to 6	36	50	10 to 24	442	–	45DB240V50PTS		
				80	10 to 24	442	30 014 43.80	–	
1600	5 to 6	46.5	100	10 to 24	442	30 022 43.100	–		
2000	5 to 6	57.8	140	10 to 24	442	30 022 43.140	–		

### Features

- According to IEC/EN 61869-1 and -2/ VDE 0414-9-1 and -2
- Designed as ring-core current transformers, 1-pole
- Free of dielectrically stressed cast-resin parts (due to design)
- Insulation class E
- Inductive type
- Secondary connection by means of a terminal strip in the panel.

### Installation

The mounting location is outside the switchgear vessel, around the cable at the panel connection; installation on the cable on site.

Note: Installation inside or underneath the panel depending on the panel type and the overall transformer height.

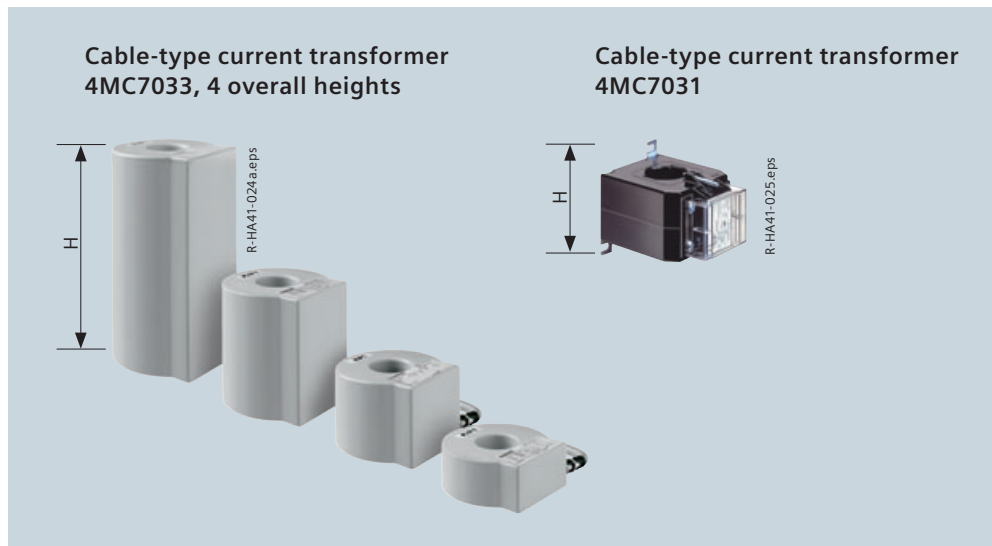

### Technical data

#### Cable-type current transformer 4MC7033

##### Primary data

Highest voltage for equipment $U_m$	0.72 kV
Rated current $I_N$	20 A to 600 A
Rated short-duration power-frequency withstand voltage (winding test)	3 kV
Rated short-time thermal current $I_{th}$	up to 25 kA / 1 s or 20 kA / 3 s
Rated continuous thermal current $I_D$	$1.2 \times I_N$
Transient overload current	$1.5 \times I_D / 1 \text{ h}$ or $2 \times I_D / 0.5 \text{ h}$
Rated dynamic current $I_{dyn}$	$2.5 \times I_{th}$

##### Secondary data

Rated current	1 A or 5 A, optionally: multiratio			
Measuring core	Class	0.2	0.5	1
	Overcurrent factor	without FS5	FS10	
	Rating	2.5 VA to 30 VA		
Protection core	Class	10 P	5 P	
	Overcurrent factor	10	20	30
	Rating	1 VA to 30 VA		

##### Dimensions

Overall height H, depending on core data	mm	65	110	170	285
Outside diameter	150 mm				
Inside diameter	55 mm				
For cable diameter	50 mm				

Other values on request

### Technical data

#### Cable-type current transformer 4MC7031

##### Primary data

Highest voltage for equipment $U_m$	0.72 kV
Rated current $I_N$	50 A to 600 A
Rated short-duration power-frequency withstand voltage (winding test)	3 kV
Rated short-time thermal current $I_{th}$	up to 25 kA / 1 s or 14.5 kA / 3 s
Rated continuous thermal current $I_D$	$1.2 \times I_N$
Transient overload current	$1.5 \times I_D / 1 \text{ h}$ or $2 \times I_D / 0.5 \text{ h}$
Rated dynamic current $I_{dyn}$	$2.5 \times I_{th}$

##### Secondary data

Rated current	1 A or 5 A	
Measuring core	Class	1
	Overcurrent factor	FS5
	Rating	2.5 VA to 10 VA

##### Dimensions

Overall height H	89 mm
Width × depth	85 mm × 114 mm
Inside diameter	40 mm
For cable diameter	36 mm

Other values on request

# Components

## Three-phase current transformer 4MC63

### Features

- According to IEC/EN 61869-1 and -2/ VDE 0414-9-1 and -2
- Designed as ring-core current transformer, 3-pole
- Free of dielectrically stressed cast-resin parts (due to design)
- Insulation class E
- Inductive type
- Climate-independent
- Secondary connection by means of a terminal strip in the panel.

### Installation

- Mounting location:
  - For individual panels type R(500) and L(500) (optional)
  - Arranged outside the switchgear vessel on the bushings of the cable connection
  - Factory-assembled.

### Further designs

(option)

For protection equipment based on the current-transformer operation principle:

- Protection system 7SJ45 as definite-time overcurrent protection
- Definite-time overcurrent protection relay, make Woodward/SEG, type WIP 1
- Definite-time overcurrent protection relay, make Woodward/SEG, type WIC.

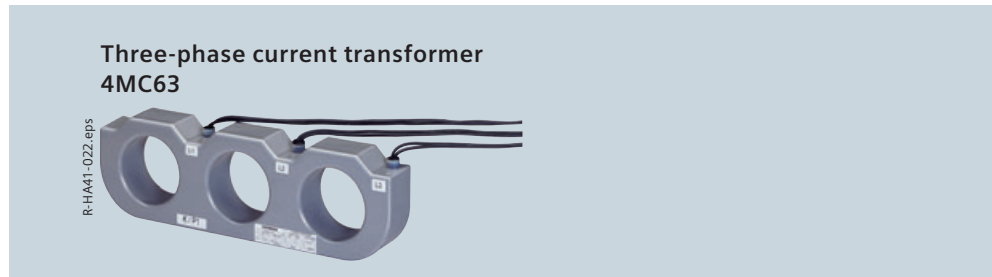

### Technical data

Three-phase current transformer 4MC6310  
for  $I_N \leq 150$  A and  $I_D = 630$  A

#### Primary data

Highest voltage for equipment $U_m$	0.72 kV				
Rated current $I_N$	A	150	100	75	50
Rated short-duration power-frequency withstand voltage (winding test)	3 kV				
Rated short-time thermal current $I_{th}$	up to 25 kA / 1 s or 20 kA / 3 s				
Rated continuous thermal current $I_D$	630 A				
Transient overload current	$1.5 \times I_D / 1$ h				
Rated dynamic current $I_{dyn}$	$2.5 \times I_{th}$				

#### Secondary data

Rated current	A	1	0.67	0.5	0.33
Rating	VA	2.5	1.7	1.25	0.8
Current at $I_D$	4.2 A				
Protection core	Class	10 P			
	Overcurrent factor	10			

Other values on request

### Technical data

Three-phase current transformer 4MC6311  
for  $I_N \leq 400$  A and  $I_D = 630$  A

#### Primary data

Highest voltage for equipment $U_m$	0.72 kV			
Rated current $I_N$	A	400	300	200
Rated short-duration power-frequency withstand voltage (winding test)	3 kV			
Rated short-time thermal current $I_{th}$	up to 25 kA / 1 s or 20 kA / 3 s			
Rated continuous thermal current $I_D$	630 A			
Transient overload current	$2 \times I_D / 0.5$ h			
Rated dynamic current $I_{dyn}$	$2.5 \times I_{th}$			

#### Secondary data

Rated current	A	1	0.75	0.5
Rating	VA	4	3	2
Current at $I_D$	1.575 A			
Protection core	Class	10 P		
	Overcurrent factor	10		

Other values on request

### Features

- According to IEC/EN 61869-1 and -2/ VDE 0414-9-1 and -2
- Designed as ring-core current transformer, 1-pole
- Free of dielectrically stressed cast-resin parts (due to design)
- Insulation class E
- Inductive type
- Secondary connection by means of a terminal strip in the panel.

### Installation

- Mounting location:
    - Arranged outside the switchgear vessel on the screened busbar section in bus sectionalizer panels with switch-disconnector type S and bus sectionalizer panels with circuit-breaker type V with the option of busbar current transformers
    - Arranged outside the switchgear vessel around the cable at the panel connection for 310 mm panel width (cable feeders type R and K), transformers mounted on a supporting plate at the factory; final assembly around the cables on site.
- Note:** Depending on the transformer overall height: Installation inside or underneath the panel.

### Bus/cable-type current transformer 4MC7032

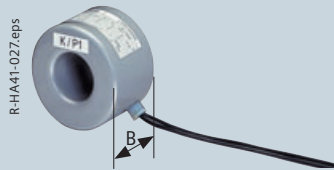

### Technical data

#### Bus/cable-type current transformer 4MC7032

#### Primary data

Highest voltage for equipment $U_m$	0.72 kV
Rated current $I_N$	200 A to 600 A
Rated short-duration power-frequency withstand voltage (winding test)	3 kV
Rated short-time thermal current $I_{th}$	up to 25 kA / 1 s or 20 kA / 3 s
Rated continuous thermal current $I_D$	$1.2 \times I_N$
Transient overload current	$1.5 \times I_D / 1$ h or $2 \times I_D / 0.5$ h
Rated dynamic current $I_{dyn}$	$2.5 \times I_{th}$

#### Secondary data

Rated current	1 A (option: 5 A)			
Measuring core	Class	0.2	0.5	1
	Overcurrent factor	with-out	FS5	FS10
	Rating	2.5 VA to 10 VA		
Protection core	Class	10 P	5 P *)	
	Overcurrent factor	10	10	
	Rating	2.5 VA to 15 VA		

#### Dimensions

Overall width B, depending on core data and mounting location	80 mm / 150 mm
Outside diameter	125 mm
Inside diameter	55 mm

Other values on request      \*) On request

### Panel section type V

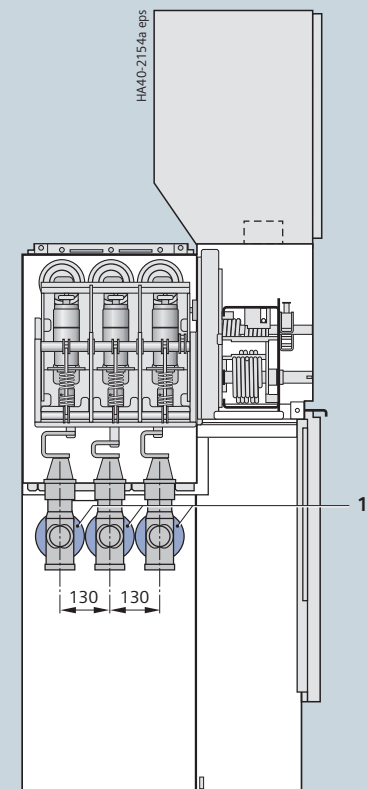

1 Bus / cable-type current transformer 4MC7032

# Components

## Plug-in voltage transformers 4MT3 and 4MT8

### Common features

- According to IEC/EN 61869-1 and -3/ VDE 0414-9-1 and -3
- 1-pole, plug-in design
- Inductive type
- Connection with plug-in contact
- Safe-to-touch due to metal cover
- Secondary connection by means of plugs inside the panel.

### Features of type 4MT3

- Metal-coated or metal-enclosed (option)
- For outside-cone system type A.

### Installation

- Mounting location:
  - Arranged above the switchgear vessel in individual panels type L(500), M(430), V and E (optional)
  - Arranged in front of the switchgear vessel in individual panel type M(500)
  - Direct connection to the busbar.

### Features of type 4MT8

- Metal-enclosed
- For connection to the cable plug-in unit (screened). <sup>1)</sup>

### Installation

- Mounting location:
  - Arranged in the cable compartment of individual panels type L(500) and R(500) (optional).

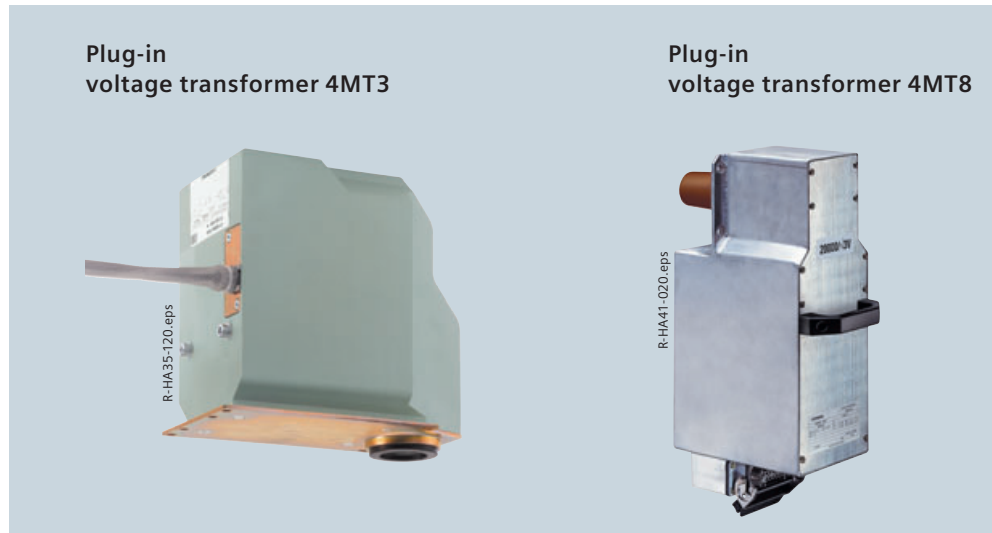

### Technical data

for types 4MT3 and 4MT8

#### Primary data

Highest voltage for equipment $1.2 \times U_n$	
Rated voltage (8 h) $= 1.9 \times U_n$	
Rated voltage $U_r$	Operating voltage $U_n$
kV	kV/ $\sqrt{3}$
3.6	3.3
7.2	3.6
	4.2
	4.8
	5.0
	6.0
	6.3
12	6.6
	7.2
	10.0
	11.0
17.5	11.6
	12.8
	13.2
	13.8
	15.0
	16.0
24	17.5
	20.0
	22.0
	22.0
	23.0

#### Secondary data

Rated voltage	1 <sup>st</sup> winding	100/ $\sqrt{3}$ 110/ $\sqrt{3}$
	Auxiliary winding (option)	100/3 110/3

#### for 4MT3

Rated long-time current (8 h)	6 A	Class
Rating in VA up to	20	0.2
	60	0.5
	120	1.0

#### for 4MT8

Rated long-time current (8 h)	6 A	Class
Rating in VA up to	25	0.2
	75	0.5
	120	1.0

<sup>1)</sup> Connection with symmetrical cable T-plugs (see table on page 47)

## Features

### Current transformer 4MA7

- According to IEC/EN 61869-1 and -2 / VDE 0414-9-1 and -2
- Dimensions according to DIN 42600-8 (small design)
- Designed as indoor support-type current transformer, 1-pole
- Cast-resin insulated
- Insulation class E
- Secondary connection by means of screw-type terminals.

### Voltage transformer 4MR

- According to IEC/EN 61869-1 and -3 / VDE 0414-9-1 and -3
- Dimensions according to DIN 42600-9 (small design)
- Designed as indoor voltage transformer:
  - Type 4MR, 1-pole
  - Option: Type 4MR, 2-pole
- Cast-resin insulated
- Insulation class E
- Secondary connection by means of screw-type terminals.

Current transformer 4MA7



Voltage transformer 4MR



## Technical data

### Current transformer 4MA7, 1-pole

#### Primary data

Highest voltage for equipment $U_m$	up to 24 kV
Rated short-duration power-frequency withstand voltage $U_d$	up to 50 kV
Rated lightning impulse withstand voltage $U_p$	up to 125 kV
Rated current $I_N$	20 A to 600 A
Rated short-time thermal current $I_{th}$	up to 25 kA / 1 s
Rated continuous thermal current $I_D$	$1.2 \times I_N$
Rated dynamic current $I_{dyn}$	max. $2.5 \times I_{th}$

#### Secondary data

Rated current	1 A or 5 A			
Measuring core	Class	0.2	0.5	1
	Overcurrent factor	without	FS5	FS10
	Rating	2.5 VA to 30 VA		
Protection core	Class	5 P or 10 P		
	Overcurrent factor	10		
	Rating	2.5 VA to 30 VA		

Other values on request

## Technical data

### Voltage transformer 4MR, 1-pole

#### Primary data

Highest voltage for equipment $1.2 \times U_n$	
Rated voltage (8 h) = $1.9 \times U_n$	
Rated voltage $U_r$	Operating voltage $U_n$
kV	$kV / \sqrt{3}$
3.6	3.3
7.2	3.6
	4.2
	4.8
	5.0
	6.0
12	6.3
	6.6
	7.2
17.5	10.0
	11.0
	11.6
	12.8
	13.2
24	13.8
	15.0
	16.0
	17.5
	20.0
	22.0
	23.0

#### Secondary data

Rated voltage in V	1st winding	100 / $\sqrt{3}$
		110 / $\sqrt{3}$
	120 / $\sqrt{3}$	
Rating in VA up to	Auxiliary winding (option)	100 / 3
		110 / 3
		120 / 3
	Class	
	20	0.2
	60	0.5
	100	1.0

Other values on request



# Components

## Current sensors

### Common features

- According to IEC 60044-8 (low-power current transformers)
- Example for available secondary devices that can be connected:
  - SICAM FCM
  - 7SJ81

### Current sensors (make Zelisko)

The current sensors are inductive current transformers whose secondary winding delivers a voltage signal through a precision shunt. At the rated primary current, this is 225 mV. Depending on their version, the sensors have a dual accuracy class; the output signal can be equally used for measuring, protection and, if required, earth-fault detection. The outgoing leads of the sensors are directly connected to the secondary device (SICAM FCM, 7SJ81).

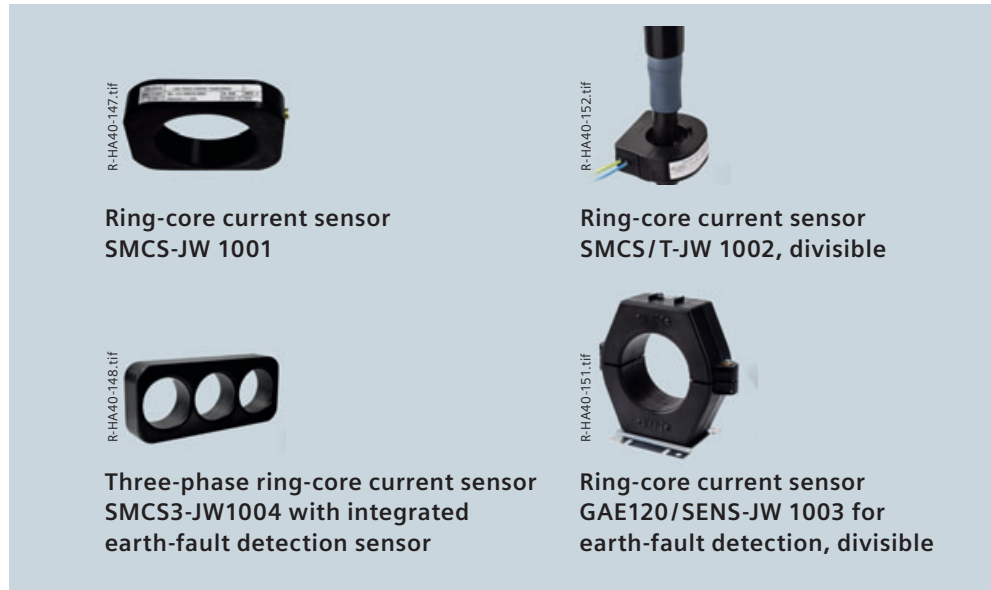

### Technical data

	SMCS-JW1001	SMCS/T-JW1002	GAE120/SENS-JW1003	SMCS3-JW1004	
<b>Primary data</b>					
Highest voltage for equipment $U_n$	0.72/3 kV	0.72/3 kV	0.72/3 kV	0.72/3 kV	
Rated current $I_N$	300 A <sup>1)</sup>	300 A <sup>1)</sup>	60 A	300 A <sup>1)</sup>	
Rated short-time thermal current $I_{th}$	25 kA 1 s	25 kA 1 s	25 kA 1 s	25 kA 1 s	
<b>Secondary data</b>					
Output signal	225 mV	225 mV	225 mV	225 mV	
Measuring	Class	0.5; 1; 3	1; 3	0.5; 1; 3	
	Overcurrent factor	–	–	–	
Protection	Class	5P	5P	5P	
	Overcurrent factor	10    20	10; 20	–	10
Earth-fault detection	Class	–	–	1	
	Angle error	–	–	± 120'	
	Composite error e	–	–	≤ 10 % (at 0.4 A) ≤ 20 % (at 200 A)	≤ 10 % (at 0.4 A)
Rated burden	≥ 20 kOhm	≥ 20 kOhm	≥ 20 kOhm	≥ 20 kOhm	
<b>Dimensions and installation</b>					
Overall height, depending on the overcurrent factor	28 mm	up to 56 mm	53 mm	130 mm (incl. mounting plate)	54 mm
External dimensions in mm	128 × 106		111 × 106	242 × 226	300 × 132
Inside diameter in mm	82		55	120	84 (per phase)
Mounting location	Cable plug <sup>2)</sup>		On the cable	On the cable	Cable plug <sup>2)</sup>
Usable for panel widths in mm	310, 430, 500	430, 500	310, 430, 500	310, 430, 500	310

1) Usable up to  $2 \times I_n = 600$  A (output signal  $2 \times 225$  mV) at constant accuracy class and half overcurrent factor

2) Mounting location at the bushings around the screened cable plug

**Common features**

- According to IEC 60044-7 (low-power voltage transformers)
- Example for available secondary devices that can be connected:
  - SICAM FCM
  - 7SJ81

**Voltage sensors**  
(make Zelisko)

The voltage sensors are resistor dividers which provide an output signal of  $3.25 V/\sqrt{3}$  at the rated primary voltage. The outgoing leads of the sensors are directly connected to the secondary device (SICAM FCM, 7SJ81).

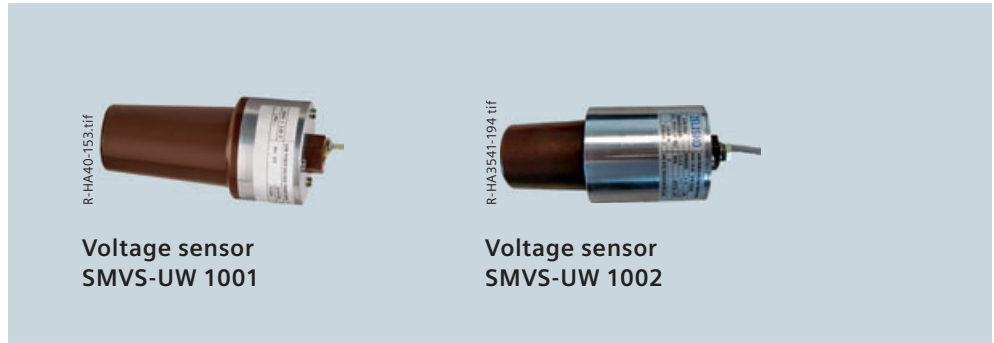

Technical data				
	SMVS-UW1001		SMVS-UW1002	
<b>Primary data</b>				
Highest voltage for equipment $U_m$	$1.2 \times U_n$		$1.2 \times U_n$	
Rated voltage (8 h)	$1.9 \times U_n$		$1.9 \times U_n$	
Rated voltage $U_r$	12 kV	24 kV	12 kV	24 kV
Operating voltage $U_n$	10 kV	20 kV	10 kV	20 kV
<b>Secondary data</b>				
Rated voltage	$3.25 V/\sqrt{3}$		$3.25 V/\sqrt{3}$	
Class	0.5; 1; 3		0.5; 1; 3	
Rated burden	200 kOhm $\pm$ 1 %		200 kOhm $\pm$ 1 %	
<b>Installation</b>				
Mounting location	On the screened cable plugs make Nexans type 440TB, K440TB; other types and makes on request		On the screened cable plugs make TE Connectivity type RSTI-58, RSTI-CC58xx, make nkt cables type CB-24 and CC-24; other types and makes on request	

# Components

## Cable connection with interface type C

### Features

- Access to the cable compartment only if the feeder has been disconnected and earthed
- Bushings according to DIN EN 50181 with outside cone and bolted connection M16 as interface type C.

### Connection of

- Cable elbow plugs or cable T-plugs with bolted contact M16 for 630 A
- Paper-insulated mass-impregnated cables via customary adapters
- Thermoplastic-insulated cables (1-core and 3-core cables).

### Option

- Mounted cable clamps on cable bracket.

### Cable plugs

- As screened (semi-conductive) design independent of the site altitude,  
or  
as unscreened (insulated) design, but then dependent on the site altitude.

### Surge arresters

- Pluggable on cable T-plug, cable elbow plug or T-adapter
- The switchgear depth can be extended when surge arresters are mounted (depending on the make and type)
- Surge arresters recommended if, at the same time,
  - the cable system is directly connected to the overhead line,
  - the protection zone of the surge arrester at the end tower of the overhead line does not cover the switchgear.

### Surge limiters

- Pluggable on cable T-plug
- Surge limiters recommended when motors with starting currents < 600 A are connected.

### Cable compartment

	Switchgear height without low-voltage compartment <sup>1)</sup>	1040 <sup>2)</sup>	1200	1400 without absorber base	1400 with absorber base, or 1700
Panel width 310 mm	Typical K, R	A	500	660	860
	Typical R (8DJH Compact)		–	–	200
Panel width 430 mm	Typical K(E), L	B	–	660	860
Panel width 500 mm	Typical R(500), L(500)	C	–	510	710

<sup>1)</sup> Option: With low-voltage compartment  
<sup>2)</sup> Only for panel blocks RR, RRR, RT, RRT and RTR

---

### Connection options

1 Cable T-plug  
 2 Cable elbow plug  
 3 Surge arrester  
 4 Coupling T-plug  
 5 Screw-type coupling insert

### Cable plugs for single cable connection

Cable type	Cable plugs					
	Make	Serial no.	Type	Design T/W <sup>1)</sup>	Conductor cross-section mm <sup>2</sup>	Design <sup>2)</sup>

#### Thermoplastic-insulated cables ≤ 12 kV according to IEC/EN 60502-2/VDE 0276-620

1-core or 3-core cable, PE and XLPE-insulated N2YSY (Cu) and N2XSY (Cu) or NA2YSY (Al) and NA2XSY (Al)	Nexans	1	400TB/G, 430TB/G, 480TB/G	T	35–300	Screened
		2	400LB/G	W	35–300	Screened
		3	484TB/G	T	70–630	Screened
		4	440TB/G	T	185–630	Screened
	nkt cables	5	CB 24-630	T	25–300	Screened
		6	AB 24-630	T	25–300	Insulated
		7	CB 36-630 (1250)	T	300–630	Screened
	Südkabel	8	SET 12	T	50–300	Screened
		9	SEHDT 13	T	185–500	Screened
	Prismian Kabel und Systeme (Pirelli Elektrik)	10	FMCTs-400	T	25–300	Screened
	3M	11	93-EE 705-6/-95	T	50–95	Screened
		12	93-EE 705-6/-240	T	95–240	Screened
	TE Connectivity	13	RICS 51 ... with IXSU	T	25–300	Insulated
		14	RICS 31 ... with IXSU	T	25–300	Insulated
		15	RSTI-39xx	T	400–800	Screened

#### Thermoplastic-insulated cables 15/17.5/24 kV according to IEC/EN 60502-2/VDE 0276-620

1-core or 3-core cable, PE and XLPE-insulated N2YSY (Cu) and N2XSY (Cu) or NA2YSY (Al) and NA2XSY (Al)	Nexans	16	K400TB/G, K430TB/G, K480TB/G	T	35–300	Screened	
		17	K400LB/G	W	35–300	Screened	
		18	K484TB/G	T	70–630	Screened	
		19	K440TB/G	T	185–630	Screened	
	nkt cables	20	CB 24-630	T	25–300	Screened	
		21	AB 24-630	T	25–300	Insulated	
		22	CB 36-630 (1250)	T	300–630	Screened	
	Südkabel	23	SET 24	T	50–240	Screened	
		24	SEHDT 23.1	T	300	Screened	
		25	SEHDT 23	T	185–630	Screened	
	Prismian Kabel und Systeme (Pirelli Elektrik)	26	FMCTs-400	T	25–240	Screened	
	3M	27	93-EE 705-6/-95	T	25–95	Screened	
		28	93-EE 705-6/-240	T	95–240	Screened	
	TE Connectivity	for 1-core cables	29	RICS 51 ... with IXSU	T	25–300	Insulated
			30	RSTI-58xx	T	25–300	Screened
31			RSTI-59xx	T	400–800	Screened	
for 3-core cables		32	RICS 51 ... with IXSU	T	25–300	Insulated	
		33	RSTI-58xx + RSTI-TRFxx	T	25–300	Screened	

#### Paper-insulated mass-impregnated cables ≤ 12 kV according to IEC/EN 60055-2/VDE 0276-621

3-core cable, paper-insulated N(A)KLEY, N(A)KBA, N(A)KBY	TE Connectivity	34	RICS 51... with UHGK/EPKT	T	95–300	Insulated
3-core cable, paper-insulated N(A)EKBA, N(A)KLEY	TE Connectivity	35	RICS 51... with IDST 51 .. <sup>3)</sup>	T	50–300	Insulated

#### Paper-insulated mass-impregnated cables 15/17.5/24 kV according to IEC/EN 60055-2/VDE 0276-621

1-core or 3-core cable, paper-insulated N(A)EKBA, N(A)KLEY	TE Connectivity	36	RICS 51 ... with IDST 51 .. <sup>3)</sup>	T	35–240	Insulated
---	-----------------	----	---	---	--------	-----------

1) T = Cable T-plug, W = Cable elbow plug

2) Use of current transformers and sensors in combination with insulated systems on request

3) Discontinued by the manufacturer

# Components

## Cable connection with interface type C

### Deep cable compartment cover

To increase the mounting depth in the cable compartment, deep cable compartment covers can be ordered optionally (not for 8DJH Compact). The assignment to selected types of cable plugs and cable plug/surge arrester combinations is given in the following tables.

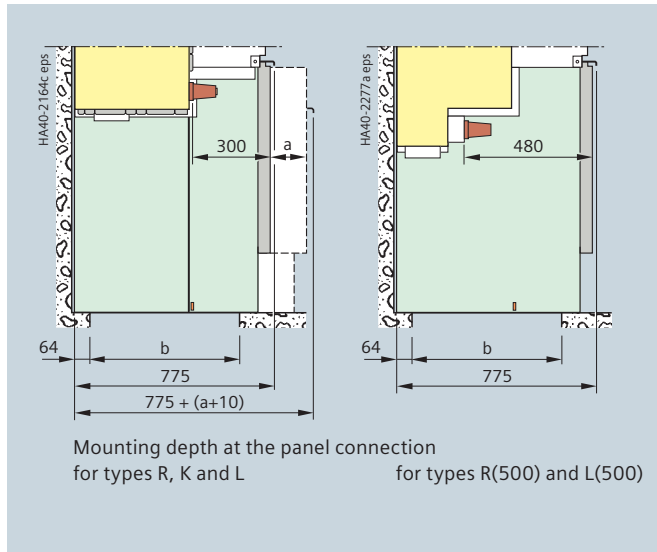

### Cable plugs for double cable connection

Double cable connection			Connection combination			Deep cable compartment cover <sup>1)</sup>	
Make	Serial no.	Cable plug (type)	Design <sup>2)</sup>	Arrangement	Mounting depth (mm)	Deeper by a (mm)	Depth of floor opening b (mm)
Nexans	1	(K)430TB/G + (K)300PB/G, (K)480TB/G + (K)800PB/G, (K)484TB/G + (K)804PB/G	Screened	K + K	290	–	635
	2	2x (K)400TB/G with coupling insert (K)400CP	Screened	K + K	505	250	860
	3	(K)400TB/G + (K)400LB/G with coupling insert (K)400CP-LB	Screened	K + K	455	250	860
	4	(K)400TB/G + (K)430TB/G with coupling insert (K)400CP	Screened	K + K	403	250	860
	5	2x (K)440TB/G with coupling insert (K)440CP	Screened	K + K	505	250	860
Südkabel	6	SET (12/24) + SEHDK (13.1/23.1)	Screened	K + K	290	–	635
	7	SEHDT 23.1 + SEHDK 23.1	Screened	K + K	290	–	635
	8	2x SEHDT 23.1 with coupling unit KU 23.2/23	Screened	K + K	363	250	860
	9	SEHDT (13/23) + SET (12/24) with coupling unit KU 23 or KU 33	Screened	K + K	451	250	860
	10	2x SET (12/24) with coupling unit KU 23.2/23	Screened	K + K	363	105	715
nkt cables	11	CB 24-630 + CC 24-630	Screened	K + K	290	–	635
	12	2x CB 24-630 with coupling unit CP 630C	Screened	K + K	370	250 105 o.r.	860 715
	13	AB 24-630 + AC 24-630	Insulated	K + K	290	105 o.r.	715
	14	2x AB 24-630 with coupling unit CP 630A	Insulated	K + K	370	250 105 o.r.	860 715
	15	CB 36-630 (1250) + CC 36-630 (1250)	Screened	K + K	300	–	635
TE Connectivity	16	RSTI-58xx + RSTI-CC-58xx	Screened	K + K	285	–	635
	17	RSTI-x9xx + RSTI-CC-x9xx	Screened	K + K	315	105	715
3M	18	2x 93-EE705-6/xxx with coupling unit KU 23.2	Screened	K + K	363	105	715

o.r. = on request

K = Cable plug

1) Applies to panels of 310 mm and 430 mm. For individual panels of 500 mm, no deep cable compartment cover and floor opening are required – except for serial no. 2 and no. 5 with cable compartment cover deeper by 105 mm (a).

2) Use of current transformers and sensors in combination with insulated systems on request

### Cable plugs for single and double cable connection with surge arresters

Cable plugs for single and double cable connection with surge arresters			Connection combination			Deep cable compartment cover <sup>1)</sup>
Make	Serial no.	Cable plug / surge arrester (type)	Design <sup>2)</sup>	Arrangement	Mounting depth (mm)	Deeper by a <sup>3)</sup> (mm)
Nexans	1	(K)430TB/G + 300SA, (K)480TB/G + 800SA, (K)484TB/G + 800SA	Screened	K + Ü	290	–
	2	(K)400TB/G + 400PB-...SA	Screened	K + Ü	410	250
	3	(K)430TB/G + (K)300PB/G + 300SA	Screened	K + K + Ü	395	105
	4	(K)480TB/G + (K)800PB/G + 800SA, (K)484TB/G + (K)804PB/G + 800SA	Screened	K + K + Ü	400	250
Südkabel	5	SET (12/24) + MUT (13/23)	Screened	K + Ü	302	105
	6	SEHDT 23.1 + MUT 23	Screened	K + Ü	302	105
	7	2x SET (12/24) + MUT (13/23) with coupling unit KU 23.2/23	Screened	K + K + Ü	476	250
	8	2x SEHDT 23.1 + MUT 23 with coupling unit KU 23.2/23	Screened	K + K + Ü	476	250
	9	SEHDT (13/23) + MUT 33	Screened	K + Ü	540	250
nkt cables	10	CB 24-630 + CSA 24...	Screened	K + Ü	290	–
	11	AB 24-630 + ASA 24...	Insulated	K + Ü	290	105
	12	CB 36-630 (1250) + CSA...	Screened	K + Ü	290	–
TE Connectivity	13	RICS 5139 + RDA...	Insulated	K + Ü	275	–
	14	RSTI-58xx + RSTI-CC-58SAxx	Screened	K + Ü	285	–
	15	RSTI-58xx + RSTI-CC-68SAxx	Screened	K + Ü	292	–
	16	RSTI-x9xx + RSTI-CC-58SAxx	Screened	K + Ü	295	–
	17	RSTI-x9xx + RSTI-CC-68SAxx	Screened	K + Ü	302	105
3M	18	2x 93-EE705-6/xxx + MUT 23 with coupling unit KU 23.2	Screened	K + K + Ü	476	250

### Cable plugs for single cable connection and 4MT8 voltage transformers

The 4MT8 voltage transformers can be installed in ring-main and circuit-breaker feeders (500 mm panel width). A deep cable compartment cover is not necessary. To connect them, symmetrical cable T-plugs (see table) are required.

Before a dielectric test on the cables (supplied by site with max. 80%  $U_d$ ) can be carried out, the voltage transformers must be demounted.

Make	Type	Design
Nexans	(K)400TB/G (K)440TB/G	Screened
Prysmian	FMCTs-400	Screened
Südkabel	SEHDT (13/23) without metal enclosure	Screened

1) Applies to panels of 310- and 430-mm. For individual panels of 500 mm, no deep cable compartment cover and floor opening are required – except for serial no. 9 with cable compartment cover deeper by 105 mm (a)

2) Use of current transformers and sensors in combination with insulated systems on request

3) See drawing on page 46.

K = Cable plug      Ü = Surge arrester

# Components

Cable connection for transformer feeders with interface type A

## Features

- Access to the cable compartment only if the feeder has been disconnected and earthed
- Bushings according to DIN EN 50181 with outside cone and plug-in contact as interface type A.

Connection of

- Cable elbow plugs or straight cable plugs
- Connection cross-sections up to 120 mm<sup>2</sup>.

## Option

- Mounted cable clamps on cable bracket
- Bushings according to DIN EN 50181 with outside cone and bolted contact as interface type C for cable routing downwards.

## Routing of transformer cables

For 8DJH Standard design with bushing arrangement:

- At the front with cable elbow plug: Downwards (standard)
- At the bottom with cable elbow plug: To the rear (option)
- At the bottom with straight cable plug: Downwards (option).

For 8DJH Compact design with bushing arrangement:

- At the top with cable elbow plug: To the rear (standard)
- At the top with straight cable plug: Upwards (option)
- At the top with cable elbow plug: To the right (option).

## Cable plugs

- As screened (semi-conductive) design independent of the site altitude,  
or  
as unscreened (insulated) design, but then dependent on the site altitude.

	Switchgear height without low-voltage compartment <sup>1)</sup>		1040 <sup>2)</sup>	1200	1400 without absorber base	1400 with absorber base, or 1700
Panel width 430 mm	Typical T	A	62	222	422	722
	Typical T (8DJH Compact)	B <sub>1</sub>	–	–	1245	1545
		B <sub>2</sub>	–	–	1143	1443

## Cable compartment

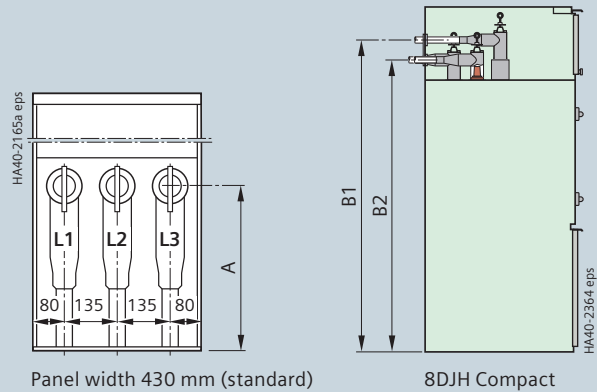

## Connection options

8DJH Standard

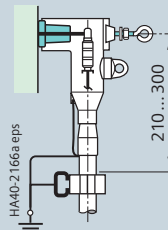

Cable routing downwards with cable elbow plug

8DJH Compact

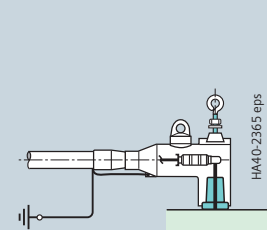

Cable routing to the rear with cable elbow plug

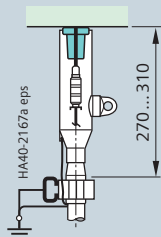

Cable routing downwards with straight plug

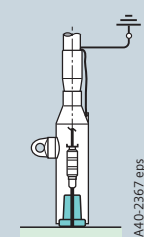

Cable routing upwards with straight plug

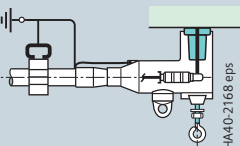

Cable routing to the rear with cable elbow plug

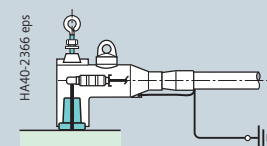

Cable routing to the right with cable elbow plug

1) Option: With low-voltage compartment

2) Only for panel blocks RR, RRR, RT, RRT and RTR



### Cable plugs for single cable connection

Cable type	Cable plug					
	Make	Serial no.	Type	Design G / W <sup>1)</sup>	Conductor cross-section mm <sup>2</sup>	Design

#### Thermoplastic-insulated cables ≤ 12 kV according to IEC / EN 60502-2 / VDE 0276-620

1-core cable, PE and XLPE-insulated N2YSY (Cu) and N2XSY (Cu) or NA2YSY (Al) and NA2XSY (Al)	Nexans	1	158LR	W	16–120	screened; with capacitive measuring point
		2	152SR	G	95–120	screened; with capacitive measuring point
	nkt cables	3	EASW 10/250, Gr. 2	W	25–95	screened; <u>option</u> : with metal housing or with capacitive measuring point
		4	EASG 10/250, Gr. 2	G	25–95	screened; <u>option</u> : with capacitive measuring point
		5	CE 24 – 250	W	95–120	screened; <u>option</u> : with metal housing or with capacitive measuring point
	Südkabel	6	SEHDG 11.1	G	25–120	screened; <u>option</u> : with metal housing
		7	SEW 12	W	25–120	screened; <u>option</u> : with metal housing
	Cooper Power Systems	8	DE 250 – R-C	W	16–120	screened
		9	DS 250 – R-C	G	16–120	screened
	Prysmian Kabel und Systeme (Pirelli Elektrik)	10	FMCE-250	W	25–120	screened
	3M	11	93-EE 605-2/-95	W	25–95	screened; <u>option</u> : with metal housing
		12	93-EE 600-2/xx	G	25–150	screened; <u>option</u> : with metal housing
	TE Connectivity	13	RSSS 52xx	G	25–95	screened; with capacitive measuring point
		14	RSES 52xx-R	W	25–120	screened; with capacitive measuring point

#### Thermoplastic-insulated cables 15/17.5/24 kV according to IEC / EN 60502-2 / VDE 0276-620

1-core cable, PE and XLPE-insulated N2YSY (Cu) and N2XSY (Cu) or NA2YSY (Al) and NA2XSY (Al)	Nexans	15	K158LR	W	16–120	screened; with capacitive measuring point
		16	K152SR	G	25–120	screened; with capacitive measuring point
	nkt cables	17	EASG 20/250	G	25–95	screened; <u>option</u> : with metal housing
		18	CE 24 – 250	W	25–95	screened; <u>option</u> : with metal housing or with capacitive measuring point
	Südkabel	19	SEHDG 21.1	G	25–70	screened; <u>option</u> : with metal housing
		20	SEW 24	W	25–95	screened; <u>option</u> : with metal housing
	Cooper Power Systems	21	DE 250 – R-C	W	16–120	screened
		22	DS 250 – R-C	G	16–120	screened
	Prysmian Kabel und Systeme (Pirelli Elektrik)	23	FMCE-250	W	25–120	screened
	3M	24	93-EE 605-2/-95	W	25–95	screened; <u>option</u> : with metal housing
		25	93-EE 600-2/xx	G	25–150	screened; <u>option</u> : with metal housing
	TE Connectivity	26	RSSS 52xx	G	16–70	screened; with capacitive measuring point
		27	RSES 52xx-R	W	16–120	screened; with capacitive measuring point

1) G = Straight cable plug  
W = Cable elbow plug

# Components

## Cable connections

### Cable testing

- For cable, ring-main cable and circuit-breaker feeders
- Disassembly of the switchgear cables not necessary
- Measuring bolts can be connected following the removal of the protective cap and/or the end stopper of the cable plug
- The switchgear is suitable for the following cable test voltages:

Rated voltage of switchgear	Cable test voltage <sup>1)</sup>		
	$U_{ct}$ (DC) kV	$U_{ct}$ (AC) kV	VLF 0.1 Hz <sup>2)</sup> kV
7.2	22	11	11
12	38	19	19
15	52	28	28
17.5	52	28	28
24	72	38	38
Test duration	15 min	60 min	60 min

- Additional important data for cable testing are included
  - In the installation and operating instructions for the 8DJH switchgear
  - In the standards IEC/EN 62271-200/VDE 0671-200, HD 620 S2/VDE 0276-620, HD 621 S1/VDE 0276-621
  - In the cable and cable plug manufacturer information.

### Cable testing

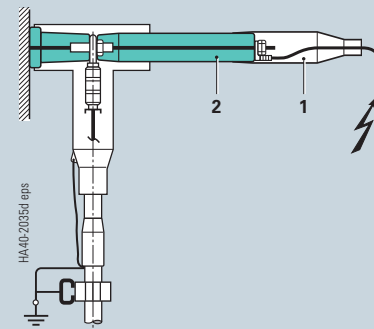

Cable testing at the cable T-plug (example)

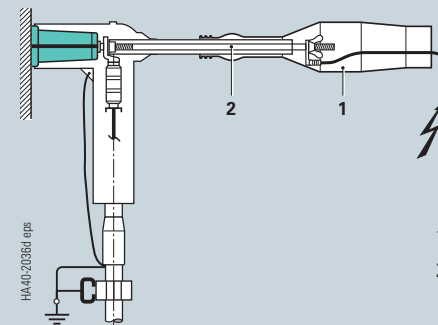

Cable testing at the cable elbow plug (example)

- 1 Insulating cap
- 2 Measuring bolt

1) Further values on request

2) VLF = Very low frequency

### Standard interlocks

- Three-position switch: Disconnecting function against earthing function
- Circuit-breaker feeder: Circuit-breaker against three-position disconnecter
- Access to cable compartment is generally only possible if
  - the feeder is isolated
  - and
  - the feeder is earthed (“EARTHED” position).

For ring-main and circuit-breaker feeders

- Option: Closing lockout  
Prevents switching the three-position switch-disconnector from “OPEN” position to “CLOSED” position when the cable compartment cover is removed.

For transformer feeders

- The three-position switch-disconnector cannot be switched from “EARTHED” to “OPEN” position when the cable compartment cover/the HV HRC fuse compartment is open.

### Locking device for padlock

- Shackle diameter 12 mm
- Standard for transformer and circuit-breaker feeders (stored-energy mechanisms)
- Option for ring-main feeders (spring-operated mechanisms)
- Three-position switch-disconnector lockable at the operating mechanism in any desired switch position.

### Key-operated interlock (option)

- With cylinder locks from selected manufacturers
- For the basic functionalities:
  - Switch-disconnector/disconnector  
KF 1 Key free in OPEN  
Key trapped in CLOSED
  - Earthing switch  
KF 2 Key free in OPEN  
Key trapped in EARTHED
  - KF 3 Key free in EARTHED  
Key trapped in OPEN

These basic functionalities can be combined at will. Furthermore, it is possible to integrate cylinder locks, e.g. of doors to transformer rooms, or external key boxes.

### Interlocking of three-position switch (option: locking device)

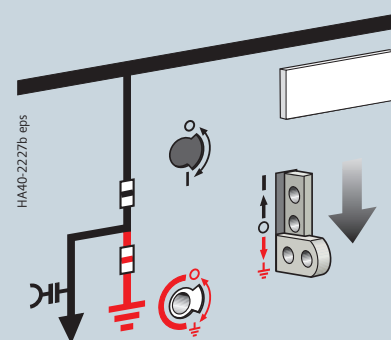
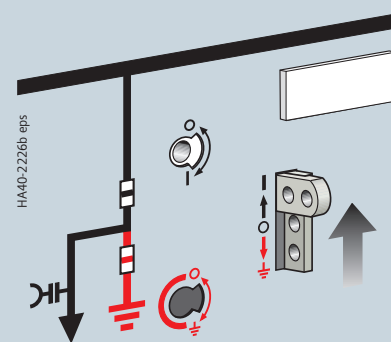
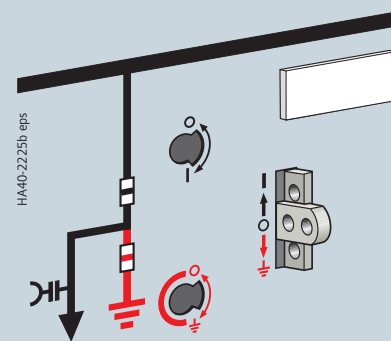

### Interlocking of three-position switch (option: key-operated interlock)

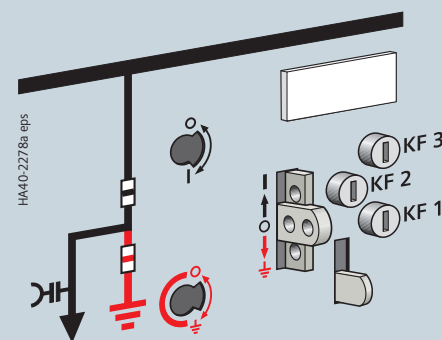

# Components

## Indicating and measuring equipment

### Ready-for-service indicator

#### Features

- Self-monitoring; easy to read
- Independent of temperature and pressure variations
- Independent of the site altitude
- Only responds to changes in gas density
- Option: Alarm switch "1NO + 1NC" for remote electrical indication.

#### Mode of operation

For the ready-for-service indicator, a gas-tight measurement box is installed inside the switchgear vessel.

A coupling magnet, which is fitted to the bottom end of the measurement box, transmits its position to an outside armature through the non-magnetizable switchgear vessel. This armature moves the ready-for-service indicator of the switchgear.

While changes in the gas density during the loss of gas, which are decisive for the dielectric strength, are displayed, temperature-dependent changes in the gas pressure are not. The gas in the measurement box has the same temperature as that in the switchgear vessel. The temperature effect is compensated via the same pressure change in both gas volumes.

### Gas monitoring

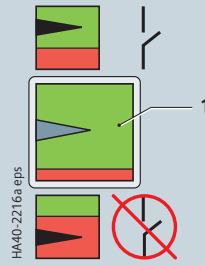

Indicator on control board:

- 1 Indication:
  - green: ready for service
  - red: not ready for service
- 2 Measurement box
- 3 Magnetic coupling

### Principle of operation

of gas monitoring with ready-for-service indicator

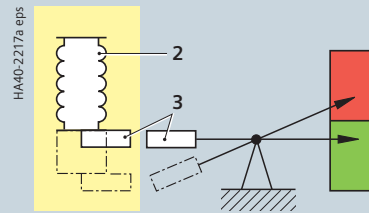

Stainless-steel vessel  
filled with SF<sub>6</sub> gas

Ready-for-service  
indicator

### Voltage detecting systems according to IEC 61243-5 or VDE 0682-415

- For verification of safe isolation from supply
- HR or LRM detecting systems with plug-in indicator
- LRM detecting systems with integrated indicator type VOIS+, VOIS R+, CAPDIS-S1+, CAPDIS-S2+, WEGA 1.2 C, WEGA 2.2 C or WEGA 3.

#### Plug-in voltage indicator

- Verification of safe isolation from supply phase by phase
- Indicator suitable for continuous operation
- Measuring system and voltage indicator can be tested, repeat test according to local specifications and standards
- Voltage indicator flashes if high voltage is present.

#### VOIS+, VOIS R+

- Without auxiliary power
- Display indication "A1" to "A3" (see legend)
- Repeat test according to local specifications and standards
- With integrated 3-phase LRM test socket for phase comparison
- With integrated signaling relay (only VOIS R+).

#### Common features of CAPDIS-Sx+

- Without auxiliary power
- Integrated repeat test of the interfaces (self-monitoring)
- With integrated function test (without auxiliary power) by pressing the "Test" button
- Adjustable for different operating voltages (adjustable capacitance C2)
- With integrated 3-phase LRM test socket for phase comparison
- With connectable signal-lead test
- With overvoltage monitoring and signaling (1.2 times operating voltage).

#### CAPDIS-S1+

- Without auxiliary power
- Display indication "A1" to "A7" (see legend)
- Without ready-for-service monitoring
- Without signaling relay (without auxiliary contacts).

#### CAPDIS-S2+

- Display indication "A0" to "A8" (see legend)
- Only by pressing the "Test" pushbutton: "ERROR" indication (A8), e.g. in case of missing auxiliary voltage
- With ready-for-service monitoring (auxiliary power required)
- With integrated signaling relay for signals (auxiliary power required).

### Indicators and detecting systems

R-HA40-103.psd



**Plug-in voltage indicator**  
per phase at the panel front

R-HA41-VOIS.tif



**Integrated voltage indicator**  
VOIS+, VOIS R+

R-HA41-CAPDIS-S1.tif



R-HA41-CAPDIS-S2.tif



**Integrated voltage detecting system**  
CAPDIS-S1+, -S2+

### Symbols shown

	VOIS+, VOIS R+			CAPDIS-S1+			CAPDIS-S2+			
	L1	L2	L3	L1	L2	L3	L1	L2	L3	
A0							000			U=0 U=0 U=0
A1	⚡	⚡	⚡	⚡	⚡	⚡	⚡	⚡	⚡	U=0 U=0 U=0
A2										U=0 U=0 U=0
A3	⚡	⚡		⚡	⚡		⚡	⚡	⚡	U=0 U=0 U=0
A4				⚡	⚡	⚡	⚡	⚡	⚡	U=0 U=0 U=0
A5				000	000	000	000	000	000	U=0 U=0 U=0
A6				000	000	000	000	000	000	U=0 U=0 U=0
A7				000	000	000	000	000	000	U=0 U=0 U=0
A8							000	000	000	U=0 U=0 U=0

HA35-2579c.eps

CAPDIS S2+: The red and green LEDs show the state of the relay contacts

○ LED doesn't light up

● LED lights up

U = Operating voltage

**A0** CAPDIS-S2+: Operating voltage not present

**A1** Operating voltage present

**A2** – Operating voltage not present

– For CAPDIS-S2+: Auxiliary power not present

**A3** Failure in phase L1, operating voltage at L2 and L3 (for CAPDIS-Sx+ also earth-fault indication)

**A4** Voltage (not operating voltage) present

**A5** Indication "Test" passed (lights up shortly)

**A6** Indication "Test" not passed (lights up shortly)

**A7** Overvoltage present (lights up permanently)

**A8** "ERROR" indication, e.g. in case of missing auxiliary voltage

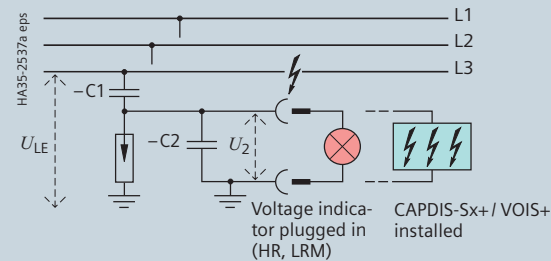

#### Voltage indication

via capacitive voltage divider (principle)

– C1 Capacitance integrated into bushing

– C2 Capacitance of the connection leads and the voltage indicator to earth

$U_{LE} = U_N / \sqrt{3}$  during rated operation in the three-phase system

$U_2 = U_A =$  Voltage at the capacitive interface of the switchgear or at the voltage indicator

# Components

Indicating and measuring equipment

## WEGA 3

- Display indication "A1" to "A5"
- Integrated repeat test of the interface (self-monitoring)
- With integrated 3-phase LRM test socket for phase comparison.

## WEGA 1.2 C

- Display indication "A1" to "A6" (see legend)
- Integrated repeat test of the interface (self-monitoring)
- With integrated function test (without auxiliary power) by pressing the "Display Test" button
- With integrated 3-phase LRM test socket for phase comparison.

## WEGA 2.2 C

- Display indication "A0" to "A7" (see legend)
- Integrated repeat test of the interface (self-monitoring)
- With integrated function test (without auxiliary power) by pressing the "Display Test" button
- With integrated 3-phase LRM test socket for phase comparison
- With two integrated signaling relays (auxiliary power required \*).



Integrated voltage indicator WEGA 3



Integrated voltage indicator WEGA 1.2 C



Integrated voltage indicator WEGA 2.2 C

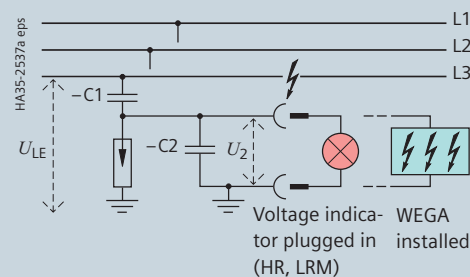

### Voltage indication

via capacitive voltage divider (principle)

- C1 Capacitance integrated into bushing
- C2 Capacitance of the connection leads and the voltage indicator to earth

$$U_{LE} = U_N / \sqrt{3} \text{ during rated operation in the three-phase system}$$

$$U_2 = U_A = \text{Voltage at the capacitive interface of the switchgear or at the voltage indicator}$$

\*) Shows the function of the relay via the LED indications (U=0, U≠0)

### Symbols shown

	WEGA 3			WEGA 1.2 C			WEGA 2.2 C			
	L1	L2	L3	L1	L2	L3	L1	L2	L3	
A0										U≠0 U=0
A1	⚡	⚡	⚡	⚡	⚡	⚡	⚡	⚡	⚡	U≠0 U=0
A2										U≠0 U=0
A3	⚡	⚡		⚡	⚡		⚡	⚡		U≠0 U=0
A4	⚡	⚡	⚡	⚡	⚡	⚡	⚡	⚡	⚡	U≠0 U=0
A5	⚡	⚡	⚡	⚡	⚡	⚡	⚡	⚡	⚡	U≠0 U=0
A6				⚡	⚡	⚡	⚡	⚡	⚡	U≠0 U=0
A7							⚡	⚡	⚡	U≠0 U=0

LC display gray: not illuminated

LC display white: illuminated

WEGA 2.2 C: The red and green LEDs show the state of the relay contacts

○ LED doesn't light up

● LED lights up

U = Operating voltage

A0 For WEGA 2.2 C:

Operating voltage not present, auxiliary power present, LCD illuminated

A1 Operating voltage present

For WEGA 2.2 C: Auxiliary power present, LCD illuminated

A2 Operating voltage not present

For WEGA 2.2 C: Auxiliary power not present, LCD not illuminated

A3 Failure in phase L1,

operating voltage at L2 and L3

For WEGA 2.2 C: Auxiliary power present, LCD illuminated

A4 Voltage present,

current monitoring of coupling

section below limit value

For WEGA 2.2 C: Auxiliary power present, LCD illuminated

A5 Indication "Display-Test" passed

For WEGA 2.2 C: Auxiliary power present, LCD illuminated

A6 Indication "Display Test" passed

For WEGA 2.2 C:

Auxiliary power present

A7 For WEGA 2.2 C: LCD for missing

auxiliary voltage is not illuminated

### Verification of correct terminal-phase connections

- Verification of correct terminal-phase connections possible by means of a phase comparison test unit (can be ordered separately)
- Safe-to-touch handling of the phase comparison test unit by inserting it into the capacitive taps (socket pairs) of the switchgear.

### Phase comparison test units according to IEC 61243-5 or VDE 0682-415

R-HA41-EPV.eps



#### Phase comparison test unit make Pfisterer, type EPV

as combined test unit (HR and LRM) for:

- Voltage detection
- Phase comparison
- Interface test
- Integrated self-test
- Indication via LED.

R-HA41-ORION-3-1.tif



#### Phase comparison test unit make Horstmann, type ORION 3.1

as combined test unit (HR and LRM) for:

- Phase comparison
- Interface testing at the switchgear
- Voltage detection
- Integrated self-test
- Indication via LED and acoustic alarm
- Phase sequence indication.

R-HA41-CAP-Phase.eps



#### Phase comparison test unit make Kries, type CAP-Phase

as combined test unit (HR and LRM) for:

- Voltage detection
- Repeat test
- Phase comparison
- Phase sequence test
- Self-test.

The unit does not require a battery.

R-HA41-ORION-M-1.tif



#### Phase comparison test unit make Horstmann, type ORION M1

as combined test unit (HR and LRM) for:

- Voltage detection
- Phase comparison
- Interface testing at the switchgear
- Integrated self-test
- Indication via display and acoustic alarm
- Phase sequence indication and status LED
- Measurement of interface current up to 25  $\mu$ A
- Measurement of phase angle from  $-180^\circ$  to  $+180^\circ$
- Measurement of harmonics up to 40<sup>th</sup> harmonic
- Securing the measured values via PC software (ORION explorer) and USB.



# Components

Indicating and measuring equipment

## Short-circuit/earth-fault indicators make Horstmann

Short-circuit/earth-fault indicator (option)  
Ring-main, cable and circuit-breaker feeders can optionally be equipped with short-circuit or earth-fault indicators in different designs. The equipment features are shown in the table on page 57.

Short-circuit and earth-fault indicators reduce the downtimes of a power system by delimiting the fault locations in medium-voltage systems.

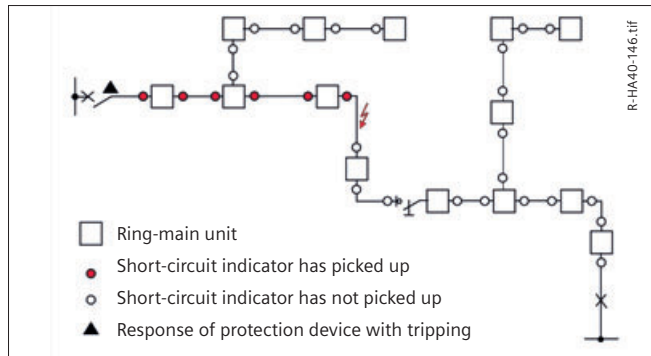

Short-circuit/earth-fault indicators can be used in all kinds of power systems. In impedance-earthed and solidly earthed systems, as well as in isolated and compensated (resonant-earthed) systems, earth-fault detection is also possible.

### SIGMA 2.0 with basic functions

- Adjustable pickup values
- Phase-selective fault indication
- Reset of the fault indication: manually, automatically, from remote
- Earth-fault detection in impedance-earthed or solidly earthed systems
- Remote indication with relay contacts.

### SIGMA D++ with directional function

- Directional short-circuit indication
- Directional earth-fault indication for all types of neutral treatment
- Unambiguous indication of the fault direction
- Monitoring with "SIGMA Explorer" software.

### ComPass B 2.0 with monitoring

- Voltage detection via WEGA voltage detecting system and resistive sensor system for up to 4 devices
- High-precision current and voltage measurement up to 0.5%
- Monitoring of the values: U, I, f, P, Q, S, E, cos φ, load flow direction, power meter with direction
- Temperature measurement with PT100
- Limit value recording for U, I, P, Q, T
- Transfer of measured values, fault indications and events via RS485/MODBUS.

### ComPass Bs 2.0 with control function

- Remote control of a switch-disconnector or circuit-breaker
- Freely programmable logic to define the switching conditions
- 6 binary inputs for recording relevant state information from the switchgear/substation.





Short-circuit/ earth-fault indicators Horstmann	ALPHA M ALPHA E	SIGMA 2.0 SIGMA 2.0 AC/DC	SIGMA F+E 2.0 SIGMA F+E 2.0 AC/DC	SIGMA F+E 3 2.0 SIGMA F+E 3 2.0 AC/DC	SIGMA D	SIGMA D+	SIGMA D++	ComPass A 2.0	ComPass B 2.0	ComPass Bs 2.0	Earth Zero- EarthZeroFlag
<b>Function</b>											
Short circuit/earth fault	■ / ■	■ / ■	■ / ■	■ / ■	■ / ■	■ / ■	■ / ■	■ / ■	■ / ■	■ / ■	- / ■
Direction indication	-	-	-	-	■	■	■	-	■	■	-
Monitoring: U, I, f, P, Q, S, E, cos φ, load flow direction	-	-	-	-	-	-	-	■	■	■	-
Control of a CB or SD	-	-	-	-	-	-	-	-	-	■	-
Logic	-	-	-	-	-	-	-	-	-	■	-
<b>Applicable for the following neutral treatments</b>											
Impedance earthed	■	■	■	■	■	■	■	■	■	■	■
Solidly earthed	■	■	■	■	■	■	■	■	■	■	■
Isolated	■	■	■	■	■	■	■	■	■	■	-
Compensated	■	■	■	■	■	■	■	■	■	■	-
<b>Short-circuit pickup values</b>											
I>> Short-circuit current	400, 600, 800, 1000 A	200, 300, 400, 600, 800, 1000, 2000 A, self-adjustment			DIP: 200, 300, 400, 600, 800, 2000 A, self-adjustment Software (SW): 50 – 2000 A			20 – 2000 A		-	
tI>> Pickup delay	100 ms	40, 80 ms	40, 80, 200, 300 ms		DIP: 40, 80 ms, Software (SW): 40 ms – 60 s			40 ms – 60 s		-	
<b>Earth-fault pickup values</b>											
IES> Short-circuit-to-earth current	-	-	20, 40, 60, 80, 100, 120 or 160 A		DIP: off, 20, 40, 60, 80, 100, 120, 160 A, Software (SW): 20 – 1000 A			20 – 1000 A		25, 50, 75, 100 A	
IET> Transient earth fault	-	-	-	-	-	10 – 100 A	10 – 500 A	-	10 – 500 A	-	
IEP> Active residual current cos φ	-	-	-	-	-	5 – 200 A	5 – 200 A	-	1 – 200 A	-	
IEQ> Reactive current sin φ	-	-	-	-	-	5 – 200 A	5 – 200 A	-	1 – 200 A	-	
UNE> Permanent earth fault	-	-	-	-	-	-	-	-	1 – 100 %	-	
ΔIE> Pulse location (pulse amplitude)	-	-	-	■	-	1 – 100 A	1 – 100 A	1 – 200 A		-	
Pickup delay	-	-	80, 200 ms	60, 80, 200, 300 ms	DIP: 80, 160 ms, Software (SW): 40 ms – 60 s			40 ms – 60 s		80, 160 ms	
<b>Reset</b>											
Manually / from remote	■ / - (M) ■ / ■ (E)	■ / ■	■ / ■	■ / ■	■ / ■	■ / ■	■ / ■	■ / ■	■ / ■	■ / ■	■ / -
Auto. time reset	■ (E)	■	■	■	■	■	■	■	■	■	■
Current / voltage recovery	-	-	-	■ / -	■ / ■	■ / ■	■ / ■	■ / -	■ / ■	■ / ■	- / ■
<b>Test</b>											
Manually / from remote	■ / -	■ / ■	■ / ■	■ / ■	■ / ■	■ / ■	■ / ■	■ / ■	■	■	■ / -
<b>Communication</b>											
Relay contact	1	1	2	3	4	4	4	4	4	4	1
Maintained/passing contact	adjustable	adjustable			adjustable			adjustable		adjustable	
RS485 / MODBUS-RTU	-	-	-	-	-	-	-	■	■	■	-
USB connection	-	-	-	-	■	■	■	■	■	■	-
<b>Parameterizing</b>											
Manually / from remote	■ / -	■ / -	■ / -	■ / -	■ / -	■ / -	■ / -	■ / ■	■ / ■	■ / ■	■ / -
<b>Supply</b>											
Lithium cell, ≥ 20 years	■ (E)	■ / Capacitor (AC / DC)			■	■	■	■	■	■	■
Current-transformer operated	■	■	■	■	■	■	■ (not IET>)	-	-	-	■
External auxiliary voltage	-	24 – 230 V AC / DC (only AC / DC versions)		24 – 230 V AC / DC (SIGMA F+E3 2.0 optional)	-	24 V AC, 24 – 60 V DC (possible)	24 – 230 V AC / DC (for IET>)	24 – 230 V AC / DC		-	
<b>Binary inputs</b>											
Number	2	2	2	2	2	2	2	2	2	6	-
<b>Current inputs</b>											
Phase current	3	3	3	3	3	3	3	3	3 or 2	0	
Summation current	0	0	0	0	0	0 or 1	0 or 1	0	0 or 1	1	
<b>Voltage inputs</b>											
Capacitive	-	-	-	-	■	■	■	-	■	■	-
Resistive	-	-	-	-	-	-	-	-	■	■	-

# Components

## Indicating and measuring equipment

### Short-circuit / short-circuit-to-earth and earth-fault indicators, make Kries

Ring-main, cable and circuit-breaker feeders can optionally be equipped with short-circuit or earth-fault indicators in different designs. The equipment features are shown in the table on page 59.

The three most common types of faults in medium-voltage systems are earth faults in cables and switchgear, faults and overloads of distribution transformers, as well as short circuits in cables and switchgear. For fast fault location and minimization of downtimes, electronic fault indicators are used:

- Selective fault detection, and thus minimization of downtimes
- Reliable fault detection through electronic measured-value acquisition
- Remote indication of fault events and measured values.

#### Short-circuit and short-circuit-to-earth indicator IKI-20

- Universally adjustable
- Current-transformer supported battery version or auxiliary voltage versions available
- Extended commissioning and testing functions.

#### Short-circuit and earth-fault indicator IKI-20PULS

- Short-circuit detection same as IKI-20
- Earth-fault detection via pulse location in compensated systems.

#### Short-circuit and earth-fault indicator IKI-20C(PULS)

- Current-transformer operated (No battery, no auxiliary voltage)
- Optionally with pulse location for earth-fault detection in compensated systems.

#### Directional short-circuit and earth-fault indicator IKI-22

- Directional fault detection for all system types
- Directional detection combined with the voltage detecting system CAPDIS-Sx+.

#### Grid-Inspector IKI-50

- Directional measured-value acquisition
- Monitoring of values U, I, f, P, Q, S, E, cos  $\varphi$ , power factor, load flow direction (momentary value, mean value and min/max value directional)
- Directional fault detection for all system types
- Switchgear control or automation through an integrated, programmable logic component
- Directional detection combined with the voltage detecting system CAPDIS-Sx+.

#### Options:

- One device controls two cable panels and the load flow total
- Directional detection combined with resistor dividers (accuracy 1.0%)
- Early fault detection and detection of intermittent earth faults
- Telecontrol interface according to IEC 60870-5-104.

#### Short-circuit-to-earth indicator IKI-10light

- Earth-fault detection in systems with impedance-earthed neutral or temporarily impedance-earthed neutral
- Adjustable.



Short-circuit/ earth-fault indicators Kries	IKI-20B	IKI-20T	IKI-20U	IKI-20PULS	IKI-20C	IKI-20CPULS	IKI-22	IKI-50_1F	IKI-50_1F_EW_PULS	IKI-50_2F	IKI-50_2F_EW_PULS	IKI-10-light-P	
<b>Function</b>													
Short-circuit indication	■	■	■	■	■	■	■	■	■	■	■	■	
Earth-fault indication				■		■	■	■	■	■	■		
Short-circuit-to-earth indication <sup>5)</sup>	■	■	■		■		■	■	■	■	■	■	
Direction indication							■	■	■	■	■		
<b>Applicable for the following neutral earthing options</b>													
Impedance	■	■	■		■		■	■	■	■	■	■	
Solid	■	■	■		■		■	■	■	■	■	■	
Isolated	■	■	■		■	■	■	■	■	■	■		
Compensated	■	■	■	■	■		■	■	■	■	■		
<b>Pickup current</b>													
Short-circuit current	100, 200, 400, 600, 800, 1000, 2000 A				400, 600, 800, 1000 A		100, 200, 300, 400, 600, 800, 1000, 2000 A		100 ... 1000 A (steps of 100 A)				
Earth-fault current							Transient fault detection		4 ... 30 A (steps of 1 A)				
Short-circuit-to-earth current <sup>5)</sup>	40, 80, 100, 150 A						40, 80, 100, 200 A		40 ... 200 A (steps of 10 A)		20, 40, 60, 80 A		
Pulse location				■		■			■		■		
<b>Pickup time</b>													
Short-circuit current	60, 80, 150, 200 ms				100 ms		60, 80, 150, 200 ms		60 – 1600 ms				
Short-circuit-to-earth current <sup>5)</sup>	60, 80, 150, 200 ms				100 ms		60, 80, 150, 200 ms		60 – 1600 ms		70, 250 ms		
Earth-fault current				Pulse location		Pulse location	Transient fault detection		400 – 3000 ms				
<b>Reset</b>													
Manual	■	■	■	■	■	■	■	■	■	■	■	■	
Automatic	■	■	■	■	■	■	■	■	■	■	■	■	
From remote	■	■	■	■			■	■	■	■	■	■	
<b>Remote indication</b>													
Passing contact	adjustable				■	■	■	adjustable					
Maintained contact	adjustable							adjustable					
<b>Interface</b>													
RS485/MODBUS								■	■	■	■		
IEC 60870-5-104 (option)								■	■	■	■		
<b>Power supply</b>													
Lithium battery	■						■					■	
External auxiliary voltage		■	■	■			Only for transient fault detection	Buffered for 6 h by internal capacitor				■	
<b>Current inputs</b>													
Phase current	3	3	3	3	3	3	3	3	3	6	6	–	
Summation current	1	1	1	1		1		1 <sup>1)</sup>	0 <sup>2)</sup>	0 <sup>2)</sup>	0 <sup>2)</sup>	1	
<b>Voltage inputs</b>													
Capacitive							3	3	3	6	6	–	
Resistive (option)							–	3	3	6	6	–	
<b>Release outputs</b>													
Potential-free	1 – 3	1 – 3	1 – 3	1 – 3	2	2	4	4	4	4	4	1	
Supplied by internal capacitor (option)								2 <sup>3)</sup>	2 <sup>3)</sup>	2 <sup>3)</sup>	2 <sup>3)</sup>		
<b>Binary inputs</b>													
Number	2 (test + reset)						2 (test + reset)		4	4	4	4	–

- 1) Optional for wattmetric detection of earth-fault direction
- 2) Creation of sum signal via 3 transformers mounted around the conductor
- 3) 0.1 Ws, 24 V DC
- 4) Momentary value, mean value and min / max value directional
- 5) Short-circuit to earth = Earth fault in impedance-earthed system

# Components

On request: Indicating and measuring equipment

Short-circuit/earth-fault indicator Siemens	SICAM FCM	SICAM FPI
<b>Function</b>		
Short-circuit indication	■	■
Earth-fault indication	■	■
Earth-fault function (impedance-earthed system)	■	■
Indication of direction, short-circuit / earth-fault	■	–
Undervoltage and overvoltage indication	■	–
<b>Applicable for the following neutral earthing options</b>		
Impedance	■	■
Solid	■	■
Isolated	■	■
Compensated	■	■
<b>Pickup current</b>		
Short-circuit current	50 ... 2000 A (steps of 1 A)	Type 1: 200 – 1200 A, Type 2: 200 – 800 A (in 7 steps each)
Earth-fault current	1 ... 1000 A (steps of 1 A)	Type 1: 10 – 100 A, Type 2: 40 – 300 A (in 7 steps each)
Pulse location	–	–
<b>Pickup time</b>		
Short-circuit current	40 ms < t < 60 s	< 500 ms adjustable
Earth-fault current	40 ms < t < 60 s	< 500 ms adjustable
<b>Reset</b>		
Manual	■	■
Automatic	■	■
From remote	■	■
<b>Remote indication</b>		
Passing contact	adjustable	–
Maintained contact	adjustable	2 binary outputs
<b>Interface</b>		
RS485 / MODBUS	■	–
<b>Power supply</b>		
Lithium battery	■	■
External auxiliary voltage	■	–
<b>Current inputs</b>		
Phase current	3 (2) <sup>1)</sup>	3 optical
Summation current	0 (1) <sup>1)</sup>	1 optical
<b>Voltage inputs</b>		
Via resistor divider	3	–
Via integrated capacitive voltage indicator (optional)	3	–
<b>Relay outputs</b>		
Potential-free	2 <sup>2)</sup>	2
<b>Binary inputs</b>		
Number	1	–



## SICAM FCM

The short-circuit and earth-fault indicator SICAM FCM (Feeder Condition Monitor) with direction indication enables fast and precise fault location, thus reducing the downtimes in the power system. The possibility to determine and telecommunicate the values U, I, f, P, Q, S, E, cos φ and load flow direction supports efficient operational management and network planning.

- Usable in earthed, isolated and resonance-earthed systems
- Directional short-circuit and earth-fault detection
- Selective fault information with direction indication as a basis for “self-healing” applications
- Usable with current and voltage sensors according to IEC 60044 for precise measurement without calibration and adjustment to the primary values
- Alternatively usable with an integrated capacitive voltage detecting system
- Flexible earth-current detection as from 0.4 A
- Integrated MODBUS-RTU interface:
- Remote parameterization via SICAM A8000 and MODBUS
- Self-test function of the communication connection.

## SICAM FPI (Fault Passage Indicator)

- Detection of short circuits and earth faults
- Indication of phase and earth faults via 4 separate LEDs
- Enhanced diagnostics, self and sensor cable diagnostics is supported
- Configurable binary outputs, for remote indication to SCADA via RTU for faults and for diagnostics.



1) Measuring sensor 3+0 (summation current is calculated), measuring sensor 2+1 (phase L2 is calculated)

2) Optional

### Transformer monitor IKI-30 (make Kries)

Protection of distribution transformers with ratings that cannot or should not be protected with HV HRC fuses:

- Tripping in case of overload (delayed)
- Tripping when the short-circuit current arises.



Transformer monitor IKI-30

### Application

The transformer monitor IKI-30 is suitable for the following transformer ratings:

- Operating voltage 6 to 15 kV:  $\geq 160$  kVA to 2500 kVA
- Operating voltage 20 kV:  $\geq 250$  kVA to 7500 kVA.

### Features

- Current-transformer operated, alternatively auxiliary voltage 24 to 230 V AC/DC
- Current measurement through special ring-type sensors
- For low-energy magnetic release (0.02 Ws) on circuit-breaker type 2
- Optional for shunt release with circuit-breaker or switch-fuse combination (auxiliary voltage supply required)
- Mounting location
  - In the front operating mechanism box of the feeder panel
  - In the low-voltage compartment (option) of the circuit-breaker feeder
- Response performance
  - Definite-time overcurrent characteristic
  - Definite-time overcurrent characteristic for earth-fault protection
  - Inverse-time overcurrent characteristic
    - extremely inverse
    - normal inverse
  - Externally undelayed instantaneous tripping
- Self-test function
- Indication
  - LED indication for tripping (single flash: starting; double flash: tripping)
  - Reset after 2 h or automatically (after return of power) or manually with reset pushbutton
- Outputs for signals
  - Tripping signal: 1 NC (passing contact)
  - Starting signal: 1 NC (maintained contact during protection device pickup)
  - 1 watchdog to report internal device faults
- Input
  - Remote tripping signal
  - Instantaneous tripping.

### Time-fuse-link protection system

The time-fuse-link protection system in accordance with the TS 12-6 British ENA specification is a simple protection system for protection of medium-voltage transformers with circuit-breakers.

### Mode of operation

In undisturbed operation, the ring-core current transformers of the protection system are short-circuited on the secondary side via type XF low-voltage fuses. In the case of a fault, the fuses are tripped and commutate the secondary current directly on the tripping coil of the circuit-breaker. The switching device disconnects the fault. The selection of fuses is made based on the fuse protection table for the protection system.

### Application

- For Dyn transformers with a rated output
  - Operational voltage 6.6 kV:  $\leq 1000$  kVA
  - Operational voltage 11 kV:  $\leq 1250$  kVA
  - Additional values on request
- For short-circuit protection and earth-fault protection
- For circuit-breakers type 2 with specially-adapted low-energy releases
- Installation in the front operating mechanism box of the switchgear panel.

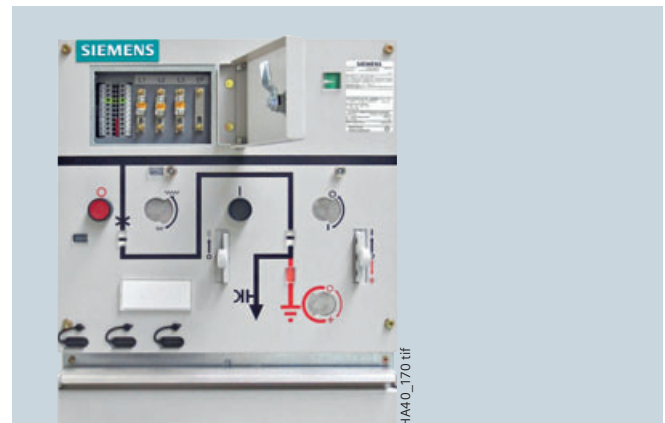

Time fuse link

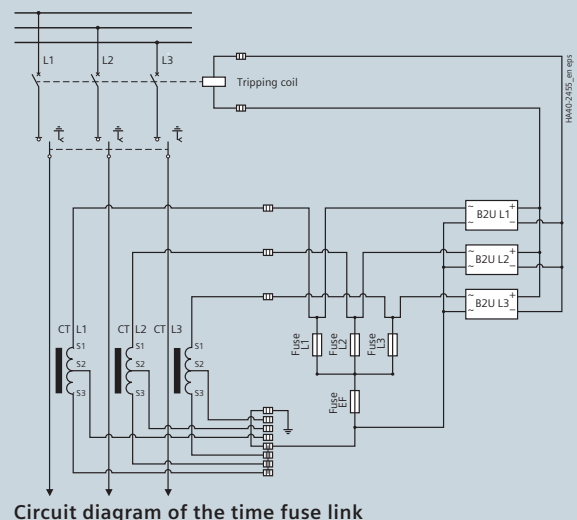

Circuit diagram of the time fuse link

# Components

Intelligent transformer substation

## Equipment examples for the switchgear

8DJH switchgear can be equipped with motor operating mechanisms, voltage detecting and measuring devices, short-circuit indicators, and further detection systems.

RTUs (Remote Terminal Units) can be optionally integrated inside the switchgear, in additional low-voltage compartments, or in a separate wall cubicle via a plug connection.

In this way, the switchgear fulfills all preconditions for integration in an intelligent network infrastructure. Depending on the purpose, different components for monitoring and control are used: These components can also be easily and quickly retrofitted at a later time. An equipment example for the switchgear is illustrated here.



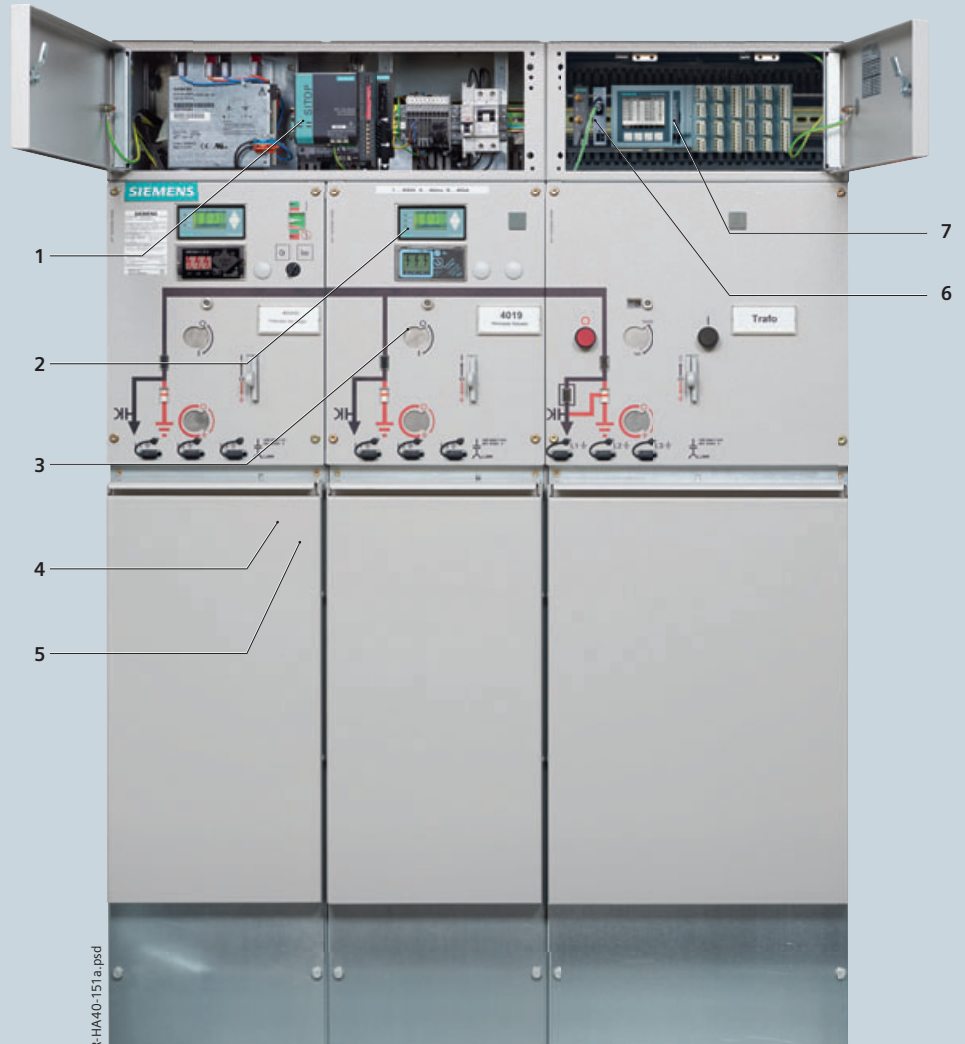

## The integration

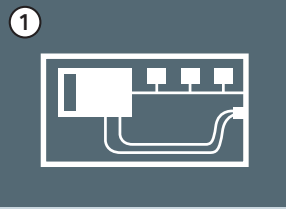
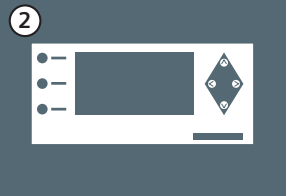

R-HA40-151a.psd

- 1 Uninterruptible power supply (UPS)
- 2 Intelligent SC indicators
- 3 Remotely controllable operating mechanisms
- 4 Current sensors
- 5 Voltage sensors
- 6 Communication modem
- 7 Remote terminal unit

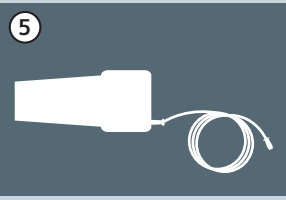

	Components	Function
	<p><b>Uninterruptible power supply (UPS)</b> Depending on the requested bridging time in case of power failures, an uninterruptible power supply based on battery or capacitor modules is used.</p>	<p>The task of the UPS is to continue to ensure the communication and/or the possibility to telecontrol the transformer substation in case of power failure.</p>
	<p><b>Intelligent SC indicators</b> Intelligent short-circuit and ground fault indicators with or without direction indication can be used in all grid types. For communication with the RTU, a Modbus RTU interface is available.</p>	<p>Intelligent short-circuit/ground fault direction indicators report short-circuits or ground faults in the medium-voltage distribution grid. Relevant measured values are acquired, allowing for an active load management in the distribution grid.</p>
	<p><b>Remotely controllable operating mechanisms</b> Motor operating mechanisms inside the ring-main unit are available in original equipment manufacturer quality. If required, retrofitting is easily possible.</p>	<p>In order to reduce the reclosing times in case of fault, the switch-disconnectors or circuit-breakers are equipped with motor operating mechanisms for remote control.</p>
	<p><b>Current sensors</b> Current sensors with low-power transformer technology are available as closed or divisible ring cores.</p>	<p>The current signal serves to detect short-circuits and ground faults, and can be used as a measured value for load flow control or for optimal utilization of the grid capacity.</p>
	<p><b>Voltage sensors</b> Voltage sensors as resistor dividers are available as cast-resin plugs for insertion into the cable T-plug.</p>	<p>The voltage signal serves to detect the direction of the short-circuit or ground fault, and can be used as a measured value for load flow control or voltage regulation.</p>
	<p><b>Communication modem</b> The selection of the communication modem to be used is determined by the selected or available telecommunication technology.</p>	<p>Communication modems are employed for safe data transmission from the remote terminal unit to the network control center using the selected telecommunication technology.</p>
	<p><b>Remote terminal unit</b> The remote terminal unit (RTU) is equipped with binary inputs and outputs, various communication interfaces, and freely programmable user programs.</p>	<p>Inside the intelligent transformer substation, the RTU serves as a connecting element to the network control center. It collects all relevant signals and receives control commands, or works autonomously according to predetermined control or regulation algorithms.</p>

# Components

## Protection systems

### Simple protection systems

As a simple protection for distribution transformers and circuit-breaker feeders, standard protection systems are available, consisting of:

- Current-transformer operated protection device with c.t.-operated release (low-energy 0.1 Ws)
  - Siemens SIPROTEC 7SJ45
  - Woodward/SEG WIC 1-2P, WIC 1-3P, WIP-1
- Protection device with auxiliary voltage supply with shunt release (f)
  - Siemens SIPROTEC 7SJ46
- Instrument transformer as
  - Cable-type current transformer (standard)
  - Three-phase current transformer as option for 8DJH switchgear panels L(500).

#### Mounting location

- In 200-mm-high top low-voltage unit (option) of the circuit-breaker feeder.

### Application of simple protection systems

Operating voltage (kV)	Transformer rating (kVA)	
	7SJ45/7SJ46	WIC 1-2P
6	≥ 160	≥ 160
10	≥ 200	≥ 250
13.8	≥ 250	≥ 400
15	≥ 315	≥ 400
20	≥ 400	≥ 500

### Multifunction protection (selection)

#### SIPROTEC Compact series, overcurrent protection SIPROTEC 7SJ80

- 9 programmable function keys
- 6-line display
- USB front port
- 2 additional communication ports
- IEC 61850 with integrated redundancy (electrical or optical).

#### SIPROTEC 5 series, overcurrent protection SIPROTEC 7SJ82

- Directional and non-directional time-overcurrent protection with additional functions
- Time optimization of the tripping times by directional comparison and protection data communication
- Frequency protection and rate-of-frequency-change protection for load shedding applications
- Overvoltage and undervoltage protection in all required variations
- Power protection, configurable as active or reactive power protection
- Control, synchrocheck and switchgear interlocking system
- Firmly integrated, electrical Ethernet port J for DIGSI
- Complete IEC 61850 (Reporting and GOOSE) via integrated port J
- Two optional, pluggable communication modules usable for different and redundant protocols (IEC 61850, IEC 60870-5-103, DNP3 (serial+TCP), Modbus RTU Slave, protection data communication).

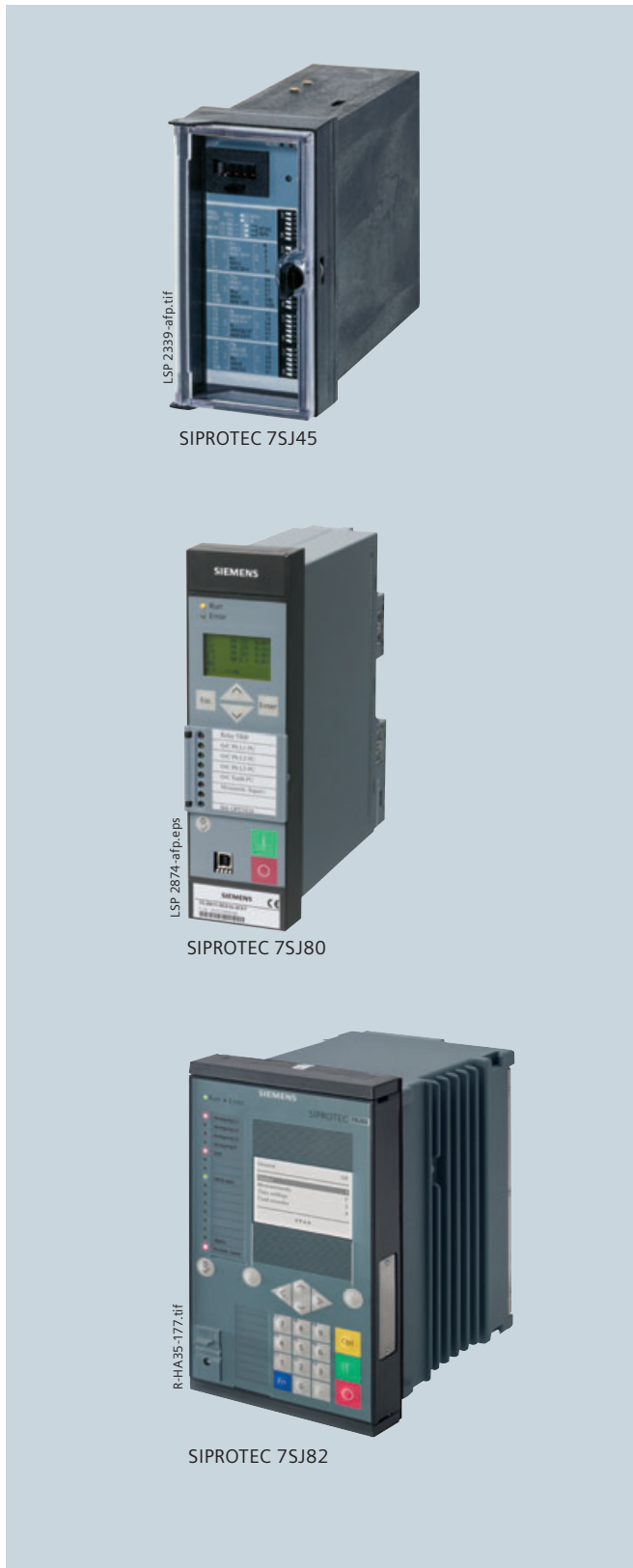

### Other types and makes on request

#### Mounting location

- In the 400 mm, 600 mm, or 900 mm high low-voltage compartment (option) of the circuit-breaker feeder.



### Features

- Overall heights
  - 200 mm, 400 mm, 600 mm, 900 mm
  - Option: Cover
- Partitioned safe-to-touch from the high-voltage part of the panel
- Installation on the panel:
  - Possible per feeder
  - Standard for circuit-breaker panels type L (1.1) and bus sectionalizer panels with circuit-breaker type V (1.1)
  - Option for all other panel types, depending on the scope of the secondary equipment
- Customer-specific equipment
  - For accommodation of protection, control, measuring and metering equipment
- Separate wiring duct on the switchgear beside the low-voltage compartment (option)
- Door with hinge on the left (standard for heights of 400, 600 and 900 mm).

### Low-voltage cables

- Control cables of the panel to the low-voltage compartment via multi-pole, coded module plug connectors
- Option: Plug-in bus wires from panel to panel in the separate wiring duct on the panel.

### Low-voltage niche

- Only inside billing metering panels type M
- For accommodation of options, e.g.:
  - Voltage transformer m.c.b.s
  - Small distribution fuse-box and fuse-links type Diazed or Neozed.

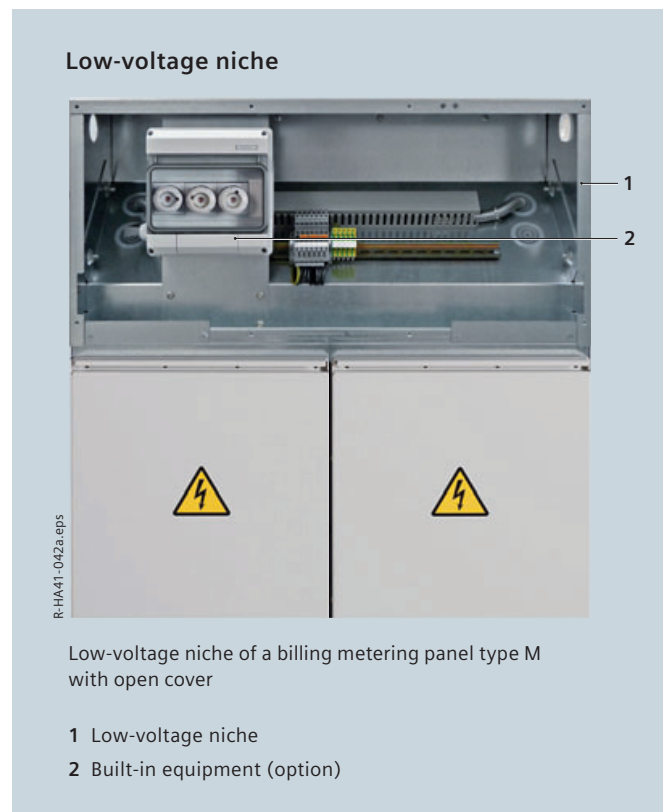
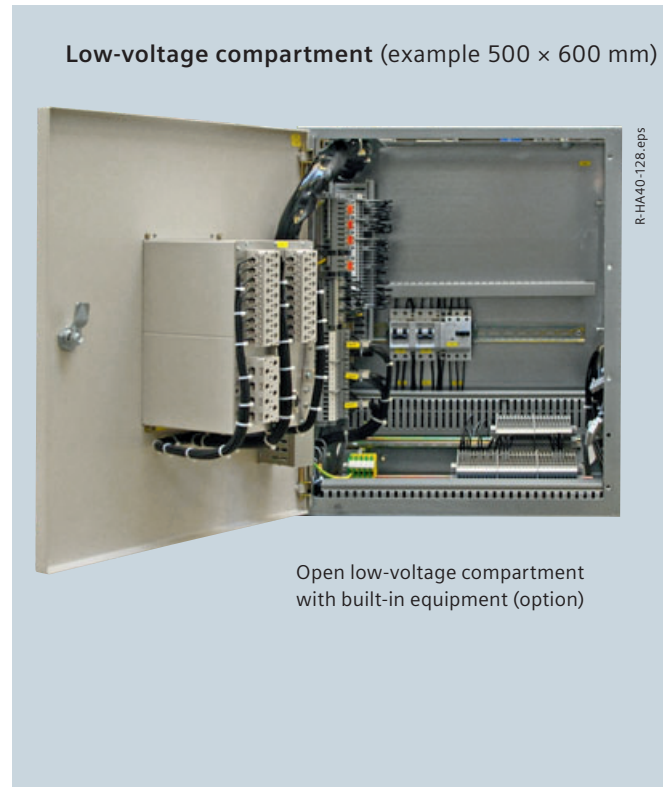

# Dimensions

## Room planning

Please observe the following for room planning and switchgear installation:

### Switchgear installation

Wall-standing arrangement

- 1 row
- 2 rows (for face-to-face arrangement)

Option: Free-standing arrangement.

### Pressure relief

The type of pressure relief selected has an effect on the switchgear depth, and places requirements on the size of the cable basement and /or the room height. In case of pressure relief upwards, the room heights reproduced in the type test are decisive for the internal arc classification acc. to IEC/EN 62271-200/VDE 0671-200 (see table on page 67).

### Door dimensions

The door dimensions have an influence on the size of the transport units (see page 87) and the factory assembly of panel groups, low-voltage compartments and pressure absorber systems. If required, this installation work can also be performed on site by the customer.

### Switchgear fixing

- For floor openings and fixing points of the switchgear, see pages 83 to 86
- Foundations:
  - Steel girder construction
  - Reinforced-concrete floor.

### Panel dimensions

See illustrations on pages 69 to 86.

### Weight

For data, see page 88.

### Local regulations and guidelines

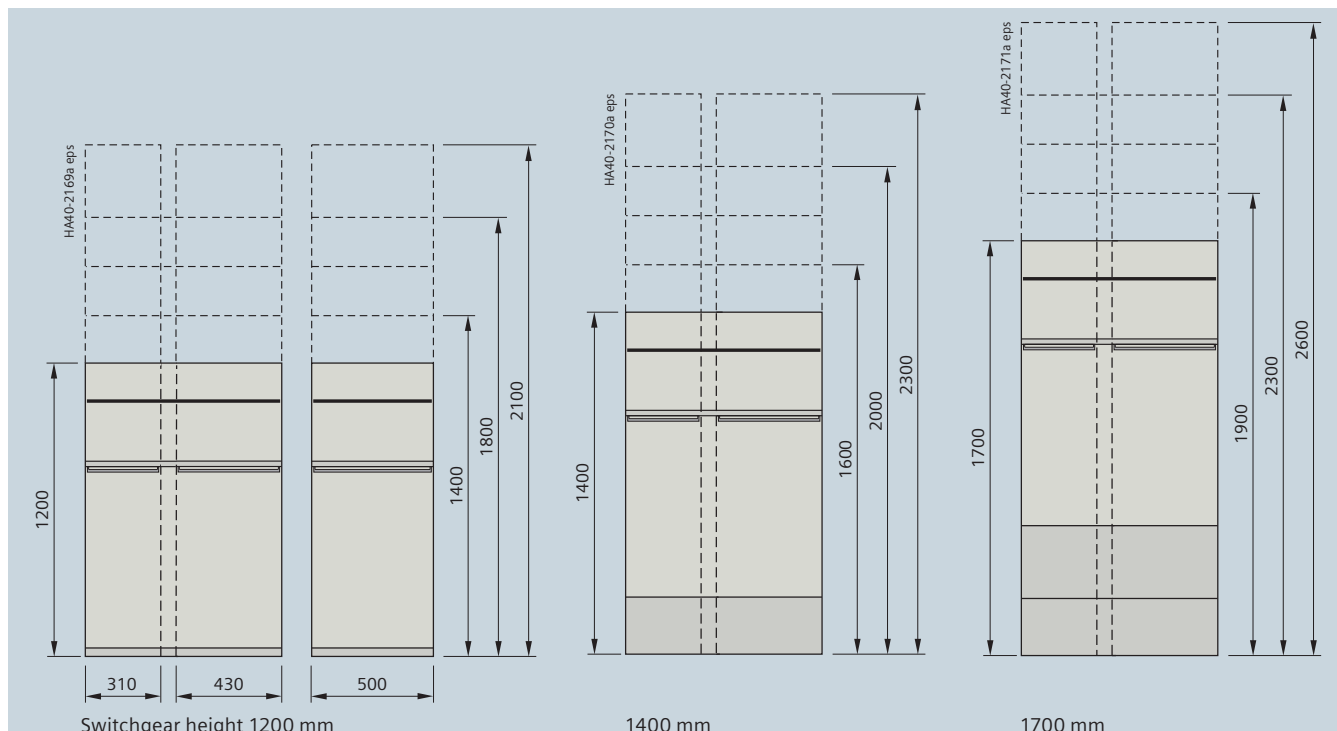
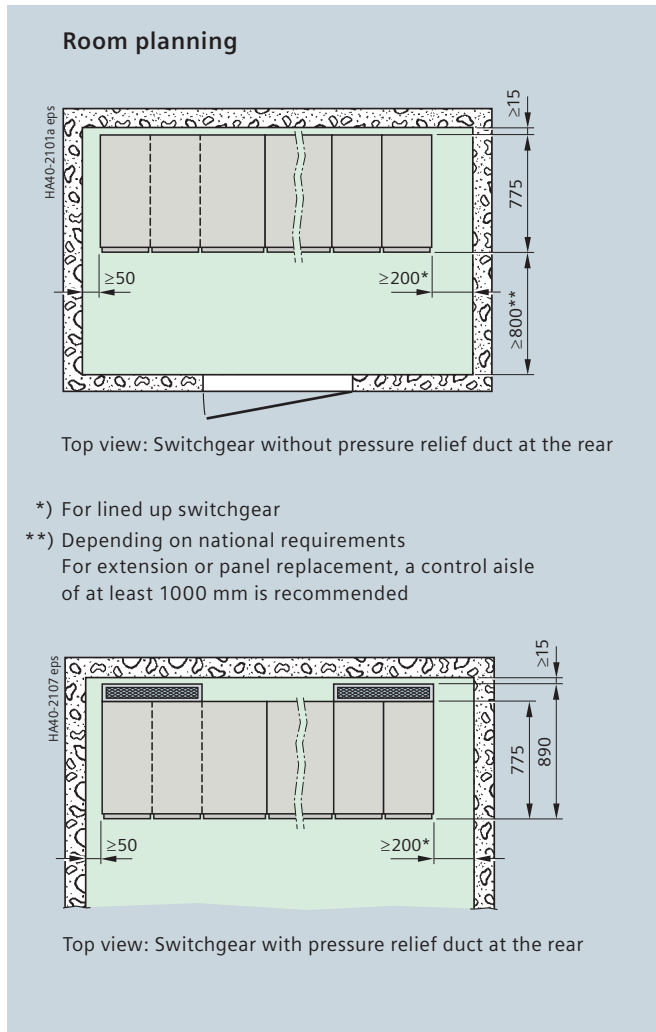

The following type-tested versions of the pressure relief system are available for 8DJH switchgear:

- Downwards into the cable basement (for individual panels and panel blocks, internal arc classification up to IAC A FL 21 kA /1 s or IAC A FLR 21 kA /1 s, minimum cross-section of the cable basement according to the illustration below)
- To the rear (for non-extendable panel blocks with 1400 or 1700 mm switchgear height, internal arc classification up to IAC A FL 21 kA /1 s, a rear pressure relief outlet with a minimum cross-section of 1 m<sup>2</sup> is required in the switchgear room and must be supplied by the site)
- Upwards through rear pressure relief duct (for extendable and non-extendable panel blocks, internal arc classification up to IAC A FL 16 kA /1 s, minimum room heights according to the table below), with pressure absorber system
- Upwards through base and rear pressure relief duct (for individual panels and panel blocks, internal arc classification up to IAC A FL 21 kA /1 s and IAC A FLR 21 kA /1 s, minimum room heights according to the table below), with pressure absorber system.

### Switchgear installation with pressure relief downwards (standard) or to the rear (option)

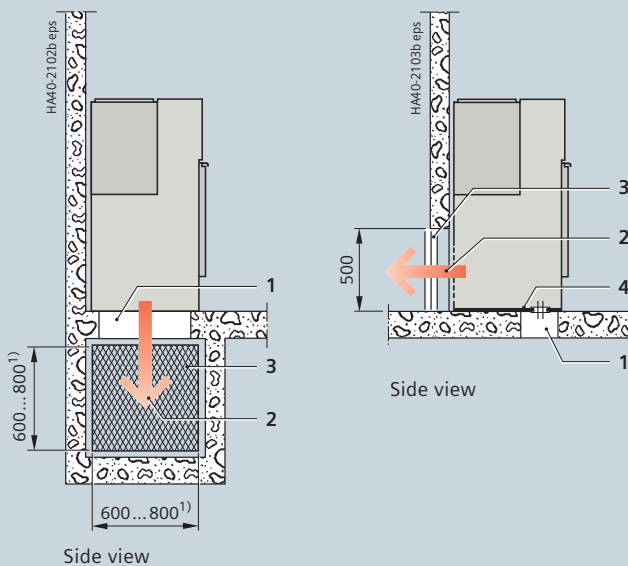

- 1 Floor opening
  - 2 Direction of pressure relief
  - 3 Expanded metal (supplied by site)
  - 4 Floor cover (divided plate for comfortable working at the cable connection)
  - 5 Pressure absorber system with pressure relief duct
- 1) Total opening minimum 0.48 m<sup>2</sup>

### Room heights for switchgear installation with pressure relief duct at the rear (design with or without base)

Switchgear height	Room height
1400 mm	≥ 2000 mm
1700, 1800 mm	≥ 2200 mm
2300 mm	≥ 2400 mm
2600 mm	≥ 2600 mm

### Switchgear installation with rear pressure relief duct (option) for panel block with IAC A FL or FLR up to 16 kA /1 s

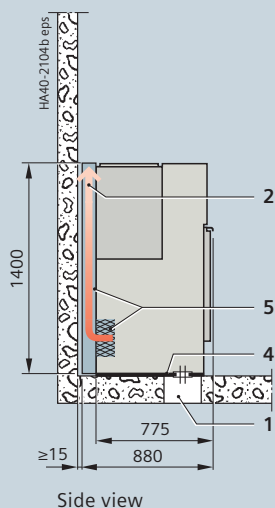

### Switchgear installation with base and rear pressure relief duct (option) for panel block with IAC A FL or FLR up to 21 kA /1 s

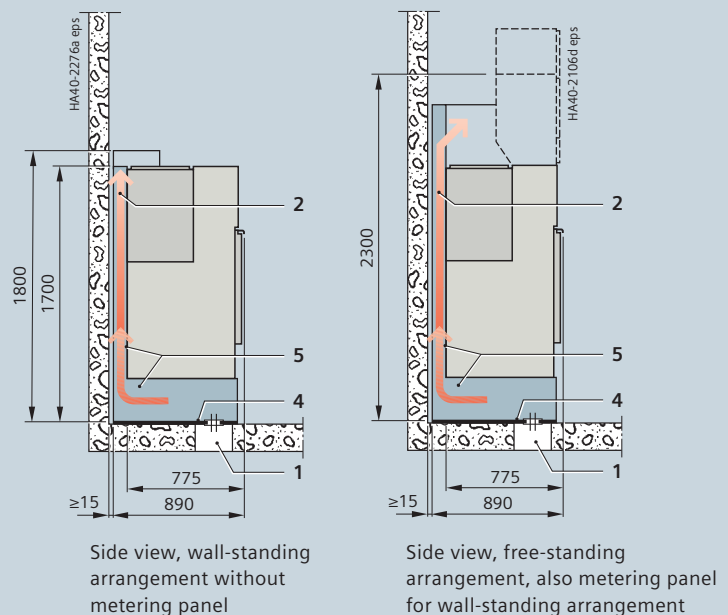

# Dimensions

## Room planning

For 8DJH Compact, the following types of pressure relief can be selected:

- Downwards into the cable basement for all feeders (internal arc classification up to IAC A FL or FLR 21 kA /1 s)
- Downwards into the cable basement for the ring-main feeders, and to the rear for the transformer feeders (internal arc classification up to IAC A F 21 kA /1 s).

The dimensions for wall distances, control aisles and cable basements correspond to those of the 8DJH Standard design. The pressure relief to the rear was tested with a rear wall distance of  $\geq 3$  m. This design is recommended for application in prefabricated substations without control aisle, with internal arcing test according to IEC 62271-202.

For 8DJH with outdoor enclosure (option), the direction of the pressure relief can be selected as follows:

- Downwards into the cable basement (internal arc classification up to IAC A FL or FLR 21 kA /1 s, minimum cross-section of the cable basement according to the illustration below)
- To the rear (internal arc classification up to IAC A FL 21 kA /1 s; for wall-standing arrangement, a rear pressure relief outlet with a minimum cross-section of 1 m<sup>2</sup> is required and must be supplied by the site)
- Upwards through rear pressure relief duct (internal arc classification up to IAC A FL or FLR 21 kA /1 s, free space above the switchgear 600 mm as a minimum).

The dimensions for wall distances, control aisles and cable basements correspond to those of the 8DJH Standard design. The outdoor enclosure is conceived for application on company ground.

**Switchgear installation for 8DJH Compact with pressure relief downwards for all feeders (standard)**

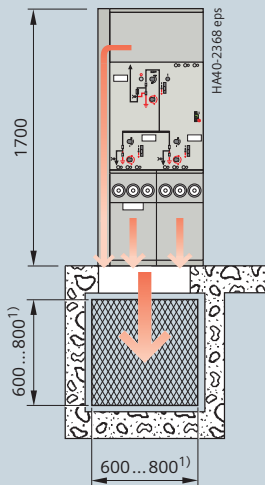

**Switchgear installation for 8DJH Compact with pressure relief downwards for the ring-main feeders, and to the rear for the transformer feeders (option)**

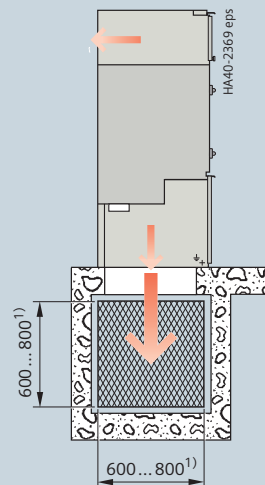

**Switchgear installation for outdoor enclosure with pressure relief downwards**

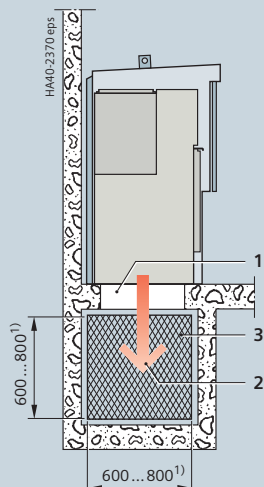

**Switchgear installation for outdoor enclosure with pressure relief to the rear or upwards through rear duct**

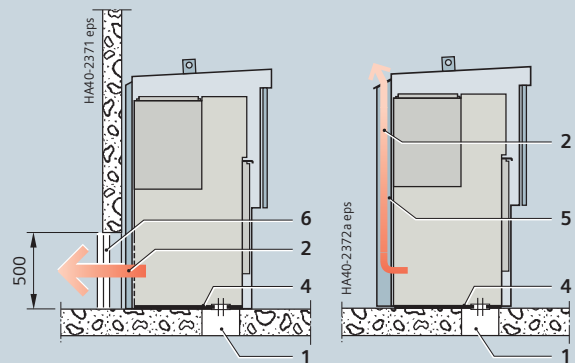

## Cable feeder type K

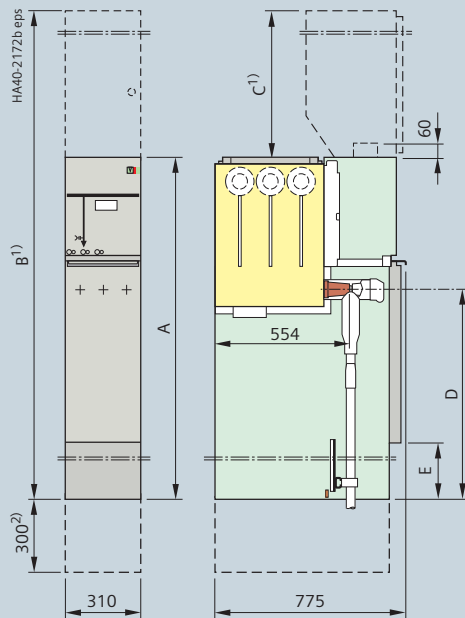

## Ring-main feeder type R

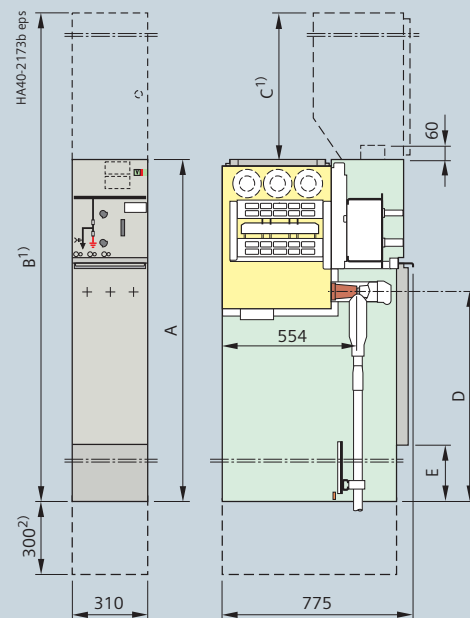

Switchgear height	without low-voltage compartment	A	1040 <sup>3)</sup>	1200	1400
	with low-voltage compartment <sup>1)</sup>	B	–	see page 67	
Low-voltage compartment <sup>1)</sup>		C	–	200, 400, 600 or 900	
Cable connection	Typical K and R	D	500	660	860
Base cover		E	32	32	232

1) Option: With low-voltage compartment

2) Base for switchgear height of 1700 mm, or absorber --> cable connection height = D + 300 mm

3) Only for panel blocks RR, RRR, RT, RRT and RTR

# Dimensions

Feeder panels (430 mm)

## Cable feeder type K(E) with make-proof earthing switch

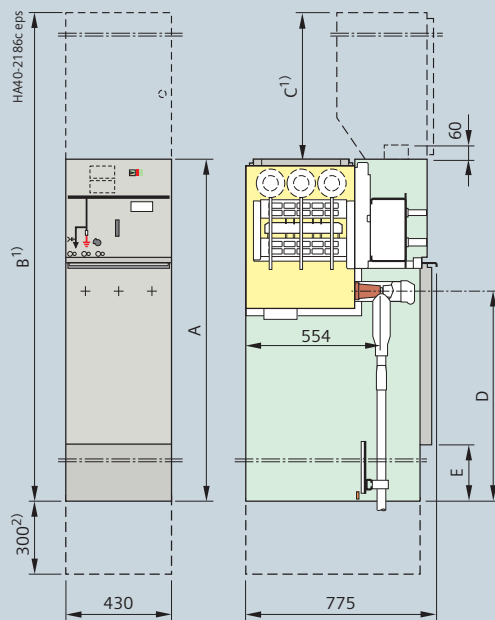

## Transformer feeder type T

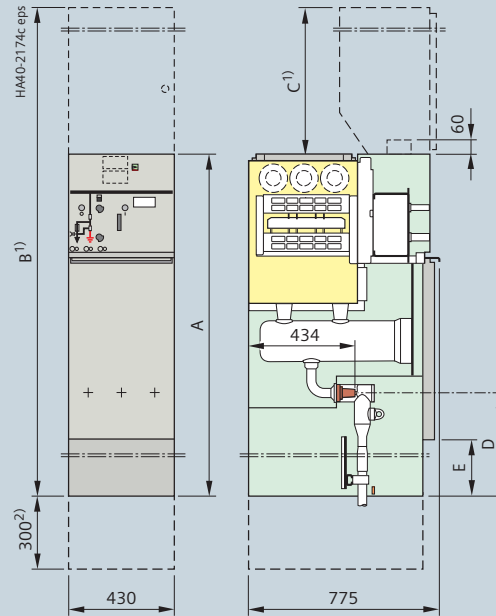

## Circuit-breaker feeder type L

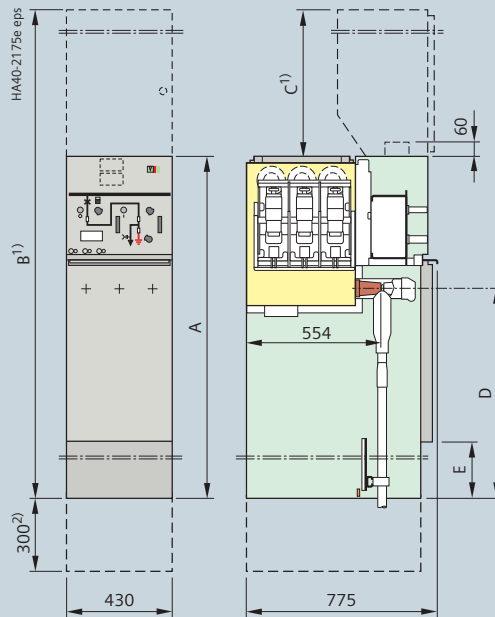

Switchgear height	without low-voltage compartment	A	1040 <sup>3)</sup>	1200	1400
	with low-voltage compartment <sup>1)</sup>	B	–	see page 67	
Low-voltage compartment <sup>1)</sup>		C	–	200, 400, 600 or 900	
Cable connection	Typical K(E), L	D	–	660	860
	Typical T		62	222	422
Base cover		E	32	32	232

1) Option: With low-voltage compartment

2) Base for switchgear height of 1700 mm, or absorber --> cable connection height = D + 300 mm

3) Only for panel blocks RR, RRR, RT, RRT and RTR

## Ring-main feeder type R(500)

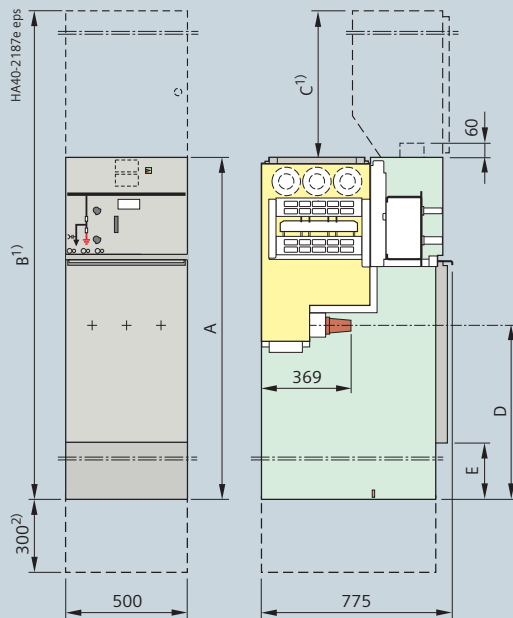

## Circuit-breaker feeder type L(500)

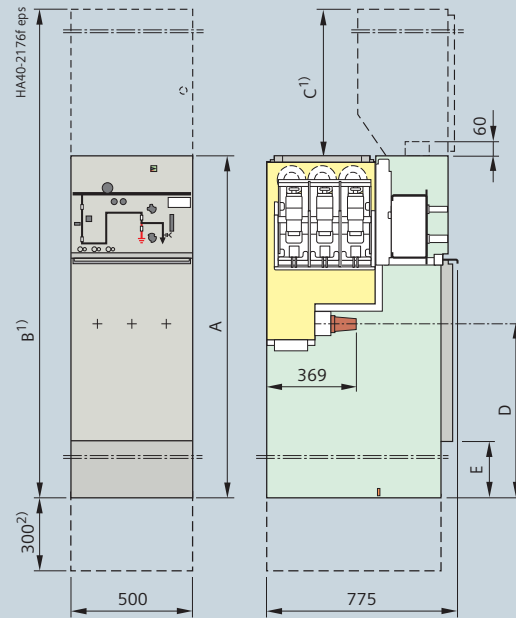

## Design option with busbar voltage transformer for all circuit-breaker types

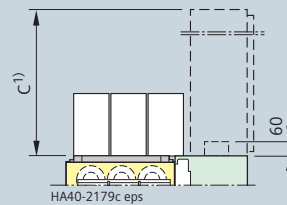

Switchgear height	without low-voltage compartment	A	1200	1400
	with low-voltage compartment <sup>1)</sup>	B	see page 67	
Low-voltage compartment <sup>1)</sup>		C	200, 400, 600 or 900	
Cable connection	Typical R(500), L(500)	D	510	710
Base cover		E	32	232

1) Option: With low-voltage compartment

2) Base for switchgear height of 1700 mm, or absorber --> cable connection height = D + 300 mm

# Dimensions

Bus sectionalizer panels with switch-disconnector

**Bus sectionalizer panel type S**  
with three-position switch-disconnector  
and earthing on the right

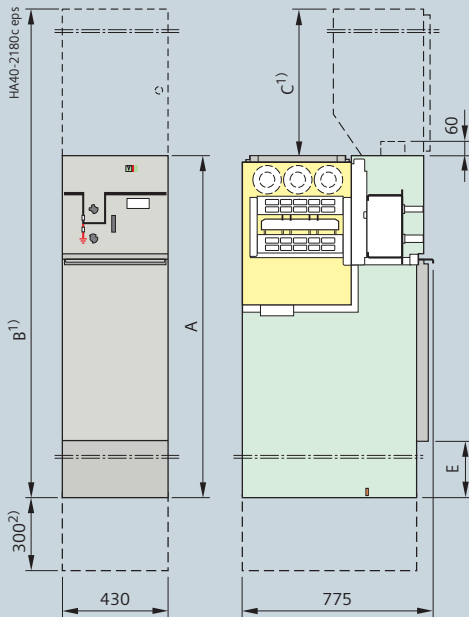

**Bus sectionalizer panel type S(500)**  
with three-position switch-disconnector  
and earthing on the right

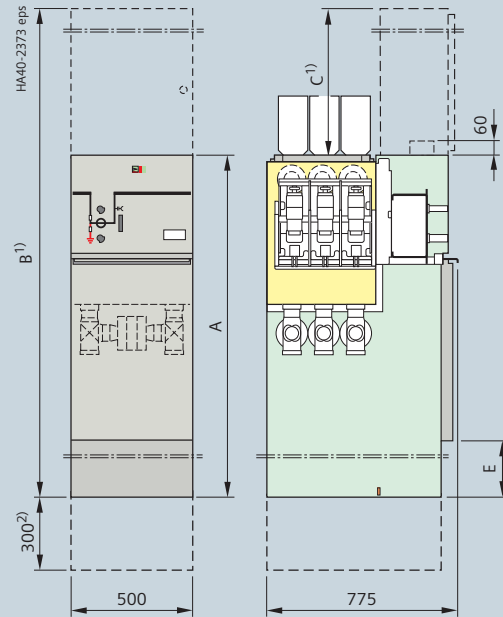

**Bus sectionalizer panel type S(620)**  
with three-position switch-disconnector  
and earthing on the left

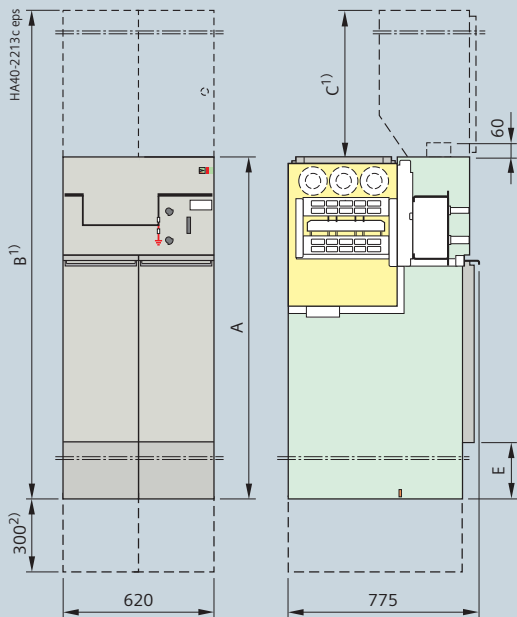

**Bus sectionalizer panel type H**  
with switch-disconnector / fuse combination

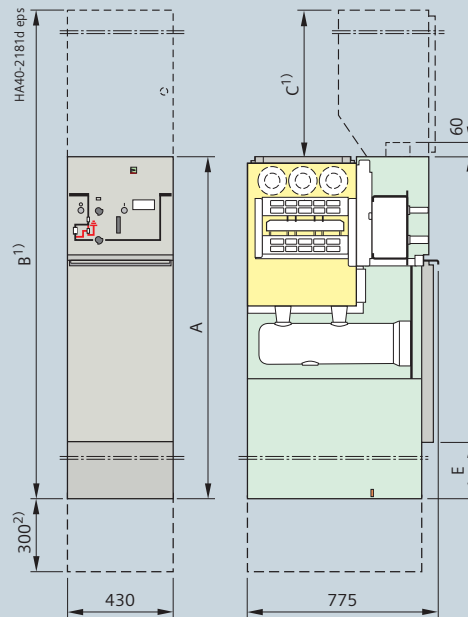

Switchgear height	without low-voltage compartment	A	1200	1400
	with low-voltage compartment <sup>1)</sup>	B	see page 67	
Low-voltage compartment <sup>1)</sup>		C	200, 400, 600 or 900	
Base cover		E	32	232

1) Option: With low-voltage compartment

2) Base for switchgear height of 1700 mm, or absorber



## Bus sectionalizer panel type V with circuit-breaker

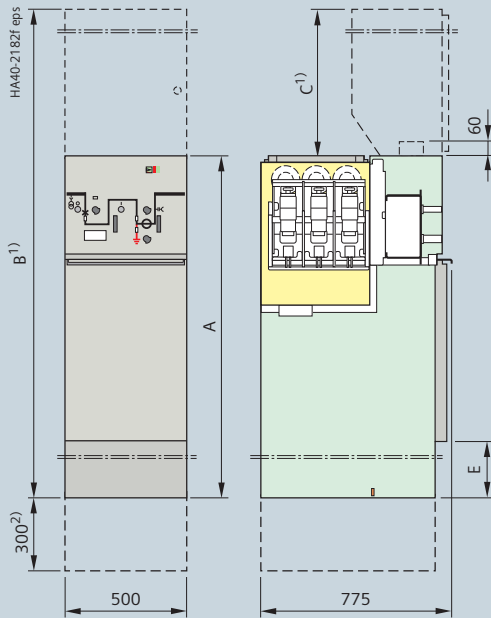

## Design options

with busbar voltage transformer and/or  
busbar current transformer

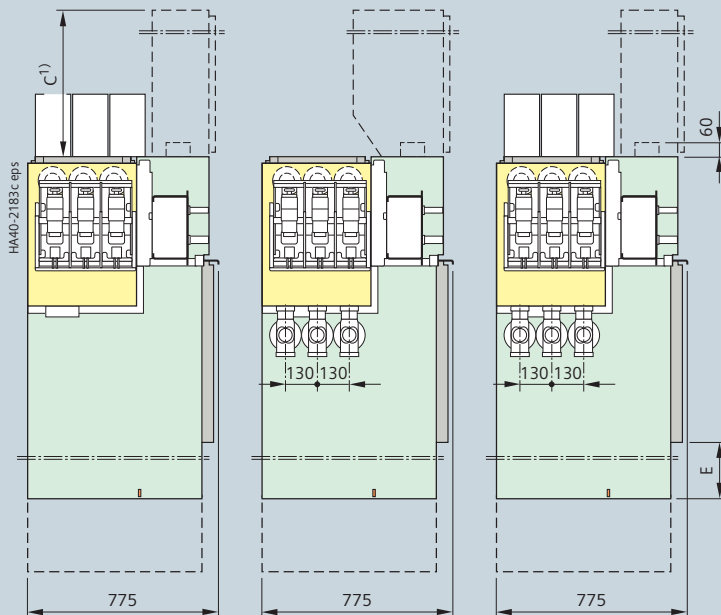

Switchgear height	without low-voltage compartment	A	1200	1400
	with low-voltage compartment <sup>1)</sup>	B	see page 67	
Low-voltage compartment <sup>1)</sup>		C	200, 400, 600 or 900	
Base cover		E	32	232

1) Option: With low-voltage compartment

2) Base for switchgear height of 1700 mm, or absorber

# Dimensions

Busbar earthing panels and busbar voltage metering panels

## Busbar earthing panel type E

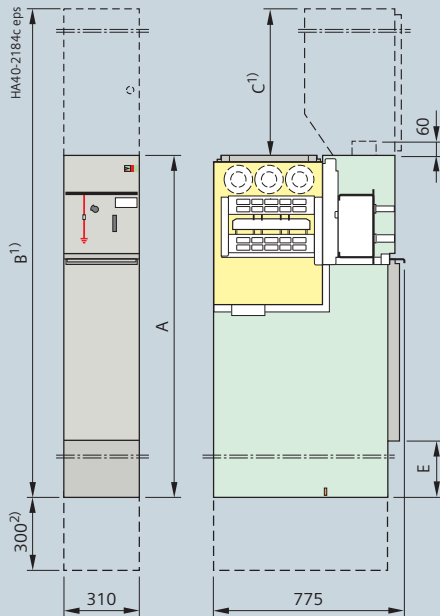

## Busbar earthing panel type E(500) with voltage transformer

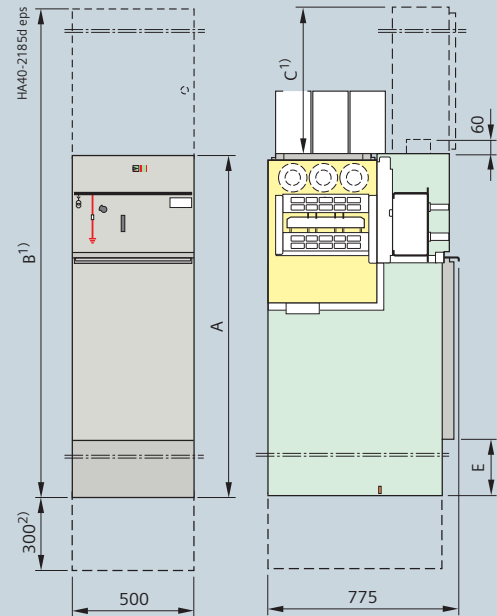

## Metering panel type M(500) with disconnectable voltage transformer

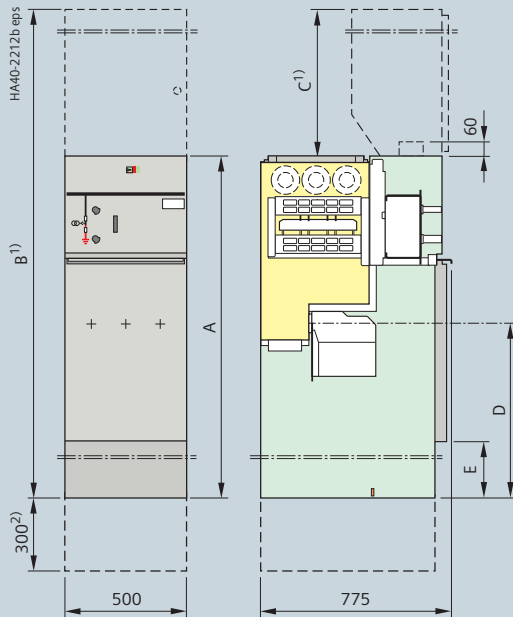

## Metering panel type M(430) with disconnectable voltage transformer fused on the primary side

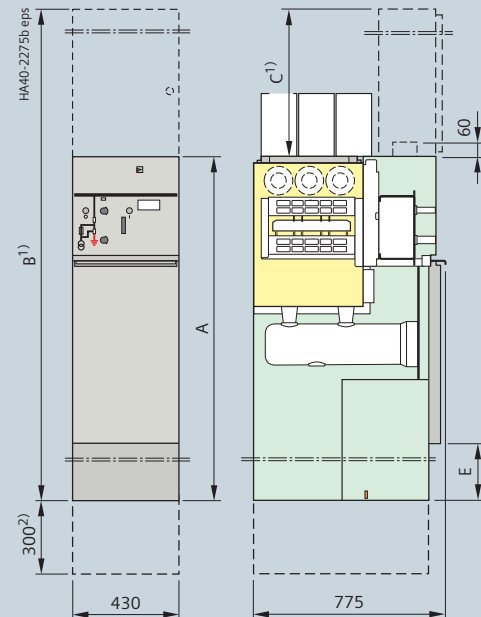

Switchgear height	without low-voltage compartment	A	1200	1400
	with low-voltage compartment <sup>1)</sup>	B	see page 67	
Low-voltage compartment <sup>1)</sup>		C	200, 400, 600 or 900	
Transformer connection	Typical M(500)	D	510	710
Base cover		E	32	232

1) Option: With low-voltage compartment

2) Base for switchgear height of 1700 mm, or absorber

# Dimensions

Billing metering panel as individual panel, air-insulated

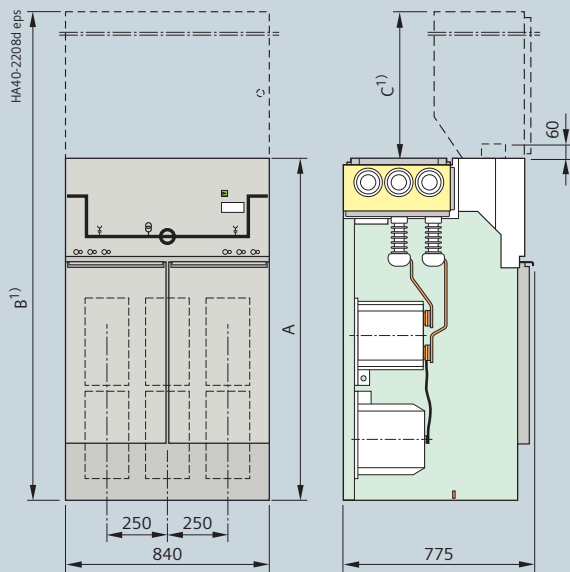

Connection: busbar – busbar

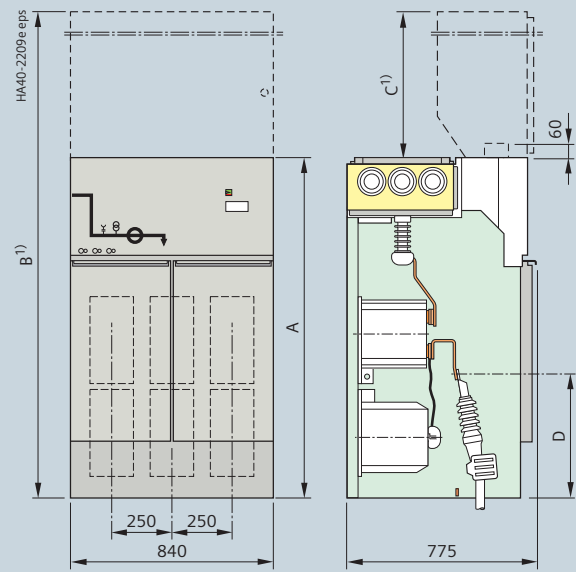

Connection: busbar on the left – cable on the right

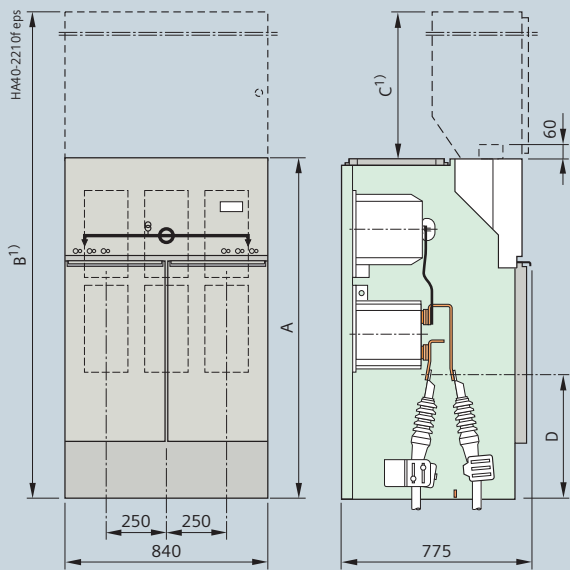

Connection: cable – cable

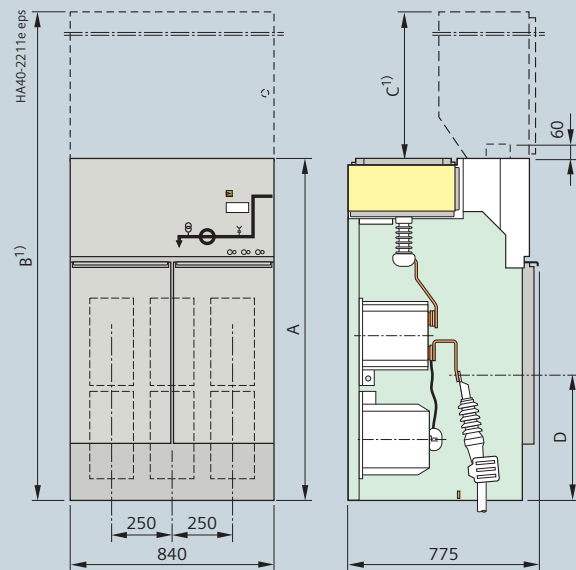

Connection: cable on the left – busbar on the right

Switchgear height	without low-voltage compartment	A	1400
	with low-voltage compartment <sup>1)</sup>	B	see page 67
Low-voltage compartment <sup>1)</sup>		C	200, 400, 600 or 900
Cable connection		D	515                      815

1) Option: With low-voltage compartment

# Dimensions

Panel blocks (preferred versions)

## Versions with transformer feeders

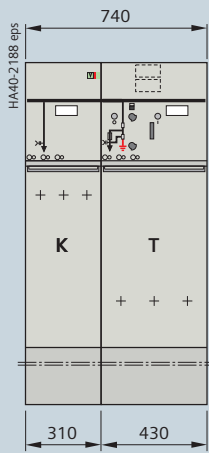

Panel block **KT**

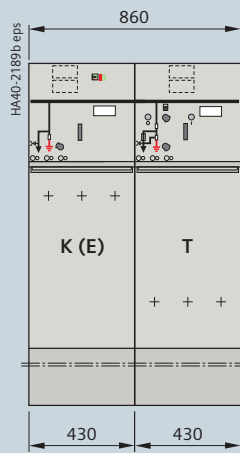

Panel block **K(E)T**

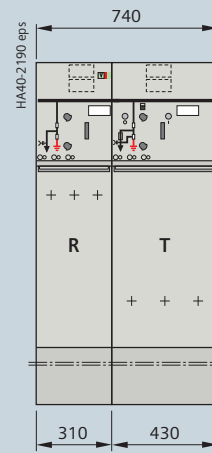

Panel block **RT**

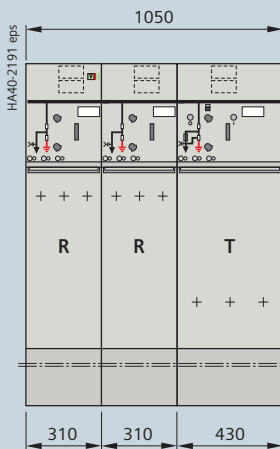

Panel block **RRT**

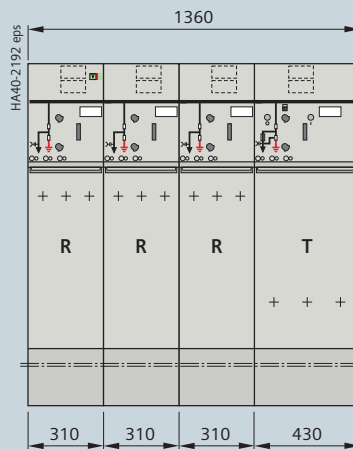

Panel block **RRRT**

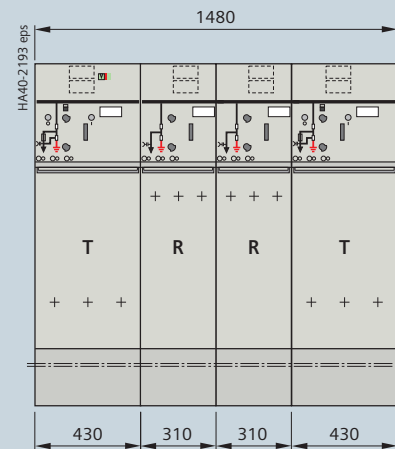

Panel block **TRRT**

For further dimension data,  
see individual panels on pages 69 and 70.

Overall height optionally 1200 mm, 1400 mm or 1700 mm.  
For floor openings and fixing points, see pages 83 to 86.

## Versions with circuit-breaker feeders

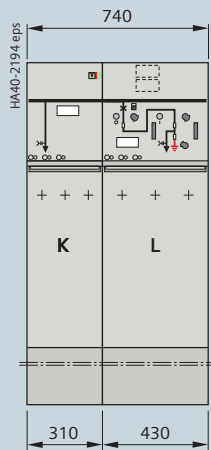

Panel block KL

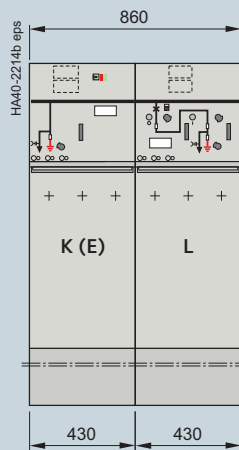

Panel block K(E)L

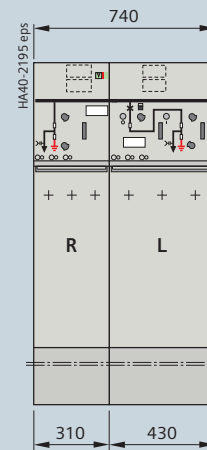

Panel block RL

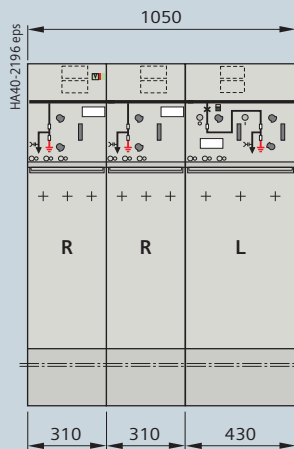

Panel block RRL

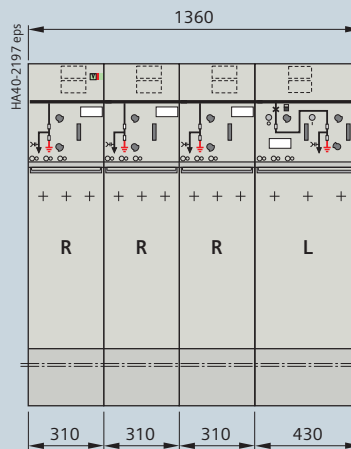

Panel block RRRL

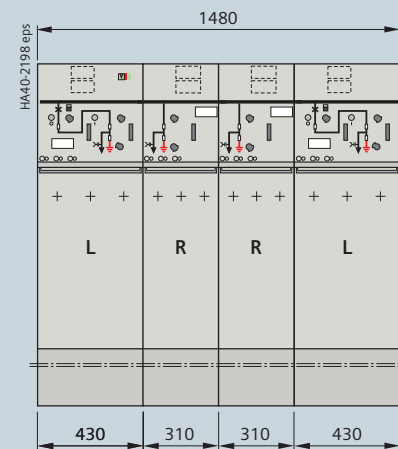

Panel block LRRL

For further dimension data,  
see individual panels on pages 69 and 70.

Overall height optionally 1200 mm, 1400 mm or 1700 mm.  
For floor openings and fixing points, see pages 83 to 86.

# Dimensions

Panel blocks (preferred versions)

## Further versions

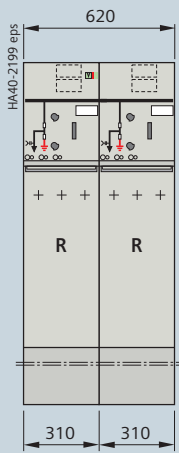

Panel block **RR**

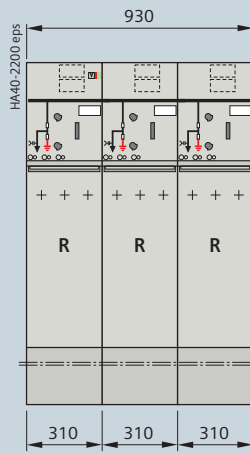

Panel block **RRR**

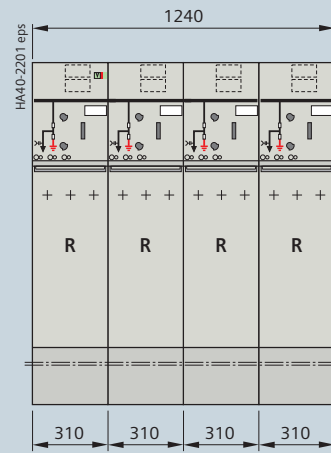

Panel block **RRRR**

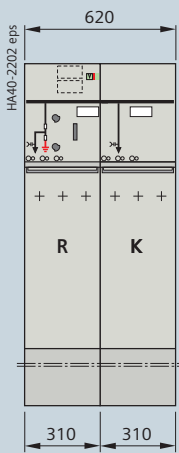

Panel block **RK**

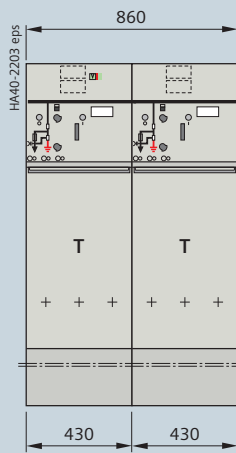

Panel block **TT**

For further dimension data,  
see individual panels on pages 69 and 70.

Overall height optionally 1200 mm, 1400 mm or 1700 mm.  
For floor openings and fixing points, see pages 83 to 86.

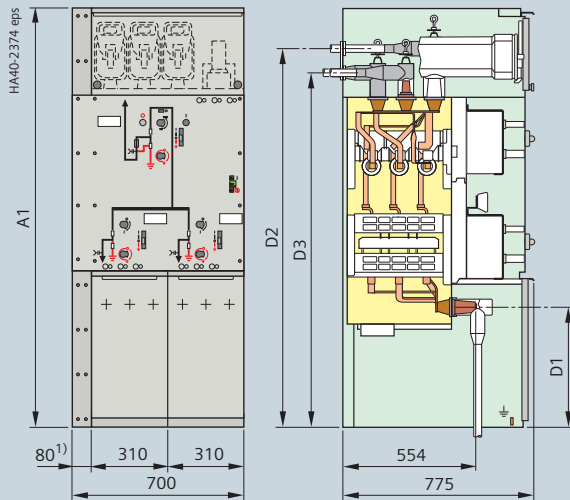

Panel block RRT Compact

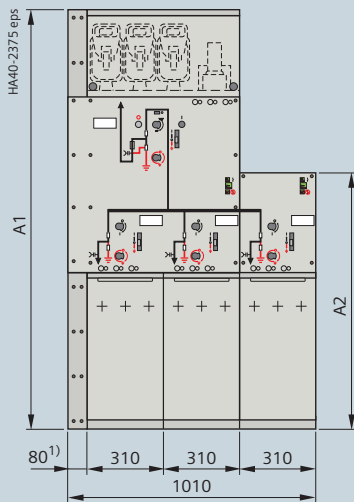

Panel block RRT-R Compact

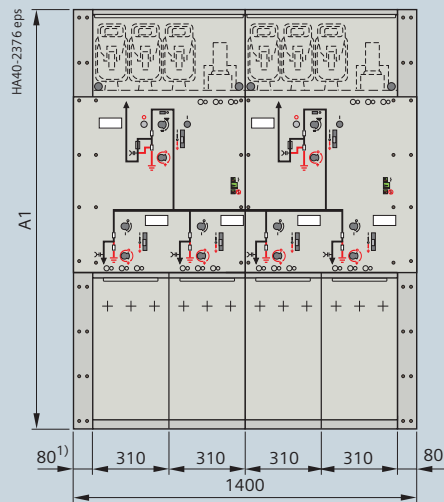

Panel block RRT-RRT Compact

Switchgear height		A <sub>1</sub>	1400	1700
		A <sub>2</sub>	740	1040
Cable connection	Typical R	D <sub>1</sub>	200	500
	Typical T	D <sub>2</sub>	1245	1545
		D <sub>3</sub>	1143	1443

1) Only for pressure relief downwards for all feeders (IAC A FLR up to 21 kA/1 s)

# Dimensions

Panel blocks (freely configurable)

## Panel blocks with common gas-filled vessel are possible for

- Up to 4 functions in one block
- Functions in 310 mm and 430 mm panel widths
- Functions R and T in any arrangement
- Functions R and L in any arrangement
- Optionally for overall heights 1200 mm, 1400 mm and 1700 mm

## Examples

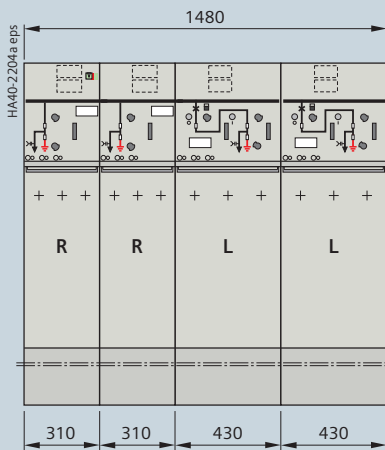

Panel block **RRLL**

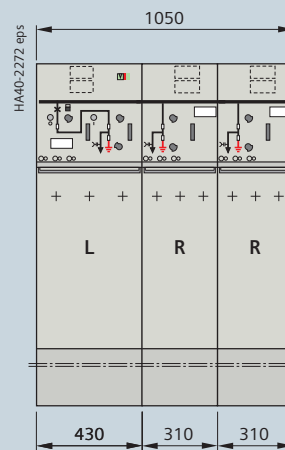

Panel block **LRR**

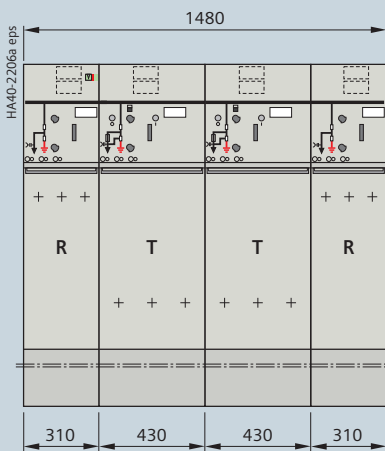

Panel block **RTTR**

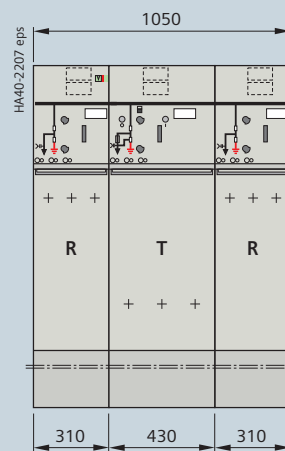

Panel block **RTR**

Further panel block versions can be supplied without functional restrictions up to a total width of 2 m as an assembled and tested unit.



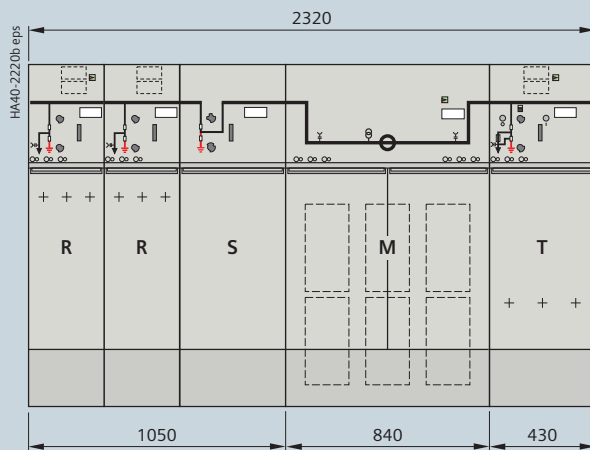

Transfer with ring-main switch (RRS-M-T...)

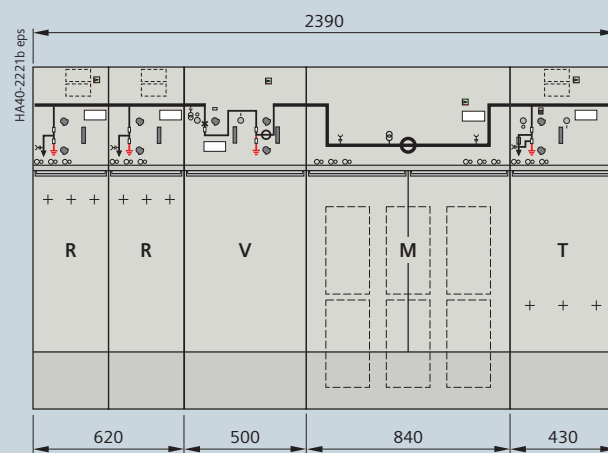

Transfer with circuit-breaker without cables (RR-V-M-T...)

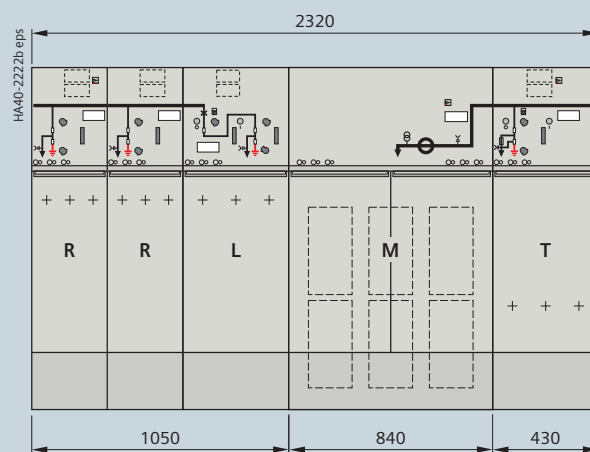

Transfer with circuit-breaker in the panel block and cable connection (RRL-M-T...)

# Dimensions

## Outdoor enclosure

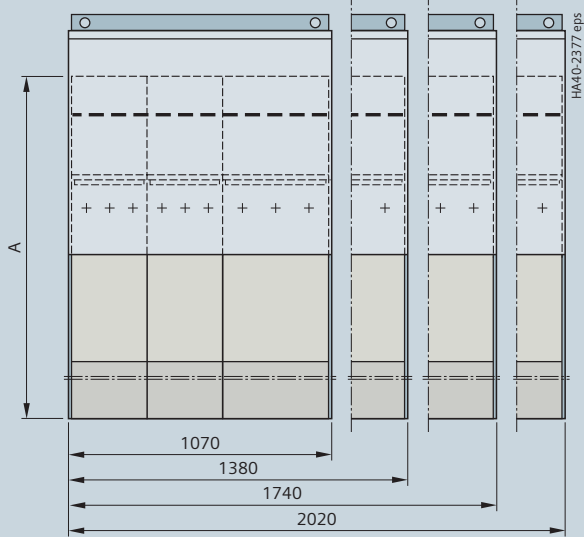

Outdoor enclosure with pressure relief downwards or to the rear

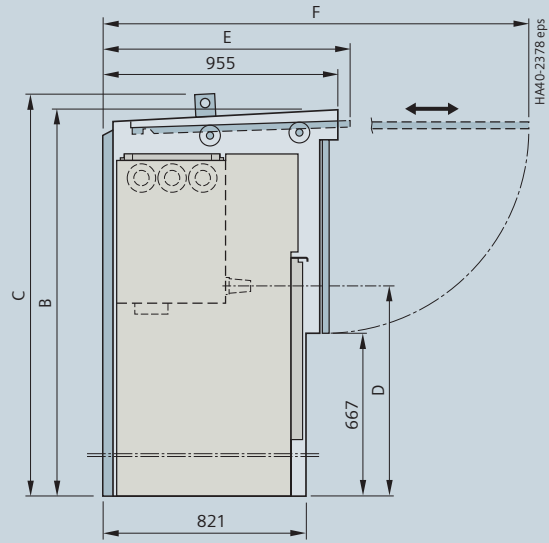

Outdoor enclosure with pressure relief downwards or to the rear

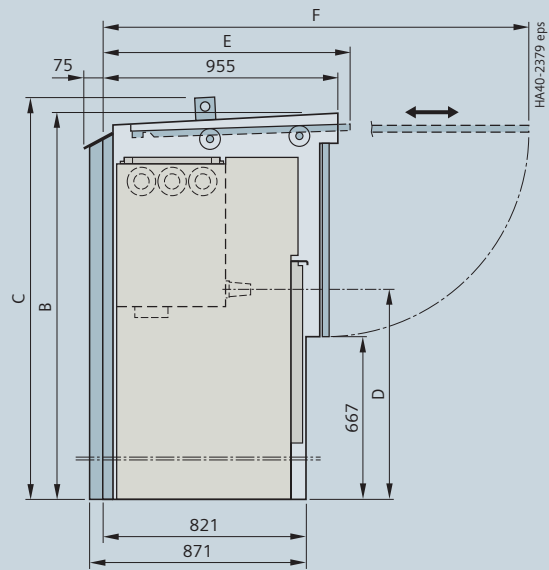

Outdoor enclosure with pressure relief upwards

Switchgear height	without low-voltage compartment	A	1200			1400			
	with low-voltage compartment <sup>1)</sup>		–	1400	1600	1800	–	1400	–
Low-voltage compartment <sup>1)</sup>	–	–	–	200	400	600	–	200	400
Enclosure height	without crane height	B	1575	1575	1775	1975	1575	1775	1975
	with crane profile (removable)	C	1640	1640	1840	2040	1640	1840	2040
Cable connection	Typical K, K(E), R, L	D	660			860			
	Typical T		222			422			
	Typical R(500), L(500)		510			710			
Enclosure depth (roof level, without pressure relief duct)	Door open	E	1000	1000	1200	1400	1000	1200	1400
	Door while opening / closing	F	1725	1725	1925	2125	1725	1925	2125

1) Option: With low-voltage compartment

Note: Maximum switchgear width = Enclosure width – 20 mm

## Individual panels

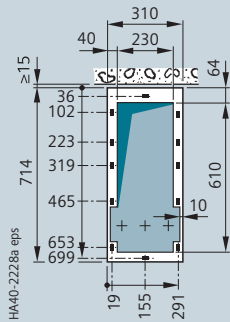

- For ring-main panel type R
- For cable panel type K
- For busbar earthing panel type E

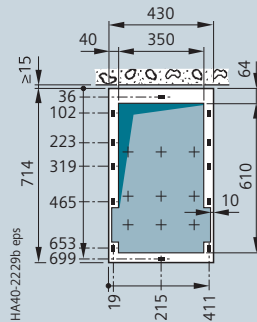

- For cable panel with make-proof earthing switch type K(E)
- For circuit-breaker panel type L
- For transformer panel type T
- For bus sectionalizer panel type S with switch-disconnector
- For bus sectionalizer panel type H with switch-disconnector/fuse combination
- For busbar voltage metering panel type M(430)

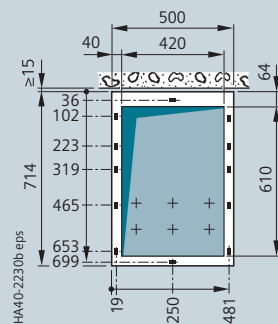

- For ring-main panel type R(500)
- For circuit-breaker panel type L(500)
- For busbar earthing panel type E(500)
- For bus sectionalizer panel type S(500) with switch-diconnector
- For bus sectionalizer panel type V with circuit-breaker
- For busbar voltage metering panel type M(500)

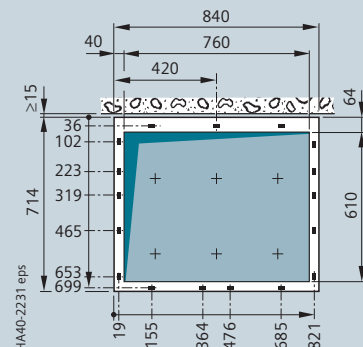

- For billing metering panel type M

# Dimensions

Floor openings and fixing points

## Panel blocks (excerpt)

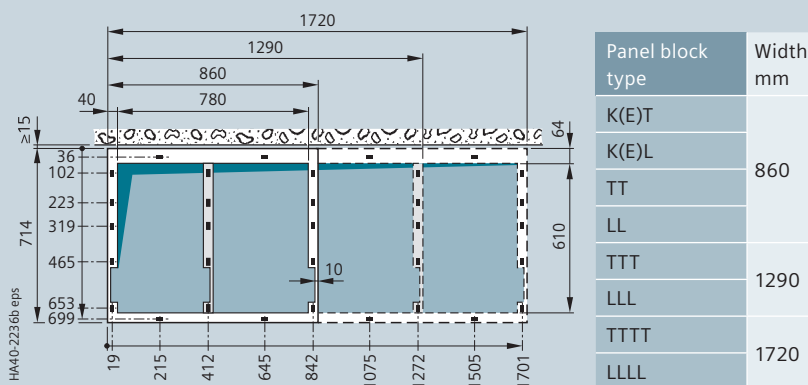
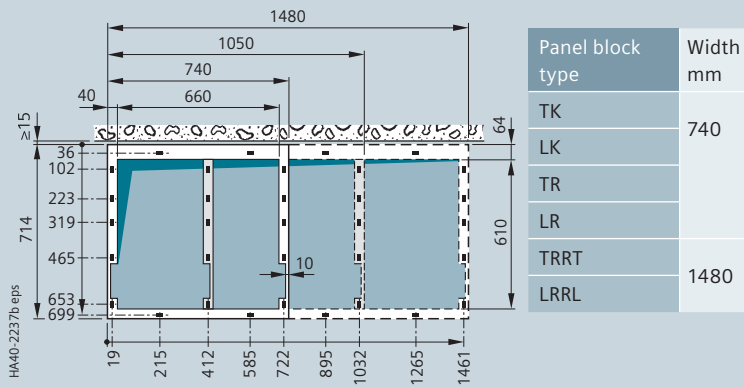
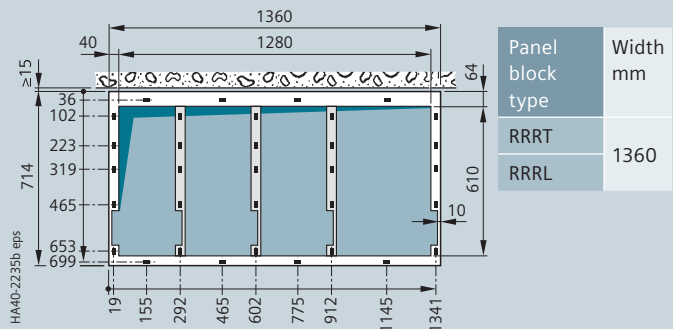
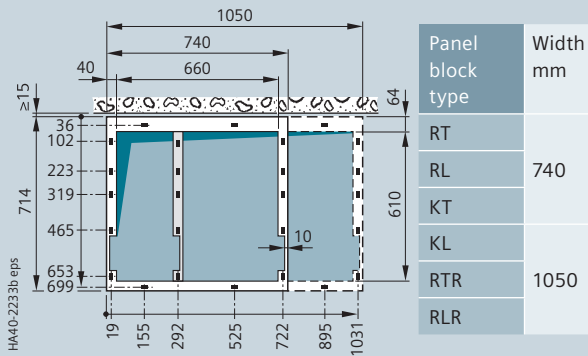
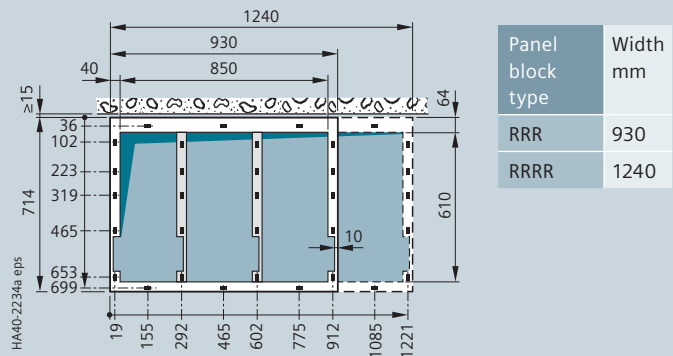
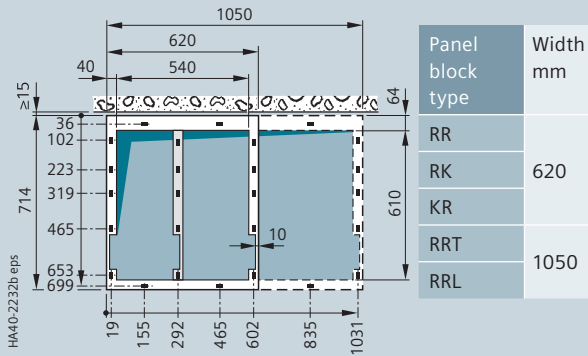

### Panel blocks 8DJH Compact (design option with pressure relief downwards)

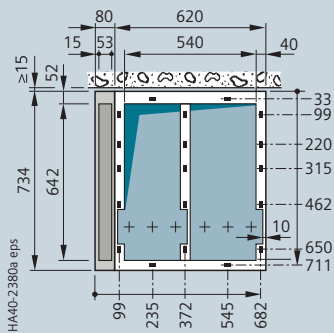

Panel block RRT Compact

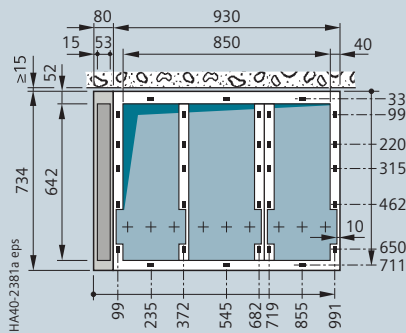

Panel block RRT-R Compact

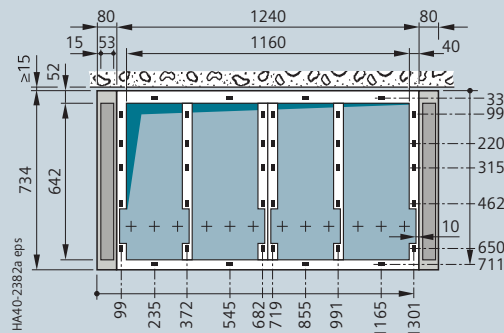

Panel block RRT-RRT Compact

### Versions with deep cable compartment covers (e.g. for double cable connections)

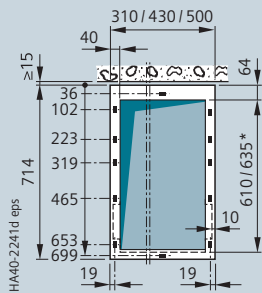

Deep cable compartment cover:  
Without

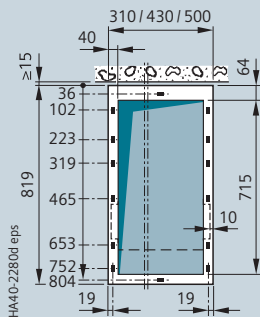

With base extension  
(floor opening depending on selected cable connection/arrester)  
Deeper by 105 mm

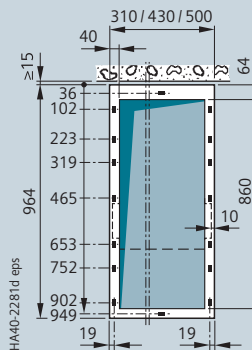

Deeper by 250 mm

### Example:

Position of floor openings and fixing points for double cable connection for panel blocks

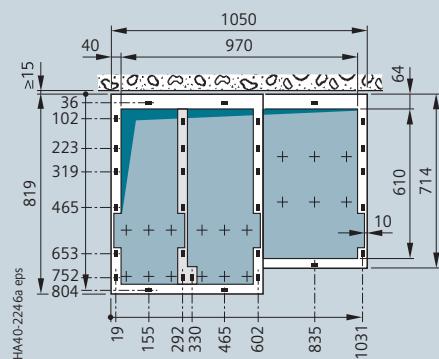

Type RRT deeper by 105 mm

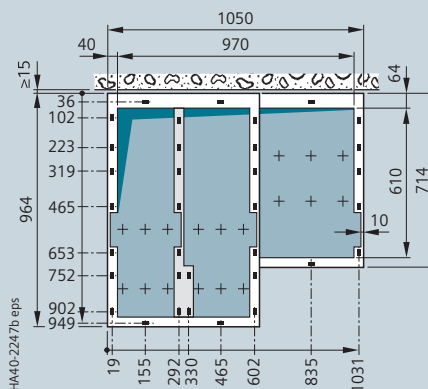

Type RRT deeper by 250 mm

\* 610 mm for single cable connection; 635 mm for double cable connection with coupling T-plug

# Dimensions

Floor openings and fixing points

Versions in connection with base and rear pressure relief duct for switchgear with IAC A FL or FLR up to 21 kA/1 s and deep cable compartment covers\*\*

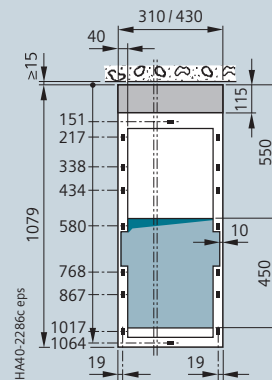
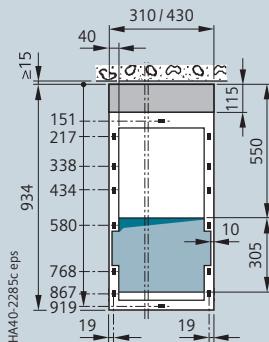
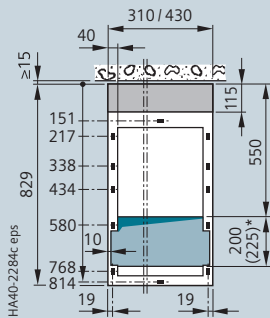

- For ring-main panel type R
- For cable panel type K
- For cable panel type K(E) with make-proof earthing switch
- For circuit-breaker panel type L

Deep cable compartment cover: Without

With base extension

(floor opening depending on selected cable connection/arrester)  
Deeper by 105 mm                      Deeper by 250 mm

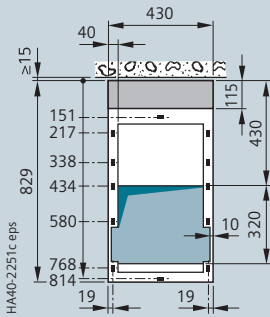

- For transformer panel type T

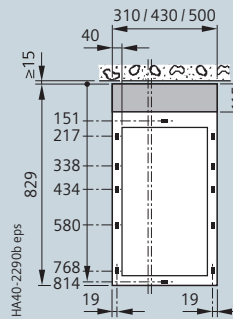

- For panels without cable feeder types S, H, V, M(430)/(500), E, E(500)

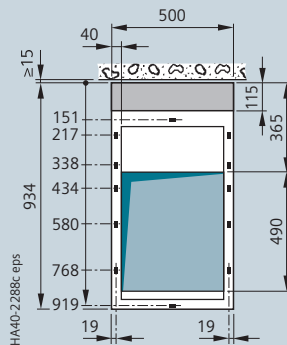
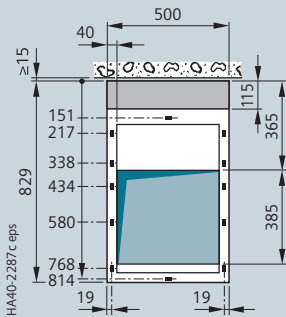

- For ring-main panel type R(500)
- For circuit-breaker panel type L(500)

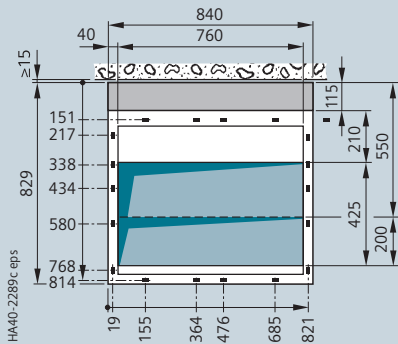

- For billing metering panel type M

\* 200 mm for single cable connection; 225 mm for double cable connection with coupling T-plug

\*\* In versions with rear pressure relief duct for panel block with IAC A FL or FLR up to 16 kA/1 s, the depth is reduced by 10 mm.

For wall-standing arrangement, a wall distance of  $\geq 15$  mm must be provided.

## Packing types (examples)

For size and weight of the transport units, see the following tables.

Means of transport	Examples for packing
Rail and truck	Type: Open PE protective foil pulled over the switchgear, with wooden base
Seafreight	Type: Open (for container transport) PE protective foil pulled over the switchgear, with wooden base
	Type: Seaworthy crate (for open-top container) Welded PE protective foil, with closed wooden crate, with desiccant bag
Airfreight	Type: Open PE protective foil pulled over the switchgear, with wooden base and lattice or cardboard cover

## Transport

8DJH switchgear is completely delivered in transport units. Please observe the following:

- Transport facilities on site
- Transport dimensions and weights
- Size of door openings in building
- Switchgear with low-voltage compartment: Please observe other transport dimensions and weights.

## Transport dimensions

Max. width of switchgear unit TE	Transport dimensions				
	Truck/rail/container			Seaworthy crate/airfreight	
	Width B	Height	Depth T	Height	Depth T
mm	m	m	m	m	m
850	1.10	A + 0.20	1.10 / 1.26 *)	A + 0.4	1.10 / 1.26 *)
1200	1.40			min. 2.00	
1550	1.80				
1800	2.05				
2300	2.55				

A = Switchgear height with or without low-voltage compartment

\*) Deeper transport base required in case of cable compartment cover deeper by 250 mm

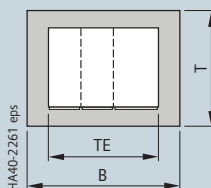

Transport units for shipment (top view)

## Types of transport (examples)

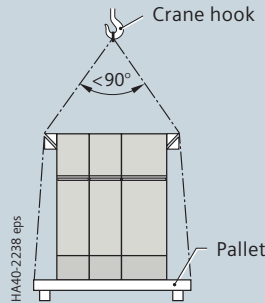

Crane transport with Pallet

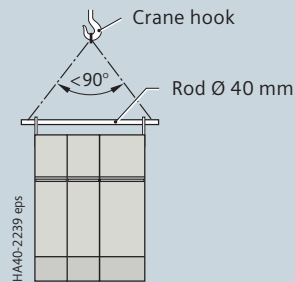

Crane transport with rod

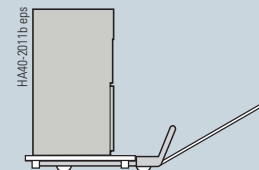

Transport with lifting truck with or without pallet

Rod Ø 40 mm  
(observe switchgear weight)

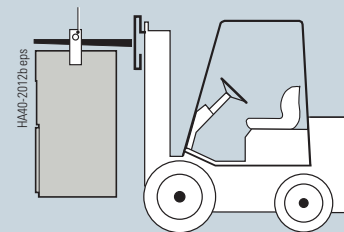

Transport with fork-lift truck, suspended

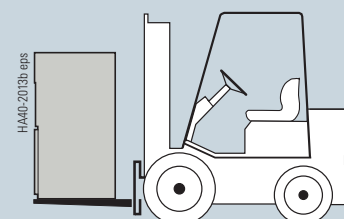

Transport with fork-lift truck, standing



# Installation

## Shipping data, transport

### Transport weights

The transport weight results from the switchgear weight per transport unit and the packing weight. The packing weight results from the transport dimensions and the type of transport.

#### Switchgear weights

The weight of the switchgear unit results from the sum of the weights per functional unit. Depending on the design and the degree to which it is equipped (e.g. current transformers, motor operating mechanism, low-voltage compartment), different values will result. The table shows typical values.

Panel type	Width mm	Gross weight for switchgear height		
		1200 mm approx. kg	1400 mm approx. kg	1700 mm approx. kg
R	310	100	110	120
R(500)	500	140	150	170
K	310	100	110	120
K(E)	430	130	140	160
T	430	135	145	160
L	430	130	140	155
L (type 1.1) without 4MT3	500	210	220	240
L (type 2)	500	160	170	190
M (BC / BB / CB)	840	–	370	400
M (CC)	840	–	270	300
M(430) with 3x4MT3	430	220	230	245
M(500) with 3x4MT3	500	230	240	260
S	430	130	140	160
S(500)	500	150	160	180
S(620)	620	200	220	240
H	430	135	145	160
V	500	240	250	270
E	310	100	110	120
E(500)	500	140	150	170

#### Additional weights for pressure absorber

Pressure relief version for IAC	Absorber unit	Weight of the absorber unit approx. kg
A FL 16 kA / 1 s, A FLR 16 kA / 1 s	Type 8DJH panel block, 2...4 panels	110
A FL 21 kA / 1 s	A minimum of 2 type 8DJH panels, gas-insulated	120
	For each additional type 8DJH panel (total panel width ≤ 2000 mm)	20
A FLR 21 kA / 1 s	A minimum of 2 type 8DJH panels, gas-insulated	145
	For each additional type 8DJH panel (total panel width ≤ 2000 mm)	20
A FL 21 kA / 1 s, A FLR 21 kA / 1 s	Metering panel M	145

#### Additional weights for low-voltage compartment for a height of 600 mm with average degree of equipment

Low-voltage compartment for panel width mm	Weight approx. kg
310	40
430	50
500	60
620	45
840	70

Panel block	Width mm	Gross weight for switchgear height without LV compartment		
		1200 mm approx. kg	1400 mm approx. kg	1700 mm approx. kg

#### 2 panels

KT, TK	740	230	250	280
K(E)T	860	240	260	290
KL <sup>1)</sup> , LK	740	230	250	280
K(E)L <sup>1)</sup>	860	250	270	300
RK, KR	620	200	220	240
RT, TR	740	230	250	280
RL <sup>1)</sup> , LR	740	230	250	280
TT	860	270	290	320
RR	620	200	220	240
LL <sup>1)</sup>	860	260	280	310
RS	740	230	250	280
RH	740	230	250	280

#### 3 panels

RRT	1050	330	360	400
RRL <sup>1)</sup>	1050	320	350	390
RTR	1050	330	360	400
RLR	1050	320	350	390
RRR	930	300	330	360
TTT	1290	410	440	490
LLL <sup>1)</sup>	1290	400	430	480
RRS	1050	320	350	390
RRH	1050	330	360	400

#### 4 panels

RRRT	1360	430	470	520
RRRL <sup>1)</sup>	1360	430	470	520
RRRR	1240	400	440	480
TRRT	1480	470	510	560
LRRL	1480	460	500	550
TTTT	1720	540	580	640
LLLL <sup>1)</sup>	1720	520	560	620
RRRS	1360	420	460	510
RRRH	1360	430	470	520

#### 8DJH Compact

Panel block	Width mm	Gross weight for switchgear height	
		1400 mm approx. kg	1700 mm approx. kg
RRT <sup>2)</sup>	700	365	380
RRT	620	340	345
RRT-R <sup>2)</sup>	1010	475	490
RRT-R	930	450	455
RRT-RRT <sup>2)</sup>	1400	730	760
RRT-RRT	1240	680	690

1) Weight data applies to design with circuit-breaker type 2

2) With lateral pressure relief duct

#### Packing weights

Max. width of switchgear unit mm	Packing weight Truck/rail/container approx. kg	Packing weight Seaworthy crate/airfreight approx. kg
850	30	90
1200	40	120
1550	50	150
1800	60	180
2000	75	225

## Standards

8DJH switchgear complies with the relevant standards and specifications applicable at the time of type tests. In accordance with the harmonization agreement reached by the countries of the European Union, their national specifications conform to the IEC standard.

### Type of service location

8DJH switchgear can be used as indoor installation according to IEC/EN 61936 (Power Installations exceeding AC 1 kV) and VDE 0101.

- Outside lockable electrical service locations at places which are not accessible to the public. Enclosures of switchgear can only be removed with tools.
- Inside lockable electrical service locations. A lockable electrical service location is a place outdoors or indoors that is reserved exclusively for housing electrical equipment and which is kept under lock and key. Access is restricted to authorized personnel and persons who have been properly instructed in electrical engineering. Untrained or unskilled persons may only enter under the supervision of authorized personnel or properly instructed persons.

### Terms

“Make-proof earthing switches” are earthing switches with short-circuit making capacity according to IEC/EN 62271-102 and VDE 0671-102.

### Dielectric strength

- The dielectric strength is verified by testing the switchgear with rated values of short-duration power-frequency withstand voltage and lightning impulse withstand voltage according to IEC/EN 62271-1/VDE 0671-1.
- The rated values are referred to sea level and to normal atmospheric conditions (1013 hPa, 20 °C, 11 g/m<sup>3</sup> humidity according to IEC/EN 60071 and VDE 0111).
- The dielectric strength decreases with increasing altitude. For site altitudes above 1000 m (above sea level) the standards do not provide any guidelines for the insulation rating, but leave this to the scope of special agreements.

All parts housed inside the switchgear vessel which are subjected to high voltage are SF<sub>6</sub>-insulated against the earthed enclosure.

The gas insulation at a relative gas pressure of 50 kPa (= 500 hPa) permits switchgear installation at any desired altitude above sea level without the dielectric strength being adversely affected. This also applies to the cable connection when using screened cable T-plugs or cable elbow plugs.

A decrease (reduction) of the dielectric strength with increasing site altitude must be considered for panels with HV HRC fuses as well as for air-insulated metering panels and a site altitude above 1000 m (above sea level). A higher insulation level must be selected, which results from the multiplication of the rated insulation level for 0 to 1000 m with the altitude correction factor  $K_a$ .

## Overview of standards (June 2017)

		IEC/EN standard	VDE standard
Switchgear	8DJH	IEC/EN 62271-1 IEC/EN 62271-200	VDE 0671-1 VDE 0671-200
Devices	Circuit-breakers	IEC/EN 62271-100	VDE 0671-100
	Disconnectors and earthing switches	IEC/EN 62271-102	VDE 0671-102
	Switch-disconnectors	IEC/EN 62271-103	VDE 0671-103
	Switch-disconnector / fuse combination	IEC/EN 62271-105	VDE 0671-105
	HV HRC fuses	IEC/EN 60282-1	VDE 0670-4
	Voltage detecting systems	IEC/EN 61243-5	VDE 0682-415
Degree of protection	–	IEC/EN 60529	VDE 0470-1
Insulation	–	IEC/EN 60071	VDE 0111
Instrument transformers	Current transformers	IEC/EN 61869-1/-2	VDE 0414-9-1/-2
	Voltage transformers	IEC/EN 61869-1/-3	VDE 0414-9-1/-3
	Electronic voltage transformers	IEC/EN 60044-7	VDE 0414-44-7
	Electronic current transformers	IEC/EN 60044-8	VDE 0414-44-8
Installation, erection	–	IEC/EN 61936-1 EN 50522	VDE 0101
SF <sub>6</sub> insulating gas	Specification for SF <sub>6</sub>	IEC/EN 60376	VDE 0373-1

## Altitude correction factor $K_a$ for panels with HV HRC fuses or for metering panels type M

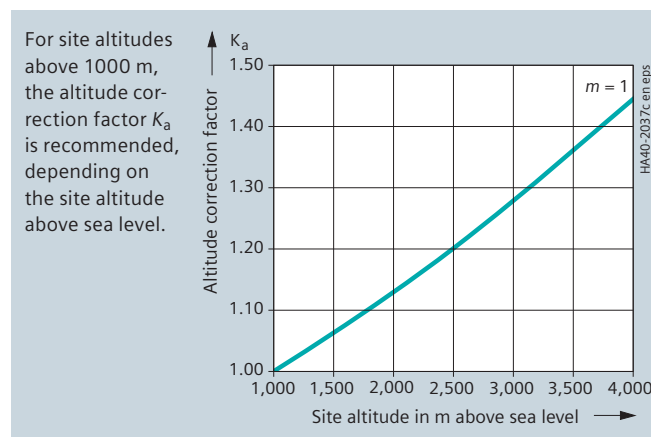

Curve  $m = 1$  for rated short-duration power-frequency withstand voltage and rated lightning impulse withstand voltage according to IEC/EN 62271-1/VDE 0671-1.

### Example:

3000 m site altitude above sea level,  
17.5 kV switchgear rated voltage,  
95 kV rated lightning impulse withstand voltage

Rated lightning impulse withstand-voltage to be selected  $95 \text{ kV} \cdot 1.28 = 122 \text{ kV}$

### Result:

According to the above table, a switchgear for a rated voltage of 24 kV with a rated lightning impulse withstand voltage of 125 kV is to be selected.

# Standards

Standards, specifications, guidelines

## Current carrying capacity

- According to IEC/EN 62271-200/VDE 0671-200 or IEC/EN 62271-1/VDE 0671-1, the rated normal current refers to the following ambient air temperatures:
  - Maximum of 24-hour mean + 35 °C
  - Maximum + 40 °C
- The current carrying capacity of the panels and busbars depends on the ambient air temperature outside the enclosure.

## Appearance of internal faults

In gas-insulated switchgear 8DJH, faults leading to internal arcing are widely excluded by construction due to the following measures:

- Use of gas-filled switchgear compartments
- Use of suitable operational equipment such as three-position switches with make-proof earthing switch
- Logical mechanical interlocks
- Use of metal-coated or metal-enclosed voltage transformers and three-phase current transformers as ring-core current transformers
- There are no effects due to external influences, such as
  - Pollution layers
  - Humidity
  - Small animals and foreign objects
- Maloperation is practically excluded due to logical arrangement of operating elements
- Short-circuit-proof feeder earthing by means of the three-position switch-disconnector.

In the event of an arc fault at the cable connection or, in an unlikely case, inside the switchgear vessel, pressure relief is effected downwards into the cable basement.

For the use in substation buildings without internal arcing test, such as “old substations”, the switchgear can be designed with a modified pressure relief system with absorbers (option).

As a “special cooling system”, this maintenance-free pressure absorber system reduces the pressure-dependent and thermal effects of internal arcing in switchgear vessels and cable compartments, and thus protects people and buildings.

The closed switchgear system is suitable for both wall-standing and free-standing arrangement.

## Internal arcing test (design option)

- Protection of operating personnel by means of tests for verifying the internal arc classification
- Internal arcing tests must be performed in accordance with IEC/EN 62271-200/VDE 0671-200 for IAC (internal arc classification)

- Definition of criteria:

- Criterion 1  
Correctly secured doors and covers do not open, limited deformations are accepted
  - Criterion 2  
No fragmentation of the enclosure, no projection of small parts above 60 g
  - Criterion 3  
No holes in accessible sides up to a height of 2 m
  - Criterion 4  
No ignition of indicators due to hot gases
  - Criterion 5  
The enclosure remains connected to its earthing point.
- Optionally, 8DJH switchgear can be designed with internal arc classification.

## Seismic withstand capability (option)

8DJH switchgear can be upgraded for regions at risk from earthquakes. For upgrading, earthquake qualification testing has been carried out in accordance with the following standards:

- IEC/EN 60068-3-3
- IEC/EN 60068-2-6
- IEEE 693
- IABG TA13-TM-002/98 (guide).

## Climate and environmental influences

8DJH switchgear is completely enclosed and insensitive to climatic influences.

- The switchgear is maintenance-free under indoor ambient conditions (according to IEC 62271-1 and VDE 0671-1)
- Switchgear versions for outdoor installation or severe ambient conditions (according to customer specification) are available on request
- Climatic tests are fulfilled according to IEC/EN 62271-304/ VDE 0671-304
- All medium-voltage devices (except for HV HRC fuses) are installed in a gas-tight, welded stainless-steel switchgear vessel which is filled with SF<sub>6</sub> gas
- Live parts outside the switchgear vessel are provided with single-pole enclosure
- At no point can creepage currents flow from high-voltage potentials to earth
- Operating mechanism parts which are functionally important are made of corrosion-resistant materials
- Bearings in the operating mechanism are designed as dry-type bearings and do not require lubrication.

## Color of the panel front

Siemens standard (SN) 47030 G1, color no. 700/light basic (similar to RAL 7047/gray).

### Recycling

The switchgear can be recycled in ecological manner in compliance with existing legislation. Auxiliary devices such as short-circuit indicators have to be recycled as electronic scrap. Batteries have to be recycled professionally. Insulating gas SF<sub>6</sub> has to be evacuated professionally as a reusable material and recycled (SF<sub>6</sub> must not be released into the environment).

### Protection against solid foreign objects, electric shock and water

8DJH switchgear fulfills according to the standards \*)

IEC/EN 62271-1	VDE 0671-1
IEC/EN 62271-200	VDE 0671-200
IEC/EN 60529	DIN EN 60529

the following degrees of protection (for explanations, see opposite table):

Degree of protection	Type of protection
IP 2x	for switchgear enclosure
IP 3x	for switchgear enclosure (optional)
IP 65	for gas-filled switchgear vessel

### IEC/EN 60529

Type of protection	Degree of protection
	<b>IP 2 X</b>
<b>Protection against solid foreign objects</b> Protected against solid foreign objects of 12.5 mm diameter and greater (the object probe, sphere of 12.5 mm diameter, shall not fully penetrate)	↑ ↑
<b>Protection against access to hazardous parts</b> Protected against access to hazardous parts with a finger (the jointed test finger of 12 mm diameter, 80 mm length, shall have adequate clearance from hazardous parts)	
<b>Protection against water</b> No definition	
	<b>IP 3 X</b>
<b>Protection against solid foreign objects</b> Protected against solid foreign objects of 2.5 mm diameter and greater (the object probe, sphere of 2.5 mm diameter, shall not penetrate at all)	↑ ↑
<b>Protection against access to hazardous parts</b> Protected against access to hazardous parts with a tool (the access probe, sphere of 2.5 mm diameter shall not penetrate)	
<b>Protection against water</b> No definition	
	<b>IP 6 5</b>
<b>Protection against solid foreign objects</b> Dust-tight (no ingress of dust)	↑ ↑
<b>Protection against access to hazardous parts</b> Protected against access to hazardous parts with a wire (the access probe of 1.0 mm diameter shall not penetrate)	
<b>Protection against water</b> Protected against water jets (water projected in jets against the enclosure from any direction shall have no harmful effects)	

\*) For standards, see page 89

Published by  
Siemens AG 2017

Energy Management  
Medium Voltage & Systems  
Mozartstraße 31 C  
91052 Erlangen, Germany

For further information please contact  
our Customer Support Center  
Phone: +49 180 524 70 00  
Fax: +49 180 524 24 71  
E-mail: [support.energy@siemens.com](mailto:support.energy@siemens.com)  
[siemens.com/medium-voltage-switchgear](http://siemens.com/medium-voltage-switchgear)  
[siemens.com/8DJH](http://siemens.com/8DJH)

Article No. EMMS-K1440-A211-A6-7600  
Printed in Germany  
Dispo 40401  
PU 002806 KG 07.17 1.0

Subject to changes and errors. The information given in this document only contains general descriptions and/or performance features which may not always specifically reflect those described, or which may undergo modification in the course of further development of the products. The requested performance features are binding only when they are expressly agreed upon in the concluded contract.

2017

