

SIEMENS

DRY TYPE TRANSFORMERS

NOTES:

- 1) ALL UNITS ARE UL LISTED AND ARE DESIGNED IN ACCORDANCE WITH ANSI C89.2 AND NEMA ST-20 STANDARDS.
- 2) THESE TRANSFORMERS UTILIZE A UL RECOGNIZED 220°C INSULATION SYSTEM, TEMPERATURE RISE AS INDICATED IN THE TABLE.
- 3) TRANSFORMERS ARE DRY TYPE, CLASS AA, ENCLOSURE FOR INDOOR OR OUTDOOR USE
- 4) FOR LIFTING OTHER THAN WITH FORK TRUCK, REMOVE TOP COVER AND USE CORE CLAMPS FOR 45KVA & UP.
- 5) PAINT COLOR IS ANSI #61 GRAY.
- 6) FULL WIDTH COPPER ELECTROSTATIC SHIELD (OPTIONAL).
- 7) 6" REQUIRED CLEARANCE FROM THE WALLS.
8. HV/LV TERMINALS ARE TOP FRONT TERMINATED.

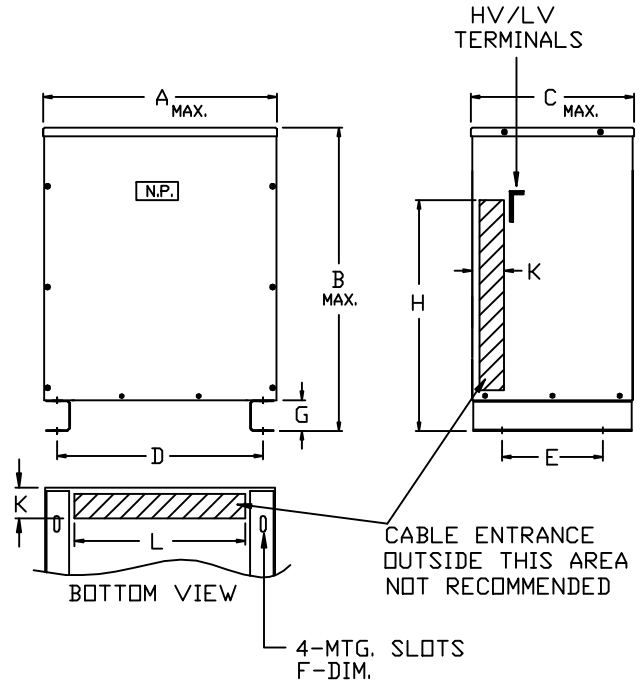

DIMENSIONS IN (E)=INCHES & (M)=CENTIMETERS

KVA	TEMP. RISE °C	NET WT. LBS.	A		B		C		D		E		F		G		H		K		L	
			E	M	E	M	E	M	E	M	E	M	E	M	E	M	E	M	E	M	E	M
			15	150	357	22.0	55.9	25.0	63.5	17.0	43.2	17.4	44.1	13.0	33.0	.56x1.13	1.42x2.87	3.0	7.6	13.0	33.0	3.0
30	150	673	27.0	68.6	32.0	81.3	21.0	53.3	23.5	59.7	16.0	40.6	.56x1.13	1.42x2.87	3.0	7.6	18.0	45.7	3.0	7.6	20.0	50.8
45	150	891	29.0	73.7	38.0	96.5	23.0	58.4	25.5	64.8	18.0	45.7	.56x1.13	1.42x2.87	3.0	7.6	20.0	45.8	3.0	7.6	22.0	55.9
75	150	1150	33.0	83.8	42.0	107	26.0	66.0	29.5	74.9	21.0	53.3	.56x1.13	1.42x2.87	3.0	7.6	23.0	58.4	4.0	10.2	25.5	64.8
112.5	150	1512	35.0	88.9	46.0	117	30.0	76.2	31.5	80.0	25.0	63.5	.56x1.13	1.42x2.87	3.0	7.6	32.0	81.3	5.0	12.7	27.5	69.9
150	150	1915	35.0	88.9	52.0	132	30.0	76.2	31.5	80.0	25.0	63.5	.56x1.13	1.42x2.87	3.0	7.6	32.0	81.3	5.0	12.7	27.5	69.9
225	150	2829	48.0	122	60.0	154	33.0	83.8	42.0	107	27.0	68.6	.56x1.13	1.42x2.87	4.0	10.2	36.0	91.4	5.0	12.7	34.0	86.4
300	150	4945	52.0	132	72.0	183	40.0	102	34.0	86.4	42.0	107	.56x1.13	1.42x2.87	4.0	10.2	50.0	112	5.0	12.7	32.0	81.3
500	150	6325	66.0	168	81.0	206	44.0	112	63.0	160	38.5	97.8	.56x1.13	1.42x2.87	5.0	12.7	60.0	152	6.0	15.2	48.0	122

KVA	QTY.	CATALOG NO.	VOLTAGE		TAPS	DRAWING
			PRIMARY	SECONDARY		
						<input type="checkbox"/> APPROVAL
						<input type="checkbox"/> RECORD
						<input type="checkbox"/> OTHER

CUST.	DWN. BY:	Siemens Industry, Inc.
	DATE:	
JOB	CHK. BY:	TOTALLY ENCLOSED TRANSFORMERS THREE-PHASE, 600 VOLTS CLASS, 60 HZ. K-FACTOR (1) RATED - COPPER
P.O.	DATE:	
TIE	APVD. BY:	
S.O.	DATE:	DWG. NO. J-137
		REV. A DATE 12/06/10