

Contactors and Contactor Assemblies

contents

Section Overview	2/2 - 2/5	SIRIUS Contactor Spare Parts	
Product Overview	2/6 - 2/7	Coils	2/94 - 2/98
SIRIUS Contactors		Arc Chutes	2/99
3RT20, 3-pole to 95A	2/8	Contact Kits	2/99
3RT10, 3-pole to 500A	2/9	Obsolete Contactor / Relay Spare Parts.....	2/102 - 2/103
3RT12, 3-pole Vacuum to 500A	2/10	Design / Function Overview	
3RT23, 4-pole with 4 NO	2/11	3RT20 Contactors, S00 to S3	2/104 - 2/105
3RT24, 3-pole for Resistive Loads	2/12	3RT10 Contactors, S6 to S12	2/106 - 2/107
3RT25, 4-pole with 2 NO + 2 NC	2/13	WYE-Delta Starters	2/110 - 2/115
3RT26, for Capacitor Switching	2/19	3RH2 Control Relays	2/116
3RT20, Interface Coupling Contactors	2/20 - 2/21	3TF6 Vacuum Contactors up to 820A	2/117
3RT20 Motor Contactors for DC Operation	2/16 - 2/18	3RT / 3RH Accessories	2/118 - 2/120
3RH21 Contactor Relays	2/14 - 2/15	Technical Data	
3RA13 / 3RA23 Reversing Contactors	2/37 - 2/44	3RT10 / 3RT20 Contactors	2/121 - 2/154
3RT, 3TF Safety Contactors and		3RT12 Vacuum Contactors	2/155 - 2/160
3RH2, 3TH2 Safety Control Relays	2/22 - 2/23	3RT24 Resistive Load Contactors	2/161 - 2/168
Function Modules for Communications	2/24 - 2/36	3RT23 4-pole Contactors 4 NO	2/169 - 2/170
3RA24, Wye-Delta Starting	2/45 - 2/48	3RT25 4-pole Contactors 2 NO & 2 NC	2/171 - 2/172
Contactor Coil Codes	2/49	3RT26 Capacitor Switching Contactors	2/173
SIRIUS Control Relays & Coupling Relays		3RT20 Interface Relays	2/174
3RH2 Control Relays	2/50	3TF6 Vacuum Contactors up to 820A	2/175 - 2/180
3RH24 Latched Control Relays	2/51	3TC DC Switching Contactors	2/181 - 2/184
Auxiliary Switches	2/51	Accessories	2/185 - 2/187
3RH21 Coupling Relays	2/52	3RH2 Control and Latching Relays	2/188 - 2/191
Special Application Contactors (3TF6 / 3TB5 / 3TC)		3RH21 Coupling Relays	2/192
3TF6 Vacuum Contactors up to 820A	2/53 - 2/54	Circuit Diagrams	
3TC DC Switching Contactors	2/55 - 2/56	3RT Contactors & Accessories	2/193 - 2/201
3TB5 Contactor Coils	2/100 - 2/101	3RA23 Reversing Contactors	2/202
SIRIUS Contactor & Relay Accessories		WYE-Delta Starters	2/203
Overview	2/57 - 2/65	3TF6 Vacuum Contactors up to 820A	2/204
Auxiliary Switches	2/66 - 2/69	3RH2 Control & Latching Relays	2/206
Auxiliary Time Delay and Latching Blocks	2/70 - 2/71	3RH21 Coupling Relays	2/205
Surge and EMC Suppressors	2/73 - 2/74	Position of Terminals	
Contactor Accessories	2/76 - 2/79	3RT Contactors and Accessories	2/206 - 2/210
Reversing Accessories	2/80 - 2/82	3RT Capacitor Contactors	2/209
Wye-delta Accessories	2/83	3TF6 Vacuum Contactors up to 820A	2/211
NEMA 1 Enclosures	2/93	3RH2 Control Relays	2/206
SIRIUS Current Monitoring Relays		Dimensions	
3RR21 Basic Versions	2/84 - 2/87	3RT, 3-pole Contactors S00 to S3	2/212 - 2/215
3RR22 Standard Versions	2/84 - 2/87	3RT10, 3-pole Contactors S6 to S12	2/216 - 2/217
3RR24 with IO-Link	2/88 - 2/91	3RT24, 3-pole Contactors for Resistive Loads	2/216 - 2/217
Accessories	2/92	3RT12, 3-pole Vacuum Contactors	2/218
Special Application Contactor Accessories		3RT23, 3RT25 4-pole Contactors	2/219
Auxiliary Contacts	2/53	3RT26, Contactors for Capacitor Switching	2/220
Box Terminals and Covers	2/54	3RA13 / 23 Reversing Contactors	2/221 - 2/223
Surge Suppressors for 3TB, 3TC, 3TF	2/54	3TF6 Vacuum Contactors up to 820A	2/224
		Contactor Accessories	2/225 - 2/226
		3RH2 Control and Coupling Relays	2/227

Contactors and Contactor Assemblies

Contactors for switching three-phase motors

contents

Contactors for switching three-phase motors

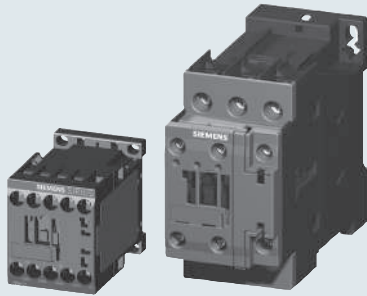

**3RT20 contactors, 3-pole
3 to 75 HP, Sizes S00 to S3**
with screw, spring or ring lug
connections

Page

Selection and ordering data

- AC/DC operation 2/8
- Accessories 2/66
- Spare parts 2/94

Description	2/104
Technical data	2/121
Internal circuit diagrams	2/193
Position of terminals	2/206
Dimension drawings	2/212

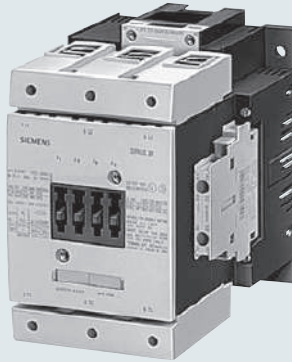

**3RT10 contactors, 3-pole,
100 to 400 HP,
sizes S6, S10 and S12**

Page

Selection and ordering data

- AC/DC operation 2/9
- Accessories 2/66
- Spare parts 2/98

Description	2/106
Technical data	2/123
Internal circuit diagrams	2/199
Position of terminals	2/207
Dimension drawings	2/216



**3RT20 NEMA
labeled contactors,
NEMA size 0 to 6**

Page

Selection and ordering data

- AC/DC operation 2/8, 2/9
- Accessories 2/66
- Spare parts 2/94

Description	2/104
Technical data	2/121
Internal circuit diagrams	2/193
Position of terminals	2/206
Dimension drawings	2/212

Contactor assemblies for switching three-phase motors

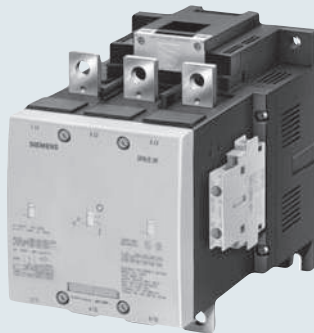

**3RT12 vacuum contactors, 3-pole,
150 to 400 HP,
sizes S10 and S12**

Page

Selection and ordering data

- AC/DC operation 2/10
- Accessories 2/66
- Spare parts 2/98

Description	2/106
Technical data	2/155
Internal circuit diagrams	2/199
Position of terminals	2/207
Dimension drawings	2/218

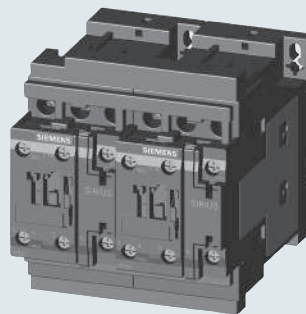

**3RA13 / 23 contactor assemblies for
reversing, 3 to 75 HP, sizes S00 to S3**
with screw or spring loaded connections

Page

Selection and ordering data

- AC/DC operation 2/40
- Accessories 2/80
- Spare parts 2/94

Overview	2/38
Description	2/37
Circuit diagrams	2/202
Position of terminals	2/207
Dimension drawings	2/221

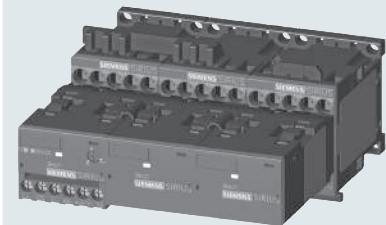

**Wye Delta for
customer assembly of
sizes S00 to S12**

Page

Selection and ordering data

- For wye-delta starting 2/47
- Accessories 2/83
- Spare parts 2/94

Overview	2/108
Description	2/110
Circuit diagrams	2/203

Contactors and Contactor Assemblies

Contactors for special applications

contents

Contactors for special applications

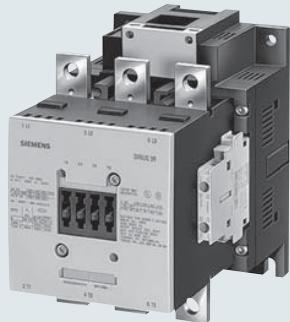

3RT14 / 24 contactors,
 I_e /AC-1: 140 to 690 A,
3-pole, sizes S3 to S12,
with screw connections

Page

Selection and ordering data

- AC/DC operation 2/12
- Accessories 2/66
- Spare parts 2/97

Descriptions	2/12
Technical Data	2/161
Internal circuit diagrams	2/199
Position of terminals	2/207
Dimension drawings	2/214

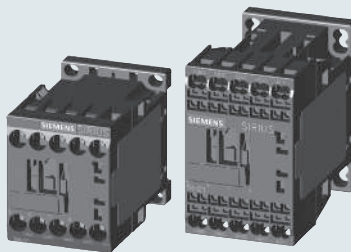

3RT23 contactors,
AC-1: 18 to 140 A with 4 NO main
contacts, sizes S00 to S3
with screw or spring connections

Page

Selection and ordering data

- AC/DC operation 2/11
- Accessories 2/66
- Spare parts 2/94

Description	2/11
Technical Data	2/169
Internal circuit diagrams	2/194
Position of terminals	2/210
Dimension drawings	2/219



3RT25 contactors,
AC-3: 7.5-25 HP with 2 NO + 2 NC
main contacts, sizes S00 to S2
with screw or spring connections

Page

Selection and ordering data

- AC/DC operation 2/13
- Accessories 2/66
- Spare parts 2/94

Description	2/13
Technical Data	2/171
Internal circuit diagrams	2/193
Position of terminals	2/206
Dimension drawings	2/219

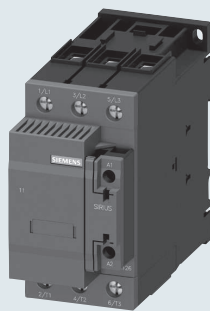

3RT26 capacitor
contactors, up to 75 kvar,
sizes S00 to S2
with screw connections

Page

Selection and ordering data

- AC/DC operation 2/19
- Accessories 2/66
- Spare parts 2/96

Descriptions	2/12
Technical Data	2/173
Internal circuit diagrams	2/193
Position of terminals	2/209
Dimension drawings	2/220

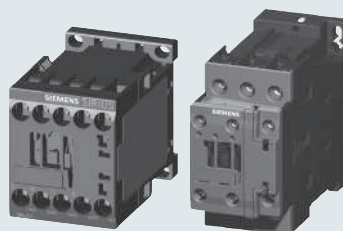

3RT20 coupling relays up to 20 HP
(interface,) 3-pole, for switching
motors, sizes S00 and S0
with screw or spring connections

Page

Selection and ordering data

- DC operation 2/20
- Accessories 2/66
- Spare parts 2/94

Description	2/20
Technical Data	2/174
Internal circuit diagrams	2/193
Position of terminals	2/206
Dimension drawings	2/212

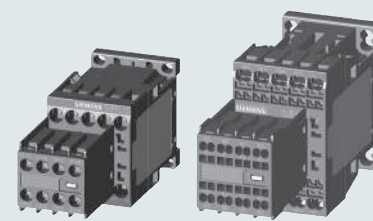

3RT Safety Contactors and
3RH Safety Control Relays

Page

Selection and ordering data

- Safety with standard devices 2/22
- Safety with permanently mounted auxiliaries 2/23
- Accessories 2/73

Description	2/22
Technical Data	2/121

Contactors and Contactor Assemblies

Contactors for special application

contents

Contactors for special applications



3TF68 and 3TF69 vacuum contactors, 500 to 700 HP; contactor assemblies

Page

Selection and ordering data

- AC/DC operation 2/53
- Accessories 2/53
- Spare parts 2/53

Descriptions	2/117
Technical Data	2/175
Internal circuit diagrams	2/204
Position of terminals	2/211
Dimension drawings	2/224

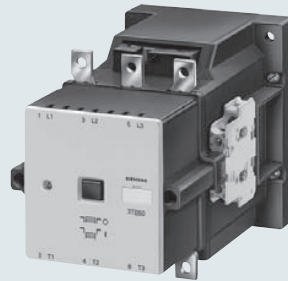

3TB50 to 3TB56 contactors with DC solenoid system, 100 to 300 HP

Page

Selection and ordering data

- Spare parts 2/101

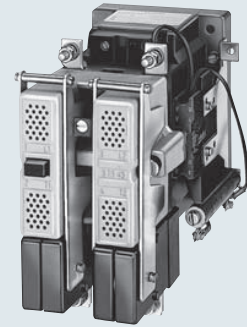

3TC Contactors

Page

Selection and ordering data

- DC operation 2/55
- Spare parts 2/55

Technical Data	2/181
----------------	-------

3RT1 SIRIUS Nomenclature

3RT1	0	3	5	1	A	B0	1
SIRIUS Contactor	Application 0 = 3 pole Standard 2 = 3 pole Vacuum 3 = 4 pole NO 4 = 3 pole resistive load 5 = 4 pole 2 NO + 2 NC 6 = 3 pole Capacitive	Frame 5 = S6 6 = S10 7 = S12	Current Designation Choices = 4,5,6	Terminal 2 = Spring Loaded Coil only 6 = Busbar Terminal	Coil Type A = AC/DC (S6-S12) N = UC Solid state (S6-S12) P = UC Solid state with RLT (S6-S12)	Coil Voltage See Coil Selection Chart page 2/49	Aux Contacts A) 0 = None 4 = 2NO + 2NC (S6-S12) 5 = 1NO + 1 NC (S6-S12) 6 = 2 NO + 2 NC (S6-S12) A) per EN50012

3RT2 SIRIUS Innovations Nomenclature

3RT2	0	1	5	1	A	B0	1
SIRIUS Innovations Contactor	Application 0 = 3 pole Standard 3 = 4 pole NO 5 = 4 pole 2 NO + 2 NC 6 = 3-pole Capacitive	Frame 1 = S00 2 = S0 3 = S2 4 = S3	Current 3,4,5,6,7,8	Terminal 1 = Screw 2 = Spring Loaded 3 = Spring Loaded Coil only 4 = Ring Lug	Coil Type A = AC (S0-S3) B = DC N = UC Electronic	Coil Voltage See Coil Selection Chart page 2/49	Aux Contacts A) 0 = 1NO + 1NC (S0-S3) 1 = 1 NO (S00) 2 = 1 NC (S00) 4 = 2NO + 2NC (S00-S3) A) per EN50012

Note: MSPs and Contactors of the same frame size are made to easily fit together with the use of a link module or can be purchased pre-assembled as 3RA starter assemblies. See section 4.

Note: Contactors and Overloads of the frame size S00 - S3 are made to easily fit together without the use of accessories.

Note: This is only a guide to decode the model number. All possible combinations of these are not available.

Contents

SIRIUS contactor relays

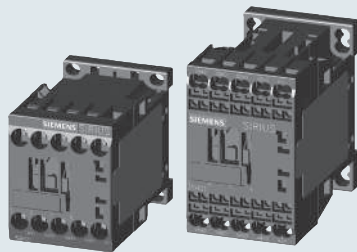

3RH21, 3RH22 control relays 4- and 8-pole, size S00, AC/DC operation

Selection and ordering data

- With screw connections 2/50
- With spring connections 2/50
- Accessories for 3RH2 2/51

Overview	2/14
Technical data	2/188
Terminal diagrams	2/205
Position of terminals	2/206
Dimension drawings	2/227

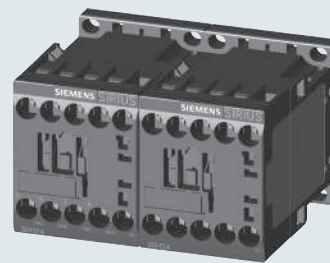

3RH24 latched control relays, 4-pole, size S00, AC/DC operation

Selection and ordering data

- With screw connections 2/51
- Accessories for 3RH2 2/51

Application	2/116
Technical data	2/188
Terminal diagrams	2/205
Position of terminals	2/206
Dimension drawings	2/227

SIRIUS coupling relays (interface)

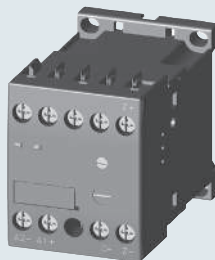

3RH21 coupling relays for switching auxiliary circuits, 4-pole, size S00, DC operation

Selection and ordering data

- With screw connections 2/52
- with Cage Clamp connections 2/52

Application	2/52
Technical data	2/192
Terminal diagrams	2/205
Position of terminals	2/206
Dimension drawings	2/227

SIRIUS current monitoring relays

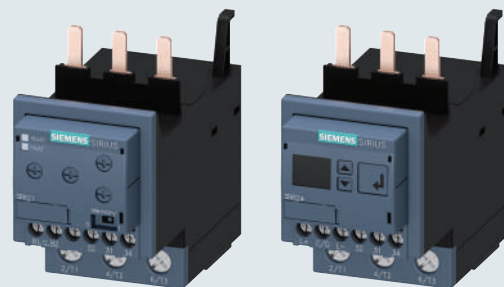

3RR current monitoring relays for direct mounting to SIRIUS contactors

Selection and ordering data

- Basic versions 2/87
- Standard versions 2/87
- Versions with IO-Link 2/91
- Accessories for 3RR 2/92

Overview	2/84
Application	2/84
Technical data	2/85

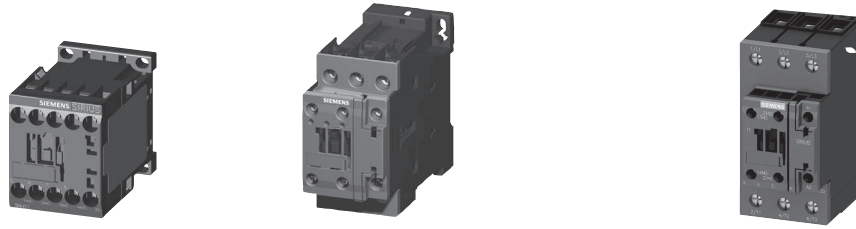

Type	S00 3RT20 1				S0 3RT20 2							S2 3RT20 3			
3RT20 contactors															
Type	3RT2015	3RT2016	3RT2017	3RT2018	3RT2023	3RT2024	3RT2025	3RT2026	3RT2027	3RT2028	3RT2035	3RT2036	3RT2037	3RT2038	
AC/DC operation	(p. 2/8)				(p. 2/8)							(p. 2/8)			
Type															
AC/DC operation															
Maximum 3-phase horsepower ratings at 460V (UL and CSA listed values)															
200 V	HP	1.5	2	3	3	2	3	5	7.5	10	10	10	15	20	20
230 V	HP	2	3	3	5	3	3	5	7.5	10	10	15	15	20	25
460 V	HP	3	5	7.5	10	5	7.5	10	15	20	25	30	40	50	50
575 V	HP	5	7.5	10	10	7.5	10	15	20	25	25	40	50	50	60
AC-3															
I_e /AC-3/400V	A	6	9	12	16	9	12	17	25	32	38	40	50	65	80
230 V	kW	1.5	2.2	3	4	2.2	3	4	5.5	7.5	11	11	15	18.5	22
400 V	kW	3	4	5.5	7.5	4	5.5	7.5	11	15	18.5	18.5	22	30	37
500 V	kW	3.5	4.5	5.5	7.5	4.5	7.5	10	11	18.5	18.5	22	30	37	37
690 V	kW	4	5.5	5.5	7.5	7.5	7.5	11	11	18.5	18.5	22	22	37	45
1000 V	kW	—	—	—	—	—	—	—	—	—	—	—	—	—	—
AC-4 (at $I_a = 6 \times I_e$)															
400 V	kW	3	4	4	5.5	4	5.5	7.5	7.5	11	11	18.5	22	30	37
400 V (200,000 operating cycles)	kW	1.15	2	2	2.5	2	2.6	3.5	4.4	6	6	11.6	12.6	14.7	15.8
AC-1 (40°C, ≤ 690V)															
I_e	A	18	22	22	22	40	40	40	40	50	50	60	70	80	90

Accessories for contactors

Auxiliary switch blocks	front	3RH29 11	(p. 2/66)	3RH29 11	(p. 2/66)										
	lateral	3RH29 11	(p. 2/68)	3RH29 21	(p. 2/68)										
Terminal covers		—		—								3RT29 36		(p. 2/77)	
Box terminals		—		—								—			
Surge suppressor		3RT29 16	(p. 2/73)	3RT29 26	(p. 2/73)							3RT29 36		(p. 2/73)	
3RU21 and 3RB3 overload relays (Section 3)															
3RU21, thermal, CLASS 10		3RU21 16	0.1-16A (p. 3/10)	3RU21 26	0.18-40A (p. 3/10)							3RU21 36	11-80A (p. 3/10)		
3RB30/31, solid-state, CLASS 5, 10, 20 and 30		3RB30 16	0.1-16A (p. 3/22)	3RB30 26	0.1-40A (p. 3/22)							3RB30 36	12-80A (p. 3/22)		
		3RB31 13	(p. 3/23)	3RB31 23	(p. 3/23)							3RB31 33	(p. 3/23)		
3RB22/23, solid-state, CLASS 5, 10, 20 and 30		3RB2.83+ 3RB29 06	0.3-25A (p. 3/34)									3RB22,	10-100A (p. 3/34)		
												3RB22, 3RB23 and 3RB24	with current measuring module		
3RV20 circuit-breakers (Section 1)															
Type		3RV20 11	0.18-16A (p. 1/4)	3RV20 21	11-40A (p. 1/4)							3RV20 31	9.5-80A (p. 1/5)		
Link modules		3RA29 11	(p. 1/10)	3RA29 21	(p. 1/10)							3RA29 31	(p. 1/10)		

3RA23 Reversing contractor assemblies

Complete units	Type	3RA2315	3RA2316	3RA2317	3RA2318	3RA2324	3RA2325	3RA2326	3RA2327	3RA2328	3RA2335	3RA2336	3RA2337	3RA2338
		(page 2/40)				(page 2/42)					(page 2/43)			
460 V	HP	3	5	7.5	10	7.5	10	15	20	25	30	40	50	50
Installation kits / wiring connectors		3RA2913-2AA1 (p. 2/81)				3RA2923-2AA1 (p. 2/81)					3RA2933-2AA1 (p. 2/81)			
Mechanical interlocks		3RA2912-2H (p. 2/82)				3RA2922-2H (p. 2/82)					3RA2934-2B (p. 2/80)			

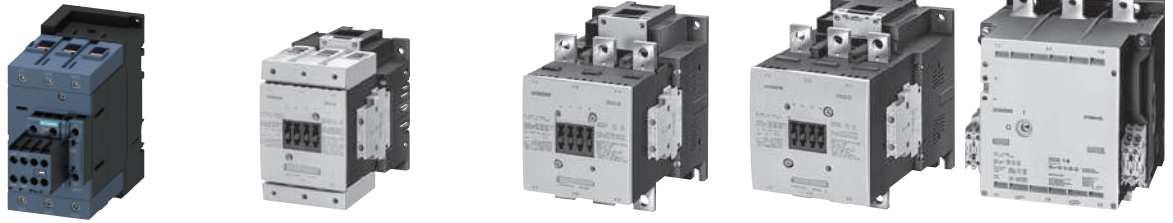

Type	S3 3RT2. 4			S6 3RT1. 5			S10 3RT1. 6			S12 3RT1. 7		S14 3TF6		
3RT20 contactors														
Type	3RT2045	3RT2046	3RT2047	3RT1054	3RT1055	3RT1056	3RT1064	3RT1065	3RT1066	3RT1075	3RT1076	—	—	
AC/DC operation	(p. 2/8)			(p. 2/9)			(p. 2/9)			(p. 2/9)				
Type							3RT1264	3RT1265	3RT1266	3RT1275	3RT1276	3TF68	3TF69	
AC/DC operation							(p. 2/10)			(p. 2/10)		(p. 2/53)		
Maximum 3-phase horsepower ratings at 460V (UL and CSA listed values)														
200 V	HP	25	30	30	40	50	60	60	75	100	125	150	200	290
230 V	HP	30	30	40	50	60	75	75	100	125	150	200	250	350
460 V	HP	60	75	75	100	125	150	150	200	250	300	400	500	700
575 V	HP	60	75	100	125	150	200	200	250	300	400	500	650	860
AC-3														
I_e /AC-3/400V	A	80	95	110	115	150	185	225	265	300	400	500	630	820
230 V	kW	22	22	30	37	45	55	55	75	90	132	160	200	260
400 V	kW	37	45	55	55	75	90	110	132	160	200	250	335	450
500 V	kW	45	55	75	75	90	110	160	160	200	250	355	434	600
690 V	kW	55	75	90	110	132	160	200	250	250	400	400/500	600	800
1000 V	kW	37	—	—	75	90	90	90/315	132/355	132/400	250/560	250/710	600	800
AC-4 (at $I_a = 6 \times I_e$)														
400 V	kW	37	45	55	55	75	90	110	132	160	200	250	355	400
400 V (200,000 operating cycles)	kW	17.9	22	24.3	29	38	45	54/78	66/93	71/112	84/140	98/161	168	191
AC-1 (40°C, ≤ 690V)														
I_e	A	125	130	130	160	185	215	275/330	330	330	430/610	610	700	910

Accessories for contactors

Auxiliary switch blocks	front lateral	3RH29 11	(p. 2/66)	3RH19 21	(p. 2/66)	—	—	—	—	—	—	—	—
		3RH29 21	(p. 2/68)	3RH19 21	(p. 2/68)	—	—	—	—	—	—	—	3TY7 561 (p. 2/53)
Terminal covers		3RT2946-4EA2	(p. 2/79)	3RT19 56-4EA1/2/3	(p. 2/79)	3RT19 66-4EA1/2/3	(p. 2/79)	—	—	—	—	—	3TX7 686/696 (p. 2/54)
Box terminals		—	—	3RT19 55/56-4G	(p. 2/79)	3RT19 66-4G	(p. 2/79)	—	—	—	—	—	—
Surge suppressor		3RT29 36	(p. 2/73)	3RT19 56-1C (RC element)	(p. 2/73)	—	—	—	—	—	—	—	3TX7 572 (p. 2/54)

3RU21 and 3RB3 overload relays (Section 3)

3RU21, thermal, CLASS 10	3RU21 46	18-100A	(p. 3/10)	—	—	—	—	—	—	—	—	—	—	
3RB30/31, solid-state, CLASS 5, 10, 20 and 30	3RB30 46	12.5-100A	(p. 3/22)	3RB20 56	50-200A	(p. 3/22)	3RB20 66	50-630A	(p. 3/22)	3RB20 66	160-630A	(p. 3/22)	3RB20 66	160-630A
	3RB31 43		(p. 3/23)	3RB21 56		(p. 3/23)	3RB21 66		(p. 3/23)	3RB21 66		(p. 3/22)	3RB21 66	(p. 3/22)
3RB22/23, solid-state, CLASS 5, 10, 20 and 30	—	—	—	3RB2.83 + 3RB29 56	20-200A	(p. 3/34)	3RB2.83 + 3RB29 56	63-640A	(p. 3/34)	—	—	—	—	

3RV20 circuit-breakers (Section 1)

Type	3RV20 41	45-100A	(p. 1/5)	—	—	—	—	—	—	—	—	—	—
Link modules	3RA19 41		(p. 1/10)	—	—	—	—	—	—	—	—	—	—

3RA23 Reversing contractor assemblies

Complete units	Type	3RA23 45	3RA23 46	3RA23 47	—	—	—	—	—	—	—	—	—	
		(p. 2/44)												
460 V	HP	60	75	75	100	125	150	150	200	250	300	400	500	700
Installation kits / wiring connectors		3RA2943-2AA1		(p. 2/81)	3RA1953-2A		(p. 2/81)	3RA1963-2A		(p. 2/81)	3RA1973-2A		(p. 2/81)	3TX7680-1A
Mechanical interlocks		3RA2934-2B			3RA1954-2A		(p. 2/80)	—	—	—	—	—	—	3TX7686-1A

Contactors for Switching Motors

3RT contactors, 3-pole – Size S00 to S3

CONTACTORS AND ASSEMBLIES 2

Selection and ordering data

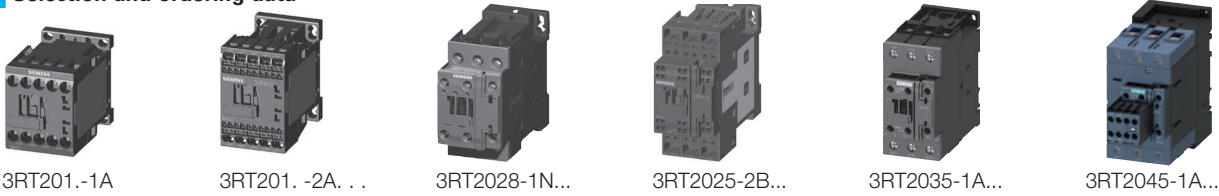

Frame Size	Amp Ratings		Single-phase HP ratings			Three-phase HP ratings				Auxiliary contacts		Screw Terminals	Spring-Loaded Terminals ¹⁾	Weight approx. kg
	AC3	AC1	115V	208V	230V	208V	230V	460V	575V	NO	NC	Order No.	Order No.	
3RT 3-pole contactors														
S00	6	18	0.25	0.5	0.75	1.5	2	3	5	1	0	3RT2015-1□●●1	3RT2015-2□●●1	0.24/0.29
	9	22	0.33	1	1	2	3	5	7.5	0	1	3RT2016-1□●●1	3RT2016-2□●●1	
	12	22	0.5	1.5	2	3	3	7.5	10	1	0	3RT2017-1□●●1	3RT2017-2□●●1	
	16	22	1	2	2	3	5	10	10	1	0	3RT2018-1□●●1	3RT2018-2□●●1	
S0	9	40	1	1	1	2	3	5	7.5	1	1	3RT2023-1□●●0	3RT2023-2□●●0	0.42/0.60
	12	40	1	2	2	3	3	7.5	10	1	1	3RT2024-1□●●0	3RT2024-2□●●0	
	17	40	1	2	3	5	5	10	15	1	1	3RT2025-1□●●0	3RT2025-2□●●0	
	25	40	2	3	3	7.5	7.5	15	20	1	1	3RT2026-1□●●0	3RT2026-2□●●0	
	32	50	2	5	5	10	10	20	25	1	1	3RT2027-1□●●0	3RT2027-2□●●0	
S2	40	50	3	5	5	10	10	25	25	1	1	3RT2028-1□●●0	3RT2028-2□●●0	0.99/1.121
	50	60	3	5	7.5	10	15	30	40	1	1	3RT2035-1□●●0	3RT2035-3□●●0	
	65	70	3	7.5	10	15	15	40	50	1	1	3RT2036-1□●●0	3RT2036-3□●●0	
	80 ²⁾	80	5	10	10	20	20	50	50	1	1	3RT2037-1□●●0	3RT2037-3□●●0	
S3	80	90	5	10	15	20	25	50	60	1	1	3RT2038-1□●●0	3RT2038-3□●●0	1.8/2.8
	80	125	7.5	10	15	25	30	60	60	1	1	3RT2045-1□●●0	3RT2045-3□●●0	
	95	130	10	10	20	30	30	75	75	1	1	3RT2046-1□●●0	3RT2046-3□●●0	
	110	130	10	10	20	30	40	75	100	1	1	3RT2047-1□●●0	3RT2047-3□●●0	
Size S2 & S3 only: Replace "B" with "K" for 24VDC coil only Size S0-S3 only: UC Electronic with integrated varistor												<input type="checkbox"/> A <input type="checkbox"/> B <input type="checkbox"/> N		

NEMA Size	Amp Ratings	Single-phase HP ratings		Three-phase HP ratings				Auxiliary contacts		Screw Terminals with AC coil	Screw Terminals with 24 VDC coil	Weight approx. kg
		115V	230V	208V	230V	460V	575V	NO	NC	Order No.	Order No.	
NEMA Labeled Contactors												
0	18	1	2	3	3	5	5	1	0	3RT2018-1A●●1-0UA0	3RT2018-1BB41-0UA0	0.28
1	27	2	3	7.5	7.5	10	10	1	1	3RT2027-1A●●0-0UA0	3RT2027-1BB40-0UA0	0.42
2	45	3	7.5	10	15	25	25	1	1	3RT2036-1A●●0-0UA0	3RT2036-1NB30-0UA0	0.986/1.121
3	90	7.5	15	25	30	50	50	1	1	3RT2046-1A●●0-0UA0	3RT2046-1NB40-0UA0	1.8 / 2.8

1) All terminals are spring loaded on frame sizes S00 & S0. Only the coil terminals are spring loaded on frame sizes S2 & S3.
 2) Max UL FLA = 65A at 460V

Note: Ring lug terminals are also available in size S00 & S0 contactors, except contactors with communication interface or UC coil. Change the 8th digit of the order number to a "4", e.g. 3RT2015-4AK61.

For further coil voltages, see page 2/49.
 For auxiliaries and accessories, see page 2/66-2/83.
 For spare parts, see page 2/94-2/99.
 For technical data, see page 2/121-2/142.
 For description, see page 2/104-2/105.
 For int. circuit diagrams, see page 2/193-2/200.
 For dimension drawings, see page 2/212-2/215.

AC Coil Selection for 3RT201 through 3RT204

●●Coil Code	C2 ²⁾	H2 ³⁾	K6	P6	U6	V6	T6
60 Hz	24 V	48 V	120 V	240 V	277 V	480 V	600 V
50 Hz	24 V	48 V	110 V	220 V	—	—	—

²⁾ Use Code B0 for 3RT201, S00
³⁾ Use Code H0 for 3RT201, S00

DC Coil Selection for 3RT201 & 3RT202 (for 3RT203 & 3RT204 see UC)

●●Coil Code	A4 ⁴⁾	B4	W4	E4	F4	G4	M4
DC	12 V	24 V	48 V	60 V	110 V	125 V	220 V

⁴⁾ 3RT201 and 3RT202 only

UC Coil Selection for 3RT202

●●Coil Code	B3	F3	P3 ⁴⁾
UC	21-28V	95-130V	200-280V

UC Coil Selection for 3RT203 & 3RT204

●●	B3	F3	P3 ⁵⁾
UC	20-33V	83-155V	175-280V

⁵⁾ at upper limit = 1.1 x U_s

Contactors for Switching Motors

3RT contactors, 3-pole – Size S6-S12 and NEMA size 4-6

Selection and ordering data

- * AC/DC Coils with built in surge suppressor
- * Coil Types (40Hz to 60Hz, DC):
- * Conventional Coil
- * Solid-state operated coil with wider range and 24 V DC PLC input
- * Solid-state operated coil with Remaining Lifetime Indication (RLT)
- * Box terminals ordered separately



3RT1056-6PF35



3RT1054-6SF36

Frame Size	Amp Ratings		Single-phase HP ratings		Three-phase HP ratings				Auxiliary contacts		Screw Terminals on coil and aux. Order No.	Spring-type terminals on coil and aux. contacts Order No.	Weight approx. kg
	AC3	AC1	115V	230V	200V	230V	460V	575V	NO	NC			
3RT 3-pole Contactors													
S6	115	160	—	25	40	50	100	125	2	2	3RT1054-6□●●6	3RT1054-2□●●6	3.5
	150	185	—	30	50	60	125	150	2	2	3RT1055-6□●●6	3RT1055-2□●●6	
	185	215	—	30	60	75	150	200	2	2	3RT1056-6□●●6	3RT1056-2□●●6	
S10	225	275	—	—	60	75	150	200	2	2	3RT1064-6□●●6	3RT1064-2□●●6	6.7
	265	330	—	—	75	100	200	250	2	2	3RT1065-6□●●6	3RT1065-2□●●6	
	300	330	—	—	100	125	250	300	2	2	3RT1066-6□●●6	3RT1066-2□●●6	
S12	400	430	—	—	125	150	300	400	2	2	3RT1075-6□●●6	3RT1075-2□●●6	10.5
	500	610	—	—	150	200	400	500	2	2	3RT1076-6□●●6	3RT1076-2□●●6	
UC Conventional Coil □ Solid State Operated Coil = A Solid State Operated Coil with RLT = N Solid State Fail-safe Coil = P ●●5 S S													

NEMA Size	Amp Ratings	Single-phase HP ratings		Three-phase HP ratings				Auxiliary contacts		Screw Terminals on coil and aux. Order No.	Spring-type terminals on coil and aux. contacts Order No.	Weight approx. kg
		115V	230V	200V	230V	460V	575V	NO	NC			
NEMA Labeled Contactors												
4	135	—	—	40	50	100	100	2	2	3RT1056-6A●●6-0UA0	—	3.5
5	270	—	—	75	100	200	200	2	2	3RT1066-6A●●6-0UA0	—	6.7
6	540	—	—	150	200	400	400	2	2	3RT1076-6A●●6-0UA0	—	10.5

All coil voltages are in the adjacent table.
 For auxiliaries and accessories, see page 2/66-2/83.
 For spare parts, see page 2/94-2/99.
 For technical data, see page 2/146-2/154.
 For description, see page 2/106-2/107.
 For int. circuit diagrams, see page 2/199-2/201.
 For dimension drawings, see page 2/216-2/217.

Sizes S6 to S12 Coil Codes - UC operation (AC 50 to 60 Hz and DC)

UC Conventional Coil		Solid-State Coil			
Rated control supply voltage Us Us min ... Us max ¹⁾	3RT1. 5.-A 3RT1. 6.-A 3RT1. 7.-A	Rated control supply voltage Us Us min ... Us max ¹⁾	3RT1. 5.-S 3RT1. 6.-S 3RT1. 7.-S	3RT1. 5.-N 3RT1. 6.-N 3RT1. 7.-N	3RT1. 5.-P 3RT1. 6.-P 3RT1. 7.-P
Coil Codes	●●	Coil Codes	●●	●●	●●
23 ... 26 V AC/DC	B3	21 ... 27.3 V AC/DC	—	B3	—
42 ... 48 V AC/DC	D3	96 ... 127 V AC/DC	F3	F3	F3
110 ... 127 V AC/DC	F3	200 ... 277 V AC/DC	P3	P3	P3
200 ... 220 V AC/DC	M3				
220 ... 240 V AC/DC	P3				
240 ... 277 V AC/DC	U3				
380 ... 420 V AC/DC	V3				
440 ... 480 V AC/DC	R3				
500 ... 550 V AC/DC	S3				
575 ... 600 V AC/DC	T3				

1) Operating range:
 0.8 x Us min to 1.1 x Us max.

Contactors for Switching Motors

3RT12 vacuum contactors, 3-pole

Selection and ordering data

- AC/DC operation (40 Hz ... 60 Hz, DC)
- Withdrawable coils
- Integrated coil circuit (varistor)
- Auxiliary and control conductors: screw connections
- Main conductor: bar connections

Size	Horsepower ratings and utilization categories					Auxiliary contacts, lateral			Rated control supply voltage U_s	Order No.	Weight approx. kg	
	AC-3 Maximum inductive current	Ratings of three-phase motors				AC-1 Maximum resistive current						
		200 V	230 V	460 V	575 V							
Amps	HP	HP	HP	HP	Amps	NO	NC	AC/DC V				
Conventional operating mechanism												
3RT12 6.	S10	225	60	75	150	200	330	2	2	110 ... 127 220 ... 240	3RT12 64-6AF36 3RT12 64-6AP36	6.4
		265	75	100	200	250	330	2	2	110 ... 127 220 ... 240	3RT12 65-6AF36 3RT12 65-6AP36	
		300	100	125	250	300	330	2	2	110 ... 127 220 ... 240	3RT12 66-6AF36 3RT12 66-6AP36	
3RT12 7.	S12	400	125	150	300	400	610	2	2	110 ... 127 220 ... 240	3RT12 75-6AF36 3RT12 75-6AP36	9.6
		500	150	200	400	500	610	2	2	110 ... 127 220 ... 240	3RT12 76-6AF36 3RT12 76-6AP36	
Solid-state operating mechanism - for DC 24 V PLC output												
3RT12 6.	S10	225	60	75	150	200	330	2	2	96 ... 127 200 ... 277	3RT12 64-6NF36 3RT12 64-6NP36	6.4
		265	75	100	200	250	330	2	2	96 ... 127 200 ... 277	3RT12 65-6NF36 3RT12 65-6NP36	
		300	100	125	250	300	330	2	2	96 ... 127 200 ... 277	3RT12 66-6NF36 3RT12 66-6NP36	
3RT12 7.	S12	400	125	150	300	400	610	2	2	96 ... 127 200 ... 277	3RT12 75-6NF36 3RT12 75-6NP36	9.6
		500	150	200	400	500	610	2	2	96 ... 127 200 ... 277	3RT12 76-6NF36 3RT12 76-6NP36	



Universal Coil Selection for 3RT126 through 3RT127: Conventional Operation

Coil Code	B3	D3	F3	M3	P3	U3	V3	R3	S3	T3
Volts AC/DC 40 - 60 Hz, DC	23 .. 26 V	42 .. 48 V	110 .. 127 V	200 .. 220 V	220 .. 240 V	240 .. 277 V	380 .. 420 V	440 .. 480 V	500 .. 550 V	575 .. 600 V

Solid State Selection for 3RT126 through 3RT127: Solid-State

Coil Code	B3	F3	P3
Volts AC/DC 40 - 60 Hz, DC	21 .. 27.3 V	96 .. 127 V	200 .. 277 V

For further vacuum contactors, 500Hp and 700Hp (3TF68/69), see page 2/53.
 For auxiliaries and accessories, see page 2/68 .
 For spare parts, see page 2/98-2/99.
 For technical data, see page 2/155-2/160.
 For int. circuit diagrams, see page 2/199
 For dimension drawings, see page 2/218.

Contactors for Special Applications

3RT23 contactors, 4-pole (4 NO contacts) for switching resistive loads (AC-1)

Standards

IEC 60947-1, EN 60947-1
 IEC 60947-4-1, EN 60947-4-1
 IEC 60947-5-1, EN 60947-5-1 (auxiliary switches)

Design

The contactors are suitable for use in any climate. They are safe from touch to DIN VDE 0106, Part 100. The accessories for the 3-pole SIRIUS contactors can also be used for the 4-pole designs.

Mountable auxiliary contacts

Size S00: 4 auxiliary contacts of which up to 3 can be NC.
 Size S0 & S2: 4 additional auxiliary contacts up to 3 can be NC.
 Sizes S2 and S3: Up to 4 auxiliary contacts (either laterally mounted or snapped onto the top).

Contactor assemblies with mechanical interlock

The 4-pole 3RT23 contactors with 4 NO contacts as the main contacts are suitable for making contactor assemblies with a mechanical interlock, e.g. for system transfers.

Size S00: Contactor assemblies can be made using two 3RT231. contactors in conjunction with the mechanical interlock and two connecting clips (Order No. 3RA2912-2H, pack comprising 10 interlocking elements and 20 clips for 10 contactor assemblies, see accessories on page 2/72).

Size S0: In order to make 4-pole contactor assemblies using two 3RT232. contactors, the fourth pole of the left-hand contactor must always be moved to the left-hand side. The contactor assembly can then be made easily with the aid of the 3RA2922-2H mechanical interlock and connecting clip set fitted between the two contactors.

Sizes S2 and S3: Contactor assemblies can be made using two 3RT23 3 or 3RT23 4. contactors in conjunction with the laterally mountable mechanical interlock and the mechanical connectors. The mechanical interlock for fitting onto the front cannot be used for size S2 and S3 contactors.

Application

- Switching resistive loads
- Isolating systems with unearthed or poorly earthed neutral conductors
- System transfers when alternative AC power supplies are used
- As contactors which only carry current and do not have to switch in case of inductive loads – e.g. variable-speed operating mechanisms
- Switching mixed loads in distribution systems (e.g. for supplying heaters, lamps, motors, PC power supply units) with p.f. > 0.8 according to IEC 60947-4-1, test conditions for utilization category AC-1

Selection and ordering data

Rating data			Auxiliary contacts			Rated control supply voltage U_s 50/60 Hz V AC	AC Operation Screw Terminals ¹⁾ Order No.	Rated control supply voltage U_s V DC	DC Operation Screw Terminals ¹⁾ Order No.
AC-1 Max resist. current I_e 40°C 60°C Amps	UL ratings AC loads at 600 V, 60 Hz Amps	Ident-ification No.	Version						
				NO	NC				

For screwing and stepping onto 35 mm mounting rail

3RT23 17-1AP60



Size S00 – Auxiliary switches can be retrofitted

18	16	18	–	–	–	24 110/120 220/240	3RT23 16-1AB00 3RT23 16-1AK60 3RT23 16-1AP60	24 125 220	3RT23 16-1BB40 3RT23 16-1BG40 3RT23 16-1BM40
22	20	20	–	–	–	24 110/120 220/240	3RT23 17-1AB00 3RT23 17-1AK60 3RT23 17-1AP60	24 125 220	3RT23 17-1BB40 3RT23 17-1BG40 3RT23 17-1BM40

Size S0 – Terminal designations according to EN 50012 – 1 NO + 1 NC, identification number 11E

35 ²⁾	30 ²⁾	30	11E	1	1	24 110/120 220/240	3RT23 25-1AC20 3RT23 25-1AK60 3RT23 25-1AP60	24 125 220	3RT23 25-1BB40 3RT23 25-1BG40 3RT23 25-1BM40
40 ²⁾	35 ²⁾	35	11E	1	1	24 110/120 220/240	3RT23 26-1AC20 3RT23 26-1AK60 3RT23 26-1AP60	24 125 220	3RT23 26-1BB40 3RT23 26-1BG40 3RT23 26-1BM40
50 ²⁾	42 ²⁾	38	11E	1	1	24 110/120 220/240	3RT23 27-1AC20 3RT23 27-1AK60 3RT23 27-1AP60	24 125 220	3RT23 27-1BB40 3RT23 27-1BG40 3RT23 27-1BM40

Size S2

60	55	60	11E	1	1	24 110/120 220/240	3RT23 36-1AC20 3RT23 36-1AK60 3RT23 36-1AP60	20-33 83-155 175-280	3RT23 36-1NB30 3RT23 36-1NF30 3RT23 36-1NP30
110	95	105	11E	1	1	24 110/120 220/240	3RT23 37-1AC20 3RT23 37-1AK60 3RT23 37-1AP60	20-33 83-155 175-280	3RT23 37-1NB30 3RT23 37-1NF30 3RT23 37-1NP30

Size S3

140	130	120	–	–	–	24 110/120 220/240	3RT23 46-1AC20 3RT23 46-1AK60 3RT23 46-1AP60	20-33 83-155 175-280	3RT23 46-1NB30 3RT23 46-1NF30 3RT23 46-1NP30
-----	-----	-----	---	---	---	--------------------------	--	----------------------------	--

3RT23 27-1AP60



3RT23 36-1AP60



1) Size S00 and S0 contactors are also available with spring-type terminals. Replace the 8th digit of the order no. with a "2" e.g. "3RT23 16-2AK60"

2) Minimum conductor cross-section 8 AWG.

For further voltages, see page 2/49.
 For coil voltage tolerance, p. 2/49
 For auxiliaries and accessories, see page 2/66-2/83.
 For spare parts, see page 2/94-2/99.

For technical data, see page 2/169-2/170.
 For in. circuit diagrams, see page 2/194-2/199.
 For dimension drawings, see page 2/219.

Contactors for Special Applications

3RT24, 3-pole for switching resistive loads (AC-1)

Application

AC and DC operation (size S3)
UC operation (AC/DC) (sizes S6 to S12)

IEC 60 947, EN 60 947 (VDE 0660)

The contactors are suitable for use in any climate. They are safe from touch to DIN VDE 0106 Part 100.

3RT14/3RT24 contactors are used for switching resistive loads.

(AC-1) or as contactors, for example in variable-speed drives which normally only have to carry the current.

The accessories for the SIRIUS 3RT10/3RT20 contactors can also be used here.

Selection and ordering data

3RT24 46-1A..0



Ratings AC-1 utilization category,		UL Ratings			Rated control supply voltage U_c	Order No.	Weight approx. kg
Maximum current	IEC Ratings	Max Current	230/240V	460/480V			
Amps	Rated power of three phase loads $\cos \phi = 0.95$ (@ 60°C) 230V kW 400V kW 500V kW 690V kW	Amps	Hp	Hp	Hp		

With screw connections · for screwing and snapping onto 35 mm and 75 mm standard mounting rails

Size S3 · (without auxiliary contacts)

• **AC operation**

140	50	86	107	148	140	15	30	40	24 V, 50/60 Hz 120 V, 60 Hz 240 V, 60 Hz	3RT24 46-1AC2 0 3RT24 46-1AK6 0 3RT24 46-1AP6 0	1.8
-----	----	----	-----	-----	-----	----	----	----	--	---	-----

• **DC operation · DC solenoid system**

140	50	86	107	148	131	15	30	40	DC 24 V DC 48 V	3RT24 46-1BB4 0 3RT24 46-1BW40	2.7
-----	----	----	-----	-----	-----	----	----	----	--------------------	-----------------------------------	-----

- **AC/DC operation** (40 Hz ... 60 Hz, DC)
- **Withdrawable coils**
- **Integrated coil circuit** (varistor)
- **Auxiliary and control conductors: screw connections**
- **Main conductor: bar connections**

3RT14 6.



Size	Ratings AC-1 utilization category,	UL Rating	Auxiliary contacts, lateral		Rated control supply voltage U_c	Order No.	Weight approx. kg
AC-1 Maximum resistive current	IEC Ratings	Max Current	NO	NC			
Amps	Rated power of three phase loads $\cos \phi = 0.95$ (@ 60°C) 230V kW 400V kW 500V kW 690V kW	Amps					

Conventional operating mechanism

S6	275	95	165	205	285	210	2	2	110 ... 127 220 ... 240	3RT14 56-6AF36 3RT14 56-6AP36	3.1
S10	400	145	250	315	430	360	2	2	110 ... 127 220 ... 240	3RT14 66-6AF36 3RT14 66-6AP36	5.7
S12	690	245	430	535	740	580	2	2	110 ... 127 220 ... 240	3RT14 76-6AF36 3RT14 76-6AP36	9.1

Solid-state operating mechanism · for DC 24 V PLC output

S6	275	95	165	205	285	210	2	2	96 ... 127 200 ... 277	3RT14 56-6NF36 3RT14 56-6NP36	3.1
S10	400	145	250	315	430	360	2	2	96 ... 127 200 ... 277	3RT14 66-6NF36 3RT14 66-6NP36	5.7
S12	690	245	430	535	740	580	2	2	96 ... 127 200 ... 277	3RT14 76-6NF36 3RT14 76-6NP36	9.1

Solid-state operating mechanism · for DC 24 V PLC with remaining lifetime indication

S6	275	95	165	205	285	210	1	1	96 ... 127 200 ... 277	3RT14 56-6PF35 3RT14 56-6PP35	3.1
S10	400	145	250	315	430	360	1	1	200 ... 277	3RT14 66-6PP35	5.7
S12	690	245	430	535	740	580	1	1	200 ... 277	3RT14 76-6PP35	9.1

3RT14 7.



Coil Code	B3	D3	F3	M3	P3	U3	V3	R3	S3	T3
Volts AC/DC 40 - 60 Hz, DC	23 ... 26 V	42 ... 48 V	110 ... 127 V	200 ... 220 V	220 ... 240 V	240 ... 277 V	380 ... 420 V	440 ... 480 V	500 ... 550 V	575 ... 600 V

Coil Code	B3	F3	P3
Volts AC/DC 40 - 60 Hz, DC	21 ... 27.3 V	96 ... 127 V	200 ... 277 V

Note: B3 code not available for Remaining Lifetime Contactors.

For further coil voltages, see page 2/49.
 For auxiliaries and accessories, see page 2/66-2/83.
 For spare parts, see page 2/94-2/99.
 For technical data, see page 2/161-2/168.
 For int. circuit diagrams, see page 2/199.
 For dimension drawings, see page 2/214, 2/216-2/217.

Contactors for Special Applications

3RT25 contactors, 4-pole (2 NO + 2 NC) contacts for switching motors

AC and DC operation

IEC 60 947-4-1/EN 60 947-4-1
(VDE 0660, Part 102)

Design

The contactors are suitable for use in any climate. They are safe to touch according to EN 50274. The accessories for the 3-pole SIRIUS contactors can also be used for the 4-pole designs.

Mountable auxiliary contacts

Size S00 and S0:

4 auxiliary contacts, of which up to 4 can be NC contacts.

Size S2

Up to 4 auxiliary contacts (either laterally mounted or snapped onto the top; auxiliary switch blocks to EN 50 012 and EN 50 005)

Application

- Changing the polarity of hoisting gear motors
- Switching two separate loads from the same source

Selection and ordering data

Rating data				Auxiliary contacts Version		Rated control supply voltage U_s	AC Operation ²⁾ Screw terminals	Rated control supply voltage U_s	DC Operation ²⁾ Screw terminals
AC-2/AC-3 T_U : up to 60°C		AC-1 Max resistive current		NO	NC				
Max Current I_e at 400 V	Max motor HP at 460 V, 60 Hz	40°C	60°C			V AC, 50/60 Hz	Order No.	V DC	Order No.
Amps	NO NC	Amps							

For screwing and snapping onto 35 mm standard mounting rail

3RT25 16-1AB00

Size S00 ³⁾ - Auxiliary switches can be retrofitted

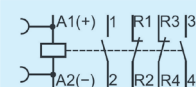

9	5	18	16	—	—	24	3RT25 16-1AB00	24	3RT25 16-1BB40
						110/120	3RT25 16-1AK60	125	3RT25 16-1BG40
						220/240	3RT25 16-1AP60	220	3RT25 16-1BM40
12	7.5 ⁴⁾	22	20	—	—	24	3RT25 17-1AB00	24	3RT25 17-1BB40
						110/120	3RT25 17-1AK60	125	3RT25 17-1BG40
						220/240	3RT25 17-1AP60	220	3RT25 17-1BM40
16	10 ⁴⁾	22	20	—	—	24	3RT25 18-1AB00	24	3RT25 18-1BB40
						110/120	3RT25 18-1AK60	125	3RT25 18-1BG40
						220/240	3RT25 18-1AP60	220	3RT25 18-1BM40

3RT25 26-1AC20

Size S0 - Terminal designations according to EN 50012, 1 NO + 1 NC, identification number 11E

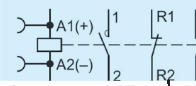
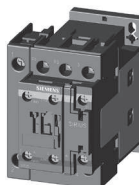

25	15	15	40	35	1	1	24	3RT25 26-1AC20	24	3RT25 26-1BB40
							110/120	3RT25 26-1AK60	125	3RT25 26-1BG40
							220/240	3RT25 26-1AP60	220	3RT25 26-1BM40

3RT25 35-1AC20

Size S2

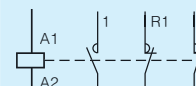

35	30	20	60	55	1	1	24	3RT25 35-1AC20	V UC	3RT25 35-1NB30
							110/120	3RT25 35-1AK60	20-33	3RT25 35-1NF30
							220/240	3RT25 35-1AP60	83-155	3RT25 35-1NP30
41	30	25	70	60	1	1	24	3RT25 36-1AC20	175-280	3RT25 36-1NB30
							110/120	3RT25 36-1AK60	20-33	3RT25 36-1NF30
							220/240	3RT25 36-1AP60	83-155	3RT25 36-1NP30
							220/240	3RT25 36-1AP60	175-280	3RT25 36-1NP30

For further voltages, see page 2/49.
For auxiliaries and accessories, see page 2/66-2/83.
For spare parts, see page 2/94-2/99.
For technical data, see page 2/171-2/172.
For int. circuit diagrams, see page 2/194-2/199.
For dimension drawings, see page 2/219.

1) For changing polarity; not suitable for reversing.
2) Size S00 and S0 contactors are also available with spring-type terminals. Replace the 8th digit of the order no. with a "2" e.g. "3RT25 16-2AK60"

3) Size S00:
Coil voltage tolerance
at 50 Hz: 0.8 ... 1.1 x U_s
at 60 Hz: 0.85 ... 1.1 x U_s
4) The NC contact can switch up to 5 HP.

3RT, 3RH Contactors for Special Applications

3RH21 contactor relays

CONTACTORS AND ASSEMBLIES 2

Overview

DC operation

IEC 60947-4-1, EN 60947-4-1, for requirements according to IEC 60077-1 and IEC 60077-2.

The contactor relays are finger-safe according to EN 50274. The size S00 contactor relays have spring-type connections for all terminals.

Ambient temperature

The permissible ambient temperature for operation of the contactor relays (across the full coil operating range) is -40 to +70 °C.

Uninterrupted duty at temperatures > +60 °C reduces the mechanical endurance, the current carrying capacity of the conducting paths and the switching frequency.

Control and auxiliary circuits

The solenoid coils of the contactor relays have an extended coil operating range from 0.7 to 1.25 x U_s and are fitted as standard with suppressor diodes to provide protection against overvoltage. The opening delay is consequently 2 to 5 ms longer than for standard contactors.

Application

For operation in installations which are subject both to considerable variations in the control voltage and to high ambient temperatures, e. g. railway applications under extreme climatic conditions, rolling mills, etc.

Also for control supply voltages with battery buffer for longer operating times should the battery charging fail.

Contactor relays without series resistor

Control and auxiliary circuits

These contactor relays have an extended operating range from 0.7 to 1.25 x U_s ; the solenoid coils are fitted with a suppressor diode. An additional series resistor is not required.

Note:

An additional auxiliary switch block cannot be mounted.

Side-by-side mounting

A clearance of 10 mm is required for side-by-side mounting at ambient temperatures > 60 °C ≤ 70 °C.

Contactor relays with series resistor

Control and auxiliary circuits

The DC solenoid systems of the contactor relays are modified (to hold-in coil) by means of a series resistor.

The size S00 contactor relays are supplied prewired with a plug-on module containing the series resistor. The suppressor diode is integrated.

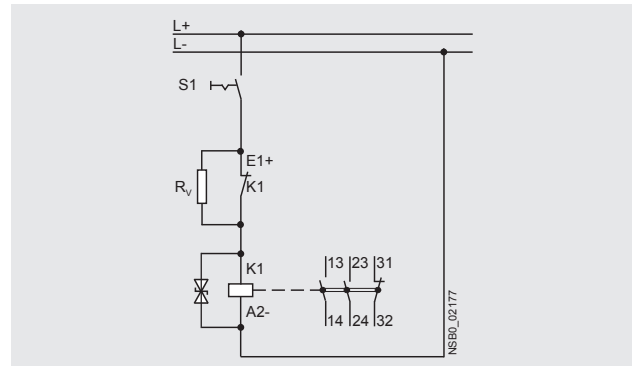

A 4-pole auxiliary switch block (according to EN 50005) can be fitted additionally.

Side-by-side mounting

Side-by-side mounting is permitted at ambient temperatures up to 70 °C.

3RT, 3RH Contactors for Special Applications

3RH21 contactor relays

Selection and ordering data

DC operation · DC solenoid system
Spring-type terminals
For screw and snap-on mounting onto standard mounting rail
Solenoid coil fitted with suppressor diode



3RH21 22-2K.40



3RH21 22-2K.40-0LA0

Rated operational current I_e /AC-15/AC-14 T_{ij} : 70 °C at	Contacts	Rated control supply voltage U_s	Spring-type terminals	Weight approx.
230 V 400 V 500 V 690 V	Version			
A A A A	NO NC	V DC	Order No.	kg

3RH21 contactor relays

Size S00

Without series resistor

Terminal designations according to EN 50011

2 NO + 2 NC, identification number **22E**

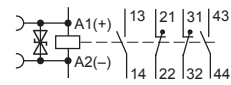

10	3	2	1	2	2 ¹⁾	24	
						110	

3RH21 22-2KB40	0.300
3RH21 22-2KF40	0.300

With series resistor

Terminal designations according to EN 50005

2 NO + 1 NC, identification number **21E**

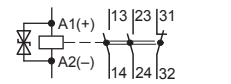

10	3	2	1	2	1 ²⁾	24	
						110	

3RH21 22-2KB40-0LA0	0.300
3RH21 22-2KF40-0LA0	0.300

¹⁾ It is not possible to mount an auxiliary switch block.
²⁾ 4-pole auxiliary switch block according to EN 50005 can be mounted.

More information

Contactors	Type	3RH21 ..
Upright mounting position		
• Contactors with series resistor		Special version (on request)
• Contactors without series resistor		Special version (on request)
Ambient temperature		
• During operation	°C	-40 ... +70
• During storage	°C	-55 ... +80
Solenoid coil operating range DC		
		0.7 ... 1.25 x U_s
Power consumption of the solenoid coils		
For cold coil and 1.0 x U_s		
• Contactors with series resistor	- Closing	W 13
	- Closed	W 4
• Contactors without series resistor	- Closing	W 2.8
	- Closed	W 2.8

All specifications and technical specifications not mentioned here are identical to those of the standard contactor relays.

3RT, 3RH Contactors for Special Applications

3RT20 motor contactors, 7.5 ... 25 HP

Overview

DC operation

IEC 60947-4-1, EN 60947-4-1, for requirements according to IEC 60077-1 and IEC 60077-2.

The contactors are finger-safe according to EN 50274. The contactors have spring-type connections as well as screw connections. The size S00 and S0 contactors have spring-type connections for all terminals.

Ambient temperature

The permissible ambient temperature for operation of the contactors (across the full coil operating range) is -40 to $+70$ °C.

Uninterrupted duty at temperatures $> +60$ °C reduces the mechanical endurance, the current carrying capacity of the conducting paths and the switching frequency.

Control and auxiliary circuits

The solenoid coils of the contactor relays have an extended coil operating range from 0.7 to 1.25 or $1.3 \times U_s$ and are fitted as standard with suppressor diodes. The opening delay is consequently 2 to 5 ms longer than for standard contactors.

Application

For operation in installations which are subject both to considerable variations in the control voltage and to high ambient temperatures, e. g. railway applications under extreme climatic conditions, rolling mills, etc.

Also for control supply voltages with battery buffer for longer operating times should the battery charging fail.

Contactors without series resistor

Control and auxiliary circuits

These contactors have an extended operating range from 0.7 to $1.25 \times U_s$; on size S00 the coils are fitted with suppressor diodes, on size S0 with varistors. An additional series resistor is not required.

Note:

An additional auxiliary switch block cannot be mounted.

Side-by-side mounting

A clearance of 10 mm is required for side-by-side mounting at ambient temperatures > 60 °C ≤ 70 °C.

3RT20 1. contactors with series resistor

Control and auxiliary circuits

The solenoid coils of the contactors have an extended coil operating range from 0.7 to $1.25 \times U_s$ and are fitted as standard with suppressor diodes to provide protection against overvoltage.

The DC solenoid systems of the contactors are modified (to holding excitation) by means of a series resistor.

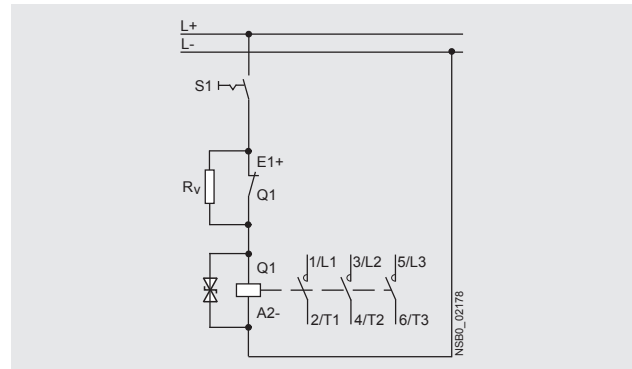

The size S00 contactors are supplied prewired with a plug-on module containing the series resistor. The suppressor diode is integrated. A 4-pole auxiliary switch block (according to EN 50005) can be fitted additionally.

A circuit diagram showing the terminals is labeled on each contactor. One NC of the auxiliary contacts is required for the series resistor function. The selection and ordering data shows the number of additional, unassigned auxiliary contacts. With size S00 it is possible to extend the number of auxiliary contacts.

Side-by-side mounting

At ambient temperatures up to 70 °C, the size S00 contactors and contactor relays are allowed to be mounted side by side.

3RT20 2. contactors with solid-state operating mechanism, extended operating range

Control and auxiliary circuits

The solenoid coils of the contactors have an extended coil operating range from 0.7 to $1.3 \times U_s$ and are fitted as standard with varistors to provide protection against overvoltage.

The contactors are energized via upstream control electronics which ensure the coil operating range of 0.7 to $1.3 \times U_s$ at an ambient temperature of 70 °C. They are supplied as complete units with integrated coil electronics. A varistor is integrated for damping opening surges in the coil.

The mounting possibilities for auxiliary switches correspond to those of the standard contactors for switching motors in the matching size (see page 2/58).

Side-by-side mounting

Side-by-side mounting is permitted at ambient temperatures up to 70 °C for these contactor versions in size S0.

3RT, 3RH Contactors for Special Applications

3RT20 motor contactors, 7.5 ... 25 HP

Selection and ordering data

DC operation · DC solenoid system
Spring-type terminals
For screw and snap-on mounting onto standard mounting rail
Solenoid coil fitted with suppressor diode (S00)



3RT20 1.-2K.4.



3RT20 1.-2K.42-0LA0

Rated data AC-3		Auxiliary contacts		Rated control supply voltage U_s	Spring-type terminals	Weight approx.
Operational current I_e at	Ratings of induction motors at	Ident. No.	Version			
400 V	200 V 230 V 460 V 575 V					
A	HP HP HP HP			V DC	Order No.	kg

3RT20 contactors for switching motors

Size S00

Without series resistor⁴⁾

Terminal designations according to EN 50012 or EN 50005

- 1 NO, identification number **10E**

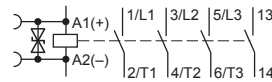

- 1 NC, identification number **01**

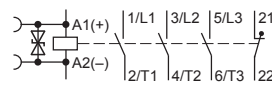

12	--	3	7.5	10	10E¹⁾	1	--	24 125	3RT20 17-2KB41 3RT20 17-2KG41	0.300 0.300
12	--	3	7.5	10	01¹⁾	--	1	24 125	3RT20 17-2KB42 3RT20 17-2KG42	0.300 0.300

With series resistor

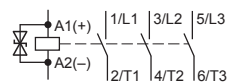

12	--	3	7.5	10	-- ²⁾	--	1 ³⁾	24 125	3RT20 17-2KB42-0LA0 3RT20 17-2KG42-0LA0	0.300 0.300
16	--	5	10	10	-- ²⁾	--	1 ³⁾	24 125	3RT20 18-2KB42-0LA0 3RT20 18-2KG42-0LA0	0.300 0.300

For accessories and spare parts, see page 2/66-2/69.

- 1) It is not possible to mount an auxiliary switch block. A clearance of 10 mm is required for side-by-side mounting at ambient temperatures > 60 °C.
- 2) One 4-pole auxiliary switch block according to EN 50005 can be mounted; no distance required up to 70 °C.
- 3) NC contact cannot be used because it is required for switching the series resistor.
- 4) Versions available with screw terminals.

3RT, 3RH Contactors for Special Applications

3RT20 motor contactors, 7.5 ... 25 HP

DC operation - DC solenoid system
Spring-type terminals
 For screw and snap-on mounting onto standard mounting rail
 Solenoid coil fitted with varistor (S0)



3RT20 2.-2K.40

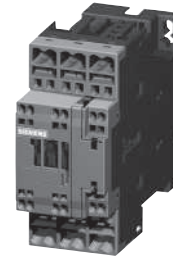

3RT20 2.-2X.40-0LA2

CONTACTORS AND ASSEMBLIES

Rated data AC-3	Auxiliary contacts	Rated control supply voltage U_s	Spring-type terminals	Weight approx.
Operational current I_e at	Ident. No.	Version	Order No.	
400 V		NO NC		kg
200 V 230 V 460 V 575 V				
A HP HP HP HP				

3RT20 contactors for switching motors

Size S0

Terminal designations according to EN 50012

1 NO + 1 NC, identification number **11E**

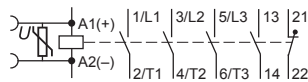

Without series resistor¹⁾

16	--	5	10	15	11E	1	1	24 125	3RT20 25-2KB40 3RT20 25-2KG40	0.600 0.600
25	--	7.5	15	20	11E	1	1	24 125	3RT20 26-2KB40 3RT20 26-2KG40	0.600 0.600
32	--	10	20	25	11E	1	1	24 125	3RT20 27-2KB40 3RT20 27-2KG40	0.600 0.600

With solid-state operating mechanism

16	--	5	10	15	11E	1	1	24 125	3RT20 25-2XB40-0LA2 3RT20 25-2XG40-0LA2	0.580 0.580
25	--	7.5	15	20	11E	1	1	24 125	3RT20 26-2XB40-0LA2 3RT20 26-2XG40-0LA2	0.580 0.580
32	--	10	20	25	11E	1	1	24 125	3RT20 27-2XB40-0LA2 3RT20 27-2XG40-0LA2	0.580 0.580
38	--	10	25	25	11E	1	1	24 125	3RT20 28-2XB40-0LA2 3RT20 28-2XG40-0LA2	0.580 0.580

For accessories and spare parts, see page 2/66-2/69.

¹⁾ It is not possible to mount an auxiliary switch block. A clearance of 10 mm is required for side-by-side mounting at ambient temperatures > 60 °C.

More information

Contactors	Type		3RT20 17	3RT20 2.	3RT20 2.-2XB40-0LA2	3RT20 2.-2XF40-0LA2
Ambient temperature						
• During operation		°C	-40 ... +70			
• During storage		°C	-55 ... +80			
Solenoid coil operating range		DC	0.7 ... 1.25 x U_s		0.7 ... 1.3 x U_s	
Power consumption of the solenoid coils			For cold coil and 1.0 x U_s			
• Contactors with series resistor	- Closing	W	13	--	--	--
	- Closed	W	4	--	--	--
• Contactors without series resistor	- Closing	W	2.8	4.5	--	--
	- Closed	W	2.8	4.5	--	--
• Contactors with solid-state operating mechanism	- Closing	W	--	--	6.7	13.2
	- Closed	W	--	--	0.8	1.56

All specs and technical specs not mentioned here are identical to those of the standard contactors for switching motors.

Contactors for Special Applications

3RT26 capacitor contactors

AC operation

IEC 60947-5, DIN EN 60947-5-1, (VDE 0660 Part 200)

The contactors are suitable for use in any climate and are finger safe per DIN EN 50274.

The 3RT26 capacitor contactors are application specific variants of the size S00 to S2 SIRIUS Innovations contactors. The capacitors are precharged by means of the mounted leading NO contacts and resistors; only then do the main contacts close.

This prevents disturbances in the power system and welding of the contactors.

Only discharged capacitors are permitted to be switched on with capacitor contactors. Recommendation: use discharge chokes for parallel connection with the capacitors.

The capacitor contactors of size S00 contain either 1NO or 1NC in the basic unit and another unassigned NC contact in the auxiliary switch block fitted to the basic unit.

The auxiliary switch block which is snapped onto the capacitor contactor of sizes S0 contains the three leading NO contacts and one standard NO contact, which is unassigned.

The capacitor contactors of size S2 can be fitted additionally with a 2-pole auxiliary switch on the right side (2 NO, 2 NC or 1 NO + 1 NC), type 3RH19 21-1EA.. for lateral mounting.

For the capacitor making and breaking capacity of the basic 3RT20 contactor variant, see the technical data.

Selection and ordering data

AC operation

AC-6b utilization category For switching three-phase capacitors at an ambient temperature of 60 °C ²⁾					Current	Auxiliary contacts, unassigned	Rated control supply voltage $U_s^{1)3)}$	Screw connection	Weight approx.
UL capacitor rating at operational voltage									
200/208 230/240 460/480 575/600								Order No.	
Phase	kvar	kvar	kvar	kvar			AC		kg

For screwing and snapping onto 35 mm standard mounting rail

3RT26 17-1AK63

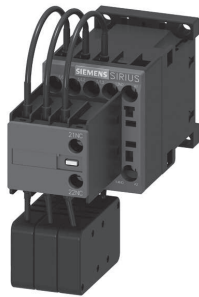

• Size S00					Current	Auxiliary contacts, unassigned	Rated control supply voltage $U_s^{1)3)}$	Screw connection	Weight approx.
1Ø	3.6	4	8.3	10					
3Ø	6.2	6.9	14	17			120 V, 60 Hz	3RT26 17-1AK63	
							240 V, 60 Hz	3RT26 17-1AP63	

• Size S0					Current	Auxiliary contacts, unassigned	Rated control supply voltage $U_s^{1)3)}$	Screw connection	Weight approx.
1Ø	4.8	5.3	11	13					
3Ø	8.3	9.1	18	23			120 V, 60 Hz	3RT26 25-1AK65	
							240 V, 60 Hz	3RT26 25-1AP65	

1Ø	5.8	6.4	13	16	29	1NO / 2NC	24 V, 50/60 Hz	3RT26 26-1AC25	0.49
3Ø	10	11	22	28			120 V, 60 Hz	3RT26 26-1AK65	
							240 V, 60 Hz	3RT26 26-1AP65	

3RT2637-1NF35



1Ø	6.6	7.3	15	18	33	1NO / 2NC	24 V, 50/60 Hz	3RT26 27-1AC25	0.49
3Ø	11	13	25	31			120 V, 60 Hz	3RT26 27-1AK65	
							240 V, 60 Hz	3RT26 27-1AP65	

1Ø	8.6	9.5	20	24	43	1NO / 2NC	24 V, 50/60 Hz	3RT26 28-1AC25	0.59
3Ø	15	16	33	41			120 V, 60 Hz	3RT26 28-1AK65	
							240 V, 60 Hz	3RT26 28-1AP65	

• Size S2					Current	Auxiliary contacts, unassigned	Rated control supply voltage $U_s^{1)3)}$	Screw connection	Weight approx.
1Ø	14	16	33	40					
3Ø	25	27	55	69			83-155 VUC	3RT26 36-1NF35	
							175-280 VUC	3RT26 36-1NP35	

1Ø	20	22	45	54	98A	2 NC	20-33 VUC	3RT26 37-1NB35	1.11
3Ø	34	38	75	94			83-155 VUC	3RT26 37-1NF35	
							175-280 VUC	3RT26 37-1NP35	

1) Coil voltage tolerance: 0.85 ... 1.1 x U_s .

2) A clearance of 10 mm is required for side-by-side mounting at ambient temperatures > 60 °C

For further voltages, see page 2/49.

For auxiliaries and accessories, see page 2/66-2/83.

For technical data, see page 2/173.

For wiring diagram, see page 2/201.

For dimension drawings, see page 2/220.

DC Coil Selection for 3RT261 only

Coil Code	B4	W4	E4	F4	G4	M4
DC	24 V	48 V	60 V	110 V	125 V	220 V

UC Coil Selection for 3RT262

Coil Code	NB3	NF3	NP3
UC	21-28V	95-130V	200-280V

UC Coil Selection for 3RT263

Coil Code	B3	F3	P3
UC	20-33V	83-155V	175-280V

3) at upper limit = 1.1 x U_s

Contactors for Special Applications

3RT20 coupling contactors (interface) for switching motors, 3-pole

AC and DC operation

IEC 60947, EN 60947.

The 3RT20 coupling contactors for switching motors are tailored to the special requirements of working with electronic controls.

The 3RT20 1 coupling contactors cannot be expanded with auxiliary switch blocks. Coupling contactors have a low power consumption and an extended solenoid coil operating range.

Depending on the version, the solenoid coils are supplied either without overvoltage damping or with a diode, suppressor diode or varistor connected as standard.

Selection and ordering data

DC operation

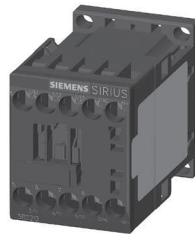

3RT2015-1HB41

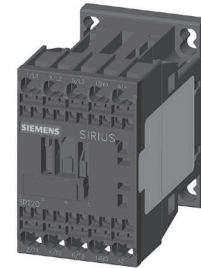

3RT2015-2HB41

Surge suppressor	Ratings Utilization category		Auxiliary contacts		Screw connection	Spring-type connection	Weight approx. (screw/spring) kg
	Maximum inductive current	Maximum ¹⁾ horsepower ratings at 460 V	Ident. no.	Design no.	Order No.	Order No.	
	AC-3						
	Amps	HP		NO NC			

For screwing and snapping onto 35 mm standard mounting rail

• Size S00

Terminal designations according to EN 50 012

Rated control supply voltage U_s = DC 24 V, coil voltage tolerance **0.7 to 1.25** × U_s

Power consumption of the coils **2.8 W** at 24 V (no auxiliary switch blocks can be mounted)

Diode, varistor or RC element can be mounted	7	3	10E01	1 –	– 1	3RT20 15-1HB41 3RT20 15-1HB42	3RT20 15-2HB41 3RT20 15-2HB42	0.28/0.30
Diode integrated	7	3	10E01	1 –	– 1	3RT20 15-1J B41 3RT20 15-1J B42	3RT20 15-2J B41 3RT20 15-2J B42	0.28/0.30
Suppressor diode integrated	7	3	10E01	1 –	– 1	3RT20 15-1KB41 3RT20 15-1KB42	3RT20 15-2KB41 3RT20 15-2KB42	0.28/0.30
Diode, varistor or RC element can be mounted	9	5	10E01	1 –	– 1	3RT20 16-1HB41 3RT20 16-1HB42	3RT20 16-2HB41 3RT20 16-2HB42	0.28/0.30
Diode integrated	9	5	10E01	1 –	– 1	3RT20 16-1J B41 3RT20 16-1J B42	3RT20 16-2J B41 3RT20 16-2J B42	0.28/0.30
Suppressor diode integrated	9	5	10E01	1 –	– 1	3RT20 16-1KB41 3RT20 16-1KB42	3RT20 16-2KB41 3RT20 16-2KB42	0.28/0.30
Diode, varistor or RC element can be mounted	12	7.5	10E01	1 –	– 1	3RT20 17-1HB41 3RT20 17-1HB42	3RT20 17-2HB41 3RT20 17-2HB42	0.28/0.30
Diode integrated	12	7.5	10E01	1 –	– 1	3RT20 17-1J B41 3RT20 17-1J B42	3RT20 17-2J B41 3RT20 17-2J B42	0.28/0.30
Suppressor diode integrated	12	7.5	10E01	1 –	– 1	3RT20 17-1KB41 3RT20 17-1KB42	3RT20 17-2KB41 3RT20 17-2KB42	0.28/0.30

For technical data, see page 2/174.

For int. circuit diagrams, see page 2/193-2/198.

For dimension drawings, see page 2/212.

1) Complete HP ratings on page 2/124

Contactors for Special Applications

3RT20 coupling contactors (interface) for switching motors

Selection and ordering data

DC operation



3RT2015-1VB41

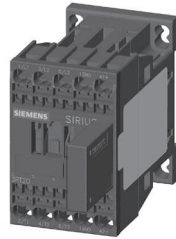

3RT2015-2VB41

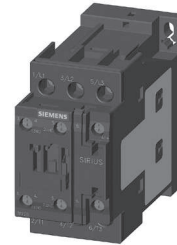

3RT2024-1KB40

Surge suppressor	Ratings Utilization category		Auxiliary contacts		Screw connection	Spring-type connection	Weight approx. (screw/spring) kg
	AC-3		Ident. no.	Design	Order No.	Order No.	
	Maximum inductive current	Maximum horsepower ratings at 460 V					
	Amps	HP		NO NC			

For screwing and snapping onto 35 mm standard mounting rail

• Size S00

Terminal designations according to EN 50 012

Rated control supply voltage $U_s = DC 24 V$, coil voltage tolerance $0.85 \text{ to } 1.85 \times U_s$

Power consumption of the coils **1.6 W** at 24 V (no auxiliary switch blocks can be mounted)

Diode, varistor or RC element can be mounted	7	3	10E 01	1 – – 1	3RT20 15-1MB41-0KT0 3RT20 15-1MB42-0KT0	3RT20 15-2M B41-0KT0 3RT20 15-2M B42-0KT0	0.28/0.30
Diode integrated	7	3	10E 01	1 – – 1	3RT20 15-1VB41 3RT20 15-1VB42	3RT20 15-2VB41 3RT20 15-2VB42	0.28/0.30
Suppressor diode integrated	7	3	10E 01	1 – – 1	3RT20 15-1SB41 3RT20 15-1SB42	3RT20 15-2SB41 3RT20 15-2SB42	0.28/0.30
Diode, varistor or RC element can be mounted	9	5	10E 01	1 – – 1	3RT20 16-1MB41-0KT0 3RT20 16-1MB42-0KT0	3RT20 16-2M B41-0KT0 3RT20 16-2M B42-0KT0	0.28/0.30
Diode integrated	9	5	10E 01	1 – – 1	3RT20 16-1VB41 3RT20 16-1VB42	3RT20 16-2VB41 3RT20 16-2VB42	0.28/0.30
Suppressor diode integrated	9	5	10E 01	1 – – 1	3RT20 16-1SB41 3RT20 16-1SB42	3RT20 16-2SB41 3RT20 16-2SB42	0.28/0.30
Diode, varistor or RC element can be mounted	12	7.5	10E 01	1 – – 1	3RT20 17-1MB41-0KT0 3RT20 17-1MB42-0KT0	3RT20 17-2M B41-0KT0 3RT20 17-2M B42-0KT0	0.28/0.30
Diode integrated	12	7.5	10E 01	1 – – 1	3RT20 17-1VB41 3RT20 17-1VB42	3RT20 17-2VB41 3RT20 17-2VB42	0.28/0.30
Suppressor diode integrated	12	7.5	10E 01	1 – – 1	3RT20 17-1SB41 3RT20 17-1SB42	3RT20 17-2SB41 3RT20 17-2SB42	0.28/0.30

• Size S0

Rated control supply voltage $U_s = DC 24 V$, coil voltage tolerance $0.7 \text{ to } 1.25 \times U_s$

Power consumption of the coils **4.5 W** at 24 V no auxiliary switch blocks can be mounted.

Varistor integrated	12	7.5	11E	1 1	3RT20 24-1KB40	3RT20 24-2KB40	0.58/0.60
	16	10	11E	1 1	3RT20 25-1KB40	3RT20 25-2KB40	0.58/0.60
	25	15	11E	1 1	3RT20 26-1KB40	3RT20 26-2KB40	0.58/0.60
	32	20	11E	1 1	3RT20 27-1KB40	3RT20 27-2KB40	0.58/0.60

For technical data, see page 2/174.

For int. circuit diagrams, see page 2/193-2/198.

For dimension drawings, see page 2/212.

Contactors & Relays for Safety Applications

3RT, 3TF safety contactors and 3RH2, 3TH2 safety control relays

Applications

“Safety” Contactors

Safety rated contactors are required to have mirrored contact construction according to IEC 60947-4-1 Annex F. A mirror contact is a Normally Closed (NC) auxiliary contact which can not be closed simultaneously with a Normally Open (NO) main contact.

In some industries, such as automotive, requirements have been established that a safety rated contactor must also have permanently mounted auxiliary contact blocks. See page 2/23 for Contactors with permanently mounted auxiliary contacts.

Siemens Contactors for “Safety” applications:

All Siemens standard 3RT, 3TF6, 40HN & 40PH Contactors are provided with positively driven (mirror) contacts which meet or exceed the criteria for “Safety Contactors” according to IEC 60947-4 Annex F which describes the requirements for mirror contact performance.

When applying Safety Contactors in safety circuits, the NC auxiliary contacts must be wired in series or parallel and must be used as monitoring contacts with feedback to the safety evaluation device (i.e. safety relay or failsafe logic controller).

“Safety” Control Relays

Safety rated control relays are required to have positively driven contact elements according to IEC 60947-5-1 Annex L. Positively driven contact elements are a combination of NO auxiliary contacts and NC auxiliary contacts whose construction prevents them from being closed simultaneously.

In some industries, such as automotive, requirements have been established that a safety rated control relays must also have permanently mounted auxiliary contact blocks. See page 2/18 for Control Relays with permanently mounted auxiliary contacts.

Siemens Control Relays for “Safety” applications:

All SIRIUS 3RH control relays (with at least 1 NC contact) meet or exceed the criteria for “Safety Control Relays” according to IEC 60947-5-1 Annex L. This is true for the basic 3RH relay with or without an additional auxiliary contact block.

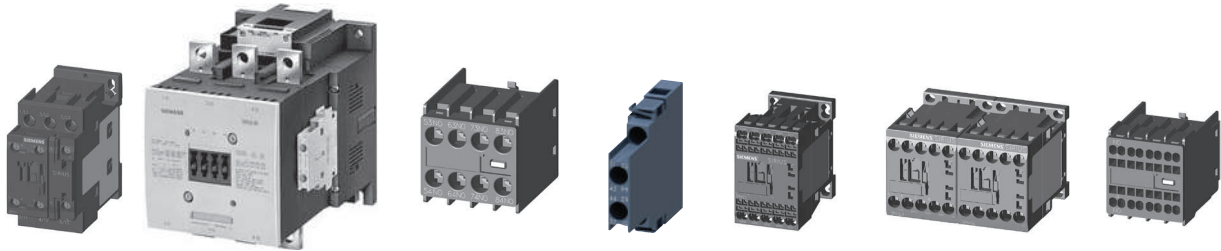

3RT20 2.-1A..00 3RT10 7.-6A..6 3RH29 21.-1F 3RH29 21.-1DA 11 3RH21 3RH24 3RH2911-2HA..

Frame size	Contactors	Auxiliary contact block
S00	3RT201	3RH2911
	3RT231	
	3RT251	
	3RT261	
S0	3RT202	3RH2921
	3RT232	
	3RT252	
	3RT262	
S2	3RT203	3RH2921
	3RT233	
	3RT253	
S3	3RT263	3RH2921
	3RT204	
	3RT234	
S6	3RT244	3RH2921
	3RT264	
	3RT105	
S10	3RT145	3RH1921
	3RT106	
	3RT126	
S12	3RT146	3RH1921
	3RT107	
	3RT127	
	3RT147	
	3TF6	3TY7561-1UA00

Frame size	Control Relays	Auxiliary contact block
S00	3RH21	3RH2911
	3RH24	
	3TH20	
		3TX44

For contactors, see pages 2/8-2/9.
 For auxiliaries contact blocks, see pages 2/66-2/68.
 For control relays, see pages 2/50-2/52.
 For auxiliaries contact blocks, see page 2/66-2/68..



Contactors & Relays for Safety Applications

3RT safety contactors, 3RH2 safety control relays with permanently mounted auxiliary contact blocks

Application

"Safety" Contactors

Safety rated contactors are required to have mirrored contact construction according to IEC 60947-4 Annex F. A mirror contact is a Normally Closed (NC) auxiliary contact which can not be closed simultaneously with a Normally Open (NO) main contact. In some industries, such as Automotive, the auxiliary contact blocks are required to be permanently attached to meet the requirements of "unintentional misuse" as specified in IEC 60292, paragraph 3.12. Tested by SUVA.

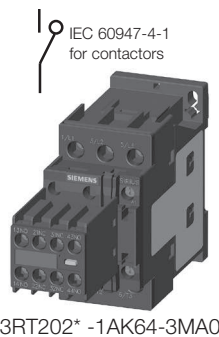

"Safety" Control Relays

Safety rated control relays are required to have positively driven contact elements according to IEC 60947-5-1 Annex L. Positively driven contact elements are a combination of NO auxiliary contacts and NC auxiliary contacts whose construction prevents them from being closed simultaneously. In some industries, such as automotive, the auxiliary contact blocks are required to be permanently attached to meet the requirements of "unintentional misuse" as specified in IEC 60292, paragraph 3.12. Tested by SUVA.

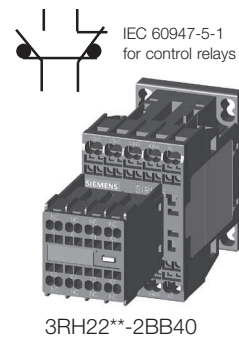

Application

Frame Size	Max. current		Single-phase HP ratings			Three-phase HP ratings			Auxiliary contacts		Screw Terminals Order No.	Spring-Type Terminals ¹⁾ Order No.
	AC3	AC1	115V	220/240V	200V	230V	460V	575V	Ident. No.	NO		
	A	A	HP	HP	HP	HP	HP	HP				

Contactors with permanently mounted auxiliary contact blocks													
S00	6	18	¼	¾	1 ½	2	3	5	22E	2	2	3RT2015-1●●●4-3MA0	3RT2015-2●●●4-3MA0
	9	22	⅓	1	2	3	5	7 ½	22E	2	2	3RT2016-1●●●4-3MA0	3RT2016-2●●●4-3MA0
	12	22	½	2	3	3	7 ½	10	22E	2	2	3RT2017-1●●●4-3MA0	3RT2017-2●●●4-3MA0
S0	16	22	1	2	3	5	10	10	22E	2	2	3RT2018-1●●●4-3MA0	3RT2018-2●●●4-3MA0
	9	40	1	1	2	3	5	7 ½	22E	2	2	3RT2023-1●●●4-3MA0	3RT2023-2●●●4-3MA0
	12	40	1	2	3	3	7 ½	10	22E	2	2	3RT2024-1●●●4-3MA0	3RT2024-2●●●4-3MA0
	17	40	1	3	5	5	10	15	22E	2	2	3RT2025-1●●●4-3MA0	3RT2025-2●●●4-3MA0
	25	40	2	3	7 ½	7 ½	15	20	22E	2	2	3RT2026-1●●●4-3MA0	3RT2026-2●●●4-3MA0
S2	32	50	2	5	10	10	20	25	22E	2	2	3RT2027-1●●●4-3MA0	3RT2027-2●●●4-3MA0
	38	50	3	5	10	10	25	25	22E	2	2	3RT2028-1●●●4-3MA0	3RT2028-2●●●4-3MA0
	40	60	3	7 ½	10	15	30	40	22E	2	2	3RT2035-1●●●4-3MA0	3RT2035-3●●●4-3MA0
	50	70	3	10	15	15	40	50	22E	2	2	3RT2036-1●●●4-3MA0	3RT2036-3●●●4-3MA0
	65	80	5	10	20	20	50	50	22E	2	2	3RT2037-1●●●4-3MA0	3RT2037-3●●●4-3MA0
S3	80 ⁴⁾	90	5	15	20	25	50	60	22E	2	2	3RT2038-1●●●4-3MA0	3RT2038-3●●●4-3MA0
	80	120	7 ½	15	25	30	60	75	22E	2	2	3RT2045-1●●●4-3MA0	3RT2045-3●●●4-3MA0
	95	120	10	20	30	30	75	100	22E	2	2	3RT2046-1●●●4-3MA0	3RT2046-3●●●4-3MA0
S6	150	185	--	30	50	60	125	150	22E	2	2	3RT1055-6●●●6-3PA0	--
	185	215	--	30	60	75	150	200	22E	2	2	3RT1056-6●●●6-3PA0	--
S10	225	275	--	--	60	75	150	200	22E	2	2	3RT1064-6●●●6-3PA0	--
	265	330	--	--	75	100	200	250	22E	2	2	3RT1065-6●●●6-3PA0	--
	300	330	--	--	100	125	250	300	22E	2	2	3RT1066-6●●●6-3PA0	--
S12	400	430	--	--	125	150	300	400	22E	2	2	3RT1075-6●●●6-3PA0	--
	500	610	--	--	150	200	400	500	22E	2	2	3RT1076-6●●●6-3PA0	--

Control circuit coil options: Replace ●●● with the desired code

Frame Size S00 - S0	●●●	Frame Size S2	●●●	Frame Size S3	●●●	Frame Size S6 - S10	●●●
120 V AC	AK6	120 V AC	AK6	120 V AC **	AK6	21-27 V UC*, solid state coil w/ PLC interface	AB3
120 V AC, integrated varistor	CK6	120 V AC w/ Varistor	CK6	24V DC	KB4	110 ... 127 V UC*, conventional coil	NB3
230 V AC	AP0	24 V DC w/Varistor	KB4	w/ integrated varistor	NB3	Frame Size S6 - S12	●●●
24 V DC	BB4			24V AC/DC		96 ... 127, fail-safe coil	SF3
24 V DC, integrated varistor	DB4			w/integrated varistor		200 ... 277, fail-safe coil	SP3
24 V DC, integrated diode assy.	FB4					*UC coil: accepts DC voltage or AC voltage, 40 to 60 Hz.	

Frame Size	Max. current at 240 V ²⁾	Rated control supply voltage U _s	Auxiliary contacts		Screw Terminals ³⁾ Order No.	Spring Terminals ³⁾ Order No.
			Ident. No.	NO		
A						

Control relays with permanently mounted auxiliary contact blocks							
S00-S00	10	110 V AC, 50 Hz / 120 V AC, 60 Hz	44E	4	4	3RH2244-1AK60	3RH2244-2AK60
	10	24 V DC	44E	4	4	3RH2244-1BB40	3RH2244-2BB40
	10	110 V AC, 50 Hz / 120 V AC, 60 Hz	62E	6	2	3RH2262-1AK60	3RH2262-2AK60
	10	24 V DC	62E	6	2	3RH2262-1BB40	3RH2262-2BB40

For other voltages see page 2/49.

For accessories, see pages 2/73-2/78.

For spare parts, see pages 2/94-2/97.

For technical data, see pages 2/121-2/142.

For description, see pages 2/104-2/105.

For int. circuit diagrams, see page 2/193-2/199.

For dimension drawings, see pages 2/212-2/218.

1) All terminals are spring loaded on frame size S00 and S0. Only the coil and auxiliary contact terminals are spring loaded on frame sizes S2 & S3.

2) For AC-15/AC-14, max current for front mounted auxiliary contacts = 6 A.

3) The 3RH22 control relays are also available with ring lug terminals. Replace the 8th digit of the order number with a "4", e.g. 3RH2244-4AK60











4) Max UL FLA = 65A at 460V

Function Modules for Mounting onto SIRIUS 3RT2 Contactors

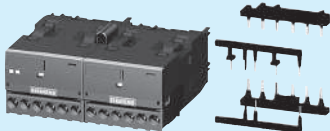
Introduction

Overview

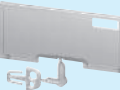
The function modules for mounting onto contactors enable the assembly of starters and contactor assemblies for direct-on-line, reversing and wye-delta starting without any additional, complicated wiring of the individual components. They include the key control functions required for the particular starter, e. g. timing and interlocking, and can be connected to the control system by either parallel wiring or through IO-Link or AS-Interface.

Version	SIRIUS function modules for parallel wiring	SIRIUS function modules for IO-Link ¹⁾	SIRIUS function modules for AS-Interface ¹⁾
For direct-on-line starting	<p>Timing relays: ON or OFF-delay with semiconductor output With screw or spring-type terminals</p> 	<p>With screw or spring-type terminals</p> 	<p>With screw or spring-type terminals</p> 
For reversing starting	<p>Wiring modules for sizes S00, S0 & S2 With screw or spring-type terminals - (with screw terminals for main and control circuit)</p> 	<p>1 function module for size S00, S0 & S2, screw and spring-type connection, plus the respective wiring modules¹⁾</p> 	<p>1 function module for size S00, S0 & S2, screw and spring-type connection, plus the respective wiring modules¹⁾</p> 
For wye-delta starting	<p>1 function module for size S00, S0 & S2, screw and spring-type connection of the contactors, plus the respective wiring modules²⁾</p> 	<p>For wye-delta starting: 1 function module for size S00, S0 & S2, plus screw and spring-type connection, plus the respective wiring modules²⁾</p> 	<p>For wye-delta starting: 1 function module for size S00, S0 & S2, plus screw and spring-type connection, plus the respective wiring modules²⁾</p> 
Accessories	<p>Sealable covers</p> 	<p>Operator panel for autonomous controlling of up to 4 starters Module connector for the grouping of starters Connection cable between the operator panel and the starter group Sealable covers</p> 	<p>AS-Interface addressing units Sealable covers</p> 

¹⁾ Use of the communication-capable function modules for IO-Link or AS-Interface requires contactors with communication interface (see pages 2/26).

²⁾ The modules for the control current wiring, which are included in the wiring kit, are not required.

Note:
When the function modules are used, no other auxiliary switches are allowed to be mounted on the basic units.

Function Modules for Mounting onto SIRIUS 3RT2 Contactors

SIRIUS function modules

Overview

Simply by being plugged in place, the SIRIUS function modules enable different functionalities required for the assembly of starters to be realized in the starter. The function modules and wiring kits help to reduce the wiring work within the starter practically to zero.

SIRIUS function modules for direct-on-line starting

The electronic timing relays which can be mounted onto the contactor are available in these versions:

- Sizes S00 and S0 for applications in the range from 24 to 240 V AC/DC (wide voltage range)
- Size S2 for applications in either the range from 24 to 90 V AC/DC or 90 to 240 V AC/DC

Both the electrical and mechanical connection are made by simple snapping on and locking.

A protection circuit (varistor) is integrated in each module.

The electronic timing relay with semiconductor output uses two contact legs to actuate the contactor underneath by means of a semiconductor after the set time t has elapsed.

The switching state feedback is performed by a mechanical switching state indicator (plunger). In addition, the auxiliary switches in the contactors are freely accessible and can be used for feedbacks to the control system or for signal lamps.

A sealable cover is available to protect against careless adjustment of the set times.

SIRIUS function modules for reversing starting

The wiring kits for reversing starters enable the cost-effective assembly of contactor assemblies. They can be used for all applications with reversing duty up to 50 HP.

[For a detailed description see page 2/37.](#)

SIRIUS function modules for wye-delta starting

Both interlocking and timing functions are required for the assembly of wye-delta starters. With the function modules for wye-delta starting and the matching link modules for the main circuit, these starters can be assembled easily and with absolutely no errors.

The entire sequence in the control circuit is integrated in the snap-on modules. This covers:

- An adjustable wye time t from 0.5 to 60 s
- A non-adjustable dead interval of 50 ms
- Electrical contacting to the contactors by means of coil pick-off (contact legs)
- Feedback of the switching state at the contactor using a mechanical switch position indicator (plunger)
- Electrical interlocking between the contactors

These modules do not require their own terminals and can therefore be used for contactors with both screw and spring-type terminals in the S00, S0 and S2. To start the wye-delta starter, only the first of the three contactors (line contactor) is actuated. All other functions then take place inside the individual modules.

This also offers advantages if the timing function was previously implemented in a controller, as it again results in a significant reduction in the number of PLC outputs, the programming work and the wiring outlay.

The kits for the main circuit include the mechanical interlock, the star jumper, the wiring modules at the top and at the bottom, and the required connecting clips.

A protection circuit (varistor) is integrated in the basic module.

Application

The snap-on function modules for direct-on-line starting are used above all for realizing timing functions independently of the control system.

With the OFF-delay variant of the timing relay it is possible for example for the fan motor for cooling a main drive to be switched off with a delay so that sufficient cooling after operation is guaranteed even if the plant and its control system have already been switched off.

The ON-delay timing relays enable for example the time-delayed starting of several drives so that the summation starting current does not rise too high, which could result in voltage failure.

The function modules for wye-delta starting are mostly used where current-limiting measures for starting a drive are required, e.g. for large fans and ventilators, and a high level of availability is essential at the same time. This technology has been used with success for several decades and has the additional advantage of requiring relatively little know-how. Through the use of function modules, the assembly work with simple standard components is even easier and error-free.

Benefits

The use of snap-on function modules for direct-on-line starting (timing relays) results in the following advantages:

- Reduction of control current wiring
- Prevention of wiring errors
- Reduction of testing costs
- Implementation of timing functions independently of the control system
- Less space required in the control cabinet compared to a separate timing relay
- No additive protection circuit required (varistor integrated)

The use of function modules for wye-delta starting results in the following advantages:

- Operation solely through the line contactor A1/A2 – no further wiring needed
- Reduction of the control current wiring inside the contactor assembly and to the higher-level control system where applicable
- Prevention of wiring errors
- Reduction of testing costs
- Integrated electrical interlocking saves costs and prevents errors
- Less space needed in the control cabinet compared to using a separate timing relay
- Adjustable starting in star mode from 0.5 to 60 s
- Independent of the contactor's control supply voltage (24 to 240 V AC/DC)
- Varistor integrated – no additive protection circuit required
- No control current wiring thanks to plug-in technology and connecting cables
- Mechanically coded assembly enables easy configuration and reliable wiring
- Fewer versions – one module kit for screw and spring-type connection and for the two sizes S00 to S2
- Mechanical interlocking (with wiring kit for the main circuit)



Contactors for Switching Motors

3RT2 contactors, 3-pole – Communication Contactors

Selection and ordering data

- Ideal for diagnostics to the automation controller
- Quickly locate and rectify faults
- Configuration available in Step 7 and TIA Portal
- Easy engineering of parameters
- For DOL, reversing and wye delta starters up to 50 HP
- Manual starter operation with optional operator panel
- Reduces control wiring in the panel
- Available for 24VDC control systems
- Easily snap on IO-Link or AS-Interface modules onto contactors



Frame Size	Amp Ratings		Single-phase HP ratings		Three-phase HP ratings			Auxiliary contacts		Screw Terminals 24 V DC coil	Spring-type Terminals 1) 24 V DC coil	Weight approx. kg		
	AC3	AC1	115V	230V	208V	230V	460V	575V	NO	NC	Order No.		Order No.	
3RT 3-pole Contactors														
 3RT2018-1BB41-0CC0	S00	7	18	0.25	0.75	1.5	2	3	5	1	0	3RT2015-1BB41-0CC0	3RT2015-2BB41-0CC0	0.28
		0	1	3RT2015-1BB42-0CC0	3RT2015-2BB42-0CC0									
		9	22	0.33	1	2	3	5	7.5	1	0	3RT2016-1BB41-0CC0	3RT2016-2BB41-0CC0	
		0	1	3RT2016-1BB42-0CC0	3RT2016-2BB42-0CC0									
		12	22	0.5	2	3	3	7.5	10	1	0	3RT2017-1BB41-0CC0	3RT2017-2BB41-0CC0	
		0	1	3RT2017-1BB42-0CC0	3RT2017-2BB42-0CC0									
 3RT2028-1BB40-0CC0	S0	16	22	1	2	3	5	10	10	1	0	3RT2018-1BB41-0CC0	3RT2018-2BB41-0CC0	0.58
		0	1	3RT2018-1BB42-0CC0	3RT2018-2BB42-0CC0									
		9	40	1	1	2	3	5	7.5	1	1	3RT2023-1BB40-0CC0	3RT2024-2BB40-0CC0	
		12	40	1	2	3	3	7.5	10	1	1	3RT2024-1BB40-0CC0	3RT2024-2BB40-0CC0	
		16	40	1	3	5	5	10	15	1	1	3RT2025-1BB40-0CC0	3RT2025-2BB40-0CC0	
		25	40	2	3	7.5	7.5	15	20	1	1	3RT2026-1BB40-0CC0	3RT2026-2BB40-0CC0	
 3RT2038-1NB30-0CC0	S2	32	50	2	5	10	10	20	25	1	1	3RT2027-1BB40-0CC0	3RT2027-2BB40-0CC0	1.122
		38	50	3	5	10	10	25	25	1	1	3RT2028-1BB40-0CC0	3RT2028-2BB40-0CC0	
		40	60	3	7.5	10	15	30	40	1	1	3RT2035-1NB30-0CC0	3RT2035-3NB30-0CC0	
		50	70	3	10	15	15	40	50	1	1	3RT2036-1NB30-0CC0	3RT2036-3NB30-0CC0	
65	80	5	10	20	20	50	50	1	1	3RT2037-1NB30-0CC0	3RT2037-3NB30-0CC0			
80	90	5	15	20	25	50	60	1	1	3RT2038-1NB30-0CC0	3RT2038-3NB30-0CC0			

1) All terminals are spring loaded in sizes S00 and S0.
For size S2, only the coil and aux contacts are spring loaded.

Communication capable contactors are ideal for starter feedback to the automation level. IO-Link starters in the cabinet save considerable wiring effort. AS-Interface is best suited for distributed systems.

- For reversing contactors with communication capability, see pages 2/39-2/43
- For accessories, see page 2/27, 2/30, 2/34.
- For technical data, see page 2/31, 2/35, 2/36
- For description, see page 2/24.
- For further information on IO-Link and AS-Interface, see page 2/28-2/29 and 2/32-2/33.

Function Modules for Mounting onto SIRIUS 3RT2 Contactors

SIRIUS function modules for reversing starting / wye-delta starting

Selection and ordering data

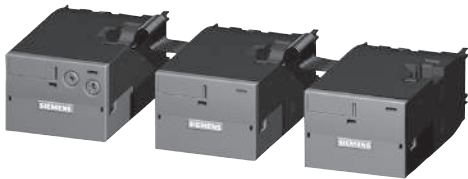

3RA28 16-0EW20



3RA29 13-2AA1

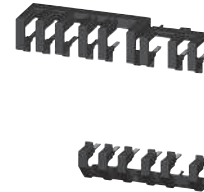

3RA29 13-2BB2

For contactors	Rated control supply voltage U_s ¹⁾	Time setting range t	Screw terminals	Weight approx.	Spring-type ²⁾ terminals	Weight approx.
Type	V	s	Order No.	kg	Order No.	kg

Assembly kits for reversing starting

Assembly kits for making 3-pole contactor assemblies

The assembly kit contains:
Mechanical interlock;
2 connecting clips for 2 contactors,
wiring modules on the top and bottom

3RT20 1.	• For size S00	3RA29 13-2AA1	0.046	3RA29 13-2AA2	0.070
3RT20 2.	• For size S0	3RA29 23-2AA1	0.089	3RA29 23-2AA2	0.112
3RT20 3.	• For size S2 (w/o mechanical interlock, see pg. 2/43)	3RA29 33-2AA1	0.159	3RA29 33-2AA2	0.156

Assembly kits for wye-delta starting

Assembly kits for making 3-pole contactor assemblies

The assembly kit contains:
Mechanical interlock,
4 connecting clips for 3 contactors;
star jumper,
wiring modules on the top and bottom

3RT20 1.	• For size S00	3RA29 13-2BB1	0.051	3RA29 13-2BB2	0.080
3RT20 2.	• For size S0 (only main circuit for version with spring-type terminals)	3RA29 23-2BB1	0.099	3RA29 23-2BB2	0.133
3RT20 3.	• For size S2 (only main circuit for version with spring-type terminals)	3RA29 33-2BB1	0.242	3RA29 33-2BB2	0.182

Function modules for wye-delta starting

The electrical connection between the function module and the contactor assembly is established automatically by snapping on and plugging in the connecting cables.

Wye-delta function (varistor integrated)

3RT20 1.	24 ... 240 AC/DC	0.5 ... 60	3RA28 16-0EW20	0.170	3RA28 16-0EW20	0.170
3RT20 2.		(10, 30, 60				
3RT20 3.		selectable)				

Accessories

Sealable covers

for 3RA27, 3RA28, 3RA29

	3RA29 10-0	0.002	3RA29 10-0	0.002
--	-------------------	-------	-------------------	-------

¹⁾ AC voltage values apply for 50 Hz and 60 Hz.

²⁾ Assembly kits in sizes S0 and S2 are supplied with wiring modules for the main circuit only.

Note:

When the function modules are used, no other auxiliary switches are allowed to be mounted on the basic units.

Function charts

- Timing relay energized
- Contact closed
- Contact open

2 NO contacts (internally connected)

Wye-delta function (varistor integrated)

- 1 NO contact, delayed
- 1 NO contact, instantaneous

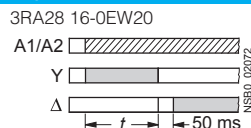

Function Modules for Mounting onto SIRIUS 3RT2 Contactors

SIRIUS function modules for IO-Link

Overview

The SIRIUS function modules for IO-Link enable the assembly of starters and contactor assemblies for direct-on-line, reversing and wye-delta starting without any additional, complicated wiring of the individual components. They include the key control functions required for the particular starter, e. g. timing and interlocking. The electrical and mechanical connection to the contactor is established by snapping on and locking. An additive protection circuit for the individual contactors can be dispensed with completely, and feedback from the contactor contacts is performed with Hall sensors which provide reliable feedback concerning the switching state even under extremely dusty conditions. The starters are connected to the higher-level

control system through IO-Link, with the possibility of connecting up to four starters as a group to one port of the IO-Link master.

Through this type of connection to the control system, a maximum of wiring is saved. The following essential signals are transmitted:

- Availability of the starter in response to an indirect inquiry from the motor starter protector
- Starter operation
- Feedback concerning the switching state of the starter

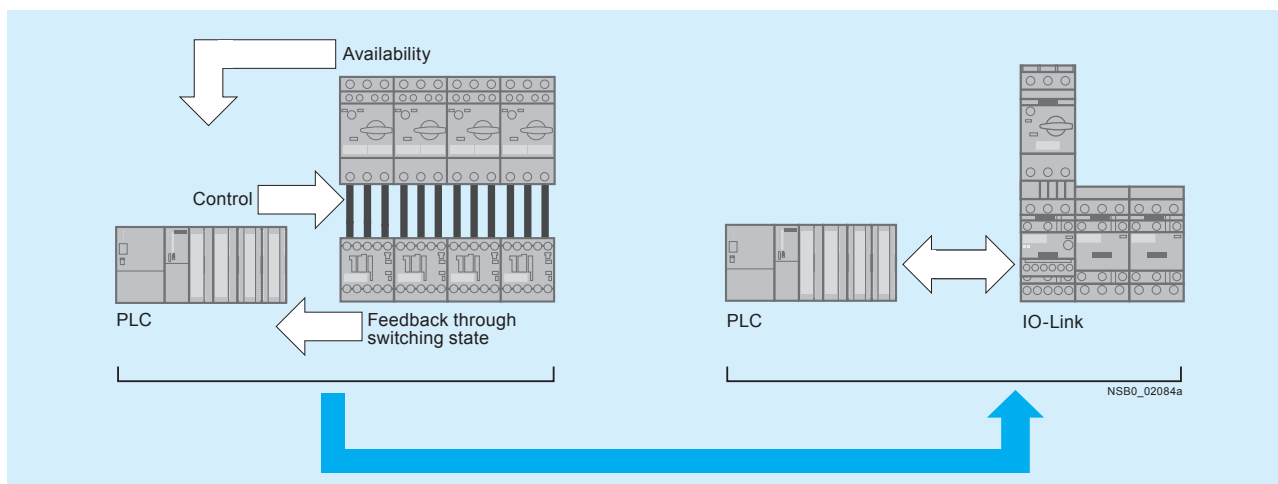

Signal transmission through IO-Link

The inquiry from the motor starter protector does not take place through additional wiring between the auxiliary switch and the module but by means of a voltage inquiry at the contactor input.

This requires the use of communication versions of the contactors with communication interface (see page 2/26).

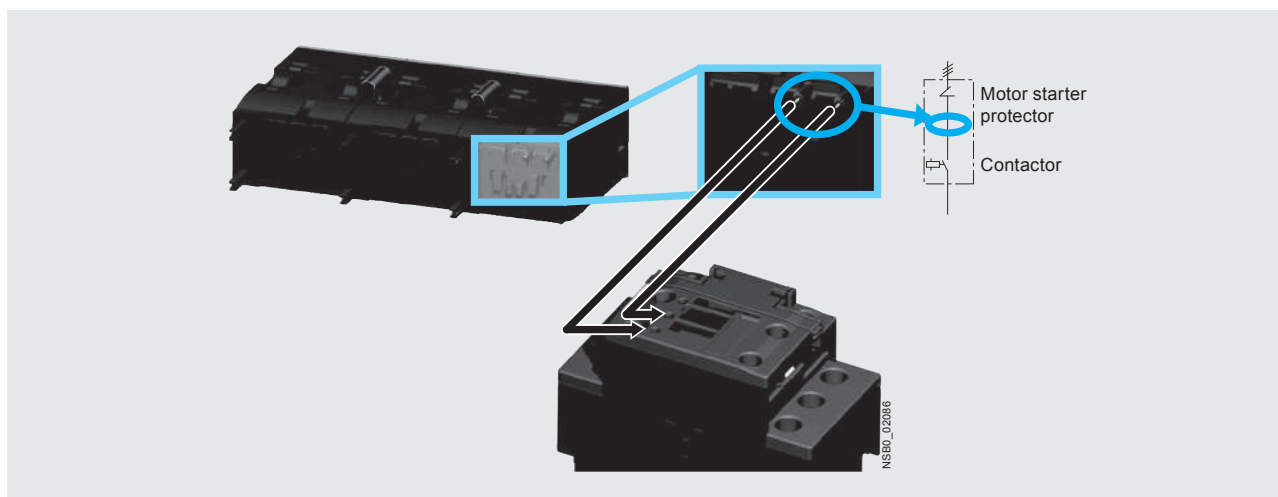

Availability signal through voltage pick-off

Function Modules for Mounting onto SIRIUS 3RT2 Contactors

SIRIUS function modules for IO-Link

By grouping up to four starters it is possible to connect up to 16 starters to one master of the ET200S. All the signals of the individual controls are made available through only 3 individual wires per starter group directly in the process image. If the

potential at the master of the ET200S is the same as that of the controls, a further reduction in wiring is possible by providing the control supply voltage to the contactors by jumpering the corresponding communication wires.

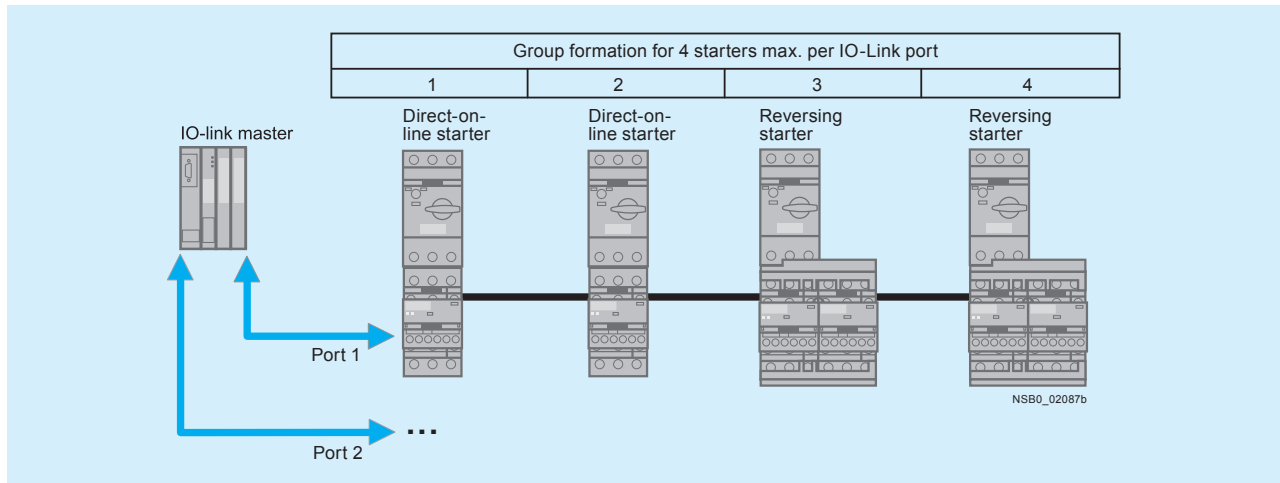

Group formation with IO-Link

In case of a malfunction, the corresponding error signals are also sent directly to the PLC in acyclic mode. This is in addition to transmission of the switching signals and status signals.

Possible error signals:

- Device defect
- No main voltage (motor starter protector tripped)
- No control supply voltage
- Limit position on the right / on the left
- Manual mode
- Process image fault

This easy integration of the starters in the TIA world does not limit the flexibility in the field in the least. For example, all function modules have special terminals in order to enable direct local disconnection. These terminals can be connected for example to a position switch. The input interrupts the voltage supply to the contactor coil directly, i. e. without going through the PLC. These terminals are jumpered in the as-delivered state.

Local manual operation of the complete starter group is also straight-forward using an operator panel. The latter is easily connected to the last starter and can be built into the front panel of the control cabinet if required. This offers significant advantages particularly for commissioning.

Application

The use of SIRIUS function modules with IO-Link is recommended above all in machines and plants in which there are several motor starters in one control cabinet. Using IO-Link, the connection of these starters to the automation level is easy, quick and error-free. And with IO modules no longer needed, the width of the ET200S becomes far smaller.

Benefits

- Reduction of the control current wiring to no more than one cable having three conductors for four starters
- Elimination of testing costs and wiring errors
- Reduction of configuration work
- Integration in TIA for clear diagnostics if a fault occurs
- Fewer IO modules saves space in the control cabinet
- All essential timing and interlocking functions for reversing duty and wye-delta starting are integrated
- No additional control circuit required

Further information on the application and benefits of the SIRIUS function modules for connection to the control system through IO-Link can be found in Chapter 14 "Industrial Communication".

Function Modules for Mounting onto SIRIUS 3RT2 Contactors

SIRIUS function modules for IO-Link

Selection and ordering data

Version	Screw terminals	Spring-type terminals	Weight
	Order No.	Order No.	kg
Function modules for direct-on-line starting			
<p>IO-Link connection Includes one module connector for assembling an IO-Link group</p> <p>3RA2711-1AA00</p>	3RA2711-1AA00	3RA2711-2AA00	
<p>3RA2711-2AA00</p>			
Function modules for reversing starting¹⁾			
<p>IO-Link connection, comprising one basic and one coupling module and an additional module connector for assembling an IO-Link group</p> <p>3RA2711-1BA00</p>	3RA2711-1BA00	3RA2711-2BA00	
<p>3RA2711-2BA00</p>			
Assembly kits for making 3-pole contactor assemblies			
<p>3RA2923-2AA1</p>	3RA2913-2AA1	3RA2913-2AA2	
<p>3RA2923-2AA2</p>			
<p>The assembly kit contains: mechanical interlock, 2 connecting clips for two contactors, wiring modules on the top and bottom</p> <ul style="list-style-type: none"> • For size S00 • For size S0 <ul style="list-style-type: none"> - For main, auxiliary and control circuits - Only for main circuit²⁾ • For size S2 <ul style="list-style-type: none"> - For main, auxiliary and control circuits - Only for main circuit²⁾ 	3RA2923-2AA1	--	3RA2923-2AA2
	3RA2933-2AA1	--	3RA2933-2AA2

1) For prewired contactor assemblies for reversing starting with voltage tap-off, see pages 2/40 and 2/43. When these contactor assemblies are used, the assembly kit for the wiring is already integrated.

2) Version in sizes S0 and S2 with spring-type terminals:
Only the wiring modules for the main circuit are included.
No connectors are included for the auxiliary and control circuit.

Matching contactors with communications interface required; see pages 2/26.

Function Modules for Mounting onto SIRIUS 3RT2 Contactors

SIRIUS function modules for IO-Link

Function modules for wye-delta starting¹⁾



3RA2711-1CA00

IO-Link connection, comprising one basic module and two coupling modules, plus an additional module connector for assembling an IO-Link group

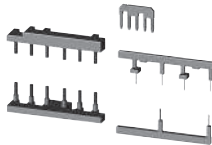

3RA2923-2BB1

Assembly kits for making 3-pole contactor assemblies²⁾

The assembly kit contains:
mechanical interlock,
4 connecting clips for 3 contactors;
star jumper,
wiring modules on the top and bottom



3RA2923-2BB2

- For size S00
- For size S0
 - For main, auxiliary and control circuits
 - Only for main circuit³⁾
- For size S2
 - For main, auxiliary and control circuits
 - Only for main circuit³⁾

- 1) For complete contactor assemblies for wye-delta starting including function modules, see pages 2/47 and 2/48.
- 2) When using the function modules for wye-delta starting, the wiring modules for the auxiliary current are not required.
- 3) Version in sizes S0 and S2 with spring-type terminals:
Only the wiring modules for the main circuit are included.
No connectors are included for the auxiliary and control circuit.

Version	Screw terminals	Spring-type terminals	Weight
	Order No.	Order No.	kg

	3RA2711-1CA00	3RA2711-2CA00	
	3RA2913-2BB1	3RA2913-2BB2	
	3RA2923-2BB1	--	
	--	3RA2923-2BB2	
	3RA2933-2BB1	--	
	--	3RA2933-2BB2	

Matching contactors with communications interface required; see pages 2/26.

Version	Order No.	Weight
		kg

Accessories



3RA2711-0EE10

Module connector set, comprising:
• 2 module connectors, 14-pole, short
• 2 interface covers

3RA2711-0EE10



3RA2711-0EE06

Module connectors

- 14-pole, 9 cm
For size jump + 1 space
- 14-pole, 26 cm
For various space combinations
- 14-pole, 33.5 cm
For various space combinations
- 10-pole, 9 cm
For separate control signal infeed within an IO-Link group

3RA2711-0EE06

3RA2711-0EE07

3RA2711-0EE08

3RA2711-0EE16



3RA2711-0EE15

Interface covers (Set of 5)

3RA2711-0EE15



3RA2910-0

Sealable covers
For 3RA27, 3RA28, 3RA29

3RA2910-0

Operator panels¹⁾



3RA6935-0A

Operator panel (set), comprising:
• 1 x operator panel
• 1 x enabling module
• 1 x interface cover
• 1 x fixing terminal

3RA6935-0A



3RA2711-0EE11

Connection cable, length 2 m, 10- to 14-pole
For connecting the operator panel to the communication module

3RA2711-0EE11

Enabling modules (replacement)

3RA6936-0A

Interface covers (replacement)

3RA6936-0B

¹⁾ Suitable only for communication through IO-Link.

For manuals, see <http://support.automation.siemens.com/WW/view/en/39319600>.

Function Modules for Mounting onto SIRIUS 3RT2 Contactors

SIRIUS function modules for AS-Interface

Overview

The SIRIUS function modules for AS-Interface enable the assembly of starters and contactor assemblies for direct-on-line, reversing and wye-delta starting without any additional, complicated wiring of the individual components. They include the key control functions required for the particular starter, e. g. timing and interlocking. The electrical and mechanical connection to the contactor is established by snapping on and locking. An additional control circuit for the individual contactors can be eliminated with completely because a varistor is integrated in the modules. Feedback from the contactor contacts is performed with Hall sensors which provide reliable feedback concerning the switching state even under extremely dusty conditions. Connection of the starters to the higher-level control system takes place through AS-Interface with the Specification V2.1 in A/B technology. As the result, up to 62 starters can be con-

nected to one master and the address is entered in normal manner with an addressing unit.

Through the AS-Interface connection to the control system, a maximum of wiring is saved. The wiring outlay is reduced to the control supply voltage and the two individual wires for AS-Interface.

The following essential signals are transmitted:

- Availability of the starter in response to an indirect inquiry from the motor starter protector
- Starter operation
- Feedback concerning the switching state of the starter

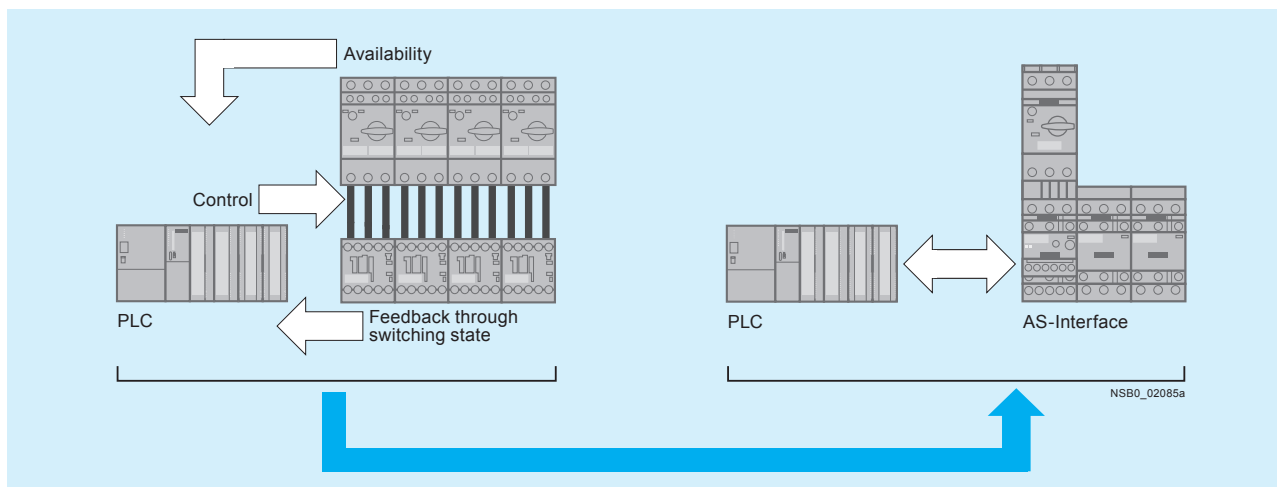

Signal transmission through AS-Interface

The inquiry from the motor starter protector does not take place through additional wiring between the auxiliary switch and the module but by means of a voltage inquiry at the contactor input.

This requires use of communication versions of the contactors with communication interface (see page 2/26).

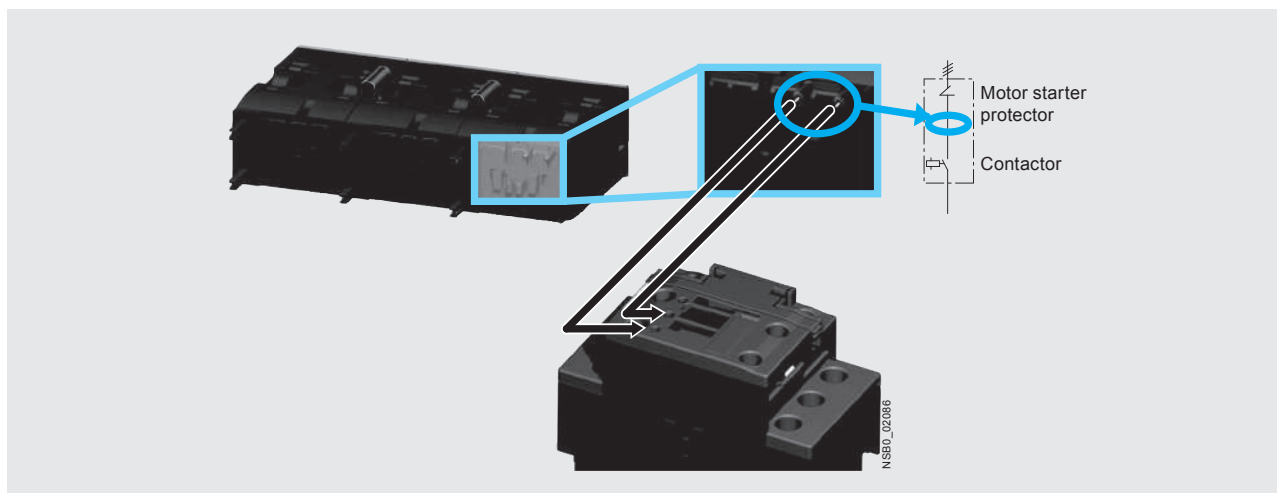

Availability signal through voltage pick-off

Function Modules for Mounting onto SIRIUS 3RT2 Contactors

SIRIUS function modules for AS-Interface

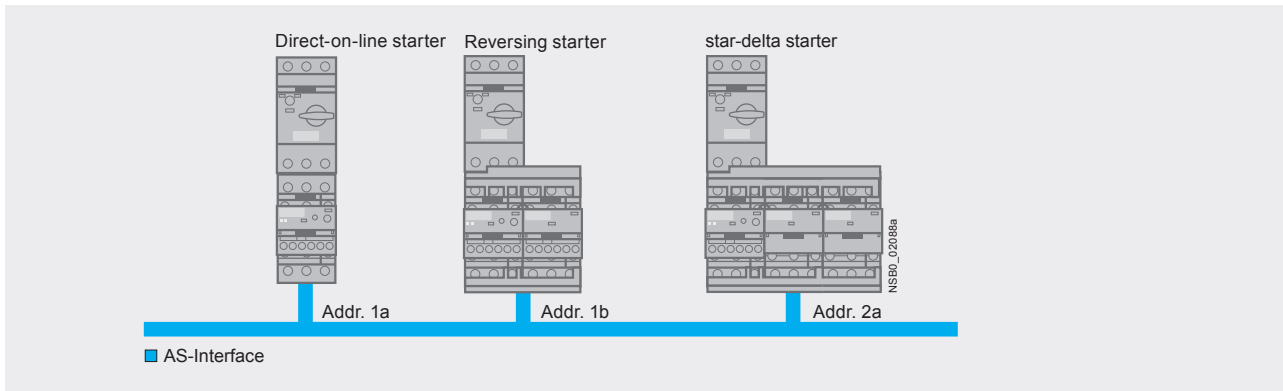

Topology with AS-Interface

This easy integration of the starters in the TIA world does not limit the flexibility in the field in the least. For example, all function modules have special terminals in order to enable direct local disconnection. These terminals can be connected for example,

to a position switch. The input interrupts the voltage supply to the contactor coil directly, i. e. without going through the PLC. These terminals are jumpered in the as-delivered state.

Application

The use of SIRIUS function modules with AS-Interface is recommended above all in machines and plants requiring easy connection of several different sensors and actuators both inside and outside the control cabinet to the higher-level control system. And with IO modules no longer needed, the width of the PLC is far smaller.

Benefits

- Reduction of control current wiring
- Elimination of testing costs and wiring errors
- Reduction of configuration work
- Elimination of IO modules saves space in the control cabinet
- All essential timing and interlocking functions for reversing duty and wye-delta starting are integrated
- No additional control circuit required

Function Modules for Mounting onto SIRIUS 3RT2 Contactors

SIRIUS function modules for AS-Interface

Selection and ordering data

Version	Screw terminals	Spring-type terminals	Weight
	Order No.	Order No.	kg
Function modules for direct-on-line starting			
<p>3RA2712-1AA00</p> <p>3RA2712-2AA00</p>	<p>AS-Interface connection</p> <p>3RA2712-1AA00</p>	<p>3RA2712-2AA00</p>	
Function modules for reversing starting¹⁾			
<p>3RA2712-1BA00</p> <p>3RA2712-2BA00</p>	<p>AS-Interface connection, comprising one basic and one coupling module</p> <p>3RA2712-1BA00</p>	<p>3RA2712-2BA00</p>	
<p>3RA2923-2AA1</p> <p>3RA2923-2AA2</p>	<p>Assembly kits for making 3-pole contactor assemblies The assembly kit contains: mechanical interlock, 2 connecting clips for two contactors, wiring modules on the top and bottom</p> <ul style="list-style-type: none"> • For size S00 • For size S0 <ul style="list-style-type: none"> - For main, auxiliary and control current - Only for main current • For size S2 <ul style="list-style-type: none"> - For main, auxiliary and control current - Only for main current 	<p>3RA2913-2AA1</p> <p>3RA2913-2AA2</p> <p>3RA2923-2AA1</p> <p>--</p> <p>3RA2923-2AA2</p> <p>3RA2933-2AA1</p> <p>--</p> <p>3RA2933-2AA2</p>	

Matching contactors with communications interface required; see page 2/26.

For matching AS-Interface masters, routers and power supply units, see Chapter 14 "Industrial Communication".

1) For prewired contactor assemblies for reversing starting with communication interface, see pages 2/40 and 2/43. When these contactor assemblies are used, the assembly kit for the wiring is already integrated.

Function Modules for Mounting onto SIRIUS 3RT2 Contactors

SIRIUS function modules for AS-Interface

Function modules for wye-delta starting¹⁾



3RA2712-1CA00



3RA2712-2CA00

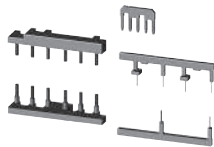

3RA2923-2BB1



3RA2923-2BB2

AS-Interface connection, comprising one basic module and two coupling modules

Assembly kits for making 3-pole contactor assemblies

The assembly kit contains:
mechanical interlock,
4 connecting clips for 3 contactors;
star jumper,
wiring modules on the top and bottom

- For size S00
- For size S0
 - For main, auxiliary and control circuits
 - Only for main circuit
- For size S2
 - For main, auxiliary and control circuits
 - Only for main circuit

1) For complete contactor assemblies for wye-delta starting including function modules, see pages 2/47 and 2/48.

Version	Screw terminals	Spring-type terminals	Weight
	Order No.	Order No.	kg
	3RA2712-1CA00	3RA2712-2CA00	
	3RA2913-2BB1	3RA2913-2BB2	
	3RA2923-2BB1 --	-- 3RA2923-2BB2	
	3RA2933-2BB1 --	-- 3RA2933-2BB2	

Matching contactors with communications interface required; see page 2/26.

For matching AS-Interface masters, routers and power supply units, see Chapter 14 "Industrial Communication".

Accessories



3RA2711-0EE10



3RA2711-0EE06



3RA2711-0EE15



3RA2910-0

Module connector set, comprising:
• 2 module connectors, 14-pole, short
• 2 interface covers

Module connectors
• 14-pole, 9 cm
For size jump + 1 space

Interface covers
(Set of 5)

Sealable covers
For 3RA27, 3RA28, 3RA29

Version	Order No.	Weight
		kg
	3RA2711-0EE10	
	3RA2711-0EE06	
	3RA2711-0EE15	
	3RA2910-0	

For manuals, see <http://support.automation.siemens.com/WW/view/en/39318922>.

Function Modules for Mounting onto SIRIUS 3RT2 Contactors

SIRIUS function modules

Technical specifications

Type		3RA2811	3RA2831	3RA2812	3RA2832	3RA2816	
Can be used for size		S00, S0	S2	S00, S0	S2	S00, S0, S2	
Function		ON-delay		OFF-delay with control signal		Wye-delta function	
General data							
Rated insulation voltage U_i	V AC	300					
Pollution degree 3 Overvoltage category III							
Rated impulse withstand voltage U_{imp}	kV AC	4					
Operating range of excitation		0.85 ... 1.1 x U_s , 0.95 ... 1.05 times the rated frequency					
Overvoltage protection		Varistor integrated					
Rated power	W	1				1	
• Power consumption at 230 V AC, 50 Hz	VA	1				2	
DIASED protection	Operational class gG	A	--				
Switching frequency for load							
• With I_b at 230 V AC	h^{-1}	2 500				--	
• With 3RT2 contactor at 230 V AC	h^{-1}	2 500				--	
Recovery time	ms	50				150	
Minimum ON period	ms	--				35	
Residual current	Max.	mA	5				--
Voltage drop	Max.	VA	3.5				--
With conducting output							
Setting accuracy	Typ.	±15 %					
With reference to upper limit of scale							
Repeat accuracy	Max.	±1 %					
Electrical endurance							
• With 3RT2028 contactor	Operating cycles	100 000				--	
• At AC-15, 250 V, 3 A	Operating cycles	--				100 000	
Mechanical endurance	Operating cycles	100 x 10 ⁶				10 x 10 ⁶	
Permissible ambient temperature							
• During operation	°C	-25 ... +60					
• During storage	°C	-40 ... +80					
Degree of protection acc. to IEC 60947-1, Appendix C		IP20					
Shock resistance	g/ms	15/11					
Half-sine acc. to IEC 60068-2-27							
Vibration resistance	Hz/mm	10 ... 55/0.35					
According to IEC 60068-2-6							
Electromagnetic compatibility (EMC)		IEC 61000-6-2, IEC 61000-6-4, IEC 61812-1, IEC 60947-4-1					
Overvoltage protection		Varistor integrated					
Permissible mounting position		Any (see contactor)					
Conductor cross-sections							
Connection type		Screw terminals					
(1 or 2 conductors can be connected)							
• Solid	mm^2	1 x (0.5 ... 4), 2 x (0.5 ... 2.5)				--	
• Finely stranded with end sleeve	mm^2	1 x (0.5 ... 2.5), 2 x (0.5 ... 1.5)				--	
• AWG cables, solid or stranded	AWG	2 x (20 ... 14)				--	
• Terminal screws		M3 (for standard screw driver size 2 or Pozidriv 2)				--	
• Tightening torque	Nm	0.8 ... 1.2				--	
Connection type		Spring-type terminals					
(1 or 2 conductors can be connected)							
• Operating devices	mm	3.0 x 0.5				--	
• Solid	mm^2	2 x (0.25 ... 1.5)				--	
• Finely stranded with end sleeve	mm^2	2 x (0.25 ... 1.5)				--	
• Finely stranded	mm^2	2 x (0.25 ... 1.5)				--	
• AWG cables, solid or stranded	AWG	2 x (24 ... 16)				--	

Contactors Assemblies for Switching Motors

3RA reversing contactor assemblies

Design

Complete equipment assemblies

The fully wired reversing contactor assemblies are suitable for use in any climate. They are safe from touch to EN 50274.

The contactor assemblies each consist of two contactors with identical ratings. The contactors are mechanically and electrically interlocked (NC contact interlock). The main and control circuits are wired according to the circuit diagrams on page 2/202.

For motor protection, either 3RU2 or 3RB3 overload relays for direct mounting or individual mounting or thermistor motor protection tripping units must be ordered separately.

Components for customer assembly

Installation kits for all sizes are available for customer assembly of reversing contactor assemblies.

Contactors, overload relays, the mechanical interlock and — for momentary-contact operation — auxiliary switch blocks for latching must be ordered separately

The following points should be noted:

Size S00

- For maintained-contact operation: use contactors with an NC contact in the basic unit for the electrical interlock.
- For momentary-contact operation: use contactors with an NC contact in the basic unit for the electrical interlock; in addition, an auxiliary switch block with at least one NO contact for latching is required per contactor.

Size S0 and S2

Contactors come equipped with integrated 1 NO and 1 NC aux contacts in each contactor. Both electrical interlocking and latching are satisfied with the integrated auxiliaries. Mechanical interlocking is required in either size and comes in the assembly kits except for size S2 where you need to order 3RA2934-2B interlock separately.

Sizes S3

- For maintained-contact operation: the contactors have no auxiliary contact in the basic unit; NC contacts for the electrical interlock are therefore integrated in the mechanical interlock that can be mounted on the side of each contactor (one contact each for the left and right-hand contactors).
- For momentary-contact operation: the electrical interlock is the same as for maintained-contact operation; in addition, an auxiliary switch with one NO contact for latching is required per contactor. This contact can be snapped onto the top of the contactors. Alternatively, auxiliary switch blocks mounted on the side can be used; they must be fitted onto the outside of each contactor.

If the front-mounted mechanical interlock is used for size S2 to S3 contactors, two location holes for single-pole auxiliary switch blocks are provided on the front of each S2 contactor while three additional, single-pole auxiliary switch blocks can be snapped onto S3 contactors. The maximum auxiliary switch complements per contactor stated on page 2/12 must not be exceeded.

When size S3 contactors are combined with a front-mounted mechanical interlock, the 3RA19 33-2B and 3RA19 43-2B installation kits cannot be used.

Sizes S6 to S12

To insert the mechanical interlock, the prestamped location holes positioned opposite on the contactor must be knocked out. The internal auxiliary contacts (up to 1 NO + 1 NC per contactor) can be used for the electrical interlock and latching. The mechanical interlock itself does not contain any auxiliary contacts. Additional auxiliary contacts can be used on the outside and front (on the front in the case of 3RT10) of the reversing contactor assembly.

Principle of operation

The operating times of the individual 3RT10/20 contactors are rated in such a way that no overlapping of the contact making and the arcing time between two contactors can occur on reversing, providing they are interlocked via their auxiliary switches (NC contact interlock) and the operating mechanisms. An additional dead interval of 50 ms is necessary on reversing if the individual contactors are used at voltages > 500 V. The operating times of the individual contactors are not affected by the mechanical interlock.

Surge suppression

Sizes S00 to S3

All contactor assemblies can be fitted with RC elements or varistors for damping opening surges in the coil.

As with the individual contactors, the surge suppressors can either be plugged onto the front of the contactors (S00) or fitted onto the coil terminals on the top or bottom (S3). For sizes S0 and S2, the surge protection fits behind the hinged door on the front of the contactor and does not take up any additional space.

Sizes S6 to S12

The contactors are fitted with varistors as standard.

Contactors Assemblies for Switching Motors

3RA13 and 3RA23 reversing contactor assemblies

Overview

The 3RA13 and 3RA23 reversing contactor assemblies can be ordered as follows:

Sizes S00 to S3

- Fully wired and tested, open type, with mechanical and electrical interlock. 1)

Sizes S00 to S12

- As components for customer assembly.

There is also a range of accessories (auxiliary switch blocks, surge suppressors, etc.) that must be ordered separately.

For overload relays for motor protection, see section 3.

The 3RA23 and 3RA13 contactor assemblies have screw connections and are available for screwing or snapping onto 35 mm standard mounting rails. The 3RA23 contactor assemblies are also available with spring-type terminals.

The © and ® approvals only apply to the complete contactor assemblies and not to the components for customer assembly.

AC and DC operation
See pages 2/40 through 2/44 for complete part numbers.

Maximum horsepower rating at 460 V AC	AC-3 maximum inductive current	Size	Order No.				Installation kit	Fully wired and tested contactor assembly
			Contactor	Mechanical interlock 2)	Mechanical interlock 3)	Mechanical interlock 4)		
HP	A							
3	7	S00	3RT20 15	3RA29 13-2AA1 6)	–	–	3RA29 13-2AA1 6)	3RA23 15-8XB30- ...
5	9		3RT20 16					3RA23 16-8XB30- ...
7.5	12		3RT20 17					3RA23 17-8XB30- ...
10	16		3RT20 18					3RA23 18-8XB30- ...
7.5	12	S0	3RT20 24	3RA29 23-2AA1 6)	–	–	3RA29 23-2AA1 6)	3RA23 24-8XB30- ...
10	16		3RT20 25					3RA23 25-8XB30- ...
15	25		3RT20 26					3RA23 26-8XB30- ...
20	32		3RT20 27					3RA23 27-8XB30- ...
25	38		3RT20 28					3RA23 28-8XB30- ...
30	40	S2	3RT20 35	3RA29 34-2B	–	–	3RA29 33-2AA1 7)	3RA23 35-8XB30-1 ..
40	50		3RT20 36					3RA23 36-8XB30-1 ..
50	65		3RT20 37					3RA23 37-8XB30-1 ..
50	80		3RT20 38					3RA23 38-8XB30-1 ..
50	65	S3	3RT20 44	3RA29 34-2B	–	–	3RA29 43-2AA1 8)	3RA13 44-8XB30-1 ..
60	80		3RT20 45					3RA13 45-8XB30-1 ..
75	95		3RT20 46					3RA13 46-8XB30-1 ..
100	115	S6	3RT10 54	–	–	3RA19 54-2A	3RA19 53-2A 9)	–
125	150		3RT10 55					
150	185		3RT10 56					
150	225	S10	3RT10 64	–	–	3RA19 54-2A	3RA19 63-2A 9)	–
200	265		3RT10 65					
250	300		3RT10 66					
300	400	S12	3RT10 75	–	–	3RA19 54-2A	3RA19 73-2A 9)	–
400	500		3RT10 76					

For accessories, see page 2/80-2/83.
For circuit diagrams, see page 2/202.
For dimension drawings, see page 2/221-2/223.

- 1) An additional dead interval of 50 ms is necessary on reversing at voltages > 500 V.
- 2) Laterally mountable with one auxiliary contact (except no auxiliary contact in S2 & S3)
- 3) For front mounting with one auxiliary contact.
- 4) Laterally mountable without auxiliary contact.
- 5) Interlock must be ordered with installation kit.
- 6) Installation kit contains: mechanical interlock; 2 connecting clips for 2 contactors; wiring connectors on the top and bottom.
- 7) Installation kit contains: 2 connecting clips for 2 contactors; wiring connectors on the top and bottom and the mechanical interlock.
- 8) Installation kit contains: 2 connecting clips for 2 contactors; wiring connectors on the top and bottom.
- 9) Installation kit contains: wiring connector on the top and bottom.

Contactors Assemblies for Switching Motors

3RA23 reversing contactor assemblies

Fully wired and tested reversing contactor assemblies · Size S00 – Up to 10 HP

The figure shows the version with screw terminals

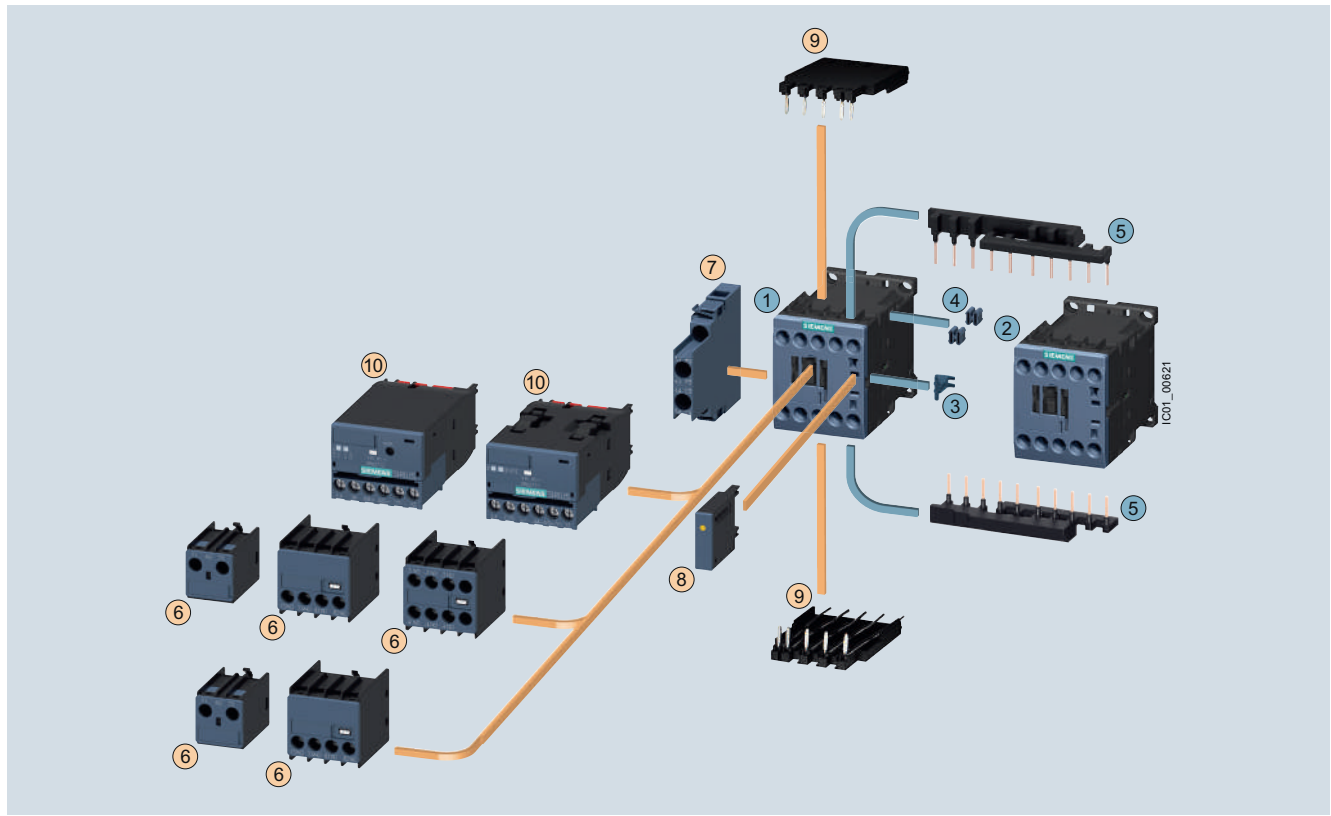

Mountable accessories (optional)

To be ordered separately	Type
⑥ Auxiliary switch block, front ¹⁾	3RH2911
⑦ Auxiliary switch block, lateral	3RH2921
⑧ Surge suppressors	3RT2916
⑨ Solder pin adapters	3RT1916-4KA1
⑩ Function module for connection to the control system	3RA271.-1BA00

Complete reversing contactor assembly

Individual parts	Type	Q11	Q12
① ② Contactors, 3 kW	3RT2015	3RT2015	
① ② Contactors, 4 kW	3RT2016	3RT2016	
① ② Contactors, 5.5 kW	3RT2017	3RT2017	
① ② Contactors, 7.5 kW	3RT2018	3RT2018	
③ ... ⑤ Assembly kit comprising:	3RA2913-2AA1		
③	Mechanical interlock ²⁾		
④	Two connecting clips for two contactors ²⁾		
⑤	Wiring modules on the top and bottom for connecting the main current circuits, electrical interlock included ³⁾ , interruptible (NC contact interlock)		

¹⁾ Auxiliary switch block according to EN 50005 must be used.

²⁾ The parts ③ and ④ can only be ordered together as 3RA2912-2H mechanical connectors.

³⁾ 3RT201. contactors with one NC contact in the basic unit are required for the electrical interlock. An additional NO contact is required for momentary-contact operation.

Contactor Assemblies for Switching Motors

3RA23 reversing contactor assemblies

Fully wired and tested contactor assemblies²⁾ · Size S00 · Up to 10 HP

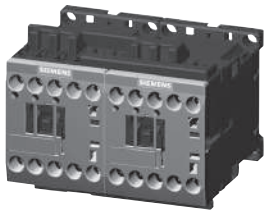

3RA23 18-8XE30-1BB4

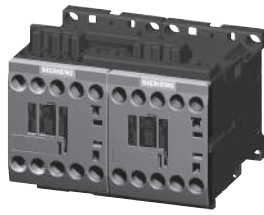

3RA23 1.-8XB30-1A..

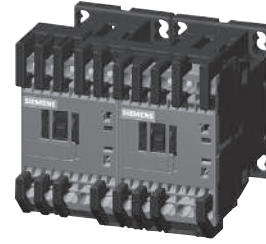

3RA23 1.-8XB30-2A..

AC data		UL data					Rated control supply voltage U_s at 50/60 Hz		Auxiliary contacts		Screw terminals		Weight approx.
Amp ratings	Single-phase HP ratings	Three-phase HP ratings				NO	NC	Spring-type terminals	Order No.				
AC2/AC3	115 V 230 V	200 V	230 V	460 V	575 V							kg	
AC operation, 50/60 Hz													
<i>Size S00¹⁾</i>													
7	1/4	3/4	1 1/2	2	3	5	24 AC	0	2	3RA23 15-8XB30-□AB0	0.46/0.50		
7	1/4	3/4	1 1/2	2	3	5	110/120 AC	0	2	3RA23 15-8XB30-□AK6	0.46/0.50		
7	1/4	3/4	1 1/2	2	3	5	220/240 AC	0	2	3RA23 15-8XB30-□AP6	0.46/0.50		
9	1/3	1	2	3	5	7 1/2	24 AC	0	2	3RA23 16-8XB30-□AB0	0.46/0.50		
9	1/3	1	2	3	5	7 1/2	110/120 AC	0	2	3RA23 16-8XB30-□AK6	0.46/0.50		
9	1/3	1	2	3	5	7 1/2	220/240 AC	0	2	3RA23 16-8XB30-□AP6	0.46/0.50		
12	1/2	2	3	3	7 1/2	10	24 AC	0	2	3RA23 17-8XB30-□AB0	0.46/0.50		
12	1/2	2	3	3	7 1/2	10	110/120 AC	0	2	3RA23 17-8XB30-□AK6	0.46/0.50		
12	1/2	2	3	3	7 1/2	10	220/240 AC	0	2	3RA23 17-8XB30-□AP6	0.46/0.50		
16	1	2	3	5	10	10	24 AC	0	2	3RA23 18-8XB30-□AB0	0.46/0.50		
16	1	2	3	5	10	10	110/120 AC	0	2	3RA23 18-8XB30-□AK6	0.46/0.50		
16	1	2	3	5	10	10	220/240 AC	0	2	3RA23 18-8XB30-□AP6	0.46/0.50		
DC operation													
7	1/4	3/4	1 1/2	2	3	5	24 DC	0	2	3RA23 15-8XB30-□BB4	0.58/0.62		
9	1/3	1	2	3	5	7 1/2	24 DC	0	2	3RA23 16-8XB30-□BB4	0.58/0.62		
12	1/2	2	3	3	7 1/2	10	24 DC	0	2	3RA23 17-8XB30-□BB4	0.58/0.62		
16	1	2	3	5	10	10	24 DC	0	2	3RA23 18-8XB30-□BB4	0.58/0.62		
With communication interface³⁾													
7	1/4	3/4	1 1/2	2	3	5	24 DC	0	2	3RA23 15-8XE30-□BB4	0.58/0.62		
9	1/3	1	2	3	5	7 1/2	24 DC	0	2	3RA23 16-8XE30-□BB4	0.58/0.62		
12	1/2	2	3	3	7 1/2	10	24 DC	0	2	3RA23 17-8XE30-□BB4	0.58/0.62		
16	1	2	3	5	10	10	24 DC	0	2	3RA23 18-8XE30-□BB4	0.58/0.62		

1 Screw terminals
2 Spring-loaded terminals

For other voltages see page 2/49

For accessories and spare parts, see page 2/66-2/83.

- 1) For coil operating range, see page 2/49.
- 2) The contactors integrated in the contactor assemblies have no unassigned auxiliary contacts.
- 3) For use with 3RA27 and 3RA28 communication modules. See pages 2/24 to 2/31.

Contactors Assemblies for Switching Motors

3RA23 reversing contactor assemblies

Fully wired and tested reversing contactor assemblies · Size S0 – Up to 25 HP

The figure shows the version with screw terminals

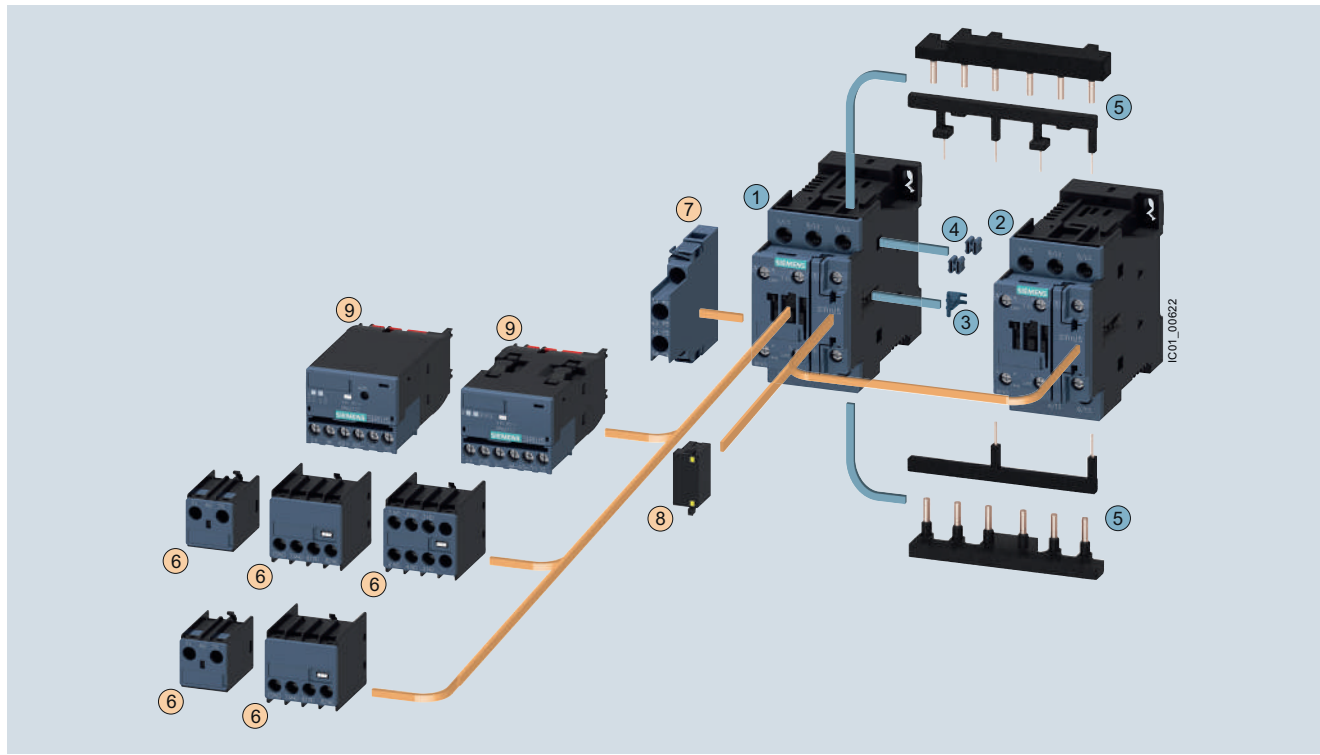

Mountable accessories (optional)

To be ordered separately	Type
⑥ Auxiliary switch block, front	3RH2911
⑦ Auxiliary switch block, lateral	3RH2921
⑧ Surge suppressors	3RT2926
⑨ Function module for connection to the control system	3RA271.-1BA00

Complete reversing contactor assembly

Individual parts	Type	
	Q11	Q12
① ② Contactors, 5.5 kW	3RT2024	3RT2024
① ② Contactors, 7.5 kW	3RT2025	3RT2025
① ② Contactors, 11 kW	3RT2026	3RT2026
① ② Contactors, 15 kW	3RT2027	3RT2027
① ② Contactors, 18.5 kW	3RT2028	3RT2028
③ ... ⑤ Assembly kit comprising:	3RA2923-2AA1	
③ Mechanical interlock ¹⁾		
④ Two connecting clips for two contactors ¹⁾		
⑤ Wiring modules on the top and bottom for connecting the main current circuits, electrical interlock included (NC contact interlock)		

¹⁾ The parts ③ and ④ can only be ordered together as 3RA2922-2H mechanical connectors.

Contactors Assemblies for Switching Motors

3RA23 reversing contactor assemblies

Fully wired and tested contactor assemblies · Size S0 · up to 25 HP

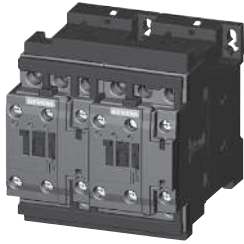

3RA23 24-8XE30-1BB4

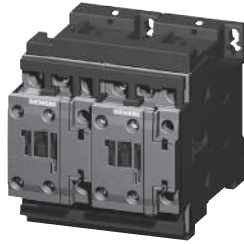

3RA23 2.-8XB30-1A..

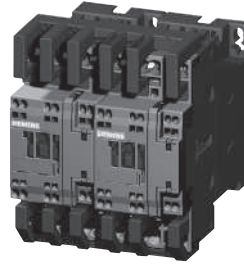

3RA23 2.-8XB30-2A..

AC data		UL data					Rated control supply voltage U_s at 50/60 Hz	Auxiliary contacts		Screw terminals		Weight approx.
Amp ratings	AC2/AC3	Single-phase HP ratings		Three-phase HP ratings				NO	NC	Spring-type terminals	Order No.	
		115 V	230 V	200 V	230 V	460 V	575 V					kg

AC operation, 50/60 Hz

Size S0¹⁾

Size	1	2	3	3	7 1/2	10	24 AC	2	2	3RA23 24-8XB30-□AC2	0.84/0.94
12	1	2	3	3	7 1/2	10	110/120 AC	2	2	3RA23 24-8XB30-□AK6	0.84/0.94
12	1	2	3	3	7 1/2	10	220/240 AC	2	2	3RA23 24-8XB30-□AP6	0.84/0.94
16	1	3	5	5	10	15	24 AC	2	2	3RA23 25-8XB30-□AC2	0.84/0.94
16	1	3	5	5	10	15	110/120 AC	2	2	3RA23 25-8XB30-□AK6	0.84/0.94
16	1	3	5	5	10	15	220/240 AC	2	2	3RA23 25-8XB30-□AP6	0.84/0.94
25	2	3	7 1/2	7 1/2	15	20	24 AC	2	2	3RA23 26-8XB30-□AC2	0.84/0.94
25	2	3	7 1/2	7 1/2	15	20	110/120 AC	2	2	3RA23 26-8XB30-□AK6	0.84/0.94
25	2	3	7 1/2	7 1/2	15	20	220/240 AC	2	2	3RA23 26-8XB30-□AP6	0.84/0.94
32	2	5	10	10	20	25	24 AC	2	2	3RA23 27-8XB30-□AC2	0.84/0.94
32	2	5	10	10	20	25	110/120 AC	2	2	3RA23 27-8XB30-□AK6	0.84/0.94
32	2	5	10	10	20	25	220/240 AC	2	2	3RA23 27-8XB30-□AP6	0.84/0.94
38	3	5	10	10	25	25	24 AC	2	2	3RA23 28-8XB30-□AC2	0.84/0.94
38	3	5	10	10	25	25	110/120 AC	2	2	3RA23 28-8XB30-□AK6	0.84/0.94
38	3	5	10	10	25	25	220/240 AC	2	2	3RA23 28-8XB30-□AP6	0.84/0.94

DC operation

12	1	2	3	3	7 1/2	10	24 DC	2	2	3RA23 24-8XB30-□BB4	1.22/1.32
16	1	3	5	5	10	15	24 DC	2	2	3RA23 25-8XB30-□BB4	1.22/1.32
25	2	3	7 1/2	7 1/2	15	20	24 DC	2	2	3RA23 26-8XB30-□BB4	1.22/1.32
32	2	5	10	10	20	25	24 DC	2	2	3RA23 27-8XB30-□BB4	1.22/1.32
38	3	5	10	10	25	25	24 DC	2	2	3RA23 28-8XB30-□BB4	1.22/1.32

With communication interface²⁾

12	1	2	3	3	7 1/2	10	24 DC	2	2	3RA23 24-8XE30-□BB4	1.22/1.32
16	1	3	5	5	10	15	24 DC	2	2	3RA23 25-8XE30-□BB4	1.22/1.32
25	2	3	7 1/2	7 1/2	15	20	24 DC	2	2	3RA23 26-8XE30-□BB4	1.22/1.32
32	2	5	10	10	20	25	24 DC	2	2	3RA23 27-8XE30-□BB4	1.22/1.32
38	3	5	10	10	25	25	24 DC	2	2	3RA23 28-8XE30-□BB4	1.22/1.32

1 Screw terminals
2 Spring-loaded terminals

For other voltages see page 2/49.

For accessories and spare parts, see page 2/66-2/83.

1) For coil operating range, see page 2/49.

2) For use with 3RA27 and 3RA28 communication modules. See pages 2/24 to 2/31.

Contactors Assemblies for Switching Motors

3RA23 reversing contactor assemblies

Selection and ordering data

Size S2 · up to 50 HP

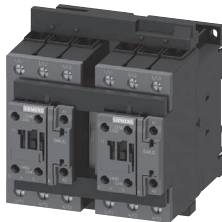

AC data Amp ratings AC2/AC3	UL data Single-phase HP ratings		Three-phase HP ratings				Rated control supply voltage ¹⁾	Auxiliary contacts		Screw Terminals ⊕ Order No.	Weight approx. kg
	115 V	230 V	200 V	230 V	460 V	575 V		NO	NC		
A	HP	HP	HP	HP	HP	HP					
AC operation											
40	3	7.5	10	15	30	40	24 V, 50/60 Hz 120 V, 60 Hz 240 V, 60 Hz	2 2 2 2 2 2		3RA2335-8XB30-1AC2 3RA2335-8XB30-1AK6 3RA2335-8XB30-1AP6	1.72
50	3	10	15	15	40	50	24 V, 50/60 Hz 120 V, 60 Hz 240 V, 60 Hz	2 2 2 2 2 2		3RA2336-8XB30-1AC2 3RA2336-8XB30-1AK6 3RA2336-8XB30-1AP6	1.72
65	5	10	20	20	50	50	24 V, 50/60 Hz 120 V, 60 Hz 240 V, 60 Hz	2 2 2 2 2 2		3RA2337-8XB30-1AC2 3RA2337-8XB30-1AK6 3RA2337-8XB30-1AP6	2.548
80 ¹⁾	5	15	20	25	50	60	24 V, 50/60 Hz 120 V, 60 Hz 240 V, 60 Hz	2 2 2 2 2 2		3RA2338-8XB30-1AC2 3RA2338-8XB30-1AK6 3RA2338-8XB30-1AP6	2.548
AC/DC operation											
40	3	7.5	10	15	30	40	20-33 AC/DC	2 2		3RA2335-8XB30-1NB3	2.5
50	3	10	15	15	40	50	20-33 AC/DC	2 2		3RA2336-8XB30-1NB3	
65	5	10	20	20	50	50	20-33 AC/DC	2 2		3RA2337-8XB30-1NB3	
80 ¹⁾	5	15	20	25	50	60	20-33 AC/DC	2 2		3RA2338-8XB30-1NB3	

For Reversing Contactors with communication interface: replace the 8XB30-1NB3 with 8XE30-1NB3.

1) Max UL FLA = 65A at 460V

Fully wired and tested reversing contactor assemblies · Size S2 · Up to 50 HP

The figure shows the version with screw terminals

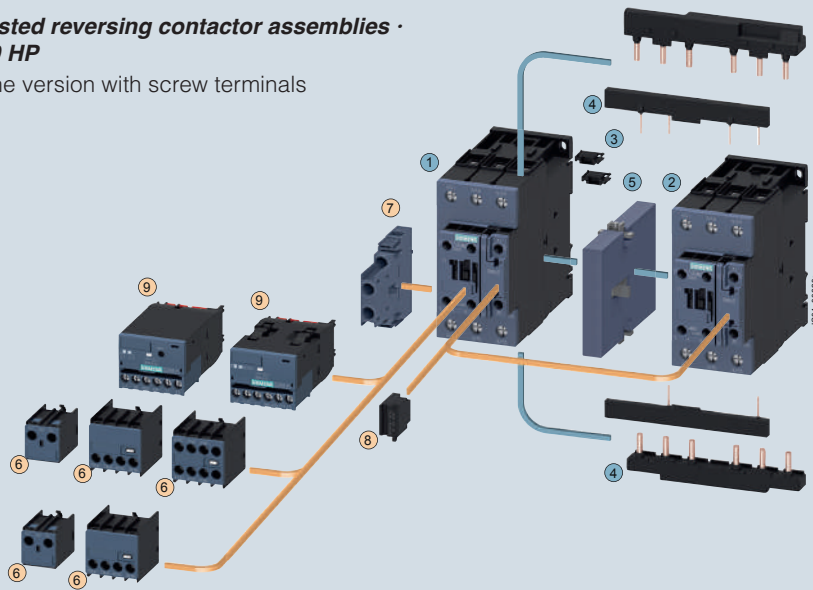

Mountable accessories (optional)

To be ordered separately	Type
⑥ Auxiliary switch block, front	3RH2911
⑦ Auxiliary switch block, lateral	3RH2921
⑧ Surge suppressors	3RT2936
⑨ Function module for connection to the control system	3RA271.-1BA00

For further voltages, see page 2/49.
 For overview, see page 2/37-2/38.
 For accessories, see page 2/66-2/83.
 For circuit diagrams, see page 2/203.
 For dimension drawings, see page 2/221.

Coil voltage tolerance:
 at 50Hz: 0.8 to 1.1 x Us
 at 60Hz: 0.85 to 1.1 x Us
 at AC/DC: 0.8 to 1.1 x Us

Complete reversing contactor assembly

Individual parts	Type	Q11	Q12
①② Contactors, 18.5 kW	3RT2035	3RT2035	
①② Contactors, 22 kW	3RT2036	3RT2036	
①② Contactors, 30 kW	3RT2037	3RT2037	
①② Contactors, 37 kW	3RT2038	3RT2038	
③④ Assembly kit comprising:	3RA2933-2AA1		
③ Two connectors for two contactors			
④ Wiring modules on the top and bottom for connecting the main and auxiliary current circuits, electrical interlock included (NC contact interlock)			
⑤ Mechanical interlock (must be ordered separately)	3RA2934-2B		

Contactors Assemblies for Switching Motors

3RA23 reversing contactor assemblies

Selection and ordering data

Size S3 · up to 75 HP

AC data Amp ratings AC2/AC3	UL data Single-phase HP ratings		Three-phase HP ratings				Rated control supply voltage ¹⁾	Auxiliary contacts		Fully wired and tested contactor assembly Order No.	Weight approx. kg
	115 V	230 V	200 V	230 V	460 V	575 V		NO	NC		
A	HP	HP	HP	HP	HP	HP					
AC operation											
80	5	15	20	25	50	60	24 V, 50/60 Hz 120 V, 60 Hz 240 V, 60 Hz	0 2 0 2 0 2		3RA2345-8XB30-1AC2 3RA2345-8XB30-1AK6 3RA2345-8XB30-1AP6	3.9
95	7.5	15	25	30	60	75	24 V, 50/60 Hz 120 V, 60 Hz 240 V, 60 Hz	0 2 0 2 0 2		3RA2346-8XB30-1AC2 3RA2346-8XB30-1AK6 3RA2346-8XB30-1AP6	3.9
110	10	20	30	30	75	100	24 V, 50/60 Hz 120 V, 60 Hz 240 V, 60 Hz	0 2 0 2 0 2		3RA2347-8XB30-1AC2 3RA2347-8XB30-1AK6 3RA2347-8XB30-1AP6	3.9
AC/DC operation											
80	5	15	20	25	50	60	20-33 V AC/DC	0 2		3RA2345-8XB30-1NB3	5.7
95	7.5	15	25	30	60	75	20-33 V AC/DC	0 2		3RA2346-8XB30-1NB3	
110	10	20	30	30	75	100	20-33 V AC/DC	0 2		3RA2347-8XB30-1NB3	



Fully wired and tested reversing contactor assemblies · Size S3 · Up to 75 HP

The figure shows the version with screw terminals

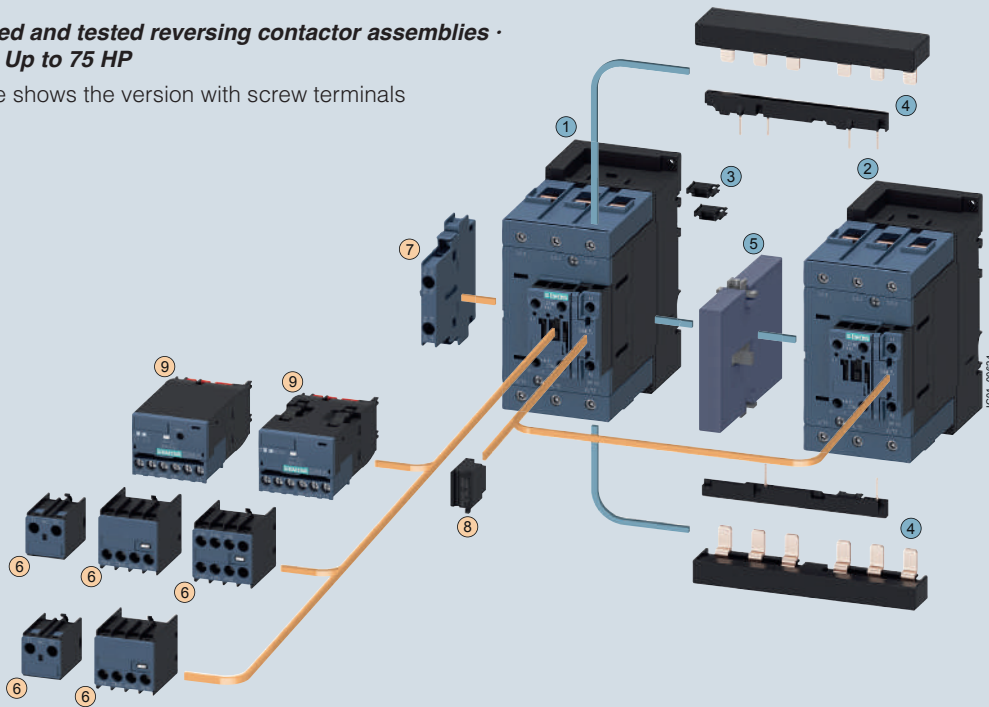

Mountable accessories (optional)

To be ordered separately	Type
① Auxiliary switch block, front	3RH2911
② Auxiliary switch block, lateral	3RH2921
③ Surge suppressors	3RT2936
④ Function module for connection to the control system (the associated module connectors 3RA2711-0EE17 must be ordered separately)	3RA2711.-1BA00

For further voltages, see page 2/49.
 For overview, see page 2/37-2/38.
 For accessories, see page 2/66-2/83.
 For circuit diagrams, see page 2/203.
 For dimension drawings, see page 2/221.

1) Coil voltage tolerance
 at 50 Hz: 0.8 ... 1.1 x U_s
 at 60 Hz: 0.85 ... 1.1 x U_s

Complete reversing contactor assembly

Individual parts	Type	Q11	Q12
① ② Contactors, 37 kW	3RT2045	3RT2045	
① ② Contactors, 45 kW	3RT2046	3RT2046	
① ② Contactors, 55 kW	3RT2047	3RT2047	
③ ④ Assembly kit comprising:	3RA2943-2AA1		
③ Two connectors for two contactors			
④ Wiring modules on the top and bottom for connecting the main and auxiliary current circuits, electrical interlock included (NC contact interlock)			
⑤ Mechanical interlock (must be ordered separately)	3RA2934-2B		

3RA24 Contactor Assemblies for Wye-Delta Starting

3RA24 complete units, 5.5 ... 22 kW

Overview

These 3RA24 contactor assemblies for wye-delta starting are designed for standard applications.

Note:

Contactor assemblies for wye-delta starting in special applications such as very heavy starting or wye-delta starting of special motors must be customized. Help with designing such special applications is available from Technical Assistance.

The 3RA24 contactor assemblies for wye-delta starting can be ordered as follows:

Sizes S00 and S0

- Fully wired and tested, with electrical and mechanical interlock.
- As individual parts for customer assembly.

A dead interval of 50 ms on reversing is already integrated in the function module for wye-delta starting.

There is also a range of accessories (lateral auxiliary switch blocks, etc.) that must be ordered separately.

[For overload relays for motor protection see Chapter 3 "Overload Relays" --> "3RB3 Solid-State Overload Relays".](#)

The 3RA24 contactor assemblies have screw or spring-type terminals and are suitable for screwing or snapping onto TH 35 standard mounting rails.

With the fully wired and tested 3RA24 contactor assemblies, the auxiliary contacts included in the basic devices are unassigned.

Motor protection

Overload relays or thermistor motor protection releases can be used for overload protection.

The overload relay can be either mounted onto the line contactor or separately fitted. It must be set to 0.58 times the rated motor current.

Surge suppression

Sizes S00 and S0

Surge suppression (varistor) is included in the function modules for wye-delta starting.

Function modules for wye-delta starting

The 3RA28 16-0EW20 wye-delta function module ([see page 2/27](#)) replaces the complete wiring in the control circuit and can be used in the voltage range from 24 to 240 V AC/DC. It is snapped onto the front of the contactor assembly size S00 or S0.

One function module comprises a complete module kit:

- One 3RA29 12-0 basic module with integrated control logic and time setting,
- And two 3RA29 11-0 coupling modules with related connecting cables.

The scope of supply comprises a complete module kit for one contactor assembly for wye-delta starting size S00 or S0, regardless of the connection method.

Screw terminals

Rated data at AC 50 Hz 400 V			Size			
Power kW	Operational current I_e A	Motor current A		Line/delta contactor	Star contactor	Order No. complete
5.5	12	9.5 ... 13.8	S00-S00-S00	3RT2015-1....	3RT2015-1....	3RA2415-8XF32-1...
7.5	16	12.1 ... 17		3RT2017-1....	3RT2015-1....	3RA2416-8XF32-1...
11	25	19 ... 25		3RT2018-1....	3RT2016-1....	3RA2417-8XF32-1...
11	25	19 ... 25	S0-S0-S0	3RT2024-1...0	3RT2024-1...0	3RA2423-8XF32-1...
15	32	24.1 ... 34		3RT2026-1...0	3RT2024-1...0	3RA2425-8XF32-1...
18.5	40	34.5 ... 40		3RT2026-1...0	3RT2024-1...0	3RA2425-8XF32-1...
22	50	31 ... 43		3RT2027-1...0	3RT2026-1...0	3RA2426-8XF32-1...
22/30	50	31 ... 43	S2-S2-S0	3RT2035-1...0	3RT2026-1...0	3RA2434-8XF32-1...
37	80	62.1 ... 77.8		3RT2035-1...0	3RT2027-1...0	3RA2435-8XF32-1...
45	86	69 ... 86		3RT2036-1...0	3RT2028-1...0	3RA2436-8XF32-1...
55	115	77.6 ... 108.6	S2-S2-S2	3RT2037-1...0	3RT2035-1...0	3RA2444-8XF32-1...
75	150	120.7 ... 150		3RT2045-1...0	3RT2036-1...0	3RA2445-8XF32-1...
90	160	86 ... 160		3RT2046-1...0	3RT2037-1...0	3RA2446-8XF32-1...

Spring-type terminals

Rated data at AC 50 Hz 400 V			Size			
Power kW	Operational current I_e A	Motor current A		Line/delta contactor	Star contactor	Order No. complete
5.5	12	9.5 ... 13.8	S00-S00-S00	3RT2015-2....	3RT2015-2....	3RA24 15-8XF31-2...
7.5	16	12.1 ... 17		3RT2017-2....	3RT2015-2....	3RA24 16-8XF31-2...
11	25	19 ... 25		3RT2018-2....	3RT2016-2....	3RA24 17-8XF31-2...
11	25	19 ... 25	S0-S0-S0	3RT2024-2....0	3RT2024-2....0	3RA24 23-8XF32-2...
15	32	24.1 ... 34		3RT2026-2....0	3RT2024-2....0	3RA24 25-8XF32-2...
18.5	40	34.5 ... 40		3RT2026-2....0	3RT2024-2....0	3RA24 25-8XF32-2...
25	50	31 ... 43		3RT2027-2....0	3RT2026-2....0	3RA24 26-8XF32-2...

Note:

The selection of contactor types refers to fused configurations.

3RA24 Contactor Assemblies for Wye-Delta Starting

3RA24 complete units, 5.5 ... 22 kW

Components for customer assembly

Assembly kits with wiring modules and mechanical connectors are available for contactor assemblies for wye-delta starting. Contactors, overload relays, function modules for wye-delta starting or wye-delta timing relays, auxiliary switches for electrical interlock – if required also feeder terminals and base plates – must be ordered separately.

The wiring kits for sizes S00 and S0 contain the top and bottom main conducting path connections between the line and delta

contactors (top) and between the delta and star contactors (bottom).

Control circuit

Features:

- Time setting range 0.5 to 60 s (3 selectable settings)
- Wide voltage range 24 to 240 V AC/DC
- Dead interval of 50 ms, non-adjustable.

Screw terminals

Power kW	Accessories for customer assembly			Overload relay, thermal (trip class CLASS 10)		Overload relay, solid-state (trip class CLASS 10)	
	Function modules for wye-delta starting	Assembly kit B, for single infeed	Star jumper	Setting range	Order No.	Setting range	Order No.
5.5	3RA28 16-0EW20	3RA29 13-2BB1 ¹⁾	3RT29 16-4BA31	5.5 ... 8	3RU21 16-1HB0	4 ... 16	3RB30 16-1TB0
7.5				7 ... 10	3RU21 16-1JB0		
11				11 ... 16	3RU21 16-4AB0		
11	3RA28 16-0EW20	3RA29 23-2BB2 ²⁾	3RT29 26-4BA31	11 ... 16	3RU21 26-4AB0	6 ... 25	3RB30 26-1QB0
15				14 ... 20	3RU21 26-4BB0		
18.5				20 ... 25	3RU21 26-4DB0		
22				20 ... 25	3RU21 26-4DB0		

Spring-type terminals

Power kW	Accessories for customer assembly			Overload relay, thermal (trip class CLASS 10)		Overload relay, solid-state (trip class CLASS 10)	
	Function modules for wye-delta starting	Assembly kit B, for single infeed	Star jumper	Setting range	Order No.	Setting range	Order No.
5.5	3RA28 16-0EW20	3RA29 13-2BB2 ¹⁾	3RT29 16-4BA32	5.5 ... 8	3RU21 16-1HC0	4 ... 16	3RB30 16-1TE0
7.5				7 ... 10	3RU21 16-1JC0		
11				11 ... 16	3RU21 16-4AC0		
11	3RA28 16-0EW20	3RA29 23-2BB2 ²⁾	3RT29 26-4BA32	11 ... 16	3RU21 26-4AC0	6 ... 25	3RB30 26-1QE0
15				14 ... 20	3RU21 26-4BC0		
18.5				20 ... 25	3RU21 26-4DC0		
22				20 ... 25	3RU21 26-4DC0		

¹⁾ The assembly kit contains: mechanical interlock, 4 connecting clips; wiring modules on the top (connection between line and delta contactor) and on the bottom (connection between delta and star contactor); star jumper and auxiliary circuit wiring.

²⁾ The assembly kit contains: mechanical interlock, 4 connecting clips; wiring modules on the top (connection between line and delta contactor) and on the bottom (connection between delta and star contactor); star jumper.

Order No. scheme

Digit of the Order No.	1.	2.	3.	4.	5.	6.	7.	8.	9.	10.	11.	12.	13.	14.	15.	16.		
SIRIUS contactor assemblies	3	R	A															
2nd generation				2														
Device type (e. g. 4 = contactor assembly for wye-delta starting)				4														
Contactor size (1 = S00, 2 = S0)					1													
Power dependent on size (e. g. 25 = 15 kW)						25												
Type of overload relay (8X = without)								8	X									
Assembly (F = ready-assembled, E, H = ready-assembled with communication)										F								
Interlock (3 = mechanical and electrical)											3							
Free auxiliary switches (e. g. S00: 1 = 3 NO total, S0: 2 = 3 NO + 3 NC total)												2						
Connection type (1 = screw, 2 = spring)													1					
Operating range / solenoid coil circuit (e. g. A = AC standard / without)														A				
Rated control supply voltage (e. g. K6 = 110/120 V, 50/60 Hz)															K	6		
Example	3	R	A	2	4	2	5	-	8	X	F	3	2	-	1	A	K	6

3RA24 Contactor Assemblies for Wye-Delta Starting

3RA24 complete units, 5.5 ... 22 kW

Fully wired and tested contactor assemblies · Size S00-S00-S00 · Up to 11 kW

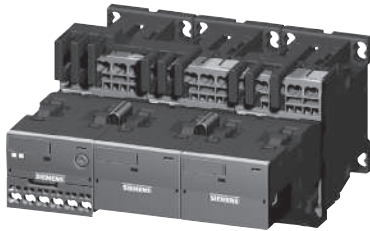

3RA24 1.-8XE31-2BB4

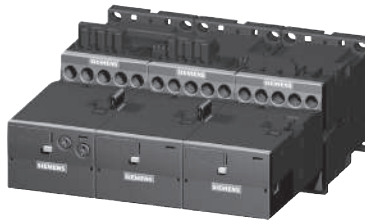

3RA24 1.-8XF31-1A.0

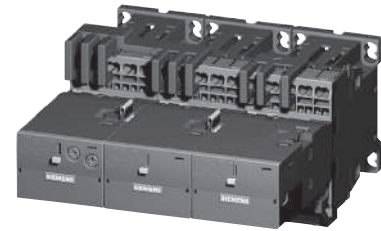

3RA24 1.-8XF31-2A.0

2 CONTACTORS AND ASSEMBLIES

Rated data AC-3						Rated control supply voltage U_s ¹⁾ at 50/60 Hz	Screw terminals		Weight approx. kg	Spring-type terminals		Weight approx. kg
Operational current I_e up to	Ratings of induction motors at 50 Hz and				Order No.		Order No.					
400 V	230 V	400 V	500 V	690 V								
A	kW	kW	kW	kW	V							
AC operation, 50/60 Hz												
12	3.3	5.5	7.2	9.2	24 AC 110/120 AC 220/240 AC	3RA24 15-8XF31-1AB0 3RA24 15-8XF31-1AF0 3RA24 15-8XF31-1AP0	0.910 0.850 0.850	3RA24 15-8XF31-2AB0 3RA24 15-8XF31-2AF0 3RA24 15-8XF31-2AP0	0.910 0.910 0.910			
16	4.7	7.5	10.3	9.2	24 AC 110/120 AC 220/240 AC	3RA24 16-8XF31-1AB0 3RA24 16-8XF31-1AF0 3RA24 16-8XF31-1AP0	0.910 0.850 0.850	3RA24 16-8XF31-2AB0 3RA24 16-8XF31-2AF0 3RA24 16-8XF31-2AP0	0.910 0.910 0.910			
25	5.5	11	11	11	24 AC 110/120 AC 220/240 AC	3RA24 17-8XF31-1AB0 3RA24 17-8XF31-1AF0 3RA24 17-8XF31-1AP0	0.850 0.850 0.850	3RA24 17-8XF31-2AB0 3RA24 17-8XF31-2AF0 3RA24 17-8XF31-2AP0	0.910 0.910 0.910			
DC operation												
12	3.3	5.5	7.2	9.2	24 DC	3RA24 15-8XF31-1BB4	0.910	3RA24 15-8XF31-2BB4	0.910			
16	4.7	7.5	10.3	9.2	24 DC	3RA24 16-8XF31-1BB4	0.910	3RA24 16-8XF31-2BB4	0.910			
25	5.5	11	11	11	24 DC	3RA24 17-8XF31-1BB4	1.030	3RA24 17-8XF31-2BB4	1.090			
For IO-Link connection												
12	3.3	5.5	7.2	9.2	24 DC	3RA24 15-8XE31-1BB4	1.030	3RA24 15-8XE31-2BB4	1.090			
16	4.7	7.5	10.3	9.2	24 DC	3RA24 16-8XE31-1BB4	1.030	3RA24 16-8XE31-2BB4	1.090			
25	5.5	11	11	11	24 DC	3RA24 17-8XE31-1BB4	1.030	3RA24 17-8XE31-2BB4	1.090			
For AS-Interface connection												
12	3.3	5.5	7.2	9.2	24 DC	3RA24 15-8XH31-1BB4	1.050	3RA24 15-8XH31-2BB4	1.110			
16	4.7	7.5	10.3	9.2	24 DC	3RA24 16-8XH31-1BB4	1.050	3RA24 16-8XH31-2BB4	1.110			
25	5.5	11	11	11	24 DC	3RA24 17-8XH31-1BB4	1.050	3RA24 17-8XH31-2BB4	1.110			

The wye-delta starters listed here are assembled from individual contactors which are UL Listed. The overall assembly Catalog Number is not UL Listed.

¹⁾ Coil operating range at 50 Hz: 0.8 ... 1.1 x U_s ; at 60 Hz: 0.85 ... 1.1 x U_s .

For other voltages see page 2/49.

3RA24 Contactor Assemblies for Wye-Delta Starting

3RA24 complete units, 5.5 ... 22 kW

Fully wired and tested contactor assemblies · Size S0-S0-S0 · Up to 22 kW

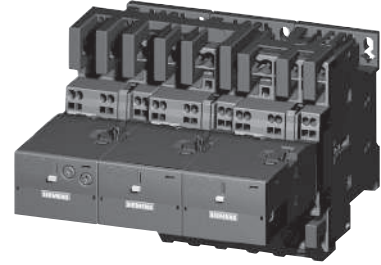
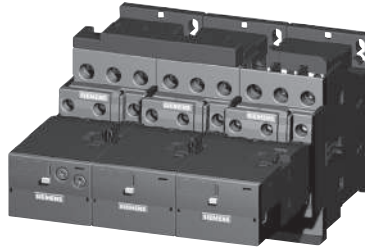

3RA24 2.-8XE32-1BB4

3RA24 2.-8XF32-1A.2

3RA24 2.-8XF32-2A.2

CONTACTORS AND ASSEMBLIES 2

Rated data AC-3						Rated control supply voltage U_s ¹⁾ at 50/60 Hz	Screw terminals		Weight approx.	Spring-type terminals		Weight approx.
Operational current I_e up to	Ratings of induction motors at 50 Hz and				Order No.		Order No.					
400 V	230 V	400 V	500 V	690 V								
A	kW	kW	kW	kW	V			kg			kg	
AC operation, 50/60 Hz												
25	7.1	11	15.6	19	24 AC 110/220 AC 220/240 AC	3RA24 23-8XF32-1AC2 3RA24 23-8XF32-1AK6 3RA24 23-8XF32-1AP6		1.370 1.370 1.370		3RA24 23-8XF32-2AC2 3RA24 23-8XF32-2AK6 3RA24 23-8XF32-2AP6	1.530 1.530 1.530	
32 / 40	11.4	15 / 18.5	19	19	24 AC 110/220 AC 220/240 AC	3RA24 25-8XF32-1AC2 3RA24 25-8XF32-1AK6 3RA24 25-8XF32-1AP6		1.370 1.370 1.370		3RA24 25-8XF32-2AC2 3RA24 25-8XF32-2AK6 3RA24 25-8XF32-2AP6	1.530 1.530 1.530	
50	--	22	19	19	24 AC 110/220 AC 220/240 AC	3RA24 26-8XF32-1AC2 3RA24 26-8XF32-1AK6 3RA24 26-8XF32-1AP6		1.390 1.390 1.390		3RA24 26-8XF32-2AC2 3RA24 26-8XF32-2AK6 3RA24 26-8XF32-2AP6	1.550 1.550 1.550	
DC operation												
25	7.1	11	15.6	19	24 DC	3RA24 23-8XF32-1BB4		1.940		3RA24 23-8XF32-2BB4	2.100	
32 / 40	11.4	15 / 18.5	19	19	24 DC	3RA24 25-8XF32-1BB4		1.940		3RA24 25-8XF32-2BB4	2.100	
50	--	22	19	19	24 DC	3RA24 26-8XF32-1BB4		1.960		3RA24 26-8XF32-2BB4	2.120	
For IO-Link connection												
25	7.1	11	15.6	19	24 DC	3RA24 23-8XE32-1BB4		1.940		3RA24 23-8XE32-2BB4	2.100	
32 / 40	11.4	15 / 18.5	19	19	24 DC	3RA24 25-8XE32-1BB4		1.940		3RA24 25-8XE32-2BB4	2.100	
50	--	22	19	19	24 DC	3RA24 26-8XE32-1BB4		1.960		3RA24 26-8XE32-2BB4	2.120	
For AS-Interface connection												
25	7.1	11	15.6	19	24 DC	3RA24 23-8XH32-1BB4		1.960		3RA24 23-8XH32-2BB4	2.120	
32 / 40	11.4	15 / 18.5	19	19	24 DC	3RA24 25-8XH32-1BB4		1.960		3RA24 25-8XH32-2BB4	2.120	
50	--	22	19	19	24 DC	3RA24 26-8XH32-1BB4		1.980		3RA24 26-8XH32-2BB4	2.140	

The wye-delta starters listed here are assembled from individual contactors which are UL Listed. The overall assembly Catalog Number is not UL Listed.

¹⁾ Coil operating range at 50 Hz: 0.8 ... 1.1 x U_s ; at 60 Hz: 0.85 ... 1.1 x U_s .

For other voltages see page 2/49 .

Rated control supply voltages

Selection and ordering data

Contactors type	3RT201	3RT231	3RT202	3RT232	3RT2617	3RT203	3RT233	3RT104
Rated control supply voltage U_s	3RA211	3RT251	3RA212	3RT252	3RT2627 3RT2637	3RA213	3RT253	3RT134 3RT144 3RA114
	S00	S00	S0	S0	S00-S2	S2	S2	S3

Rated control supply voltages (changes to 10th and 11th positions of the Order No.)

AC Operation¹⁾

Coils for 50 Hz	24 V AC	B0	B0	B0	B0	B0	B0	B0	B0
(exception: size S00: 50 and 60 Hz ²⁾)	42 V AC	D0	D0	D0	--	--	D0	--	D0
	48 V AC	H0	H0	H0	--	--	H0	--	H0
	110 V AC	F0	F0	F0	F0	F0	F0	F0	F0
	230 V AC	P0	P0	P0	P0	P0	P0	P0	P0
	400 V AC	V0	V0	V0	V0	V0	V0	V0	V0
Coils for 50 and 60 Hz²⁾	24 V AC	B0	B0	C2	C2	C2	C2	C2	C2
	42 V AC	D0	D0	D2	D2	--	D2	D2	D2
	48 V AC	H0	H0	H2	H2	--	H2	H2	H2
	110 V AC	F0	F0	G2	G2	G2	G2	G2	G2
	208 V AC	M2	M2	M2	M2	M2	M2	M2	M2
	220 V AC	N2	N2	N2	N2	N2	N2	N2	N2
	230 V AC	P0	P0	L2	L2	L2	L2	L2	L2
	240 V AC	P2	P2	P2	P2	P2	P2	P2	P2
For USA and Canada³⁾	50 Hz:	60 Hz:							
	110 V AC	120 V AC	K6	K6	K6	K6	K6	K6	K6
	220 V AC	240 V AC	P6	P6	P6	P6	P6	P6	P6
		277 V AC	--	--	--	U6	--	U6	U6
		480 V AC	V6	--	V6	--	V6	V6	V6
		600 V AC	--	--	--	T6	--	T6	T6
For Japan	50/60 Hz ⁴⁾ :	60 Hz ⁵⁾ :							
	100 V AC	110 V AC	G6	G6	G6	G6	G6	G6	G6
	200 V AC	220 V AC	N6	N6	N6	N6	N6	N6	N6
	400 V AC	440 V AC	R6	R6	R6	R6	R6	R6	R6

DC Operation¹⁾

12 V DC	A4	A4	--	--	--	--	--	--
24 V DC	B4	B4	B4	B4	--	--	--	--
42 V DC	D4	D4	D4	D4	--	--	--	--
48 V DC	W4	W4	W4	W4	--	--	--	--
60 V DC	E4	E4	E4	E4	--	--	--	--
72 V DC	J8	J8	J8	J8	--	--	--	--
80 V DC	--	--	--	--	--	--	--	--
110 V DC	F4	F4	F4	F4	--	--	--	--
125 V DC	G4	G4	G4	G4	--	--	--	--
220 V DC	M4	M4	M4	M4	--	--	--	--
230 V DC	P4	P4	P4	--	--	--	--	--

Coil codes for frame sizes S6-S12 can be found on page 2/9. Further voltages on request

Rated control supply voltage	Contactors type	--	3RT2. 2.-N	Rated control supply voltage	Contactors type	3RT2. 3.-N	3RT2. 2.-N
$U_{s \min} \dots U_{s \max}^{6)}$	Size	S00	S0	$U_{s \min} \dots U_{s \max}^{6)}$	Size	S2	S3

Sizes S00 to S3

AC/DC operation (50/60 Hz AC, DC)

21 ... 28 V AC/DC	--	B3	20 ... 33 V AC/DC	B3	B3
95 ... 130 V AC/DC	--	F3	83 ... 155 V AC/DC	F3	F3
200 ... 280 V AC/DC ⁷⁾	--	P3	175 ... 280 V AC/DC	P3	P3

¹⁾ For deviating coil voltages and coil operating ranges of sizes S00 and S0, the SITOP power 24 V DC power supply unit with wide range input (93 to 264 V AC; 30 to 264 V DC) can be used for coil excitation (For more SITOP information see section 15).

²⁾ Coil operating range
at 50 Hz: 0.8 ... 1.1 x U_s
at 60 Hz: 0.85 ... 1.1 x U_s

³⁾ Coil operating range
Size S00: at 50 Hz: 0.85 ... 1.1 x U_s
at 60 Hz: 0.8 ... 1.1 x U_s
Size S0 to S3: at 50 Hz and 60 Hz: 0.8 ... 1.1 x U_s

⁴⁾ Coil operating range
Size S00: at 50/60 Hz: 0.85 ... 1.1 x U_s
Size S0: at 50 Hz: 0.8 ... 1.1 x U_s
at 60 Hz: 0.85 ... 1.1 x U_s

⁵⁾ Coil operating range
at 60 Hz: 0.8 ... 1.1 x U_s

⁶⁾ Coil operating range for S0: 0.7 x $U_{s \min} \dots 1.3 \times U_{s \max}$
Coil operating range for S2: 0.8 x $U_{s \min} \dots 1.1 \times U_{s \max}$

⁷⁾ The following applies to S0 and $U_{s \max} = 280$ V: Upper limit = 1.1 x $U_{s \max}$

Control Relays, Coupling Relays

3RH21 control relays, 4-pole

Selection and ordering data AC and DC operation

CONTACTORS AND ASSEMBLIES 2

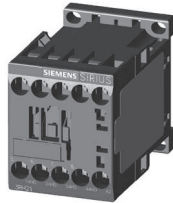

3RH11...-1...

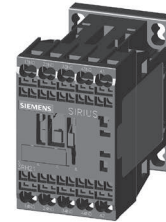

3RH11...-2...

Size S00 – Terminal designations according to EN 50011

Rated current at 240 V NEMA A600/Q600 Amps	Auxiliary contacts		Rated control supply voltage U_s V AC 50/60 Hz ³⁾	AC Operation Screw Terminals ^{1) 2)} Order No.	Rated control supply voltage U_s V DC	DC Operation Screw Terminals ^{1) 2)} Order No.
	Ident- ification No.	Version				
		NO NC				

For screw and snap-on mounting onto TH 35 standard mounting rail

	10	40E	4	—	24 110/120 220/240	3RH2140-1AB00 3RH2140-1AK60 3RH2140-1AP60	24 110 220	3RH2140-1BB40 3RH2140-1BF40 3RH2140-1BM40
	10	31E	3	1	24 110/120 220/240	3RH2131-1AB00 3RH2131-1AK60 3RH2131-1AP60	24 110 220	3RH2131-1BB40 3RH2131-1BF40 3RH2131-1BM40
	10	22E	2	2	24 110/120 220/240	3RH2122-1AB00 3RH2122-1AK60 3RH2122-1AP60	24 110 220	3RH2122-1BB40 3RH2122-1BF40 3RH2122-1BM40

Notes:

- For further voltages, see page 2/49.
- For accessories, see pages 2/66-2/77.
- For technical data, see pages 2/188-2/191.
- For overview, see page 2/116.
- For position terminals, see page 2/205-2/206.
- For dimension drawings, see page 2/124.

- 1) The 3RH21 contactor relays are also available with spring-type terminals. Replace the 8th digit of the order number with a "2" e.g. "3RH2140-2AB00"
- 2) The 3RH21 contactor relays are also available with ring lug terminals. Replace the 8th digit of the order number with a "4" e.g. "3RH2140-4AB00"
- 3) AC coil operating range at 50 Hz: 0.8 to 1.1 x U_s at 60 Hz: 0.85 to 1.1 x U_s
- 4) For AC-15/AC-14 the following applies: $I_e = 6A$ for mounted auxiliary contacts.

Control Relays, Coupling Relays

3RH24 latched control relays, 4-pole

Overview

The contactor coil and the coil of the release solenoid are both designed for uninterrupted duty.

The number of auxiliary contacts can be extended by means of front auxiliary switch blocks (up to 4 poles).

RC elements, varistors diodes or diode assemblies can be fitted to both coils from the front for damping opening surges in the coil.

Selection and ordering data

Size S00 – Terminal designations according to EN 5001

Rated current at 240 V AC-14, AC-15 NEMA A600/Q600 Amps	Aux. contacts		Rated control supply voltage U_s V AC	AC Operation Screw Terminals ¹⁾ Order No.	Rated control supply voltage U_s V DC	DC Operation Screw Terminals Order No.			
	Ident. No.	Version							
		NO NC							
For screw and snap-on mounting onto TH 35 standard mounting rail									
 3RH2422-1BB40	 E1(+), A1(+), 13, 23, 33, 43 E2(-), A2(-), 14, 24, 34, 44	10	40E	4	—	24, 50/60 Hz 110, 50 Hz / 120, 60 Hz 220, 50 Hz / 240, 60 Hz 230, 50/60 Hz	3RH2440-1AB00 3RH2440-1AK60 3RH2440-1AP60 3RH2440-1AP00	24 110 125 220	3RH2440-1BB40 3RH2440-1BF40 3RH2440-1BG40 3RH2440-1BM40
	 E1(+), A1(+), 13, 21, 33, 43 E2(-), A2(-), 14, 22, 34, 44	10	31E	3	1	24, 50/60 Hz 110, 50 Hz / 120, 60 Hz 220, 50 Hz / 240, 60 Hz 230, 50/60 Hz	3RH2431-1AB00 3RH2431-1AK60 3RH2431-1AP60 3RH2431-1AP00	24 110 125 220	3RH2431-1BB40 3RH2431-1BF40 3RH2431-1BG40 3RH2431-1BM40
	 E1(+), A1(+), 13, 21, 31, 43 E2(-), A2(-), 14, 22, 32, 44	10	22E	2	2	24, 50/60 Hz 110, 50 Hz / 120, 60 Hz 220, 50 Hz / 240, 60 Hz 230, 50/60 Hz	3RH2422-1AB00 3RH2422-1AK60 3RH2422-1AP60 3RH2422-1AP00	24 110 125 220	3RH2422-1BB40 3RH2422-1BF40 3RH2422-1BG40 3RH2422-1BM40

For accessories for 3RH24, see below and page 2/66-2/77
For technical data, see page 2/188-2/191.
For overview, see page 2/116.

For position of terminals, see page 2/205-2/206.
For dimension drawings, see page 2/227.

Auxiliary switch blocks for 3RH21, 3RH24 control relays

Size S00 – For assembling to control relays to have 8 contacts

For contactor type	HS Block Ident. No.	Contacts Version		Weight approx. kg.	Screw Terminals Order No.	Spring Terminals Order No.
		NO	NC			

Auxiliary switch blocks for snapping onto the front according to EN 50011

 3RH2911-1GA40	 53 63 73 83 54 64 74 84	3RH2140, 3RH2440, Ident. No. 40 E	80E	4	—	0.050	3RH2911-1GA40	3RH2911-2GA40
	 53 61 73 83 54 62 74 84	3RH2140, 3RH2440, Ident. No. 40 E	71E	3	1	0.050	3RH2911-1GA31	3RH2911-2GA31
 3RH2911-2GA40	 53 61 71 83 54 62 72 84	3RH2140, 3RH2440, Ident. No. 40 E	62E	2	2	0.050	3RH2911-1GA22	3RH2911-2GA22
	 53 61 71 81 54 62 72 82	3RH2140, 3RH2440, Ident. No. 40 E	53E	1	3	0.050	3RH2911-1GA13	3RH2911-2GA13
	 51 61 71 81 52 62 72 82	3RH2140, 3RH2440, Ident. No. 40 E	44E	—	4	0.050	3RH2911-1GA04	3RH2911-2GA04

1) Coil voltage tolerance
at 50 Hz: 0.8 to 1.1 x U_s
at 60 Hz: 0.85 to 1.1 x U_s

For further accessories see pages 2/66-2/77

Coupling Relays

3RH21 coupling relays for switching auxiliary circuits, 4 pole

Application

DC operation

IEC 60 947 and EN 60 947

The 3RH21 coupling relays for switching auxiliary circuits are tailored to the special requirements of working with electronic controls.

The 3RH21 coupling relays cannot be extended with auxiliary switch blocks.

Coupling relays have a low power consumption, an extended coil voltage tolerance and an integrated surge suppressor for damping opening surges on select versions

Selection and ordering data

DC operation

Size S00 – Terminal designations according to EN 50 011

Surge suppressor	Rated current	Auxiliary contacts		Screw Terminals ¹⁾ Order No.	Spring Terminals ¹⁾ Order No.	Weight approx. kg.
	at 240 V NEMA A600/Q600	Ident- ification No.	Version			
	Amps		NO NC			

For screw and snap-on mounting onto TH 35 standard mounting rail

Rated control supply voltage $U_s = 24\text{ V DC}$, coil voltage tolerance **0.7 to 1.25 x U_s**
Power consumption of the coils **2.8 W** at 24 V (no auxiliary switch blocks can be mounted)

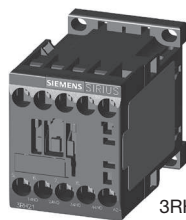

3RH2140-1HB40

Diode, varistor, or RC element can be mounted	10	40E	4	—	3RH2140-1HB40	3RH2140-2HB40	0.300
	10	31E	3	1	3RH2131-1HB40	3RH2131-2HB40	0.300
	10	22E	2	2	3RH2122-1HB40	3RH2122-2HB40	0.300
Diode integrated	10	40E	4	—	3RH2140-1JB40	3RH2140-2JB40	0.300
	10	31E	3	1	3RH2131-1JB40	3RH2131-2JB40	0.300
	10	22E	2	2	3RH2122-1JB40	3RH2122-2JB40	0.300
Suppressor diode integrated	10	40E	4	—	3RH2140-1KB40	3RH2140-2KB40	0.300
	10	31E	3	1	3RH2131-1KB40	3RH2131-2KB40	0.300
	10	22E	2	2	3RH2122-1KB40	3RH2122-2KB40	0.300

Rated control supply voltage $U_s = 24\text{ V DC}$, coil voltage tolerance **0.85 to 1.85 x U_s**
Power consumption of the coils **1.6 W** at 24 V (no auxiliary switch blocks can be mounted)



3RH2140-2SB40

Diode, varistor, or RC element can be mounted	10	40E	4	—	3RH2140-1MB40-0KTO	3RH2140-2MB40-0KTO	0.300
	10	31E	3	1	3RH2131-1MB40-0KTO	3RH2131-2MB40-0KTO	0.300
	10	22E	2	2	3RH2122-1MB40-0KTO	3RH2122-2MB40-0KTO	0.300
Diode integrated	10	40E	4	—	3RH2140-1VB40	3RH2140-2VB40	0.300
	10	31E	3	1	3RH2131-1VB40	3RH2131-2VB40	0.300
	10	22E	2	2	3RH2122-1VB40	3RH2122-2VB40	0.300
Suppressor diode integrated	10	40E	4	—	3RH2140-1SB40	3RH2140-2SB40	0.300
	10	31E	3	1	3RH2131-1SB40	3RH2131-2SB40	0.300
	10	22E	2	2	3RH2122-1SB40	3RH2122-2SB40	0.300

For technical data, see 2/192.

For position of terminals, see 2/205-2/206.

For dimension drawings, see 2/227.

1) Ring lug terminals are also available.

Replace the 8th digit of the order number with a "4", e.g. 3RH2140-4HB40

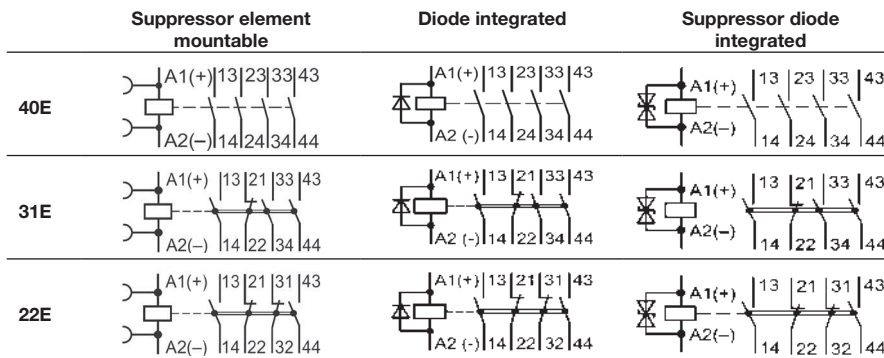

Contactors for Switching Motors

3TF68 and 3TF69 vacuum contactors, 3-pole

Selection and ordering data

Maximum inductive current AC-3	Maximum power ratings					Max. resistive current AC-1	Auxiliary contacts		Rated control supply voltage ¹⁾	Order No.	Weight approx. kg
	UL Ratings		IEC ratings		NO		NC				
	200 V	230 V	460 V	575 V	1000 V			V			
A	HP	HP	HP	HP	kW	A					
AC operation ^{2) 3)}											
Size 14											
Auxiliary and control conductors: screw terminals											
Main conductor: bar connections											
• AC Operation											
630	200	250	500	600	600	700	4	4	110-132, 50/60 Hz	3TF6844-■CF7	15
630	200	250	500	600	600	700	4	4	200-240, 50/60 Hz	3TF6844-■CM7	15
820	290	350	700	860	800	910	4	4	110-132, 50/60 Hz	3TF6944-■CF7	19
820	290	350	700	860	800	910	4	4	200-240, 50/60 Hz	3TF6944-■CM7	19
UL ratings shown in above table:										■=0	
For IEC use only up to 1000 V:										■=8	
• DC Operation											
630	200	250	500	600	600	700	3	3	24 V DC	3TF6833-■DB4	16.9
820	290	350	700	860	800	910	3	3	24 V DC	3TF6933-■DB4	20.9
UL ratings shown in above table:										■=1	
For IEC use only up to 1000 V:										■=8	

3TF68



Accessories and Spare parts for 3TF68 and 3TF69 vacuum contactors

Selection and ordering data

Details	For contactor type	Order No.	Weight approx. kg
Coils			
<p>3TY7</p>	AC Operation		
	The coils are fitted with varistors for damping surges as standard; the coil is supplied with the closing electronics included.		
	3TF68	3TY7683-0C●●	0.65
	3TF69	3TY7693-0C●●	
DC Operation			
Reversing contactors are required for size 14 contactors:			
Contactor type	Reversing contactor type		
3TF68 and 3TF69:	3TC44 (70 mm wide, 85 mm high)		
The coils are supplied without a reversing contactor.			
●● For rated control supply voltages, see page 2/102.			
Vacuum interrupters			
In order to ensure reliable operation of the contactors, only Siemens original replacement interrupters should be used.			
3 vacuum interrupters with mounting parts per set.			
	3TF68	3TY7680-0B	3.2
	3TF69	3TY7690-0B	3.5
Auxiliary switch blocks with screw terminals			
1 NO and 1 NC	First auxiliary switch block, left or right. Replacement type for: 3TY7561-1A, -1B	3TF68 / 3TF69	3TY7561-1AA00 0.042
1 NO and 1 NC	First auxiliary switch block, left or right late break	3TF68 / 3TF69	3TY7561-1EA00 0.042
1 NO and 1 NC	Second auxiliary switch block, left or right. Replacement type for: 3TY7 561-1K, -1L	3TF68 / 3TF69	3TY7561-1KA00 0.042
Auxiliary switches for coil reconnection, for DC economy circuit with screw connections			
1 NC	Auxiliary switch block late break	3TF68 / 3TF69	3TY7681-1G 0.042
Solid-state compatible auxiliary switch block with screw terminals			
For mounting onto the side of contactors. For use in dusty atmosphere and electronic circuits with rated operational currents			
I_e AC-14 and DC-13 from 1 mA to 300 mA at 3 V to 60 V.		3TF68 / 3TF69	3TY7561-1UA00 0.042





For accessories, see page 2/53-2/54.
 For technical data, see page 2/175-2/180.
 For description, see page 2/117.
 For internal circuit diagrams, see page 2/214.
 For position of terminals, see page 2/211
 For dimension drawings, see page 2/224.

1) For further voltages, see page 2/102.
 2) Surge suppression integrated: fitted with varistor.
 3) For EMC, see description on page 2/117.
 3TF68/69 vacuum contactors are supplied with integrated surge suppression for the main conducting paths (for description, see page 2/117). In operation in circuits with DC choppers, frequency converters, variable-speed drives, for example, this protective circuitry is not required. It might be damaged by voltage peaks and harmonics generated, possibly followed by phase-to-phase shortcircuits. For this reason, the contactors can be supplied without overvoltage damping. To order these versions add a "-Z" and the order code "A02".

Contactors for Switching Motors

Accessories and Spare parts for 3TF68 and 3TF69 vacuum contactors

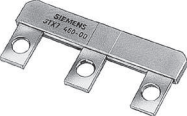
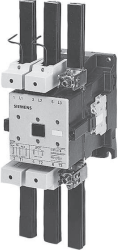
Selection and ordering data

For contactor		Design	Order No.	Weight approx. kg	Std. Pack Qty	
Size	Type					
Interface for control by PLC						
	3TX7 090-0D	Coil voltage tolerance: DC 17 V to 30 V Power consumption: 0.5 W at DC 24 V Fitted with varistor For technical data, see Part 7.				
	14	3TF68 and 3TF69	For snapping onto the side of auxiliary switch blocks, with surge suppression	3TX7 090-0D	0.1	1
Terminal covers						
	3TX7 686-0A	for protection against inadvertent contact with the exposed busbar connections (DIN VDE 0106 Part 100)*	(Order No. and price per set) 3TX7 686-0A 3TX7 696-0A	0.17	1 set = 2 units	
	14	3TF68 3TF69				
Link for paralleling (star jumper) · 3-pole, without terminal ¹⁾						
	3TX7 680-0D		3TX7 680-0D	0.26	1	
	14	3TF68				
	14	3TF68	• Cover plate for paralleling link A cover plate must be used in order to protect against inadvertent contact (DIN VDE 0106 Part 100).	3TX7 680-0E	0.18	1
Box terminals for laminated copper bars						
	3TX7570-1E					
	14	3TF68	• Without auxiliary conductor terminal With single covers for protection against inadvertent contact (EN 50274)	3TX7 570-1E	0.6	1
	14	3TF69	• With auxiliary conductor terminal Conductor cross-sections for auxiliary conductors: Solid: 2 × (0.75 ... 2.5) mm ² Finely stranded with end sleeve: 2 × (0.5 ... 2.5) mm ² Solid or stranded: 2 × (18 ... 12) AWG Tightening torque: 0.8 Nm ... 1.4 Nm (7 ... 12 lb.in)	3TX7 690-1F	2.0	1
Surge suppressors — Varistors						
	3TX7 572-3G	For DC economy circuit; for lateral snapping onto auxiliary switches	<i>Rated control supply voltage, V_{DC}</i> 24 ... 48 48 ... 127 127 ... 240	3TX7 572-3G 3TX7 572-3H 3TX7 572-3J	0.09 0.09 0.09	1 1 1
	14	3TF68 and 3TF69	The varistor is included in the scope of supply of the 3TF68 and 3TF69 contactors with AC operation. Includes the peak value of the alternating voltage on the DC side.			

1) The link for paralleling can be reduced by one pole.

Contactors and Replacement Parts

General Purpose - Type 3TC

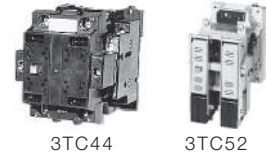

Ordering information

- Select Contactor from table below.
- Complete catalog number replace the two daggers (††) with appropriate coil voltage suffix. See corresponding coil voltage suffix table below.
- Technical Data [see page 2/181-2/184](#).
- Dimensions [see page 2/224](#).



2 CONTACTORS AND ASSEMBLIES

Frame Size	Ampere Rating		2 Pole DC HP Ratings (DC-3, DC-5)				Auxiliary contacts		AC-Operated	DC-Operated
	Open	Enclosed	115 V	230 V	500 V	575 V	NO	NC	Order No.	Order No.
3TC DC Contactors										
2	40	40	5	10	15	15	2	2	3TC4417-0B††	3TC4417-0A††
4	75	68	8	18	40	45	2	2	3TC4817-0B††	3TC4817-0A††
8	220	200	25	50	100	100	2	2	3TC5217-0B††	3TC5217-0A††
12	330	300	40	75	150	150	2	2	3TC5617-0B††	3TC5617-0A††

Device	Frame Size	Catalog Number						
Coils, AC		24V AC	120V AC	220/240V AC	277V AC	480V AC	600V AC	
	3TC	3TY7403-0AC2	3TY7403-0AK6	3TY7403-0AP6	3TY7403-0AU1	3TY7403-0AV0	3TY7403-0AS0	
		3TY6483-0AC1	3TY6483-0AK6	3TY6483-0AP6	3TY6483-0AP0	3TY6483-0AV0	3TY6483-0AS0	
			3TY6523-0AK6	3TY6523-0AP6	3TY6523-0AP0	3TY6523-0AV0		
			3TY6566-0AK6		3TY6566-0AP0	3TY6566-0AV0	3TY6566-0AS0	
Coils, DC		24V DC	48V DC	110V DC	125V DC	230V DC		
	3TC	3TY6443-0BB4		3TY6443-0BF4	3TY6443-0BG4			
		3TY6483-0BB4	3TY6483-0BW4	3TY6483-0BF4	3TY6483-0BG4			
		3TY6523-0BB4		3TY6523-0BF4	3TY6523-0BG4	3TY6523-0BP4		
		3TY6563-0BB4		3TY6563-0BF4	3TY6563-0BG4	3TY6563-0BP4		



Frame size	Contact type	Mounting position	Solid state	Order No.	
Auxiliary Contact Blocks with 1 NO + 1 NC contacts ²⁾					
	2, 4	3TC44 or 3TC48	1st block, left or right	—	3TY6501-1AA00
			2nd block, left or right	Yes ³⁾	3TY7561-1UA00
	4	3TC48	2nd block, left ⁵⁾	—	3TY6501-1K
			2nd block, right ⁵⁾	—	3TY6501-1L
	8, 12	3TC52 or 3TC56	1st block, left	—	3TY6561-1A
			1st block, right	—	3TY6561-1B
		2nd block, left ⁵⁾	—	3TY6561-1K	
		2nd block, right ⁵⁾	—	3TY6561-1L	

Coil Suffix Table ††

Replace †† in the contactor Order No. with a coil code from the table below.

V AC 50/60 Hz	Code	V DC	Code
24	C1	24	B4
120	K1*	36	V4
240	P1	48	W4
460	V0	60	E4
600	S0	72	J8
		110	F4
		125	G4
		220	M4
		230	P4

*Use suffix K2 for 3TC44.

Device Type	Frame Size	Catalog Number
Main Contacts ¹⁾		
	3TC44	3TY2440-0A
	3TC48	3TY2480-0A
	3TC52	3TY2520-0A
	3TC56	3TY2560-0A
Arc Chutes		
	3TC44	3TY2442-0A
	3TC48	3TY2482-0A
	3TC52	3TY2522-0A
	3TC56	3TY2562-0A

1) Main contact kits for size 3TC48 and larger include springs. Smaller sizes do not.

2) On DC operated contactors the maximum number of auxiliary contacts is 2 NO, 2 NC.

3) For use in dusty atmosphere and electronic circuits with rated operational currents I_b AC-14 and DC-13 from 1 mA to 300 mA at 3V to 60V. With 1 changeover contact.

4) Discount Code: DC Contactors

5) Can only be mounted on AC-operated contactors.

DC Contactor Replacement Parts

General Purpose - Type 3TC

Surge suppressors · Varistors



3TX7 402-3.



3TX7 462-3.



3TX7 522-3.

For contactors		Version	Rated control supply voltage U_s		Order No.	Std. Pack Qty	
Size	Type		V AC	V DC			
2	3TC44 ¹⁾	Varistors²⁾ with line spacer, for mounting onto the coil terminal	24 ... 48	24 ... 70	3TX7 402-3G	1	
			48 ... 127	70 ... 150			3TX7 402-3H
			127 ... 240	150 ... 250			3TX7 402-3J
			240 ... 400				3TX7 402-3K
			400 ... 600				3TX7 402-3L
4	3TC48	Varistors²⁾ for sticking onto the contactor base or for mounting separately	24 ... 48	24 ... 70	3TX7 462-3G	1	
			48 ... 127	70 ... 150			3TX7 462-3H
			127 ... 240	150 ... 250			3TX7 462-3J
			240 ... 400				3TX7 462-3K
400 ... 600		3TX7 462-3L					
8 and 12	3TC52, 3TC56	Varistor for sticking onto the contactor base or for mounting separately	24 ... 48	24 ... 70	3TX7 462-3G	1	
			48 ... 127	70 ... 150			3TX7 462-3H
			127 ... 240	150 ... 250			3TX7 462-3J
			240 ... 400				3TX7 462-3K
400 ... 600		3TX7 462-3L					
8 and 12	3TC52, 3TC56	Varistors²⁾ for separate screw connection or snapping onto TH 35 standard mounting rail	24 ... 48	24 ... 70	3TX7 522-3G	1	
			48 ... 127	70 ... 150			3TX7 522-3H
			127 ... 240	150 ... 250			3TX7 522-3J
240 ... 400							
400 ... 600							

Surge suppressors · RC elements

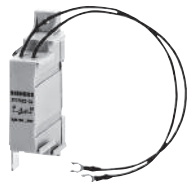

3TX7 462-3, 3TX7 522-3.

4	3TC48	RC elements For lateral snapping onto auxiliary switch or TH 35 standard mounting rail	24 ... 48	24 ... 70	3TX7 462-3R	1	
			48 ... 127	70 ... 150			3TX7 462-3S
			127 ... 240	150 ... 250			3TX7 462-3T
			240 ... 400				3TX7 462-3U
			400 ... 600				3TX7 462-3V
8 and 12	3TC52, 3TC56	RC elements For lateral snapping onto auxiliary switch or TH 35 standard mounting rail	24 ... 48	24 ... 70	3TX7 522-3R	1	
			48 ... 127	70 ... 150			3TX7 522-3S
			127 ... 240	150 ... 250			3TX7 522-3T
			240 ... 400				3TX7 522-3U
			400 ... 600				3TX7 522-3V

Surge suppressors · Diodes



3TX7 462-3.

4 to 12	3TC48, 3TC52, 3TC56	Diode assemblies³⁾ (diode and Zener diode) for DC solenoid system, for sticking onto the contactor base or for mounting separately	24 ... 250	3TX7 462-3D	1
---------	---------------------------	---	------------	--------------------	---

Terminal covers



3TX6 506-3B

6	3TC48	For protection against inadvertent contact with exposed busbar connections. Can be screwed on free screw end. Covers one busbar connection	3TX6 506-3B	1 set=6 units
10 and 14	3TC52, 3TC56		3TX6 546-3B	1 set=6 units

¹⁾ The connection piece for mounting the surge suppressor must be bent slightly.

²⁾ Includes the peak value of the alternating voltage on the DC side.

³⁾ Not for DC economy circuit.

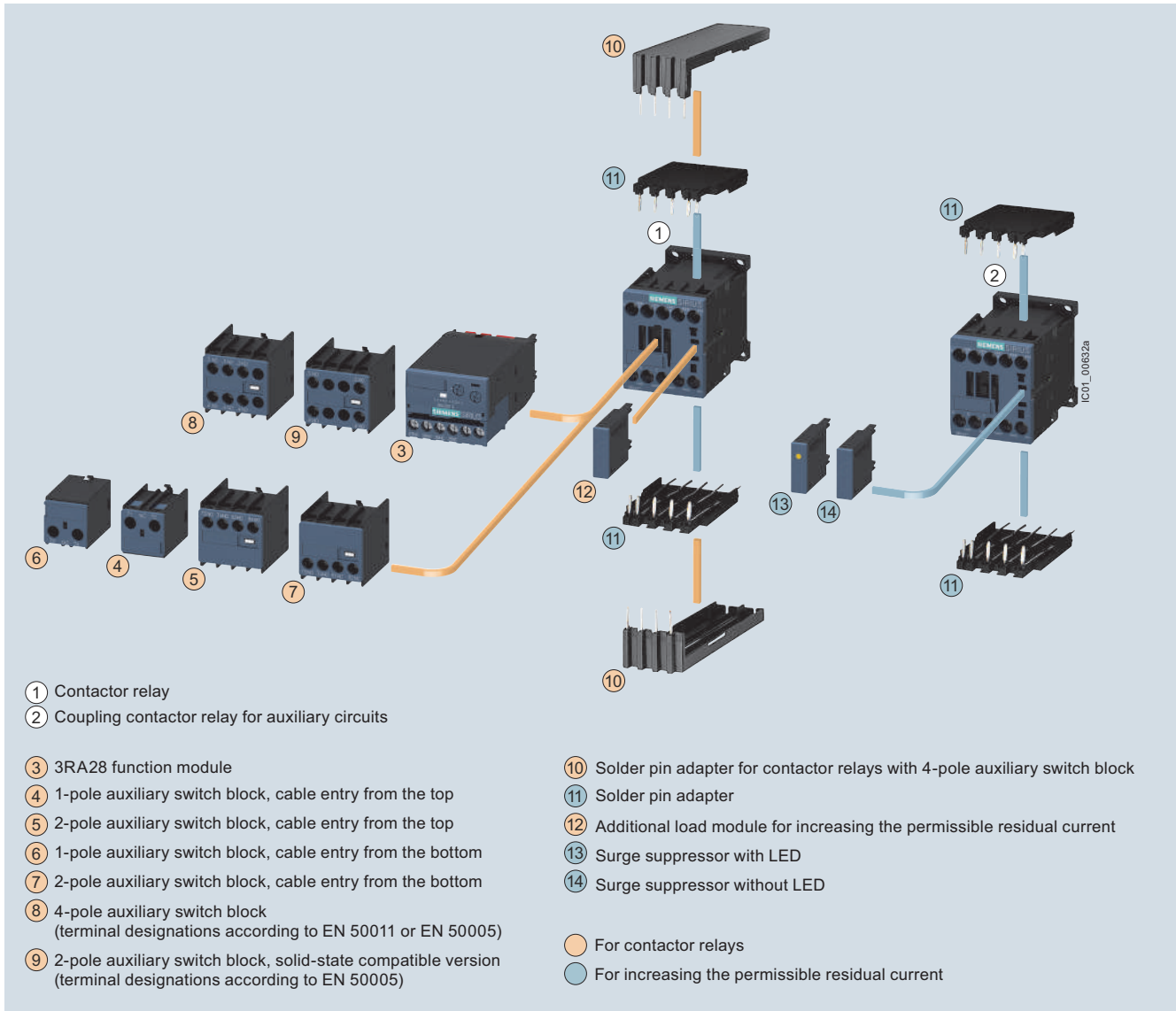

3RT2 contactors and coupling relays – Size S00 with mountable accessories

Overview

The SIRIUS family of controls

The SIRIUS modular system with its components for the switching, starting, protection and monitoring of motors and industrial systems stands for the fast, flexible and space-saving construction of control cabinets.

3RT2 contactors
Size S00 with mountable accessories

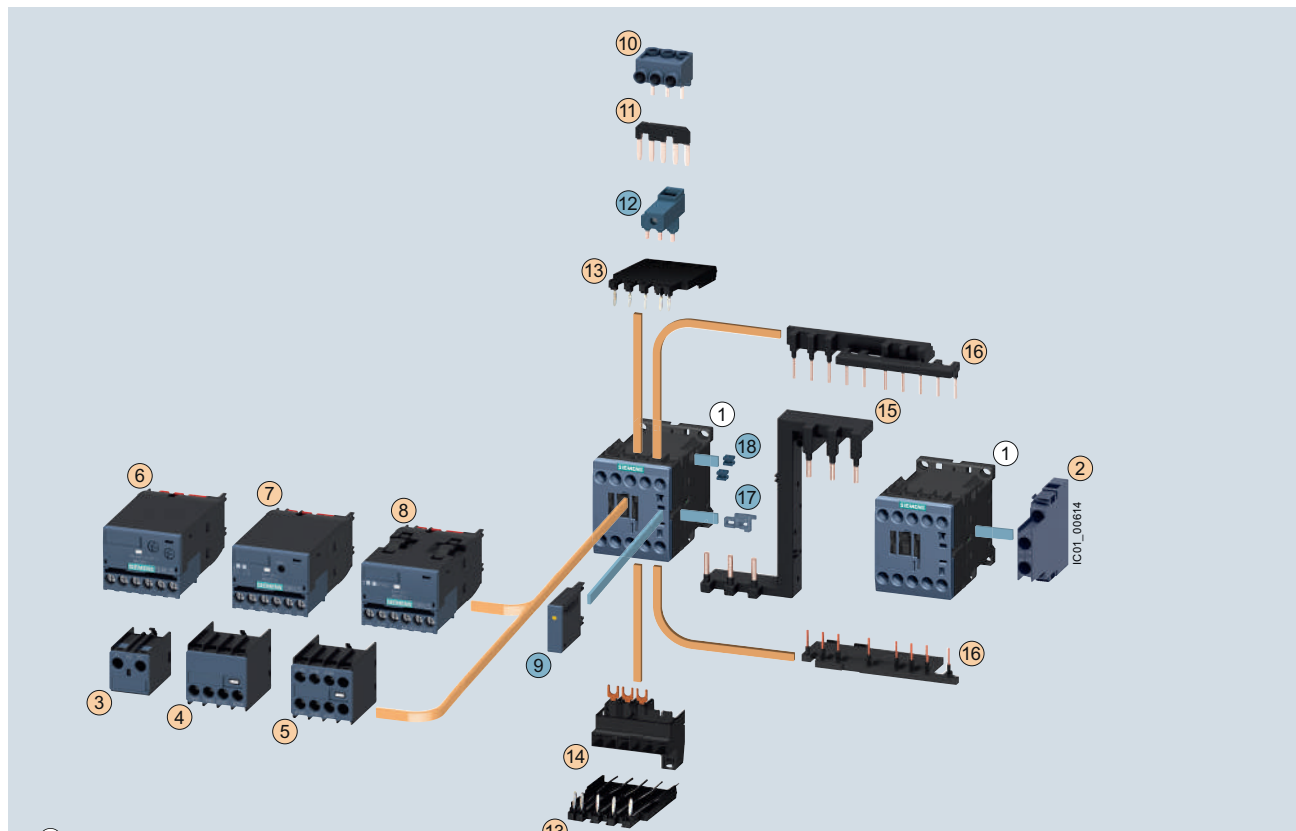

① Contactor size S00

- ② 2-pole auxiliary switch block, laterally mountable
- ③ 1-pole auxiliary switch block, for snapping onto the front cable entry from the top
- ④ 2-pole auxiliary switch block, for snapping onto the front cable entry from the bottom
- ⑤ 4-pole auxiliary switch block, for snapping onto the front
- ⑥ 3RA28 function module
- ⑦ 3RA27 function module for AS-Interface, direct starting
- ⑧ 3RA27 function module for IO-Link, direct starting
- ⑨ Surge suppressor with/without LED
- ⑩ Three-phase feeder terminal

- ⑪ Star jumper, 3-pole, without connecting terminal
- ⑫ Link for paralleling, 3-pole, with connecting terminal
- ⑬ Solder pin adapter
- ⑭ Connection module (adapter and connector) for contactors with screw-type connection
- ⑮ Safety main current connector for two contactors

Assembly kit 3RA2913-2AA1 comprising:

- ⑯ Wiring modules on the top and bottom for connecting the main, auxiliary and control current paths, electrical interlock¹⁾ included (NC contact interlock), can be broken off (NC contact interlock)
- ⑰ Mechanical interlocks²⁾
- ⑱ Two connecting clips for two contactors²⁾

- For contactors
- For contactors and coupling contactors

¹⁾ 3RT201. contactors with one NC contact in the basic unit are required for the electrical interlock. An additional NO contact is required for momentary-contact operation.

²⁾ The parts ⑰ and ⑱ can only be ordered together as 3RA2912-2H mechanical connectors.

3RT2 contactors and coupling relays – Size S0 with mountable accessories

3RT2 contactors
Size S0 with mountable accessories

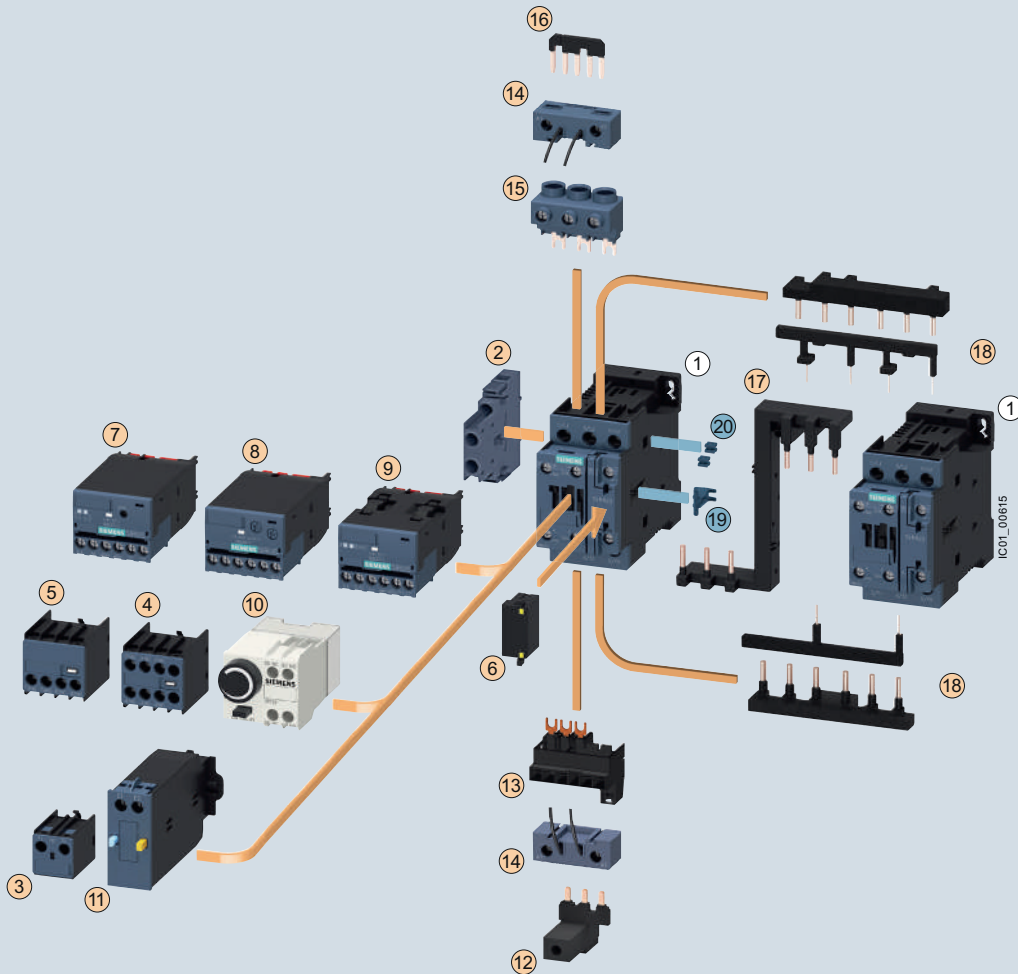

① Contactor size S0

- ② 2-pole auxiliary switch block, laterally mountable
- ③ 1-pole auxiliary switch block, for snapping onto the front cable entry from the top
- ④ 4-pole auxiliary switch block, for snapping onto the front
- ⑤ 2-pole auxiliary switch block, for snapping onto the front cable entry from the bottom
- ⑥ Surge suppressor with/without LED
- ⑦ 3RA27 function module for AS-Interface, direct starting
- ⑧ 3RA28 function module
- ⑨ 3RA27 function module for IO-Link, direct starting
- ⑩ Pneumatically delayed auxiliary switch block
- ⑪ Mechanical latching block

- ⑫ Link for paralleling, 3-pole, with connecting terminal
- ⑬ Connection module (adapter and plug) for contactors with screw-type connection
- ⑭ Coil terminal module, on the top and bottom
- ⑮ Three-phase feeder terminal
- ⑯ Link for paralleling (star jumper), 3-pole, without connecting terminal
- ⑰ Safety main current connector for two contactors

Assembly kit 3RA2923-2AA1 comprising:

- ⑱ Wiring modules on the top and bottom for connecting the main current paths, electrical interlock included (NC contact interlock)
- ⑲ Mechanical interlocks¹⁾
- ⑳ Two connecting clips for two contactors¹⁾

- For contactors
- For contactors and coupling contactors

¹⁾ The parts ⑲ and ⑳ can only be ordered together as 3RA2912-2H mechanical connectors.

3RT2 contactors – Size S2 with mountable accessories

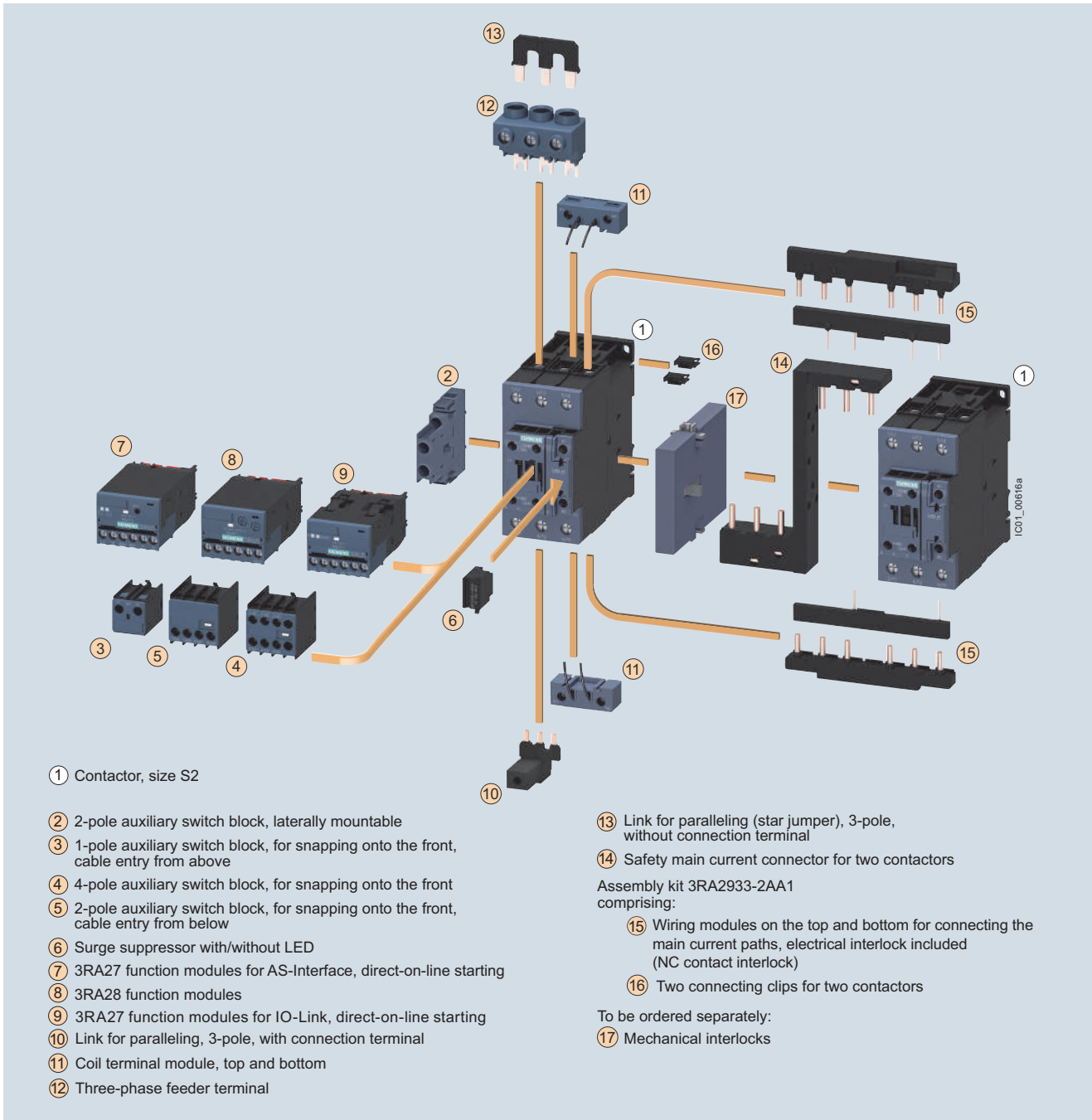

① Contactor, size S2

- ② 2-pole auxiliary switch block, laterally mountable
- ③ 1-pole auxiliary switch block, for snapping onto the front, cable entry from above
- ④ 4-pole auxiliary switch block, for snapping onto the front
- ⑤ 2-pole auxiliary switch block, for snapping onto the front, cable entry from below
- ⑥ Surge suppressor with/without LED
- ⑦ 3RA27 function modules for AS-Interface, direct-on-line starting
- ⑧ 3RA28 function modules
- ⑨ 3RA27 function modules for IO-Link, direct-on-line starting
- ⑩ Link for paralleling, 3-pole, with connection terminal
- ⑪ Coil terminal module, top and bottom
- ⑫ Three-phase feeder terminal

- ⑬ Link for paralleling (star jumper), 3-pole, without connection terminal
- ⑭ Safety main current connector for two contactors

Assembly kit 3RA2933-2AA1 comprising:

- ⑮ Wiring modules on the top and bottom for connecting the main current paths, electrical interlock included (NC contact interlock)
- ⑯ Two connecting clips for two contactors

To be ordered separately:

- ⑰ Mechanical interlocks

Accessories see pages 2/66 to 2/81.

3RT2 contactors – Size S3 with mountable accessories

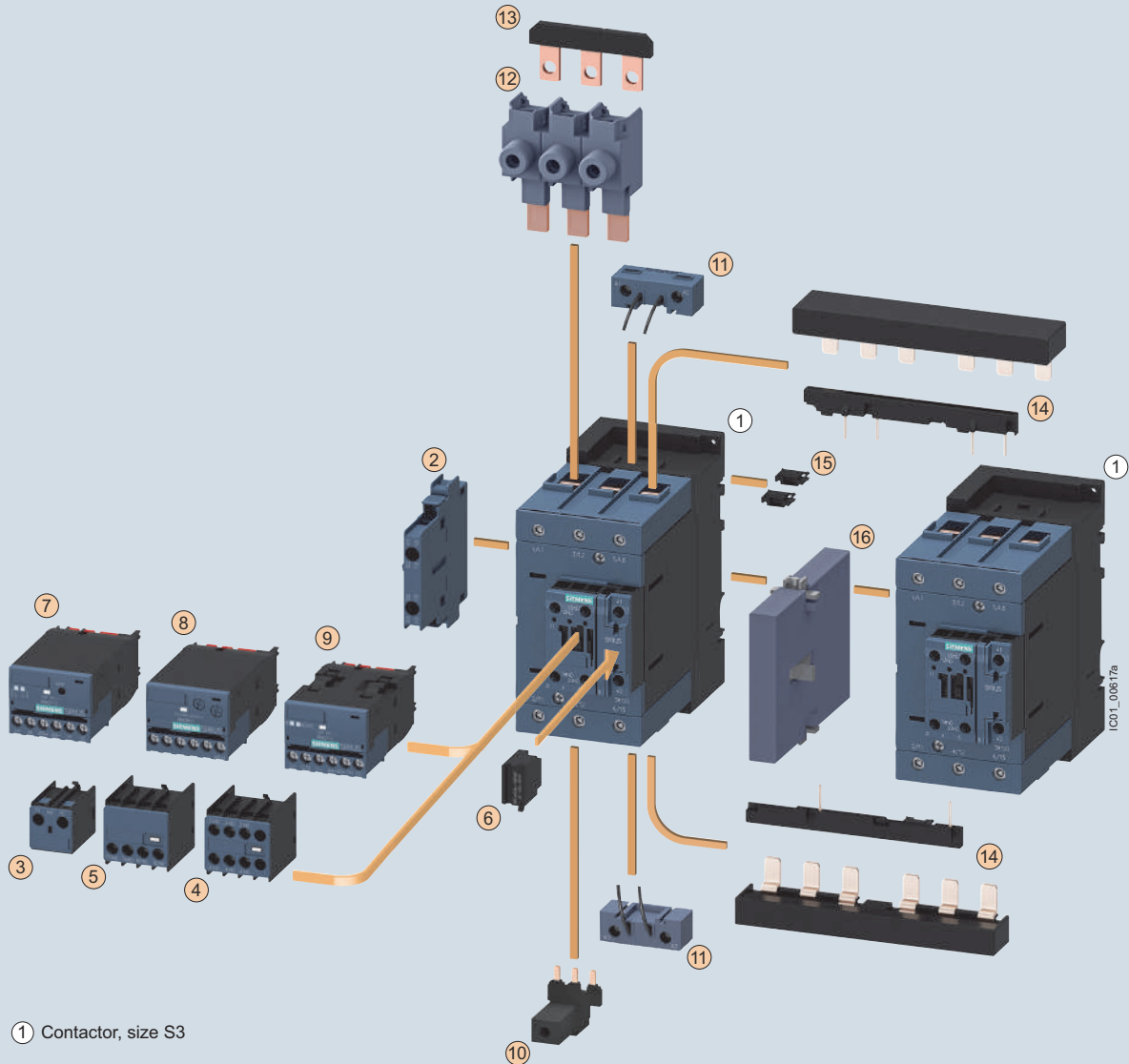

① Contactor, size S3

- ② 2-pole auxiliary switch block, laterally mountable
- ③ 1-pole auxiliary switch block, for snapping onto the front, cable entry from above
- ④ 4-pole auxiliary switch block, for snapping onto the front
- ⑤ 2-pole auxiliary switch block, for snapping onto the front, cable entry from below
- ⑥ Surge suppressor with/without LED
- ⑦ 3RA27 function modules for AS-Interface, direct-on-line starting
- ⑧ 3RA28 function modules
- ⑨ 3RA27 function modules for IO-Link, direct-on-line starting

- ⑩ Links for paralleling, 3-pole, with connection terminal
- ⑪ Coil terminal module, top and bottom
- ⑫ Single-phase infed terminals (3 units)
- ⑬ Links for paralleling (star jumper), 3-pole without connecting terminal

Assembly kit 3RA2943-2AA1 comprising:

- ⑭ Wiring modules on the top and bottom for connecting the main, auxiliary and control current paths, electrical interlock¹⁾ included, can be broken off (NC contact interlock)
- ⑮ Two connectors for two contactors

To be ordered separately:

- ⑯ Mechanical interlock

¹⁾ 3RT201. contactors with one NC contact in the basic unit are required for the electrical interlock. An additional NO contact is required for momentary-contact operation.

Accessories see pages 2/66 to 2/81.

Motor Starters see Chapter 4 Combination Starters & Starters for group installation

3RT1 contactors – Sizes S6 to S12 with mountable accessories

(illustration for basic unit)

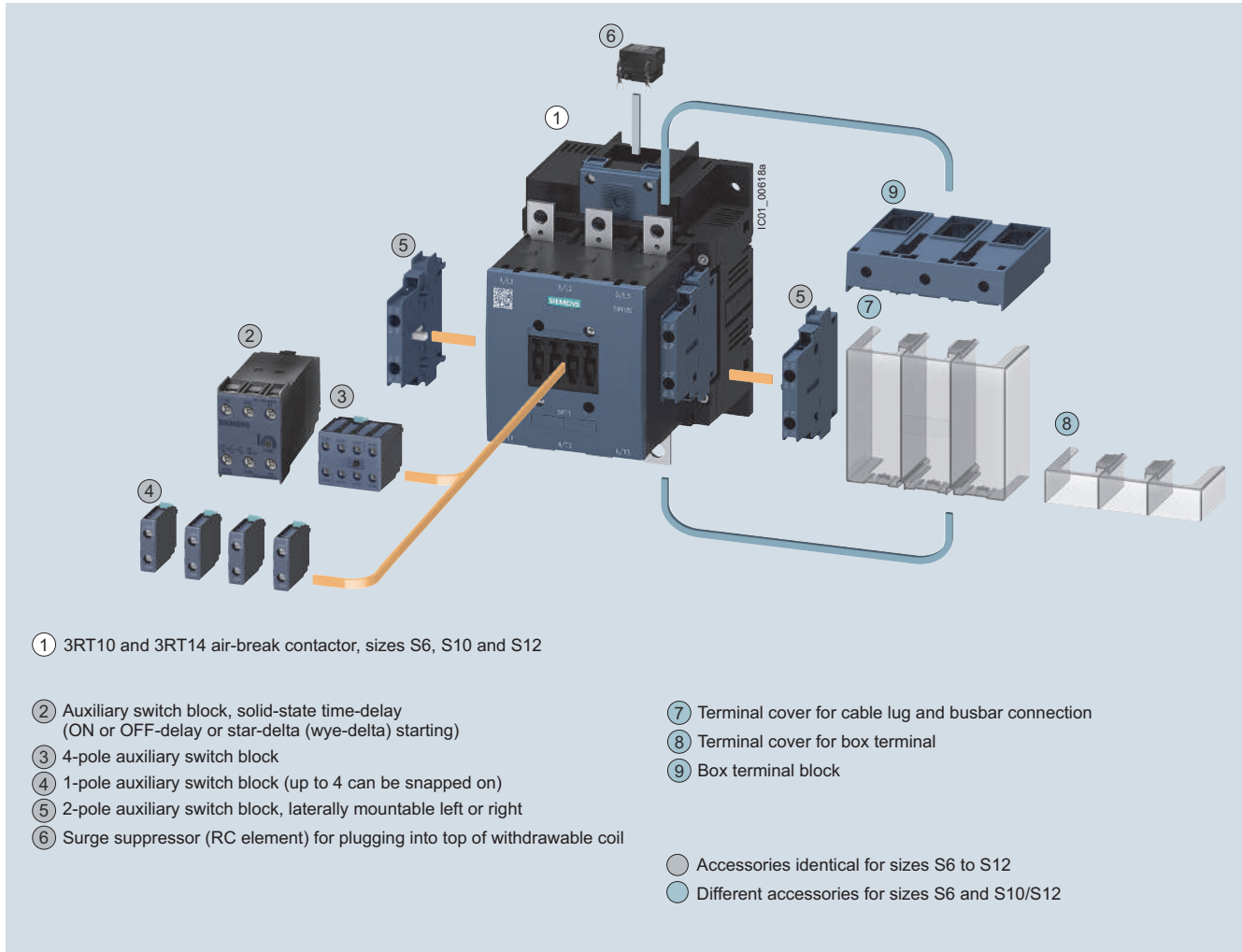

For accessories [see pages 2/66 to 2/83](#).

For mountable overload relays [see Chapter 3, "Overload Relays"](#).

3RT1 contactors – Sizes S6, S10 and S12 reversing contactors

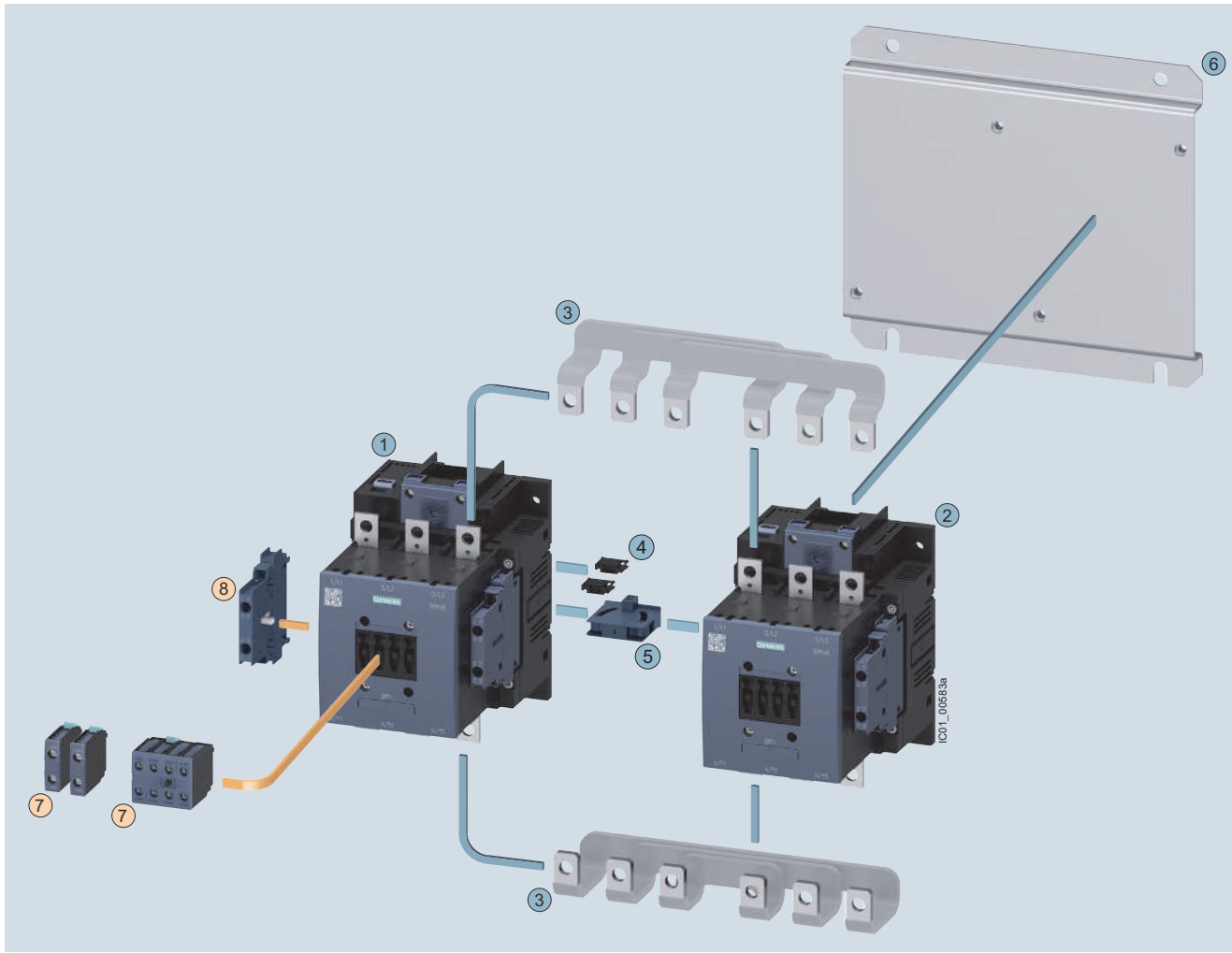

Mountable accessories (optional)

To be ordered separately	Type
⑥	Auxiliary switch block, front 3RH1921
⑦	Auxiliary switch block, lateral 3RH1921

Reversing contactor assembly for customer assembly

Individual parts	Type	
	Q11	Q12
① ②	3RT1.54	3RT1.54
① ②	3RT1.55	3RT1.55
① ②	3RT1.56	3RT1.56
③	3RA1953-2A	
Assembly kit consisting of: Wiring modules on the top and bottom for contactors without box terminals for connecting the main and auxiliary circuits, electrical interlock included (NC contact interlock)		
④	3RA1932-2D	
⑤	3RA1954-2A	
⑥	3RA1952-2A	
Base plate for reversing contactor assemblies		

For accessories see pages 2/66-2/83.

Mountable overload relays see Chapter 3, "Overload Relays".

3RT1 contactors – Sizes S6, S10 and S12 reversing contactors

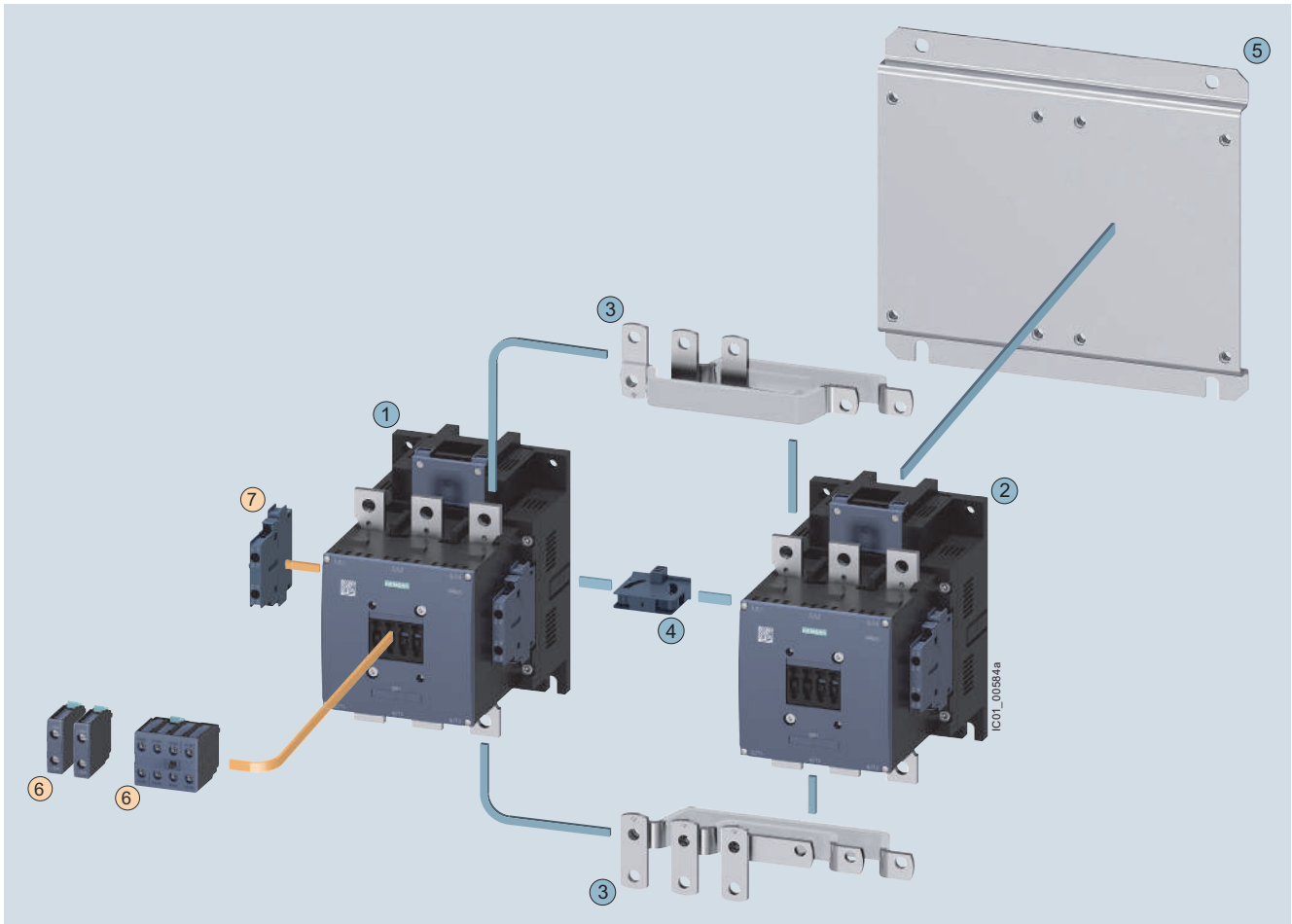

Mountable accessories (optional)

To be ordered separately	Type
⑥ Auxiliary switch block, front	3RH1921
⑦ Auxiliary switch block, lateral	3RH1921

Reversing contactor assembly for customer assembly

Individual parts	Type	
	Q11	Q12
① ② Contactors, 110 kW	3RT1.64	3RT1.64
① ② Contactors, 132 kW	3RT1.65	3RT1.65
① ② Contactors, 160 kW	3RT1.66	3RT1.66
③ Assembly kit consisting of: Wiring modules on the top and bottom for contactors without box terminals for connecting the main and auxiliary circuits, electrical interlock included (NC contact interlock)	3RA1963-2A	
④ Mechanical interlock (must be ordered separately)	3RA1954-2A	
⑤ Base plate for reversing contactor assemblies	3RA1962-2A	

For accessories see pages 2/66-2/83.

For mountable overload relays see Chapter 3, "Overload Relays".

3RT1 contactors – Sizes S6 to S12 with accessories

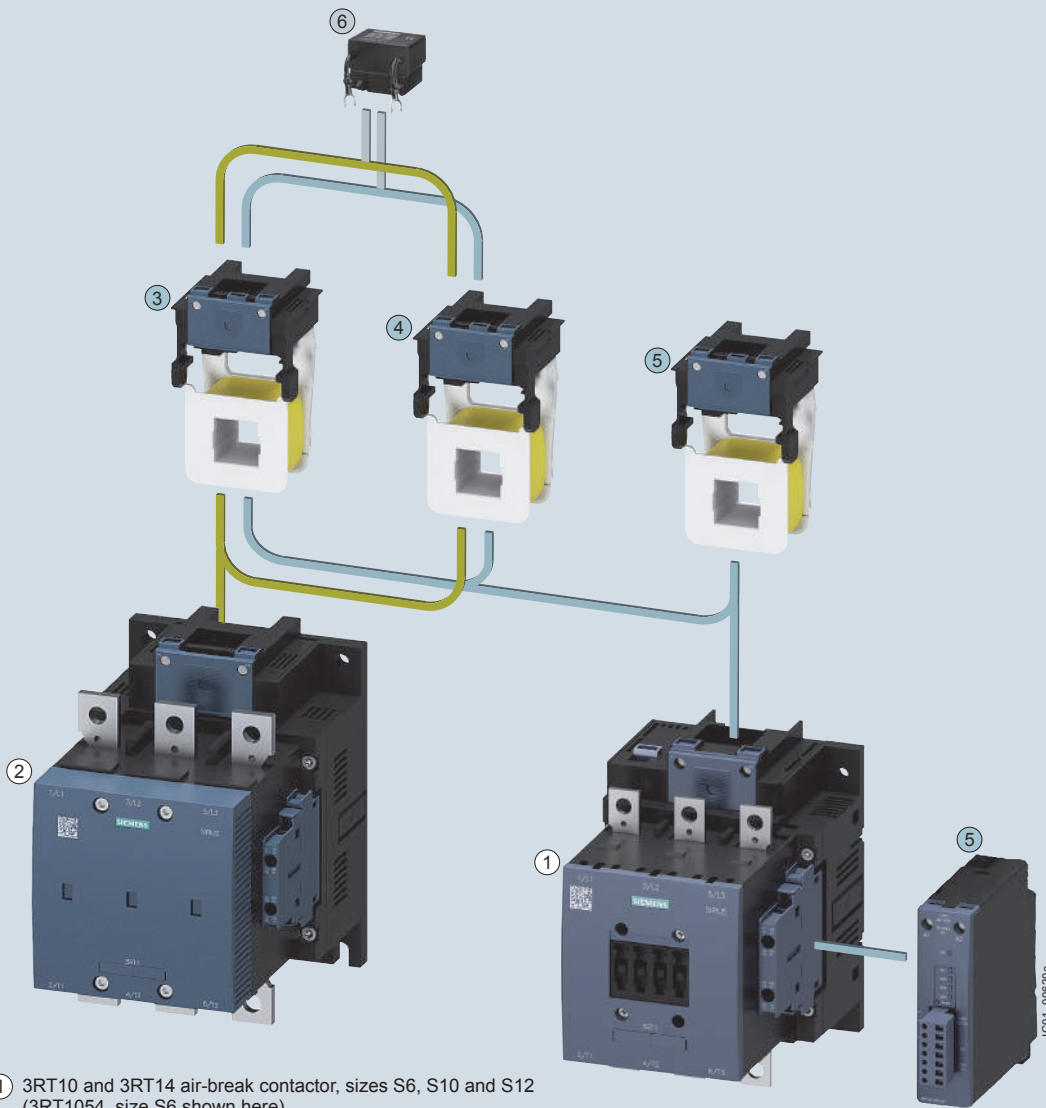

- ① 3RT10 and 3RT14 air-break contactor, sizes S6, S10 and S12 (3RT1054, size S6 shown here)
- ② 3RT12 vacuum contactor, sizes S10 and S12 (3RT1266, size S10 shown here)
- ③ Withdrawable coils for 3RT1...-A... contactors with conventional operating mechanism (size S10: differentiation between 3RT10/3RT14 air-break contactors and 3RT12 vacuum contactors) (size S12: the same for air-break and vacuum contactors)
- ④ Withdrawable coils for 3RT1...-N... contactors with solid-state operating mechanism. (size S10: differentiation between 3RT10/3RT14 air-break contactors and 3RT12 vacuum contactors) (size S12: the same for air-break and vacuum contactors)
- ⑤ Withdrawable coils and laterally mountable module (plug-on) for 3RT1...-P... air-break contactors with solid-state operating mechanism and remaining lifetime indicator
- ⑥ Surge suppressor (RC element), plug-mountable on withdrawable coils
 - 3RT1...-A... with conventional operating mechanism
 - 3RT1...-N... with solid-state operating mechanism
- Same accessories for sizes S6 to S12
- Different accessories depending on size

For surge suppressors [see page 2/73](#),
 withdrawable coils [see page 2/98](#).

For mountable overload relays [see Chapter 3](#),
 “Overload Relays”.

Accessories for 3RT contactors / 3RH control relays

Auxiliary switch blocks

Selection and ordering data

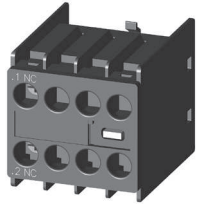

3RH2911-1HA01

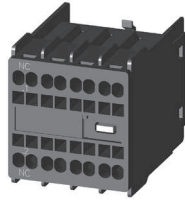

3RH2911-2HA01



3RH19 21-1HA .

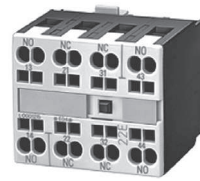

3RH19 21-2HA . .

For contactors/ control relays	Rated operational Current ³⁾ 6A NEMA A600/Q600	Contactor with HS block Ident. No.	Connections position	Auxiliary contacts				Screw Terminals ¹⁾ Order No.	Spring Terminals ¹⁾ Order No.
				Version					
Type				NO	NC	NO	NC		

Auxiliary switch blocks for snapping onto the front according to EN 50012 (also compliant with the requirements according to EN 50005)

Size S00 ²⁾

For assembling contactors with 2, 3, 4, or 5 auxiliary contacts

3RT2.1, Ident. No. 10E	11E	-	1	-	-	3RH2911-1HA01	3RH2911-2HA01
	12E	-	2	-	-	3RH2911-1HA02	3RH2911-2HA02
	13E	-	3	-	-	3RH2911-1HA03	3RH2911-2HA03
	21E	1	-	-	-	3RH2911-1HA10	3RH2911-2HA10
	21E	1	1	-	-	3RH2911-1HA11	3RH2911-2HA11
	22E	1	2	-	-	3RH2911-1HA12	3RH2911-2HA12
	23E	1	3	-	-	3RH2911-1HA13	3RH2911-2HA13
	31E	2	-	-	-	3RH2911-1HA20	3RH2911-2HA20
	31E	2	1	-	-	3RH2911-1HA21	3RH2911-2HA21
	32E	2	2	-	-	3RH2911-1HA22	3RH2911-2HA22
	41E	3	-	-	-	3RH2911-1HA30	3RH2911-2HA30
	41E	3	1	-	-	3RH2911-1HA31	3RH2911-2HA31

Size S0 to S3

For assembling contactors with 3, 4, or 5 auxiliary contacts

3RT2.2, Ident. No. 11E	12E	-	1	-	-	3RH2911-1HA01	3RH2911-2HA01
	13E	-	2	-	-	3RH2911-1HA02	3RH2911-2HA02
3RT2.3, 3RT2.4	14E	-	3	-	-	3RH2911-1HA03	3RH2911-2HA03
	21E	1	-	-	-	3RH2911-1HA10	3RH2911-2HA10
	22E	1	1	-	-	3RH2911-1HA11	3RH2911-2HA11
	23E	1	2	-	-	3RH2911-1HA12	3RH2911-2HA12
	24E	1	3	-	-	3RH2911-1HA13	3RH2911-2HA13
	31E	2	-	-	-	3RH2911-1HA20	3RH2911-2HA20
	32E	2	1	-	-	3RH2911-1HA21	3RH2911-2HA21
	33E	2	2	-	-	3RH2911-1HA22	3RH2911-2HA22
	41E	3	-	-	-	3RH2911-1HA30	3RH2911-2HA30
	42E	3	1	-	-	3RH2911-1HA31	3RH2911-2HA31

Auxiliary switch blocks for snapping onto the front according to EN 50012

Sizes S6 to S12

4-pole

3RT1.5 ... 3RT1.7	22	(with location digits 5, 6, 7, 8)	2	2	-	3RH1921-1XA22-0MA0	3RH1921-2XA22-0MA0
----------------------	-----------	--------------------------------------	---	---	---	---------------------------	---------------------------

EN50005 and EN50012 designate the markings of the auxiliary terminal numbers.

For position of the terminals see pages 2/205-2/209.

For int. circuit diagrams see page 2/193.

3RH29 aux blocks are not intended for use with 3RT1 or 3RH1 contactors and relays.

3RH19 aux blocks are not intended for use with 3RT2 or 3RH2 contactors and relays.

For auxiliary switch blocks for 3RH2140 and 3RH2440 see page 2/51.

1) The 3RH2911-.HA.. aux. switches are available with ring-lug terminals. Replace the 8th digit of the Order No. with a "4".

2) Size S00 can be mounted according to EN 50012 only on basic units which have no integrated NC contact.

3) UL ratings: See appendix page 15/7

Accessories for 3RT contactors / 3RH control relays

Auxiliary switch blocks

Selection and ordering data



3RH2911-1FA40



3RH2911-2FA40



3RH19 21-1C...



3RH19 21-2C...



3RH19 21-1LA...



3RH19 21-1MA..

For contactors/ control relays	Rated operational Current ³⁾ 6A NEMA A600/Q600	Contactor with HS block Ident. No.	Connections position	Auxiliary contacts				Screw Terminals ¹⁾		Spring Terminals ¹⁾	
				Version				Order No.	Order No.		
Type				NO	NC	NO	NC				

Auxiliary switch blocks for snapping onto the front according to EN 50005

Sizes S00 to S3

2- or 4-pole auxiliary switch blocks for assembling contactors with 3 and 5 or 4 and 6 auxiliary contacts

3RT2.1, 3RT2.2, 3RT2.3, 3RT2.4, 3RH21, 3RH24	40 22 04 ¹⁾ 11 ²⁾ 22 ²⁾ 22 ²⁾	4 2 - - 1 -	- 2 4 -	- - - 1 1 2	- - - 1 1 -	3RH2911-1FA40 3RH2911-1FA22 3RH2911-1FA04 3RH2911-1FB11 3RH2911-1FB22 3RH2911-1FC22	3RH2911-2FA40 3RH2911-2FA22 3RH2911-2FA04 3RH2911-2FB11 3RH2911-2FB22 3RH2911-2FC22
---	--	----------------------------	------------------	----------------------------	----------------------------	--	--

1- and 2- pole auxiliary switch blocks, cable entry from above or below

3RT2.1, 3RT2.2, 3RT2.3, 3RT2.4, 3RH21, 3RH24	10 01 11 20	Top Bottom Top Bottom Top Bottom Top Bottom	1 1 - - 1 1 2 2	- - 1 1 - - - -	- - - - - - - -	3RH2911-1AA10 3RH2911-1BA10 3RH2911-1AA01 3RH2911-1BA01 3RH2911-1LA11 3RH2911-1MA11 3RH2911-1LA20 3RH2911-1MA20	- - - - - - - -
---	----------------------	--	--------------------------------------	--------------------------------------	--------------------------------------	--	--------------------------------------

Sizes S6 to S12

Single-pole auxiliary switch blocks (also compliant with EN 5001²⁾)

3RT1.5 ... 3RT1.7	- - - -	1 - - -	- 1 - -	- - 1 1	- - - -	3RH1921-1CA10 3RH1921-1CA01 3RH1921-1CD10 3RH1921-1CD01	3RH1921-2CA10 3RH1921-2CA01 - -
----------------------	------------------	------------------	------------------	------------------	------------------	--	--

EN50005 and EN50012 designate the markings of the auxiliary terminal numbers. For position of the terminals see pages 2/205-2/209. For int. circuit diagrams see page 2/193.

1) Mounting is permitted only on basic units which have no integrated NC contact.

2) Version with early make and delayed break contacts

3) UL ratings: See appendix page 15/7

Accessories for 3RT contactors / 3RH control relays

Laterally mountable auxiliary switch blocks

CONTACTORS AND ASSEMBLIES

Selection and ordering data

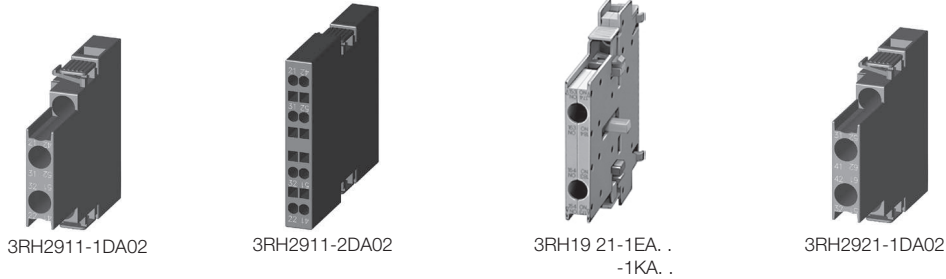

For contactors/ control relays	Rated operational Current ⁵⁾ 6A NEMA A600/Q600	Contactor with HS block Ident. No.	Mountable to contactor/ contactor relay side	Auxiliary contacts		Screw Terminals ¹⁾ Order No.	Spring Terminals ¹⁾ Order No.
				Version			
Type				NO	NC		

Laterally mountable auxiliary switch blocks according to EN 50012

Laterally mountable auxiliary switch block, 2-pole							
Size S00 ^{1) 2)}							
3RT2.1, Ident. No. 10E	A600/Q600 A600/Q600	12E 21E	right or left right or left	– 1	2 1	3RH2911-1DA02 3RH2911-1DA11	3RH2911-2DA02 3RH2911-2DA11
Size S00 to S3							
3RT2.1	A600/Q600	13E	right or left	–	2	3RH2921-1DA02	3RH2921-2DA02
3RT2.2 ³⁾ , Ident. No. 11E	A600/Q600	22E	right or left	1	1	3RH2921-1DA11	3RH2921-2DA11
3RT2.3 ⁴⁾ , 3RT2.4 ⁴⁾	A600/Q600	31E	right or left	2	–	3RH2921-1DA20	3RH2921-2DA20
First laterally mountable auxiliary switch block, 2-pole							
Sizes S6 to S12							
3RT1.5 ... 3RT1.7	A600/Q600		right or left	1	1	3RH1921-1DA11	3RH1921-2DA11
Second laterally mountable auxiliary switch block, 2-pole							
Sizes S6 to S12							
3RT1.5 ... 3RT1.7	A300/Q300		right or left	1	1	3RH1921-1JA11	3RH1921-2JA11

Laterally mountable auxiliary switch blocks according to EN 50005

First laterally mountable auxiliary switch block, 2-pole							
Sizes S00 ^{1) 2)}							
3RT2.1, Ident.No. 10E	A600/Q600 A600/Q600 A600/Q600	02 11 20	right or left right or left right or left	– 1 2	2 1 –	3RH2911-1DA02 3RH2911-1DA11 3RH2911-1DA20	3RH2911-2DA02 3RH2911-2DA11 3RH2911-2DA20
Sizes S00 to S3							
3RT2.1	A600/Q600	02	right or left	–	2	3RH2921-1DA02	3RH2921-2DA02
3RT2.2 ³⁾ ,	A600/Q600	11	right or left	1	1	3RH2921-1DA11	3RH2921-2DA11
3RT2.3 ⁴⁾ , 3RT2.4 ⁴⁾	A600/Q600	20	right or left	2	–	3RH2921-1DA20	3RH2921-2DA20
Sizes S6 to S12							
3RT1.5 ... 3RT1.7	A300/Q300 A300/Q300 A300/Q300		right or left right or left right or left	– 1 2	2 1 –	3RH1921-1EA02 3RH1921-1EA11 3RH1921-1EA20	3RH1921-2EA02 – 3RH1921-2EA20
Second laterally mountable auxiliary switch block, 2-pole							
Sizes S6 to S12							
3RT1.5 ... 3RT1.7	A300/Q300 A300/Q300 A300/Q300		right or left right or left right or left	– 1 2	2 1 –	3RH1921-1KA02 3RH1921-1KA11 3RH1921-1KA20	3RH1921-2KA02 – 3RH1921-2KA20

EN50005 and EN50012 designate the markings of the auxiliary terminal numbers.
For position of the terminals see pages 2/205-2/209.
For int. circuit diagrams see pages 2/193-2/198.

- 1) With size S00, mounting according to EN 50012 is permitted only on basic units which have no NC contact integrated.
- 2) Ident. No. 41, 32 and 23 according to EN 50012 is also possible. Please note the corresponding circuit diagrams for mounting 3RH29 11-1DA.. on the left.
- 3) With 3RT23 2., 3RT25. 2. mountable only on the right.

- 4) 3RH2921-1DA.. lateral auxiliary switches can only be mounted onto 3RT26 capacitor contactors of sizes S2 and S3.
- 5) UL ratings: See appendix page 15/7

Accessories for 3RT contactors / 3RH control relays

Solid-state auxiliary switch blocks

Selection and ordering data

- Operation in dusty atmospheres
- Solid-state circuits with rated operational currents I_e /AC-14 and DC-13 from 1 ... 300 mA at 3 ... 60 V
- Hard gold-plated contacts
- Mirror contacts according to EN 60947-4-1, Appendix F, for laterally mountable auxiliary switches

Selection and ordering data

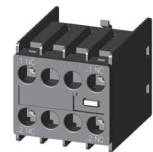

3RH2911-1NF02

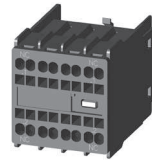

3RH2911-2NF02



3RH2911-2DE11



3RH1921-2DE11



3RH29 21-2DE11

For contactors/ control relays	Contactor with HS block Ident. No.	Mountable to contactor/ contactor relay side	Auxiliary contacts Version	Screw Terminals ¹⁾	Spring Terminals ¹⁾
Type				Order No.	Order No.

Solid-state compatible auxiliary switch blocks for snapping onto the front according to EN 50005¹⁾

Sizes S00 to S3

3RT2.1, 3RT2.2...3RT2.4 3RH21, 3RH24	02 11 20	- 1 2	- - -	- - -	2 1 -	3RH2911-1NF02 3RH2911-1NF11 3RH2911-1NF20	3RH2911-2NF02 3RH2911-2NF11 3RH2911-2NF20
---	----------------	-------------	-------------	-------------	-------------	---	---

Solid-state compatible auxiliary switch blocks, laterally mountable, according to EN 50012

First laterally mountable auxiliary switch block, 2-pole

Size S00²⁾

3RT2. 1., Ident. No. 10E	21E	right	1	-	-	1	-	3RH2911-2DE11
-----------------------------	-----	-------	---	---	---	---	---	---------------

Size S0 to S3

3RT2.2...3RT2.4 Ident. No. 10E	22E	right	1	-	-	1	-	3RH2921-2DE11
-----------------------------------	-----	-------	---	---	---	---	---	---------------

Sizes S6 to S12

3RT1.5 ... 3RT1.7		right or left	1	-	-	1	-	3RH1921-2DE11
-------------------	--	---------------	---	---	---	---	---	---------------

Second laterally mountable auxiliary switch block, 2-pole

Sizes S6 to S12

3RT1.5 ... 3RT1.7		right or left	1	-	-	1	-	3RH1921-2JE11
-------------------	--	---------------	---	---	---	---	---	---------------

Solid-state compatible auxiliary switch blocks, laterally mountable, according to EN 50005

Size S00

3RT2. 1., Ident. No. 10E	11	right or left	1	-	-	1	-	3RH2911-2DE11
-----------------------------	----	---------------	---	---	---	---	---	---------------

Size S0 to S2

3RT2. 2., 3RT2. 3	11	right or left	1	-	-	1	-	3RH2921-2DE11
----------------------	----	---------------	---	---	---	---	---	---------------

EN50005 and EN50012 designate the markings of the auxiliary terminal numbers. For position of the terminals see pages 2/205 -2/209. For int. circuit diagrams see pages 2/193-2/198.



1) The 3RH29 11-.NF.. auxiliary switches are also available with ring lug terminal connection. The 8th digit of the order number must be replaced with "4", e. g.: 3RH2911-1NF11 -> 3RH2911-4NF11

2) Size S00 can be mounted according to EN 50012 only on basic units which have no integrated NC contact.

Accessories for 3RT contactors / 3RH control relays

Auxiliary switch blocks, delayed

Selection and ordering data

For contactors	Rated control supply voltage $U_s^{1)}$	Time setting range t	Output / auxiliary contacts	Screw Terminals	Spring Terminals
Type	V	Sec		Order No.	Order No.
Time-delay, solid-state auxiliary switch blocks for snapping onto the front according to DIN 46199-5					
The electrical connection between the solid-state time-delay auxiliary switch and the contactor underneath is established automatically when it is snapped on and locked into place.					
Sizes S00 to S3					
3RA2813-1AW10 	3RT2., 3RH21 ²⁾ 3RH24	ON-delay (varistor integrated) 24 ... 240 AC/DC 0.05 ... 100 (1, 10, 100, selectable)	1 CO 1 NO + 1 NC	3RA2813-1AW10 3RA2813-1FW10	3RA2813-2AW10 3RA2813-2FW10
		OFF-delay with auxiliary voltage (varistor integrated) 24 ... 240 AC/DC 0.05 ... 100 (1, 10, 100, selectable)	1 CO 1 NO + 1 NC	3RA28 14-1AW10 3RA28 14-1FW10	3RA28 14-2AW10 3RA28 14-2FW10
		OFF-delay without auxiliary voltage³⁾ (varistor integrated) 24 ... 240 AC/DC 0.05 ... 100 (1, 10, 100, selectable)	1 CO 1 NO + 1 NC	3RA2815-1AW10 3RA2815-1FW10	3RA2815-2AW10 3RA2815-2FW10
Sizes S6 to S12					
3RT1926-2FJ11 	3RT10, 3RT13, 3RT14, 3RT15	ON-delay (varistor integrated) 24 AC/DC ⁴⁾ 0.05 ... 1 0.5 ... 10 5 ... 100	1 NO + 1 NC 1 NO + 1 NC 1 NO + 1 NC	3RT19 26-2EJ11 3RT19 26-2EJ21 3RT19 26-2EJ31	— — —
		100 ... 127 AC ⁴⁾ 0.05 ... 1 0.5 ... 10 5 ... 100	1 NO + 1 NC 1 NO + 1 NC 1 NO + 1 NC	3RT19 26-2EC11 3RT19 26-2EC21 3RT19 26-2EC31	— — —
		200 ... 240 AC ⁴⁾ 0.05 ... 1 0.5 ... 10 5 ... 100	1 NO + 1 NC 1 NO + 1 NC 1 NO + 1 NC	3RT19 26-2ED11 3RT19 26-2ED21 3RT19 26-2ED31	— — —
	OFF-delay without auxiliary voltage ⁵⁾ 24 AC/DC ⁴⁾ 0.05 ... 100 (1, 10, 100, selectable)	1 NO + 1 NC 1 NO + 1 NC 1 NO + 1 NC	3RT19 26-2FJ11 3RT19 26-2FJ21 3RT19 26-2FJ31	— — —	
	100 ... 127 AC ⁴⁾ 0.05 ... 100 (1, 10, 100, selectable)	1 NO + 1 NC 1 NO + 1 NC 1 NO + 1 NC	3RT19 26-2FK11 3RT19 26-2FK21 3RT19 26-2FK31	— — —	
	200 ... 240 AC ⁴⁾ 0.05 ... 100 (1, 10, 100, selectable)	1 NO + 1 NC 1 NO + 1 NC 1 NO + 1 NC	3RT19 26-2FL11 3RT19 26-2FL21 3RT19 26-2FL31	— — —	
	WYE-delta function 24 AC/DC ⁴⁾ 1.5 ... 30 100 ... 127 AC ⁴⁾ 1.5 ... 30 200 ... 240 AC ⁴⁾ 1.5 ... 30	each have: 1 NO delayed 1 NO instant interval 50ms	3RT19 26-2GJ51 3RT19 26-2GC51 3RT19 26-2GD51	— — —	

For technical data, see pages 2/185-2/186.
 For int. circuit diagrams, see page 2/201.
 For position of terminals, see page 2/209.

When the solid-state time-delay auxiliary switches are used, no other auxiliary switches are allowed to be mounted on the basic units.

1) AC voltage values apply for 50 Hz and 60 Hz.

2) Cannot be fitted onto coupling relays.

3) Setting of output contacts in as-supplied state not defined (bistable relay). Application of the control supply voltage once results in contact change-over to the correct setting.

4) Terminals A1 and A2 for the rated control supply voltage of the solid-state time-delay auxiliary switch must be connected to the associated contactor by means of connecting leads.

5) Position of the output contacts not defined in the as-delivered state (bistable relay). Applying the control voltage once results in the contacts switching to the correct position.

Accessories for 3RT contactors / 3RH control relays

Function modules, delay blocks

Selection and ordering data



3RA2812-1DW10



3RA2811-2CW10

For contactors	Rated control supply voltage U_s ¹⁾	Time setting range t	Screw terminals	Spring-type terminals	Weight
Type	V AC/DC	s	Order No.	Order No.	kg

Timing relays for mounting on 3RT2 contactors

Sizes S00 to S3

The electrical connection between the timing relay and the contactor underneath is established automatically when it is snapped on and locked.

ON-delay

Two-wire design, varistor integrated

Type	Rated control supply voltage U_s	Time setting range t	Order No. (Screw terminals)	Order No. (Spring-type terminals)
3RT20..., 3RT23..., 3RT25..., 3RH21 ²⁾ , 3RH24	24 ... 240	0.05 ... 100 (1, 10, 100; selectable)	3RA2811-1CW10	3RA2811-2CW10
3RT203.	24 ... 90 90 ... 240	0.05 ... 100 (1, 10, 100; selectable)	3RA2831-1DG10 3RA2831-1DH10	3RA2831-2DG10 3RA2831-2DH10
OFF-delay with control signal Varistor integrated				
3RT20..., 3RT23..., 3RT25..., 3RH21 ²⁾ , 3RH24	24 ... 240	0.05 ... 100 (1, 10, 100; selectable)	3RA2812-1DW10	3RA2812-2DW10
3RT203.	24 ... 90 90 ... 240	0.05 ... 100 (1, 10, 100; selectable)	3RA2832-1DG10 3RA2832-1DH10	3RA2832-2DG10 3RA2832-2DH10

¹⁾ AC voltage values apply for 50 Hz and 60 Hz.

²⁾ Cannot be fitted onto coupling relays.

For description, see page 2/119.
For technical data, see page 2/185.
For circuit diagrams, see page 2/201.

¹⁾ AC voltage ratings apply for 50 and 60 Hz.

²⁾ The 3RA28 time-delay blocks are available with spring-type terminals. Replace the 8th digit of the order number with a "2".

³⁾ Cannot be fitted onto coupling relays

Accessories for 3RT contactors / 3RH control relays

Function modules, delay blocks, and mechanical latching blocks

CONTACTORS AND ASSEMBLIES 2

Selection and ordering data

	For contactors Type	Rated control supply voltage U_s ¹⁾ V	Time setting range t sec	Screw Terminals ²⁾ Order No.	Weight approx. kg	
Off-delay device						
	3RT2916-2B.01	Sizes S00 to S2		3RT2916-2BK01	0.150	
		For contactors with DC operation. Non-adjustable delay time				
	3RT2., 3RH2. ...-1BF40	110 AC/DC	S00: > 0.1 S0: > 0.08; S2: > 0.25	3RT2916-2BL01	0.150	
	3RT2., 3RH2. ...-1BM40	220 ... 230 AC/DC	S00: > 0.5 S0: > 0.3; S2: > 0.8	3RT2916-2BE01	0.150	
	3RT2916-2BE01	24 DC	S00: > 0.2 S0: > 0.1; S2: > 0.1	3RT2916-2BE01	0.150	
		Sizes S3				
	3RT2. 4	24 DC	S3: 70 fixed	3RT2916-2BE01	0.093	
Pneumatic delay blocks, terminal designation according to EN 50005 ⁴⁾						
	3RT2926-2PA01	Size S0		3RT2926-2PA01 3RT2926-2PA11 3RT2926-2PR01 3RT2926-2PR11	0.080 0.080 0.080 0.080	
		For snapping onto the front of contactors ⁵⁾ Auxiliary contacts 1 NO and 1 NC				
		With ON-delay	–			0.1 ... 30 1 ... 60
		With OFF-delay	–			0.1 ... 30 1 ... 60
Mechanical latching blocks						
	3RT2926-3AB31	For mounting onto the front of contactors		3RT2926-3AB31 3RT2926-3AF31 3RT2926-3AP31	0.100 0.100 0.100	
		The contactor remains in the energized state even after voltage failure				
		Size S0				
	3RT2. 2	24 AC/DC 110 AC/DC 230 AC/DC	– – –			

For description, see page 2/119.
For technical data, see page 2/185.
For circuit diagrams, see page 2/201.

- 1) AC voltage ratings apply for 50 and 60 Hz.
- 2) The 3RA28 time-delay blocks are available with spring-type terminals. Replace the 8th digit of the order number with a "2".
- 3) Cannot be fitted onto coupling relays
- 4) Versions according to DIN VDE 0116 on request.
- 5) In addition to these, no other auxiliary contacts are permitted.

Accessories for 3RT contactors / 3RH control relays

Surge suppressors

Selection and ordering data

For contactors	Version	Rated control supply voltage U_s ¹⁾		Order No.	Weight kg
		AC operation	DC operation		
Type		V AC	V DC		

Surge suppressors without LED (also for spring-type terminals)

Size S00

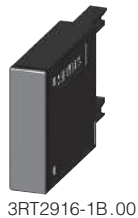

For plugging onto the front side of the contactors (with and without auxiliary switch block)

For contactors	Version	Rated control supply voltage U_s ¹⁾	Order No.
3RT2.1, 3RH2.	Varistors	24 ... 48	3RT2916-1BB00
		48 ... 127	3RT2916-1BC00
		127 ... 240	3RT2916-1BD00
		240 ... 400	3RT2916-1BE00
		400 ... 600	3RT2916-1BF00
3RT2.1, 3RH2.	RC elements	24 ... 48	3RT2916-1CB00
		48 ... 127	3RT2916-1CC00
		127 ... 240	3RT2916-1CD00
		240 ... 400	3RT2916-1CE00
		400 ... 600	3RT2916-1CF00
3RT2.1, 3RH2.	Noise suppression diodes	12 ... 250	3RT2916-1DG00
3RT2.1, 3RH2.	Diode assemblies (diode and Zener diode) for DC operation	12 ... 250	3RT2916-1EH00

Size S0



For plugging onto the front side of the contactors (prior to mounting of the auxiliary switch block)

For contactors	Version	Rated control supply voltage U_s ¹⁾	Order No.
3RT2.2	Varistors	24 ... 48	3RT2926-1BB00
		48 ... 127	3RT2926-1BC00
		127 ... 240	3RT2926-1BD00
		240 ... 400	3RT2926-1BE00
		400 ... 600	3RT2926-1BF00
3RT2.2	RC elements	24 ... 48	3RT2926-1CB00
		48 ... 127	3RT2926-1CC00
		127 ... 240	3RT2926-1CD00
		240 ... 400	3RT2926-1CE00
		400 ... 600	3RT2926-1CF00
3RT2.2	Diode assembly for DC operation	24 30 ... 250	3RT2926-1ER00 3RT2926-1ES00

Size S2 and S3



For plugging onto the front side of the contactors (prior to mounting of the auxiliary switch block)

For contactors	Version	Rated control supply voltage U_s ¹⁾	Order No.
3RT2.3.	Varistors	24 ... 48	3RT2936-1BB00
		48 ... 127	3RT2936-1BC00
		127 ... 240	3RT2936-1BD00
		240 ... 400	3RT2936-1BE00
		400 ... 600	3RT2936-1BF00
3RT2.3.	RC elements	24 ... 48	3RT2936-1CB00
		48 ... 127	3RT2936-1CC00
		127 ... 240	3RT2936-1CD00
		240 ... 400	3RT2936-1CE00
		400 ... 600	3RT2936-1CF00
3RT2.3.	Diode assembly for DC operation	24 30 ... 250	3RT2936-1ER00 3RT2936-1ES00





¹⁾ Can be used for AC operation for 50/60 Hz. Please inquire about further voltages.

Accessories for 3RT contactors / 3RH control relays

Surge suppressors

Selection and ordering data

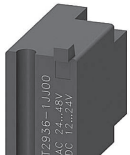
For contactors	Version	Rated control supply voltage U_s 1)			Order No.	Weight approx. kg		
		AC operation	DC operation	mW				
Type		V AC	V DC					
Surge suppressors without LED (also for spring-type terminals)								
3RT1936-1C.00	Sizes S6, S10, S12	For plugging onto the conventional or solid-state coil RC element						
	3RT1.5, 3RT1.6 3RT1.7	24 ... 48 48 ... 127 127 ... 240 240 ... 400 400 ... 600	24 ... 70 70 ... 150 150 ... 250 – –		3RT1956-1CB00 3RT1956-1CC00 3RT1956-1CD00 3RT1956-1CE00 3RT1956-1CF00	0.03 0.03 0.03 0.03 0.03		
Surge suppressors with LED (also for spring-type terminals)								
3RT2916-1J.00	Size S00	For plugging onto the front side of the contactors (with and without auxiliary switch block) Varistor						
	3RT2.1, 3RH2.	24 ... 48 48 ... 127 127 ... 240 –	12 ... 24 24 ... 70 70 ... 150 150 ... 250	10 ... 120 20 ... 470 50 ... 700 160 ... 950	3RT2916-1JJ00 3RT2916-1JK00 3RT2916-1JL00 3RT2916-1JP00	0.010 0.010 0.010 0.010		
	3RT2.1, 3RH2.	Noise suppression diode		– – –	24 ... 70 50 ... 150 150 ... 250	20 ... 470 50 ... 700 160 ... 950	3RT2916-1LM00 3RT2916-1LN00 3RT2916-1LP00	0.010 0.010 0.010
3RT2926-1MR00	Size S0	For plugging onto the front side of the contactors (prior to mounting of the auxiliary switch block) Varistor						
	3RT2.2	24 ... 48 48 ... 127 127 ... 240	12 ... 24 24 ... 70 70 ... 150	10 ... 120 20 ... 470 50 ... 700	3RT2926-1JJ00 3RT2926-1JK00 3RT2926-1JL00	0.010 0.010 0.010		
	3RT2.2	Diode assembly		–	24	20 ... 470	3RT2926-1MR00	0.010
3RT2936-1J.00	Sizes S2 and S3	For plugging onto the front side of the contactors (prior to mounting of the auxiliary switch block) Varistor						
	3RT2.3.	24 ... 48 48 ... 127 127 ... 240	12 ... 24 24 ... 70 70 ... 150	10 ... 120 20 ... 470 50 ... 700	3RT2936-1JJ00 3RT2936-1JK00 3RT2936-1JL00	0.010 0.010 0.010		

1) Can be used for AC operation for 50/60 Hz. Please inquire about further voltages.

Accessories for 3RT contactors / 3RH control relays

Surge suppressors, terminals, labels

Selection and ordering data

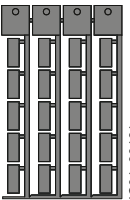
For contactors	Version	Units	Order No.	Weight approx. kg
Main conducting path surge suppression module for 3RT12 vacuum contactors				
Sizes S10 and S12 3RT12	For damping overvoltages and protecting the motor windings against multiple reignition when switching off three-phase motors. For connection on the contactor feeder side (2-T1/4-T2/6-T3). For separate installation. Rated operational voltage $U_e \geq 500$ V AC ... ≤ 690 V AC Rated operational voltage $U_e \leq 1000$ V AC		3RT1966-1PV3 3RT1966-1PV4	0.18 0.36
Auxiliary conductor terminal, 3-pole				
3RT2946-4F	Size S3 3RT204.	For connecting auxiliary and control leads to the main conductor terminals (for one side).	3RT2946-4F	
Blank Labels				
3RT29 00- 1SB20		Unit labeling plates 20 mm x 7 mm, pastel PC labeling system for individual inscription of unitlabeling plates available from: murrplastik Systems, Inc.		
		340 units	3RT2900-1SB20	0.200
		816 units	3RT2900-1SB10	0.294

Links for paralleling



3RT1916-4BB31



3RT1916-4BB41

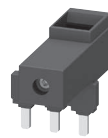

3RT1936-4BB31



3RT1956-4BA31

Size	For contactors Type	Maximum resistive current I_e /AC-1 (at 60 °C) of contactors A	Max. conductor cross sections	Screw Terminals Order No.	Standard package quantity	Weight approx. kg
S00	3RT201.	3-pole, with terminal 1), 2)	4 AWG, stranded	3RT1916-4BB31		0.015
S0	3RT202.		0 AWG, stranded	3RT2926-4BB31		0.042
S2	3RT203.		95 mm ²	3RT1936-4BB31		0.139
S3	3RT204.	3-pole, with through hole	185 mm ²	3RT1946-4BB31		0.205
S6	3RT1. 5	(WYE jumpers) 1), 2)	—	3RT1956-4BA31		0.159
S10/S12	3RT1. 6 3RT1. 7		—	3RT1966-4BA31		0.541
S00	3RT231. 3RT251.	4-pole, with terminal 1), 2)	4 AWG, stranded	3RT1916-4BB41		0.016

1) Can be used for AC operation for 50/60 Hz. Please inquire about further voltages.

Accessories for 3RT contactors / 3RH control relays

Other function blocks, PLC control, load modules, control kit

Selection and ordering data

For contactors Type	Version	Order No.	Weight
------------------------	---------	-----------	--------

EMC suppression modules; 3-phase, up to 10 HP

Size S00 (for contactors with AC or DC operation)



3RT2916-1PA.

3RT201	RC elements (3 x 220Ω/0.22 μF) Up to 400 V Up to 575 V Up to 690 V
3RT201	Varistors Up to 400 V Up to 575 V Up to 690 V

Screw terminals

3RT2916-1PA1
3RT2916-1PA2
3RT2916-1PA3

3RT2916-1PB1
3RT2916-1PB2
3RT2916-1PB3

Coupling links for control by PLC

Size S0



3RH2924-1GP11

3RT2.. 2 **For mounting onto the coil terminals of the contactors (only for contactors with screw terminals)**
With LED for indicating switching state.
With integrated varistor for damping opening surges.
24 V DC control,
17 ... 30 V DC operating range

3RH2924-1GP11

Sizes S00 to S3



3RH2914-1GP11

3RT2.. 1,
3RT2.. 2,
3RT2.. 3 **For mounting on the front side of contactors with AC, DC or AC/DC operation**
24 V DC control,
17 ... 30 V DC operating range

3RH2914-1GP11

Spring-type terminals

3RH2914-2GP11

Additional load modules

Size S00



3RT2916-1GA00

3RT2.. 1,
3RH2.. **For plugging onto the front side of the contactors with or without auxiliary switch blocks**
For increasing the permissible residual current and for limiting the residual voltage. It ensures the safe opening of contactors with direct control via 230 V AC semiconductor outputs of SIMATIC controllers. It acts simultaneously as a surge suppressor.
Rated voltage:
50/60 Hz, 180 to 255 V AC

3RT2916-1GA00

LED module for indicating contactor operation

Sizes S00 to S3



3RT2926-1QT00

3RT2.. **For snapping into the location hole of an inscription label on the front of a contactor**
either directly on the contactor or on the front auxiliary switch.
The LED module is connected to coil terminals A1 and A2 of the contactor and indicates its energized state.
Yellow LED.
Rated voltage:
24 ... 240 V AC/DC, with reverse polarity protection.

3RT2926-1QT00

Control kit

Sizes S00 to S3



3RT2916-4MC00

3RT2.. 1,
3RH2.. **For manual operation of the contactor contacts for start-up and service**
3RT2.. 2
3RT2.. 3

3RT2916-4MC00

3RT2926-4MC00
3RT2936-4MC00

Accessories for 3RT contactors / 3RH control relays

Terminals, covers, adapters, connectors

Selection and ordering data

For contactors Type	Version	Order No.	Weight
Sealable covers			
	<p>Sizes S00 to S3</p> <p>3RT2.1, 3RT2.2, 3RT2.3, 3RT2.4, 3RH2.1)</p>	<p>Sealable covers for preventing manual operation (Not suitable for coupling relays)</p> <p>3RT2916-4MA10</p>	
Connection modules for contactors with screw terminals			
Sizes S00 and S0			
	<p>Adapters for contactors Ambient temperature $T_{U\max} = 60\text{ °C}$</p> <p>3RT2.1, 3RH2.</p>	<p>Screw terminals </p> <p>Size S00, rated operational current I_e at AC-3/400 V: 20 A</p> <p>3RT1916-4RD01</p>	
3RT1926-4RD01	3RT2.2	<p>Size S0, rated operational current I_e at AC-3/400 V: 25 A</p> <p>3RT1926-4RD01</p>	
	<p>Plugs for contactors Size S00, S0</p> <p>3RT2.1, 3RT2.2, 3RH2.</p>	3RT1900-4RE01	
3RT1900-4RE01			
Terminal covers for contactors with box terminals			
Size S2			
	<p>Covers for box terminals</p> <p>3RT203 3RT233, 3RT253</p>	<p>For 3-pole contactors For 4-pole contactors (see Chapter 4)</p> <p>3RT2936-4EA2 3RT2936-4EA4</p>	
3RT2936-4EA2			
Coil connection modules			
Sizes S0 and S2			
	<p>3RT2.2, 3RT2.3</p>	<p>Connection from top Connection from below Connection diagonally</p> <p>3RT2926-4RA11 3RT2926-4RB11 3RT2926-4RC11</p>	
3RT2926-4RA11			
	3RT2.2	<p>Connection from top Connection from below</p> <p>3RT2926-4RA12 3RT2926-4RB12</p>	
3RT2926-4RA12			
Covers for contactors with ring cable lug connections			
Size S00			
	<p>Covers for ring terminal lug connections</p> <p>3RT2.1, 3RH2</p>	<p>Ring terminal lug connections </p> <p>Single covers</p> <p>3RT2916-4EA13</p>	
3RT2916-4EA13			
	<p>Covers for ring terminal lug connections</p> <p>3RT2.2</p>	<p>Set for one device, comprising 4 single covers: - 2 x 3RT2926-4EB13 - 2 x 3RV2928-4AA00</p> <p>3RT2926-4EB13</p>	
3RT2926-4EB13			

1) Exception: contactors and contactor relays with auxiliary switch block mounted onto the front.

Accessories for 3RT contactors / 3RH control relays

Terminals, covers, adapters, connectors

For contactors Type	Version	Order No.	Weight
------------------------	---------	-----------	--------

Screw adapters for fixing the contactors

Sizes S0 and S2

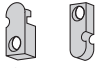

NSB0_01470
3RT1926-4P

3RT2.2,
3RT2.3

Screw adapters for easier screw fixing
2 units required per contactor
(1 pack contains 10 sets for 10 contactors)

3RT1926-4P

Solder pin adapters for contactors up to 7.5 HP / 12 A

Size S00, up to 7.5 HP



3RT1916-4KA1

3RT2.1,
3RH21

Assembly kit for soldering contactors onto a printed circuit board.
For 1 contactor, 1 set is required.

Screw terminals



3RT1916-4KA1

Solder pin adapters for contactors up to 7.5 HP / 12 A with mounted 4-pole auxiliary switch block

Size S00, up to 7.5 HP

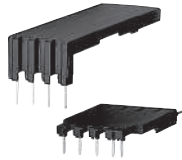

3RT1916-4KA2

3RT2.1,
3RH21

Assembly kit for soldering contactors with an auxiliary switch block onto a printed circuit board.
For 1 contactor, 1 set is required.

3RT1916-4KA2

Safety main current connectors for 2 contactors

Sizes S00 to S2



3RA2926-1A

For series connection of 2 contactors

3RT2.1
3RT2.2
3RT2.3

3RA2916-1A
3RA2926-1A
3RA2936-1A

1) Exception: contactors and contactor relays with auxiliary switch block mounted onto the front.

Accessories for 3RT contactors / 3RH control relays

Terminals, covers, accessories

Selection and ordering data

For contactors	Design	Order No.	Weight approx. kg.
----------------	--------	-----------	--------------------

Box terminal block for contactors with screw connections

3RT19 5. -4G



Size	Type	Design	Order No.	Weight approx. kg.
S3	3RT2. 4	For circular conductors and ribbon cables For connectable cross-sections, see technical data of contactors, page 2/99 16 mm ² / 10 AWG (solid), 70 mm ² / 0 AWG (stranded)	3RT19 46-4G	
S6	3RT1. 5 (3RB205)	up to 70 mm ² / 2/0 AWG up to 120 mm ² / 4/0 AWG	3RT19 55-4G 3RT19 56-4G	0.23 0.26
S10, S12	3RT1. 6, 3RT1. 7 (3RB206)	240 mm ² - 500 mm ² / 500 MCM - 750 MCM with auxiliary conductor connection	3RT19 66-4G	0.64

Covers for contactors with screw connections

3RT29 36-4EA2

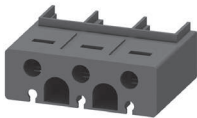

Design	Order No.	Package quantity	Weight approx. kg.
S2	3RT20 3	Terminal cover for box terminals Additional shock-hazard protection for mounting on the box terminals (2 units required per contactor)	3RT29 36-4EA2 0.012
S3	3RT20 4		3RT19 46-4EA2
S6	3RT1. 5	Length: 25 mm	3RT19 56-4EA2 0.016
S10, S12	3RT1. 6, 3RT1. 7	Length: 30 mm	3RT19 66-4EA2

3RT19 46-4EA1



Design	Order No.	Package quantity	Weight approx. kg.
S3	3RT20 4 3RT24 4	Terminal cover for cable lug and busbar connection For complying with the phase clearances and as shock-hazard protection in the case of a distant box terminal ¹⁾ (2 units required per contactor)	3RT19 46-4EA1 0.028
S6	3RT1. 5	Length: 100 mm	3RT19 56-4EA1 0.05
S10, S12	3RT1. 6, 3RT1. 7	Length: 120 mm	3RT19 66-4EA1
S6	3RT1. 5	For covering bars between the contactor and 3RB20 overload relay or wiring connector for contactor assemblies Length: 27 mm	3RT19 56-4EA3 0.018
S10, S12	3RT1. 6, 3RT1. 7	Length: 42 mm	3RT19 66-4EA3

Design	Order No.	Package quantity	Weight approx. kg.
--------	-----------	------------------	--------------------

Insulation stop for securely holding back the conductor insulation on conductors up to 1 mm² (17 AWG)

3RT1916-4JA02



Insulation stop strips can be inserted in cable entry of the spring terminal (2 strips per contactor required)			
• For basic devices S00 (3RT201. or 3RH2.), removable individually	3RT2916-4JA02	20 strips	0.005
• For auxiliary and control circuit on basic devices size S0 and S2 (3RT2.2., 3RT2.3.) and for mountable 3RH29 auxiliary switches, removable in pairs	3RT1916-4JA02	20 strips	0.010

Tool for opening spring-type terminals

3RA2908-1A



Screwdriver for all SIRIUS devices with spring-type terminals Length: approx. 200 mm, 3.0 mm x 0.5 mm, titanium gray/black, partially insulated	3RA2908-1A	1 unit	0.045
--	-------------------	--------	-------



1) Refer to the note on page 2/142, conductor cross-sections.

Contactors Assemblies for Switching Motors

3RA13, 3RA23 reversing contactor assemblies

CONTACTORS AND ASSEMBLIES 2

Accessories

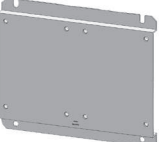

	For contactors Type	Size	Design	Order No.	Weight approx. kg	
Mechanical interlocks						
	3RA19 24-2B	3RT2.3	S2	laterally mountable for 3RT2 S2 contactors only. There are no NC auxiliary contacts. Use the integrated NC auxiliary on the contactor.	3RA2934-2B	0.04
		3RT204, 3RT234, 3RT245	S3 ¹⁾	laterally mountable each with one auxiliary contact (1 NC) per contactor (can only couple contactors of max. 1 level different size. The mounting depth of the smaller contactor has to be adapted.) Interlock width: 10 mm	3RA2934-2B	0.05
	3RA19 54-2C	3RT204 to 3RT105	S3 to S6	adapter to mechanically interlock a 3RT204 with a 3RT105 includes the adapter and QTY 2 - 3RA1942-2G mechanical connectors requires the 3RA1954 - 2A to be ordered separately Note: Fits 3RT104 AC coil versions only. Does not fit 3RT104 DC coil versions.	3RA1954-2G	
	3RA19 54-2A	3RT1. 5 to 3RT1. 7	S6, S10, S12	laterally mountable without auxiliary contacts; size S6, S10 and S12 contactors can be interlocked with each other as required; no adaptation of mounting depth is necessary. Contactor clearance 10 mm.	3RA1954-2A	0.02
Baseplates						
	3RA1972-2A	3RT10 5	S6	for customer mounting of contactor assemblies for reversing	3RA1952-2A	1.3
		3RT1. 6	S10		3RA1962-2A	2.4
		3RT1. 7	S12		3RA1972-2A	2.6

1) Can also be used for size S3 4-pole contactors.

Contactors Assemblies for Switching Motors

3RA13, 3RA23 reversing contactor assemblies

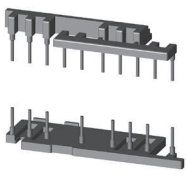
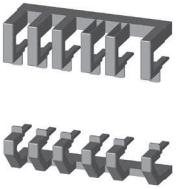
Accessories

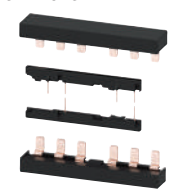
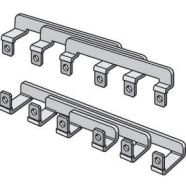
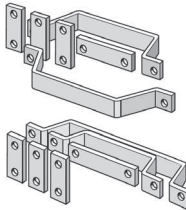
	For contactors Type	Size	Details	Screw Terminals Order No.	Spring Terminals Order No.	Pkg. qty.
Assembly kits for making 3-pole contactor assemblies						
	3RT201	S00	The assembly kit contains: Mechanical interlock, 2 connecting clips for 2 contactors, Wiring modules on the top and bottom <ul style="list-style-type: none">For main, auxiliary and control circuits	3RA2913-2AA1	3RA2913-2AA2	1 kit
	3RT202	S0	The assembly kit contains: Mechanical interlock, 2 connecting clips for 2 contactors, Wiring modules on the top and bottom <ul style="list-style-type: none">For main, auxiliary and control circuits ¹⁾Only for main circuit ²⁾	3RA2923-2AA1 —	— 3RA2923-2AA2	1 kit 1 kit
	3RT203	S2	The installation kit contains: 2 connecting clips for 2 contactors, Wiring modules on the top and bottom <ul style="list-style-type: none">Only for main circuit ³⁾	3RA2933-2AA1 —	— 3RA2933-2AA2	1 kit 1 kit
	3RT204	S3	The installation kit contains: 2 connecting clips for 2 contactors, Wiring modules on the top and bottom and the mechanical interlock	3RA2943-2AA1	—	1 kit
	3RT105	S6	The installation kit contains: Wiring modules on the top and bottom (for connection with box terminal)	3RA19 53-2A	—	1 kit
	3RT105 3RT1. 6 3RT1. 7	S6 S10 S12	The installation kit contains: Wiring modules on the top and bottom (for connection without box terminals)	3RA1953-2M 3RA1963-2A 3RA1973-2A		1 kit

1) Use of the 3RA2923-2AA1 assembly kit in conjunction with the 3RT202.-.....-3MA0 contactors is limited because the auxiliary switches in the basic unit are not allowed to be used on account of the permanently mounted auxiliary switch block.

2) Version in size S0 with spring-type terminals: Only the wiring modules for the main circuit are included. No connectors are included for the auxiliary and control circuit.

3) Version in size S2 with spring-type terminals in the auxiliary and control circuits: Only the wiring modules for the main circuit are included. A cable set is included for the auxiliary circuit.

Contactors Assemblies for Switching Motors

3RA13, 3RA23 reversing contactor assemblies

Accessories

	For contactors Type	Size	Contactor gap for interlock	Version	Screw Terminals Order No.	Spring Terminals Order No.	Pkg. qty.
Wiring modules							
	3RT201	S00-S00	0 mm	Top (in-phase) Bottom (phase reversal)	3RA2913-3DA1 3RA2913-3EA1	3RA2913-3DA2 3RA2913-3EA2	1 1
	3RT202	S0-S0	0 mm	Top (in-phase) Bottom (phase reversal)	3RA2923-3DA1 3RA2923-3EA1	3RA2923-3DA2 3RA2923-3EA2	1 1
	3RT203	S2-S2	10 mm	Top (in-phase) Bottom (phase reversal)	3RA1933-3D 3RA1933-3E	3RA1933-3D 3RA1933-3E	1 1
	3RT204	S3-S3	10 mm	Top (in-phase) Bottom (phase reversal)	3RA1943-3D 3RA1943-3E	3RA1943-3D 3RA1943-3E	1 1
	3RT105	S6-S6	10 mm	Top (in-phase, for connection with box terminal)	3RA1953-3D	3RA1953-3D	1
	3RA1953-3P			Top (with phase reversal, for connection without box terminal)	3RA1953-3P	3RA1953-3P	1

For contactors Type	Size	Contactor gap for interlock	Interlock Type	Version	Order No.	Pkg. qty.
---------------------	------	-----------------------------	----------------	---------	-----------	-----------

Mechanical connectors¹⁾							
	3RT201	S00-S00	0 mm	Laterally mountable	For 3-pole contactors and 4-pole contactors	3RA2912-2H	1 set
	3RT202	S0-S0	0 mm	Laterally mountable	For 3-pole contactors and 4-pole contactors	3RA2922-2H	1 set
	3RT203	S2-S2	0 mm	Laterally mountable	For 3-pole contactors	3RA2932-2C	5 sets
			10 mm	Laterally mountable	For 3-pole contactors	3RA2932-2D	5 sets
	3RT233			Laterally mountable	For 4-pole contactors	3RA2932-2G	5 sets
	3RT2. 4	S3-S3	0 mm	Mountable on front	For 3-pole contactors	3RA2932-2C	10 sets
			10 mm	Laterally mountable	For 3-pole contactors	3RA2932-2D	10 sets
					For 4-pole contactors	3RA2942-2G	10 sets
	3RT1. 5	S6-S6	10 mm	Laterally mountable	Top (with phase reversal, for connection without box terminal)	3RA1932-2D	10 sets

Note: Standard package quantities may change. Check Industry Mall for current package quantities.

1) 1 set for 1 contactor. Size S00 & S0: 1 set includes 2 connectors and 1 interlock. **Size S2: The mechanical interlock must be ordered separately.** S3-S6: 1 set includes 2 connectors; one connector for top and one connector for bottom.

Contactors Assemblies for Switching Motors

WYE-delta accessories

Accessories					
Design	Sizes	Order No.		Weight approx. kg	
Installation kits^{1) 2)}					
<p>3RA19 53-2B</p>	The installation kit contains: Mechanical interlock, 4 connecting clips, WYE jumper, Wiring connectors on the top and bottom,- For main, auxiliary, and control circuits ³⁾	S00-S00-S00	3RA2913-2BB1	1 set	0.05
	The installation kit contains: mechanical interlock, 4 connecting clips, WYE jumper, wiring connectors on the top and bottom - For main, auxiliary, and control circuits ³⁾	S0-S0-S0 S2-S2-S0 S2-S2-S2	3RA2923-2BB1 3RA2933-2C 3RA2933-2BB1	1 set 1 set	0.10 0.16 0.16
<p>3RA19 53-2N, 3RA19 63-2B, 3RA19 73-2B</p>	The installation kit contains: WYE jumper on the top Wiring jumper on the bottom	S3-S3-S2 S3-S3-S3 S6-S6-S6	3RA2943-2C 3RA2943-2BB1 3RA1953-2B		0.33 0.16 0.85
	(The wiring connector on the top is not included in the scope of supply. A double infeed between the line contactor and the delta contactor is recommended.)	S6-S6-S6 S10-S10-S10 S12-S12-S12	3RA1953-2N 3RA1963-2B 3RA1973-2B		0.60 1.80 2.20
	3-phase feeder terminal				
	Feeder terminal block for the line contactor for large conductor cross-sections				1 unit
Conductor cross-section: 6 mm ² , 10 AWG	S00	3RA2913-3K			0.02
Conductor cross-section: 16 mm ² , 6 AWG	S0	3RV2925-5AB			0.04
Conductor cross-section: 70 mm ² , 2/0 AWG	S2	3RV2935-5A			0.10
1-phase feeder terminals					
Conductor cross-section: 95 mm ²	S3	3RA2943-3L			0.280
3-phase busbar					
For in-phase bridging of all input terminals of the line contactor (K1) and the delta contactor (K3)	S0 S2	3RV1915-1AB 3RV2935-5E		1 unit	0.03 0.15
Link for paralleling, 3-pole (WYE jumpers)					
3RT19 26-4BA31	Without terminal (the links for paralleling can be reduced by one pole)	S00¹⁾ S0¹⁾ S2 S3 S6⁴⁾ S10, S12⁴⁾	3RT1916-4BA31 3RT1926-4BA31 3RT1936-4BA31 3RT1946-4BA31 3RT1956-4BA31 3RT1966-4BA31	1 unit	0.010 0.020 0.02 0.02 0.15
Baseplates					
For customer assembly of WYE-delta contactor assemblies with a laterally mounted time-delay				1 unit	
Side-by-side mounting		3RA2932-2F			0.45
10 mm clearance between K3 and K2		3RA2932-2F			0.48
Side-by-side mounting		3RA2942-2F			0.72
Side-by-side mounting		3RA2942-2F			0.72
10 mm clearance between K1, K3 and K2		3RA1952-2E 3RA1952-2F 3RA1962-2E 3RA1962-2F 3RA1972-2E 3RA1972-2F		1 unit	2.0 2.1

1) Size S00, S0 and S2 installation kits for paralleling are available in spring-type terminals. Change the last digit of the order number to a "2".

2) When using the function modules for wye-delta starting, the wiring modules for the auxiliary current are not required. See page 2/45 for more information.

3) Also requires quantity (1) 3RA2816-0EW20 function module set for all control functions. See page 2/45.

4) The 3RT19 56-4EA1 (S6) or 3RT19 66-4EA1 (S10, S12) cover can be used for shock-hazard protection.

Contactor Assemblies for Switching Motors

Current Monitoring Relays

Overview

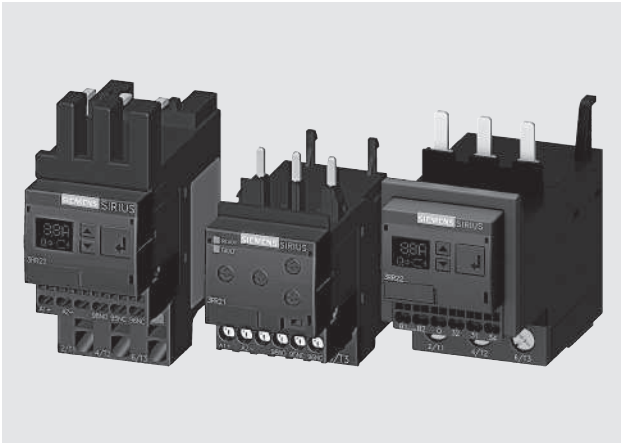

SIRIUS 3RR2242, 3RR2142 and 3RR2243 current monitoring relays

The SIRIUS 3RR2 current monitoring relays are suitable for the load monitoring of motors or other loads. In two or three phases they monitor the rms value of AC currents for overshooting or undershooting of set threshold values.

Whereas apparent current monitoring is used above all in connection with the rated torque or in case of overload, the active current monitoring option can be used to observe and evaluate the load factor over a motor's entire torque range.

The 3RR2 current monitoring relays can be integrated directly in the feeder by mounting onto the 3RT2 contactor; separate wiring of the main circuit is therefore superfluous. No separate transformers are required.

For a line-oriented configuration or simultaneous use of an overload relay, terminal supports for stand-alone installation are available for separate standard rail mounting.

Versions

Basic versions

The basic versions with two-phase apparent current monitoring, a CO contact output and analog adjustability provide a high level of monitoring reliability especially in the rated and overload range.

Standard versions

The standard versions monitor the current in three phases with selectable active current monitoring. They have additional diagnostics options such as residual current monitoring and phase sequence monitoring, and they are also suitable for monitoring motors below the rated torque. These devices have an additional independent semiconductor output, an actual value indicator, and are digitally adjustable.

Both versions are available optionally with screw or spring-type terminals, in each case for sizes S00 and S0. With variants of size S2 the main current paths always have screw terminals; the control current side can have screw or spring-type terminals.

Note:

In addition to the features of the standard versions, 3RR24 monitoring relays for mounting onto 3RT2 contactors for IO-Link also offer the possibility of transmitting the measured values and diagnostics data to a controller via an IO-Link. Furthermore, the devices can be parameterized on the devices themselves or via IO-Link.

Benefits

- Can be mounted directly on 3RT2 contactors and 3RA23 reversing contactor assemblies, in other words, there is no need for additional wiring in the main circuit
- Optimally coordinated with the technical characteristics of the 3RT2 contactors
- No separate current transformer required
- Versions with wide voltage supply range
- Variably adjustable to overshoot, undershoot or range monitoring
- Freely configurable delay times and RESET response
- Display of ACTUAL value and status messages
- All versions with removable control current terminals
- All versions with screw terminals or spring-type terminals
- Simple determination of the threshold values through direct reference to actually measured values for setpoint loading
- Range monitoring and selectable active current measurement mean that only one device for monitoring a motor is required along the entire torque curve
- In addition to current monitoring it is also possible to monitor for broken cables, phase failure, phase sequence, residual current and motor blocking

Application

- Monitoring of current overshoot and undershoot
- Monitoring of broken conductors
- Monitoring of no-load operation and load shedding, e.g. in the event of a torn V-belt or no-load operation of a pump
- Monitoring of overload, e.g. on conveyor belts or cranes due to an excessive load
- Monitoring the functionality of electrical loads such as heaters
- Monitoring of wrong phase sequence on mobile equipment such as compressors or cranes
- Monitoring of high-impedance faults to ground, e.g. caused by damaged insulation or moisture

Contactors Assemblies for Switching Motors

Current Monitoring Relays

Technical specifications

Function charts of 3RR214-..A.30 basic variants, analog dial adjustable

Closed-circuit principle upon application of the control supply voltage

Current overshoot

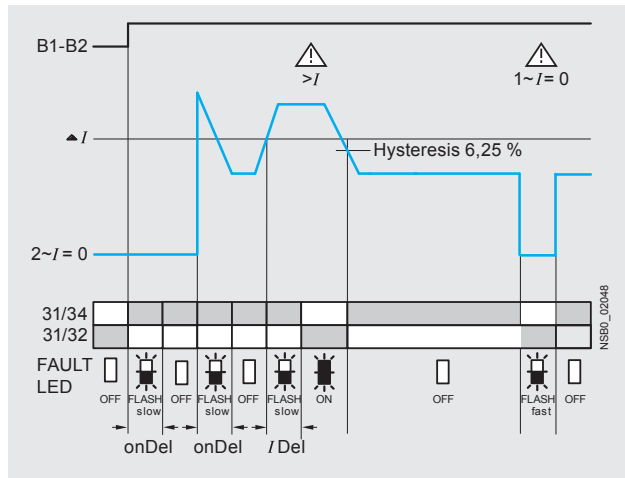

Range monitoring

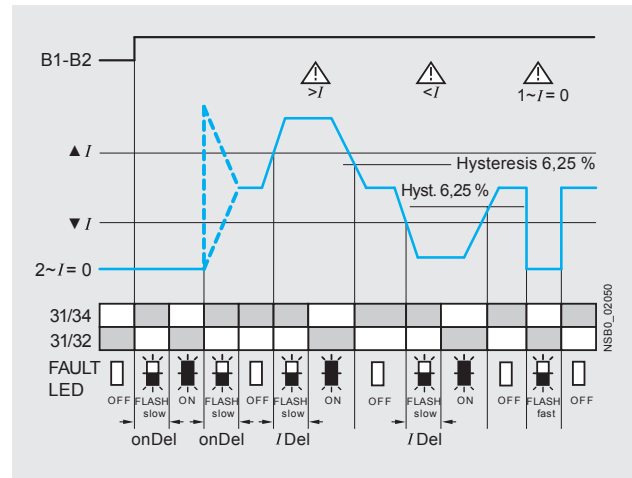

Current undershoot

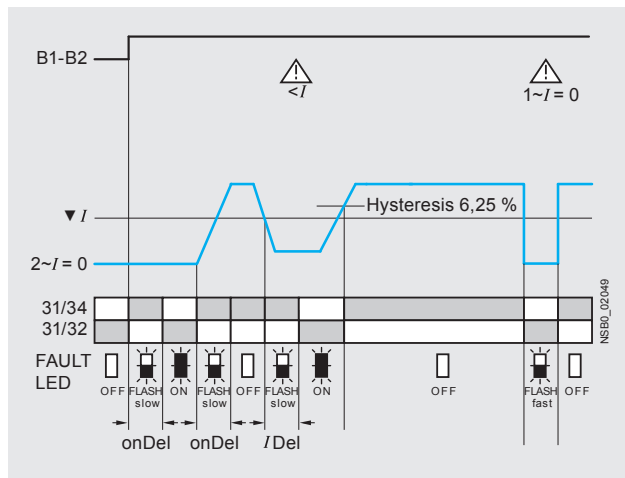

Circuit diagrams

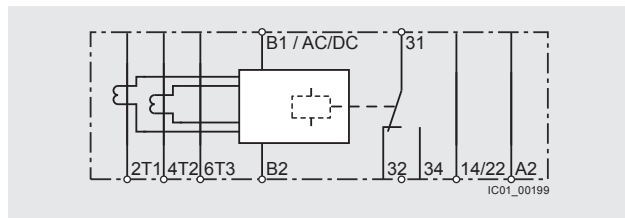

3RR2141-1A.30

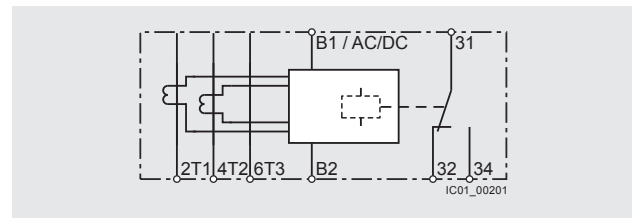

3RR2141-2A.30, 3RR2142-..A.30, 3RR2143-..A.30

Note:

It is not necessary to protect the measuring circuit for device protection. The protective device for line protection depends on the cross-section used.

Contactor Assemblies for Switching Motors

Current Monitoring Relays

2 CONTACTORS AND ASSEMBLIES

Function charts of 3RR224-..F.30 standard versions, digitally adjustable

With the closed-circuit principle selected upon application of the control supply voltage

Current overshoot

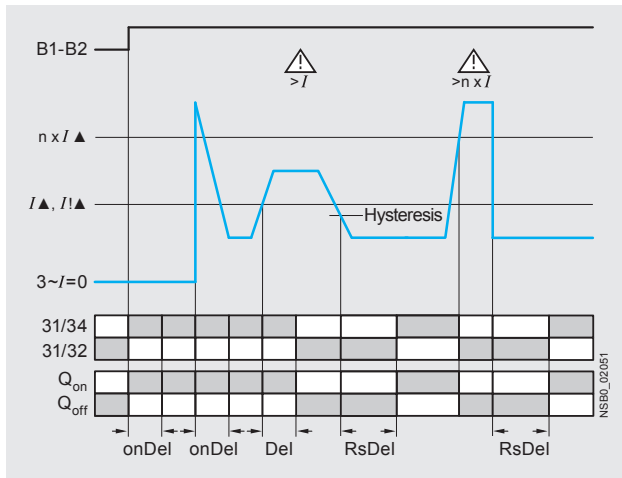

Range monitoring

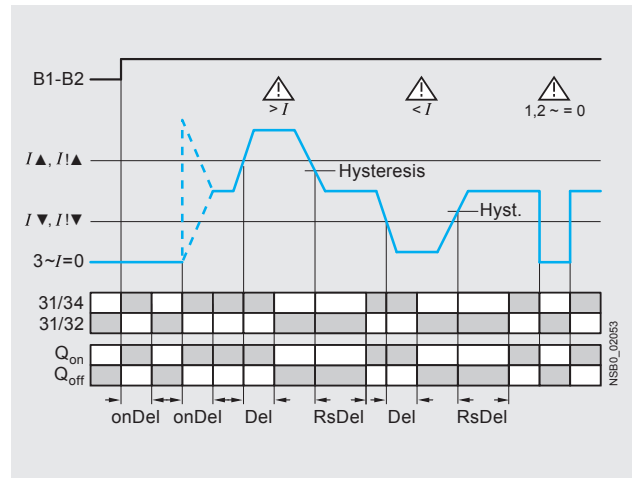

Current undershoot with residual current monitoring

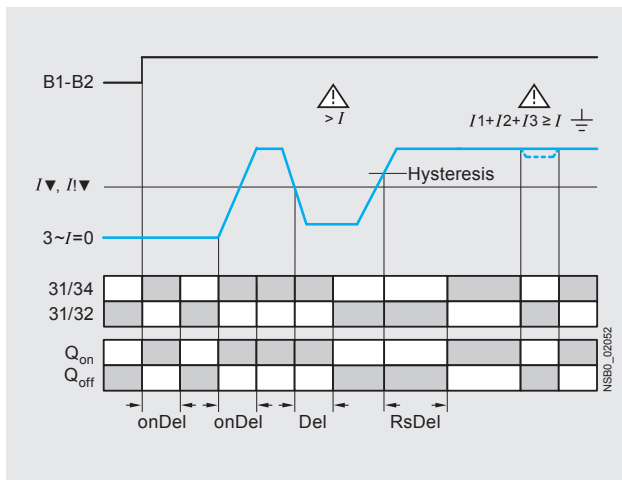

Phase sequence monitoring

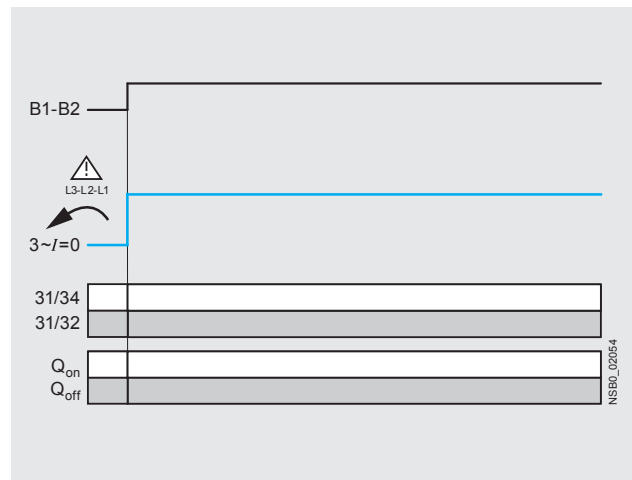

Circuit diagrams

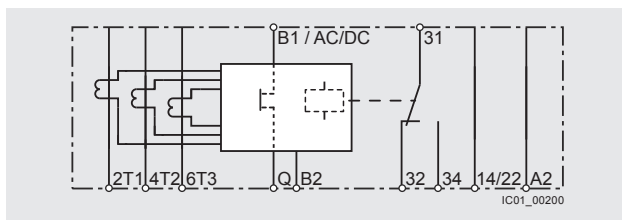

3RR2241-1F.30

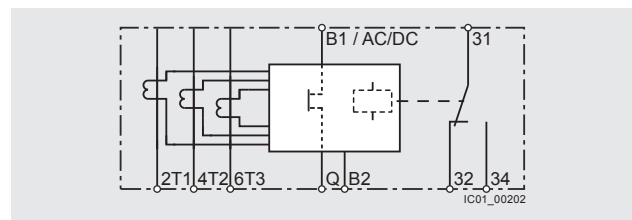

3RR2241-2F.30, 3RR2242-F.30, 3RR2243-F.30

Note:

It is not necessary to protect the measuring circuit for device protection. The protective device for line protection depends on the cross-section used.

Contactor Assemblies for Switching Motors

Current Monitoring Relays

Selection and ordering data

SIRIUS 3RR21/3RR22 current monitoring relays

- For load monitoring of motors or other loads
- Multi-phase monitoring of undercurrent and overcurrent
- Starting and tripping delay can be adjusted separately
- Tripping delay 0 to 30 s
- Auto or Manual RESET



3RR2141-1AW30

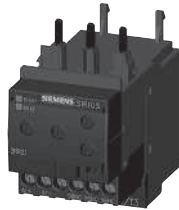

3RR2142-1AW30



3RR2241-1FW30



3RR2242-1FW30



3RR2141-2AA30



3RR2243-3FW30

Size	Measuring range	Hysteresis	Control supply voltage U_s	Screw terminals	Spring-type terminals
A	A	A	V	Order No.	Order No.

Basic versions

- Analogically adjustable
- Closed-circuit principle
- 1 CO contact
- 2-phase current monitoring
- Apparent current monitoring
- Start-up delay 0 ... 60 s

S00	1.6 ... 16	6.25 % of threshold value	24 AC/DC 24 ... 240 AC/DC	3RR2141-1AA30 3RR2141-1AW30	3RR2141-2AA30 3RR2141-2AW30
S0	4 ... 40	6.25 % of threshold value	24 AC/DC 24 ... 240 AC/DC	3RR2142-1AA30 3RR2142-1AW30	3RR2142-2AA30 3RR2142-2AW30
S2	8 ... 80	6.25 % of threshold value	24 AC/DC 24 ... 240 AC/DC	3RR2143-1AA30 3RR2143-1AW30	3RR2143-3AA30 3RR2143-3AW30

Standard versions

- Digitally adjustable
- LC display
- Open or closed-circuit principle
- 1 CO contact
- 1 semiconductor output
- 3-phase current monitoring
- Active current or apparent current monitoring
- Phase sequence monitoring
- Residual current monitoring
- Blocking current monitoring
- Reclosing delay time 0 ... 300 min
- Start-up delay 0 ... 99 s
- Separate settings for warning and alarm thresholds

S00	1.6 ... 16	0.1 ... 3	24 AC/DC 24 ... 240 AC/DC	3RR2241-1FA30 3RR2241-1FW30	3RR2241-2FA30 3RR2241-2FW30
S0	4 ... 40	0.1 ... 8	24 AC/DC 24 ... 240 AC/DC	3RR2242-1FA30 3RR2242-1FW30	3RR2242-2FA30 3RR2242-2FW30
S2	8 ... 80	0.2 ... 16	24 AC/DC 24 ... 240 AC/DC	3RR2243-1FA30 3RR2243-1FW30	3RR2243-3FA30 3RR2243-3FW30

Contactors and Contactor Assemblies for Switching Motors

Current Monitoring Relays with IO-Link

Overview

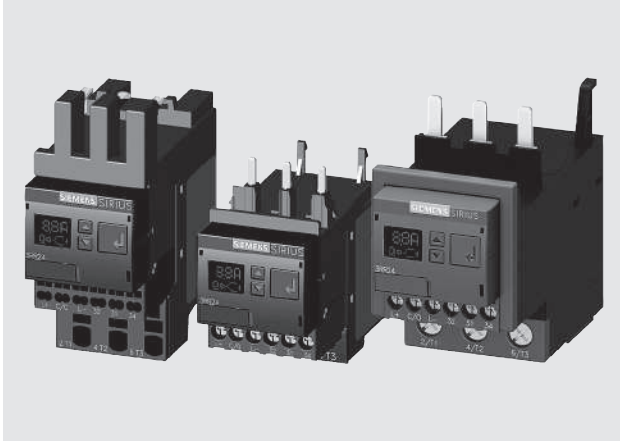

SIRIUS 3RR2441, 3RR2442 and 3RR2443 current monitoring relays

The SIRIUS 3RR24 current monitoring relays for IO-Link are suitable for the load monitoring of motors or other loads. In three phases they monitor the rms value of AC currents for overshooting or undershooting of set threshold values.

Whereas apparent current monitoring is used above all in connection with the rated torque or in case of overload, the active current monitoring option, which is also selectable, can be used to observe and evaluate the load factor over a motor's entire torque range.

The 3RR24 current monitoring relays for IO-Link can be integrated directly in the feeder by mounting onto the 3RT2 contactor; separate wiring of the main circuit is therefore superfluous. No separate transformers are required.

For a line-oriented configuration or simultaneous use of an overload relay, terminal supports for stand-alone installation are available for separate standard rail mounting.

The SIRIUS 3RR24 current monitoring relays for IO-Link also offer many other options based upon the monitoring functions of the conventional SIRIUS 3RR2 monitoring relays:

- Measured value transmission to a controller, including resolution and unit, may be parameterizable as to which value is cyclically transmitted
- Transmission of alarm flags to a controller
- Full diagnosis capability by inquiry as to the cause of the fault in the diagnosis data record
- Remote parameterization is also possible, in addition to or instead of local parameterization

- Rapid parameterization of the same devices by duplication of the parameterization in the controller
- Parameter transmission by upload to a controller by IO-Link call or by parameter server (if IO-Link master from IO-Link Specification V 1.1 and higher is used)
- Consistent central data storage in the event of parameter change locally or via a controller
- Automatic reparameterizing when devices are exchanged
- Blocking of local parameterization via IO-Link possible
- Faults are saved in parameterizable and non-volatile fashion to prevent an automatic start up after voltage failure and to make sure diagnostics data is not lost
- By integration into the automation level the option exists of parameterizing the monitoring relay at any time via a display unit or displaying the measured values in a control room or locally at the machine/control cabinet

Even without communication via IO-Link the devices continue to function fully autonomously:

- Parameterization can take place locally at the device, independently of a controller
- In the event of failure or before the controller becomes available the monitoring relays work as long as the control supply voltage (24 V DC) is present
- If the monitoring relays are operated without the controller, the 3RR24 monitoring relays for IO-Link have, thanks to the integrated SIO mode, an additional semiconductor output, which switches when the adjustable warning threshold is exceeded

Thanks to the combination of autonomous monitoring relay function and integrated IO-Link communication, redundant sensors and/or analog signal converters – which previously took over the transmission of measured values to a controller, leading to considerable extra cost and wiring outlay – are no longer needed.

Because the output relays are still present, the monitoring relays increase the functional reliability of the system, since only the controller can fulfill the control tasks if the current measured values are available, whereas the output relays can also be used for the disconnection of the system if limit values that cannot be reached during operation are exceeded.

For further information on the IO-Link communication system, see [Chapter 14](#).

Contactors and Contactor Assemblies for Switching Motors

Current Monitoring Relays with IO-Link

Benefits

- Can be mounted directly on 3RT2 contactors and 3RA23 reversing contactor assemblies, in other words, there is no need for additional wiring in the main circuit
- Optimally coordinated with the technical characteristics of the 3RT2 contactors
- No separate current transformer required
- Variably adjustable to overshoot, undershoot or range monitoring
- Freely configurable delay times and RESET response
- Display of ACTUAL value and status messages
- All versions with removable control current terminals
- All versions with screw or spring-type terminals
- Simple determination of the threshold values through direct reference to actually measured values for setpoint loading
- Range monitoring and selectable active current measurement mean that only one device for monitoring a motor is required along the entire torque curve
- In addition to current monitoring it is also possible to monitor for current unbalance, broken cables, phase failure, phase sequence, residual current and motor blocking
- Integrated counter for operating cycles and operating hours to support requirements-based maintenance of the monitored machine or application
- Simple cyclical transmission of the current measured values, relay switching states and events to a controller
- Remote parameterization
- Automatic reparameterizing when devices are exchanged
- Simple duplication of identical or similar parameterizations
- Reduction of control current wiring
- Elimination of testing costs and wiring errors
- Reduction of configuration work
- Integration in TIA means clear diagnostics if a fault occurs
- Cost saving and space saving in control cabinet due to the elimination of AI and IO modules as well as analog signal converters and duplicated sensors

Application

- Monitoring of current overshoot and undershoot
- Monitoring of broken conductors
- Monitoring of no-load operation and load shedding, e.g. in the event of a torn V-belt or no-load operation of a pump
- Monitoring of overload, e.g. on pumps due to a dirty filter system
- Monitoring the functionality of electrical loads such as heaters
- Monitoring of wrong phase sequence on mobile equipment such as compressors or cranes
- Monitoring of high-impedance faults to ground, e.g. caused by damaged insulation or moisture

The use of SIRIUS monitoring relays for IO-Link is particularly recommended for machines and plant in which these relays, in addition to their monitoring function, are to be connected to the automation level for the rapid, simple and fault-free provision of the current measured values and/or for remote parameterization.

The monitoring relays can either relieve the controller of monitoring tasks or, as a second monitoring entity in parallel to and independent of the controller, increase the reliability in the process or in the system. In addition, the elimination of AI and IO modules allows the width of the controller to be reduced despite significantly expanded functionality.

Contactor Assemblies for Switching Motors

Current Monitoring Relays with IO-Link

Technical specifications

Function charts for 3RR24 for IO-Link, digitally adjustable

With the closed-circuit principle selected upon application of the control supply voltage

Current overshoot

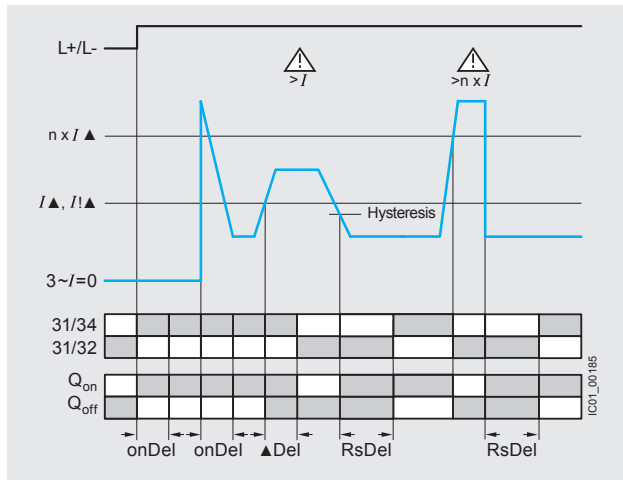

Range monitoring

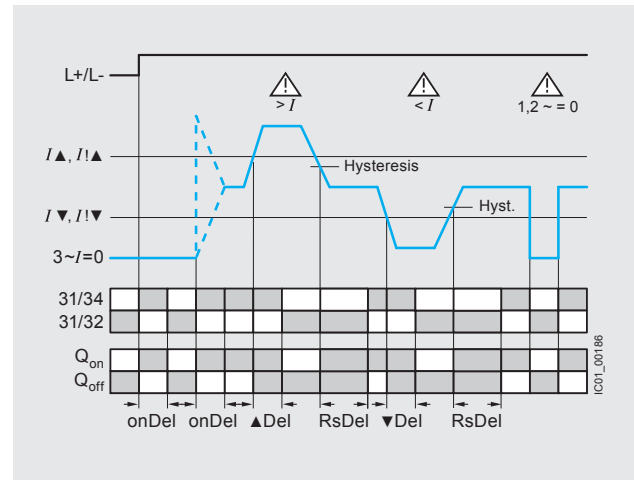

Current undershoot with residual current monitoring

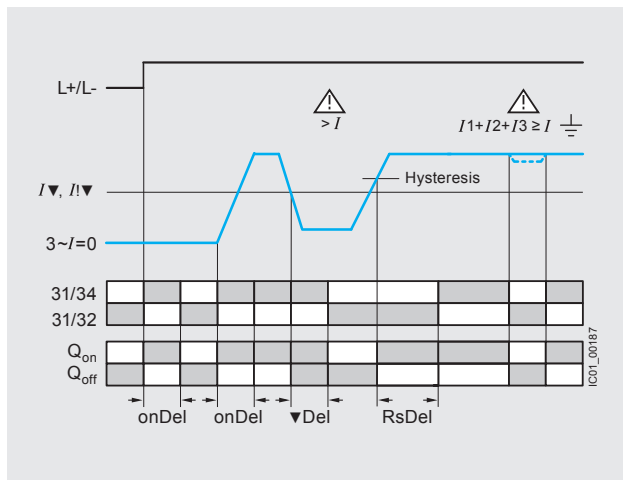

Phase sequence monitoring

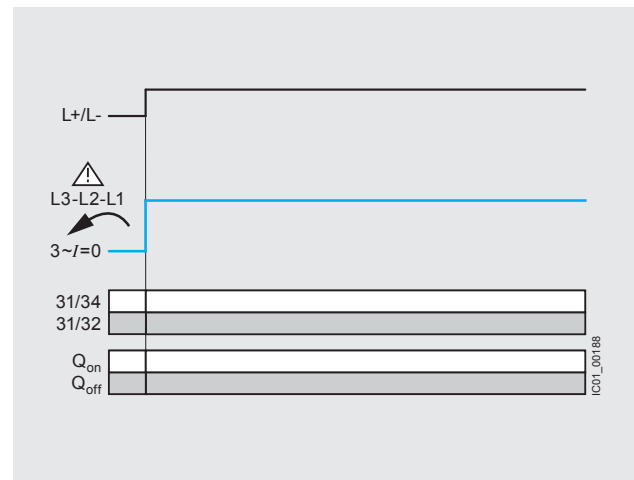

Circuit diagrams

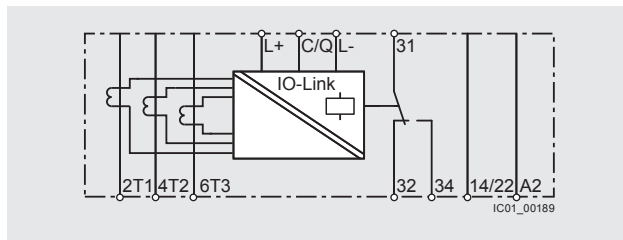

3RR2441-1AA40

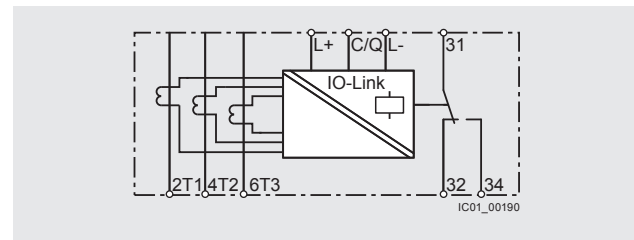

3RR2441-2AA40, 3RR2442-AA40, 3RR2443-AA40

Note:

It is not necessary to protect the measuring circuit for device protection. The protective device for line protection depends on the cross-section used.

Contactors and Contactor Assemblies for Switching Motors

Current Monitoring Relays

Selection and ordering data

SIRIUS 3RR24 current monitoring relays for IO-Link

- For load monitoring of motors or other loads
- Multi-phase monitoring of undercurrent and overcurrent
- Starting and tripping delay can be adjusted separately
- Tripping delay 0 to 999.9 s
- Auto or Manual RESET



3RR2441-1AA40



3RR2442-1AA40



3RR2441-2AA40



3RR2442-2AA40



3RR2443-1AA40



3RR2443-3AA40

Size	Measuring range	Hysteresis	Control supply voltage U_s	Screw terminals	Spring-type terminals
A	A	V		Order No.	Order No.
<ul style="list-style-type: none"> • Digitally adjustable • LC display • Open or closed-circuit principle • 1 CO contact • 1 semiconductor output (in SIO mode) • 3-phase current monitoring • Active current or apparent current monitoring • Current unbalance monitoring • Phase sequence monitoring • Residual current monitoring • Blocking current monitoring • Operating hours counter • Operating cycles counter • Reclosing delay time 0 ... 300 min • Start-up delay 0 ... 999.9 s • Separate settings for warning and alarm thresholds 					
S00	1.6 ... 16	0.1 ... 3	24 DC	3RR2441-1AA40	3RR2441-2AA40
S0	4 ... 40	0.1 ... 8	24 DC	3RR2442-1AA40	3RR2442-2AA40
S2	8 ... 80	0.2 ... 16	24 DC	3RR2443-1AA40	3RR2443-3AA40

Contactors Assemblies for Switching Motors

Current Monitoring Relay Accessories

Accessories

Use	Version	Size	Order No.	Standard Pack Quantity
-----	---------	------	-----------	------------------------

Terminal supports for stand-alone installation¹⁾



3RU2916-3AA01

For 3RR21, 3RR22, 3RR24
 For separate mounting of the overload relays or monitoring relays; screw and snap-on mounting onto TH 35 standard mounting rail according to IEC 60715

- Screw connection

S00
 S0
 S2

Screw terminals



3RU2916-3AA01
 3RU2926-3AA01
 3RU2936-3AA01

1 unit
 1 unit
 1 unit



3RU2926-3AC01

- Spring-type connection

S00
 S0

Spring-type terminals



3RU2916-3AC01
 3RU2926-3AC01

1 unit
 1 unit

Blank labels

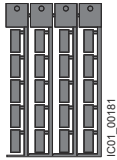

3RT2900-1SB20

For 3RR21, 3RR22, 3RR24
Unit labeling plates
 For SIRIUS devices
 20 mm x 7 mm, titanium gray

3RT2900-1SB20

340 units

Sealable covers



3RR2940

For 3RR21, 3RR22, 3RR24
Sealable covers
 For securing against unintentional or unauthorized adjustment of settings

3RR2940

5 units

For 3RR21
Sealing foil
 For securing against unauthorized adjustment of setting knobs

3TK2820-0AA00

1 unit

Tools for opening spring-type terminals



3RA2908-1A

For auxiliary circuit connections
Screwdrivers
 For all SIRIUS devices with spring-type terminals; 3.0 mm x 0.5 mm; length approx. 200 mm, titanium gray/black, partially insulated

Spring-type terminals



3RA2908-1A

1 unit

¹⁾ The accessories are identical to those of the 3RU21 thermal overload relays and the 3RB3 electronic overload relays, see Chapter 3 "Overload Relays".

Contactors Assemblies for Switching Motors

NEMA 1 Enclosure

Selection and ordering data

- * NEMA Type 1 Enclosures
- * Lift off cover
- * Accepts SIRIUS power control components
 - * Non-reversing contactors
 - * Reversing contactors
 - * Starters with thermal overload relays
 - * Starters with solid-state overload relays

Application

The 49EC14*B separate enclosures are designed for field assembly of a wide range of Siemens SIRIUS open style control components and field modification kits as listed in the charts below. Note that certain components require the addition of a DIN Rail kit for proper mounting in the enclosure.



NEMA 1 Enclosures

Max. current A	Contactor		Max. current A	Overload relay		Required DIN rail kit Order No.	NEMA 1 Enclosure Order No.
	Non-reversing	Reversing		Thermal	Solid-state		
16	3RT201	3RA231	16	3RU2116	3RB3016	MTR5	49EC14EB110705R
38	3RT202	3RA232	40	3RU2126	3RB3026	MTR5	
50	3RT203		50	3RU2136	3RB3036	—	49EC14GB140807R
12		3RA231	12	3RU2116	3RB3016	MTR5	
25		3RA232	25	3RU2126	3RB3036	MTR5	
50		3RA233	50	3RU2136	3RB3036	—	
95	3RT204		100	3RU2146	3RB3046	—	49EC14IB201208R
95		3RA234	100	3RU2146	3RB3046	—	



Accessories for NEMA 1 Enclosures

Accessory type	Description	Legends	Voltage	Order No.
Push buttons	Momentary	Start - Stop	none	49SDPB5
	Monentary	Reset (blue)		49MBRS
Selector Switch	2 position	Off - On	none	49SDSB4
	3 position	Hand - Off - Auto	none	49SDSB1
		For - Off - Rev		49SDSB2
	High - Off - Low		49SDSB3	
Pilot light	Light module and lens color: RED, GREEN, and AMBER"	ON, RUN, OFF, OL TRIPPED	24 to 240 AC DC	49SDLBU
			277V AC	49SDLBL
	Light module and lens color: RED, RED	REV - FOR or HIGH - LOW	24 to 240 AC DC	49SDLB7RU
			277V AC	49SDLB7RL
Light module and lens color: GREEN, GREEN	REV - FOR or HIGH - LOW	24 to 240 AC DC	49SDLB7GU	
		277V AC	49SDLB7GL	

For 3RT contactors, see page 2/8.
 For 3RA reversing, see pages 2/37.
 For thermal overloads, see page 3/10.
 For solidstate overloads, see pages 3/22.
 For enclosure dimensions, see figures 1, 2, and 3 on page 9/150.

3RT Contactors

Spare parts for 3RT2 contactors

Selection and ordering data

For screw, spring-type and ring lug terminal connection



3RT29 24-5A.01

For contactors		Rated control supply voltage U_s			Order No.	Weight approx. kg	
Size	Type	50 Hz V	50/60 Hz V	60 Hz V			
Solenoid coils • AC operation							
S0	3RT20 23,	24	--	--	3RT29 24-5AB01	0.100	
	3RT20 24,	42	--	--	3RT29 24-5AD01	0.100	
	3RT20 25	48	--	--	3RT29 24-5AH01	0.100	
		110	--	--	3RT29 24-5AF01	0.100	
		230	--	--	3RT29 24-5AP01	0.100	
		400	--	--	3RT29 24-5AV01	0.100	
		--	24	--	3RT29 24-5AC21	0.100	
		--	42	--	3RT29 24-5AD21	0.100	
		--	48	--	3RT29 24-5AH21	0.100	
		--	110	--	3RT29 24-5AG21	0.100	
		--	220	--	3RT29 24-5AN21	0.100	
		--	230	--	3RT29 24-5AL21	0.100	
		110	--	120	3RT29 24-5AK61	0.100	
		220	--	240	3RT29 24-5AP61	0.100	
		--	100	110	3RT29 24-5AG61	0.100	
		--	200	220	3RT29 24-5AN61	0.100	
		--	400	440	3RT29 24-5AR61	0.100	
	S0	3RT20 26,	24	--	--	3RT29 26-5AB01	0.100
		3RT20 27,	42	--	--	3RT29 26-5AD01	0.100
		3RT20 28	48	--	--	3RT29 26-5AH01	0.100
3RT23 25,		110	--	--	3RT29 26-5AF01	0.100	
3RT23 26,		230	--	--	3RT29 26-5AP01	0.100	
3RT23 27		400	--	--	3RT29 26-5AV01	0.100	
3RT25 26		--	24	--	3RT29 26-5AC21	0.100	
		--	42	--	3RT29 26-5AD21	0.100	
		--	48	--	3RT29 26-5AH21	0.100	
		--	110	--	3RT29 26-5AG21	0.100	
		--	208	--	3RT29 26-5AM21	0.100	
		--	220	--	3RT29 26-5AN21	0.100	
		--	230	--	3RT29 26-5AL21	0.100	
		110	--	120	3RT29 26-5AK61	0.100	
		220	--	240	3RT29 26-5AP61	0.100	
		--	100	110	3RT29 26-5AG61	0.100	
		--	200	220	3RT29 26-5AN61	0.100	
		--	400	440	3RT29 26-5AR61	0.100	
		500	--	--	3RT29 26-5AQ21	0.100	
			277	--	3RT29 26-5AU61	0.100	
		480	--	3RT29 26-5AV61	0.100		
		600	--	3RT29 26-5AT61	0.100		

Note:

Contactors with AC and AC/DC coils have different depths. It is only possible to replace the coils on AC contactors with AC coils, and on AC/DC contactors with AC/DC coils. It is not possible to replace the coils on DC contactors in the S0 frame.

Contactors Assemblies for Switching Motors

Spare parts for 3RT2 contactors

Screw terminals and spring-type terminals

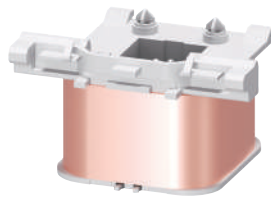

3RT2934-5A.01



3RT2934-5N.31

For contactors Type	Rated control supply voltage U_s				SD	Article No.	Price per PU	PU (UNIT, SET, M)	PS*	PG
	50 Hz	50/60 Hz	60 Hz	DC						
	V	V	V		d					
Solenoid coils · AC operation										
Size S2										
3RT203.-.A,	24	--	--	--	5	3RT2934-5AB01		1	1 unit	41B
3RT233.-.A,	42	--	--	--	5	3RT2934-5AD01		1	1 unit	41B
3RT253.-.A	48	--	--	--	5	3RT2934-5AH01		1	1 unit	41B
	110	--	--	--	5	3RT2934-5AF01		1	1 unit	41B
	230	--	--	--	5	3RT2934-5AP01		1	1 unit	41B
	400	--	--	--	5	3RT2934-5AV01		1	1 unit	41B
	--	24	--	--	5	3RT2934-5AC21		1	1 unit	41B
	--	42	--	--	5	3RT2934-5AD21		1	1 unit	41B
	--	48	--	--	5	3RT2934-5AH21		1	1 unit	41B
	--	110	--	--	5	3RT2934-5AG21		1	1 unit	41B
	--	220	--	--	5	3RT2934-5AN21		1	1 unit	41B
	--	230	--	--	5	3RT2934-5AL21		1	1 unit	41B
	110	--	120	--	5	3RT2934-5AK61		1	1 unit	41B
	220	--	240	--	5	3RT2934-5AP61		1	1 unit	41B
	--	--	480	--	5	3RT2934-5AV61		1	1 unit	41B
	--	--	600	--	5	3RT2934-5AT61		1	1 unit	41B
	--	100	110	--	5	3RT2934-5AG61		1	1 unit	41B
	--	200	220	--	5	3RT2934-5AN61		1	1 unit	41B
	--	400	440	--	5	3RT2934-5AR61		1	1 unit	41B
Size S3 NEW										
3RT2.4.-.A	24	--	--	--	X	3RT2944-5AB01		1	1 unit	41B
	42	--	--	--	X	3RT2944-5AD01		1	1 unit	41B
	48	--	--	--	X	3RT2944-5AH01		1	1 unit	41B
	110	--	--	--	X	3RT2944-5AF01		1	1 unit	41B
	230	--	--	--	X	3RT2944-5AP01		1	1 unit	41B
	400	--	--	--	X	3RT2944-5AV01		1	1 unit	41B
	--	24	--	--	X	3RT2944-5AC21		1	1 unit	41B
	--	42	--	--	X	3RT2944-5AD21		1	1 unit	41B
	--	48	--	--	X	3RT2944-5AH21		1	1 unit	41B
	--	110	--	--	X	3RT2944-5AG21		1	1 unit	41B
	--	220	--	--	X	3RT2944-5AN21		1	1 unit	41B
	--	230	--	--	X	3RT2944-5AL21		1	1 unit	41B
	110	--	120	--	X	3RT2944-5AK61		1	1 unit	41B
	220	--	240	--	X	3RT2944-5AP61		1	1 unit	41B
	--	--	480	--	X	3RT2944-5AV61		1	1 unit	41B
	--	--	600	--	X	3RT2944-5AT61		1	1 unit	41B
	--	100	110	--	X	3RT2944-5AG61		1	1 unit	41B
	--	200	220	--	X	3RT2944-5AN61		1	1 unit	41B
	--	400	440	--	X	3RT2944-5AR61		1	1 unit	41B
Solenoid coils · AC/DC operation, with varistor										
Size S2										
3RT203.-.A,	--	20 ... 33	--	20 ... 33	5	3RT2934-5NB31		1	1 unit	41B
3RT233.-.A,	--	30 ... 42	--	30 ... 42	5	3RT2934-5ND31		1	1 unit	41B
3RT253.-.A	--	48 ... 80	--	48 ... 80	5	3RT2934-5NE31		1	1 unit	41B
	--	83 ... 155	--	83 ... 155	5	3RT2934-5NF31		1	1 unit	41B
	--	175 ... 280	--	175 ... 280	5	3RT2934-5NP31		1	1 unit	41B
Size S3 NEW										
3RT2.4.-.A	--	20 ... 33	--	20 ... 33	X	3RT2944-5NB31		1	1 unit	41B
	--	30 ... 42	--	30 ... 42	X	3RT2944-5ND31		1	1 unit	41B
	--	48 ... 80	--	48 ... 80	X	3RT2944-5NE31		1	1 unit	41B
	--	83 ... 155	--	83 ... 155	X	3RT2944-5NF31		1	1 unit	41B
	--	175 ... 280	--	175 ... 280	X	3RT2944-5NP31		1	1 unit	41B

Note:

It is only possible to replace the coils on AC contactors with AC coils, and on AC/DC contactors with AC/DC coils.

3RT Contactors

Spare parts for 3RT1 contactors

CONTACTORS AND ASSEMBLIES 2

Selection and ordering data

For contactor	Rated control supply voltage U_s	Screw connection	Spring-type connection	Weight approx.
		Order No.	Order No.	
Size	Type			kg

Coils - AC operation





3RT19 34-5A . 01



Size	Type	Rated control supply voltage U_s	Screw connection	Spring-type connection	Weight approx.			
S2	3RT10 33 3RT10 34	24 V, 50 Hz	3RT19 34-5AB01	3RT19 34-5AB02	0.088			
		42 V, 50 Hz	3RT19 34-5AD01	3RT19 34-5AD02				
		48 V, 50 Hz	3RT19 34-5AH01	3RT19 34-5AH02				
		110 V, 50 Hz	3RT19 34-5AF01	3RT19 34-5AF02				
		230 V, 50 Hz	3RT19 34-5AP01	3RT19 34-5AP02				
		400 V, 50 Hz	3RT19 34-5AV01	3RT19 34-5AV02				
		42 V, 50/60 Hz	3RT19 34-5AD21	3RT19 34-5AD22				
		48 V, 50/60 Hz	3RT19 34-5AH21	3RT19 34-5AH22				
		24 V, 50/60 Hz	3RT19 34-5AC21	3RT19 34-5AC22				
		110 V, 50/60 Hz	3RT19 34-5AG21	3RT19 34-5AG22				
		208 V, 50/60 Hz	3RT19 34-5AM21	3RT19 34-5AM22				
		220 V, 50/60 Hz	3RT19 34-5AN21	3RT19 34-5AN22				
		230 V, 50/60 Hz	3RT19 34-5AL21	3RT19 34-5AL22				
		110 V, 50 Hz/120 V, 60 Hz	3RT19 34-5AK61	3RT19 34-5AK62				
		220 V, 50 Hz/240 V, 60 Hz	3RT19 34-5AP61	3RT19 34-5AP62				
		277 V, 60 Hz	3RT19 34-5AU61	3RT19 34-5AU62				
		480 V, 60 Hz	3RT19 34-5AV61	3RT19 34-5AV62				
		600 V, 60 Hz	3RT19 34-5AT61	3RT19 34-5AT62				
		100 V, 50/60 Hz/110 V, 60 Hz	3RT19 34-5AG61	3RT19 34-5AG62				
		200 V, 50/60 Hz/220 V, 60 Hz	3RT19 34-5AN61	3RT19 34-5AN62				
		400 V, 50/60 Hz/440 V, 60 Hz	3RT19 34-5AR61	3RT19 34-5AR62				
		3RT10 35, 3RT10 36, 3RT13 3., 3RT15 3.		24 V, 50 Hz		3RT19 35-5AB01	3RT19 35-5AB02	0.088
				42 V, 50 Hz		3RT19 35-5AD01	3RT19 35-5AD02	
				48 V, 50 Hz		3RT19 35-5AH01	3RT19 35-5AH02	
110 V, 50 Hz	3RT19 35-5AF01			3RT19 35-5AF02				
230 V, 50 Hz	3RT19 35-5AP01			3RT19 35-5AP02				
400 V, 50 Hz	3RT19 35-5AV01			3RT19 35-5AV02				
24 V, 50/60 Hz	3RT19 35-5AC21			3RT19 35-5AC22				
42 V, 50/60 Hz	3RT19 35-5AD21			3RT19 35-5AD22				
48 V, 50/60 Hz	3RT19 35-5AH21			3RT19 35-5AH22				
110 V, 50/60 Hz	3RT19 35-5AG21			3RT19 35-5AG22				
208 V, 50/60 Hz	3RT19 35-5AM21			3RT19 35-5AM22				
220 V, 50/60 Hz	3RT19 35-5AN21			3RT19 35-5AN22				
230 V, 50/60 Hz	3RT19 35-5AL21			3RT19 35-5AL22				
110 V, 50 Hz/120 V, 60 Hz	3RT19 35-5AK61			3RT19 35-5AK62				
220 V, 50 Hz/240 V, 60 Hz	3RT19 35-5AP61			3RT19 35-5AP62				
277 V, 60 Hz	3RT19 35-5AU61			3RT19 35-5AU62				
480 V, 60 Hz	3RT19 35-5AV61			3RT19 35-5AV62				
600 V, 60 Hz	3RT19 35-5AT61			3RT19 35-5AT62				
100 V, 50/60 Hz/110 V, 60 Hz	3RT19 35-5AG61			3RT19 35-5AG62				
200 V, 50/60 Hz/220 V, 60 Hz	3RT19 35-5AN61			3RT19 35-5AN62				
400 V, 50/60 Hz/440 V, 60 Hz	3RT19 35-5AR61			3RT19 35-5AR62				

3RT Contactors

Spare parts for 3RT1 contactors

Selection and ordering data																				
For contactor		Rated control supply voltage U_s		Screw connection			Spring-type connection			Weight approx.										
Size		Type		Order No.			Order No.			kg										
Coils · AC operation																				
	3RT19 44-5A.01	S3	3RT10 44	24 V, 50 Hz	3RT19 44-5AB01	3RT19 44-5AB02	0.130													
				42 V, 50 Hz							3RT19 44-5AD01	3RT19 44-5AD02								
				48 V, 50 Hz							3RT19 44-5AH01	3RT19 44-5AH02								
				110 V, 50 Hz							3RT19 44-5AF01	3RT19 44-5AF02								
				230 V, 50 Hz							3RT19 44-5AP01	3RT19 44-5AP02								
				400 V, 50 Hz							3RT19 44-5AV01	3RT19 44-5AV02								
				24 V, 50/60 Hz							3RT19 44-5AC21	3RT19 44-5AC22								
				42 V, 50/60 Hz							3RT19 44-5AD21	3RT19 44-5AD22								
				48 V, 50/60 Hz							3RT19 44-5AH21	3RT19 44-5AH22								
				110 V, 50/60 Hz							3RT19 44-5AG21	3RT19 44-5AG22								
208 V, 50/60 Hz	3RT19 44-5AM21	3RT19 44-5AM22																		
220 V, 50/60 Hz	3RT19 44-5AN21	3RT19 44-5AN22																		
230 V, 50/60 Hz	3RT19 44-5AL21	3RT19 44-5AL22																		
110 V, 50 Hz/120 V, 60 Hz	3RT19 44-5AK61	3RT19 44-5AK62																		
220 V, 50 Hz/240 V, 60 Hz	3RT19 44-5AP61	3RT19 44-5AP62																		
277 V, 60 Hz	3RT19 44-5AU61	3RT19 44-5AU62																		
480 V, 60 Hz	3RT19 44-5AV61	3RT19 44-5AV62																		
600 V, 60 Hz	3RT19 44-5AT61	3RT19 44-5AT62																		
100 V, 50/60 Hz/110 V, 60 Hz	3RT19 44-5AG61	3RT19 44-5AG62																		
200 V, 50/60 Hz/220 V, 60 Hz	3RT19 44-5AN61	3RT19 44-5AN62																		
400 V, 50/60 Hz/440 V, 60 Hz	3RT19 44-5AR61	3RT19 44-5AR62																		
	3RT19 45-5A.01	S3	3RT10 45, 3RT10 46, 3RT13 4., 3RT14 46	24 V, 50 Hz	3RT19 45-5AB01	3RT19 45-5AB02	0.130													
				42 V, 50 Hz							3RT19 45-5AD01	3RT19 45-5AD02								
				48 V, 50 Hz							3RT19 45-5AH01	3RT19 45-5AH02								
				110 V, 50 Hz							3RT19 45-5AF01	3RT19 45-5AF02								
				230 V, 50 Hz							3RT19 45-5AP01	3RT19 45-5AP02								
				400 V, 50 Hz							3RT19 45-5AV01	3RT19 45-5AV02								
				24 V, 50/60 Hz							3RT19 45-5AC21	3RT19 45-5AC22								
				42 V, 50/60 Hz							3RT19 45-5AD21	3RT19 45-5AD22								
				48 V, 50/60 Hz							3RT19 45-5AH21	3RT19 45-5AH22								
				110 V, 50/60 Hz							3RT19 45-5AG21	3RT19 45-5AG22								
208 V, 50/60 Hz	3RT19 45-5AM21	3RT19 45-5AM22																		
220 V, 50/60 Hz	3RT19 45-5AN21	3RT19 45-5AN22																		
230 V, 50/60 Hz	3RT19 45-5AL21	3RT19 45-5AL22																		
110 V, 50 Hz/120 V, 60 Hz	3RT19 45-5AK61	3RT19 45-5AK62																		
220 V, 50 Hz/240 V, 60 Hz	3RT19 45-5AP61	3RT19 45-5AP62																		
277 V, 60 Hz	3RT19 45-5AU61	3RT19 45-5AU62																		
480 V, 60 Hz	3RT19 45-5AV61	3RT19 45-5AV62																		
600 V, 60 Hz	3RT19 45-5AT61	3RT19 45-5AT62																		
100 V, 50/60 Hz/110 V, 60 Hz	3RT19 45-5AG61	3RT19 45-5AG62																		
200 V, 50/60 Hz/220 V, 60 Hz	3RT19 45-5AN61	3RT19 45-5AN62																		
400 V, 50/60 Hz/440 V, 60 Hz	3RT19 45-5AR61	3RT19 45-5AR62																		
	3RT19 45-5AP02	S3	3RT10 45, 3RT10 46, 3RT13 4., 3RT14 46	24 V, 50 Hz	3RT19 45-5AB01	3RT19 45-5AB02	0.130													
				42 V, 50 Hz							3RT19 45-5AD01	3RT19 45-5AD02								
				48 V, 50 Hz							3RT19 45-5AH01	3RT19 45-5AH02								
				110 V, 50 Hz							3RT19 45-5AF01	3RT19 45-5AF02								
				230 V, 50 Hz							3RT19 45-5AP01	3RT19 45-5AP02								
				400 V, 50 Hz							3RT19 45-5AV01	3RT19 45-5AV02								
				24 V, 50/60 Hz							3RT19 45-5AC21	3RT19 45-5AC22								
				42 V, 50/60 Hz							3RT19 45-5AD21	3RT19 45-5AD22								
				48 V, 50/60 Hz							3RT19 45-5AH21	3RT19 45-5AH22								
				110 V, 50/60 Hz							3RT19 45-5AG21	3RT19 45-5AG22								
208 V, 50/60 Hz	3RT19 45-5AM21	3RT19 45-5AM22																		
220 V, 50/60 Hz	3RT19 45-5AN21	3RT19 45-5AN22																		
230 V, 50/60 Hz	3RT19 45-5AL21	3RT19 45-5AL22																		
110 V, 50 Hz/120 V, 60 Hz	3RT19 45-5AK61	3RT19 45-5AK62																		
220 V, 50 Hz/240 V, 60 Hz	3RT19 45-5AP61	3RT19 45-5AP62																		
277 V, 60 Hz	3RT19 45-5AU61	3RT19 45-5AU62																		
480 V, 60 Hz	3RT19 45-5AV61	3RT19 45-5AV62																		
600 V, 60 Hz	3RT19 45-5AT61	3RT19 45-5AT62																		
100 V, 50/60 Hz/110 V, 60 Hz	3RT19 45-5AG61	3RT19 45-5AG62																		
200 V, 50/60 Hz/220 V, 60 Hz	3RT19 45-5AN61	3RT19 45-5AN62																		
400 V, 50/60 Hz/440 V, 60 Hz	3RT19 45-5AR61	3RT19 45-5AR62																		
Coils · DC operation																				
	3RT19 44-5BM42	S2	3RT10 3., 3RT13 3., 3RT15 3.	24 V	3RT19 34-5BB41	3RT19 34-5BB42	0.558													
				42 V							3RT19 34-5BD41	3RT19 34-5BD42								
				48 V							3RT19 34-5BW41	3RT19 34-5BW42								
				60 V							3RT19 34-5BE41	3RT19 34-5BE42								
				110 V							3RT19 34-5BF41	3RT19 34-5BF42								
				125 V							3RT19 34-5BG41	3RT19 34-5BG42								
				220 V							3RT19 34-5BM41	3RT19 34-5BM42								
				230 V							3RT19 34-5BP41	3RT19 34-5BP42								
											3RT19 44-5BM42	S3	3RT10 4., 3RT13 4., 3RT14 4.	24 V	3RT19 44-5BB41	3RT19 44-5BB42	0.916			
														42 V						
48 V	3RT19 44-5BW41	3RT19 44-5BW42																		
60 V	3RT19 44-5BE41	3RT19 44-5BE42																		
110 V	3RT19 44-5BF41	3RT19 44-5BF42																		
125 V	3RT19 44-5BG41	3RT19 44-5BG42																		
220 V	3RT19 44-5BM41	3RT19 44-5BM42																		
230 V	3RT19 44-5BP41	3RT19 44-5BP42																		

3RT Contactors

Spare parts for 3RT1 contactors

Selection and ordering data

For contactor	Rated control supply voltage $U_{s \text{ min}}$ to $U_{s \text{ max}}$	Order No.	Weight approx. kg
Size	Type	AC/DC V	

Withdrawable coils

3RT19 55-5A...



Conventional operating mechanism

S6	3RT10 5, 3RT14 5	23 ... 26	3RT19 55-5AB31 3RT19 55-5AD31 3RT19 55-5AF31 3RT19 55-5AM31 3RT19 55-5AP31 3RT19 55-5AU31 3RT19 55-5AV31 3RT19 55-5AR31 3RT19 55-5AS31 3RT19 55-5AT31	0.49
		42 ... 48		
	110 ... 127			
	200 ... 220			
	220 ... 240			
	240 ... 277			
	380 ... 420			
	440 ... 480			
	500 ... 550			
	575 ... 600			
S10	3RT10 6, 3RT14 6	23 ... 26	3RT19 65-5AB31 3RT19 65-5AD31 3RT19 65-5AF31 3RT19 65-5AM31 3RT19 65-5AP31 3RT19 65-5AU31 3RT19 65-5AV31 3RT19 65-5AR31 3RT19 65-5AS31 3RT19 65-5AT31	0.65
		42 ... 48		
	110 ... 127			
	200 ... 220			
	220 ... 240			
	240 ... 277			
	380 ... 420			
	440 ... 480			
	500 ... 550			
	575 ... 600			
	3RT12 6 Vacuum contactor	23 ... 26	3RT19 66-5AB31 3RT19 66-5AD31 3RT19 66-5AF31 3RT19 66-5AM31 3RT19 66-5AP31 3RT19 66-5AU31 3RT19 66-5AV31 3RT19 66-5AR31 3RT19 66-5AS31 3RT19 66-5AT31	
		42 ... 48		
	110 ... 127			
	200 ... 220			
	220 ... 240			
	240 ... 277			
	380 ... 420			
	440 ... 480			
	500 ... 550			
	575 ... 600			
S12	3RT10 7, 3RT14 7, 3RT12 7	23 ... 26	3RT19 75-5AB31 3RT19 75-5AD31 3RT19 75-5AF31 3RT19 75-5AM31 3RT19 75-5AP31 3RT19 75-5AU31 3RT19 75-5AV31 3RT19 75-5AR31 3RT19 75-5AS31 3RT19 75-5AT31	1.1
		42 ... 48		
	110 ... 127			
	200 ... 220			
	220 ... 240			
	240 ... 277			
	380 ... 420			
	440 ... 480			
	500 ... 550			
	575 ... 600			

Withdrawable coils

3RT19 55-5N...



Solid-state operating mechanism · for DC 24 V PLC output

S6	3RT10 5, 3RT14 5	21 ... 27.3	3RT19 55-5NB31 3RT19 55-5NF31 3RT19 55-5NP31	0.49
		96 ... 127		
		200 ... 277		
S10	3RT10 6, 3RT14 6	21 ... 27.3	3RT19 65-5NB31 3RT19 65-5NF31 3RT19 65-5NP31	0.65
		96 ... 127		
		200 ... 277		
	3RT12 6 Vacuum contactor	21 ... 27.3	3RT19 66-5NB31 3RT19 66-5NF31 3RT19 66-5NP31	
		96 ... 127		
		200 ... 277		
S12	3RT10 7, 3RT14 7, 3RT12 7	21 ... 27.3	3RT19 75-5NB31 3RT19 75-5NF31 3RT19 75-5NP31	1.1
		96 ... 127		
		200 ... 277		

Solid-state operating mechanism · for DC 24 V PLC output/PLC relay output, with remaining lifetime indication (withdrawable coil with lateral electronics module)

S6	3RT10 5, 3RT14 5	96 ... 127	3RT19 55-5PF31 3RT19 55-5PP31	1.1
		200 ... 277		
S10	3RT10 6, 3RT14 6	96 ... 127	3RT19 65-5PF31 3RT19 65-5PP31	1.1
		200 ... 277		
S12	3RT10 7, 3RT14 7	96 ... 127	3RT19 75-5PF31 3RT19 75-5PP31	1.1
		200 ... 277		

3RT Contactors

Spare parts for 3RT1 contactors

Selection and ordering data

For contactor		Design	Order No.	Weight approx.	Pack.
Size	Type			kg	

Arc chutes

S2	3RT20 3. 3RT20 3.	For AC coil contactors only For UC (AC/DC) coil contactors only	3RT29 36-7A 3RT29 36-7B		1 unit
S3	3RT10 4., 3RT14 46		3RT19 46-7A		
S6	3RT10 54 3RT10 55 3RT10 56		3RT19 54-7A 3RT19 55-7A 3RT19 56-7A	0.72	
S10	3RT10 64 3RT10 65 3RT10 66		3RT19 64-7A 3RT19 65-7A 3RT19 66-7A	1.24	
S12	3RT10 75 3RT10 76		3RT19 75-7A 3RT19 76-7A	1.4	
S6	3RT14 56		3RT19 56-7B	0.72	
S10	3RT14 66		3RT19 66-7B	1.24	
S12	3RT14 76		3RT19 76-7B	1.4	

Contacts with fixing parts

• for contactors with 3 main contacts					
S2	3RT20 35 3RT20 36 3RT20 37 3RT20 38	Main contacts (3 NO) for AC-3 utilization category (1 set = 3 moving and 6 fixed contacts with fixing parts)	3RT29 35-6A 3RT29 36-6A 3RT29 37-6A 3RT29 38-6A		1 set
S3	3RT10 44 3RT10 45 3RT10 46		3RT19 44-6A 3RT19 45-6A 3RT19 46-6A		
S6	3RT10 54 3RT10 55 3RT10 56		3RT19 54-6A 3RT19 55-6A 3RT19 56-6A	0.28	
S10	3RT10 64 3RT10 65 3RT10 66		3RT19 64-6A 3RT19 65-6A 3RT19 66-6A	0.48	
S12	3RT10 75 3RT10 76		3RT19 75-6A 3RT19 76-6A	0.9	
S3	3RT14 46	Main contacts (3 NO) for AC-1 utilization category (1 set = 3 moving and 6 fixed contacts with fixing parts)	3RT19 46-6D		
S6	3RT14 56		3RT19 56-6D	0.28	
S10	3RT14 66		3RT19 66-6D	0.48	
S12	3RT14 76		3RT19 76-6D	0.9	
• for 3RT12 vacuum contactors					
S10	3RT12 64 3RT12 65 3RT12 66	3 vacuum interrupters with fixing parts	3RT19 64-6V 3RT19 65-6V 3RT19 66-6V	1.4	1 set
S12	3RT12 75 3RT12 76		3RT19 75-6V 3RT19 76-6V	1.5	
• for contactors with 4 main contacts					
S2	3RT23 36 3RT23 37	Main contacts (4 NO contacts) for utilization category AC-1	3RT29 36-6E 3RT29 37-6E		1 set
S3	3RT13 44 3RT13 46	(1 set = 4 moving and 8 fixed contacts with fixing parts)	3RT19 44-6E 3RT19 46-6E		

3TB World Series Contactors

Rated control supply voltages for coils

Selection and ordering data

Coil type		3TY6 503-0A..	3TB50	3TY7 683-0C..	3TF68	
Rated control supply voltage U_c	Control supply voltage at	3TY6 523-0A..	3TB52	3TY7 693-0C..	3TF69	
		3TY6 543-0A..	3TB54			
		3TY6 566-0A..	3TB56			

Rated control supply voltages (changes to 10th and 11th positions of the Order No.)

AC operation

Coils for 50 Hz					
50 Hz	60 Hz				
AC 24 V	AC 39 V	B0		—	
AC 32 V	AC 28 V	—		—	
AC 36 V	AC 42 V	G0		—	
AC 42 V	AC 50 V	D0		—	
AC 48 V	AC 58 V	H0		—	
AC 60 V	AC 72 V	E0		—	
AC 110 V	AC 132 V	F0		—	
AC 125/127 V	AC 150/152 V	L0		—	
AC 230/220 V	AC 277 V	P0 ¹⁾		—	
AC 240 V	AC 288 V	U0		—	
AC 400/380 V	AC 480/460 V	V0 ¹⁾		—	
AC 415 V	AC 500 V	R0		—	
AC 500 V	AC 600 V	S0		—	
Coils for 50/60 Hz					
AC 110 V ... 132 V		—		F7	
AC 200 V ... 240 V		—		M7	
AC 230 V ... 277 V		—		P7 ²⁾	
AC 380 V ... 460 V		—		Q7	
AC 500 V ... 600 V		—		S7	

Coil type		3TY6 503-0B..	3TB50	3TY7 683-0D..	3TF68	
Rated control supply voltage U_c		3TY6 523-0B..	3TB52	3TY7 693-0D..	3TF69	
		3TY6 543-0B..	3TB54			
		3TY6 563-0B..	3TB56			

Rated control supply voltages (changes to 10th and 11th positions of the Order No.)

DC operation

DC 24 V	B4		B4		
DC 30 V	C4		—		
DC 36 V	V4		—		
DC 42 V	D4		—		
DC 48 V	W4		—		
DC 60 V	E4		—		
DC 110 V	F4		F4		
DC 125 V	G4		G4		
DC 180 V	K4		—		
DC 220 V	M4		M4		
DC 230 V	P4		P4		

Due to the mature nature of some product series, supply cannot be guaranteed on all versions listed on this page.

1) Coil voltage tolerance at 220 V or 380 V:
0.85 to 1.15 x U_c ;
lower tolerance range limit acc. to IEC 60 947.

2) Lower tolerance range limit at 220 V:
0.85 x U_c acc. to IEC 60 947.

3TB World Series Contactors

Spare parts

Coils, AC ¹⁾								
Frame Size	Catalog No							
	24V AC	120V AC	208V AC	220/240V AC	277V AC	480V AC	600V AC	
3TB40-44	3TY7403-0AC2	3TY7403-0AK6	3TY7403-0AM1	3TY7403-0AP6	3TY7403-0AU1	3TY7403-0AV0	3TY7403-0AS0	
3TB47-48	3TY6483-0AC1	3TY6483-0AK6	3TY6483-0AM1	3TY6483-0AP6	3TY6483-0AP0	3TY6483-0AV0	3TY6483-0AS0	
3TB52	—	3TY6523-0AK6	3TY6523-0AM1	3TY6523-0AP6	3TY6523-0AP0	3TY6523-0AV0	—	
3TB56	—	—	—	—	3TY6566-0AP0	3TY6566-0AV0	3TY6566-0AS0	



3TY6463-0AK6

Coils, DC								
Frame Size	Catalog No							
	12V DC	24V DC	42V DC	48V DC	110V DC	125V DC	240V DC	
3TB40-43	3TY4803-0BA4	3TY4803-0BB4	3TY4803-0BD4	3TY4803-0BW4	3TY4803-0BF4	3TY4803-0BG4	3TY4803-0BQ4	
3TB44	3TY6443-0BA4	3TY6443-0BB4	3TY6443-0BD4	3TY6443-0BW4	3TY6443-0BF4	3TY6443-0BG4	3TY6443-0BQ4	
3TB46	—	—	3TY6463-0BD4	3TY6463-0BW4	3TY6463-0BF4	—	3TY6463-0BQ4	
3TB47-48	—	3TY6483-0BB4	3TY6483-0BD4	3TY6483-0BW4	3TY6483-0BF4	3TY6483-0BG4	—	
3TB50	—	3TY6503-0BB4	3TY6503-0BD4	3TY6503-0BW4	3TY6503-0BF4	3TY6503-0BG4	3TY6503-0BQ4	
3TB52	—	3TY6523-0BB4	3TY6523-0BD4	—	3TY6523-0BF4	3TY6523-0BG4	—	
3TB54	—	3TY6543-0BB4	3TY6543-0BD4	3TY6543-0BW4	3TY6543-0BF4	—	3TY6543-0BQ4	
3TB56	—	3TY6563-0BB4	3TY6563-0BD4	—	3TY6563-0BF4	3TY6563-0BG4	3TY6563-0BQ4	
3TB58	—	—	—	—	—	—	—	



3TY6483-0BB4

Main Contacts (Includes 3 Moving and 6 Fixed Contacts) ²⁾	
Frame Size	Catalog No
3TB40-43	Not Replaceable
3TB44	3TY6440-0A
3TB46	3TY6460-0A
3TB47	3TY6470-0A
3TB48	3TY6480-0A
3TB50	3TY6500-0A
3TB52	3TY6520-0A
3TB54	3TY6540-0A
3TB56	3TY6560-0A
3TB58	3TY6580-0A



3TY6500-0A

Select Complete Catalog Number From Above ¹⁾	
Old Number	New Number
3TY6465-0A††	3TY6463-0A††
3TY6485-0A††	3TY6483-0A††
3TY6505-0A††	3TY6503-0A††
3TY6525-0A††	3TY6523-0A††
3TY6545-0A††	3TY6543-0A††
3TY6565-0A††	3TY6566-0A††

Coil Voltages	
Old Number	New Number
A8	K6
B8	M1
C8	P6
D8	Q0
E8	S0
F8	C1
G8	P0

Due to the mature nature of some product series, supply cannot be guaranteed on all versions listed on this page.

1)Some old 3TB coil catalog numbers have been superceded. Cross to current catalog number from these tables.
 2)Main contact kits for size 3TB47 and larger include springs. Smaller sizes do not.

3TF World Series Contactors

Spare parts

Coils, AC Type 3TF and CRLTF

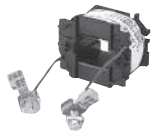

3TY7403-0AK6



3TY7483-0AK6

Frame Size	Catalog No							
	24V AC, 60Hz	120V AC, 60Hz	208V AC, 60Hz	240V AC, 60Hz	277V AC, 60Hz	460V AC, 60Hz	600V AC, 60Hz	
3TF40-43	3TY7403-0AC2	3TY7403-0AK6	3TY7403-0AM1	3TY7403-0AP6	3TY7403-0AU1	3TY7403-0AV0	3TY7403-0AS0	
3TF34-35, 3TF44-45	3TY7443-0AC2	3TY7443-0AK6	3TY7443-0AM1	3TY7443-0AP6	3TY7443-0AU1	3TY7443-0AV0	3TY7443-0AS0	
3TF46-47	3TY7463-0AC2	3TY7463-0AK6	3TY7463-0AM1	3TY7463-0AP6	3TY7463-0AU1	3TY7463-0AV0	3TY7463-0AS0	
3TF48-49	3TY7483-0AC2	3TY7483-0AK6	3TY7483-0AM1	3TY7483-0AP6	3TY7483-0AU1	3TY7483-0AV0	3TY7483-0AS0	
3TF50-51	3TY7503-0AC2	3TY7503-0AK6	3TY7503-0AM1	3TY7503-0AP6	3TY7503-0AU1	3TY7503-0AV0	3TY7503-0AS0	
3TF52-53	3TY7523-0AC2	3TY7523-0AK6	3TY7523-0AM1	3TY7523-0AP6	3TY7523-0AU1	3TY7523-0AV0	3TY7523-0AS0	
3TF54-55	3TY7543-0AC2	3TY7543-0AK6	3TY7543-0AM1	3TY7543-0AP6	3TY7543-0AU1	3TY7543-0AV0	3TY7543-0AS0	
3TF56	3TY7563-0AC2	3TY7563-0AK6	3TY7563-0AM1	3TY7563-0AP6	3TY7563-0AU1	3TY7563-0AV0	3TY7563-0AS0	
3TF57	—	3TY7573-0CF7	—	3TY7573-0CM7	—	3TY7573-0CQ7	—	
3TF68	—	3TY7683-0CF7	—	3TY7683-0CM7	—	3TY7683-0CQ7	3TY7683-0CS7	
3TF69	—	3TY7693-0CF7	—	3TY7693-0CM7	—	3TY7693-0CQ7	3TY7693-0CS7	

Coils, DC Type 3TF and CRLTF



3TY4803-0BB4

Frame Size	Catalog No							
	12V DC	24V DC	42V DC	48V DC	110V DC	125V DC	240V DC	
DC Solenoid								
3TF30-33								
3TF40-43	3TY4803-0BA4	3TY4803-0BB4	3TY4803-0BD4	3TY4803-0BW4	3TY4803-0BF4	3TY4803-0BG4	3TY4803-0BQ4	
3TF34-35, 3TF44-45	3TY7443-0BA4	3TY7443-0BB4	3TY7443-0BD4	3TY7443-0BW4	3TY7443-0BF4	3TY7443-0BG4	—	
3TF46-47	—	3TY7463-0BB4	3TY7463-0BD4	3TY7463-0BW4	—	3TY7463-0BG4	3TY7463-0BQ4	
DC Economy Circuit (Replacement coils only. Does not include interlock or interposing relay.)								
3TF46-47	—	3TY7463-0DB4	3TY7463-0DD4	3TY7463-0DW4	3TY7463-0DF4	3TY7463-0DG4	3TY7463-0DQ4	
3TF48-49	—	—	3TY7483-0DD4	3TY7483-0DW4	3TY7483-0DF4	3TY7483-0DG4	3TY7483-0DQ4	
3TF50-51	—	3TY7503-0DB4	3TY7503-0DD4	3TY7503-0DW4	3TY7503-0DF4	3TY7503-0DG4	3TY7503-0DQ4	
3TF52-53	—	3TY7523-0DB4	3TY7523-0DD4	3TY7523-0DW4	3TY7523-0DF4	3TY7523-0DG4	3TY7523-0DQ4	
3TF54-55	—	—	3TY7543-0DD4	3TY7543-0DW4	3TY7543-0DF4	3TY7543-0DG4	3TY7543-0DQ4	
3TF56	—	3TY7563-0DB4	3TY7563-0DD4	3TY7563-0DW4	—	3TY7563-0DG4	3TY7563-0DQ4	
3TF57	—	3TY7573-0DB4	3TY7573-0DD4	3TY7573-0DW4	3TY7573-0DF4	3TY7573-0DG4	3TY7573-0DQ4	
3TF68	—	3TY7683-0DB4	—	—	3TY7683-0DF4	—	—	

Main Contacts (Includes 3 Moving and 6 Fixed Contacts)



3TY7460-0A

Frame Size	Catalog No	List Price \$
3TF30-35	Not Replaceable	
3TF40-43	Not Replaceable	
3TF44	3TY7440-0A	
3TF45	3TY7450-0A	
3TF46	3TY7460-0A	
3TF47	3TY7470-0A	
3TF48	3TY7480-0A	
3TF49	3TY7490-0A	
3TF50	3TY7500-0A	
3TF51	3TY7510-0A	
3TF52	3TY7520-0A	
3TF53	3TY7530-0A	
3TF54	3TY7540-0A	
3TF55	3TY7550-0A	
3TF56	3TY7560-0A	
3TF57	3TY7570-0A	
3TF68	3TY7680-0B ¹⁾	
3TF69	3TY7690-0B ¹⁾	

Arc Chutes

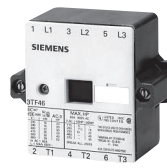

3TY7482-0A

Frame Size	Catalog No
3TF30-35	Not Replaceable
3TF40-43	Not Replaceable
3TF44	3TY7442-0A
3TF45	3TY7452-0A
3TF46	3TY7462-0A
3TF47	3TY7472-0A
3TF48	3TY7482-0A
3TF50	3TY7502-0A
3TF51	3TY7512-0A
3TF52	3TY7522-0A
3TF53	3TY7532-0A
3TF54	3TY7542-0A
3TF55	3TY7552-0A
3TF56	3TY7562-0A
3TF57	3TY7572-0A
3TF68	Not Available
3TF69	Not Available

Due to the mature nature of some product series, supply cannot be guaranteed on all versions listed on this page.

1) Vacuum bottles with mounting hardware.

3TF Contactors and 3TH Control Relays

Spare parts

Auxiliary Contact Blocks

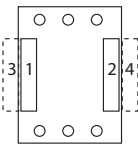
Illustration	Frame Size	Auxiliary Contacts		NO/Early Make	NC/Early Break	Auxiliary Contact Mounting Position	Position	Block Location	Obsolete Catalog No	Current Catalog	
		NO	NC								
	3TF30 to 3TF35, 3TH3	1	—	—	—		—	Top	—	3TX4010-2A	
		—	1	—	—		—	Top	—	3TX4001-2A	
		—	—	1	—		—	Top	—	3TX4010-4A	
		—	—	—	1		—	Top	—	3TX4001-4A	
	3TF40 to 3TF43		Not Replaceable								
	3TF44 to 3TF68	1	1	—	—		1	Left	3TY7561-1A	3TY7561-1AA00	
		1	1	—	—		2	Right	3TY7561-1B	3TY7561-1AA00	
		1	—	—	1		4	Right	3TY7561-1K	3TY7561-1EA00	
	3TF46 to 3TF68	1	1	—	—		3	Left	3TY7561-1K	3TY7561-1KA00	
		2nd Aux Contact Block		1	1		—	—	4	Right	3TY7561-1L
3TF46 to 3TF68 For Electronic Circuits	1	1	—	—		3	Left	3TY7561-1U	3TY7561-1UA00		
	1	1	—	—		4	Right	3TY7561-1V	3TY7561-1UA00		

Mechanical Interlocks

Frame Size	Catalog No
3TF44-54	3TX7466-1A



Arc Chutes

Type	Frame Size	Catalog No	List Price \$	Frame Size	Catalog No
3TB	3TB40-43	Not Replaceable		3TB50	3TY6502-0A
	3TB44	—		3TB52	3TY6522-0A
	3TB46	—		3TB54	3TY6542-0A
	3TB47	—		3TB56	3TY6562-0A
	3TB48	3TY6482-0A		3TB58	—



Control Relays, Type 3TH3, 3TH4 Coils, AC

Type	Frame Size	Catalog No							
		24V AC	120V AC	208V AC	220/240V AC	277V AC	480V AC	600V AC	
3TH	3TH30-33 3TH40-43	3TY7403-0AC2	3TY7403-0AK6	3TY7403-0AM1	3TY7403-0AP6	3TY7403-0AU1	3TY7403-0AV0	3TY7403-0AS0	



Coils, DC

Type	Frame Size	Catalog No							
		12V DC	24V DC	42V DC	48V DC	110V DC	125V DC	240V DC	
3TH	3TH30-33 3TH40-43	3TY4803-0BA4	3TY4803-0BB4	3TY4803-0BD4	3TY4803-0BW4	3TY4803-0BF4	3TY4803-0BG4	3TY4803-0BQ4	

Auxiliary Contact Blocks¹⁾

Type	Frame Size	Auxiliary Contacts		Normally Open/ Early Make	Normally Closed/ Late Break	Block Location	Catalog No
		NO	NC				
3TH	3TH3	1	—	—	—	Top	3TX4010-2A
		—	1	—	—	Top	3TX4001-2A
		—	—	1	—	Top	3TX4010-4A
		—	—	—	1	Top	3TX4001-4A

Control Relays, Type 3TH8 Coils, AC

Type	Frame Size	Catalog No							
		24V AC	120V AC	208V AC	220/240V AC	277V AC	480V AC	600V AC	
3TH	3TH80-83	3TY7403-0AC2	3TY7403-0AK6	3TY7403-0AM1	3TY7403-0AP6	3TY7403-0AU1	3TY7403-0AV0	3TY7403-0AS0	

Coils, DC

Type	Frame Size	Catalog No							
		12V AC	24V AC	42V AC	48V AC	110V AC	125V AC	240V AC	
3TH	3TH80-83	3TY4803-0BA4	3TY4803-0BB4	3TY4803-0BD4	3TY4803-0BW4	3TY4803-0BF4	3TY4803-0BG4	3TY4803-0BQ4	

Due to the mature nature of some product series, supply cannot be guaranteed on all versions listed on this page.

1) Maximum 4 blocks per relay.

Contactors for Switching Motors

3RT contactors, 3-pole, sizes S00 to S3

AC and DC operation

IEC 60 947, EN 60 947 (VDE 0660), UL 508

Design

The 3RT contactors are suitable for use in any climate. They are safe from touch to DIN VDE 0106 Part 100.

The 3RT contactors are available screw, spring-type, or ring lug connections.

An auxiliary contact is integrated in the basic unit of size S00 contactors. The basic units of sizes S0 to S3 only contain the main conducting paths.

All the basic units can be extended with auxiliary switch blocks. Cabinet units with 2 NO + 2 NC (terminal designations acc. to EN 50 012) are available as of size S0; the auxiliary switch block is removable.

The size S3 contactors have removable box terminals for the main conductor connections. Ring cable lugs or bars can thus also be connected.

Contact reliability

If voltages ≤ 110 V and currents ≤ 100 mA are to be switched, the auxiliary contacts of 3RT contactors and 3RH contactor relays should be used to ensure good contact stability.

These auxiliary contacts are suitable for electronic circuits with currents ≥ 1 mA at a voltage of 17 V.

Short-circuit protection of contactors

For the short-circuit protection of contactors without an overload relay, see the technical data.

For the short-circuit protection of contactors with an overload relay, see section 3.

Motor protection

3RU overload relays can be mounted onto the 3RT contactors for protection against overloads. The overload relays must be ordered separately (see section 3).

Surge suppression

The 3RT contactors can be retrofitted with RC elements, varistors, diodes or diode assemblies (combination of an interference suppression diode and a Zener diode for short tripping times) for suppressing opening surges in the coil.

The surge suppressors are plugged onto the front of size S00 contactors. Space is provided for them next to a snap-on auxiliary switch block.

With all size S0 to S3 contactors, varistors and RC elements can be plugged on directly at the coil terminals, either on the top or underneath. Diode assemblies are available in two different designs with different polarities. Depending on the application, they can be attached either only on the bottom (assembly with circuit-breaker) or only on the top (assembly with overload relay).

The plug-in direction of the diodes and diode assemblies is determined by a coding device. Exceptions: 3RT29 26-1E.00 and 3RT19 36-1T.00; in these cases the plug-in direction is identified by "+" and "-".

Coupling relays are supplied either without surge suppression or with a varistor or diode connected as standard, according to the design.

Note

The opening times of the NO contacts and the closing times of the NC contacts increase if the contactor coils are protected against voltage peaks (interference suppression diode 6 to 10 times; diode assemblies 2 to 6 times; varistor +2 ms to 5 ms).

3RT20 1. contactors (size S00),

Terminal designations acc. to EN 50 012 or DIN 50 005.

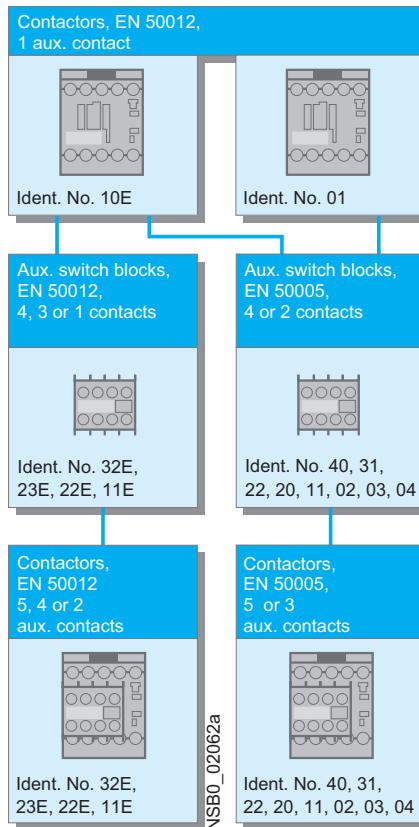

Auxiliary switch blocks

The 3RT basic units can be extended with various auxiliary switch blocks, depending on the application:

Size S00 (3RT201)

Contactors with one NO contact as the auxiliary contact and with either screw or spring-type connections, identification number 10E, can be extended to obtain contactors with 2, 4 or 5 auxiliary contacts in accordance with EN 50 012 using auxiliary switch blocks. The identification numbers 11E, 22E, 23E and 32E on the auxiliary switch blocks apply to the complete contactors. These auxiliary switch blocks cannot be combined with contactors that have an NC contact in their basic unit, identification number 01, as these are coded.

All size S00 contactors with one auxiliary contact, identification number 10E or 01, and the contactors with 4 main contacts can be extended to obtain contactors with 3 or 5 auxiliary contacts (contactors with 4 main contacts: 2 or 4 auxiliary contacts) according to EN 50 005 using auxiliary switch blocks

with identification numbers 40 to 02. The identification numbers on the auxiliary switch blocks apply only to the attached auxiliary contacts.

Single or 2-pole auxiliary switch blocks that can be connected on either the top or the bottom facilitate quick, straightforward wiring, especially when assembling feeders. These auxiliary switch blocks are only available with screw-type terminals.

The solid-state compatible 3RH29 11-1NF.. auxiliary switch blocks for size S00 contactors contain two enclosed contact elements. They are ideal for switching low voltages and currents (hard gold-plated contacts) or for use in dusty atmosphere. The contacts do not have positively-driven operation.

All the above-mentioned auxiliary switch variants can be snapped into the location holes on the front of the contactors. The auxiliary switch block has a centrally positioned release lever for disassembly.

Contactors for Switching Motors

3RT2 contactors, 3-pole, sizes S00 to S3

3RT20 2. to 3RT20 4. contactors (sizes S0 to S3), single-pole auxiliary switch blocks,
terminal designations acc. to EN 50 005 or EN 50 012.

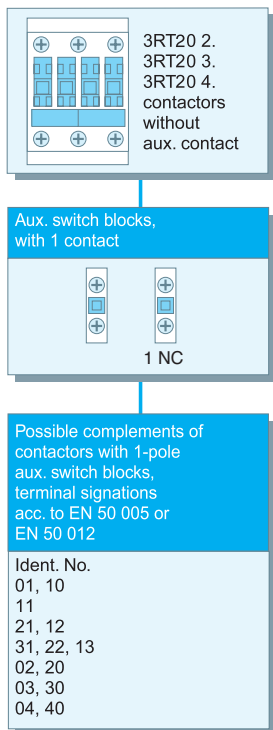

3RT20 2. to 3RT20 4. contactors (sizes S0 to S3), single-pole auxiliary switch blocks,
terminal designations acc. to EN 50 005 or EN 50 012.

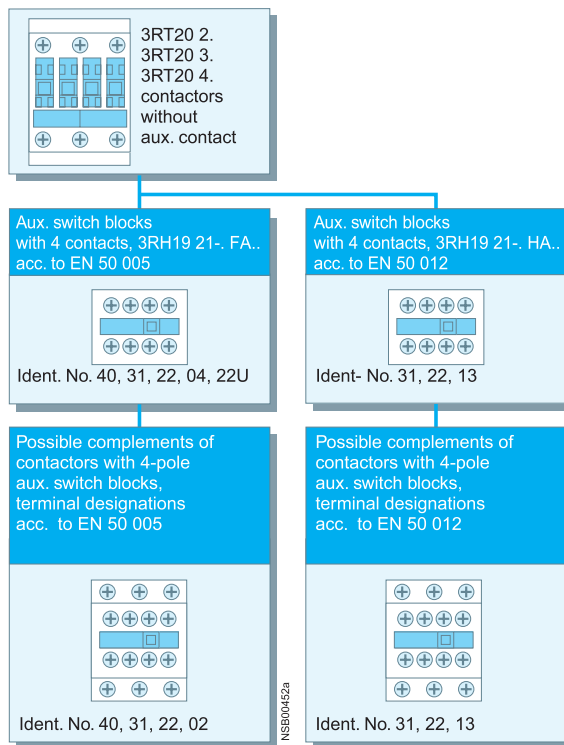

Sizes S0 to S3 (3RT202 to 3RT204)

An extensive range of auxiliary switch blocks is available for various applications. The contactors themselves do not have an integrated auxiliary conducting path.

The auxiliary switch variants are identical for all size S0 to S3 contactors.

One 4-pole or up to four single-pole auxiliary switch blocks (with screw or spring-type connections) can be snapped onto the front of the contactors. When the contactors are energized, the NC contacts open before the NO contacts close.

The terminal designations of the single-pole auxiliary switch blocks consist of location digits on the basic unit and function digits on the auxiliary switch blocks.

In addition, 2-pole auxiliary switch blocks (screw-type terminals) are provided for cable entries from above or below in the style of a four-connector block (feeder auxiliary switch).

If the available installation depth is restricted, 2-pole auxiliary switch blocks (screw or spring-type connections) can be mounted laterally on the left or right.

The auxiliary switch blocks designed for mounting onto the front can be disassembled with the aid of a centrally positioned release lever; the laterally mountable auxiliary switch blocks can be removed easily by pressing on the fluted grips.

The terminal designations of the individual auxiliary switch blocks comply with EN 50 005 or EN 50 012, while those of the complete contactors with an auxiliary switch block with 2 NO + 2 NC comply with EN 50 012.

The laterally mountable auxiliary switch blocks to EN 50 012 can only be used if no 4-pole auxiliary switch blocks are snapped onto the front. If single-pole auxiliary switch blocks are used in addition, the location digits on the contactor must be noted.

Two enclosed contact elements and two standard contact elements are available for the 3RH29 21-FE22 solid-state compatible auxiliary switch block mountable on the front. The laterally mountable 3RH29 21-2DE11 solid-state compatible auxiliary switch block contains 2 enclosed contact elements (1 NO + 1 NC). The enclosed contact elements are ideal for switching low voltages and currents (hard gold-plated contacts) or for use in a dusty atmosphere. The contacts are positively driven.

Sizes S0 and S2 (3RT202 and 3RT203)

Up to four auxiliary contacts can be mounted, whereby any design of the auxiliary switch blocks is permitted. If two 2-pole, laterally mounted, auxiliary switch blocks are used, one must be mounted on the left and one on the right for the sake of symmetry.

Under certain circumstances, more auxiliary contacts are allowed for size S2 (please ask for details).

With regard to 3RT23 and 3RT24 4-pole contactors, please refer to pages 2/12 to 2/14.

Sizes S3 to S12 (3RT204 to 3RT107)

Up to eight auxiliary contacts can be mounted, whereby the following points must be noted:

- Of these eight auxiliary contacts, no more than four must be NC contacts.
- If laterally mounted auxiliary switch blocks are used, they must be symmetrical.

With regard to 3RT15 4-pole contactors, please refer to pages 2/11 to 2/13.

Contactors for Switching Motors

3RT1 contactors, 3-pole, sizes S6 to S12

Overview

Design

- 3RT10 contactors for switching motors
- 3RT12 vacuum contactors for switching motors
- 3RT14 contactors for AC-1 applications

Operating mechanism

Two types of solenoid-operated mechanism are available:

- Conventional operating mechanism
- Solid-state operating mechanism (with 3 performance levels)

UC operation

The contactors can be AC (40 to 60 Hz) and DC driven.

Withdrawable coils

To allow easy coil changing, for example if the application is changed, the magnetic coil can be pulled out upwards without tools after the release mechanism has been actuated, and can be replaced by any other required coil of the same size.

Auxiliary contact complement

The contactors can be equipped with a maximum of 8 auxiliary contacts, with identical auxiliary switch blocks from S0 to S12. Of these, no more than 4 are permitted to be NC contacts.

- 3RT10 and 3RT14 contactors: auxiliary contacts mounted laterally and on front
- 3RT12 vacuum contactors: auxiliary contact mounted laterally

Contactors with conventional operating mechanism

3RT1...-A:

The magnetic coil is switched on and off directly with the control supply voltage U_s via terminals A1/A2.

Multi-voltage range for the control supply voltage $U_{s,c}$: Several closely adjacent control supply voltages, available around the world, are covered by just one coil, for example UC 110-115-120-127 V or UC 220-230-240 V.

In addition, allowance is also made for a coil voltage tolerance of 0.8 times the lower rated control supply voltage ($U_{s,min}$) and 1.1 times the upper rated control supply voltage ($U_{s,max}$), within which the

contactor switches reliably and no thermal overloading occurs.

Contactors with solid-state operating mechanism

The power required for reliable switching and holding is supplied selectively to the magnetic coil by series-connected control electronics.

Features:

- Extended voltage range for the control supply voltage U_s : Compared with the conventional operating mechanism, the solid-state operating mechanism covers an even broader range of globally available control supply voltages within one coil variant. For example, the globally available voltages 200-208-220-230-240-254-277 V are covered with the coil for UC 200 to 277 V ($U_{s,min}$ to $U_{s,max}$).

- Extended coil voltage tolerance 0.7 to $1.25 \times U_s$: On account of the broad range for the rated control supply voltage and the additionally allowed coil voltage tolerance of $0.8 \times U_{s,min}$ to $1.1 \times U_{s,max}$, an extended coil voltage tolerance of at least 0.7 to $1.25 \times U_s$, within which the contactors will operate reliably, is available for the most common control supply voltages of 24, 110 and 230 V.

- Bridging short-time voltage dips: Control voltage failures dipping to 0 V (at A1/A2) are bridged for up to approx. 25 ms, therefore preventing unintentional disconnection.

- Defined ON and OFF thresholds: As of voltages $\geq 0.8 \times U_{s,min}$, the electronics reliably switch the contactor on and as of $\leq 0.5 \times U_{s,min}$ it is reliably switched off. The differential travel in the switching thresholds prevents chattering of the main contacts and hence increased wear or welding when operated in weak, unstable networks. Similarly, thermal overloading of the contactor coil is prevented if the voltage applied is too low – the contactor is not switched on and is operated with overexcitation.
- Low control power consumption when closing and in closed state.

Electromagnetic compatibility (EMC)

The contactors with solid-state operating mechanism conform to the requirements for operation in industrial plants.

- **Noise immunity**
 - Burst (IEC 61 000-4-4): 4 kV
 - Surge (IEC 61 000-4-5): 4 kV
 - Electrostatic discharge, ESD (IEC 61 000-4-2): 8/15 kV
 - Electromagnetic field (IEC 61 000-4-3): 10 V/m
- **Emitted interference**
 - Limiting value class A to EN 55 011

Note: In connection with converters, the control cables should be installed separately from the load cables to the converter.

3RT1...-N: for DC 24 V PLC output

2 control options:

- Control without an interface directly via a DC 24 V ≥ 30 mA PLC output (EN 61 131-2). Connection via a 2-pole plug-in connection; the connector, using screwless spring-force technology, is included in the scope of supply. The control supply voltage for supplying power to the solenoid operating mechanism must be connected to A1/A2.

Note: Before start-up, the sliding-dolly switch for PLC operation must be moved to the "PLC ON" position (setting ex works: "PLC OFF").

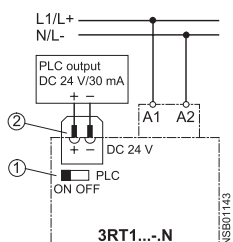

- ① Sliding-dolly switch, must be in PLC "ON" position
- ② Plug-in connection, 2-pole

- Conventional control by applying the control supply voltage at A1/A2 via a switching contact.

Note: The sliding-dolly switch must be in the "PLC OFF" position (= setting ex works).

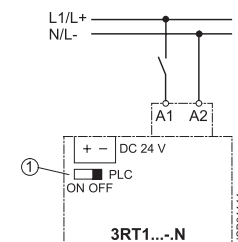

- ⑤ Sliding-dolly switch, must be in PLC "OFF" position

Contactors for Switching Motors

3RT1 contactors, 3-pole, sizes S6 to S12

Overview

Contactors with solid-state operating mechanism

3RT1...-P: for DC 24 V PLC output or PLC relay output, with indication of remaining lifetime
(Indication of remaining lifetime RLT: see 2/69.)

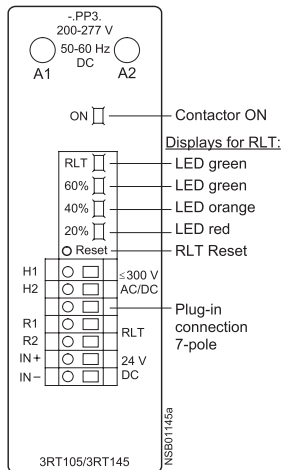

To supply power to the solenoid operating mechanism and the remaining lifetime indication, the control supply voltage U_c must be run to terminals A1/A2 of the laterally mounted electronics module. The control inputs of the contactor are brought out to a 7-pole plug-in connection; the connector, using screwless spring-force technology, is included in the scope of supply.

- The remaining lifetime RLT status signal is available at terminals R1/R2 via a floating relay contact (hard gold-plated, enclosed) and can be processed for example via SIMOCODE-DP or PLC inputs or elsewhere.
- Permissible current carrying capacity of relay output R1/R2:
- I_{th}/AC -15/24 to 230 V: 3 A
 - I_{th}/DC -13/24 V: 1 A

LED indicators

The following statuses are indicated by LEDs on the laterally mounted electronics module:

- Contactor ON (energized state): Green LED ("ON")
- Indication of remaining lifetime (see 2/69)

2 control options:

- Contactor control without an interface directly via a DC 24 V ≥ 30 mA PLC output (EN 61 131-2) via terminals IN+/IN-.

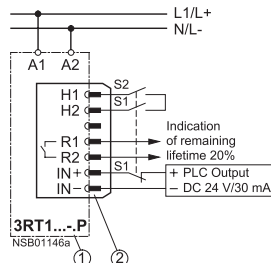

Electronics module of 3RT1 ...-P contactor
Plug-in connection, 7-pole
S1 Changeover switch from automatic control via PLC semiconductor output to local control
S2 Local control option

Possibility of switching from automatic control to local control via terminals H1/H2, i.e. automatic control via a PLC or SIMOCODE-DP/PROFIBUS-DP can be deactivated, for example during start-up or in the event of a fault, and the contactor can be controlled manually.

- Contactor control via relay outputs, e.g. by
 - PLC
 - SIMOCODE-DP 3UF5 via terminals H1/H2.
 Contact loading: U_g /approx. 5 mA.

When operated via SIMOCODE-DP, a communication link to PROFIBUS-DP is also provided.

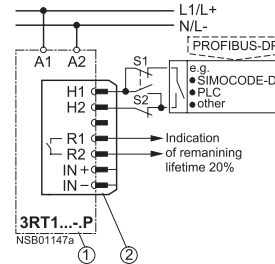

Electronics module of 3RT1 ...-P contactor
Plug-in connection, 7-pole
S1 Changeover switch from automatic control, e.g. via SIMOCODE-DP or PLC relay output to local control
S2 Local control option

3RT12 vacuum contactors

In contrast with the 3RT10 contactors – the main contacts operate in air under atmospheric conditions – the contact gaps of the 3RT12 vacuum contactors are contained in hermetically enclosed vacuum contact tubes. Neither arcs nor arcing gases are produced. The particular benefit of 3RT12 vacuum contactors, however, is that their electrical endurance is at least twice as long as that of 3RT10 contactors.

They are therefore particularly well suited to frequent switching in jogging/mixed operation, for example in crane control systems.

Advantages:

- Very long electrical endurance
- High short-time current-carrying capacity for heavy starting
- No open arcs, no arcing gases, i.e. no minimum clearances from earthed parts required either
- Longer maintenance intervals
- Increased plant availability

Notes on operation:

– Switching motors with rated operational voltages $U_e > 500$ V:

In order to damp overvoltages and protect the motor winding insulation against multiple reignition when switching off three-phase motors, it is recommended to fit the contactors on the outgoing side (T1/T2/T3) with the 3RT19 66-1PV surge suppression module – RC varistor – (accessory).

This additional equipment is not required for operation in circuits with converters. It might be damaged by the voltage peaks and harmonics generated.

- Switching DC voltage: Vacuum contactors are basically unsuitable for switching DC voltage.

Contactors Assemblies for Switching Motors

Contactors assemblies for WYE-delta starting

Overview

The contactor assemblies for star-delta starting can be ordered as follows:

- Sizes S00-S0 as assemblies. (see pages 2/47-2/48)
- Sizes S2-S12 as components for customer assembly

HP	Calculated horsepower ratings at 460 V AC	Operat. current I_e A	Motor current A	Size	Line/delta contactor	WYE contactor	Accessories for customer assembly																					
							Time-delay relay	Installation kit A double infeed																				
30	50	9.5 ... 13.8 12.1 ... 17.2 15.5 ... 21.5 19 ... 27.6 24.1 ... 34 31 ... 43 37.9 ... 55.2 48.3 ... 65	S2-S2-S0	3RT2028	3RT2026		3RP2574-1N.30	3RA2933-2C ³⁾																				
									50	80	62.1 ... 77.8	S2-S2-S2	3RT2935	3RT2035	3RA2933-2BB1 ³⁾													
																60	86	69 ... 86	3RT2036									
																					75	115	31 ... 43.1 37.9 ... 55.2 48.3 ... 69 62.1 ... 77.6 77.6 ... 108.6	S3-S3-S2	3RT2045	3RT2035	3RP2574-1N.30	3RA2943-2C ³⁾
125	160	86 ... 160	S6-S6-S3	3RT1054	3RT2045	3RP2574-1N.30																						
							150	195	86 ... 195	3RT1055	3RT2046																	
												190	230	86 ... 230	3RT1056	3RT2046												
																	200	280	86 ... 280									
250	350	95 ... 350	S10-S10-S6	3RT1064 3RT1065	3RT1054 3RT1056	3RP2574-1N.30																						
							300	430	95 ... 430																			
400	540	347 ... 540	S12-S12-S10	3RT1075	3RT1064	3RP2574-1N.30																						
							450	610	347 ... 610																			
500	690	347 ... 690		3RT1065																								
					650	850	347 ... 850	3RT1076	3RT1066																			

For accessories, see page 2/83.
For circuit diagrams, see page 2/203.

1) The installation kit contains mechanical interlock; 3 connecting clips; wiring connectors on the top (connection between line contactor and delta contactor) and the bottom (connection between delta contactor and star contactor); WYE jumper.

2) The installation kit contains 5 connecting clips; wiring connectors on the top (connection between line contactor and delta contactor) and the bottom (connection between delta contactor and WYE contactor); star jumper.

Contactors Assemblies for Switching Motors

Contactors assemblies for WYE-delta starting

Installation kit B for single infeed	WYE jumper	Baseplates	Overload relay, thermal		Overload relay, solid-state	
			Range of overload relay, thermal [A]	Order No. overload relay, thermal	Range of overload relay, solid-state [A]	Order No. overload relay, solid-state
3RA1933-3D ⁴⁾	3RT1926-4BA31	3RA2932-2E	5.5 ... 8	3RU2136-1HB	12.5 ... 50	3RB3036-1UB0
			7 ... 10	3RU2136-1JB0		
			9 ... 12.5	3RU2136-1KB0		
			11 ... 16	3RU2136-4AB0		
			14 ... 20	3RU2136-4BB0		
			18 ... 25	3RU2136-4DB0		
			22 ... 32	3RU2136-4EB0	20 ... 80	3RB3036-1WB0
			28 ... 40	3RU2136-4FB0		
	3RT1936-4BA31	3RA2932-2F	36 ... 45	3RU2136-4GB0		
			40 ... 50	3RU2136-4HB0		
3RA1943-3D ⁴⁾	3RT1946-4BA31	3RA2942-2E	28 ... 40	3RU2146-4FB0	12.5 ... 50	3RB3046-1UB0
			36 ... 45	3RU2146-4HB0		
			45 ... 63	3RU2146-4JB0		
			57 ... 75	3RU2146-4KB0	32 ... 115	3RB3046-1XB0
			70 ... 90	3RU2146-4LB0		
80 ... 100 ⁷⁾	3RU2146-4MB0					
3RA1953-3D ⁵⁾	3RT1946-4BA31	3RA1952-2E	–	–	50 ... 200	3RB2056-1FC2

3) Installation kit contains wiring connector on the bottom (connection between delta contactor and WYE contactor) and WYE jumper.
 4) Wiring connector on top from reversing contactor assembly (note conductor cross-sections).

5) A mechanical interlock adapter, 3RA1954-2C, is required to use the standard 3RA1954-2A mechanical interlock for the AC version of the S6-S6-S3 WYE-Delta starter. The S6-S6-S3 WYE-Delta DC version would require a special custom build spacer, which is not manufactured, to allow the mechanical interlock to operate.

6) Only use wiring connector on the top from reversing contactor assembly (note conductor cross-sections); order WYE jumper in addition.
 7) For overload relays >100A, see 3RB2 electronic Section 3, page 23.

Contactors Assemblies for Switching Motors

Contactors assemblies for WYE-delta starting

Application

WYE-delta starting can only be used either if the motor normally operates in a Δ (delta) connection or starts softly or if the load torque during Υ starting is low and does not increase sharply. On the Υ step the motors can carry approximately 50% (class KL 16) or 30% (class KL 10) of their rated torque; the starting torque is approximately $\frac{1}{3}$ of that during direct on-line starting. The starting current is approximately 2 to 2.7 times the rated motor current.

The changeover from Υ to Δ must not be effected until the motor has run up to rated speed. Drives which require this changeover to be performed earlier are unsuitable for WYE-delta starting.

The ratings given in the above table are only applicable to motors with a starting current ratio of $I_A \leq 8.4 \times I_N$ and using either a 3RT19 16-2G or 3RT19 26-2G solid-state time-delay auxiliary switch block with a WYE-delta function or a 3RP1574 WYE-delta time-delay relay with a dead interval of approximately 50 ms on reversing.

For the circuit diagrams for the main and control circuits, see page 2/161. The size selected for the installation kits for WYE-delta starting is determined by the line contactor.

Design

Components for customer assembly

Installation kits with wiring connectors and, if necessary, mechanical connectors are available for contactor assemblies for WYE-delta starting. Contactors, overload relays, star-delta time-delay relays and auxiliary switches for the electrical interlock – if required also feeder terminals, mechanical interlocks ¹⁾ and baseplates – must be ordered separately.

The wiring installation kits for sizes S00 and S0 contain the top and bottom main conducting path connections between the line and delta contactors (top) and between the delta and WYE contactors (bottom).

In the case of sizes S2 to S12 only the bottom main conducting path connection between the delta and WYE contactors is included in the wiring connector, owing to the larger conductor cross-section at the infeed.

Motor protection

Overload relays or thermistor motor protection tripping units can be used for overload protection.

The overload relay can be either mounted onto the line contactor or separately fitted. It must be set to 0.58 times the rated motor current.

Surge suppression

Sizes S00 to S3

All contactor assemblies can be fitted with RC elements, varistors or diode assemblies for damping opening surges in the coil.

As with the individual contactors, the surge suppressors can either be plugged onto the top of the contactors (S00) or fitted onto the coil terminals on the top or bottom (S0 to S3).

Sizes S6 to S12

The contactors are fitted with varistors as standard.

1) Exception:
The mechanical interlock between the delta and WYE contactors is included in the installation kit for size S00 contactor assemblies.

Contactors Assemblies for Switching Motors

Contactors assemblies for WYE-delta starting

Selection and ordering data

Fully wired and tested contactor assemblies · Size S00-S00-S00 · Up to 11 kW

The figure shows the version with screw terminals

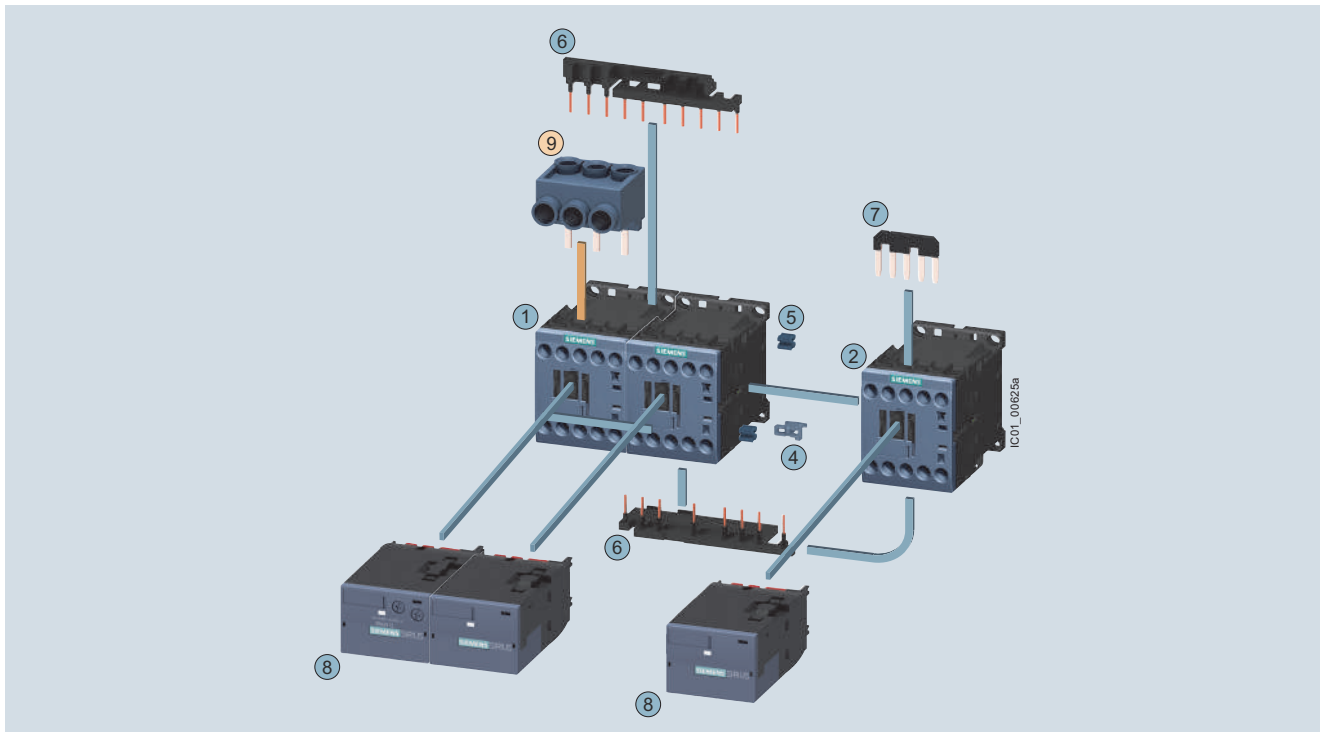

Mountable accessories (optional)

To be ordered separately	Type	Page
⑨ Three-phase infeed terminal ¹⁾	3RA2913-3K	2/83

Complete contactor assembly for star-delta (wye-delta) starting

Individual parts	Type			Page
	Q11 ²⁾	Q13	Q12	
① ② ③ Contactors, 5.5 kW	3RT2015	3RT2015	3RT2015	2/8
① ② ③ Contactors, 7.5 kW	3RT2017	3RT2017	3RT2015	2/8
① ② ③ Contactors, 11 kW	3RT2018	3RT2018	3RT2016	2/8
④ ... ⑦ Assembly kit S00-S00-S00 comprising:	3RA2913-2BB1			2/83
④ Mechanical interlock				
⑤ Four connecting clips for three contactors				
⑥ Wiring modules on top and bottom for connecting the main and auxiliary circuits				
⑦ Star jumper				
⑧ Function modules for star-delta (wye-delta) starting	3RA2816-0EW20			2/27

1) Part ⑨ can only be mounted in the case of contactors with screw terminal.

2) The version with 1 NO is required for momentary-contact operation.

Note:

When the function modules for contactor assemblies for wye-delta starting are used, no other auxiliary switches are allowed to be mounted on the basic units.

Contactor Assemblies for Switching Motors

Contactor assemblies for WYE-delta starting

Fully wired and tested contactor assemblies · Size S0-S0-S0 · Up to 22 kW

The figure shows the version with screw terminals

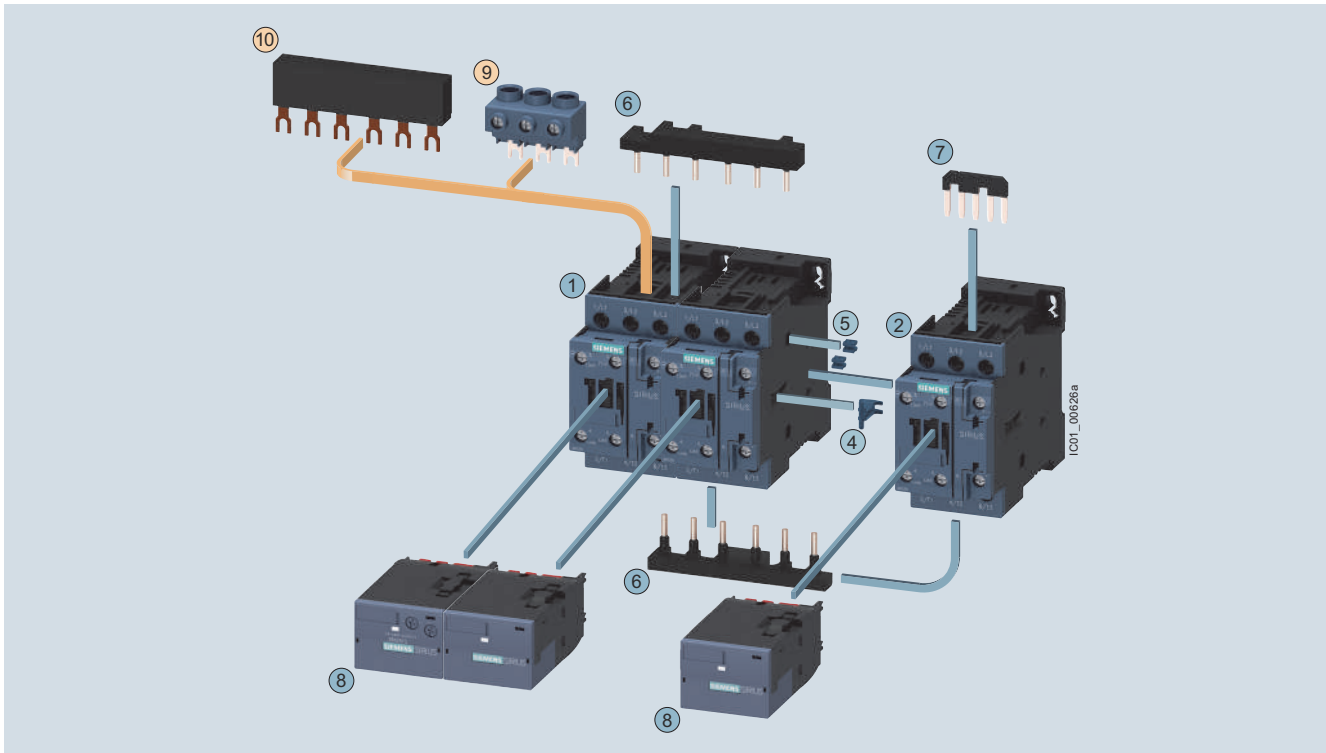

Mountable accessories (optional)

To be ordered separately	Type	Page
⑨ Three-phase infeed terminal ¹⁾	3RV2925-5AB	2/83
⑩ Three-phase busbar ¹⁾	3RV1915-1AB	1/8

Complete contactor assembly for star-delta (wye-delta) starting

Individual parts	Type			Page
	Q11	Q13	Q12	
① ② ③ Contactors, 11 kW	3RT2024	3RT2024	3RT2024	2/8
① ② ③ Contactors, 15/18.5 kW	3RT2026	3RT2026	3RT2024	2/8
① ② ③ Contactors, 22 kW	3RT2027	3RT2027	3RT2026	2/8
④ ... ⑦ Assembly kit S0-S0-S0 comprising:	3RA2923-2BB1			2/83
④ Mechanical interlock				
⑤ Four connecting clips for three contactors				
⑥ Wiring modules on top and bottom for connecting the main and auxiliary circuits				
⑦ Star jumper				
⑧ Function modules for star-delta (wye-delta) starting	3RA2816-0EW20			2/27

¹⁾ The parts ⑨ and ⑩ can only be mounted with contactors with screw terminal, the ⑥ wiring modules must be removed beforehand.

Note:

When the function modules for contactor assemblies for wye-delta starting are used, no other auxiliary switches are allowed to be mounted on the basic units.

Contactors Assemblies for Switching Motors

Contactors assemblies for WYE-delta starting

Size S2-S2-S0 · up to 65 A, 30 HP

The figure shows the version with screw terminals in S2-S2-S2

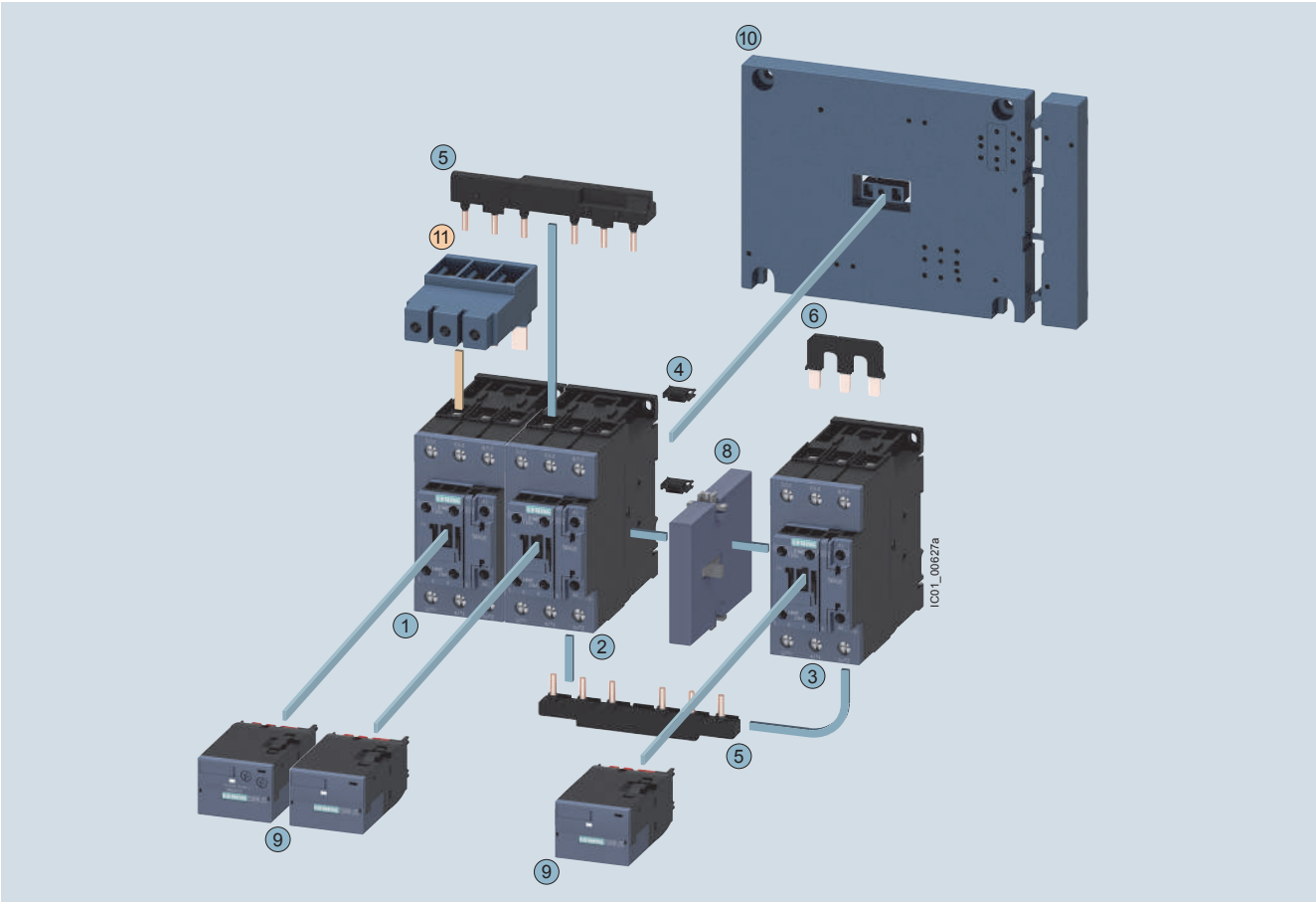

Mountable accessories (optional)

To be ordered separately	Type
11 Three-phase infeed terminal	3RV2935-5A

Complete contactor assembly for star-delta (wye-delta) starting

Individual parts	Type		
	Q11	Q13	Q12
1 2 3 Contactors, 22/30 kW	3RT2035	3RT2035	3RT2026
1 2 3 Contactors, 37 kW	3RT2035	3RT2035	3RT2027
1 2 3 Contactors, 45 kW	3RT2036	3RT2036	3RT2028
4 ... 7 Assembly kit S2-S2-S0 comprising:	3RA2933-2C		
4 Four connectors for three contactors (not required for fully pre-wired contactor assemblies for star-delta (wye-delta) starting)			
5 Wiring modules on top and bottom for connecting the main and auxiliary circuits			
6 Star jumper S2			
7 Cable for connecting the A2 coil contact from the line contactor with the A2 coil contact of the delta contactor (not shown in the drawing)			
8 Mechanical interlock	3RA2934-2B		
9 Function modules for star-delta (wye-delta) starting	3RA2816-0EW20		
10 Base plate star-delta (wye-delta)	3RA2932-2F		

For overview, see page 2/110.
For circuit diagrams, see page 2/203.

Contactors Assemblies for Switching Motors

Contactors assemblies for WYE-delta starting

Size S2-S2-S2 · up to 86 A, 60 HP

2
CONTACTORS AND
ASSEMBLIES

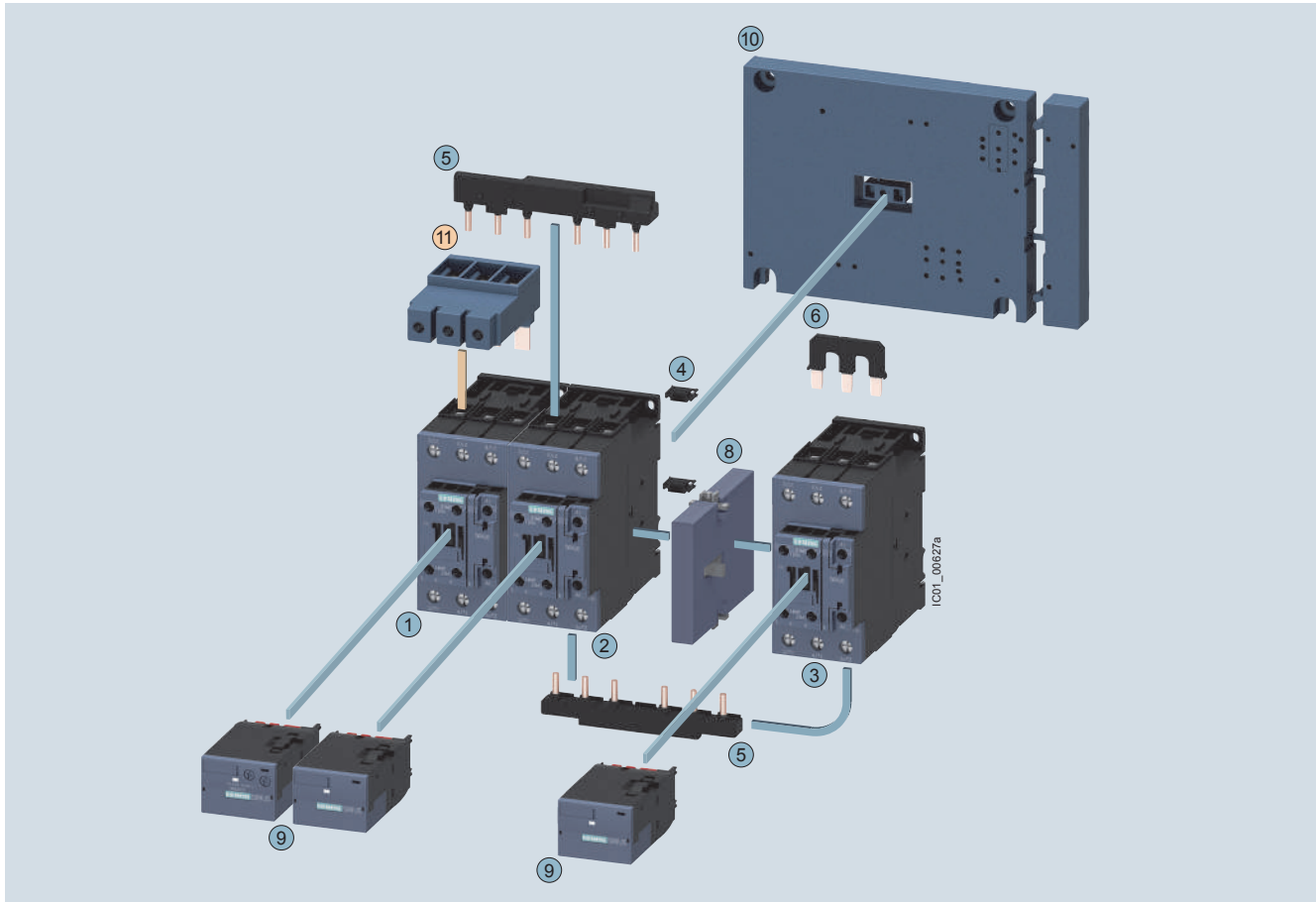

Mountable accessories (optional)

To be ordered separately	Type
⑪ Three-phase infeed terminal	3RV2935-5A

Complete contactor assembly for star-delta (wye-delta) starting

Individual parts	Type		
	Q11	Q13	Q12
① ② ③ Contactors, 55 kW	3RT2037	3RT2037	3RT2035
④ ... ⑦ Assembly kit S2-S2-S2 comprising:	3RA2933-2BB1		
④ Four connectors for three contactors (not required for fully pre-wired contactor assemblies for star-delta (wye-delta) starting)			
⑤ Wiring modules on top and bottom for connecting the main and auxiliary circuits			
⑥ Star jumper S2			
⑦ Cable for connecting the A2 coil contact from the line contactor with the A2 coil contact of the delta contactor (not shown in the drawing)			
⑧ Mechanical interlock	3RA2934-2B		
⑨ Function modules for star-delta (wye-delta) starting	3RA2816-0EW20		
⑩ Base plate star-delta (wye-delta)	3RA2932-2F		

For overview, see page 2/110.

For circuit diagrams, see page 2/203.

Contactors Assemblies for Switching Motors

Contactors assemblies for WYE-delta starting

Size S3-S3-S2 · up to 150 A, 100 HP

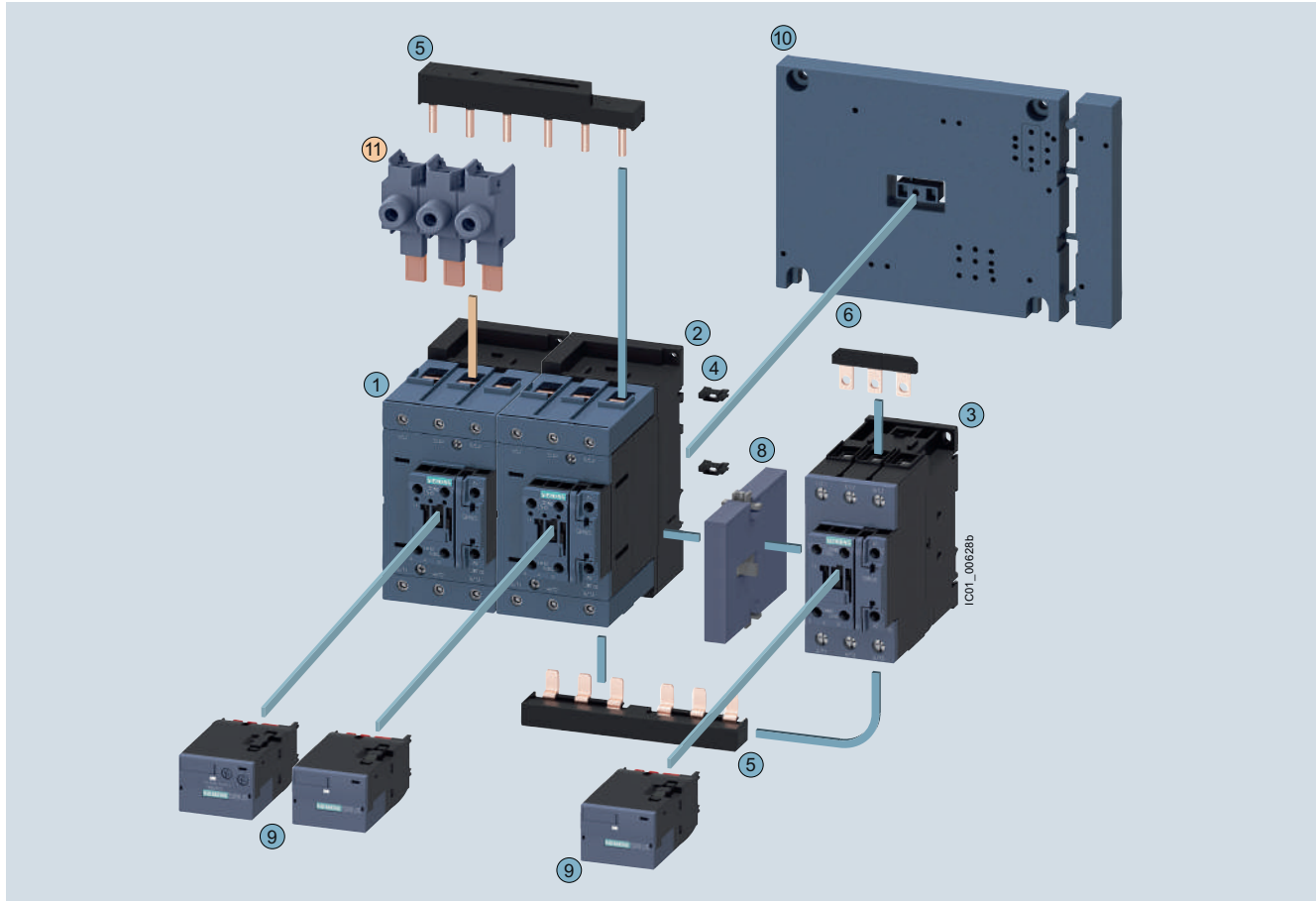

Mountable accessories (optional)

To be ordered separately	Type
11 Single-phase infeed terminal (3 units are required)	3RA2943-3L

Complete contactor assembly for star-delta (wye-delta) starting

Individual parts	Type		
	Q11	Q13	Q12
1 2 3 Contactors, 55 kW	3RT2045	3RT2045	3RT2035
1 2 3 Contactors, 75 kW	3RT2045	3RT2045	3RT2036
1 2 3 Contactors, 90 kW	3RT2046	3RT2046	3RT2037
4 ... 7 Assembly kit S3-S3-S2 comprising:	3RA2943-2C		
4 Two connectors for three contactors (not required for fully pre-wired contactor assemblies for star-delta (wye-delta) starting)			
5 Wiring modules on top and bottom (S3-S2) for connecting the main and auxiliary circuits and a cable set for the auxiliary circuit			
6 Star jumper S2			
7 Cable for connecting the A2 coil contact from the line contactor with the A2 coil contact of the delta contactor (not shown in the drawing)			
8 Mechanical interlock	3RA2934-2B		
9 Function modules for star-delta (wye-delta) starting	3RA2816-0EW20		
10 Base plate star-delta (wye-delta)	3RA2942-2F		

¹⁾ Contactor assembly for star-delta (wye-delta) starting for customer assembly in size S3-S3-S3 (not shown): The 3RA2943-2BB. assembly kit is to be used here, see page 3/106.

For overview, see page 2/110.
For circuit diagrams, see page 2/203.

Control Relays, Coupling Relays

3RH21 control relays, size S00 with 4 or 8 contacts

AC and DC operation

IEC 60947, EN 60947.

The 3RH2 contactor relays have screw, ring lug terminal or spring-type terminals. Four contacts are available in the basic unit.

The 3RH2 contactor relays are suitable for use in any climate. They are finger-safe according to EN 50274. The devices with ring lug terminal connection comply with degree of protection IP20 when fitted with the related terminal cover.

Contact reliability

High contact stability at low voltages and currents, suitable for solid-state circuits with currents ≥ 1 mA at a voltage of 17 V.

Surge suppression

RC elements, varistors, diodes or diode assemblies (combination of a diode and a Zener diode) can be plugged onto all contactor relays from the front for damping opening surges in the coil. The plug-in direction is determined by a coding device.

Note:

The OFF-delay of the NO contact and the ON-delay of the NC contact are increased if the contactor coils are attenuated against voltage peaks (noise suppression diode 6 to 10 times; diode assemblies 2 to 6 times, varistor +2 to 5 ms).

Auxiliary switch blocks

The 3RH2 contactor relays can be expanded by up to four contacts by the addition of snap-on auxiliary switch blocks.

The auxiliary switch block can easily be snapped onto the front of the contactors. The auxiliary switch block has a centrally positioned release lever for disassembly.

The contactor relays with 4 contacts according to EN 50011, with the identification number 40E, can be extended with 80E to 44E auxiliary switch blocks to obtain contactor relays with 8 contacts according to EN 50011. The identification numbers 80E to 44E on the auxiliary switch blocks apply to the complete contactors. These auxiliary switch blocks (3RH29 11-1GA..) cannot be combined with contactor relays with identification numbers 31E and 22E; they are coded.

All contactor relays with 4 contacts according to EN 50011, identification numbers 40E to 22E, can be extended with auxiliary switch blocks 40 to 02 to obtain contactor relays with 6 or 8 contacts in accordance with EN 50005. The identification numbers on the auxiliary switch blocks apply only to the attached auxiliary switch blocks.

In addition, fully mounted 3RH22 8-pole contactor relays are available; the mounted 4-pole auxiliary switch block in the 2nd tier is not removable. The terminal designations are according to EN 50011.

These versions are built according to special Swiss regulations SUVA and are distinguished externally by a red labeling plate.

Of the auxiliary contacts (integrated plus mountable) possible on the device, no more than four NC contacts are permitted.

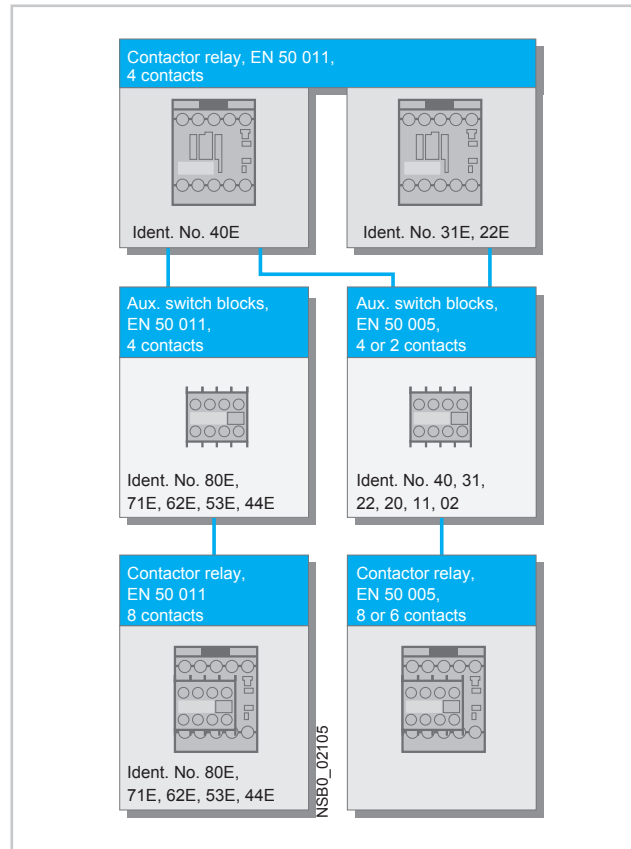

3RH24 latched control relays, size S00

Application

AC and DC operation

IEC 60 947, EN 60 947 (VDE 0660)

The terminal designations comply with EN 50 011.

The relay coil and the coil of the release solenoid are both designed for continuous duty.

The number of auxiliary contacts can be extended by means of auxiliary switch blocks (up to 4 poles).

RC elements, varistors, diodes or diode assemblies can be plugged onto both coils

from the front for damping opening surges.

The control relay can also be switched on and released manually.

Contactors for Switching Motors

3TF68 and 3TF69 vacuum contactors, 3-pole

Design

EN 60 947-4-1 (VDE 0660 Part 102).

The 3TF contactors are suitable for use in any climate. They are safe from touch according to DIN VDE 0106 Part 100. Terminal covers (see accessories) may have to be fitted onto the connecting bars, depending on the configuration with other devices.

Main contacts

Contact erosion indication with 3TF68/69 vacuum contactors

The contact erosion of the vacuum interrupters can be monitored in the closed position by means of three white double slides on the contactor base.

The vacuum interrupter must be replaced if the distance indicated by one of the double slides is less than 0.5 mm while the contactor is in the closed position.

It is advisable to replace all three interrupters in order to ensure maximum reliability.

Auxiliary contacts

The terminal designations comply with EN 50 012.

When the contactors are energized, the NC contacts open before the NO contacts close.

Contact reliability

The auxiliary contacts are extremely reliable and as such are suitable for electronic circuits

- with currents ≥ 1 mA,
- at voltages greater than 17 V.

Surge suppression

Control circuit

Protection of the coil circuits against surges:

AC operation

- fitted with varistors as standard.

DC operation

- Retrofitting options:
- varistors.

Electromagnetic compatibility (EMC)

3TF68/69...C contactors for AC operation are equipped with an electronically controlled solenoid mechanism with a high level of immunity to interference (see table opposite).

Note:

In operation in installations where it is not possible to observe the emitted interference limits, e.g. as an output contactor in static frequency changers, use of 3TF68/69...Q contactors (NS E catalogue, available in German) is recommended, without a main conductor path circuit (for further information refer also to the description below).

Contactor Type	Rated control supply voltage U_s	Overvoltage type (IEC 60 801)	Severity to IEC 60 801	Surge strength
3TF68 44-.C... 3TF69 44-.C..	110 V ... 132 V	Burst	3	2 kV
	200 V ... 276 V	Surge	4	6 kV
	380 V ... 600 V	Burst	4	4 kV
		Surge	4	5 kV
		Burst	4	4 kV
		Surge	4	6 kV

Circuit of the main conducting paths

An integrated RC varistor circuit in the main conducting paths of the contactors damps the rate of rise of switching overvoltages to uncritical values. Multiple restriking of the switching arcs is thereby prevented.

The operator of an installation can thus assume that the danger to the motor winding arising from switching overvoltages with a high rate of rise is ruled out.

The contactors can therefore be used without reservation for all AC switching applications, including three-phase motors with the demanding AC-4 utilization category.

Important note

The surge suppression circuit is not necessary when 3TF68/69 contactors are used in circuits with e.g. d.c. choppers, frequency converters or variable-speed drives.

It might be damaged by the voltage peaks and harmonics generated. This may also cause phase-to-phase short-circuits in the contactors.

Remedy: Order the special contactor design without surge suppression. In this case the Order No. must be supplemented with "-Z" and the order code "A02". No additional charge is made.

Short-circuit protection of contactors

For assembling fuseless load feeders, please select a circuit-breaker/contactor combination according to the brochure entitled "Verbraucherabzweige in sicherungsloser Bauweise", Order No. E20001-P285-A726 (available in German only).

Accessories for 3RT / 3RH Contactors

Solid-state, time-delay auxiliary switch box

The timer module, which is available in "ON-delay" and "OFF-delay" designs, allows time-delayed functions up to 100 s (3 distinct delay ranges).

It contains a relay with one NO contact and one NC contact; the relay is switched either after an ON-delay or after an OFF-delay.

The timer module with a WYE-DELTA function is equipped with one delayed and one instantaneous NO contact, with an interval time of 50 ms between the two (see diagram). The delay time of the NO contact can be set between 1.5 s and 30 s.

WYE-delta function

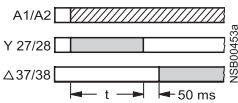

The timer module, which is available in "ON-delay" and "OFF-delay" with auxiliary power supply designs, allows time-delayed functions up to 100 s (3 distinct delay ranges). Contactors fitted with a time-delay block close or open after a delay according to the set time.

The ON-delay variant of the time-delay relay is connected in series with the contactor coil; terminal A1 of this coil must not be connected.

With the OFF-delay variant of the time-delay relay, the contactor coil is contacted directly via the relay; terminals A1 and A2 of the coil must not be connected.

The time-delay relays are suitable for both AC and DC operation.

The contactor on which the solid-state, time-delay auxiliary switch block is mounted operates without a delay.

Size S00 (3RT201)

The solid-state, time-delay auxiliary switch block is fitted onto the front of the contactor. The timer module is supplied with power directly by plug-in contacts via the coil terminals of the contactor, in parallel with A1/A2. The time function is activated by closing the contactor on which the auxiliary switch block is mounted. The OFF-delay variant operates without an auxiliary power supply. Minimum ON period: 200 ms.

Size S00 (3RT201)

The variant for size S00 contactors is fitted onto the front of the contactor (with the supply voltage switched off) and then slid into its latched position; at the same time, the time-delay relay is connected by means of plug-in contacts to coil terminals A1 and A2 of the contactor. Any contactor coil terminals which are not required are sealed off by means of covers on the enclosure of the time-delay block, to prevent them from being connected inadvertently (for circuit diagrams, see page 2/149).

A varistor is integrated in the timer module for damping opening surges in the contactor coil.

The solid-state, time-delay block cannot be mounted on size S00 coupling relays.

A varistor is integrated in the timer module for damping opening surges in the contactor coil.

The solid-state, time-delay auxiliary switch block cannot be mounted on size S00 coupling relays.

Sizes S0 to S12 (3RT202 to 3RT107)

The solid-state, time-delay auxiliary switch block is fitted onto the front of the contactor.

The timer module is supplied with power via two terminals (A1/A2); the time delay of the auxiliary switch block can be activated either by a parallel link to any contactor coil or by any power source.

The OFF-delay variant operates without an auxiliary power supply. Minimum ON period: 200 ms.

A single-pole auxiliary switch block can be snapped onto the front of the contactor in addition to the timer module.

The timer module has no integrated components for damping opening surges.

Solid-state time-delay block with semiconductor output

Sizes S0 to S3 (3RT202 to 3RT107)

The time-delay block for size S0 to S3 contactors is plugged into coil terminals A1 and A2 on top of each contactor; the time-delay relay is connected both electrically and mechanically by means of pins.

A varistor is integrated in the timer module for damping opening surges in the contactor coil.

Configuration note

Activation of loads parallel to the start input is not permitted with AC operation (see ②).

The 3RT19 16-2D.../3RT19 26-2D... time-delay blocks with an OFF delay have a voltage-carrying start input B1. This means that if there is a parallel load on terminal B1, activation can be simulated with AC voltage. In this case, the additional load (e.g. contactor K3) must be wired as shown in ⑥.

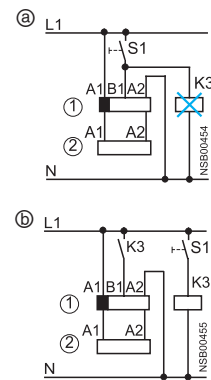

Time-delay block
Contactor

Accessories for 3RT / 3RH Contactors

3-phase EMC interference suppression module for size S00 contactor

A so-called back-e.m.f. (electromotive force) is produced when motors or various inductive loads are turned off. Voltage peaks of up to 4 000 V may occur as a result, with a frequency spectrum from 1 kHz to 10 MHz and a rate of voltage variation from 0.1 to 20 V/ns.

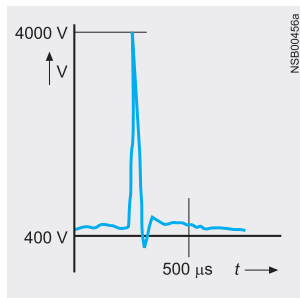

The connection between the main conducting path and the EMC interference suppression module enables contact arcing, which is responsible for contact erosion and the majority of clicking noises, to be reduced; this in turn is conducive to an electromagnetically compatible design.

Since the EMC interference suppression module achieves a significant reduction in radio-frequency components and the voltage level in three phases, the contact endurance is also improved considerably. This makes an important contribution towards enhancing the reliability and availability of the system as a whole.

There is no need for fine graduations within each performance class, as smaller motors inherently have a higher inductance, so that one solution for all fixed-speed drives up to 7.5 HP is adequate.

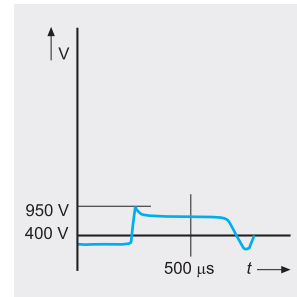
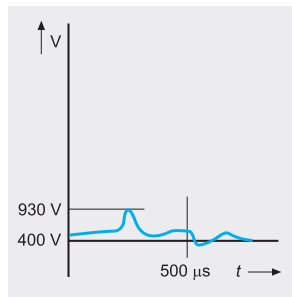
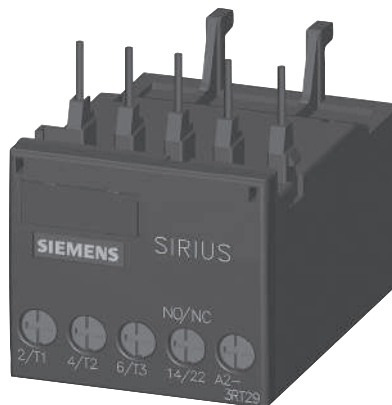

Two electrical variants are available:

The advantages of the RC circuit lie mainly in the reduction in the rate of rise and in its RF damping ability. The selected values ensure effective interference suppression over a wide range.

The varistor circuit is able to absorb high energy levels and is also suitable for frequencies from 10 to 400 Hz (variable-speed drives). There is no limiting below the knee-point voltage, however.

OFF-delay device for size S00 to S3 contactors

AC and DC operation
IEC 60 947, EN 60 947

For screwing and snapping onto 35 mm standard mounting rail. The OFF-delay devices have screw connections.

Application

The OFF-delay device prevents a contactor from dropping out unintentionally when there is a short-time voltage dip or voltage failure. It supplies the necessary power for a series-connected, DC-operated contactor during a voltage dip to ensure that the

contactor does not open. The 3RT19 16/3RT29 16 OFF-delay devices are specifically designed for operation with the 3RT contactors and 3RH contactor relays of the SIRIUS series.

Principle of operation

The OFF-delay device operates without external voltage on a capacitive basis, and can be energized with either AC or DC (24 V version for DC operation only). Voltage matching, which is only necessary with AC operation, is performed using a rectifier bridge.

A contactor opens after a delay when the capacitors of the contactor coil, built into the OFF-delay device, are switched in parallel. In the event of voltage failures, the capacitors are discharged via the coil and thereby delay the opening of the contactor.

If the command devices are upstream of the OFF-delay device in the circuit, the OFF delay takes effect with every opening operation. If the opening operation is downstream of the OFF-delay device, an OFF delay only applies in the event of failure of the mains voltage.

Operation

In the case of the versions for rated control supply voltages of 110 V and 230 V, either AC voltage or DC voltage can be applied on the line side, where as the variant for 24 V is designed for DC operation only. A DC-operated contactor is connected to the output in accordance with the input voltage that is applied.

The mean value of the OFF delay is approximately 1.5 times the specified minimum time.

Accessories for 3RT Contactors

Interface for mounting on size S0 to S3 contactors

Application

DC operation

IEC 60 947 and EN 60 947
The interface is suitable for use in any climate. It is safe from touch to DIN VDE 0106 Part 100. The terminal designations conform to EN 50 005.

Functions

Design

System-compatible operation with DC 24 V, coil voltage tolerance 17 V to 30 V.
Low power consumption in conformity with the technical data of the electronic systems.
A light-emitting diode indicates the circuit state.

Surge suppression

The 3RH29 24-1GP11 interface has an integrated surge suppressor (varistor) for the contactor coil being switched.

Mounting

The 3RH29 24-1GP11 interface is mounted directly on the contactor coil.

Terminal diagram

3RH19/29 24-1GP1
with surge suppression

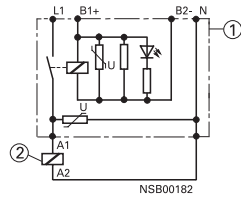

- ① Interface
- ② Contactor

Connection example

3RH19/29 24-1GP1
with surge suppression

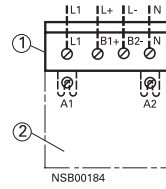

- ① Interface
- ② Contactor

Contactors for Switching Motors

SIRIUS 3RT contactors, 3-pole up to 500 HP

Technical specifications

More information

Technical specifications, see <https://support.industry.siemens.com/cs/ww/en/ps/16134/td>
 FAQs, see <https://support.industry.siemens.com/cs/ww/en/ps/16134/faq>

Manuals, see

- System Manual "SIRIUS Modular System – System Overview", <https://support.industry.siemens.com/cs/WW/en/view/60311318>
- Manual "SIRIUS – SIRIUS 3RT Contactors/Contactor Assemblies", <https://support.industry.siemens.com/cs/WW/en/view/60306557>
- Application Manual "Controls with IE3/IE4 Motors", <https://support.industry.siemens.com/cs/ww/en/view/94770820>

Type	Contactors		
	3RT2	S3	3RT1
Size	S00 to S2	S3	S6 to S12

Rated data of the auxiliary contacts

According to IEC/EN 60947-5-1

Data applies to integrated auxiliary contacts and conventional contacts in the auxiliary switch blocks

Rated insulation voltage U_i (pollution degree 3)	V	690	1 000 (3RT20...-0CC0: 690)	--
• For laterally mountable auxiliary switch blocks	V	690	690	500
• For front mountable auxiliary switch blocks	V	690	690	690

Conventional thermal current I_{th} = rated operational current $I_e/AC-12$ A 10

AC load

Rated operational current $I_e/AC-15/AC-14$

Rated operational current I_e	Up to 230 V	A	10 ¹⁾	6	6
• For rated operational voltage U_e	400 V	A	3		3
	500 V	A	2		2
	690 V	A	1		1 ²⁾

DC load

Rated operational current $I_e/DC-12$

Rated operational current I_e	24 V	A	10		10
• For rated operational voltage U_e	60 V	A	6		6
	110 V	A	3		3
	125 V	A	2		2
	220 V	A	1		1
	440 V	A	0.3		0.3
	600 V	A	0.15		0.15 ²⁾

Rated operational current $I_e/DC-13$

Rated operational current I_e	24 V	A	10 ¹⁾		10 ³⁾
• For rated operational voltage U_e	60 V	A	2		2
	110 V	A	1		1
	125 V	A	0.9		0.9
	220 V	A	0.3		0.3
	440 V	A	0.14		0.14
	600 V	A	0.1		0.15 ²⁾

Contact reliability at 17 V, 1 mA

Acc. to IEC/EN 60947-5-4

Frequency of contact faults $< 10^{-8}$ i.e. < 1 fault per 100 million operating cycles

1) 3RH22, 3RH29, 3RT2...-...4, 3RT2...-...6: $I_e = 6$ A at AC-15/AC-14 and DC-13.
 2) For laterally mountable auxiliary switch blocks, only the rated operational voltages up to 500 V apply.
 3) For laterally mountable auxiliary switch blocks, DC-13/at 24 V: Max. 6 A.

Contactors for Switching Motors

SIRIUS 3RT contactors, 3-pole up to 500 HP

Type
Size

3RT contactors
S00 to S12

Contact endurance of the auxiliary contacts

It is assumed that the operating mechanisms are switched randomly, i.e. not synchronized with the phase angle of the supply system.

The contact endurance is mainly dependent on the breaking current.

Sizes S00 to S3

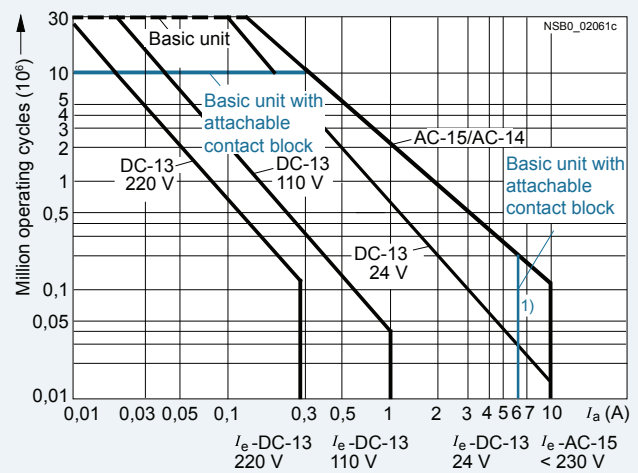

The characteristic curves apply to:

- Integrated auxiliary contacts on 3RT2.
- 3RH2911, 3RH2921 auxiliary switch blocks¹⁾

Sizes S6 to S12

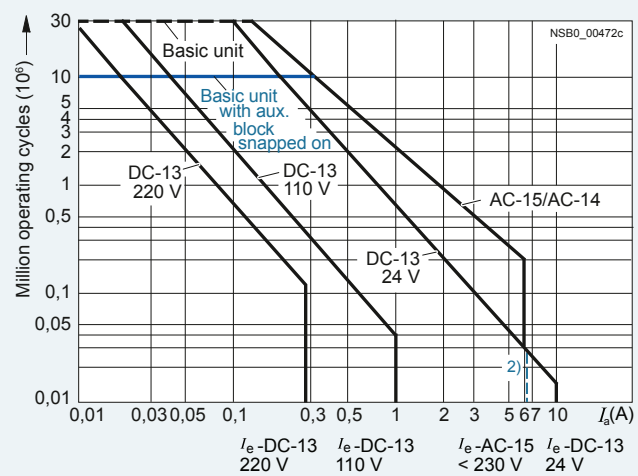

The characteristic curves apply to:

- Integrated auxiliary contacts on 3RT10
- 3RH1911, 3RH1921 auxiliary switch blocks³⁾

¹⁾ 3RH22, 3RH29, 3RT2...-...4, 3RT2...-...6: $I_e = 6$ A at AC-15/AC-14 and DC-13, 3RT2.4: $I_e = 6$ A at AC-15/AC-14.

²⁾ For laterally mountable auxiliary switch blocks, DC-13/at 24 V: Max. 6 A.

³⁾ For laterally mountable auxiliary switch blocks, only the rated operational voltages up to 500 V apply.

Contactors for Switching Motors

SIRIUS 3RT contactors, 3-pole up to 500 HP

Type
Size

3RT2 contactors
S00 and S0

Contact endurance of the main contacts

The characteristic curves show the contact endurance of the contactors when switching resistive and inductive AC loads (AC-1/AC-3) depending on the breaking current and rated operational voltage. It is assumed that the operating mechanisms are switched randomly, i.e. not synchronized with the phase angle of the supply system.

The rated operational current I_e complies with utilization category AC-4 (breaking 6 times the rated operational current) and is intended for a contact endurance of approximately 200 000 operating cycles.

If a shorter contact endurance is sufficient, the rated operational current $I_e/AC-4$ can be increased.

If the contacts are used for mixed operation, i.e. normal switching (breaking the rated operational current according to utilization category AC-3) in combination with intermittent inching (breaking several times the rated operational current according to utilization category AC-4), the contact endurance can be calculated approximately from the following equation:

$$X = \frac{A}{1 + \frac{C}{100} \frac{A}{B} - 1}$$

Characters in the equation:

- X Contact endurance for mixed operation in operating cycles
- A Contact endurance for normal operation ($I_a = I_e$) in operating cycles
- B Contact endurance for inching ($I_a = \text{multiple of } I_e$) in operating cycles
- C Inching operations as a percentage of total switching operations

Size S00

Operating cycles at

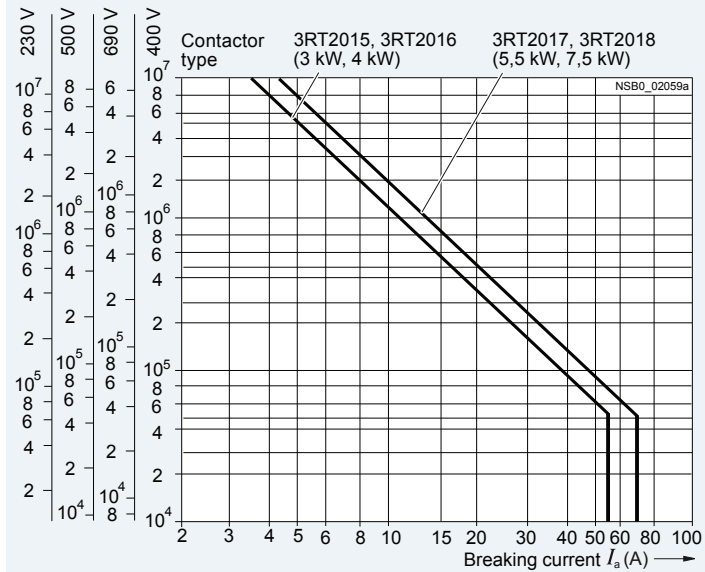

Size S0

Operating cycles at

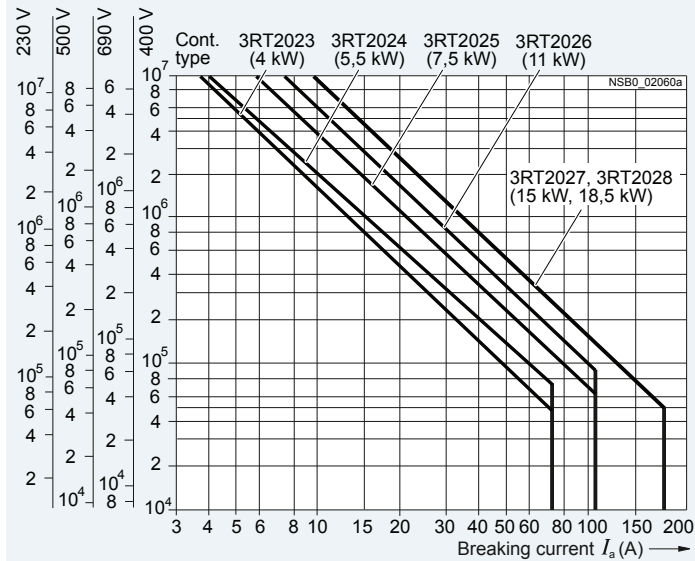

Contactors for Switching Motors

SIRIUS 3RT contactors, 3-pole up to 500 HP

CONTACTORS AND ASSEMBLIES

Type **3RT2 contactors**
 Size **S2 to S12**

Contact endurance of the main contacts

Size S2

Operating cycles at

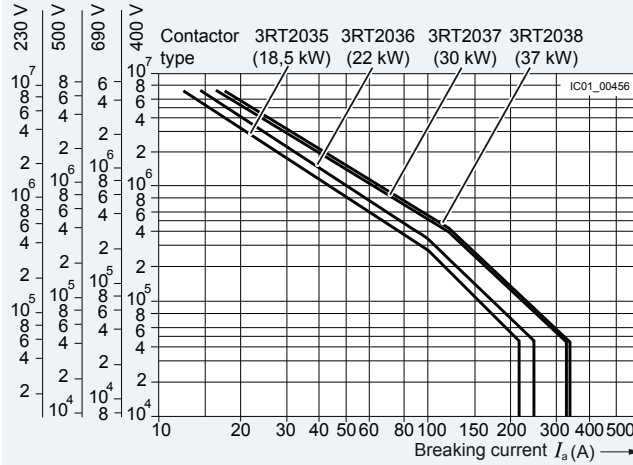

Size S3

Operating cycles at

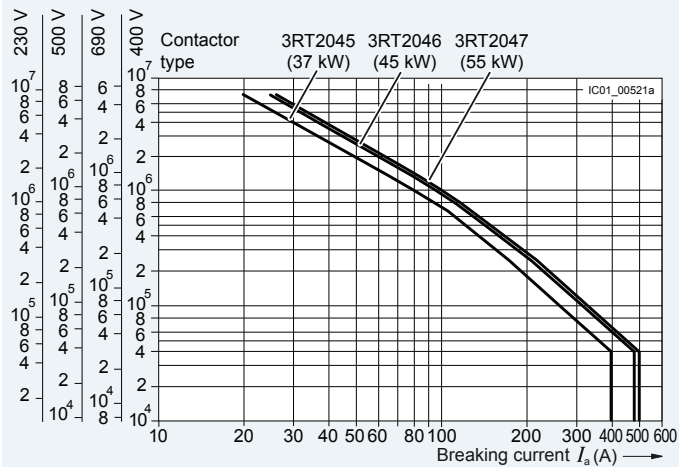

Sizes S6 to S12

Operating cycles at

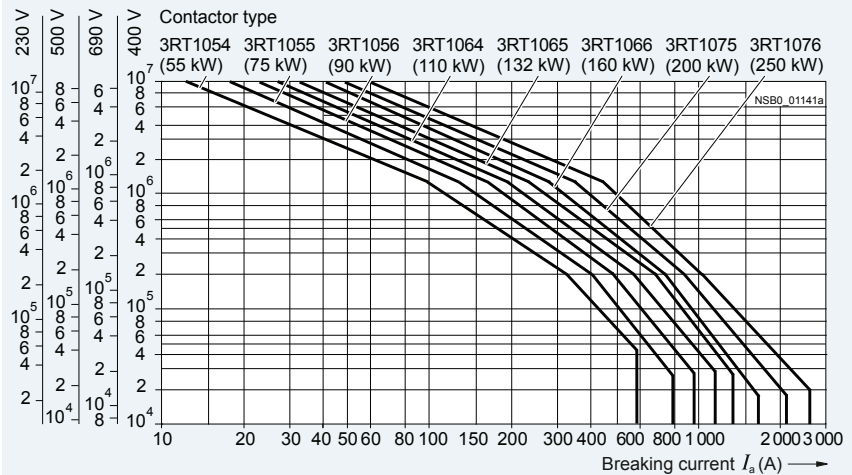

Contactors for Switching Motors

SIRIUS 3RT contactors, 3-pole up to 500 HP

		Contactors	
		3RT2015, 3RT2016	3RT2017, 3RT2018
Type		S00	
Size			
General data			
Dimensions (W x H x D)			
<ul style="list-style-type: none"> Basic unit <ul style="list-style-type: none"> Screw terminals Spring-type terminals Basic unit with mounted auxiliary switch block <ul style="list-style-type: none"> Screw terminals Spring-type terminals Basic unit with mounted function module or solid-state time-delayed auxiliary switch block <ul style="list-style-type: none"> Screw terminals Spring-type terminals 		mm	45 x 58 x 73
		mm	45 x 70 x 73
		mm	45 x 58 x 117
		mm	45 x 70 x 121
		mm	45 x 58 x 147
		mm	45 x 70 x 147
Permissible mounting position			
The contactors are designed for operation on a vertical mounting surface.			
Upright mounting position		<p>Special version required</p>	
Mechanical endurance			
<ul style="list-style-type: none"> Basic unit 	Operating cycles	30 million	
<ul style="list-style-type: none"> Basic unit with mounted auxiliary switch block 	Operating cycles	10 million	
<ul style="list-style-type: none"> Basic unit with solid-state compatible auxiliary switch block 	Operating cycles	5 million	
Electrical endurance			
For contact endurance of the main contacts, see page 3/20 .			
Rated insulation voltage U_i (pollution degree 3)	V	690	
Rated impulse withstand voltage U_{imp}	kV	6	
Protective separation between the coil and the main contacts acc. to IEC 60947-1, Appendix N	V	400	
Mirror contacts			
A mirror contact is an auxiliary NC contact that cannot be closed simultaneously with an NO main contact.			
<ul style="list-style-type: none"> 3RT2.1. (removable auxiliary switch block) 	Yes, this applies to both the basic unit as well as to between the basic unit and the mounted auxiliary switch block acc. to IEC 60947-4-1, Appendix F		
<ul style="list-style-type: none"> 3RH2919-.NF.. solid-state compatible auxiliary switch blocks 	No mirror contact for size S00		
Ambient temperature			
<ul style="list-style-type: none"> During operation 	°C	-25 ... +60	
<ul style="list-style-type: none"> During storage 	°C	-55 ... +80	
Degree of protection acc. to IEC 60529			
<ul style="list-style-type: none"> On front 	IP20 (screw terminals and spring-type terminals)		
<ul style="list-style-type: none"> Connecting terminal 	IP20 (screw terminals and spring-type terminals)		
Touch protection acc. to IEC 60529			
Finger-safe (screw terminals and spring-type terminals)			
Shock resistance			
<ul style="list-style-type: none"> Rectangular pulse <ul style="list-style-type: none"> AC operation DC operation 	g/ms	6.7/5 and 4.2/10	7.3/5 and 4.7/10
	g/ms	6.7/5 and 4.2/10	7.3/5 and 4.7/10
<ul style="list-style-type: none"> Sine pulse <ul style="list-style-type: none"> AC operation DC operation 	g/ms	10.5/5 and 6.6/10	11.4/5 and 7.3/10
	g/ms	10.5/5 and 6.6/10	11.4/5 and 7.3/10

Contactors for Switching Motors

Power Contactors, 3-pole up to 500 HP



		Contactors	
		3RT2015, 3RT2016	3RT2017, 3RT2018
Type		S00	
Size		S00	
Short-circuit protection			
Main circuit			
• Fuse links, operational class gG: LV HRC, type 3NA; DIAZED, type 5SB; NEOZED, type 5SE acc. to IEC/EN 60947-4-1			
- Type of coordination "1"	A	35	50
- Type of coordination "2"	A	20	25
- Weld-free (test conditions acc. to IEC 60947-4-1)	A	10	
• Miniature circuit breaker (up to 230 V) with C characteristic Short-circuit current 1 kA, type of coordination "1"	A	10	
Auxiliary circuit			
Short-circuit test acc. to IEC/EN 60947-5-1			
• With fuse links, operational class gG: DIAZED, type 5SB; NEOZED, type 5SE with short-circuit current $I_k = 1$ kA	A	10	
• With 230 V miniature circuit breaker, C characteristic with short-circuit current $I_k = 400$ A	A	6	
Short-circuit protection for contactors with overload relays		See "Configuring the SIRIUS Modular System – Selection data for Fuseless and Fused Load Feeders", https://support.industry.siemens.com/cs/ww/en/view/39714188	
Short-circuit protection for fuseless load feeders		See 3RA2 load feeders on page 8/4 onwards	
Control			
Solenoid coil operating range			
• AC operation	50 Hz	0.8 ... 1.1 x U_s	
	60 Hz	0.85 ... 1.1 x U_s	
• DC operation	Up to 50 °C	0.8 ... 1.1 x U_s	
	Up to 60 °C	0.85 ... 1.1 x U_s	
Power consumption of the solenoid coils (for cold coil and 1.0 x U_s)			
• AC operation, 50/60 Hz, standard version			
- Closing	VA	27/24.3	37/33
- P.f.		0.8/0.75	
- Closed	VA	4.2/3.3	5.7/4.4
- P.f.		0.25/0.25	
• AC operation, 50 Hz, for USA/Canada			
- Closing	VA	26.4	36
- P.f. for closing		0.81	0.8
- Closed	VA	4.4	5.9
- P.f. for closed		0.24	
• AC operation, 60 Hz, for USA/Canada			
- Closing	VA	31.7	43
- P.f. for closing		0.81	0.8
- Closed	VA	4.8	6.5
- P.f. for closed		0.25	
• DC operation (closing = closed)	W	4	
Permissible residual current of the electronics (with 0 signal)			
• AC operation		< 3 mA x (230 V/ U_s) ¹⁾	< 4 mA x (230 V/ U_s) ¹⁾
• DC operation		< 10 mA x (24 V/ U_s) ¹⁾	
Operating times at 1.0 x U_s²⁾			
Total break time = Opening delay + Arcing time			
• AC operation			
- Closing delay	ms	9.5 ... 24	9 ... 22
- Opening delay	ms	4 ... 14	4.5 ... 15
• DC operation			
- Closing delay	ms	35 ... 50	
- Opening delay	ms	7 ... 12	
• Arcing time	ms	10 ... 15	



¹⁾ The 3RT2916-1GA00 additional load module is recommended for higher residual currents, see page 3/114.

²⁾ The OFF-delay times of the NO contacts and the ON-delay times of the NC contacts increase if the contactor coils are attenuated against voltage peaks (suppression diode 6x to 10x; diode assembly 2x to 6x; suppression diode +1 to 5 ms; varistor +2 to 5 ms).

Contactors for Switching Motors

SIRIUS 3RT contactors, 3-pole up to 500 HP

		Coupling contactors		
Type		3RT201.-.HB4.	3RT201.-.JB4.	3RT201.-.KB4.
Size		S00		
Control				
Solenoid coil operating range		0.7 ... 1.25 x U _s		
Power consumption of the solenoid coils (for cold coil) Closing = Closed	At U _s 24 V DC W	2.8		
Permissible residual current of the electronics (with 0 signal)		< 6 mA x (24 V/U _s)		
Upright mounting position		On request		
Overvoltage configuration of the solenoid coil		No overvoltage damping 	Built-in diode 	Built-in suppressor diode 
Operating times				
• Closing delay				
- ON-delay NO	ms	35 ... 60		
- OFF-delay NC	ms	25 ... 40		
• Opening delay				
- ON-delay NO	ms	7 ... 20	38 ... 65	7 ... 20
- OFF-delay NC	ms	20 ... 30	55 ... 75	20 ... 30

		Coupling contactors		
Type		3RT201.-1MB4.-0KT0	3RT201.-1VB4.	3RT201.-1SB4.
Size		S00		
Control				
Solenoid coil operating range		0.85 ... 1.85 x U _s		
Power consumption of the solenoid coils (for cold coil) Closing = Closed	At U _s 24 V DC W	1.6		
Permissible residual current, upright mounting position		On request		
Overvoltage configuration of the solenoid coil		No overvoltage damping 	Built-in diode 	Built-in suppressor diode 
Operating times				
• Closing delay				
- ON-delay NO	ms	25 ... 90		
- OFF-delay NC	ms	15 ... 80		
• Opening delay				
- ON-delay NO	ms	5 ... 20	20 ... 80	5 ... 20
- OFF-delay NC	ms	10 ... 30	30 ... 90	10 ... 30

Contactors for Switching Motors

SIRIUS 3RT contactors, 3-pole up to 500 HP

CONTACTORS AND ASSEMBLIES 2

Type Size	Contactors			
	3RT2015	3RT2016	3RT2017	3RT2018
Rated data of the main contacts				
Load rating with AC				
Utilization category AC-1, switching resistive loads				
• Rated operational currents I_e	At 40 °C up to 690 V A At 60 °C up to 690 V A	18 16	22 20	
• Rated power for AC loads ¹⁾ P.f. = 0.95 (at 60 °C)	230 V kW 400 V kW 690 V kW	6 10.5 18	7.5 13 22	
• Minimum conductor cross-section for loads with I_e	At 40 °C mm ² At 60 °C mm ²	2.5 2.5	4	
Utilization categories AC-2 and AC-3				
• Rated operational currents I_e	Up to 400 V A 440 V A 500 V A 690 V A	7 7 6 4.9	9 9 7.7 6.7	12 11 9.2 8.9
• Rated power for slipping or squirrel-cage motors at 50 and 60 Hz	At 230 V kW 400 V kW 690 V kW	1.5 3 4	2.2 4 5.5	3 5.5 7.5
Thermal load capacity	10 s current A	56	72	96
Power loss per conducting path	At $I_e/AC-3$ W	0.42	0.7	1.24
Utilization category AC-4 (at $I_a = 6 \times I_e$)²⁾				
• Maximum values				
- Rated operational current I_e	Up to 400 V A	6.5	8.5	11.5
- Rated power for squirrel-cage motors with 50 Hz and 60 Hz	Up to 400 V kW	3	4	5.5
• The following applies to a contact endurance of about 200 000 operating cycles:				
- Rated operational currents I_e	Up to 400 V A 690 V A	2.6 1.8	4.1 3.3	5.5 4.4
- Rated power for squirrel-cage motors with 50 Hz and 60 Hz	At 230 V kW 400 V kW 690 V kW	0.67 1.15 1.15	1.1 2 2.5	1.5 2.5 3.5

1) Industrial furnaces and electric heaters with resistance heating, etc. (increased power consumption on heating up has been taken into account).
 2) The data applies to 3RT2516 and 3RT2517 contactors (2 NO + 2 NC) up to a rated operational voltage of 400 V only.

Contactors for Switching Motors

SIRIUS 3RT contactors, 3-pole up to 500 HP

Type	Contactors	
Size	3RT2015	3RT2016 to 3RT2018
	S00	

Rated data of the main contacts (continued)

Load rating with DC
Utilization category DC-1, switching resistive loads (L/R 1 ms)
 • Rated operational currents I_e (at 60 °C)

- 1 conducting path	Up to 24 V A	15	20
	60 V A	15	20
	110 V A	1.5	2.1
	220 V A	0.6	0.8
	440 V A	0.42	0.6
	600 V A	0.42	0.6
- 2 conducting paths in series	Up to 24 V A	15	20
	60 V A	15	20
	110 V A	8.4	12
	220 V A	1.2	1.6
	440 V A	0.6	0.8
	600 V A	0.5	0.7
- 3 conducting paths in series	Up to 24 V A	15	20
	60 V A	15	20
	110 V A	15	20
	220 V A	15	20
	440 V A	0.9	1.3
	600 V A	0.7	1

Utilization category DC-3/DC-5, shunt-wound and series-wound motors (L/R 15 ms)
 • Rated operational currents I_e (at 60 °C)

- 1 conducting path	Up to 24 V A	15	20
	60 V A	0.35	0.5
	110 V A	0.1	0.15
	220 V A	--	
	440 V A	--	
	600 V A	--	
- 2 conducting paths in series	Up to 24 V A	15	20
	60 V A	3.5	5
	110 V A	0.25	0.35
	220 V A	--	
	440 V A	--	
	600 V A	--	
- 3 conducting paths in series	Up to 24 V A	15	20
	60 V A	15	20
	110 V A	15	20
	220 V A	1.2	1.5
	440 V A	0.14	0.2
	600 V A	0.14	0.2

Switching frequency
Switching frequency z in operating cycles/hour

Contactors without overload relays

• No-load switching frequency	AC/DC	h ⁻¹	10 000
• Switching frequency z during rated operation ¹⁾			
- $I_e/AC-1$	At 400 V	h ⁻¹	1 000
- $I_e/AC-2$	At 400 V	h ⁻¹	750
- $I_e/AC-3$	At 400 V	h ⁻¹	750
- $I_e/AC-4$	At 400 V	h ⁻¹	250

Contactors with overload relays

• Mean value		h ⁻¹	15
--------------	--	-----------------	----

¹⁾ Dependence of the switching frequency z' on the operational current I' and operational voltage U' :
 $z' = z (I_e/I') (U_e/U')^{1.5}$ 1/h.

Contactors for Switching Motors

SIRIUS 3RT contactors, 3-pole up to 500 HP



Type	Contactors	
Size	3RT2015 to 3RT2018	
S00		
Conductor cross-sections		
Main conductors, auxiliary conductors and coil terminals (1 or 2 conductors can be connected)		
• Solid or stranded	mm ²	2 x (0.5 ... 1.5) ¹⁾ ; 2 x (0.75 ... 2.5) ¹⁾ ; max. 2 x 4
• Finely stranded with end sleeve (DIN 46228-1)	mm ²	
• AWG cables, solid or stranded	AWG	2 x (0.5 ... 1.5) ¹⁾ ; 2 x (0.75 ... 2.5) ¹⁾
• Terminal screw		2 x (20 ... 16) ¹⁾ ; 2 x (18 ... 14) ¹⁾ ; 2 x 12
• Tightening torque	Nm	M3 (for Pozidriv size 2; 5 ... 6) 0.8 ... 1.2 (7 ... 10.3 lb.in)
Main conductors, auxiliary conductors and coil terminals²⁾ (1 or 2 conductors can be connected)		
• Operating devices	mm	3.0 x 0.5
• Solid or stranded	mm ²	
• Finely stranded with end sleeve (DIN 46228-1)	mm ²	2 x (0.5 ... 4)
• Finely stranded without end sleeve	mm ²	2 x (0.5 ... 2.5)
• AWG cables, solid or stranded	AWG	2 x (0.5 ... 2.5)
Auxiliary conductors for front and laterally mounted auxiliary switches²⁾ (1 or 2 conductors can be connected)		
• Operating devices	mm	3.0 x 0.5
• Solid or stranded	mm ²	
• Finely stranded with end sleeve (DIN 46228-1)	mm ²	2 x (0.5 ... 1.5)
• Finely stranded without end sleeve	mm ²	2 x (0.5 ... 2.5)
• AWG cables, solid or stranded	AWG	2 x (20 ... 14)

¹⁾ If two different conductor cross-sections are connected to one clamping point, both cross-sections must lie in one of the ranges specified.

²⁾ Max. external diameter of the cable insulation: 3.6 mm.
On spring-type terminals with conductor cross-sections > 1 mm², an insulation stop must be used, see page 3/115.

Contactors for Switching Motors

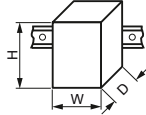
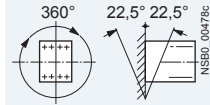
SIRIUS 3RT contactors, 3-pole up to 500 HP

		Contactors																																					
		3RT2023 to 3RT2025	3RT2026 to 3RT2028																																				
		S0																																					
Type																																							
Size																																							
General data																																							
Dimensions (W x H x D)																																							
<div style="display: flex; align-items: center;">  <table border="1" style="border-collapse: collapse; width: 100%;"> <tr> <td>mm</td> <td>45 x 85 x 97</td> <td></td> </tr> <tr> <td>mm</td> <td>45 x 102 x 97</td> <td></td> </tr> <tr> <td>mm</td> <td>45 x 85 x 141</td> <td></td> </tr> <tr> <td>mm</td> <td>45 x 102 x 145</td> <td></td> </tr> <tr> <td>mm</td> <td>45 x 85 x 171</td> <td></td> </tr> <tr> <td>mm</td> <td>45 x 102 x 171</td> <td></td> </tr> <tr> <td>mm</td> <td>45 x 85 x 107</td> <td></td> </tr> <tr> <td>mm</td> <td>45 x 102 x 107</td> <td></td> </tr> <tr> <td>mm</td> <td>45 x 85 x 151</td> <td></td> </tr> <tr> <td>mm</td> <td>45 x 102 x 155</td> <td></td> </tr> <tr> <td>mm</td> <td>45 x 85 x 181</td> <td></td> </tr> <tr> <td>mm</td> <td>45 x 102 x 181</td> <td></td> </tr> </table> </div>				mm	45 x 85 x 97		mm	45 x 102 x 97		mm	45 x 85 x 141		mm	45 x 102 x 145		mm	45 x 85 x 171		mm	45 x 102 x 171		mm	45 x 85 x 107		mm	45 x 102 x 107		mm	45 x 85 x 151		mm	45 x 102 x 155		mm	45 x 85 x 181		mm	45 x 102 x 181	
mm	45 x 85 x 97																																						
mm	45 x 102 x 97																																						
mm	45 x 85 x 141																																						
mm	45 x 102 x 145																																						
mm	45 x 85 x 171																																						
mm	45 x 102 x 171																																						
mm	45 x 85 x 107																																						
mm	45 x 102 x 107																																						
mm	45 x 85 x 151																																						
mm	45 x 102 x 155																																						
mm	45 x 85 x 181																																						
mm	45 x 102 x 181																																						
<u>AC operation</u>																																							
<ul style="list-style-type: none"> Basic unit <ul style="list-style-type: none"> Screw terminals Spring-type terminals Basic unit with mounted auxiliary switch block <ul style="list-style-type: none"> Screw terminals Spring-type terminals Basic unit with mounted function module or solid-state time-delayed auxiliary switch block <ul style="list-style-type: none"> Screw terminals Spring-type terminals 																																							
<u>DC operation</u>																																							
<ul style="list-style-type: none"> Basic unit <ul style="list-style-type: none"> Screw terminals Spring-type terminals Basic unit with mounted auxiliary switch block <ul style="list-style-type: none"> Screw terminals Spring-type terminals Basic unit with mounted function module or solid-state time-delayed auxiliary switch block <ul style="list-style-type: none"> Screw terminals Spring-type terminals 																																							
Permissible mounting position																																							
The contactors are designed for operation on a vertical mounting surface.																																							
Upright mounting position		 <p>Special version required, also applies to 3RT202...K.40 coupling contactors</p>																																					
Mechanical endurance																																							
<ul style="list-style-type: none"> Basic unit and basic unit with mounted auxiliary switch block 		Operating cycles	10 million																																				
<ul style="list-style-type: none"> Basic unit with solid-state compatible auxiliary switch block 		Operating cycles	5 million																																				
Electrical endurance																																							
		For contact endurance of the main contacts, see page 3/20 .																																					
Rated insulation voltage U_i (pollution degree 3)	V	690																																					
Rated impulse withstand voltage U_{imp}	kV	6																																					
Protective separation between the coil and the main contacts (acc. to IEC 60947-1, Appendix N)	V	400																																					
Mirror contacts																																							
A mirror contact is an auxiliary NC contact that cannot be closed simultaneously with an NO main contact.																																							
<ul style="list-style-type: none"> Integrated auxiliary switches 		Yes, acc. to IEC 60947-4-1, Appendix F																																					
<ul style="list-style-type: none"> 3RT2.2. (removable auxiliary switch block) 		Yes, acc. to IEC 60947-4-1, Appendix F																																					
Permissible ambient temperature																																							
<ul style="list-style-type: none"> During operation 		°C	-25 ... +60																																				
<ul style="list-style-type: none"> During storage 		°C	-55 ... +80																																				
Degree of protection acc. to IEC 60529																																							
<ul style="list-style-type: none"> On front 		IP20 (screw terminals and spring-type terminals)																																					
<ul style="list-style-type: none"> Connecting terminal 		IP20 (screw terminals and spring-type terminals)																																					
Touch protection acc. to IEC 60529																																							
Finger-safe (screw terminals and spring-type terminals)																																							
Shock resistance																																							
<ul style="list-style-type: none"> Rectangular pulse <ul style="list-style-type: none"> AC operation DC operation 		g/ms	7.5/5 and 4.7/10																																				
		g/ms	10/5 and 7.5/10																																				
<ul style="list-style-type: none"> Sine pulse <ul style="list-style-type: none"> AC operation DC operation 		g/ms	11.8/5 and 7.4/10																																				
		g/ms	15/5 and 10/10																																				
			8.3/5 and 5.3/10																																				
			13.5/5 and 8.3/10																																				

Contactors for Switching Motors

SIRIUS 3RT contactors, 3-pole up to 500 HP

		Contactors		
Type		3RT2023 to 3RT2025	3RT2026	3RT2027, 3RT2028
Size		S0		
Short-circuit protection				
Main circuit				
• Fuse links, operational class gG: LV HRC, type 3NA; DIAZED, type 5SB; NEOZED, type 5SE acc. to IEC/EN 60947-4-1				
- Type of coordination "1"	A	63	100	125
- Type of coordination "2"	A	25	35	50
- Weld-free (test conditions according to IEC 60947-4-1)	A	10	16	
• Miniature circuit breaker with C characteristic (short-circuit current 3 kA, type of coordination "1")	A	25	32	40
Auxiliary circuit				
• Fuse links, operational class gG: DIAZED, type 5SB; NEOZED, type 5SE (weld-free protection at $I_k = 1$ kA)	A	10		
• 230 V miniature circuit breaker, C characteristic (short-circuit current $I_k < 400$ A)	A	10		
Short-circuit protection for contactors with overload relays	See "Configuring the SIRIUS Modular System – Selection data for Fuseless and Fused Load Feeders", https://support.industry.siemens.com/cs/ww/en/view/39714188			
Short-circuit protection for fuseless load feeders	See 3RA2 load feeders on page 8/4 onwards			

		Contactors				
Type		3RT2023 to 3RT2025	3RT2026 to 3RT2028	3RT202..-NB3	3RT202..-NF3..	3RT202..-NP3
Size		S0				
Control						
Type of operating mechanism		AC or DC		AC/DC		
Solenoid coil operating range		AC/DC	0.8 ... 1.1 x $U_s^{(1)}$		0.7 ... 1.3 x $U_s^{(2)}$	
Power consumption of the solenoid coils (for cold coil and 1.0 x U_s)						
• AC operation, 50 Hz, standard version						
- Closing	VA	65	77	6.6	11.9	12.7
- P.f.		0.82		0.98		
- Closed	VA	7.6	9.8	1.9	1.6	3.9
- P.f.		0.25		0.86	0.79	0.51
• AC operation, 50/60 Hz, standard version						
- Closing	VA	68/67	81/79	6.6/6.7	11.9/12.0	12.7/14.7
- P.f.		0.72/0.74		0.98/0.98		
- Closed	VA	7.9/6.5	10.5/8.5	1.9/2.0	1.6/1.8	3.9/4.3
- P.f.		0.25/0.28		0.86/0.82	0.79/0.74	0.51/0.56
• AC operation, 50 Hz, for USA/Canada						
- Closing	VA	65	77	--		
- P.f.		0.82	0.82	--		
- Closed	VA	7.6	9.8	--		
- P.f.		0.25	0.28	--		
• AC operation, 60 Hz, for USA/Canada						
- Closing	VA	73	87	--		
- P.f.		0.76		--		
- Closed	VA	7.2	9.4	--		
- P.f.		0.28		--		
• DC operation (closing = closed)		W	5.9/5.9	5.9/1.4	10.2/1.3	14.3/1.9
Permissible residual current of the electronics (with 0 signal)						
• AC operation		mA	< 6 mA x (230 V/ U_s)		< 7 mA x (230 V/ U_s)	
• DC operation		mA	< 16 mA x (24 V/ U_s)			
Operating times at 1.0 x $U_s^{(3)}$						
• AC operation						
- Closing delay	ms	10 ... 18	10 ... 17	65 ... 80	50 ... 70	60 ... 80
- Opening delay	ms	4 ... 16		30 ... 45	35 ... 45	30 ... 50
• DC operation						
- Closing delay	ms	55 ... 80		60 ... 80	56 ... 70	60 ... 80
- Opening delay	ms	16 ... 17		30 ... 45	35 ... 45	30 ... 50
• Arcing time		ms	10			

1) Coil operating range
- At 50 Hz: 0.8 to 1.1 x U_s
- At 60 Hz: 0.85 to 1.1 x U_s .

2) The following applies to $U_{s\ max} = 280$ V: Upper limit = 1.1 x $U_{s\ max}$.

3) The OFF-delay of the NO contact and the ON-delay of the NC contact are increased if the contactor coils are attenuated against voltage peaks (varistor +2 ms to 5 ms, diode assembly: 2x to 6x).

Contactors for Switching Motors

SIRIUS 3RT contactors, 3-pole up to 500 HP

		Coupling contactors 3RT202.-.KB4. S0	
Type			
Size			
Control			
Solenoid coil operating range		0.7 ... 1.25 x U_s	
Power consumption of the solenoid coils (for cold coil) Closing = Closed		At U_s 24 V DC W	4.5
Permissible residual current of the electronics (with 0 signal)		< 10 mA x (24 V/ U_s)	
Overvoltage configuration of the solenoid coil		Built-in varistor 	
Operating times			
• Closing delay			
- ON-delay NO	ms	65 ... 90	
- OFF-delay NC	ms	55 ... 80	
• Opening delay			
- ON-delay NO	ms	19 ... 21	
- OFF-delay NC	ms	25 ... 31	

		Contactors						
		3RT2023	3RT2024	3RT2025	3RT2026	3RT2027	3RT2028	
Type		S0						
Size								
Rated data of the main contacts								
Load rating with AC								
Utilization category AC-1, switching resistive loads								
• Rated operational current I_e		At 40 °C up to 690 V A	40			50		
		At 60 °C up to 690 V A	35			42		
• Rated power for AC loads ¹⁾ P.f. = 0.95 (at 60 °C)		230 V kW	13.3			15.5		
		400 V kW	23			27.5		
		690 V kW	40			47.5		
• Minimum conductor cross-section for loads with I_e		At 40 °C mm ²	10					
		At 60 °C mm ²	10					
Utilization categories AC-2 and AC-3								
• Rated operational currents I_e		Up to 400 V A	9	12	17	25	32	38
		440 V A	9	12	17	22	32	35
		500 V A	9	12	17	18	32	
		690 V A	9		13		21	
• Rated power for slipping or squirrel-cage motors at 50 and 60 Hz		At 230 V kW	2.2	3	4	5.5	7.5	11
		400 V kW	4	5.5	7.5	11	15	18.5
		690 V kW	7.5		11		18.5	
Thermal load capacity		10 s current A	80	110	150	200	260	300
Power loss per conducting path		At $I_e/AC-3$ W	0.4	0.5	0.9	1.6	2.7	3.8
Utilization category AC-4 (for $I_a = 6 \times I_e$)								
• Maximum values:								
- Rated operational current I_e		Up to 400 V A	8.5	12.5	15.5		22	
- Rated power for squirrel-cage motors with 50 Hz and 60 Hz		At 400 V kW	4	5.5	7.5		11	
• The following applies to a contact endurance of about 200 000 operating cycles:								
- Rated operational currents I_e		Up to 400 V A	4.1	5.5	7.7	9	12	
		690 V A	3.3	5.5	7.7	9	12	
- Rated power for squirrel-cage motors with 50 Hz and 60 Hz		At 110 V kW	0.5	0.73	1	1.2	1.6	
		230 V kW	1.1	1.5	2	2.5	3.4	
		400 V kW	2	2.6	3.5	4.4	6	
		690 V kW	2.5	4.6	6	7.7	10.3	

¹⁾ Industrial furnaces and electric heaters with resistance heating, etc. (increased power consumption on heating up has been taken into account).

Contactors for Switching Motors

SIRIUS 3RT contactors, 3-pole up to 500 HP

Type	Contactors	
Size	3RT2023 to 3RT2025	3RT2026 to 3RT2028
	S0	

Rated data of the main contacts (continued)

Load rating with DC

Utilization category DC-1, switching resistive loads (L/R 1 ms)

• Rated operational currents I_e (at 60 °C)			
- 1 conducting path	Up to 24 V A	35	
	60 V A	20	
	110 V A	4.5	
	220 V A	1	
	440 V A	0.4	
	600 V A	0.25	
- 2 conducting paths in series	Up to 24 V A	35	
	60 V A	35	
	110 V A	35	
	220 V A	5	
	440 V A	1	
	600 V A	0.8	
- 3 conducting paths in series	Up to 24 V A	35	
	60 V A	35	
	110 V A	35	
	220 V A	35	
	440 V A	2.9	
	600 V A	1.4	

Utilization category DC-3/DC-5, shunt-wound and series-wound motors (L/R 15 ms)

• Rated operational currents I_e (at 60 °C)			
- 1 conducting path	Up to 24 V A	20	
	60 V A	5	
	110 V A	2.5	
	220 V A	1	
	440 V A	0.09	
	600 V A	0.06	
- 2 conducting paths in series	Up to 24 V A	35	
	60 V A	35	
	110 V A	15	
	220 V A	3	
	440 V A	0.27	
	600 V A	0.16	
- 3 conducting paths in series	Up to 24 V A	35	
	60 V A	35	
	110 V A	35	
	220 V A	10	
	440 V A	0.6	
	600 V A	0.6	

Switching frequency

Switching frequency z in operating cycles/hour

Contactors without overload relays

• No-load switching frequency	AC h ⁻¹	5 000	
	DC h ⁻¹	1 500	
• Switching frequency z during rated operation ¹⁾			
- $I_e/AC-1$	At 400 V h ⁻¹	1 000	
- $I_e/AC-2$	At 400 V h ⁻¹	1 000	750
- $I_e/AC-3$	At 400 V h ⁻¹	1 000	750
- $I_e/AC-4$	At 400 V h ⁻¹	300	250

Contactors with overload relays

• Mean value	h ⁻¹	15	
--------------	-----------------	----	--

¹⁾ Dependence of the switching frequency z' on the operational current I' and operational voltage U':
 $z' = z \cdot (I_e/I') \cdot (U_e/U)^{1.5}$ 1/h.

Contactors for Switching Motors

SIRIUS 3RT contactors, 3-pole up to 500 HP

		Contactors	
		3RT2023 to 3RT2028	
Type		S0	
Size			
Conductor cross-sections			
Main conductors (1 or 2 conductors can be connected)		Screw terminals	
• Solid or stranded	mm ²	2 x (1 ... 2.5) ¹⁾ ; 2 x (2.5 ... 10) ¹⁾	
• Finely stranded with end sleeve (DIN 46228-1)	mm ²	2 x (1 ... 2.5) ¹⁾ ; 2 x (2.5 ... 6) ¹⁾ ; 1 x 10	
• AWG cables, solid or stranded	AWG	2 x (16 ... 12) ¹⁾ ; 2 x (14 ... 8) ¹⁾	
• Terminal screws - Tightening torque	Nm	M4 (for Pozidriv size 2; 5 ... 6) 2 ... 2.5 (18 ... 22 lb.in)	
Auxiliary conductors (1 or 2 conductors can be connected)			
• Solid or stranded	mm ²	2 x (0.5 ... 1.5) ¹⁾ ; 2 x (0.75 ... 2.5) ¹⁾	
• Finely stranded with end sleeve (DIN 46228-1)	mm ²	2 x (0.5 ... 1.5) ¹⁾ ; 2 x (0.75 ... 2.5) ¹⁾	
• AWG cables, solid or stranded	AWG	2 x (20 ... 16) ¹⁾ ; 2 x (18 ... 14) ¹⁾	
• Terminal screws - Tightening torque	Nm	M3 (for Pozidriv size 2; 5 ... 6) 0.8 ... 1.2 (7 ... 10.3 lb.in)	
Main conductors²⁾ (1 or 2 conductors can be connected)		Spring-type terminals	
• Operating devices	mm	3.0 x 0.5	
• Solid or stranded	mm ²	2 x (1 ... 10)	
• Finely stranded with end sleeve (DIN 46228-1)	mm ²	2 x (1 ... 6)	
• Finely stranded without end sleeve	mm ²	2 x (1 ... 6)	
• AWG cables, solid or stranded	AWG	2 x (18 ... 8)	
Auxiliary conductors²⁾ (1 or 2 conductors can be connected)			
• Operating devices		3.0 x 0.5	
• Solid or stranded	mm ²	2 x (0.5 ... 2.5)	
• Finely stranded with end sleeve (DIN 46228-1)	mm ²	2 x (0.5 ... 1.5)	
• Finely stranded without end sleeve	mm ²	2 x (0.5 ... 2.5)	
• AWG cables, solid or stranded	AWG	2 x (20 ... 14)	

¹⁾ If two different conductor cross-sections are connected to one clamping point, both cross-sections must lie in one of the ranges specified.

²⁾ Max. external diameter of the cable insulation: 3.6 mm. On spring-type terminals with conductor cross-sections > 1 mm², an insulation stop must be used, [see page 3/115](#).

Contactors for Switching Motors

SIRIUS 3RT contactors, 3-pole up to 500 HP

		Contactors			
		3RT2035	3RT2036	3RT2037	3RT2038
		S2			
Type					
Size					
General data					
Dimensions (W x H x D)					
<ul style="list-style-type: none"> Basic unit - Screw/spring-type terminals Basic unit with mounted auxiliary switch block - Screw terminals - Spring-type terminals Basic unit with mounted function module or solid-state time-delayed auxiliary switch block - Screw/spring-type terminals 		mm	55 x 114 x 130		
		mm	55 x 114 x 174		
		mm	55 x 114 x 178		
		mm	55 x 114 x 204		
Permissible mounting position					
The contactors are designed for operation on a vertical mounting surface.					
Upright mounting position					
Mechanical endurance					
<ul style="list-style-type: none"> Basic units and basic units with mounted auxiliary switch block 		Operating cycles	10 million		
<ul style="list-style-type: none"> Basic units with solid-state compatible auxiliary switch block 		Operating cycles	5 million		
Electrical endurance					
For contact endurance of the main contacts, see page 3/21 onwards .					
Rated insulation voltage U_i (pollution degree 3)		V	690		
Rated impulse withstand voltage U_{imp}		kV	6		
Protective separation between the coil and the main contacts (acc. to IEC 60947-1, Appendix N)		V	400		
Mirror contacts					
A mirror contact is an auxiliary NC contact that cannot be closed simultaneously with an NO main contact.					
<ul style="list-style-type: none"> Integrated auxiliary switches 3RT2.3. (removable auxiliary switch block) 			Yes, acc. to IEC 60947-4-1, Appendix F	Yes, acc. to IEC 60947-4-1, Appendix F	
Permissible ambient temperature					
<ul style="list-style-type: none"> During operation 		°C	-25 ... +60		
<ul style="list-style-type: none"> During storage 		°C	-55 ... +80		
Degree of protection acc. to IEC 60529					
<ul style="list-style-type: none"> On front Connecting terminal 			IP20	IP00 (for higher degree of protection, use additional terminal covers)	
Touch protection acc. to IEC 60529					
Finger-safe for vertical touching from the front					
Shock resistance					
<ul style="list-style-type: none"> Rectangular pulse - AC operation - DC operation 		g/ms	11.8/5 and 7.4/10		
		g/ms	7.7/5 and 4.5/10		
<ul style="list-style-type: none"> Sine pulse - AC operation - DC operation 		g/ms	18.5/5 and 11.6/10		
		g/ms	12/5 and 7/10		
Short-circuit protection					
Main circuit					
<ul style="list-style-type: none"> Fuse links, operational class gG: LV HRC, type 3NA; DIAZED, type 5SB; NEOZED, type 5SE acc. to IEC/EN 60947-4-1 - Type of coordination "1" - Type of coordination "2" - Weld-free (test conditions acc. to IEC 60947-4-1) 					
	A	160		250	
	A	80		125	160
	A	16	25	50	
Auxiliary circuit					
<ul style="list-style-type: none"> Fuse links, operational class gG: DIAZED, type 5SB; NEOZED, type 5SE (weld-free protection at I_k 1 kA) 230 V miniature circuit breaker, C characteristic (short-circuit current $I_k < 400$ A) 		A	10		
		A	10		
Short-circuit protection for contactors with overload relays					
See "Configuring the SIRIUS Modular System – Selection data for Fuseless and Fused Load Feeders", https://support.industry.siemens.com/cs/ww/en/view/39714188					
Short-circuit protection for fuseless load feeders					
See 3RA2 load feeders, from page 8/4 onwards					

Contactors for Switching Motors

SIRIUS 3RT contactors, 3-pole up to 500 HP

Type	Contactors		Coupling contactors
Size	3RT203.-.A...	3RT203.-.N.3.	3RT203.-.KB4.
Control			
Type of operating mechanism	AC	AC/DC	DC
Solenoid coil operating range			
• AC operation ¹⁾	0.8 ... 1.1 x U _s	--	--
• AC/DC operation ¹⁾	--	0.8 ... 1.1 x U _s	--
• DC operation	--	--	0.8 ... 1.2 x U _s
Power consumption of the solenoid coils (for cold coil and 1.0 x U _s)			
• AC operation, 50 Hz, standard version			
- Closing	VA	190	--
- P.f.		0.72	--
- Closed	VA	16	--
- P.f.		0.37	--
• AC operation, 50/60 Hz, standard version			
- Closing	VA	210/188	--
- P.f.		0.69/0.65	--
- Closed	VA	17.2/16.5	--
- P.f.		0.36/0.39	--
• AC operation, 60 Hz, for USA/Canada			
- Closing	VA	212	--
- P.f.		0.67	--
- Closed	VA	18.5	--
- P.f.		0.37	--
• AC/DC operation			
- Closing for AC operation	VA	--	40
- P.f.		--	0.95
- Closed for AC operation	VA	--	2
- P.f.		--	0.95
• DC operation			
- Closing for DC operation	W	--	23 ²⁾
- Closed for DC operation	W	--	1
Permissible residual current of the electronics (with 0 signal)			
• AC/DC operation	mA	--	< 20
• DC operation	mA	--	< 20
Overvoltage configuration of the solenoid coil			
	--	Built-in varistor	Built-in varistor
Operating times at 0.7 ... 1.25 x U_s³⁾ Total break time = Opening delay + Arcing time			
• DC operation			
- Closing delay	ms	--	45 ... 60
- Opening delay	ms	--	35 ... 55
Operating times at 1.0 x U_s³⁾			
• AC operation			
- Closing delay	ms	12 ... 22	35 ... 80
- Opening delay	ms	10 ... 18	30 ... 55
• DC operation			
- Closing delay	ms	--	35 ... 80
- Opening delay	ms	--	30 ... 55
• Arcing time	ms	10 ... 20	

¹⁾ Coil operating range
 - At 50 Hz: 0.8 to 1.1 x U_s
 - At 60 Hz: 0.85 to 1.1 x U_s.

²⁾ In the case of AC/DC coils, increased starting currents (2.6 A on average) occur during the first 200 ms. For direct control from a PLC, we recommend special 3RT203.-.KB4. coupling contactors with adapted power consumption, suitable for a PLC output current of 2 A (see page 3/62).

³⁾ The OFF-delay of the NO contact and the ON-delay of the NC contact are increased if the contactor coils are attenuated against voltage peaks (varistor +2 ms to 5 ms, diode assembly: 2x to 6x).

Contactors for Switching Motors

SIRIUS 3RT contactors, 3-pole up to 500 HP

Type Size	Contactors				
	3RT2035	3RT2036	3RT2037	3RT2038	
Rated data of the main contacts					
Load rating with AC					
Utilization category AC-1, switching resistive loads					
• Rated operational current I_e	At 40 °C up to 690 V A At 60 °C up to 690 V A	60 55	70 60	80 70	90 80
• Rated power for AC loads ¹⁾ P.f. = 0.95 (at 60 °C)	230 V kW 400 V kW 690 V kW	23 39 68	26 46 79	30 53 91	34 59 102
• Minimum conductor cross-section for loads with I_e	At 40 °C mm ² At 60 °C mm ²	16 16	25	25	35
Utilization categories AC-2 and AC-3					
• Rated operational currents I_e	Up to 400 V A 440 V A 500 V A 690 V A	40 40 40 24	50 50 50	65 65 65 47	80 80 80 58
• Rated power for slipring or squirrel-cage motors at 50 and 60 Hz	At 230 V kW 400 V kW 690 V kW	11 18.5 22	15 22	18.5 30 37	22 37 45
Thermal load capacity	10 s current A	400	420	520	640
Power loss per conducting path	At $I_e/AC-3$ W	2.2	4	3.8	5.7
Utilization category AC-4 (for $I_a = 6 \times I_e$)					
• Maximum values					
- Rated operational current I_e	Up to 400 V A	35	41	55	
- Rated power for squirrel-cage motors with 50 Hz and 60 Hz	At 400 V kW	18.5	22	30	
• The following applies to a contact endurance of about 200 000 operating cycles:					
- Rated operational currents I_e	Up to 400 V A 690 V A	22 18.5	24 20	28 22	30 24
- Rated power for squirrel-cage motors with 50 Hz and 60 Hz	At 110 V kW 230 V kW 400 V kW 690 V kW	3.2 6.7 11.6 16.8	3.5 7.3 12.6 18.2	4.1 8.5 14.7 20	4.3 9.1 15.8 21.8

¹⁾ Industrial furnaces and electric heaters with resistance heating, etc. (increased power consumption on heating up has been taken into account).

Contactors for Switching Motors

SIRIUS 3RT contactors, 3-pole up to 500 HP

Type Size	Contactors			
	3RT2035	3RT2036	3RT2037	3RT2038
Rated data of the main contacts (continued)				
Load rating with DC				
Utilization category DC-1, switching resistive loads (L/R 1 ms)				
• Rated operational currents I_e (at 60 °C)				
- 1 conducting path	Up to 24 V A	55		
	60 V A	23		
	110 V A	4.5		
	220 V A	1		
	440 V A	0.4		
	600 V A	0.25		
- 2 conducting paths in series	Up to 24 V A	55		
	60 V A	45		
	110 V A	45		
	220 V A	5		
	440 V A	1		
	600 V A	0.8		
- 3 conducting paths in series	Up to 24 V A	55		
	60 V A	55		
	110 V A	55		
	220 V A	45		
	440 V A	2.9		
	600 V A	1.4		
Utilization category DC-3/DC-5, shunt-wound and series-wound motors (L/R 15 ms)				
• Rated operational currents I_e (at 60 °C)				
- 1 conducting path	Up to 24 V A	35		
	60 V A	6		
	110 V A	2.5		
	220 V A	1		
	440 V A	0.1		
	600 V A	0.06		
- 2 conducting paths in series	Up to 24 V A	55		
	60 V A	45		
	110 V A	25		
	220 V A	5		
	440 V A	0.27		
	600 V A	0.16		
- 3 conducting paths in series	Up to 24 V A	55		
	60 V A	55		
	110 V A	55		
	220 V A	25		
	440 V A	0.6		
	600 V A	0.35		
Switching frequency				
Switching frequency z in operating cycles/hour				
Contactors without overload relays				
• No-load switching frequency	AC	h ⁻¹	5 000	
	AC/DC	h ⁻¹	1 500	
• Switching frequency z during rated operation ¹⁾				
- $I_e/AC-1$	At 400 V	h ⁻¹	1 200	1 000
- $I_e/AC-2$	At 400 V	h ⁻¹	750	600
- $I_e/AC-3$	At 400 V	h ⁻¹	1 000	800
- $I_e/AC-4$	At 400 V	h ⁻¹	300	250
				800
				400
				700
				500
				150
Contactors with overload relays				
• Mean value		h ⁻¹	15	

1) Dependence of the switching frequency z' on the operational current I' and operational voltage U' :
 $z' = z (I_e/I') (U_e/U')^{1.5}$ 1/h.

Contactors for Switching Motors

SIRIUS 3RT contactors, 3-pole up to 500 HP

Type	Contactors	
Size	3RT2035 to 3RT2038	
S2		
Conductor cross-sections		
Main conductors (1 or 2 conductors can be connected)		
<ul style="list-style-type: none"> • Solid or stranded 	mm ²	2 x (1 ... 35) ¹⁾ ; 1 x (1 ... 50) ¹⁾
<ul style="list-style-type: none"> • Finely stranded with end sleeve (DIN 46228-1) 	mm ²	2 x (1 ... 25) ¹⁾ ; 1 x (1 ... 35) ¹⁾
<ul style="list-style-type: none"> • AWG cables, solid or stranded 	AWG	2 x (18 ... 2) ¹⁾ ; 1 x (18 ... 1) ¹⁾
<ul style="list-style-type: none"> • Terminal screws - Tightening torque 	Nm	Pozidriv size 2; 5 ... 6 3 ... 4.5 (27 ... 40 lb.in)
Auxiliary conductors and control conductors (1 or 2 conductors can be connected)		
<ul style="list-style-type: none"> • Solid or stranded 	mm ²	2 x (0.5 ... 1.5) ¹⁾ ; 2 x (0.75 ... 2.5) ¹⁾
<ul style="list-style-type: none"> • Finely stranded with end sleeve (DIN 46228-1) 	mm ²	2 x (0.5 ... 1.5) ¹⁾ ; 2 x (0.75 ... 2.5) ¹⁾
<ul style="list-style-type: none"> • AWG cables, solid or stranded 	AWG	2 x (20 ... 16) ¹⁾ ; 2 x (18 ... 14) ¹⁾
<ul style="list-style-type: none"> • Terminal screws - Tightening torque 	Nm	M3 (for Pozidriv size 2; 5 ... 6) 0.8 ... 1.2 (7 ... 10.3 lb.in)
Auxiliary and control conductors²⁾ (1 or 2 conductors can be connected)		
<ul style="list-style-type: none"> • Operating devices 	mm	3.0 x 0.5
<ul style="list-style-type: none"> • Solid or stranded 	mm ²	2 x (0.5 ... 2.5)
<ul style="list-style-type: none"> • Finely stranded with end sleeve (DIN 46228-1) 	mm ²	2 x (0.5 ... 1.5)
<ul style="list-style-type: none"> • Finely stranded without end sleeve 	mm ²	2 x (0.5 ... 2.5)
<ul style="list-style-type: none"> • AWG cables, solid or stranded 	AWG	2 x (20 ... 14)

Screw terminals

Spring-type terminals

¹⁾ If two different conductor cross-sections are connected to one clamping point, both cross-sections must lie in one of the ranges specified.

²⁾ Max. external diameter of the cable insulation: 3.6 mm. On spring-type terminals with conductor cross-sections > 1 mm², an insulation stop must be used, see page 3/115.

		Contactors		
		3RT2045	3RT2046	3RT2047
Type		S3		
Size				
General data				
Dimensions (W x H x D)				
<ul style="list-style-type: none"> Basic unit - Screw/spring-type terminals 		mm	70 x 140 x 152	
<ul style="list-style-type: none"> Basic unit with mounted auxiliary switch block - Screw terminals - Spring-type terminals 		mm	70 x 140 x 196	
<ul style="list-style-type: none"> Basic unit with mounted function module or solid-state time-delayed auxiliary switch block - Screw/spring-type terminals 		mm	70 x 140 x 226	
Permissible mounting position				
The contactors are designed for operation on a vertical mounting surface.				
Upright mounting position				
		Special version required		
Mechanical endurance				
<ul style="list-style-type: none"> Basic units and basic units with mounted auxiliary switch block 		Operat- ing cycles	10 million	
<ul style="list-style-type: none"> Basic units with solid-state compatible auxiliary switch block 		Operat- ing cycles	5 million	
Electrical endurance				
		For contact endurance of the main contacts, see page 3/21 .		
Rated insulation voltage U_i (pollution degree 3)	V	1 000 (3RT20...-...-0CC0: 690)		
Rated impulse withstand voltage U_{imp}	kV	6		
Protective separation between the coil and the main contacts (acc. to IEC 60947-1, Appendix N)	V	690		
Mirror contacts				
A mirror contact is an auxiliary NC contact that cannot be closed simultaneously with an NO main contact.				
<ul style="list-style-type: none"> Integrated auxiliary switches 3RT2.4. (removable auxiliary switch block) 		Yes, acc. to IEC 60947-4-1, Appendix F Yes, acc. to IEC 60947-4-1, Appendix F		
Permissible ambient temperature				
<ul style="list-style-type: none"> During operation 	°C	-25 ... +60		
<ul style="list-style-type: none"> During storage 	°C	-55 ... +80		
Degree of protection acc. to IEC 60529				
<ul style="list-style-type: none"> On front 		IP20		
<ul style="list-style-type: none"> Connecting terminal 		IP00 (for higher degree of protection, use additional terminal covers)		
Touch protection acc. to IEC 60529		Finger-safe for vertical touching from the front		
Shock resistance				
<ul style="list-style-type: none"> Rectangular pulse - AC operation - DC operation 	g/ms	10.3/5 and 6.7/10		
	g/ms	6.7/5 and 4.0/10 (3RT204.-.KB40: 6.3/5 and 3.6/10)		
<ul style="list-style-type: none"> Sine pulse - AC operation - DC operation 	g/ms	16.3/5 and 10.5/10		
	g/ms	10.6/5 and 6.3/10 (3RT204.-.KB40: 9.8/5 and 5.6/10)		
Short-circuit protection				
Main circuit				
<ul style="list-style-type: none"> Fuse links, operational class gG: LV HRC, type 3NA; DIAZED, type 5SB; NEOZED, type 5SE acc. to IEC/EN 60947-4-1 				
<ul style="list-style-type: none"> - Type of coordination "1" 	A	250		
<ul style="list-style-type: none"> - Type of coordination "2" 	A	160		
<ul style="list-style-type: none"> - Weld-free (test conditions according to IEC 60947-4-1) 	A	On request		
			160	200
Auxiliary circuit				
<ul style="list-style-type: none"> Fuse links, operational class gG: DIAZED, type 5SB; NEOZED, type 5SE (weld-free protection at I_k 1 kA) 	A	10		
<ul style="list-style-type: none"> 230 V miniature circuit breaker, C characteristic (short-circuit current $I_k < 400$ A) 	A	10		
Short-circuit protection for contactors with overload relays		See "Configuring the SIRIUS Modular System – Selection data for Fuseless and Fused Load Feeders", https://support.industry.siemens.com/cs/ww/en/view/39714188		
Short-circuit protection for fuseless load feeders		See 3RA2 load feeders, from page 8/4 onwards		

Contactors for Switching Motors

SIRIUS 3RT contactors, 3-pole up to 500 HP

Type	Contactors		Coupling contactors
Size	3RT204.-.A...	3RT204.-.N.3.	3RT204.-.KB4.
Control			
Type of operating mechanism	AC	AC/DC	DC
Solenoid coil operating range			
• AC operation ¹⁾	0.8 ... 1.1 x U _s	--	--
• AC/DC operation ¹⁾	--	0.8 ... 1.1 x U _s	--
• DC operation	--	--	0.8 ... 1.2 x U _s
Power consumption of the solenoid coils (for cold coil and 1.0 x U _s)			
• AC operation, 50 Hz, standard version			
- Closing	VA	296	--
- P.f.		0.61	--
- Closed	VA	19	--
- P.f.		0.38	--
• AC operation, 50/60 Hz, standard version			
- Closing	VA	348/296	--
- P.f.		0.62/0.55	--
- Closed	VA	25/18	--
- P.f.		0.35/0.41	--
• AC operation, 60 Hz, for USA/Canada			
- Closing	VA	326	--
- P.f.		0.62	--
- Closed	VA	22	--
- P.f.		0.38	--
• AC/DC operation			
- Closing for AC operation	VA	--	163
- P.f.		--	0.95
- Closed for AC operation	VA	--	3.1
- P.f.		--	0.95
• DC operation			
- Closing for DC operation	W	--	76 ²⁾
- Closed for DC operation	W	--	1.8
Permissible residual current of the electronics (with 0 signal)			
• AC/DC operation	mA	--	< 20
• DC operation	mA	--	< 20
Overvoltage configuration of the solenoid coil			
	--	Built-in varistor 	Built-in varistor
Operating times at 0.8 ... 1.2 x U_s³⁾ Total break time = Opening delay + Arcing time			
• DC operation			
- Closing delay	ms	--	50 ... 70
- Opening delay	ms	--	38 ... 57
Operating times for 1.0 x U_s³⁾			
• AC operation			
- Closing delay	ms	15 ... 25	50 ... 70
- Opening delay	ms	11 ... 20	38 ... 57
• DC operation			
- Closing delay	ms	--	50 ... 70
- Opening delay	ms	--	38 ... 57
• Arcing time	ms	10 ... 20	--

¹⁾ Coil operating range
 - At 50 Hz: 0.8 to 1.1 x U_s
 - At 60 Hz: 0.85 to 1.1 x U_s.

²⁾ In the case of AC/DC coils, increased starting currents (2.6 A on average) occur during the first 200 ms. For direct control from a PLC, we recommend special 3RT204.-.KB4. coupling contactors with adapted power consumption, suitable for a PLC output current of 2 A (see page 3/62).

³⁾ The OFF-delay of the NO contact and the ON-delay of the NC contact are increased if the contactor coils are attenuated against voltage peaks (varistor +2 ms to 5 ms, diode assembly: 2x to 6x).

Contactors for Switching Motors

SIRIUS 3RT contactors, 3-pole up to 500 HP

Type Size	Contactors		
	3RT2045	3RT2046	3RT2047
Rated data of the main contacts			
Load rating with AC			
Utilization category AC-1, switching resistive loads			
• Rated operational current I_e	At 40 °C up to 690 V A At 60 °C up to 690 V A	125 105	130 110
• Rated power for AC loads ¹⁾ P.f. = 0.95 (at 60 °C)	230 V kW 400 V kW 690 V kW	40 69 119	42 72 125
• Minimum conductor cross-section for loads with I_e	At 40 °C mm ² At 60 °C mm ²	50 35	
Utilization categories AC-2 and AC-3			
• Rated operational currents I_e	Up to 400 V A 500 V A 690 V A 1 000 V A	80 80 58 30	95 95 78 98
• Rated power for slipping or squirrel-cage motors at 50 and 60 Hz	At 230 V kW 400 V kW 690 V kW 1 000 V kW	22 37 55 37	22 45 75 90
Thermal load capacity	10 s current A	760	880
Power loss per conducting path	At $I_e/AC-3$ W	5.3	6.6
Utilization category AC-4 (for $I_a = 6 \times I_e$)			
• Maximum values			
- Rated operational current I_e	Up to 400 V A	66	80
- Rated power for squirrel-cage motors with 50 Hz and 60 Hz	At 400 V kW	37	45
• The following applies to a contact endurance of about 200 000 operating cycles:			
- Rated operational currents I_e	Up to 400 V A 690 V A	34 24	42 30
- Rated power for squirrel-cage motors with 50 Hz and 60 Hz	At 110 V kW 230 V kW 400 V kW 690 V kW	4.9 10.4 17.9 21.8	6.1 12 22 27.4
			46 36 6.7 14 24.3 32.9

¹⁾ Industrial furnaces and electric heaters with resistance heating, etc. (increased power consumption on heating up has been taken into account).

Contactors for Switching Motors

SIRIUS 3RT contactors, 3-pole up to 500 HP

CONTACTORS AND ASSEMBLIES 2

Type Size	Contactors		
	3RT2045	3RT2046	3RT2047
Rated data of the main contacts (continued)			
Load rating with DC			
Utilization category DC-1, switching resistive loads (L/R 1 ms)			
• Rated operational currents I_e (at 60 °C)			
- 1 conducting path	Up to 24 V A 60 V A 110 V A 220 V A 440 V A 600 V A	A A A A A A	100 60 9 2 0.6 0.4
- 2 conducting paths in series	Up to 24 V A 60 V A 110 V A 220 V A 440 V A 600 V A	A A A A A A	100 100 100 10 1.8 1.0
- 3 conducting paths in series	Up to 24 V A 60 V A 110 V A 220 V A 440 V A 600 V A	A A A A A A	100 100 100 80 4.5 2.6
Utilization category DC-3/DC-5, shunt-wound and series-wound motors (L/R 15 ms)			
• Rated operational currents I_e (at 60 °C)			
- 1 conducting path	Up to 24 V A 60 V A 110 V A 220 V A 440 V A 600 V A	A A A A A A	40 6 2.5 1 0.15 0.06
- 2 conducting paths in series	Up to 24 V A 60 V A 110 V A 220 V A 440 V A 600 V A	A A A A A A	100 100 100 7 0.42 0.16
- 3 conducting paths in series	Up to 24 V A 60 V A 110 V A 220 V A 440 V A 600 V A	A A A A A A	100 100 100 35 0.8 0.35
Switching frequency			
Switching frequency z in operating cycles/hour			
Contactors without overload relays			
• No-load switching frequency	AC AC/DC	h^{-1} h^{-1}	5 000 1 000
• Switching frequency z during rated operation ¹⁾			
- $I_e/AC-1$	At 400 V	h^{-1}	900
- $I_e/AC-2$	At 400 V	h^{-1}	400
- $I_e/AC-3$	At 400 V	h^{-1}	1 000
- $I_e/AC-4$	At 400 V	h^{-1}	300
Contactors with overload relays			
• Mean value		h^{-1}	15

¹⁾ Dependence of the switching frequency z' on the operational current I' and operational voltage U' :
 $z' = z (I_e/I') (U_e/U')^{1.5} 1/h.$

Contactors for Switching Motors

SIRIUS 3RT contactors, 3-pole up to 500 HP

Type	Contactors	
Size	3RT2045 to 3RT2047	
S3		
Conductor cross-sections		
Main conductors (1 or 2 conductors can be connected)		
• Solid	mm ²	2 x (2.5 ... 16) ¹⁾
• Stranded	mm ²	2 x (6 ... 16) ¹⁾ ; 2 x (10 ... 50) ¹⁾ ; 1 x (10 ... 70) ¹⁾
• Finely stranded with end sleeve (DIN 46228-1)	mm ²	2 x (2.5 ... 35) ¹⁾ ; 1 x (2.5 ... 50) ¹⁾
• AWG cables, solid or stranded	AWG	2 x (10 ... 1/0) ¹⁾ ; 1 x (10 ... 2/0) ¹⁾
• Terminal screws - Tightening torque	Nm	Hexagon socket, size 4 4.5 ... 6 (40 ... 53 lb.in)
Auxiliary conductors and control conductors (1 or 2 conductors can be connected)		
• Solid or stranded	mm ²	2 x (0.5 ... 1.5) ¹⁾ ; 2 x (0.75 ... 2.5) ¹⁾
• Finely stranded with end sleeve (DIN 46228-1)	mm ²	2 x (0.5 ... 1.5) ¹⁾ ; 2 x (0.75 ... 2.5) ¹⁾
• AWG cables, solid or stranded	AWG	2 x (20 ... 16) ¹⁾ ; 2 x (18 ... 14) ¹⁾
• Terminal screws - Tightening torque	Nm	M3 (for Pozidriv size 2; 5 ... 6) 0.8 ... 1.2 (7 ... 10.3 lb.in)
Auxiliary and control conductors²⁾ (1 or 2 conductors can be connected)		
• Operating devices	mm	3.0 x 0.5
• Solid or stranded	mm ²	2 x (0.5 ... 2.5)
• Finely stranded with end sleeve (DIN 46228-1)	mm ²	2 x (0.5 ... 1.5)
• Finely stranded without end sleeve	mm ²	2 x (0.5 ... 2.5)
• AWG cables, solid or stranded	AWG	2 x (20 ... 16)

¹⁾ If two different conductor cross-sections are connected to one clamping point, both cross-sections must lie in one of the ranges specified.

²⁾ Max. external diameter of the conductor insulation: 3.6 mm. On spring-type terminals with conductor cross-sections > 1 mm², an insulation stop must be used, see page 3/115.

Contactors for Switching Motors

3RT10.5. contactors

CONTACTORS AND ASSEMBLIES 2

Technical data

Contactor	Size Type	S6 3RT10 54	S6 3RT10 55	S6 3RT10 56
-----------	-----------	------------------------------	------------------------------	------------------------------

General data

Permissible mounting position The contactors are designed for operation on a vertical mounting surface.				
Mechanical endurance	Oper. cycles	10 million		
Electrical endurance		See page 2/123		
Rated insulation voltage U_i (pollution degree 3)	V	1000		
Rated impulse withstand voltage U_{imp}	kV	8		
Safe isolation between coil, auxiliary contacts and main contacts (acc. to DIN VDE 0106 Part 101 and A1 [draft 2/89])	V	690		
Positively driven operation There is positively driven operation if the NC and NO contacts cannot be closed at the same time		Yes, between main contacts and auxiliary NC contacts and within the auxiliary switch blocks acc. to ZH 1/457, IEC 60 947-4-1, Annex H (draft 17B/996/DC)		
Permissible ambient temperature	in operation °C when stored °C	-25 ... +60/+55 with AS-Interface -55 ... +80		
Degree of protection acc. to IEC 60 947-1 and DIN 40 050		IP 00/open type, coil system IP 20		
Shock resistance	Rectangular pulse Sine pulse	g/ms g/ms	8.5/5 and 4.2/10 13.4/5 and 6.5/10	
Conductor cross-sections		See page 2/148		
Electromagnetic compatibility (EMC)		See page 2/106		

Short-circuit protection of contactors without overload relays

Main circuit Fuse links, utilization category gL/gG NH Type 3NA, DIAZED Type 5SB, NEOZED Type 5SE – acc. to IEC 60 947-4-1/EN 60 947-4-1		Type of coord. "1" 1) Type of coord. "2" 1) Weld-free 2)	A A A	355 315 80	355 315 160
Auxiliary circuit Fuse links, utilization category gL/gG (weld-free protection at $I_k \geq 1$ kA) DIAZED Type 5SB, NEOZED Type 5SE or miniature circuit-breaker with C-characteristic ($I_k < 400$ A)			A	10	

Contactor	Size Type	S6 3RT10 5.
-----------	-----------	------------------------------

Control circuit

Coil voltage tolerance	AC/DC (UC)	$0.8 \times U_{s \min} \dots 1.1 \times U_{s \max}$			
Power consumption of solenoid mechanism (with coil in cold state and rated range $U_{s \min} \dots U_{s \max}$)		Conventional op. mechanism		Solid-state op. mechanism	
AC operation	Closing p.f.	VA	$U_{s \min}$ 250 0.9	$U_{s \max}$ 300 0.9	$U_{s \min}$ 190 0.8
	Closed p.f.	VA	4.8 0.8	5.8 0.8	$U_{s \max}$ 280 0.8 4.4 0.4
DC operation	Closing	W	300	360	250
	Closed	W	4.3	5.2	2.3 2.8
PLC control input (EN 61 131-2/Type 2)		DC 24 V/≤ 30 mA			
Operating times (Break-time = opening time + arcing time)		Conventional op. mechanism		Solid-state op. mechanism Operation via A1/A2 PLC input	
– at $0.8 \times U_{s \min} \dots 1.1 \times U_{s \max}$	closing time opening time	ms ms	20 ... 95 40 ... 60		95 ... 135 80 ... 90 35 ... 75 80 ... 90
– at $U_{s \min} \dots U_{s \max}$	closing time opening time	ms ms	25 ... 50 40 ... 60		100 ... 120 80 ... 90 40 ... 60 80 ... 90
Arcing time		ms	10 ... 15		10 ... 15 10 ... 15

1) According to excerpt from IEC 60 947-4-1 (VDE 0660 Part 102):
Type of coordination "1":
Destruction of the contactor and the overload relay is permissible. The contactor and/or overload relay must be replaced if necessary.

Type of coordination "2":
No damage can be tolerated to the overload relay, but contact welding on the contactor is permitted if the contacts can be easily separated.

2) Test conditions acc. to IEC 60 947-4-1.

Contactors for Switching Motors

3RT10.5. contactors

Technical data

Contactor	Size Type	S6 3RT10 54	S6 3RT10 55	S6 3RT10 56
-----------	-----------	-------------	-------------	-------------

Main circuit

Load ratings with AC

AC-1 utilization category, switching resistive load

Rated operational currents I_e	at 40 °C up to 690 V	A	160	185	215
	at 60 °C up to 690 V	A	140	160	185
	at 60 °C up to 1000 V	A	80	90	100
Ratings of three-phase loads ¹⁾ p.f. = 0.95 (at 60 °C)	at 230 V	kW	53	60	70
	400 V	kW	92	105	121
	500 V	kW	115	131	152
	690 V	kW	159	181	210
	1000 V	kW	131	148	165
Minimum conductor cross-section with $I_{e \text{ load}}$	at 40 °C	mm ²	70	95	95
	60 °C	mm ²	50	70	95

AC-2 and AC-3 utilization categories

Rated operational currents I_e	up to 500 V	A	115	150	185
	690 V	A	115	150	170
	1000 V	A	53	65	65
Ratings of slipring or squirrel-cage motors at 50 Hz and 60 Hz	at 230 V	kW	37	50	61
	400 V	kW	64	84	104
	500 V	kW	81	105	132
	690 V	kW	113	146	167
	1000 V	kW	75	90	90

Thermal loading capacity

10 s current ²⁾	A	1100	1300	1480
----------------------------	---	------	------	------

Power loss per conducting path

at $I_e/AC-3/500$ V	W	7	9	13
---------------------	---	---	---	----

AC-4 utilization category (at $I_a = 6 \times I_e$)

Rated operational current I_e	up to 400 V	A	97	132	160
Ratings of squirrel-cage motors at 50 Hz and 60 Hz	at 400 V	kW	55	75	90

• For a contact endurance of approx. 200 000 operating cycles:

Rated operational currents I_e	up to 500 V	A	54	68	81
	690 V	A	48	57	65
	1000 V	A	34	38	42
Ratings of squirrel-cage motors at 50 Hz and 60 Hz	at 230 V	kW	16	20	25
	400 V	kW	29	38	45
	500 V	kW	37	47	57
	690 V	kW	48	55	65
	1000 V	kW	49	55	60

AC-6a utilization category, switching three-phase transformers

with inrush	n	30	20	30	20	30	20	
Rated operational current I_e	up to 690 V	A	90	115	99	148	99	148
Ratings of three-phase transformers with an inrush of $n = 30$ or 20.	at 230 V	kVA	35	45	39	58	39	58
	400 V	kVA	62	79	68	102	68	102
The ratings must be re-calculated for other inrush factors x:	500 V	kVA	77	99	85	128	85	128
	690 V	kVA	107	137	118	176	118	176
	1000 V	kVA	80	80	98	98	117	117

$$P_x = P_{n30} \cdot \frac{30}{x}$$

AC-6b utilization category, switching low-inductance (low-loss, metallized-dielectric) three-phase capacitors

Ambient temperature 40 °C								
Rated operational currents I_e	up to 500 V	A	105	125	145			
Ratings of single capacitors or of capacitor banks (minimum inductance between parallel capacitors 6 μH) at 50 Hz, 60 Hz and	at 230 V	kvar	42	50	58			
	400 V	kvar	72	86	100			
	500 V	kvar	90	108	125			
	690 V	kvar	72	86	100			

1) Industrial furnaces and electric heaters with resistance heating, for example (higher current input allowed for during heating up).

2) Acc. to VDE 0660 Part 102. For rated values for various starting conditions, see Section 3.

Contactors for Switching Motors

Technical data

Contactor	Size Type	S6 3RT10 54	S6 3RT10 55	S6 3RT10 56
-----------	-----------	----------------	----------------	----------------

Main circuit

Load ratings with DC

DC-1 utilization category, switching resistive load (L/R ≤ 1 ms)				
Rated operational current I_e (at 60 °C)				
Number of conducting paths connected in series		1	2	3
up to 24 V	A	160	160	160
60 V	A	160	160	160
110 V	A	18	160	160
220 V	A	3.4	20	160
440 V	A	0.8	3.2	1.4
600 V	A	0.5	1.6	0.75
DC-3 and DC-5 utilization categories, shunt and series motors (L/R ≤ 15 ms)				
Rated operational current I_e (at 60 °C)				
Number of conducting paths connected in series		1	2	3
up to 24 V	A	160	160	160
60 V	A	7.5	160	160
110 V	A	2.5	160	160
220 V	A	0.6	2.5	160
440 V	A	0.17	0.65	11.5
600 V	A	0.12	0.37	4

Operating frequency

Operating frequency z in operating cycles per hour			
Contactor without overload relays	No-load operating frequency 1/h	2000	2000
Dependence of the operating frequency z' on the operational current I' and the operational voltage U':	for AC-1 1/h	800	800
	for AC-2 1/h	400	300
	for AC-3 1/h	1000	750
	for AC-4 1/h	130	130
$z' = z \cdot \frac{I_e}{I'} \cdot \left(\frac{400 \text{ V}}{U'}\right)^{1.5}$ 1/h			
Contactor with overload relays (mean value)	1/h	60	60

Contactor	Size Type	S6 3RT10 5.
-----------	-----------	----------------

Conductor cross-sections

Screw connections	Main conductor: with 3RT19 55-4G box terminal (75 HP)		Front terminal connected	Back terminal connected	Both terminals connected
	finely stranded with end sleeve	mm ²	16 ... 70	16 ... 70	max. 1 × 50, 1 × 70
	Finely stranded without end sleeve	mm ²	16 ... 70	16 ... 70	max. 1 × 50, 1 × 70
	Stranded	mm ²	16 ... 70	16 ... 70	max. 2 × 70
	AWG conductor connections, solid/stranded		6 ... 2/0	6 ... 2/0	max. 2 × 1/0
	Ribbon cable (qty. × width × thickness)	mm	min. 3 × 9 × 0.8	min. 3 × 9 × 0.8	max. 2 × (6 × 15.5 × 0.8)
		mm	max. 6 × 15.5 × 0.8	max. 6 × 15.5 × 0.8	
	with 3RT19 56-4G box terminal				
	Finely stranded with end sleeve	mm ²	16 ... 120	16 ... 120	max. 1 × 95, 1 × 120
	Finely stranded without end sleeve	mm ²	16 ... 120	16 ... 120	max. 1 × 95, 1 × 120
	Stranded	mm ²	16 ... 120	16 ... 120	max. 2 × 120
	AWG conductor connections, solid/stranded		6 ... 250 kcmil	6 ... 250 kcmil	max. 2 × 3/0
	Ribbon cable (qty. × width × thickness)	mm	min. 3 × 9 × 0.8	min. 3 × 9 × 0.8	max. 2 × (10 × 15.5 × 0.8)
		mm	max. 10 × 15.5 × 0.8	max. 10 × 15.5 × 0.8	
			– Terminal screws M 10 (hexagon socket, A/F4)		
	Nm	10 ... 12 (90 ... 110 lb.in)			
Without box terminal/busbar connection					
Finely stranded with cable lug	mm ²	16 ... 95	If cable lugs acc. to DIN 46 235 are connected, as of a conductor cross-section of 95 mm ² a 3RT19 56-4EA1 terminal cover is necessary to comply with the phase clearance.		
Stranded with cable lug	mm ²	25 ... 120			
AWG conductor connections, solid or stranded	AWG	4 ... 250 kcmil			
Connecting bar (max. width)	mm	17			
– Terminal screws		M 8 × 25 (A/F 13)			
– Tightening torque	Nm	10 ... 14 (89 ... 124 lb.in)			
Auxiliary conductor:					
Solid	mm ²	2 × (0.5 ... 1.5); 2 × (0.75 ... 2.5) acc. to IEC 60 947; max. 2 × (0.75 ... 4)			
Finely stranded with end sleeve	mm ²	2 × (0.5 ... 1.5); 2 × (0.75 ... 2.5)			
AWG conductor connections, solid or stranded	AWG	2 × (18 ... 14)			
– Terminal screws		M 3 (PZ 2)			
– Tightening torque	Nm	0.8 ... 1.2 (7 ... 10.3 lb.in)			

Contactors for Switching Motors

3RT10.6. contactors

Technical data		S10 3RT10 64	S10 3RT10 65	S10 3RT10 66
Contactors	Size Type			
General data				
Permissible mounting position The contactors are designed for operation on a vertical mounting surface.				
Mechanical endurance	Oper. cycles	10 million		
Electrical endurance		See page 2/123		
Rated insulation voltage U_i (pollution degree 3)	V	1000		
Rated impulse withstand voltage U_{imp}	kV	8		
Safe isolation between coil, auxiliary contacts and main contacts (acc. to DIN VDE 0106 Part 101 and A1 [draft 2/89])	V	690		
Positively driven operation There is positively driven operation if the NC and NO contacts cannot be closed at the same time		Yes, between main contacts and auxiliary NC contacts and within the auxiliary switch blocks acc. to ZH 1/457, IEC 60 947-4-1, Annex H (draft 17B/996/DC)		
Permissible ambient temperature	in operation when stored	°C	-25 ... +60/+55 with AS-Interface -55 ... +80	
Degree of protection acc. to IEC 60 947-1 and DIN 40 050		IP 00/open type, coil system IP 20		
Shock resistance	Rectangular pulse Sine pulse	g/ms g/ms	8.5/5 and 4.2/10 13.4/5 and 6.5/10	
Conductor cross-sections		See page 2/151		
Electromagnetic compatibility (EMC)		See page 2/106		
Short-circuit protection				
Main circuit Fuse links, utilization category gL/gG NH Type 3NA, DIAZED Type 5SB, NEOZED Type 5SE – acc. to IEC 60 947-4-1/EN 60 947-4-1		Type of coord. "1" 1) Type of coord. "2" 1) Weld-free 2)	A A A	500 400 250
Auxiliary circuit Fuse links, utilization category gL/gG (weld-free protection at $I_k \geq 1$ kA) DIAZED Type 5SB, NEOZED Type 5SE or miniature circuit-breaker with C-characteristic ($I_k < 400$ A)			A	10
Contactors	Size Type	S10 3RT10 6.		
Control circuit				
Coil voltage tolerance	AC/DC (UC)	$0.8 \times U_{s \min} \dots 1.1 \times U_{s \max}$		
Power consumption of solenoid mechanism (with coil in cold state and rated range $U_{s \min} \dots U_{s \max}$)		Conventional op. mechanism		Solid-state op. mechanism
AC operation	closing p.f.	VA	$U_{s \min}$ 490 0.9	$U_{s \max}$ 590 0.9
	closed p.f.	VA	5.6 0.9	6.7 0.9
DC operation	closing	W	540	650
	closed	W	6.1	7.4
PLC control input (EN 61 131-2/Type 2)		DC 24 V / ≤ 30 mA		
Operating times (Break-time = opening time + arcing time)		Conventional op. mechanism		Solid-state op. mechanism Operation via A1/A2
– at $0.8 \times U_{s \min} \dots 1.1 \times U_{s \max}$	closing time	ms	30 ... 95	105 ... 145
	opening time	ms	40 ... 80	80 ... 100
– at $U_{s \min} \dots U_{s \max}$	closing time	ms	35 ... 50	110 ... 130
	opening time	ms	50 ... 80	80 ... 100
Arcing time		ms	10 ... 15	10 ... 15

1) According to excerpt from IEC 60 947-4-1 (VDE 0660 Part 102):
Type of coordination "1":
Destruction of the contactor and the overload relay is permissible. The contactor and/or overload relay must be replaced if necessary.

Type of coordination "2":
No damage can be tolerated to the overload relay, but contact welding on the contactor is permitted if the contacts can be easily separated.

2) Test conditions acc. to IEC 60 947-4-1.

Contactors for Switching Motors

3RT10.6. contactors

CONTACTORS AND ASSEMBLIES 2

Technical data

Contactant	Size Type	S10 3RT10 64	S10 3RT10 65	S10 3RT10 66
------------	-----------	--------------	--------------	--------------

Main circuit

Load ratings with AC

AC-1 utilization category, switching resistive load

Rated operational currents I_e	at 40 °C up to 690 V	A	275	330	
	at 60 °C up to 690 V	A	250	300	
	at 60 °C up to 1000 V	A	100	150	
Ratings of three-phase loads 1) p.f. = 0.95 (at 60 °C)	at 230 V	kW	94	113	
	400 V	kW	164	197	
	500 V	kW	205	246	
	690 V	kW	283	340	
	1000 V	kW	164	246	
Minimum conductor cross-section with $I_{e \text{ load}}$	at 40 °C	mm ²	150	185	
	60 °C	mm ²	120	185	

AC-2 and AC-3 utilization categories

Rated operational currents I_e	up to 500 V	A	225	265	300
	690 V	A	225	265	280
	1000 V	A	68	95	95
Ratings of slipping or squirrel-cage motors at 50 Hz and 60 Hz	at 230 V	kW	73	85	97
	400 V	kW	128	151	171
	500 V	kW	160	189	215
	690 V	kW	223	265	280
	1000 V	kW	90	132	132

Thermal loading capacity

10 s current 2)	A	1800	2400	2400
-----------------	---	------	------	------

Power loss per conducting path

at $I_e/AC-3/500$ V	W	17	18	22
---------------------	---	----	----	----

AC-4 utilization category (at $I_a = 6 \times I_e$)

Rated operational current I_e	up to 400 V	A	195	230	280
Ratings of squirrel-cage motors at 50 Hz and 60 Hz	at 400 V	kW	110	132	160
• For a contact endurance of approx. 200 000 operating cycles:					
Rated operational currents I_e	up to 500 V	A	96	117	125
	690 V	A	85	105	115
	1000 V	A	42	57	57
Ratings of squirrel-cage motors at 50 Hz and 60 Hz	at 230 V	kW	30	37	40
	400 V	kW	54	66	71
	500 V	kW	67	82	87
	690 V	kW	82	102	112
	1000 V	kW	59	80	80

AC-6a utilization category, switching three-phase transformers

with inrush	n	30	20	30	20	30	20	
Rated operational current I_e	up to 690 V	A	151	227	182	265	182	273
Ratings of three-phase transformers with an inrush of n = 30 or 20.	at 230 V	kVA	60	90	72	105	72	109
	400 V	kVA	105	157	126	183	126	189
The ratings must be re-calculated for other inrush factors x:	500 V	kVA	130	196	158	229	158	236
	690 V	kVA	180	271	217	317	217	326
	1000 V	kVA	117	117	164	164	164	164

$$P_x = P_{n30} \cdot \frac{30}{x}$$

AC-6b utilization category, switching low-inductance (low-loss, metallized-dielectric) three-phase capacitors

Ambient temperature 40 °C					
Rated operational currents I_e	up to 500 V	A	183	220	
Ratings of single capacitors or of capacitor banks (minimum inductance between parallel capacitors 6 µH) at 50 Hz, 60 Hz and	at 230 V	kvar	73	88	
	400 V	kvar	127	152	
	500 V	kvar	159	191	
	690 V	kvar	127	152	

1) Industrial furnaces and electric heaters with resistance heating, for example (higher current input allowed for during heating up).

2) Acc. to VDE 0660 Part 102. For rated values for various starting conditions, see Section 3.

Contactors for Switching Motors

3RT10.6. contactors

Technical data

Contactor	Size Type	S10 3RT10 64	S10 3RT10 65	S10 3RT10 66
-----------	-----------	-----------------	-----------------	-----------------

Main circuit

Load ratings with DC



DC-1 utilization category, switching resistive load (L/R ≤ 1 ms)							
Rated operational current I_e (at 60 °C)							
Number of conducting paths connected in series		1	2	3	1	2	3
up to 24 V A		200	200	200	300	300	300
60 V A		200	200	200	300	300	300
110 V A		18	200	200	33	300	300
220 V A		3.4	20	200	3.8	300	300
440 V A		0.8	3.2	11.5	0.9	4	11
600 V A		0.5	1.6	4	0.6	2	5.2
DC-3 and DC-5 utilization categories, shunt and series motors (L/R ≤ 15 ms)							
Rated operational current I_e (at 60 °C)							
Number of conducting paths connected in series		1	2	3	1	2	3
up to 24 V A		200	200	200	300	300	300
60 V A		7.5	200	200	11	300	300
110 V A		2.5	200	200	3	300	300
220 V A		0.6	2.5	200	0.6	2.5	300
440 V A		0.17	0.65	1.4	0.18	0.65	1.4
600 V A		0.12	0.37	0.75	0.125	0.37	0.75

Operating frequency

Operating frequency z in operating cycles per hour							
Contactor without overload relays	No-load operating frequency	1/h	2000		2000		2000
Dependence of the operating frequency z' on the operational current I' and the operational voltage U' :	for AC-1	1/h	750		800		750
	for AC-2	1/h	250		300		250
	for AC-3	1/h	500		700		500
	for AC-4	1/h	130		130		130
$z' = z \cdot \frac{I_e}{I'} \cdot \left(\frac{400V}{U'}\right)^{1.5}$ 1/h							
Contactor with overload relays (mean value)		1/h	60		60		60

Contactor	Size Type	S10 3RT10 6.
-----------	-----------	-----------------

Conductor cross-sections

Screw connections	Main conductor: with 3RT19 66-4G box terminal	Front terminal connected	Back terminal connected	Both terminals connected	
	Finely stranded with end sleeve	mm ²	70 ... 240 	120 ... 185 	min. 2 × 50, max. 2 × 185 
	Finely stranded without end sleeve	mm ²	70 ... 240	120 ... 185	min. 2 × 50, max. 2 × 185
	Stranded	mm ²	95 ... 300	120 ... 240	min. 2 × 70, max. 2 × 240
	AWG conductor connections, solid or stranded	AWG	3/0 ... 600 kcmil	250 ... 500 kcmil	min. 2 × 2/0, max. 2 × 500 kcmil
	Ribbon cable (qty. × width × thickness)	mm	min. 6 × 9 × 0.8 max. 20 × 24 × 0.5	min. 6 × 9 × 0.8 max. 20 × 24 × 0.5	max. 2 × (20 × 24 × 0.5)
	– Terminal screws	mm	M 12 (hexagon socket, A/F 5)		
	– Tightening torque	Nm	20 ... 22 (180 ... 195 lb.in)		
	Without box terminal/busbar connection				
	Finely stranded with cable lug	mm ²	50 ... 240	If cable lugs acc. to DIN 46 234 are connected, as of a conductor cross-section of 240 mm ² and acc. to DIN 46 235 as of a conductor cross-section of 185 mm ² a 3RT19 66-4EA1 terminal cover is necessary to comply with the phase clearance.	
	Stranded with cable lug	mm ²	70 ... 240		
	AWG conductor connections, solid or stranded	AWG	2/0 ... 500 kcmil		
	Connecting bar (max. width)	mm	25		
	– Terminal screws	mm	M 10 × 30 (A/F 17)		
	– Tightening torque	Nm	14 ... 24 (124 ... 210 lb.in)		
Auxiliary conductor:					
Solid	mm ²	2 × (0.5 ... 1.5); 2 × (0.75 ... 2.5) acc. to IEC 60 947; max. 2 × (0.75 ... 4)			
Finely stranded with end sleeve	mm ²	2 × (0.5 ... 1.5); 2 × (0.75 ... 2.5)			
AWG conductor connections, solid or stranded	AWG	2 × (18 ... 14) M 3 (PZ 2)			
– Terminal screws	mm	0.8 ... 1.2 (7 ... 10.3 lb.in)			
– Tightening torque	Nm				

Contactors for Switching Motors

3RT10.7. contactors

Technical data		S12 3RT10 75	S12 3RT10 76			
Contactors	Size Type					
General data						
Permissible mounting position The contactors are designed for operation on a vertical mounting surface.						
Mechanical endurance	Oper. cycles	10 million				
Electrical endurance		See page 2/123				
Rated insulation voltage U_i (pollution degree 3)	V	1000				
Rated impulse withstand voltage U_{imp}	kV	8				
Safe isolation between coil, auxiliary contacts and main contacts (acc. to DIN VDE 0106 Part 101 and A1 [draft 2/89])	V	690				
Positively driven operation There is positively driven operation if the NC and NO contacts cannot be closed at the same time		Yes, between main contacts and auxiliary NC contacts and within the auxiliary switch blocks acc. to ZH 1/457, IEC 60 947-4-1, Annex H (draft 17B/996/DC)				
Permissible ambient temperature	in operation when stored	°C	-25 ... +60/+55 with AS-Interface -55 ... +80			
Degree of protection acc. to IEC 60 947-1 and DIN 40 050		IP 00/open type, coil system IP 20				
Shock resistance	Rectangular pulse Sine pulse	g/ms g/ms	8.5/5 and 4.2/10 13.4/5 and 6.5/10			
Conductor cross-sections		See page 2/154				
Electromagnetic compatibility (EMC)		See page 2/106				
Short-circuit protection						
Main circuit Fuse links, utilization category gL/gG NH Type 3NA, DIAZED Type 5SB, NEOZED Type 5SE – to IEC 60 947-4/EN 60 947-4-4 (VDE 0660 Part 102)						
	Type of coord. "1" 1) Type of coord. "2" 1) Weld-free 2)	A A A	630 500 250			
			630 500 315			
Auxiliary circuit Fuse links, utilization category gL/gG (weld-free protection at $I_k \geq 1$ kA) DIAZED Type 5SB, NEOZED Type 5SE or miniature circuit-breaker with C-characteristic ($I_k < 400$ A)						
		A	10			
Control circuit						
Coil voltage tolerance	AC/DC (UC)	$0.8 \times U_{s, \min} \dots 1.1 \times U_{s, \max}$				
Power consumption of solenoid mechanism (with coil in cold state and rated range $U_{s, \min} \dots U_{s, \max}$)						
AC operation	closing p.f. closed p.f.	VA VA	Conventional op. mechanism	Solid-state op. mechanism		
			$U_{s, \min}$	$U_{s, \max}$	$U_{s, \min}$	$U_{s, \max}$
			700 0.9 7.6 0.9	830 0.9 9.2 0.9	560 0.8 5.4 0.8	750 0.8 7 0.8
DC operation	closing closed	W W	770 8.5	920 10	600 4	800 5
			PLC control input (EN 61 131-2/Type 2)			
		DC 24 V/≤ 30 mA				
Operating times (Break-time = opening time + arcing time)						
– at $0.8 \times U_{s, \min} \dots 1.1 \times U_{s, \max}$	closing time opening time	ms ms	Conventional op. mechanism	Solid-state op. mechanism Operation via A1/A2	PLC input	
			45 ... 100 60 ... 100	120 ... 150 80 ... 100	60 ... 90 80 ... 100	
– at $U_{s, \min} \dots U_{s, \max}$	closing time opening time	ms ms	50 ... 70 70 ... 100	125 ... 150 80 ... 100	65 ... 80 80 ... 100	
			10 ... 15	10 ... 15	10 ... 15	

1) According to excerpt from IEC 60 947-4-1 (VDE 0660 Part 102):
Type of coordination "1":
Destruction of the contactor and the overload relay is permissible. The contactor and/or overload relay must be replaced if necessary.

Type of coordination "2":
No damage can be tolerated to the overload relay, but contact welding on the contactor is permitted if the contacts can be easily separated.

2) Test conditions acc. to IEC 60 947-4-1.

Contactors for Switching Motors

3RT10.7. contactors

Technical data

Contactor	Size Type	S12 3RT10 75	S12 3RT10 76
-----------	-----------	-----------------	-----------------

Main circuit

Load ratings with AC

AC-1 utilization category, switching resistive load

Rated operational currents I_e	at 40 °C up to 690 V	A	430	610
	at 60 °C up to 690 V	A	400	550 ³⁾
	at 60 °C up to 1000 V	A	200	200
Ratings of three-phase loads ¹⁾ p.f. = 0.95 (at 60 °C)	at 230 V	kW	151	208
	400 V	kW	263	362
	500 V	kW	329	452
	690 V	kW	454	624
	1000 V	kW	329	329
Minimum conductor cross-section with $I_{e \text{ load}}$	at 40 °C	mm ²	2 × 150	2 × 185
	60 °C	mm ²	240	2 × 185

AC-2 and AC-3 utilization categories

Rated operational currents I_e	up to 500 V	A	400	500 ⁴⁾
	690 V	A	400	450
	1000 V	A	180	180
Ratings of slipring or squirrel-cage motors at 50 Hz and 60 Hz	at 230 V	kW	132	164
	400 V	kW	231	291
	500 V	kW	291	363
	690 V	kW	400	453
	1000 V	kW	250	250

Thermal loading capacity

Power loss per conducting path	10 s current ²⁾	A	3200	4000
	at $I_e/AC-3/500$ V	W	35	55

AC-4 utilization category (at $I_a = 6 \times I_e$)

Rated operational current I_e	up to 400 V	A	350	430
Ratings of squirrel-cage motors at 50 Hz and 60 Hz	at 400 V	kW	200	250
• For a contact endurance of approx. 200 000 operating cycles:				
Rated operational currents I_e	up to 500 V	A	150	175
	690 V	A	135	150
	1000 V	A	80	80
Ratings of squirrel-cage motors at 50 Hz and 60 Hz	at 230 V	kW	48	56
	400 V	kW	85	98
	500 V	kW	105	123
	690 V	kW	133	148
	1000 V	kW	113	113

AC-6a utilization category, switching three-phase transformers with inrush

Rated operational current I_e	up to 690 V	A	251	377	270	404
Ratings of three-phase transformers with an inrush of $n = 30$ or 20 . The ratings must be re-calculated for other inrush factors x :	at 230 V	kVA	100	150	107	161
	400 V	kVA	173	261	187	280
	500 V	kVA	217	326	234	350
	690 V	kVA	300	450	323	483
	1000 V	kVA	311	311	311	311

$$P_x = P_{n30} \cdot \frac{30}{x}$$

AC-6b utilization category, switching low-inductance (low-loss, metallized-dielectric) three-phase capacitors

Ambient temperature 40 °C						
Rated operational currents I_e	up to 500 V	A	287	407		
Ratings of single capacitors or of capacitor banks (minimum inductance between parallel capacitors 6 µH) at 50 Hz, 60 Hz and	at 230 V	kvar	114	162		
	400 V	kvar	199	282		
	500 V	kvar	248	352		
	690 V	kvar	199	282		

1) Industrial furnaces and electric heaters with resistance heating, for example (higher current input allowed for during heating up).

2) Acc. to VDE 0660 Part 102. For rated values for various starting conditions, see Section 3.

3) Ambient temperature 50 °C for 3RT10 76-.N contactor

4) Ambient temperature 55 °C for 3RT10 76-.N contactor

Contactors for Switching Motors

3RT10.7. contactors

CONTACTORS AND ASSEMBLIES 2

Technical data

Contactors	Size Type	S12 3RT10 75	S12 3RT10 76
------------	-----------	-----------------	-----------------

Main circuit

Load ratings with DC

DC-1 utilization category, switching resistive load (L/R ≤ 1 ms)		Rated operational current I_e (at 60 °C)		
Number of conducting paths connected in series		1	2	3
up to 24 V	A	400	400	400
60 V	A	330	400	400
110 V	A	33	400	400
220 V	A	3.8	400	400
440 V	A	0.9	4	11
600 V	A	0.6	2	5.2

DC-3 and DC-5 utilization categories, shunt and series motors (L/R ≤ 15 ms)		Rated operational current I_e (at 60 °C)		
Number of conducting paths connected in series		1	2	3
up to 24 V	A	400	400	400
60 V	A	11	400	400
110 V	A	3	400	400
220 V	A	0.6	2.5	400
440 V	A	0.18	0.65	1.4
600 V	A	0.125	0.37	0.75

Operating frequency

Operating frequency z in operating cycles per hour		Contactors without overload relays		Contactors with overload relays (mean value)	
No-load operating frequency		1/h	2000	1/h	2000
Dependence of the operating frequency z' on the operational current I' and the operational voltage U' :		for AC-1	700	for AC-1	500
		for AC-2	200	for AC-2	170
		for AC-3	500	for AC-3	420
		for AC-4	130	for AC-4	130
$z' = z \cdot \frac{I_e}{I'} \cdot \left(\frac{400V}{U'}\right)^{1.5}$ 1/h					

Contactors	Size Type	S12 3RT10 7.
------------	-----------	-----------------

Conductor cross-sections

Screw connections		Front terminal connected	Back terminal connected	Both terminals connected
Main conductor: with 3RT19 66-4G box terminal				
Finely stranded with end sleeve	mm ²	70 ... 240	120 ... 185	min. 2 × 50, max. 2 × 185
Finely stranded without end sleeve	mm ²	70 ... 240	120 ... 185	min. 2 × 50, max. 2 × 185
Stranded	mm ²	95 ... 300	120 ... 240	min. 2 × 70, max. 2 × 240
AWG conductor connections, solid or stranded	AWG	3/0 ... 600 kcmil	250 ... 500 kcmil	min. 2 × 2/0, max. 2 × 500 kcmil
Ribbon cable (qty. × width × thickness)	mm	min. 6 × 9 × 0.8	min. 6 × 9 × 0.8	
- Terminal screws	mm	max. 20 × 24 × 0.5	max. 20 × 24 × 0.5	max. 2 × (20 × 24 × 0.5)
- Tightening torque	Nm	M 12 (hexagon socket, A/F 5) 20 ... 22 (180 ... 195 lb.in)		
Without box terminal/busbar connection				
Finely stranded with cable lug	mm ²	50 ... 240	If cable lugs acc. to DIN 46 234 are connected, as of a conductor cross-section of 240 mm ² and acc. to DIN 46 235 as of a conductor cross-section of 185 mm ² a 3RT19 66-4EA1 terminal cover is necessary to comply with the phase clearance.	
Stranded with cable lug	mm ²	70 ... 240		
AWG conductor connections, solid or stranded	AWG	2/0 ... 500 kcmil		
Connecting bar (max. width)	mm	25		
- Terminal screws		M 10 × 30 (A/F 17)		
- Tightening torque	Nm	14 ... 24 (124 ... 210 lb.in)		
Auxiliary conductor:				
Solid	mm ²	2 × (0.5 ... 1.5); 2 × (0.75 ... 2.5) acc. to IEC 60 947;		
Finely stranded with end sleeve	mm ²	max. 2 × (0.75 ... 4) 2 × (0.5 ... 1.5); 2 × (0.75 ... 2.5)		
AWG conductor connections, solid or stranded	AWG	2 × (18 ... 14)		
- Terminal screws		M 3 (PZ 2)		
- Tightening torque	Nm	0.8 ... 1.2 (7 ... 10.3 lb.in)		

Contactors for Switching Motors

3RT12.6. vacuum contactors

Technical data		S10 3RT12 64	S10 3RT12 65	S10 3RT12 66
Contactors	Size Type			
General data				
Permissible mounting position The contactors are designed for operation on a vertical mounting surface.				
Mechanical endurance		Oper. cycles	10 million	
Electrical endurance			See page 2/123	
Rated insulation voltage U_i (pollution degree 3)		V	1000	
Rated impulse withstand voltage U_{imp}		kV	8	
Safe isolation between coil, auxiliary contacts and main contacts (acc. to DIN VDE 0106 Part 101 and A1 [draft 2/89])		V	690	
Positively driven operation There is positively driven operation if the NC and NO contacts cannot be closed at the same time			Yes, between main contacts and auxiliary NC contacts and within the auxiliary switch blocks acc. to ZH 1/457, IEC 60 947-4-1, Annex H (draft 17B/996/DC)	
Permissible ambient temperature		in operation when stored	°C °C	-25 ... +60/+55 with AS-Interface -55 ... +80
Degree of protection acc. to IEC 60 947-1 and DIN 40 050			IP 00/open type, coil system IP 20	
Shock resistance		Rectangular pulse Sine pulse	g/ms g/ms	8.5/5 and 4.2/10 13.4/5 and 6.5/10
Conductor cross-sections			See page 2/157	
Electromagnetic compatibility (EMC)			See page 2/106	
Short-circuit protection				
Main circuit				
Fuse links, utilization category gL/gG NH Type 3NA, DIAZED Type 5SB, NEOZED Type 5SE - to IEC 60 947-4/EN 60 947-4-4 (VDE 0660 Part 102)				
	Type of coord. "1" 1)	A	500	
	Type of coord. "2" 1)	A	500	
	Weld-free 2)	A	400	
Auxiliary circuit				
Fuse links, utilization category gL/gG (weld-free protection at $I_k \geq 1$ kA) DIAZED Type 5SB, NEOZED Type 5SE or miniature circuit-breaker with C-characteristic ($I_k < 400$ A)				
		A	10	
Control circuit				
Coil voltage tolerance		AC/DC (UC)	$0.8 \times U_{s \min} \dots 1.1 \times U_{s \max}$	
Power consumption of solenoid mechanism (with coil in cold state and rated range $U_{s \min} \dots U_{s \max}$)			Conventional op. mechanism Solid-state op. mechanism	
			$U_{s \min}$	$U_{s \max}$
AC operation	closing	VA	530	630
	p.f.		0.9	0.9
	closed	VA	6.1	7.4
	p.f.		0.9	0.9
DC operation	closing	W	580	700
	closed	W	6.8	8.2
			420	570
			0.8	0.8
			4.3	5.6
			0.8	0.8
			3.4	4.2
PLC control input (EN 61 131-2/Type 2)			DC 24 V \leq 30 mA	
Operating times (Break-time = opening time + arcing time)			Conventional op. mechanism Solid-state op. mechanism	
			Operation via A1/A2 PLC input	
- at $0.8 \times U_{s \min} \dots 1.1 \times U_{s \max}$	closing time	ms	30 ... 95	105 ... 145
	opening time	ms	40 ... 80	80 ... 100
- at $U_{s \min} \dots U_{s \max}$	closing time	ms	35 ... 50	110 ... 130
	opening time	ms	50 ... 80	80 ... 100
Arcing time		ms	10 ... 15	10 ... 15

1) According to excerpt from IEC 60 947-4-1 (VDE 0660 Part 102):
Type of coordination "1":
Destruction of the contactor and the overload relay is permissible. The contactor and/or overload relay must be replaced if necessary.

Type of coordination "2":
No damage can be tolerated to the overload relay, but contact welding on the contactor is permitted if the contacts can be easily separated.

2) Test conditions acc. to IEC 60 947-4-1.

Contactors for Switching Motors

3RT12.6. vacuum contactors

CONTACTORS AND ASSEMBLIES 2

Technical data

Contactors	Size Type	S10 3RT12 64	S10 3RT12 65	S10 3RT12 66
------------	-----------	--------------	--------------	--------------

Main circuit

Load ratings with AC

AC-1 utilization category, switching resistive load

Rated operational currents I_e	at 40 °C up to 1000 V	A	330		
	at 60 °C up to 1000 V	A	300		
Ratings of three-phase loads 1) p.f. = 0.95 (at 60 °C)	at 230 V	kW	113		
	400 V	kW	197		
	500 V	kW	246		
	690 V	kW	340		
	1000 V	kW	492		
Minimum conductor cross-section with $I_{e,load}$	at 40 °C	mm ²	185		
	60 °C	mm ²	185		

AC-2 and AC-3 utilization categories

Rated operational currents I_e	up to 1000 V	A	225	265	300
Ratings of slipring or squirrel-cage motors at 50 Hz and 60 Hz	at 230 V	kW	73	85	97
	400 V	kW	128	151	171
	500 V	kW	160	189	215
	690 V	kW	223	265	288
	1000 V	kW	320	378	428

Thermal loading capacity

10 s current 2)	A	1800	2120	2400
-----------------	---	------	------	------

Power loss per conducting path

at $I_e/AC-3$	W	9	12	14
---------------	---	---	----	----

AC-4 utilization category (at $I_a = 6 \times I_e$)

Rated operational current I_e	up to 690 V	A	195	230	280
Ratings of squirrel-cage motors at 50 Hz and 60 Hz	at 400 V	kW	110	132	160

• For a contact endurance of approx. 400 000 operating cycles:

Rated operational currents I_e	up to 690 V	A	97	115	140
	1000 V	A	68	81	98
Ratings of squirrel-cage motors at 50 Hz and 60 Hz	at 230 V	kW	30	37	45
	400 V	kW	55	65	79
	500 V	kW	68	81	98
	690 V	kW	94	112	138
	1000 V	kW	95	114	140

AC-6a utilization category, switching three-phase transformers

with inrush		n	30	20	
Rated operational current I_e	up to 690 V	A	185	278	
Ratings of three-phase transformers with an inrush of n = 30 or 20. The ratings must be re-calculated for other inrush factors x:	at 230 V	kVA	74	111	
	400 V	kVA	128	193	
	500 V	kVA	160	241	
	690 V	kVA	221	332	
	1000 V	kVA	320	482	

$$P_x = P_{n30} \cdot \frac{30}{x}$$

AC-6b utilization category, switching low-inductance (low-loss, metallized-dielectric) three-phase capacitors

Ambient temperature 40 °C					
Rated operational currents I_e	up to 500 V	A	220		
Ratings of single capacitors or of capacitor banks (minimum inductance between parallel capacitors 6 µH) at 50 Hz, 60 Hz and	at 230 V	kvar	88		
	400 V	kvar	152		
	500 V	kvar	191		
	690 V	kvar	152		

Operating frequency

Operating frequency z in operating cycles per hour



Contactors without overload relays	No-load operating frequency	1/h	2000	2000
Dependence of the operating frequency z' on the operational current I' and the operational voltage U':	for AC-1	1/h	800	750
	for AC-2	1/h	300	250
	for AC-3	1/h	750	750
	for AC-4	1/h	250	250
$z' = z \cdot \frac{I_e}{I'} \cdot \left(\frac{400 V}{U'} \right)^{1.5}$		1/h		
Contactors with overload relays (mean value)		1/h	60	60

1) Industrial furnaces and electric heaters with resistance heating, for example (higher current input allowed for during heating up).

2) Acc. to VDE 0660 Part 102. For rated values for various starting conditions, see Section 3.

Contactors for Switching Motors

3RT12.6. vacuum contactors

Technical data		S10 3RT12 6.		
Contactor	Size Type			
Conductor cross-sections				
Screw connections				
Main conductor: with 3RT19 66-4G box terminal		Front terminal connected	Back terminal connected	Both terminals connected
Finely stranded with end sleeve	mm ²	70 ... 240 	120 ... 185 	min. 2 × 50, max. 2 × 185 
Finely stranded without end sleeve	mm ²	70 ... 240	120 ... 185	min. 2 × 50, max. 2 × 185
Stranded	mm ²	95 ... 300	120 ... 240	min. 2 × 70, max. 2 × 240
AWG conductor connections, solid or stranded	AWG	3/0 ... 600 kcmil	250 ... 500 kcmil	min. 2 × 2/0, max. 1 × 500 kcmil
Ribbon cable (qty. × width × thickness)	mm mm	min. 6 × 9 × 0.8 max. 20 × 24 × 0.5	min. 6 × 9 × 0.8 max. 20 × 24 × 0.5	max. 2 × (20 × 24 × 0.5)
- Terminal screws		M 12 (hexagon socket, A/F 5)		
- Tightening torque	Nm	20 ... 22 (180 ... 195 lb.in)		
Without box terminal/busbar connection				
Finely stranded with cable lug	mm ²	50 ... 240	If cable lugs acc. to DIN 46 234 are connected, as of a conductor cross-section of 240 mm ² and acc. to DIN 46 235 as of a conductor cross-section of 185 mm ² a 3RT19 66-4EA1 terminal cover is necessary to comply with the phase clearance.	
Stranded with cable lug	mm ²	70 ... 240		
AWG conductor connections, solid or stranded	AWG	2/0 ... 500 kcmil		
Connecting bar (max. width)	mm	25		
- Terminal screws		M 10 × 30 (A/F 17)		
- Tightening torque	Nm	14 ... 24 (124 ... 210 lb.in)		
Auxiliary conductor:				
Solid	mm ²	2 × (0.5 ... 1.5); 2 × (0.75 ... 2.5) acc. to IEC 60 947; max. 2 × (0.75 ... 4)		
Finely stranded with end sleeve	mm ²	2 × (0.5 ... 1.5); 2 × (0.75 ... 2.5)		
AWG conductor connections, solid or stranded	AWG	2 × (18 ... 14)		
- Terminal screws		M 3 (PZ 2)		
- Tightening torque	Nm	0.8 ... 1.2 (7 ... 10.3 lb.in)		

Contactors for Switching Motors

3RT12.7. contactors

Technical data

Contactors	Size Type	S12 3RT12 75	S12 3RT12 76
------------	-----------	-------------------------------	-------------------------------

General data

Permissible mounting position
The contactors are designed for operation on a vertical mounting surface.

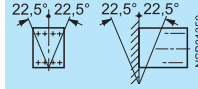

Mechanical endurance	Oper. cycles	10 million
Electrical endurance		See page 2/123
Rated insulation voltage U_i (pollution degree 3)	V	1000
Rated impulse withstand voltage U_{imp}	kV	8
Safe isolation between coil, auxiliary contacts and main contacts (acc. to DIN VDE 0106 Part 101 and A1 [draft 2/89])	V	690
Positively driven operation There is positively driven operation if the NC and NO contacts cannot be closed at the same time		Yes, between main contacts and auxiliary NC contacts and within the auxiliary switch blocks acc. to ZH 1/457, IEC 60 947-4-1, Annex H (draft 17B/996/DC)
Permissible ambient temperature	in operation when stored	°C -25 ... +60/+55 with AS-Interface °C -55 ... +80
Degree of protection acc. to IEC 60 947-1 and DIN 40 050		IP 00/open type, coil system IP 20
Shock resistance	Rectangular pulse Sine pulse	g/ms g/ms 8.5/5 and 4.2/10 13.4/5 and 6.5/10
Conductor cross-sections		See page 2/160
Electromagnetic compatibility (EMC)		See page 2/106

Short-circuit protection

Main circuit			
Fuse links, utilization category gL/gG NH Type 3NA, DIAZED Type 5SB, NEOZED Type 5SE – to IEC 60 947-4/EN 60 947-4-4 (VDE 0660 Part 102)			
Type of coord. "1" 1)	A	800	
Type of coord. "2" 1)	A	800	
Weld-free 2)	A	500	
Auxiliary circuit			
Fuse links, utilization category gL/gG (weld-free protection at $I_k \geq 1$ kA) DIAZED Type 5SB, NEOZED Type 5SE or miniature circuit-breaker with C-characteristic ($I_k < 400$ A)			
	A	10	

Control circuit

Coil voltage tolerance	AC/DC (UC)	$0.8 \times U_{s \min} \dots 1.1 \times U_{s \max}$			
Power consumption of solenoid mechanism (with coil in cold state and rated range $U_{s \min} \dots U_{s \max}$)		Conventional op. mechanism		Solid-state op. mechanism	
		$U_{s \min}$	$U_{s \max}$	$U_{s \min}$	$U_{s \max}$
AC operation	closing	700	830	560	750
	p.f.	0.9	0.9	0.8	0.8
	closed	7.6	9.2	5.4	7
	p.f.	0.9	0.9	0.8	0.8
DC operation	closing	770	920	600	800
	closed	8.5	10	4	5
PLC control input (EN 61 131-2/Type 2)		DC 24 V/≤ 30 mA			
Operating times (Break-time = opening time + arcing time)		Conventional op. mechanism		Solid-state op. mechanism Operation via A1/A2	
					PLC input
– at $0.8 \times U_{s \min} \dots 1.1 \times U_{s \max}$	closing time	45 ... 100		120 ... 150	60 ... 90
	opening time	60 ... 100		80 ... 100	80 ... 100
– at $U_{s \min} \dots U_{s \max}$	closing time	50 ... 70		125 ... 150	65 ... 80
	opening time	70 ... 100		80 ... 100	80 ... 100
Arcing time		10 ... 15		10 ... 15	10 ... 15

1) According to excerpt from IEC 60 947-4-1 (VDE 0660 Part 102):
Type of coordination "1":
Destruction of the contactor and the overload relay is permissible. The contactor and/or overload relay must be replaced if necessary.

Type of coordination "2":
No damage can be tolerated to the overload relay, but contact welding on the contactor is permitted if the contacts can be easily separated.

2) Test conditions acc. to IEC 60 947-4-1.

Contactors for Switching Motors

3RT12.7. vacuum contactors

Technical data

Contactor	Size Type	S12 3RT12 75	S12 3RT12 76
-----------	-----------	-----------------	-----------------

Main circuit

Load ratings with AC

AC-1 utilization category, switching resistive load

Rated operational currents I_e	at 40 °C up to 1000 V	A	610	
	at 60 °C up to 1000 V	A	550	
Ratings of three-phase loads 1) p.f. = 0.95 (at 60 °C)	at 230 V	kW	208	
	400 V	kW	362	
	500 V	kW	452	
	690 V	kW	624	
	1000 V	kW	905	
Minimum conductor cross-section with $I_{e,load}$	at 40 °C	mm ²	2 × 185	
	60 °C	mm ²	2 × 185	

AC-2 and AC-3 utilization categories

Rated operational currents I_e	up to 1000 V	A	400	500
Ratings of slipring or squirrel-cage motors at 50 Hz and 60 Hz	at 230 V	kW	132	164
	400 V	kW	231	291
	500 V	kW	291	363
	690 V	kW	400	507
	1000 V	kW	578	728

Thermal loading capacity

10 s current 2)	A	3200	4000
-----------------	---	------	------

Power loss per conducting path

at $I_e/AC-3$	W	21	32
---------------	---	----	----

AC-4 utilization category (at $I_a = 6 \times I_e$)

Rated operational current I_e	up to 690 V	A	350	430
Ratings of squirrel-cage motors at 50 Hz and 60 Hz	at 400 V	kW	200	250

• For a contact endurance of approx. 400 000 operating cycles:

Rated operational currents I_e	up to 690 V	A	175	215
	1000 V	A	123	151
Ratings of squirrel-cage motors at 50 Hz and 60 Hz	at 230 V	kW	56	70
	400 V	kW	98	122
	500 V	kW	124	153
	690 V	kW	172	212
	1000 V	kW	183	217

AC-6a utilization category, switching three-phase transformers with inrush

Rated operational current I_e	up to 690 V	A	279	419
Ratings of three-phase transformers with an inrush of $n = 30$ or 20. The ratings must be re-calculated for other inrush factors x:	at 230 V	kVA	111	167
	400 V	kVA	193	290
	500 V	kVA	241	363
	690 V	kVA	332	501
	1000 V	kVA	482	726

$$P_x = P_{n,30} \cdot \frac{30}{x}$$

AC-6b utilization category, switching low-inductance (low-loss, metallized-dielectric) three-phase capacitors

Ambient temperature 40 °C				
Rated operational currents I_e	up to 500 V	A	407	
Ratings of single capacitors or of capacitor banks (minimum inductance between parallel capacitors 6 µH) at 50 Hz, 60 Hz and	at 230 V	kvar	162	
	400 V	kvar	282	
	500 V	kvar	352	
	690 V	kvar	282	

Operating frequency

Operating frequency z in operating cycles per hour

Contactor without overload relays	No-load operating frequency	1/h	2000	
Dependence of the operating frequency z' on the operational current I' and the operational voltage U':	for AC-1	1/h	700	
	for AC-2	1/h	250	
	for AC-3	1/h	750	
	for AC-4	1/h	250	
$z' = z \cdot \frac{I_e}{I'} \cdot \left(\frac{400 V}{U'}\right)^{1.5}$		1/h		
Contactor with overload relays (mean value)		1/h	60	



1) Industrial furnaces and electric heaters with resistance heating, for example (higher current input allowed for during heating up).

2) Acc. to VDE 0660 Part 102. For rated values for various starting conditions, see Section 3.

Contactors for Switching Motors



3RT12.7. vacuum contactors

Technical data

Contactor	Size Type	S12 3RT12 7.		
Conductor cross-sections				
Screw connections				
Main conductor: with 3RT19 66-4G box terminal		Front terminal connected	Back terminal connected	Both terminals connected
Finely stranded with end sleeve	mm ²	70 ... 240 	120 ... 185 	min. 2 × 50, max. 2 × 185 min. 2 × 50, max. 2 × 185 min. 2 × 70, max. 2 × 240 min. 2 × 2/0, max. 2 × 500 kcmil
Finely stranded without end sleeve	mm ²	70 ... 240	120 ... 185	
Stranded	mm ²	95 ... 300	120 ... 240 	
AWG conductor connections, solid or stranded	AWG	3/0 ... 600 kcmil	250 ... 500 kcmil	
Ribbon cable (qty. × width × thickness)	mm mm	min. 6 × 9 × 0.8 max. 20 × 24 × 0.5	min. 6 × 9 × 0.8 max. 20 × 24 × 0.5	
– Terminal screws		M 12 (hexagon socket, A/F 5)		
– Tightening torque	Nm	20 ... 22 (180 ... 195 lb.in)		
<u>Without box terminal/busbar connection</u>				
Finely stranded with cable lug	mm ²	50 ... 240	If cable lugs acc. to DIN 46 234 are connected, as of a conductor cross-section of 240 mm ² and acc. to DIN 46 235 as of a conductor cross-section of 185 mm ² a 3RT19 66-4EA1 terminal cover is necessary to comply with the phase clearance.	
Stranded with cable lug	mm ²	70 ... 240		
AWG conductor connections, solid or stranded	AWG	2/0 ... 500 kcmil		
Connecting bar (max. width)	mm	25		
– Terminal screws		M 10 × 30 (A/F 17)		
– Tightening torque	Nm	14 ... 24 (124 ... 210 lb.in)		
Auxiliary conductor:				
Solid	mm ²	2 × (0.5 ... 1.5); 2 × (0.75 ... 2.5) acc. to IEC 60 947; max. 2 × (0.75 ... 4)		
Finely stranded with end sleeve	mm ²	2 × (0.5 ... 1.5); 2 × (0.75 ... 2.5)		
AWG conductor connections, solid or stranded	AWG	2 × (18 ... 14)		
– Terminal screws		M 3 (PZ 2)		
– Tightening torque	Nm	0.8 ... 1.2 (7 ... 10.3 lb.in)		

Contactors for Switching Motors

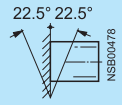
3RT24 contactors, 3-pole, for switching resistive loads (AC-1)

Technical data																																												
Contactor	Size	S3																																										
	Type	3RT24 46																																										
General data																																												
Permissible mounting position The contactors are designed for operation on a vertical mounting surface.		AC and DC operation	  <p>For DC operation and forward inclination up to 22.5°: coil voltage tolerance 0.85 ... 1.1 x U_s</p>																																									
Upright mounting position:																																												
		AC operation	Special design required. Positions 13 ... 16 of the Order No. must be changed to -1AA0 . Additional charge.																																									
		DC operation	-																																									
Mechanical endurance		Oper. cycles	10 million																																									
Electrical endurance AC-1 utilization category at I_e		Oper. cycles	0.5 million																																									
Rated insulation voltage U_i (pollution degree 3)		V	1000																																									
Rated impulse withstand voltage U_{imp}		kV	6																																									
Safe isolation between coil and main contacts (acc. to DIN VDE 0106 Part 101 and A1 [draft 2/89])		V	690																																									
Permissible ambient temperature		in operation	°C	-25 ... +60																																								
		when stored	°C	-55 ... +80																																								
Degree of protection acc. to IEC 60 947-1 and DIN 40 050		IP 20 (terminal compartment IP 00), coil system IP 40																																										
Shock resistance																																												
Rectangular pulse	AC and DC operation	g/ms	6.8/5 and 4/10																																									
Sine pulse	AC and DC operation	g/ms	10.6/5 and 6.2/10																																									
Conductor cross-sections		See page 2/163																																										
Short-circuit protection of contactors without overload relays																																												
Main circuit																																												
Fuse links, utilization category gL/gG NH, Type 3NA	Type of coord. "1" 2)	A	250																																									
Fuse links, utilization category gR SITOR, Type 3NE	Type of coord. "2" 2)	A	250																																									
Auxiliary circuit																																												
Fuse links, utilization category gL/gG (weld-free protection at $I_k \geq 1$ kA) DIAZED Type 5SB, NEOZED Type 5SE		A	10																																									
or miniature circuit-breaker with C-characteristic ($I_k < 400$ A)		A	10																																									
Control circuit																																												
Coil voltage tolerance		AC/DC	0.8 ... 1.1 x U_s																																									
Power consumption of the coils (with coil in cold state and 1.0 x U_s)			<table border="1"> <thead> <tr> <th colspan="2"></th> <th colspan="2">Standard design</th> <th colspan="2">For USA and Canada</th> </tr> <tr> <th></th> <th></th> <th>50/60</th> <th>50</th> <th>60</th> <th></th> </tr> </thead> <tbody> <tr> <td rowspan="4">AC operation</td> <td>Hz</td> <td>270</td> <td>270</td> <td>270</td> <td>300</td> </tr> <tr> <td>VA</td> <td>0.68</td> <td>0.7 / 0.62</td> <td>0.68</td> <td>0.52</td> </tr> <tr> <td rowspan="2">p.f.</td> <td>closed</td> <td>22</td> <td>27 / 20</td> <td>22</td> <td>21</td> </tr> <tr> <td>opening</td> <td>0.27</td> <td>0.29/ 0.31</td> <td>0.27</td> <td>0.29</td> </tr> <tr> <td>DC operation</td> <td>closing = closed</td> <td>W</td> <td colspan="3">15</td> </tr> </tbody> </table>				Standard design		For USA and Canada				50/60	50	60		AC operation	Hz	270	270	270	300	VA	0.68	0.7 / 0.62	0.68	0.52	p.f.	closed	22	27 / 20	22	21	opening	0.27	0.29/ 0.31	0.27	0.29	DC operation	closing = closed	W	15		
		Standard design		For USA and Canada																																								
		50/60	50	60																																								
AC operation	Hz	270	270	270	300																																							
	VA	0.68	0.7 / 0.62	0.68	0.52																																							
	p.f.	closed	22	27 / 20	22	21																																						
		opening	0.27	0.29/ 0.31	0.27	0.29																																						
DC operation	closing = closed	W	15																																									
Operating times at 0.8 ... 1.1 x U_s 1) Break-time = opening time + arcing time																																												
AC operation	closing time	ms	17 ... 90																																									
	opening time	ms	10 ... 25																																									
DC operation	closing time	ms	90 ... 230																																									
	opening time	ms	14 ... 20																																									
Arcing time		ms	10 ... 15																																									
Operating times at 1.0 x U_s 1)																																												
AC operation	closing time	ms	18 ... 30																																									
	opening time	ms	11 ... 23																																									
DC operation	closing time	ms	100 ... 120																																									
	opening time	ms	16 ... 20																																									

1) The opening times of the NO contacts and the closing times of the NC contacts increase if the contactor coils are protected against voltage peaks: varistor +2 ms to 5 ms, diode assemblies 2 to 6 times.

2) According to excerpt from IEC 60 947-4-1 (VDE 0660 Part 102):
Type of coordination "1":
Destruction of the contactor and the overload relay is permissible. The contactor and/or overload relay must be replaced if necessary.

Type of coordination "2":
No damage can be tolerated to the overload relay, but contact welding on the contactor is permitted if the contacts can be easily separated.

Contactors for Special Applications

3RT24 contactors, 3-pole, for switching resistive loads (AC-1)

Technical data

Contactors	Size Type	S3 3RT24 46
------------	-----------	------------------------------

Main circuit

Load ratings with AC

AC-1 utilization category, switching resistive load

Rated operational currents I_e	at 40 °C up to 690 V	A	140
	at 60 °C up to 690 V	A	130
	at 1000 V	A	60
Ratings of three-phase loads p.f. = 0.95 (at 60 °C)	at 230 V	kW	50
	400 V	kW	86
	500 V	kW	107
	690 V	kW	148
	1000 V	kW	98
Minimum conductor cross-section with $I_{e,load}$	at 40 °C	mm ²	50
	at 60 °C	mm ²	50

AC-2 and AC-3 utilization categories

With an electrical endurance of 1.3 million operating cycles

Rated operational current I_e	up to 690 V	A	44
Ratings of slipping or squirrel-cage motors at 50 Hz and 60 Hz (at 60 °C)	at 230 V	kW	12.7
	400 V	kW	22
	500 V	kW	29.9
	690 V	kW	38.2

Power loss per conducting path	at $I_e/AC-1$	W	12.5
--------------------------------	---------------	---	------

Load ratings with DC

DC-1 utilization category, switching resistive load $L/R \leq 1$ ms

Number of conducting paths when connected in series

			1	2	3
Rated operational currents I_e (at 60 °C)	up to 24 V	A	130	130	130
	60 V	A	80	130	130
	110 V	A	12	130	130
	220 V	A	2.5	13	130
	440 V	A	0.8	2.4	6
	600 V	A	0.48	1.3	3.4

DC-3 and DC-5 utilization categories, shunt and series motors

Number of conducting paths when connected in series

			1	2	3
Rated operational currents I_e (at 60 °C)	up to 24 V	A	6	130	130
	60 V	A	3	130	130
	110 V	A	1.25	130	130
	220 V	A	0.35	1.75	4
	440 V	A	0.15	0.42	0.8
	600 V	A	0.1	0.27	0.45

Operating frequency



Operating frequency z in operating cycles per hour				AC operation	DC operation
Contactors without overload relays	No-load operating frequency	1/h	5000	5000	1000
Rated operation	for AC-1	1/h	650	650	650
	for AC-3	1/h	1000	1000	1000

Dependence of the operating frequency z' on the operational current I' and the operational voltage U' :

$$z' = z \cdot \frac{I_e}{I'} \cdot \left(\frac{400V}{U'} \right)^{1.5} \quad 1/h$$

Contactors for Special Applications

3RT24 contactors, 3-pole, for switching resistive loads (AC-1)

Technical data		S3 3RT24 46		
Contactor	Size Type			
Conductor cross-sections				
Screw connections (1 or 2 conductor connections possible)	Main conductor: <u>With box terminal</u>	Front terminal connected	Back terminal connected	Both terminals connected
	Finely stranded with end sleeve Finely stranded without end sleeve Solid Stranded Ribbon cable (qty. x width x thickness) AWG conductor connections – Terminal screws – Tightening torque	mm ² mm ² mm ² mm ² mm AWG Nm	2.5 ... 50 4 ... 50 2.5 ... 16 4 ... 70 6 × 9 × 0.8 10 ... 2/0 	2.5 ... 50 10 ... 50 2.5 ... 16 10 ... 70 6 × 9 × 0.8 10 ... 2/0 
Connection for drilled copper bars	max. width	M 6 (hexagon socket) 4 ... 6 (36 ... 53 lb.in) 10	If bars larger than 12 × 10 mm are connected, a 3RT19 46-4EA1 terminal cover is necessary to comply with the phase clearance	
<u>Without box terminal with cable lugs</u>				
	Finely stranded with cable lug	mm ²	10 ... 50 ¹⁾	If conductors larger than 25 mm ² are connected, a 3RT19 46-4EA1 terminal cover is necessary to comply with the phase clearance
	Stranded with cable lug	mm ²	10 ... 70 ¹⁾	
	AWG conductor connections, solid or stranded	AWG	7 ... 1/0	
Auxiliary conductor:				
	Solid	mm ²	2 × (0.5 ... 1.5); 2 × (0.75 ... 2.5) acc. to IEC 60 947; max. 2 × (0.75 ... 4)	
	Finely stranded with end sleeve	mm ²	2 × (0.5 ... 1.5); 2 × (0.75 ... 2.5)	
	AWG conductor connections, solid or stranded – Terminal screws – Tightening torque	AWG Nm	2 × (20 ... 16); 2 × (18 ... 14); 1 × 12 M 3 0.8 ... 1.2 (7 ... 10.3 lb.in)	

Contactors for Special Applications

3RT14 contactors, 3-pole, for switching resistive loads (AC-1)

Technical data			
Contactors	Size Type	S6 3RT14 56	
General data			
Permissible mounting position The contactors are designed for operation on a vertical mounting surface.			
Mechanical endurance	Oper. cycles	10 million	
Electrical endurance AC-1 utilization category at I_e	Oper. cycles	0.5 million	
Rated insulation voltage U_i (pollution degree 3)	V	1000	
Rated impulse withstand voltage U_{imp}	kV	8	
Safe isolation between coil, auxiliary contacts and main contacts (acc. to DIN VDE 0106 Part 101 and A1 [draft 2/89])	V	690	
Permissible ambient temperature	in operation when stored	°C	-25 ... +60/+55 with AS-Interface -55 ... +80
Degree of protection acc. to IEC 60 947-1 and DIN 40 050	IP 00/open type, coil system IP 20		
Shock resistance			
Rectangular pulse	g/ms	8.5/5 and 4.2/10	
Sine pulse	g/ms	13.4/5 and 6.5/10	
Conductor cross-sections	See page 2/165		
Electromagnetic compatibility (EMC)	See page 2/106		
Short-circuit protection			
Main circuit			
Fuse links, utilization category gL/gG, NH, Type 3NA	Type of coordination "1" A	355	
Fuse links, utilization category gR, SITOR, Type 3NE	Type of coordination "2" A	350	
Auxiliary circuit			
Fuse links, utilization category gL/gG (weld-free protection at $I_k \geq 1$ kA) DIAZED Type 5SB, NEOZED Type 5SE or miniature circuit-breaker with C-characteristic ($I_k < 400$ A)	A	10	
Control circuit			
Coil voltage tolerance	AC/DC (UC)	$0.8 \times U_{s \min} \dots 1.1 \times U_{s \max}$	
Power consumption of solenoid mechanism (with coil in cold state and rated range $U_{s \min} \dots U_{s \max}$)		Conventional op. mechanism	
		$U_{s \min}$	$U_{s \max}$
AC operation	closing	250	300
	p.f.	0.9	0.9
	closed	4.8	5.8
	p.f.	0.8	0.8
DC operation	closing	300	360
	closed	4.3	5.2
		Solid-state op. mechanism	
		$U_{s \min}$	$U_{s \max}$
		190	280
		0.8	0.8
		3.5	4.4
		0.5	0.4
PLC control input (EN 61 131-2/Type 2)		DC 24 V ≤ 30 mA	
Operating times (Break-time = opening time + arcing time)		Conventional op. mechanism	
		Solid-state op. mechanism Operation via A1/A2	
		PLC input	
- at $0.8 \times U_{s \min} \dots 1.1 \times U_{s \max}$	closing time	20 ... 95	95 ... 135
	opening time	40 ... 60	80 ... 90
- at $U_{s \min} \dots U_{s \max}$	closing time	25 ... 50	100 ... 120
	opening time	40 ... 60	80 ... 90
Arcing time		10 ... 15	10 ... 15
Main circuit			
Load ratings with AC			
AC-1 utilization category, switching resistive load			
Rated operational currents I_e	at 40 °C up to 690 V	A	275
	at 60 °C up to 690 V	A	250
	at 1000 V	A	100
Ratings of three-phase loads p.f. = 0.95 (at 60 °C)	at 230 V	kW	95
	400 V	kW	165
	500 V	kW	205
	690 V	kW	285
	1000 V	kW	165
Minimum conductor cross-section with $I_{e \text{ load}}$	at 40 °C	mm ²	2 × 70
	at 60 °C	mm ²	120
Power loss per conducting path	at I_e /AC-1	W	20

Special Applications

3RT14 contactors, 3-pole, for switching resistive loads (AC-1)

Technical data		
Contactors	Size Type	S6 3RT14 56

Main circuit

Load ratings with AC

AC-2 and AC-3 utilization category
With an electrical endurance of 1.3 million operating cycles

Rated operational current I_e	up to 690 V	A	97
Ratings of slipping or squirrel-cage motors at 50 Hz and 60 Hz (at 60°C)	at 230 V	kW	30
	400 V	kW	55
	500 V	kW	55
	690 V	kW	90

Load ratings with DC

DC-1 utilization category, switching resistive load (L/R ≤ 1 ms)
Number of conducting paths connected in series

			1	2	3
Rated operational currents I_e (at 60°C)	up to 24 V	A	315	315	315
	60 V	A	315	315	315
	110 V	A	18	315	315
	220 V	A	3.4	20	315
	440 V	A	0.8	3.2	11.5
	600 V	A	0.5	1.6	4

DC-3 and DC-5 utilization categories, shunt and series motors (L/R ≤ 15 ms)
Number of conducting paths connected in series

			1	2	3
Rated operational currents I_e (at 60°C)	up to 24 V	A	315	315	315
	60 V	A	7.5	315	315
	110 V	A	2.5	315	315
	220 V	A	0.6	2.5	315
	440 V	A	0.17	0.65	1.4
	600 V	A	0.12	0.37	0.75

Operating frequency

Operating frequency z in operating cycles per hour

Contactors without overload relays	No-load op. frequency	1/h	2000
	for AC-1	1/h	600
	for AC-3	1/h	1000

Dependence of the operating frequency z' on the operational current I' and operational voltage U' :

$$z' = z \cdot \frac{I_e}{I'} \cdot \left(\frac{400V}{U'} \right)^{1.5} \text{ 1/h}$$

Conductor cross-sections

Screw connections	Main conductor:	Front terminal connected	Back terminal connected	Both terminals connected
	with 3RT19 55-4G box terminal			
	Finely stranded with end sleeve	10 ... 70	10 ... 70	max. 1x50, 1x70
	Finely stranded without end sleeve	10 ... 70	10 ... 70	max. 1x50, 1x70
	Stranded	16 ... 70	16 ... 70	max. 2 x 70
	AWG conductor connections, solid or stranded	6 ... 2/0	6 ... 2/0	max. 2 x 1/0
	Ribbon cable (qty. x width x thickness)	mm	mm	max. 2 x (6 x 15.5 x 0.8)
	with 3RT19 56-4G box terminal			
	Finely stranded with/without end sleeve	10 ... 120	10 ... 120	max. 1 x 95, 1 x 120
	Stranded	16 ... 120	16 ... 120	max. 2 x 120
	AWG conductor connections, solid or stranded	AWG	AWG	max. 2 x 3/0
	Ribbon cable (qty. x width x thickness)	mm	mm	max. 2 x (10 x 15.5 x 0.8)
	- Terminal screws	mm	mm	
	- Tightening torque	Nm	Nm	
	Without box terminal/busbar connection			
	Finely stranded with cable lug	16 ... 95	If cable lugs acc. to DIN 46 235 are connected, as of a conductor cross-section of 95 mm ² a 3RT19 56-4EA1 terminal cover is necessary to comply with the phase clearance.	
	Stranded with cable lug	25 ... 120		
	AWG conductor connections, solid or stranded	4 ... 250 kcmil		
	Connecting bar (max. width)	mm		
	- Terminal screws	M 8 x 25 (A/F 13)		
	- Tightening torque	Nm		
	Auxiliary conductor:			
	Solid	mm ²		2 x (0.5 ... 1.5); 2 x (0.75 ... 2.5) acc. to IEC 60 947; max. 2 x (0.75 ... 4)
	Finely stranded with end sleeve	mm ²		2 x (0.5 ... 1.5); 2 x (0.75 ... 2.5)
	AWG conductor connections, solid or stranded	AWG		2 x (18 ... 14)
	- Terminal screws	Nm		M 3 (PZ2)
	- Tightening torque	Nm		0.8 ... 1.2 (7 ... 10.3 lb.in)

Contactors for Special Applications

3RT14 contactors, 3-pole, for switching resistive loads (AC-1)

Technical data				S10 3RT14 66	S12 3RT14 76	
Contactors	Size Type					
General data						
Permissible mounting position The contactors are designed for operation on a vertical mounting surface.						
Mechanical endurance	Oper. cycles		10 million			
Electrical endurance AC-1 utilization category at I_e	Oper. cycles		0.5 million			
Rated insulation voltage U_i (pollution degree 3)	V		1000			
Rated impulse withstand voltage U_{imp}	kV		8			
Safe isolation between coil, auxiliary contacts and main contacts (acc. to DIN VDE 0106 Part 101 and A1 [draft 2/89])	V		690			
Permissible ambient temperature	in operation when stored	°C °C	-25 ... +60/+55 with AS-Interface -55 ... +80			
Degree of protection acc. to IEC 60 947-1 and DIN 40 050			IP 00/open type, coil system IP 20			
Shock resistance						
Rectangular pulse	g/ms		8.5/5 and 4.2/10			
Sine pulse	g/ms		13.4/5 and 6.5/10			
Conductor cross-sections	See page 2/168					
Electromagnetic compatibility (EMC)	See page 2/106					
Short-circuit protection						
Main circuit						
Fuse links, utilization category gL/gG, NH, Type 3NA	Type of coordination "1"	A	500		800	
Fuse links, utilization category gR, SITOR, Type 3NE	Type of coordination "2"	A	500		710	
Auxiliary circuit						
Fuse links, utilization category gL/gG (weld-free protection at $I_k \geq 1$ kA) DIAZED Type 5SB, NEOZED Type 5SE or miniature circuit-breaker with C-characteristic ($I_k < 400$ A)	A		10			
Contactors	Size Type		S10 3RT14 66			
Control circuit						
Coil voltage tolerance	AC/DC (UC)		$0.8 \times U_{s,min} \dots 1.1 \times U_{s,max}$			
Power consumption of solenoid mechanism (with coil in cold state and rated range $U_{s,min} \dots U_{s,max}$)						
AC operation	closing p.f.	VA	Conventional op. mechanism		Solid-state op. mechanism	
			$U_{s,min}$	$U_{s,max}$	$U_{s,min}$	$U_{s,max}$
	closed p.f.	VA	490	590	400	530
			0.9	0.9	0.8	0.8
			5.6	6.7	4	5
			0.9	0.9	0.5	0.4
DC operation	closing closed	W W	Conventional op. mechanism		Solid-state op. mechanism	
			$U_{s,min}$	$U_{s,max}$	$U_{s,min}$	$U_{s,max}$
			540	650	440	580
			6.1	7.4	3.2	3.8
PLC control input (EN 61 131-2/Type 2)	DC 24 V/≤ 30 mA					
Operating times (Break-time = opening time + arcing time)						
- at $0.8 \times U_{s,min} \dots 1.1 \times U_{s,max}$	closing time opening time	ms ms	Conventional op. mechanism		Solid-state op. mechanism Operation via A1/A2	
			$U_{s,min}$	$U_{s,max}$	$U_{s,min}$	PLC input
			30 ... 95		105 ... 145	45 ... 80
			40 ... 80		80 ... 200	80 ... 100
- at $U_{s,min} \dots U_{s,max}$	closing time opening time	ms ms	Conventional op. mechanism		Solid-state op. mechanism	
			$U_{s,min}$	$U_{s,max}$	$U_{s,min}$	$U_{s,max}$
			35 ... 50		110 ... 130	50 ... 65
			50 ... 80		80 ... 100	80 ... 100
Arcing time		ms	10 ... 15		10 ... 15	10 ... 15

Contactors for Special Applications

3RT14 contactors, 3-pole, for switching resistive loads (AC-1)

Technical data				
Contactors	Size Type	S12 3RT14 76		
Control circuit				
Coil voltage tolerance		AC/DC (UC)	$0.8 \times U_{s \min} \dots 1.1 \times U_{s \max}$	
Power consumption of solenoid mechanism (with coil in cold state and rated range $U_{s \min} \dots U_{s \max}$)				
AC operation	closing p.f.	VA	$U_{s \min}$ 700	
			$U_{s \max}$ 830	
			560	
DC operation	closing	VA	750	
			0.8	
			0.8	
DC operation	closed	W	770	
		W	8.5	
			920	
			10	
			600	
			4	
			800	
			5	
PLC control input (EN 61 131-2/Type 2)				
DC 24 V/≤ 30 mA				
Operating times (Break-time = opening time + arcing time)				
- at $0.8 \times U_{s \min} \dots 1.1 \times U_{s \max}$		closing time	ms	45 ... 100
			ms	60 ... 100
- at $U_{s \min} \dots U_{s \max}$		opening time	ms	50 ... 70
			ms	70 ... 100
Arcing time		closing time	ms	10 ... 15
			ms	10 ... 15
			120 ... 150	
			80 ... 100	
			80 ... 100	
			125 ... 150	
			80 ... 100	
			80 ... 100	
			10 ... 15	
			10 ... 15	
Contactors	Size Type	S10 3RT14 66	S12 3RT14 76	

Main circuit			
Load ratings with AC			
AC-1 utilization category, switching resistive load			
Rated operational currents I_e	at 40 °C up to 690 V	A	400
	at 60 °C up to 690 V	A	380
	at 1000 V	A	690
			650 1)
Ratings of three-phase loads p.f. = 0.95 (at 60 °C)	at 230 V	kW	145
	400 V	kW	250
	500 V	kW	315
	690 V	kW	430
	1000 V	kW	740
Minimum conductor cross-section with $I_{e \text{ load}}$	at 40 °C	mm ²	240
	at 60 °C	mm ²	240
			2 × 240
			2 × 240
Power loss per conducting path		at $I_e/AC-1$	W
			27
			55
AC-2 and AC-3 utilization categories With an electrical endurance of 1.3 million operating cycles			
Rated operational current I_e	up to 690 V	A	138
			170
Ratings of slipping or squirrel-cage motors at 50 Hz and 60 Hz (at 60 °C)	at 230 V	kW	37
	400 V	kW	75
	500 V	kW	90
	690 V	kW	132
			55
			90
			110
			160

Load ratings with DC			
DC-1 utilization category, switching resistive load (L/R ≤ 1 ms)			
Number of conducting paths connected in series			
1			
2			
3			
1			
2			
3			
Rated operational currents I_e (at 60 °C)	up to 24 V	A	380
	60 V	A	380
	110 V	A	33
	220 V	A	3.8
	440 V	A	0.9
	600 V	A	0.6
			380
			380
			380
			3.8
			0.9
			0.6
			500
			500
			500
			3.8
			4
			2
			500
			500
			500
			5.2
			11
			5.2
DC-3 and DC-5 utilization categories, shunt and series motors (L/R ≤ 15 ms)			
Number of conducting paths connected in series			
1			
2			
3			
1			
2			
3			
Rated operational currents I_e (at 60 °C)	up to 24 V	A	380
	60 V	A	11
	110 V	A	3
	220 V	A	0.6
	440 V	A	0.18
	600 V	A	0.125
			380
			380
			380
			0.6
			0.18
			0.125
			500
			500
			500
			2.5
			0.65
			0.37
			500
			500
			500
			1.4
			0.75

1) Ambient temperature 50 °C for 3RT14 76-N contactor

Contactors for Special Applications

3RT14 contactors, 3-pole, for switching resistive loads (AC-1)

Technical data

Contactors	Size Type	S10 3RT14 66	S12 3RT14 76
------------	-----------	-------------------------------	-------------------------------

Main circuit

Operating frequency



Operating frequency z in operating cycles per hour

Contactors without overload relays	No-load op. frequency	1/h	2000
	for AC-1	1/h	600
	for AC-3	1/h	1000

Dependence of the operating frequency z' on the operational current I' and operational voltage U' :

$$z' = z \cdot \frac{I_e}{I'} \cdot \left(\frac{400V}{U'} \right)^{1.5} \quad 1/h$$

Conductor cross-sections

Screw connections	Main conductor: with 3RT19 66-4G box terminal	Front terminal connected	Back terminal connected	Both terminals connected
Finely stranded with end sleeve	mm ²	70 ... 240 	120 ... 185 	min. 2 × 50, max. 2 × 185 
Finely stranded without end sleeve	mm ²	70 ... 240	120 ... 185	min. 2 × 50, max. 2 × 185
Stranded	mm ²	95 ... 300	120 ... 240	min. 2 × 70, max. 2 × 240
AWG conductor connections, solid or stranded		3/0 ... 600 kcmil	250 ... 500 kcmil	min. 2 × 2/0, max. 2 × 500 kcmil
Ribbon cable (qty. × width × thickness)	mm	min. 6 × 9 × 0,8	min. 6 × 9 × 0,8	max. 2 × (20 × 24 × 0,5)
	mm	max. 20 × 24 × 0,5	max. 20 × 24 × 0,5	
– Terminal screws		M 12 (hexagon socket, A/F 5)		
– Tightening torque	Nm	20 ... 22 (180 ... 195 lb.in)		
<u>Without box terminal/busbar connection</u>				
Finely stranded with cable lug	mm ²	50 ... 240	If cable lugs acc. to DIN 46 234 are connected, as of a conductor cross-section of 240 mm ² and DIN 46 235 as of a conductor cross-section of 185 mm ² , a 3RT19 66-4EA1 terminal cover is necessary to comply with the phase clearance.	
Stranded with cable lug	mm ²	70 ... 240		
AWG conductor connections, solid or stranded	AWG	2/0 ... 500 kcmil		
Connecting bar (max. width)	mm	25		
– Terminal screws		M 10 × 30 (A/F 17)		
– Tightening torque	Nm	14 ... 24 (124 ... 210 lb.in)		
Auxiliary conductor:				
Solid	mm ²	2 × (0,5 ... 1,5); 2 × (0,75 ... 2,5) acc. to IEC 60 947; max. 2 × (0,75 ... 4)		
Finely stranded with end sleeve	mm ²	2 × (0,5 ... 1,5); 2 × (0,75 ... 2,5)		
AWG conductor connections, solid or stranded	AWG	2 × (18 ... 14)		
– Terminal screws		M 3 (PZ3)		
– Tightening torque	Nm	0,8 ... 1,2 (7 ... 10,3 lb.in)		

Contactors for Special Applications

3RT23 contactors, 4-pole (4 NO), switching resistive loads

More information

Contactors	Type		3RT23 16	3RT23 17	3RT23 25	3RT23 26	3RT23 27	
	Size		S00		S0			
Dimensions (W x H x D) ³⁾	Width	mm	45 x 57.5 x 73		60 x 85 x 97			
General data								
Permissible mounting position¹⁾								
Mechanical endurance		Operating cycles	30 million		10 million			
Electrical endurance at I_e/AC-1		Operating cycles	Approx. 0.5 million					
Rated insulation voltage U_i (pollution degree 3)		V	690					
Permissible ambient temperature	• During operation • During storage	°C	-25 ... +60					
		°C	-55 ... +80					
Degree of protection Acc. to EN 60947-1, Appendix C	Device Connection range		IP20			IP20 IP00		
Touch protection acc. to EN 50274			Finger-safe					
Short-circuit protection of contactors without overload relays								
Main circuit								
Fuse links, gG operational class: LV HRC 3NA, DIAZED 5SB, NEOZED 5SE according to IEC 60947-4-1/ EN 60947-4-1	• Type of coordination *1*1) • Type of coordination *2*1) • Weld-free	A A A	35 20 10		63 20 16			
Control								
Solenoid coil operating range								
• AC operation	- At 50 Hz - At 60 Hz		0.8 ... 1.1 x U _s 0.85 ... 1.1 x U _s		-- --			
• DC operation	- At 50 °C - At 60 °C		0.8 ... 1.1 x U _s 0.85 ... 1.1 x U _s		-- --			
• AC/DC operation			--		0.8 ... 1.1 x U _s			
Power consumption of the solenoid coils (when coil is cold and 1.0 x U _s)								
• AC operation, 50 Hz, standard version	- Closing - P.f.	VA	-- --		77 0.82			
	- Closed - P.f.	VA	-- --		9.8 0.25			
• AC operation, 50/60 Hz, standard version	- Closing - P.f.	VA	27/24.3 0.8/0.75	37/33 0.8/0.75	81/79 0.72/0.74			
	- Closed - P.f.	VA	4.2/3.3 0.25/0.25	5.7/4.4 0.25/0.25	10.5/8.5 0.25/0.28			
• AC operation, 60 Hz, USA, Canada	- Closing - P.f.	VA	31.7 0.77	43 0.77	87 0.76			
	- Closed - P.f.	VA	4.8 0.25	6.5 0.25	9.4 0.28			
• DC operation	- Closing = Closed	W	4		5.9			
Operating times for 0.8 ... 1.1 x U_s²⁾								
Total break time = Opening delay + Arcing time								
• AC operation	- Closing delay - Opening delay	ms	8 ... 35 3.5 ... 14	8 ... 33 4 ... 15	9 ... 38 4 ... 16	8 ... 40 4 ... 16		
• DC operation	- Closing delay - Opening delay	ms	30 ... 100 7 ... 13		50 ... 170 15 ... 17.5			
• Arcing time		ms	10 ... 15		10			
Main circuit								
AC capacity								
Utilization category AC-1, switching resistive loads								
• Rated operational currents I _e	At 40 °C, up to 690 V	A	18	22	35	40	50	
	At 60 °C, up to 690 V	A	16	20	30	35	42	
• Rated power for AC loads P.f. = 0.95 (at 40 °C)	At 460 V	HP	5	5	10	10	10	
• Minimum conductor cross-section for loads with I _e	At 40 °C	mm ²	2.5	2.5	10	10	10	
	At 60 °C	mm ²	2.5	2.5	10	10	10	
Utilization category AC-3								
• Rated operational currents I _e	At 60 °C, up to 400 V	A	9	12	15.5	17	17	
• Rated power for slipping or squirrel-cage motors at 60 Hz	At 460 V	HP	5	5	10	10	10	

1) In accordance with the corresponding 3-pole 3RT2. contactors.
2) With size S00, DC operation: Operating times at 0.85 ... 1.1 x U_s.

3) Dimensions for devices with screw terminals. Size S0 for AC operation. DC operation: Depth + 10mm.

Contactors for Special Applications

3RT23 contactors, 4-pole (4 NO), for switching resistive loads

Technical specifications

Type		3RT23 36	3RT23 44	3RT23 46
Size		S2	S3	S3
Dimensions (W x H x D)	mm	74.5 x 113.5 x 130 / 74.5 x 113.5 x 130	73 x 112 x 110	93 x 146 x 134
• With mounted auxiliary switch block	mm	74.5 x 113.5 x 173.5 / 74.5 x 113.5 x 177.5	73 x 112 x 160	93 x 146 x 183

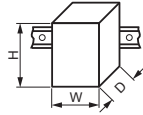

General technical specifications

Permissible mounting position¹⁾		
Mechanical endurance	Operating cycles	10 million
Electrical endurance at I_e/AC-1	Operating cycles	Approx. 0.5 million
Rated insulation voltage U_i (pollution degree 3)	V	690
Permissible ambient temperature		
• During operation	°C	-25 ... +60
• During storage	°C	-55 ... +80
Degree of protection acc. to IEC 60947-1, Appendix C	Device Connection range	IP20
Touch protection acc. to EN 50274		Finger-safe

Short-circuit protection of contactors without overload relays

Main circuit				
Fuse links, operational class gG: LV HRC, 3NA; DIAZED, 5SB; NEOZED, 5SE according to IEC 60947-4-1/EN 60947-4-1	• Type of coordination "1" ¹⁾ • Type of coordination "2" ¹⁾ • Weld-free	A A A	on request on request on request	250 125 63
				250 160 100

Control circuit

Coil operating range (AC/DC)		0.8 ... 1.1 x U _s	
Power consumption of the solenoid coils (when coil is cold and 1.0 x U _s)			
• AC operation, 50 Hz	- Closing - P.f. - Closed - P.f.	VA VA VA VA	190 0.72 16 0.37
			270 0.68 22 0.27
• AC operation, 50/60 Hz	- Closing - P.f. - Closed - P.f.	VA VA VA VA	210/188 0.69/0.65 17.2/16.5 0.36/0.3
			298/274 0.72/0.62 27/20 0.29/0.31
• DC operation	- Closing = Closed	W	15
Operating times for 0.8 ... 1.1 x U_s²⁾ Total break time = Opening delay + Arcing time			
• DC operation	- Closing delay - Opening delay	ms ms	110 ... 200 14 ... 20
• AC operation	- Closing delay - Opening delay	ms ms	10 ... 80 10 ... 18
			20 ... 50 10 ... 25
• Arcing time		ms	10 ... 20
			10 ... 15

Main circuit

AC capacity

Utilization category AC-1, switching resistive loads				
• Rated operational currents I _e	At 40 °C, up to 690 V At 60 °C, up to 690 V	A A	60 55	110 100
				140 120
• Rated power for AC loads P.f. = 0.95 (at 40 °C)	At 230 V 400 V	kW kW	21 36	42 72
				53 92
• Minimum conductor cross-section for loads with I _e	At 40 °C At 60 °C	mm ² mm ²	16 25	50 50
				50 50
Utilization categories AC-2 and AC-3				
• Rated operational currents I _e	At 60 °C, up to 400 V	A	--	--
• Rated power for slipping or squirrel-cage motors at 50 and 60 Hz	At 230 V 400 V	kW kW	-- --	-- --

¹⁾ In accordance with the corresponding 3-pole 3RT1 contactors.

²⁾ With size S00, DC operation: Operating times for 0.85 ... 1.1 x U_s

Contactors for Special Applications

3RT25 contactors, 4-pole (2 NO + 2 NC), for switching motors

Technical specifications

Type		3RT2516	3RT2517	3RT2518	3RT2526	3RT2535	3RT2536
Size		S00			S0	S2	
General technical specifications							
Permissible mounting position							
The contactors are designed for operation on a vertical mounting surface.							
Upright mounting position		<p>Special version required</p>					
Mechanical endurance	Operating cycles	30 million			10 million		
Electrical endurance at $I_e/AC-1$		Operating cycles: Approx. 0.5 million					
Rated insulation voltage U_i (Pollution degree 3)		V: 690					
Permissible ambient temperature							
• During operation		°C: -25 ... +60			-25 ... +60		
• During storage		°C: -55 ... +80			-55 ... +80		
Degree of protection acc. to IEC 60947-1, Appendix C		IP20					
Touch protection acc. to EN 50274		Finger-safe					
Short-circuit protection							
Main circuit							
Fuse links, operational class gG: LV HRC, type 3NA; DIAZED, type 5SB; NEOZED, type 5SE according to IEC 60947-4-1/EN 60947-4-1							
• Type of coordination "1"		A	35		63	125	160
• Type of coordination "2"		A	20		35	63	80
• Weld-free		A	10		16	--	--

Type		3RT2516	3RT2517	3RT2518	3RT2536	3RT2537
Size		S00			S2	
Dimensions (W x H x D) ¹⁾		45 x 57.5 x 73 / 45 x 70 x 73			74.5 x 113.5 x 130 / 74.5 x 113.5 x 130	
• with mounted auxiliary switch block		45 x 57.5 x 116 / 45 x 70 x 121			74.5 x 113.5 x 173.5 / 74.5 x 113.5 x 177.5	
Type		3RT2526				
Size		S0				
Dimensions (W x H x D) for AC operation ¹⁾²⁾		mm	60 x 85 x 97 / 60 x 101.5 x 97			
• with mounted auxiliary switch block		mm	60 x 85 x 141 / 60 x 101.5 x 144			
Dimensions (W x H x D) for DC operation ¹⁾²⁾		mm	60 x 85 x 107 / 60 x 101.5 x 107			
• with mounted auxiliary switch block		mm	60 x 85 x 151 / 60 x 101.5 x 154			

¹⁾ Dimensions for devices with screw terminals/spring-type terminals.
²⁾ For size S0, devices for AC and DC operation differ in depth. The following applies: Depth (DC) = Depth (AC) + 10 mm.

Contactors for Special Applications

3RT25 contactors, 4-pole (2 NO + 2 NC), for switching motors

Type		3RT2516	3RT2517	3RT2518	3RT2526	3RT2535	3RT2536
Size		S00			S0	S2	
Control circuit							
Solenoid coil operating range							
• AC operation	at 50 Hz	0.8 ... 1.1 x U_s			0.8 ... 1.1 x U_s		
	at 60 Hz	0.85 ... 1.1 x U_s			0.8 ... 1.1 x U_s		
• DC operation	up to 50 °C	0.8 ... 1.1 x U_s			--		
	up to 60 °C	0.85 ... 1.1 x U_s			--		
• AC/DC operation		--			0.8 x U_{smin} ... 1.1 x U_{smax}		
Power consumption of the solenoid coils (for cold coil and 1.0 x U_s)		see 3RT2316	see 3RT2317		see 3RT2326	see 3RT233	
Operating times for 0.8 to 1.1 x U_s (Total break time = Opening delay + Arcing time)		see 3RT2316	see 3RT2317		see 3RT2326	see 3RT233	
Main circuit							
Load rating with AC							
Utilization category AC-1							
Switching resistive loads							
• Rated operational currents I_e	at 40 °C up to 690 V	A	18	22	40	60	70
	at 60 °C up to 690 V	A	16	20	35	55	60
• Rated power for AC loads	at 230 V	kW	6	7.5	13.3	21	23
	400 V	kW	10.5	13	23	36	39
	p.f. = 0.95 (at 60 °C)						
• Minimum conductor cross-section for loads with I_e	at 40 °C	mm ²	2.5	2.5	10	16	25
Utilization categories AC-2 and AC-3							
• Rated operational currents I_e	NO up to 400 V	A	9	12	16	AC ¹⁾ 25	DC ¹⁾ 25
	NC up to 400 V	A	9	9	9	25	20
						35	35
• Rated power for slipping or squirrel-cage motors at 50 and 60 Hz	NO at 230 V	kW	2.2	3	4	5.5	5.5
	NC at 230 V	kW	2.2	2.2	2.2	5.5	5.5
	NO at 400 V	kW	4	5.5	7.5	11	11
	NC at 400 V	kW	4	4	4	11	7.5
						18.5	18.5
						22	22
Load rating with DC							
Utilization category DC-1							
Switching resistive loads ($L/R \leq 1$ ms)							
• Rated operational currents I_e (at 60 °C)							
- 1 conducting path	up to 24 V	A	16	20	35	55	60
	60 V	A	16	20	20	23	
	110 V	A	2.1	2.1	4.5	4.5	
	220 V	A	0.8	0.8	1	1	
	440 V	A	0.6	0.6	0.4	0.4	
- 2 conducting paths in series	up to 24 V	A	16	20	35	55	
	60 V	A	16	20	35	45	
	110 V	A	12	12	35	45	
	220 V	A	1.6	1.6	5	5	
	440 V	A	0.8	0.8	1	1	
Utilization category DC-3/DC-5²⁾							
Shunt-wound and series-wound motors ($L/R \leq 15$ ms)							
• Rated operational currents I_e (at 60 °C)							
- 1 conducting path	up to 24 V	A	16	20	20	35	
	60 V	A	0.5	0.5	5	6	
	110 V	A	0.15	0.15	2.5	2.5	
	220 V	A	0.75	0.75	1	1	
	440 V	A	--	--	0.09	0.1	
- 2 conducting paths in series	up to 24 V	A	16	20	35	55	
	60 V	A	5	5	35	45	
	110 V	A	0.35	0.35	15	25	
	220 V	A	--	--	3	5	
	440 V	A	--	--	0.27	0.27	

¹⁾ Values for devices with AC and DC operation: for 3RT25 26 with DC operation, different values apply to AC-2 and AC-3 for the NC.



²⁾ For $U_s > 24$ V, the rated operational currents I_e for the NC contact conducting paths are 50 % of the values for the NO contact conducting paths.

Contactors for Special Applications

3RT16 capacitor contactors

Technical specifications

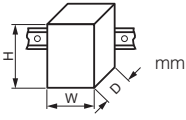
All technical specifications not mentioned in the table below are identical to those of the 3RT10 17 contactors for size S00, to those of the 3RT10 26 contactors for size S0 and to those of the 3RT10 45 contactors for size S3.

Type		3RT16 17-.A..3 S00	3RT16 27-.A..1 S0	3RT16 47-.A..1 S3
Size				
Dimensions (W x H x D) including auxiliary switches and connecting cables		45 x 101 x 105	45 x 100 x 130	70 x 167 x 183
General technical specifications				
Capacitor rating at rated power (utilization category AC-6b)	230 V, 50/60 Hz kvar 400 V, 50/60 Hz kvar 525 V, 50/60 Hz kvar 690 V, 50/60 Hz kvar	3 ... 7.5 5 ... 12.5 7.5 ... 15 10 ... 21	3.5 ... 15 6 ... 25 7.8 ... 30 10 ... 42	3.5 ... 30 5 ... 50 7.5 ... 60 10 ... 84
Auxiliary contacts mounted (unassigned)		1 NO + 1 NC	1 NO	
Auxiliary contacts mountable (lateral), not for sizes S00 and S0		--		2 NC + 2 NO or 1 NO + 1 NC
Max. switching frequency	h ⁻¹	180	100	
Electrical endurance	Operating cycles	> 250000	> 150000	> 100000
Ambient temperature	°C	60		
Short-circuit protection		1.6 ... 2.2 x I _e		
Coil operating range		0.8 ... 1.1 x U _s		
Conductor cross-sections (1 or 2 conductors connectable)				
Main conductors		 Screw terminals		
• Solid	mm ²	2 x (0.5 ... 1.5) ² ; 2 x (0.75 ... 2.5) ² according to IEC 60947; max. 2 x (1 ... 4) ²	2 x (1 ... 2.5) ² ; 2 x (2.5 ... 6) ² ¹ according to IEC 60947; max. 1 x 10 ¹ ²	--
• Finely stranded with end sleeve	mm ²	2 x (0.5 ... 1.5) ² ; 2 x (0.75 ... 2.5) ²	2 x (1 ... 2.5) ² ; 2 x (2.5 ... 6) ¹ ²	--
• AWG cables				
- Solid	AWG	2 x (20 ... 16)	2 x (16 ... 12)	--
- Solid or stranded	AWG	2 x (18 ... 14)	2 x (14 ... 10)	--
- Stranded	AWG	1 x 12	1 x 8	--
• Terminal screws		M3	M4 (Pozidriv size 2)	--
- Tightening torque	Nm lb.in	0.8 ... 1.2 7 ... 10.3	2 ... 2.5 18 ... 22	--

¹) 3RV19 25-5AB feeder terminal for 16 mm².
²) If two different conductor cross-sections are connected to one clamping point, both cross-sections must lie in one of the ranges specified.

Contactors for Special Applications

3RT20 coupling relays (interface) for switching motors

More information

All technical specifications not mentioned in the table below are identical to those of the 3RT20 contactors for switching motors (see 2/128-2/130)

Contactors	Type		3RT20 1.-.HB4.	3RT20 1.-.JB4.	3RT20 1.-.KB4.	3RT20 2.-.KB4.
	Size		S00	S00	S00	S0
	Width	mm	45	45	45	45
General data						
Mechanical endurance		Operating cycles	30 million			10 million
Protective separation between the coil and the main contacts acc. to EN 60947-1, Appendix N		V	400			
Control						
Solenoid coil operating range			0.7 ... 1.25 x U _s			
Power consumption of the solenoid coil (for cold coil)	At U _s	17 V W	1.6			2.3
Closing = Closed		24 V W	2.8			4.5
		30 V W	4.4			7
Permissible residual current of the electronics (for 0 signal)			< 10 mA x (24 V/U _s)			< 6 mA x (24 V/U _s)
Overvoltage configuration of the solenoid coil			Without overvoltage damping 	With diode 	With suppressor diode 	With varistor
Operating times of the coupling contactors						
• Closing						
- At 17 V	ON-delay NO	ms	40 ... 130			70 ... 270
	OFF-delay NC	ms	30 ... 80			60 ... 250
- At 24 V	ON-delay NO	ms	35 ... 60			65 ... 90
	OFF-delay NC	ms	25 ... 40			55 ... 80
- At 30 V	ON-delay NO	ms	25 ... 50			52 ... 65
	OFF-delay NC	ms	15 ... 30			43 ... 57
• Closing at 17 ... 30 V						
	OFF-delay NO	ms	7 ... 20	38 ... 65	7 ... 20	19 ... 21
	ON-delay NC	ms	20 ... 30	55 ... 75	20 ... 30	25 ... 31

Contactors	Type		3RT20 1.-1MB4.-0KT0	3RT20 1.-1VB4.	3RT20 1.-1WB4.
	Size		S00	S00	S00
	Width	mm	45	45	45
General data					
Mechanical endurance		Operating cycles	30 million		
Protective separation between the coil and the main contacts acc. to EN 60947-1, Appendix N		V	400		
Control					
Solenoid coil operating range			0.85 ... 1.85 x U _s		
Power consumption of the solenoid coil (for cold coil)	At U _s	24 V W	1.6		
Closing = Closed					
Permissible residual current, upright mounting position			On request		
Overvoltage configuration of the solenoid coil			Without overvoltage damping 	With diode 	With suppressor diode
Operating times of the coupling contactors					
• Closing					
- At 20.5 V	ON-delay NO	ms	30 ... 120		
	OFF-delay NC	ms	20 ... 110		
- At 24 V	ON-delay NO	ms	25 ... 90		
	OFF-delay NC	ms	15 ... 80		
- At 44 V	ON-delay NO	ms	15 ... 60		
	OFF-delay NC	ms	10 ... 50		
• Opening					
	OFF-delay NO	ms	5 ... 20	20 ... 80	5 ... 20
	ON-delay NC	ms	10 ... 30	30 ... 90	10 ... 30

3TF68 and 3TF69 Vacuum contactors

Overview

Standards

IEC 60947-1, EN 60947-1,
IEC 60947-4-1, EN 60947-4-1,
IEC 60947-5-1, EN 60947-5-1 (auxiliary switches)

The 3TF68/69 contactors are climate-proof.

They are finger-safe according to EN 50274. Terminal covers may have to be fitted onto the connecting bars, depending on the configuration with other devices (see [Accessories and Spare Parts](#) on page 2/54).

Main contacts

Contact erosion indication with 3TF68/69 vacuum contactors

The contact erosion of the vacuum interrupters can be checked during operation with the help of 3 white double slides on the contactor base. If the distance indicated by one of the double slides is < 0.5 mm while the contactor is in the closed position, then the vacuum interrupter must be replaced. To ensure maximum reliability, it is recommended to replace all 3 vacuum interrupters simultaneously.

Auxiliary contacts

Contact reliability

These auxiliary contacts are particularly suitable for solid-state circuits with currents ≥ 1 mA at a voltage ≥ 17 V.

Electromagnetic compatibility

The 3TF68/69...-C contactors for AC operation are fitted with an electronically controlled solenoid operating mechanism with a high interference immunity (for EMC values see page 3/115). The solenoid coil is connected to varistors for protection against overvoltages.

The 3TF68/69...-Q.. contactors for AC operation are designed for operation in systems with AC control supply voltage which is subject to strong interference. The solenoid systems of these contactors are configured in the DC economy circuit with rectification. The rectifier bridge is connected to varistors for protection against overvoltages.

Protection of the main current paths

An integrated RC varistor connection for the main current paths dampens the switching overvoltage rises to safe values. This prevents multiple restricting. It can therefore be assumed that the motor winding cannot be damaged by switching overvoltages with steep voltage rises.

Note:

During operation in installations in which the emitted interference limits cannot be observed, e.g. when used for output contactors in converters, 3TF68/69...-Q contactors without a main current path circuit are recommended.

Technical specifications

Contactor	Type	3TF68 and 3TF69	
Rated data of the auxiliary contacts		Acc. to IEC 60947-5-1	
Rated insulation voltage U_i (pollution degree 3)	V	690	
Conventional thermal current $I_{th} = \text{Rated operational current } I_e/\text{AC-12}$	A	10	
AC load Rated operational current $I_e/\text{AC-15/AC-14}$ • For rated operational voltage U_e			
- At 24 V	A	10	
- At 110 V	A	10	
- At 125 V	A	10	
- At 220 V	A	6	
- At 230 V	A	5.6	
- At 380 V	A	4	
- At 400 V	A	3.6	
- At 500 V	A	2.5	
- At 660 V	A	2.5	
- At 690 V	A	2.3	
DC load Rated operational current $I_e/\text{DC-12}$ • For rated operational voltage U_e			
- At 24 V	A	10	
- At 60 V	A	10	
- At 110 V	A	3.2	
- At 125 V	A	2.5	
- At 220 V	A	0.9	
- At 440 V	A	0.33	
- At 600 V	A	0.22	
Rated operational current $I_e/\text{DC-13}$ • For rated operational voltage U_e			
- At 24 V	A	10	Auxiliary contacts with delayed NC contact: NS = No specification
- At 60 V	A	5	6
- At 110 V	A	1.14	NS
- At 125 V	A	0.98	0.98
- At 220 V	A	0.48	NS
- At 440 V	A	0.13	NS
- At 600 V	A	0.07	0.07
Ⓢ and Ⓣ rated data of the auxiliary contacts			
Rated voltage, max.	V AC	600	
Switching capacity		A 600, P 600	

3TF68 and 3TF69 Vacuum contactors

Contactor

3TF68 and 3TF69

Contact endurance of the auxiliary contacts

The contact endurance for utilization category AC-12 or AC-15/AC-14 depends mainly on the breaking current. It is assumed that the operating mechanisms are switched randomly, i.e. not synchronized with the phase angle of the supply system.

The characteristic curves apply to 230 V AC.

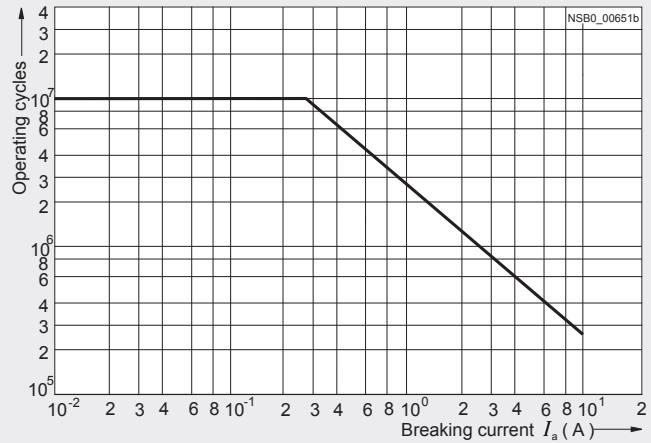

Contact erosion indication with vacuum contactors

The contact erosion of the vacuum interrupters can be checked during operation with the help of 3 white double slides on the contactor base.

If the distance indicated by one of the double slides is < 0.5 mm while the contactor is in the closed position, the vacuum interrupter must be replaced. To ensure maximum reliability, it is recommended to replace all 3 vacuum interrupters.

Contact endurance of the main contacts

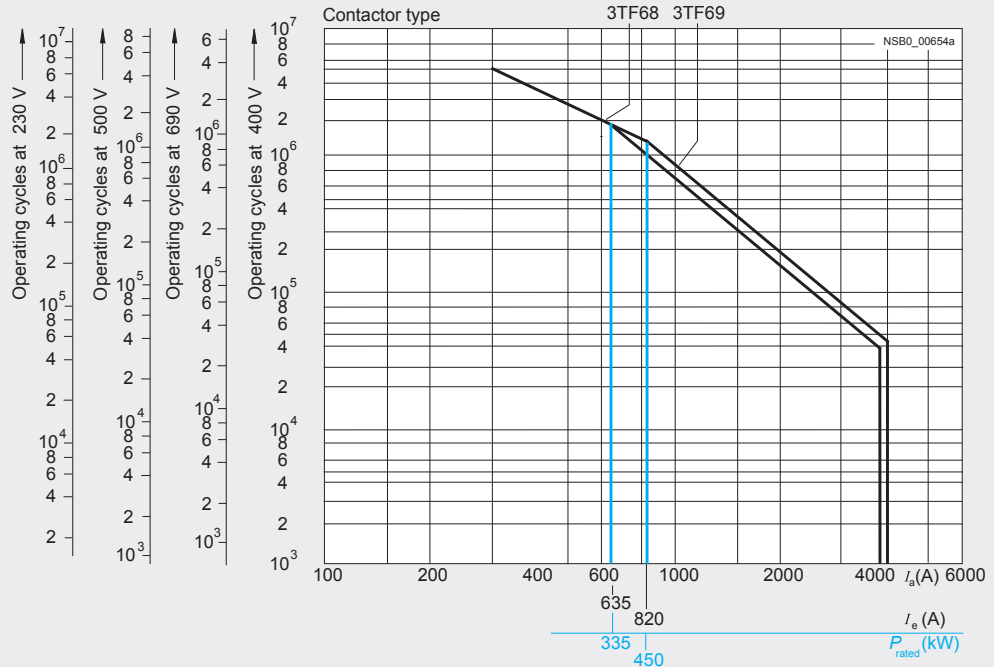

Diagram legend:
 P_{rated} = Rated power for squirrel-cage motors at 400 V
 I_a = Breaking current
 I_e^a = Rated operational current

3TF68 and 3TF69 Vacuum contactors

Type		3TF68	3TF69
Size		14	14
Dimensions (W x H x D)		230 x 276 x 237	230 x 295 x 237
General data			
Permissible mounting position, installation instructions ^{1) 2)}			
The contactors are designed for operation on a vertical mounting surface.			
Mechanical endurance	Operating cycles	5 million	
Electrical endurance	Operating cycles	³⁾	
Rated insulation voltage U_i (pollution degree 3)	kV	1	
Rated impulse withstand voltage U_{imp}	kV	8	
Protective separation between the coil and the main contacts acc. to IEC 60947-1, Appendix N	kV	1	
Mirror contacts	Yes, acc. to IEC 60947-4-1, Appendix F		
A mirror contact is an auxiliary NC contact that cannot be closed simultaneously with a NO main contact. One NC contact each must be connected in series for the right and left auxiliary switch block respectively.			
Permissible ambient temperature	°C	-25 ... +55	
• During operation ⁵⁾	°C	-55 ... +80	
• During storage			
Degree of protection acc. to IEC 60947-1, Appendix C	IP00/open (where applicable, use additional terminal covers)		
Touch protection acc. to EN 50274	Finger-safe with cover		
Shock resistance			
• Rectangular pulse			
- AC operation	g/ms	8.1/5 and 4.7/10	9.5/5 and 5.7/10
- DC operation	g/ms	9/5 and 5.7/10	8.6/5 and 5.1/10
• Sine pulse			
- AC operation	g/ms	12.8/5 and 7.4/10	13.5/5 and 7.8/10
- DC operation	g/ms	14.4/5 and 9.1/10	13.5/5 and 7.8/10
Conductor cross-sections	See page 2/180.		
Electromagnetic compatibility (EMC)	See page 2/106.		
Short-circuit protection			
Main circuit			
Fuse links, gG operational class: LV HRC, type 3NA; DIAZED, type 5SB; NEOZED, type 5SE according to IEC 60947-4-1/EN 60947-4-1			
• Type of coordination "1"	A	1000	1250
• Type of coordination "2"	A	500	630
• Weld-free ⁴⁾	A	400	500
Auxiliary circuit			
• Short-circuit test with fuse links of gG operational class: LV HRC, type 3NA; DIAZED, type 5SB; NEOZED, type 5SE with $I_k = 1$ kA acc. to IEC 60947-5-1	A	10	
• Test with miniature circuit breaker up to 230 V with C characteristic: Short-circuit current $I_k = 400$ A acc. to IEC 60947-5-1	A	10	
¹⁾ To easily replace the laterally mounted auxiliary switches it is recommended to maintain a minimum distance of 30 mm between the contactors. ²⁾ If mounted at a 90° angle (conducting paths are horizontally above each other), the switching frequency is reduced by 80% compared with the normal values. ³⁾ See "Endurance of the auxiliary contacts", page 2/176. ⁴⁾ Test conditions according to IEC 60947-4-1. ⁵⁾ For ambient temperatures > 55°C, only 3TF6.33-Q.-Z A02 contactors (= without connection of the main current path circuits) can be used. Then derating is also possible with these contactors: - AC-1: $I_{th} = 782$ A, 644 operating cycles/h; - AC-3: operating range 0.85-1.05 x U_n , 460 operating cycles/hour, mechanical endurance 5 million operating cycles, lateral clearance 10 mm			

3TF68 and 3TF69 Vacuum contactors

Contactor	Type	3TF68	3TF69
	Size	14	14
Control			
Coil operating range		0.8 x $U_{s\ min}$... 1.1 x $U_{s\ max}$	
Power consumption of the solenoid coils (when coil is cold and 1.0 x U_s)			
• AC operation, $U_{s\ max}$	- Closing - Closed	VA/p.f. VA/p.f.	1850/1 49/0.15
• AC operation, $U_{s\ min}$	- Closing - Closed	VA/p.f. VA/p.f.	1200/1 13.5/0.47
• DC economy circuit ¹⁾	- Closing at 24 V - Closed	W W	1010 28
For contactors of type 3TF68/69...-Q:			
• AC operation, $U_{s\ min}$ ²⁾	- Closing - Closed	VA/p.f. VA/p.f.	1000/0.99 11/1
Operating times for 0.8 ... 1.1 x U_s (Total break time = Opening delay + Arcing time)		(Values apply to cold and warm coil)	
• AC operation	- Closing delay - Opening delay	ms ms	70 ... 120 (22 ... 65) ³⁾ 70 ... 100
• DC economy circuit	- Closing delay - Opening delay	ms ms	76 ... 110 50
• Arcing time		ms	10 ... 15
For contactors of type 3TF68/69...-Q:			
• AC operation	- Closing delay - Opening delay	ms ms	35 ... 90 65 ... 90
Operating times for 1.0 x U_s (Total break time = Opening delay + Arcing time)			
• AC operation	- Closing delay - Opening delay	ms ms	80 ... 100 (30 ... 45) ³⁾ 70 ... 100
• DC economy circuit	- Closing delay - Opening delay	ms ms	80 ... 90 50
Minimum command duration for closing	Standard Reduced make-time	ms ms	120 90
Minimum interval time between two ON commands		ms	100

¹⁾ At 24 V DC; for further voltages, deviations of up to ±10 % are possible.

²⁾ Including reversing contactor.

³⁾ Values in brackets apply to contactors with reduced operating times.

Contactor	Type	3TF6. 44- .CF7	3TF6. 44- .CM7	3TF6. 44- .CP7	3TF6. 44- .CQ7	3TF6. 44- .CS7
Electromagnetic compatibility						
Rated control supply voltage U_s	V AC	110 ... 132	200 ... 240	230 ... 277	380 ... 460	500 ... 600
Overvoltage type acc. to IEC 60801		Burst/Surge				
Degree of severity acc. to IEC 60801						
• Burst		3	4	4	4	4
• Surge		4	4	4	4	4
Overvoltage resistance						
• Burst	kV	2	4	4	4	4
• Surge	kV	6	5	5	6	6

3TF68 and 3TF69 Vacuum contactors

Contactor	Type		3TF68	3TF69
	Size		14	14
Main circuit				
AC capacity				
Utilization category AC-1				
Switching resistive loads				
• Rated operational currents I_e	At 40 °C up to 690 V	A	700	910
	At 55 °C up to 690 V	A	630	850
	At 55 °C up to 1000 V	A	450	800
• Rated power for AC loads with p.f. = 0.95 at 55°C	230 V	kW	240	323
	400 V	kW	415	558
	500 V	kW	545	735
	690 V	kW	720	970
	1000 V	kW	780	1385
• Minimum conductor cross-sections for loads with I_e	At 40°C	mm ²	2 x 240	$I_e \geq 800$ A: 2 x 60 x 5 (copper busbars)
	At 55°C	mm ²	2 x 185	$I_e < 800$ A: 2 x 240
Utilization categories AC-2 and AC-3				
• Rated operational currents I_e	Up to 690 V	A	630	820
	1000 V	A	435	580
• Rated power for slipping or squirrel-cage motors at 50 Hz and 60 Hz	At 230 V	kW	200	260
	400 V	kW	347	450
	500 V	kW	434	600
	690 V	kW	600	800
	1000 V	kW	600	800
Thermal load capacity				
	10 s current	A	5 040	7 000
Power loss per conducting path				
	At $I_e/AC-3$	W	45	70
Utilization category AC-4 (for $I_a = 6 \times I_e$)				
• Rated operational current I_e	Up to 690 V	A	610	690
• Rated power for squirrel-cage motors with 50 Hz and 60 Hz	At 400 V	kW	355	400
The following applies to a contact endurance of about 200000 operating cycles:				
• Rated operational currents I_e	Up to 690 V	A	300	360
	1000 V	A	210	250
• Rated power for squirrel-cage motors with 50 Hz and 60 Hz	At 230 V	kW	97	110
	400 V	kW	168	191
	500 V ¹⁾	kW	210	250
	690 V ¹⁾	kW	278	335
	1000 V ¹⁾	A	290	350
Switching frequency				
Switching frequency z in operating cycles/hour				
• Contactors without overload relays	No-load switching frequency AC	1/h	2000	1000
	No-load switching frequency DC	1/h	1000	1000
	AC-1	1/h	700	700
	AC-2	1/h	200	200
	AC-3	1/h	500	500
	AC-4	1/h	150	150
• Contactors with overload relays (mean value)		1/h	15	15

¹⁾ Max. permissible rated operational current $I_e/AC-4 = I_e/AC-3$ up to 500 V, for reduced contact endurance and reduced switching frequency.

3TF68 and 3TF69 Vacuum contactors

Contactor	Type	3TF68	3TF69
	Size	14	14
Conductor cross-sections			
Main conductors:		Screw terminals	
<ul style="list-style-type: none"> • Busbar connections <ul style="list-style-type: none"> - Finely stranded with cable lug - Stranded with cable lug - Solid or stranded - Connecting bar (max. width) • Terminal screw <ul style="list-style-type: none"> - Tightening torque • With box terminal¹⁾ <ul style="list-style-type: none"> - Connectable copper bars - Width - Max. thickness - Terminal screw - Tightening torque 	mm ² mm ² AWG mm Nm mm mm Nm lb.in	50 ... 240 70 ... 240 2/0 ... 500 MCM 50 M10 x 30 14 ... 24 (124 ... 210 lb.in) 15 ... 25 1 x 26 or 2 x 11 A/F 6 (hexagon socket) 25 ... 40 221 ... 354	50 ... 240 50 ... 240 2/0 ... 500 MCM 60 (U ₀ ≤ 690 V) 50 (U ₀ > 690 V) M12 x 40 20 ... 35 (177 ... 310 lb.in) 15 ... 38 1 x 46 or 2 x 18 A/F 8 (hexagon socket) 35 ... 50 266 ... 443
Auxiliary conductors:			
<ul style="list-style-type: none"> • Solid • Finely stranded with end sleeve • Pin-end connector acc. to DIN 46231 • Solid or stranded • Tightening torque 	mm ² mm ² mm ² AWG Nm lb.in	2 x (0.5 ... 1) ² /2 x (1 ... 2.5) ² 2 x (0.5 ... 1) ² /2 x (0.75 ... 2.5) ² 2 x (1 ... 1.5) 2 x (18 ... 12) 0.8 ... 1.4 7 ... 12	

1) See "Accessories and Spare Parts", page 2/54.

2) If two different conductor cross-sections are connected to one clamping point, both cross-sections must lie in one of the ranges specified.

Contactor	Type	3TF68	3TF69
	Size	14	14
Ⓢ and Ⓣ rated data			
Rated insulation voltage	V AC	600	600
Uninterrupted current	A	630	820
Maximum horsepower ratings (Ⓢ and Ⓣ approved values)			
<ul style="list-style-type: none"> • Rated power for induction motors at 60 Hz <ul style="list-style-type: none"> - At 200 V - At 230 V - At 460 V - At 575 V 	hp hp hp hp	231 266 530 664	290 350 700 860
NEMA/EEMAC ratings			
SIZE	hp	6	7
<ul style="list-style-type: none"> • Uninterrupted current <ul style="list-style-type: none"> - Open - Enclosed • Rated power for induction motors at 60 Hz <ul style="list-style-type: none"> - At 200 V - At 230 V - At 460 V - At 575 V 	A A hp hp hp hp	600 540 150 200 400 400	820 810 -- 300 600 600
Overload relays			
<ul style="list-style-type: none"> • Setting range 	Type	3RB12 .	
	A	200 ... 820	

3TC contactors

Overview

3TC4 and 3TC5

IEC 60947-1, EN 60947-1,
IEC 60947-4-1, EN 60947-4-1

The contactors are finger-safe according to EN 50274. Terminal covers may have to be fitted onto the connecting bars, depending on the configuration with other devices.

The DC motor ratings given in the tables are applicable to the DC-3 and DC-5 utilization categories with two-pole switching of the load or with the two conducting paths of the contactor connected in series.

One contactor conducting path can switch full power up to 220 V. The ratings for higher voltages are available on request.

3TC7

IEC 60947-4-1, EN 60947-4-1.

The contactors are suitable for use in any climate. They are suitable for switching and controlling DC motors as well as all other DC circuits.

The solenoid excitation is configured for a particularly large operating range. It is between 0.7 or 0.8 to 1.2 x U_s .

3TC74 contactors can be used at up to 750 V/400 A and 50 Hz in AC-1 operation.

Application

The contactors are suitable for switching and controlling DC motors as well as all other DC circuits.

A version with an especially large coil operating range is available for operation in electrically driven vehicles and in switchgears with significant fluctuations in the actuating voltage

Technical specifications

Contactors	Type	3TC4 and 3TC7	3TC5
Rated data of the auxiliary contacts			
Rated insulation voltage U_i (pollution degree 3)	V	690	
Conventional thermal current I_{th} = Rated operational current $I_e/AC-12$	A	10	10
AC load			
Rated operational current $I_e/AC-15/AC-14$ • For rated operational voltage U_e			
	24 V A	10	10
	110 V A	10	10
	125 V A	10	10
	220 V A	6	6
	230 V A	5.6	5.6
	380 V A	4	4
	400 V A	3.6	3.6
	500 V A	2.5	2.5
	660 V A	2.5	2.5
	690 V A	--	--
DC load			
Rated operational current $I_e/DC-12$ • For rated operational voltage U_e			
	24 V A	10	10
	60 V A	10	10
	110 V A	3.2	8
	125 V A	2.5	6
	220 V A	0.9	2
	440 V A	0.33	0.6
	600 V A	0.22	0.4
Rated operational current $I_e/DC-13$ • For rated operational voltage U_e			
	24 V A	10	10
	60 V A	5	5
	110 V A	1.14	2.4
	125 V A	0.98	2.1
	220 V A	0.48	1.1
	440 V A	0.13	0.32
	600 V A	0.07	0.21

3TC contactors

Contactors	Type	3TC44 ... 3TC56
Ⓢ and Ⓣ rated data of the auxiliary contacts		
Rated voltage, max.	V AC	600
Switching capacity		A 600, P 600

Contactors	Type	3TC44 ... 3TC78
Contact endurance of the main contacts		

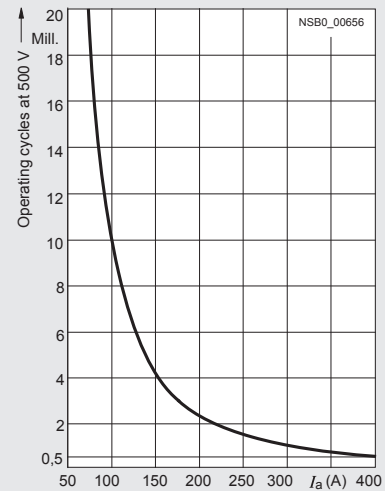
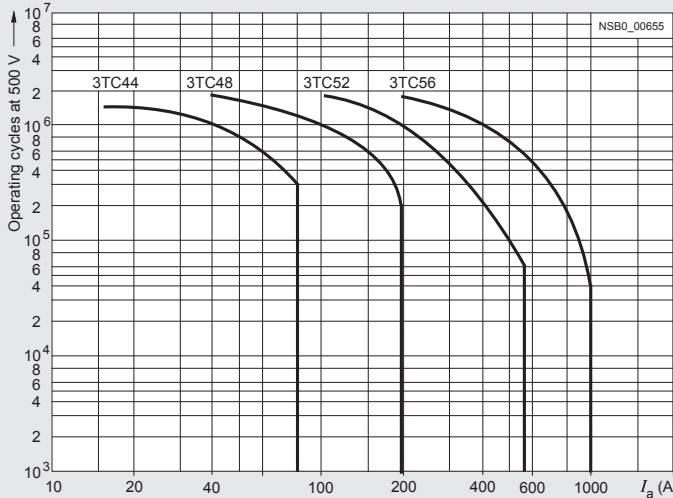

3TC44 to 3TC56 contactors

3TC74 and 3TC78 contactors

Legend for the diagrams:
 I_a = Breaking current

Contactors	Type Size	3TC44 2	3TC48 4	3TC52 8	3TC56 12
------------	-----------	-------------------	-------------------	-------------------	--------------------

General technical specifications

Permissible mounting positions

The contactors are designed for operation on a vertical mounting surface.

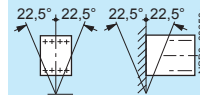

Mechanical endurance	Operating cycles	10 million				
Electrical endurance	Operating cycles	1) ¹⁾				
Rated insulation voltage U_i (pollution degree 3)	V	800		1000		
Protective separation between the coil and the main contacts acc. to IEC 60947-1, Appendix N	V	Up to 300		Up to 660		
Mirror contacts²⁾ A mirror contact is an auxiliary NC contact that cannot be closed simultaneously with a NO main contact.		Yes, acc. to IEC 60947-4-1, Appendix F				
Permissible ambient temperature						
• During operation	°C	-25 ... +55				
• During storage	°C	-50 ... +80				
Degree of protection acc. to IEC 60947-1, Appendix C		IP00/open, for AC operation, coil assembly IP40				
Shock resistance	Rectangular pulse	g/ms	7.5/5 and 3.4/10	10/5 and 5/10	12/5 and 5.5/10	12/5 and 5.6/10

Short-circuit protection

Main circuit

Fuse links, operational class gG:

LV HRC, type 3NA; DIAZED, type 5SB; NEOZED, type 5SE

• Type of coordination "1"

• Type of coordination "2"

Auxiliary circuit

• Short-circuit test with fuse links of gG operational class: DIAZED, type 5SB; NEOZED, type 5SE with short-circuit current $I_k = 1$ kA acc. to IEC 60947-5-1

• Test with miniature circuit breaker up to 230 V with C characteristic: Short-circuit current $I_k = 400$ A acc. to IEC 60947-5-1

A	50	160	250	400
A	35	63	80	250

1) See the endurance diagram above.

2) For 3TC44, one NC contact each must be connected in series for the right and left auxiliary switch block respectively.

3TC contactors

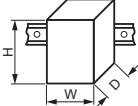
Type		3TC44	3TC48	3TC52	3TC56	
Size		2	4	8	12	
Dimensions (W x H x D)						
• DC operation	mm	70 x 85 x 141	100 x 183 x 180	135 x 238 x 232	160 x 279 x 310	
• AC operation	mm	70 x 85 x 100	100 x 183 x 154	135 x 238 x 200	160 x 279 x 251	
Control circuits						
Coil operating range		0.8 ... 1.1 x U _s				
Power consumption of the solenoid coils (for cold coil and 1.0 x U _s)						
• DC operation	- Closing = Closed	W	10	19	30	86
• AC operation, 50 Hz coil	- Closing	VA/p.f.	68/0.86	300/0.5	640/0.48	1780/0.3
	- Closed	VA/p.f.	10/0.29	26/0.24	46/0.23	121/0.22
• AC operation, 60 Hz coil	- Closing	VA/p.f.	95/0.79	365/0.45	730/0.38	2140/0.3
	- Closed	VA/p.f.	12/0.3	35/0.26	56/0.24	140/0.29
• AC operation, 50/60 Hz coil	- Closing	VA/p.f.	79/73/0.83/0.78	--	--	--
	- Closed	VA/p.f.	11/9/0.28/0.27	--	--	--
Operating times (for 0.8 ... 1.1 x U _s) Total break time = Opening delay + Arcing time						
• DC operation	- Closing delay	ms	35 ... 190	90 ... 380	120 ... 400	110 ... 400
	- Opening delay ¹⁾	ms	10 ... 25	17 ... 28	22 ... 35	40 ... 110
• AC operation	- Closing delay	ms	10 ... 40	20 ... 50	20 ... 50	20 ... 50
	- Opening delay ¹⁾	ms	5 ... 25	5 ... 30	10 ... 30	10 ... 30
• Arcing time	- DC-1	ms	20			
	- DC-3/DC-5	ms	30			
Main circuit						
Load rating with DC						
Utilization category DC-1, switching resistive loads (L/R ≤ 1 ms)						
• Rated operational currents I _e (at 55 °C)	Up to U _e 750 V	A	32	75	220	400
• Minimum conductor cross-section		mm ²	6	25	95	240
• Rated power at U _e	At 220 V	kW	7	16.5	48	88
	440 V	kW	14	33	97	176
	600 V	kW	19.2	45	132	240
	750 V	kW	24	56	165	300
Utilization category DC-3 and DC-5 Shunt-wound and series-wound motors (L/R ≤ 15 ms)						
• Rated operational currents I _e (at 55 °C)	Up to 220 V	A	32	75	220	400
	440 V	A	29	75	220	400
	600 V	A	21	75	220	400
	750 V	A	7.5	75	170	400
	• Rated power at U _e	At 110 V	kW	2.5	6.5	20
	220 V	kW	5	13	41	70
	440 V	kW	9	27	82	140
	600 V	kW	9	38	110	200
	750 V	kW	4	45	110	250
Switching frequency						
Switching frequency z in operating cycles/hour						
AC/DC operation						
• With resistive load DC-1		h ⁻¹	1500	1000		
• For inductive load DC-3/DC-5		h ⁻¹	750	600		
Conductor cross-sections (1 or 2 conductors connectable)						
Main conductors:						
• Solid	mm ²		2 x (2.5 ... 10)	2 x (6 ... 16)	--	--
• Finely stranded with end sleeve	mm ²		2 x (1.5 ... 4)	--	--	--
• Stranded with cable lug	mm ²		2 x 16	2 x 35	2 x 120	2 x 150
• Pin-end connector acc. to DIN 46231	mm ²		2 x (1 ... 6)	--	--	--
• Busbars	mm		--	15 x 2.5	25 x 4	2 x (25 x 3)
• Terminal screw			M5	M6	M10	M10
Auxiliary conductors:						
• Solid	mm ²		2 x (1 ... 2.5)			
• Finely stranded with end sleeve	mm ²		2 x (0.75 ... 1.5)			

¹⁾ The opening delay times can increase if the contactor coils are damped against voltage peaks. Only 3TC44 contactors are allowed to be fitted with diodes.

3TC contactors

Type		3TC74	3TC78
Design		1-pole contactors	2-pole contactors
Dimensions		78 x 352 x 276	160 x 366 x 290

General technical specifications

Permissible mounting positions	The contactors are designed for operation on a vertical mounting surface.		
---------------------------------------	---	--	--

Mechanical endurance	Operating cycles	30 million	
Electrical endurance	Operating cycles	1)	
Rated insulation voltage U_i (pollution degree 3)	V	1500	
Rated impulse withstand voltage U_{imp}	kV	8	
Protective separation between the coil and the main contacts acc. to IEC 60947-1, Appendix N	V	630	
Permissible ambient temperature	°C	-25 ... +55	
Degree of protection acc. to IEC 60947-1, Appendix C		IP00/open	

Short-circuit protection

Main circuit			
Fuse links, operational class gG: LV HRC, type 3NA			
• Type of coordination "1"	A	630	
• Type of coordination "2"	A	500	
Auxiliary circuits			
• Short-circuit test with fuse links of gG operational class: DIAZED, type 5SB; NEOZED, type 5SE with short-circuit current $I_k = 1$ kA acc. to IEC 60947-5-1	A	16	
• Test with miniature circuit breaker up to 230 V with C characteristic: Short-circuit current $I_k = 400$ A acc. to IEC 60947-5-1	A	10	

Control circuits

Coil operating range				
• DC operation	At $U_c = 24$ V	0.8 ... 1.2 x U_s		
	At $U_c > 24$ V	0.7 ... 1.2 x U_s		
• AC operation	At $U_c = 24$ V	0.7 ... 1.15 x U_s		
	At $U_c > 24$ V	0.7 ... 1.14 x U_s		
Power consumption of the solenoid coils (when coil is cold and 1.0 x U_s)				
• DC operation	Closing = Closed	W	46 92	
• AC operation, 50 Hz	Closing, Closed	VA	80 160	
			0.95 0.95	
Operating times (Total break time = Opening delay + Arcing time)				
• AC and DC operation	- Closing delay	ms	60 ... 100	
	- Opening delay	ms	20 ... 35	
• Arcing time at 0.06 ... 4 x I_e		ms	40 ... 70	

Main circuit

Load rating with DC			
Utilization category DC-1, switching resistive loads ($L/R \leq 1$ ms)			
• Rated operational current $I_n/DC-1$ (at 55 °C)	A	500	500
• Minimum conductor cross-section	mm ²	2 x 150	2 x 150
• Rated power			
	At 220 V	kW	110
	440 V	kW	220
	600 V	kW	300
	750 V	kW	375
	1200 V	kW	—
	1500 V	kW	—
• Critical currents, without arc extinction			
	At 440 V	A	≤ 7
	600 V	A	≤ 13
	750 V	A	≤ 15
	≤ 800 V	A	—
	1200 V	A	≤ 7
	1500 V	A	≤ 13
			≤ 15

Utilization categories DC-3 and DC-5, switching DC motors

Permissible rated current for regenerative braking At 110 ... 600 V	A	400
--	---	-----

Switching frequency

Switching frequency z in operating cycles/hour			
AC/DC operation			
• With resistive load DC-1	h ⁻¹	750	1000
• For inductive load DC-3/DC-5	h ⁻¹	500	500

1) Endurance see page 2/182..

2) See Selection and ordering data.

Accessories – 3RT1 contactors

Technical specifications

Contactor	Type	3RT19 26-2C Solid-state timing relay blocks with semiconductor output	3RT19 26-2D	3RT19 26-2E	3RT19 26-2F	3RT19 26-2G Solid-state time-delay auxiliary switch blocks
General data						
Rated insulation voltage U_i Pollution degree 3 Overvoltage category III acc. to EN 60664-1	V AC	250				
Permissible ambient temperature						
• During operation	°C	-25 ... +60				
• During storage	°C	-40 ... +80				
Degree of protection acc. to EN 60947-1, Appendix C						
• Cover		IP40				
• Terminals		IP20				
Shock resistance Half-sine acc. to IEC 60068-2-27	g/ms	15/11				
Vibration resistance according to IEC 60068-2-6	Hz/mm	10 ... 55/0.35				
EMC tests	Basic specification	IEC 61000-6-4				
Conductor connections						
• Solid	mm ²	2 x (0.5 ... 1.5), 2 x (0.75 ... 4)				
• Finely stranded with end sleeve	mm ²	2 x (0.5 ... 2.5)				
• AWG cables, solid or stranded	AWG	2 x (18 ... 14)				
• Terminal screws		M3				
• Tightening torque	Nm lb.in	0.8 ... 1.2 7 ... 10.3				
Permissible mounting positions		Any				
Control						
Operating range of excitation		0.8 ... 1.1 x U_s , 0.95 ... 1.05 times the rated frequency		0.85 ... 1.1 x U_s , 0.95 ... 1.05 times the rated frequency		
Rated power	W	1		2		
• Power consumption at 230 V AC, 50 Hz	VA	1		4		
Overvoltage protection		Varistor integrated in timing relay		--		
Recovery time	ms	50		150		
Minimum ON period	ms	35		200 (with OFF-delay)		
Setting accuracy With reference to upper limit of scale	Typ. %	±15				
Repeat accuracy	Max. %	±1				
Load side						
Rated operational currents I_e						
• Load current	A	0.3		--		
• AC-15, 230 V, 50 Hz	A	--		3		
• DC-13, 24 V	A	--		1		
• DC-13, 110 V	A	--		0.2		
• DC-13, 230 V	A	--		0.1		
Short-time loading capacity	Up to 10 ms	A	10		--	
DIAZED protection gG operational class	A	--		4		
Residual current	Max. mA	5				
Voltage drop With conducting output	Max. VA	3.5				
Mechanical endurance	Operating cycles	100 x 10 ⁶		10 x 10 ⁶		
Switching frequency for load						
• With I_e at 230 V AC	h ⁻¹	200		2500		
• With 3RT20 16 contactor at 230 V AC	h ⁻¹	2500		5000		

Accessories – 3RT1 contactors

Function	Function chart
Solid-state timing relay blocks	1 NO contact (semiconductor output)
ON-delay, two-wire design (varistor integrated)	3RT19 26-2C
	<p>A2 can be connected to N(L-) using either the contactor or the timing relay. --- To be connected optionally</p> <p>① Timing relay block ② Contactor</p>
OFF-delay with auxiliary voltage (varistor integrated)	3RT19 26-2D
	<p>A2 must only be connected to N(L-) from the timing relay.</p> <p>✗ Do not connect</p> <p>① Timing relay block ② Contactor</p>
Solid-state time-delay auxiliary switch blocks	1 NO + 1 NC
ON-delay	3RT19 26-2E
OFF-delay without auxiliary voltage	3RT19 26-2F
Solid-state time-delay auxiliary switch blocks	2 NO
Wye-delta function: 1 NO delayed, 1 NO instantaneous, dead time 50 ms (varistor integrated)	3RT19 26-2G

Accessories – 3RT1 contactors

Contactor	Type	3RH19 24, 3TX7 090 Coupling links for mounting on contactors acc. to IEC 60947/EN 60947
General data		
Rated insulation voltage U_i (pollution degree 3)	V	300
Protective separation between coil and contacts acc. to IEC 60947-1, Appendix N	V AC	Up to 300
Permissible ambient temperature		
• During operation	°C	-25 ... +60
• During storage	°C	-40 ... +80
Degree of protection acc. to IEC 60947-1, Appendix C		
• Connections		IP20
• Enclosure		IP40
Circuit diagram		
		<p>① Coupling link ② Contactor</p>
Conductor cross-sections		
• Solid	mm ²	2 x (0.5 ... 2.5)
• Finely stranded with end sleeve	mm ²	2 x (0.5 ... 1.5)
Terminal screws		M3
Control side		
Rated control supply voltage U_s	V DC	24
Operating range	V DC	17 ... 30
Power consumption at U_s	W	0.5
Nominal current input	mA	20
Release voltage	V	≥ 4
Function display		Yellow LED
Protection circuit		Varistor
Load side		
Mechanical endurance	Operating cycles	20 x 10 ⁶
Electrical endurance at I_e	Operating cycles	1 x 10 ⁵
Switching frequency	Operating cycles h ⁻¹	5000
Make-time	ms	Approx. 7
Break-time	ms	Approx. 4
Bounce time	ms	Approx. 2
Contact material		AgSnO
Switching voltage	AC/DC V	24 ... 250
Permissible residual current of the electronics (with 0 signal)	mA	2.5

Control Relays

3RH2 control relays – size S00

Technical specifications

Contactor relays	Type	3RH2
	Size	S00

Permissible mounting positions

The contactor relays are designed for operation on a vertical mounting surface.

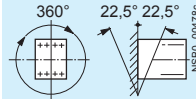

Upright mounting position



Special version required
(3RH21 22-2K, 40 coupling relays and contactor relays with extended operating range on request)

Positively-driven operation of contacts in contactor relays

3RH2:
Yes, in the basic unit and the auxiliary switch block as well as between the basic unit and the front-mounted auxiliary switch block (removable) acc. to:
 • ZH 1/457
 • IEC 60947-5-1, Appendix L

3RH22:
Yes, in the basic unit and the auxiliary switch block as well as between the basic unit and the snap-on auxiliary switch block (permanently mounted) acc. to:
 • ZH 1/457
 • IEC 60947-5-1, Appendix L

Note:
3RH29 11-.NF. solid-state compatible auxiliary switch blocks have no positively-driven contacts.

Explanations:
There is positively-driven operation if it is ensured that the NC and NO contacts cannot be closed at the same time.

ZH1/457
Safety Rules for Controls on Power-Operated Metalworking Presses.

IEC 60947-5-1, Appendix L
Low-Voltage Controlgear, Controls and Contact Blocks. Special requirements for positively-driven contacts

Contact reliability

Contact reliability at 17 V, 1 mA acc. to IEC 60947-5-4

Frequency of contact faults $<10^{-8}$ i.e. <1 fault per 100 million operating cycles

Contact endurance for AC-15/AC-14 and DC-13 utilization categories

The contact endurance is mainly dependent on the breaking current. It is assumed that the operating mechanisms are switched randomly, i.e. not synchronized with the phase angle of the supply system.

If magnetic circuits other than the contactor coil systems or solenoid valves are present, e.g. magnetic brakes, protective measures for the load circuits are necessary, e.g. in the form of RC elements and free-wheel diodes.

The characteristic curves apply to:

- 3RH21/3RH22 contactor relays
- 3RH24 latched contactor relays
- 3RH29 11 auxiliary switch blocks¹⁾
- Auxiliary switch blocks for snapping onto the front, max. 4-pole and for mounting onto the side in size S00

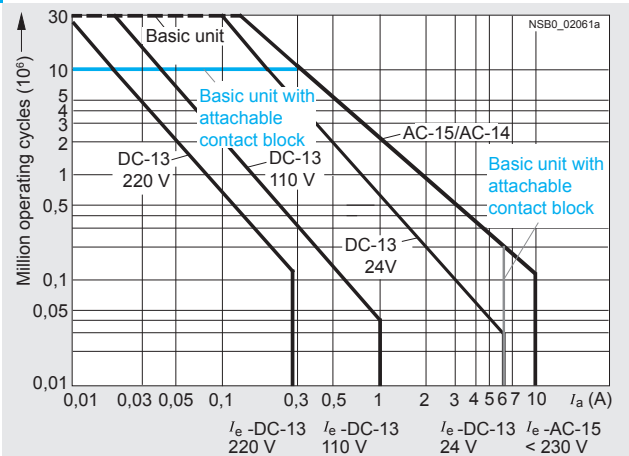

Diagram legend:
 I_a = Breaking current
 I_e = Rated operational current

¹⁾ $I_e = 6$ A for AC-15/AC-14.

Control Relays

3RH2 control relays – size S00

Type		3RH21	3RH22	3RH24
Size		S00	S00	S00
Dimensions (W x H x D) with screw terminals		45 x 57.5 x 73	--	90 x 57.5 x 73
• With mounted auxiliary switch block		45 x 57.5 x 116	45 x 57.5 x 116	--
General technical specifications				
Mechanical endurance				
• Basic units	Operating cycles	30 million		5 million
• Basic unit with snap-on auxiliary switch block	Operating cycles	10 million		
• Solid-state compatible auxiliary switch block	Operating cycles	5 million		
Rated insulation voltage U_i (pollution degree 3)	V	690		
Rated impulse withstand voltage U_{imp}	kV	6		
Protective separation between the coil and the contacts in the basic unit acc. to IEC 60947-1, Appendix N	V	400		
Permissible ambient temperature				
• During operation	°C	-25 ... +60		
• During storage	°C	-55 ... +80		
Degree of protection acc. to IEC 60947-1, Appendix C		IP20, coil assembly IP40		
Touch protection acc. to EN 50274		Finger-safe		
Shock resistance				
• Rectangular pulse	- AC operation - DC operation	<i>g</i> /ms <i>g</i> /ms	7.3/5 and 4.7/10 >10/5 and >5/10	
• Sine pulse	- AC operation - DC operation	<i>g</i> /ms <i>g</i> /ms	11.4/5 and 7.3/10 >15/5 and >8/10	
Short-circuit protection				
• Short-circuit test with fuse links of gG operational class: DIAZED, type 5SB; NEOZED, type 5SE with short-circuit current $I_k = 1$ kA acc. to IEC 60947-5-1	A	10		
• Test with miniature circuit breaker up to 230 V with C characteristic: Short-circuit current $I_k = 400$ A acc. to IEC 60947-5-1	A	6		
Conductor cross-sections				
Auxiliary conductors and coil terminals (1 or 2 conductors can be connected)			Screw terminals	
• Solid	mm ²	2 x (0.5 ... 1.5) ¹⁾ ; 2 x (0.75 ... 2.5) ¹⁾ according to IEC 60947; max. 2 x (0.5 ... 4)		
• Finely stranded with end sleeve	mm ²	2 x (0.5 ... 1.5) ¹⁾ ; 2 x (0.75 ... 2.5) ¹⁾		
• AWG cables, solid or stranded	AWG	2 x (20 ... 16) ¹⁾ ; 2 x (18 ... 14) ¹⁾		
• Terminal screw - Tightening torque	Nm	M3 (for standard screwdriver size 2 or Pozidriv 2) 0.8 ... 1.2 (7 ... 10.3 lb.in)		
Auxiliary conductors and coil terminals (1 or 2 conductors can be connected)			Spring-type terminals	
• Operating devices	mm	3.0 x 0.5; 3.5 x 0.5		
• Solid	mm ²	2 x (0.5 ... 4)		
• Finely stranded with end sleeve	mm ²	2 x (0.5 ... 2.5)		
• Finely stranded without end sleeve	mm ²	2 x (0.5 ... 2.5)		
• AWG cables, solid or stranded	AWG	2 x (20 ... 12)		
Auxiliary conductors for front and laterally mounted auxiliary switches			Ring terminal lug connection	
• Operating devices	mm	3.0 x 0.5; 3.5 x 0.5		
• Solid	mm ²	2 x (0.5 ... 2.5)		
• Finely stranded with end sleeve	mm ²	2 x (0.5 ... 1.5)		
• Finely stranded without end sleeve	mm ²	2 x (0.5 ... 2.5)		
• AWG cables, solid or stranded	AWG	2 x (20 ... 14)		
Auxiliary conductor and coil terminals				
• Terminal screw	mm	M3, Pozidriv size 2		
• Operating devices	Nm	Ø 5 ... 6		
• Tightening torque	mm	0.8 ... 1.2		
• Usable ring terminal lugs - DIN 46234 without insulation sleeve - DIN 46225 without insulation sleeve - DIN 46237 with insulation sleeve - JIS C2805 Type R without insulation sleeve - JIS C2805 Type RAV with insulation sleeve - JIS C2805 Type RAP with insulation sleeve	mm	d ₂ = min. 3.2		
	mm	d ₃ = max. 7.5		

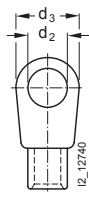

¹⁾ If two different conductor cross-sections are connected to one clamping point, both cross-sections must lie in one of the ranges specified.

Note:

Max. external diameter of the cable insulation: 3.6 mm.

Tool for opening the spring-type terminals
see [Accessories, page 2/79](#).

An insulation stop must be used for conductor cross-sections ≤1 mm², see [Accessories, page 2/79](#).

Control Relays

3RH2 control relays – size S00

Contactor relays	Type	3RH2.	
	Size	S00	
Control circuits			
Coil operating range			
• AC operation	At 50 Hz	0.8 ... 1.1 x U_s	
	At 60 Hz	0.85 ... 1.1 x U_s	
• DC operation	At +50 °C	0.8 ... 1.1 x U_s	
	At +60 °C	0.85 ... 1.1 x U_s	
Power consumption of the solenoid coils (when coil is cold and 1.0 x U_s)			
• AC operation, 50 Hz			
- Closing		VA/p.f.	37/0.8
- Closed		VA/p.f.	5.7/0.25
• AC operation, 60 Hz			
- Closing		VA/p.f.	33/0.75
- Closed		VA/p.f.	4.4/0.25
• DC operation (closing = closed)		W	4.0
Permissible residual current of the electronics (with 0 signal)			
• For AC operation ¹⁾		< 4 mA x (230 V/ U_s)	
• For DC operation		< 10 mA x (24 V/ U_s)	
Operating times²⁾			
Total break time = OFF-delay + Arcing time			
Values apply with coil in cold state and at operating temperature for operating range			
<u>AC operation</u>			
• Closing			
- ON-delay of NO contact	With 0.8 ... 1.1 x U_s	ms	8 ... 33
	With 1.0 x U_s	ms	9 ... 22
	3RH24 minimum operating time	ms	≥ 35
- OFF-delay of NC contact	With 0.8 ... 1.1 x U_s	ms	6 ... 25
	With 1.0 x U_s	ms	6.5 ... 19
• Opening			
- OFF-delay of NO contact	With 0.8 ... 1.1 x U_s	ms	4 ... 15
	With 1.0 x U_s	ms	4.5 ... 15
	3RH24 minimum operating time	ms	≥ 30
- ON-delay of NC contact	With 0.8 ... 1.1 x U_s	ms	5 ... 15
	With 1.0 x U_s	ms	5 ... 15
<u>DC operation</u>			
• Closing			
- ON-delay of NO contact	With 0.8 ... 1.1 x U_s	ms	30 ... 100
	With 1.0 x U_s	ms	35 ... 50
	3RH24 minimum operating time	ms	≥ 100
- OFF-delay of NC contact	With 0.8 ... 1.1 x U_s	ms	25 ... 90
	With 1.0 x U_s	ms	30 ... 45
• Opening			
- OFF-delay of NO contact	With 0.8 ... 1.1 x U_s	ms	7 ... 13
	With 1.0 x U_s	ms	7 ... 12
	3RH24 minimum operating time	ms	≥ 30
- ON-delay of NC contact	With 0.8 ... 1.1 x U_s	ms	13 ... 19
	With 1.0 x U_s	ms	13 ... 18
• Arcing time		ms	10 ... 15

Dependence of the switching frequency z' on the operational current I' and operational voltage U' :
 $z' = z \cdot I_e / I' \cdot (U_e / U')^{1.5} \cdot 1/h$

1) The 3RT29 16-1GA00 additional load module is recommended for higher residual currents (see page 2/74).
 2) The OFF-delay of the NO contact and the ON-delay of the NC contact are increased if the contactor coils are attenuated against voltage peaks (noise suppression diode 6 to 10 times; diode assembly 2 to 6 times, varistor +2 to 5 ms).

Coupling Relays

3RH2 control relays – size S00

Contactor relays	Type	3RH2.	
	Size	S00	
Load side			
AC capacity			
Rated operational currents I_e			
AC-12	A	10	
AC-15/AC-14 for rated operational voltage U_s	Up to 230 V A	6	
	400 V A	3	
	500 V A	2	
	690 V A	1	
Load rating with DC			
Rated operational currents I_e			
DC-12 for rated operational voltage U_s			
• 1 conducting path	24 V A	6	
	60 V A	6	
	110 V A	3	
	220 V A	1	
	440 V A	0.3	
	600 V A	0.15	
• 2 conducting paths in series	24 V A	10	
	60 V A	10	
	110 V A	4	
	220 V A	2	
	440 V A	1.3	
	600 V A	0.65	
• 3 conducting paths in series	24 V A	10	
	60 V A	10	
	110 V A	10	
	220 V A	3.6	
	440 V A	2.5	
	600 V A	1.8	
DC-13 for rated operational voltage U_s			
• 1 conducting path	24 V A	6	
	60 V A	2	
	110 V A	1	
	220 V A	0.3	
	440 V A	0.14	
	600 V A	0.1	
• 2 conducting paths in series	24 V A	10	
	60 V A	3.5	
	110 V A	1.3	
	220 V A	0.9	
	440 V A	0.2	
	600 V A	0.1	
• 3 conducting paths in series	24 V A	10	
	60 V A	4.7	
	110 V A	3	
	220 V A	1.2	
	440 V A	0.5	
	600 V A	0.26	
Switching frequency			
Switching frequency z in operating cycles/hour			
• For rated operation	AC-12/DC-12	h^{-1}	1000
• For utilization category	AC-15/AC-14	h^{-1}	1000
	DC-13	h^{-1}	1000
• No-load switching frequency		h^{-1}	10000
Dependence of the switching frequency z' on the operational current I' and operational voltage U' : $z' = z \cdot I_e/I' \cdot (U_e/U')^{1.5} \cdot 1/h$			
and rated data			
Basic units and auxiliary switch blocks			
• Rated control supply voltage	V AC	max. 600	
• Rated voltage	V AC	600	
• Switching capacity		A 600, Q 600	
• Uninterrupted current at 240 V AC	A	10	

Control Relays

SIRIUS 3RH21 coupling relays for switching auxiliary circuits, 4-pole

Technical specifications

All technical specifications not mentioned in the table below are identical to those of the 3RH21 contactor relays (see page 5/6).

Contactor type	3RH21 ...-HB40	3RH21 ...-JB40	3RH21 ...-KB40
Size	S00	S00	S00
Control circuits			
Coil operating range	0.7 ... 1.85 x U _s		
Power consumption of the solenoid coil (for cold coil) Closing = Closed			
• At U _s = 17 V	W	1.4	
• At U _s = 24 V	W	2.8	
• At U _s = 30 V	W	4.4	
Permissible residual current of the electronics for 0 signal	< 10 mA x (24 V/U _s)		
Overvoltage configuration of the solenoid coil	No overvoltage damping 	With diode 	With suppressor diode
Operating times			
• Closing at 17 V			
- ON-delay NO	ms	40 ... 130	
- OFF-delay NC	ms	30 ... 80	
• At 24 V			
- ON-delay NO	ms	35 ... 60	
- OFF-delay NC	ms	25 ... 40	
• At 30 V			
- ON-delay NO	ms	25 ... 50	
- OFF-delay NC	ms	15 ... 30	
• Opening at 17 ... 30 V			
- OFF-delay NO	ms	7 ... 20	38 ... 65
- ON-delay NC	ms	20 ... 30	55 ... 75
Upright mounting position	Request required		

Contactor type	3RH21 ...-MB40-0KT0	3RH21 ...-VB40	3RH21 ...-WB40
Size	S00	S00	S00
Control circuits			
Coil operating range	0.85 ... 1.85 x U _s		
Power consumption of the solenoid coil (for cold coil) Closing = Closed at U _s = 24 V	W	1.6	
Permissible residual current of the electronics for 0 signal	< 8 mA x (24 V/U _s)		
Overvoltage configuration of the solenoid coil	Diode, varistor or RC element, attachable 	Built-in diode 	Built-in suppressor diode

Control circuits			
Operating times			
• Closing at 20.5 V			
- ON-delay NO	ms	30 ... 120	
- OFF-delay NC	ms	20 ... 110	
• At 24 V			
- ON-delay NO	ms	25 ... 90	
- OFF-delay NC	ms	15 ... 80	
• At 44 V			
- ON-delay NO	ms	15 ... 60	
- OFF-delay NC	ms	10 ... 50	
• Closing at 17 ... 30 V			
- OFF-delay NO	ms	5 ... 20	20 ... 80
- ON-delay NC	ms	10 ... 30	30 ... 90
Upright mounting position	Request required		

3RT Contactors

3RT2 and 3RH2 contactors and relays

Terminal designations and identification numbers for auxiliary contacts

Terminal designations

The terminal designations are 2-digit, e.g. 13, 14, 21, 22:

- Tens digit: Sequence digit
 - Related terminals have the same sequence digit
- Units digit: Function digit
 - 1-2 for normally closed contacts (NC)
 - 3-4 for normally open contacts (NO)

Identification numbers

The identification number indicates the number and type of the auxiliary contacts, e.g. 40, 31, 22, 13:

- 1st digit: number of normally open contacts (NO)
- 2nd digit: number of normally closed contacts (NC)

Examples:

- 31 = 3 NO + 1 NC
- 40 = 4 NO

Selection guide for mountable auxiliary switch blocks for power contactors and contactor relays

The auxiliary switch blocks of the 3RH29 series for mounting on the front and side can be used for power contactors as well as for contactor relays.

Where the columns and lines intersect (blue and green in the example) you will find the identification number for the combination of basic unit (column) and auxiliary switch block (line).

The possible combinations of basic unit and mounted auxiliary switch block can be found in the tables below.

Auxiliary contacts	Version	3-pole contactors			Order No.	
		3RT20 1 S00	3RT20 1 S00	3RT20 2 S0		
NO NC		10 	01 	11 		
		2. 3. 4. 5.	5. 6. 7. 8.	3. 4. 5. 6.	According to EN 50012 ¹⁾	
Auxiliary switches without NO contact						
--	1		11	02	12	3RH29 11-.HA01
--	2		12	03	13	3RH29 11-.HA02
--	3		13	04	14	3RH29 11-.HA03
--	4		14	--	--	3RH29 11-.FA04
Auxiliary switch with 1 NO contact						
1	--		20	11	21	3RH29 11-.HA10
1	1		21	12	22	3RH29 11-.HA11

1) Combinations according to EN 50012, EN 50011 and IEC 60947-5-1 are in bold print. All combinations comply with EN 50005.

Type	Example 1	Example 2
Type	3RT20 motor contactor, S00 with 1 NO	3RT20 motor contactor, S0 with 1 NO + 1 NC
Sequence digit	2. 3. 4. 5.	3. 4. 5. 6.
Type	Auxiliary switch with 4 NC, 3RH29 11-.FA04	Auxiliary switch with 3 NC, 3RH29 11-.HA03
Function digit	.1 .1 .1 .1 .2 .2 .2 .2	.1 .1 .1 .2 .2 .2
Type	3RT20 motor contactor, S00 with auxiliary switch block	3RT20 motor contactor, S0 with auxiliary switch block
Terminal design.	13 21 31 41 51 14 22 32 42 52	13 21 31 41 51 14 22 32 42 52
Type	Ident. No. 14	Ident. No. 14

3RT Contactors

3RT2 and 3RH2 contactors and relays

CONTACTORS AND ASSEMBLIES

Additional auxiliary switch blocks

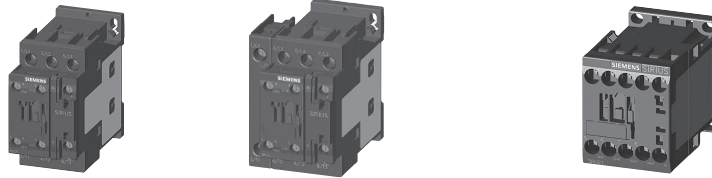

Auxiliary contacts Version NO NC	3-pole contactors			4-pole contactors				Contactor relays			Order No.	
	S00 3RT20 1 10	S0 3RT20 1 01	S0 3RT20 2 11	S00 3RT23 1 --	S0/S2 3RT25 1 --	S0/S2 3RT23 11	S0/S2 3RT25 11	S00 3RH21, 3RH24 40E	S0/S2 3RH21, 3RH24 31E	S0/S2 3RH21, 3RH24 22E		
	2. 3. 4. 5.	5. 6. 7. 8.	3. 4. 5. 6.	1. 2. 3. 4.	1. 2. 3. 4.	3. 4. 5. 6.	3. 4. 5. 6.	5. 6. 7. 8	5. 6. 7. 8	5. 6. 7. 8		
Front auxiliary switches	According to EN 50012 ¹⁾			According to EN 50012 ¹⁾				According to EN 50011 ¹⁾				
Without NO contact												
-- 1		11	02	12	01	01	12	12	41X	32X	23X	3RH29 11-.HA01
-- 2		12	03	13	02	02	13	--	42E	33X	24	3RH29 11-.HA02
-- 3		13	04	14	03	--	--	--	43	34	--	3RH29 11-.HA03
-- 4		14	--	--	--	--	--	--	44E	--	--	3RH29 11-.FA04
With 1 NO contact												
1 --		20	11	21	10	10	21	21	50E	41E	32E	3RH29 11-.HA10
1 1		21	12	22	11	11	22	22	51X	42X	33X	3RH29 11-.HA11
1 2		22	13	23	12	12	23	--	52	43	34	3RH29 11-.HA12
1 3		23	14	24	13	--	--	--	53X	44X	--	3RH29 11-.HA13
With 2 NO contacts												
2 --		30	21	31	20	20	31	31	60E	51X	42X	3RH29 11-.HA20
2 1		31	22	32	21	21	32	32	61	52	43	3RH29 11-.HA21
2 2		32	23	33	22	22	33	--	62X	53	44X	3RH29 11-.HA22
2 2		32	23	33	22	22	33	--	62X	53	44X	3RH29 11-.FA22

¹⁾ Combinations according to EN 50012, EN 50011 and IEC 60947-5-1 are in bold print. All combinations comply with EN 50005.

3RT Contactors

3RT2 and 3RH2 contactors and relays

Additional auxiliary switch blocks

Auxiliary contacts Version NO NC	3-pole contactors			4-pole contactors				Contactor relays			Order No.	
	S00 3RT20 1 10	3RT20 1 01	S0 3RT20 2 11	S00 3RT23 1 --	3RT25 1 --	S0/S2 3RT23 11	3RT25 11	3RH21, 3RH24 40E	31E	22E		
	2. 3. 4. 5.	5. 6. 7. 8.	3. 4. 5. 6.	1. 2. 3. 4.	1. 2. 3. 4.	3. 4. 5. 6.	3. 4. 5. 6.	5. 6. 7. 8.	5. 6. 7. 8.	5. 6. 7. 8.		
	According to EN 50012 ¹⁾			According to EN 50012 ¹⁾				According to EN 50011 ¹⁾				
Front auxiliary switches with 3 NO contacts												
3 --		40	31	41	30	30	41	41	70	61	52	3RH29 11-.HA30
3 1		41	32	42	31	31	42	42	71X	62X	53X	3RH29 11-.HA31
Front auxiliary switches with 4 NO contacts												
4 --		50	41	51	40	40	51	51	80E	71X	62X	3RH29 11-.FA40
	Acc. to EN 50005			Acc. to EN 50005				Acc. to EN 50005				
Front auxiliary switches with make-before-break												
-- 1		21	12	22	11	11	22	22	51	42	33	3RH29 11-.FB11
-- 2		32	23	33	22	22	33	--	62	53	44	3RH29 11-.FB22
-- 3		32	23	33	22	22	33	--	62	53	44	3RH29 11-.FC22
Front auxiliary switches with complete inscription²⁾												
1 --		20	11	21	10	10	21	21	50	41	32	3RH29 11-1AA10
1 --		20	11	21	10	10	21	21	50	41	32	3RH29 11-1BA10
-- 1		11	02	12	01	01	12	12	41	32	23	3RH29 11-1AA01
-- 1		11	02	12	01	01	12	12	41	32	23	3RH29 11-1BA01
1 1		21	12	22	11	11	22	22	51	42	33	3RH29 11-1LA11
1 1		21	12	22	11	11	22	22	51	42	33	3RH29 11-1MA11
2 --		30	21	31	20	20	31	31	60	51	42	3RH29 11-1LA20
2 --		30	21	31	20	20	31	31	60	51	42	3RH29 11-1MA20

¹⁾ Combinations according to EN 50012, EN 50011 and IEC 60947-5-1 are in bold print. All combinations comply with EN 50005. ²⁾ Terminals from the top or bottom.

3RT Contactors

3RT2 and 3RH2 contactors and relays

Additional auxiliary switch blocks

Auxiliary contacts Version NO NC	3-pole contactors			4-pole contactors				Contactor relays			Order No.
	S00 3RT20 1 10	S0 3RT20 1 01	S0 3RT20 2 11	S00 3RT23 1 --	S0 3RT25 1 --	S0/S2 3RT23 11	S0/S2 3RT25 11	S00 3RH21, 3RH24 40E	S00 3RH21, 3RH24 31E	S00 3RH21, 3RH24 22E	
	2. 3. 4. 5. Acc. to EN 50005	5. 6. 7. 8.	3. 4. 5. 6.	1. 2. 3. 4. Acc. to EN 50005	1. 2. 3. 4.	3. 4. 5. 6.	3. 4. 5. 6.	5. 6. 7. 8	5. 6. 7. 8	5. 6. 7. 8	
Front auxiliary switches with complete inscription (for contactor relays)											
4 --		--	--	--	--	--	--	80E	--	--	3RH29 11-.GA40
3 1		--	--	--	--	--	--	71E	--	--	3RH29 11-.GA31
2 2		--	--	--	--	--	--	62E	--	--	3RH29 11-.GA22
1 3		--	--	--	--	--	--	53E	--	--	3RH29 11-.GA13
-- 4		--	--	--	--	--	--	44E	--	--	3RH29 11-.GA04
Front auxiliary switches with complete inscription, special version											
4 --		50	41	51	40	40	51 51	80E	71X	62X	3RH29 11-.XA40-0MA0
3 1		41	32	42	31	31	42 42	71E	62X	53	3RH29 11-.XA31-0MA0
2 2		32	23	33	22	22	33 --	62E	53	44X	3RH29 11-.XA22-0MA0
-- 4		14	--	--	--	--	-- --	44E	--	--	3RH29 11-.XA04-0MA0
Front auxiliary switches, Solid-state compatible											
-- 2		12	03	13	02	02	13 --	42	33	24	3RH29 11-.NF02
1 1		21	12	22	11	11	22 22	51	42	33	3RH29 11-.NF11
2 --		30	21	31	20	20	31 31	60	51	42	3RH29 11-.NF20

¹⁾ Combinations according to EN 50012, EN 50011 and IEC 60947-5-1 are in bold print. All combinations comply with EN 50005.

3RT Contactors

3RT2 and 3RH2 contactors and relays

Additional auxiliary switch blocks

Auxiliary contacts		3-pole contactors S00			4-pole contactors S00				Contactor relays S00			Order No.
Version		3RT20 1	3RT20 1	S0	3RT23 1	3RT25 1	S0/S2	S0/S2	3RH21, 3RH24	31E	22E	
NO	NC	10	01	11	--	--	11	11	40E	31E	22E	
		13	21	13 21			13 21	13 21	13 23 33 43	13 21 33 43	13 21 31 43	
		14	22	14 22			14 22	14 22	14 24 34 44	14 22 34 44	14 22 32 44	
		2. 3. 4. 5.	5. 6. 7. 8.	3. 4. 5. 6.	1. 2. 3. 4.	1. 2. 3. 4.	3. 4. 5. 6.	3. 4. 5. 6.	5. 6. 7. 8.	5. 6. 7. 8.	5. 6. 7. 8.	
		According to EN 50012 ¹⁾			According to EN 50012 ¹⁾				According to EN 50011 ¹⁾			
		Left	Right									
Lateral auxiliary switches for size S00												
--	2			12	--	--	02	02	--	--	--	3RH29 11-.DA02
--	2			14	--	--	--	--	--	--	--	3RH29 11-.DA02
1	1			21	--	--	11	11	--	--	--	3RH29 11-.DA11
1	1			32	--	--	22	22	--	--	--	3RH29 11-.DA11
2	--			30	--	--	20	20	--	--	--	3RH29 11-.DA20
2	--			50	--	--	40	40	--	--	--	3RH29 11-.DA20
2	--			41	--	--	31	31	--	--	--	3RH29 11-.DA20 + 3RH29 11-.DA11
1	1			44	--	--	22	22	--	--	--	3RH29 11-.DA20 + 3RH29 11-.DA02
2	--			32	--	--	22	22	--	--	--	3RH29 11-.DA20 + 3RH29 11-.DA02
1	1			23	--	--	13	--	--	--	--	3RH29 11-.DA11 + 3RH29 11-.DA02
--	2											
Lateral auxiliary switches for size S00 to S3												
--	2			12	03	13	02	02	13	--	--	3RH29 21-.DA02
--	2			14	--	--	--	--	--	--	--	3RH29 21-.DA02
1	1			21	12	22	11	11	22	22	--	3RH29 21-.DA11
1	1			32	23	33	22	22	33	--	--	3RH29 21-.DA11
2	--			30	21	31	20	20	31	31	--	3RH29 21-.DA20
2	--			50	41	51	40	40	51	51	--	3RH29 21-.DA20

¹⁾ Combinations according to EN 50012, EN 50011 and IEC 60947-5-1 are in bold print. All combinations comply with EN 50005.

3RT Contactors

3RT2 and 3RH2 contactors and relays

Additional auxiliary switch blocks

Auxiliary contacts Version NO NC		3-pole contactors			4-pole contactors				Contactor relays			Order No.	
		S00 3RT20 1 10	3RT20 1 01	S0 3RT20 2 11	S00 3RT23 1 --	3RT25 1 --	S0/S2 3RT23 11	3RT25 11	S00 3RH21, 3RH24 40E	31E	22E		
Left Right		2. 3. 4. 5. 5. 6. 7. 8. 3. 4. 5. 6. According to EN 50012 ¹⁾			1. 2. 3. 4. 1. 2. 3. 4. 3. 4. 5. 6. 3. 4. 5. 6. According to EN 50012 ¹⁾				5. 6. 7. 8. 5. 6. 7. 8. 5. 6. 7. 8. According to EN 50011 ¹⁾				
Lateral auxiliary switches for size S00 to S3													
2	--		41	32	42	31	31	42	42	--	--	--	3RH29 21-DA20 + 3RH29 21-DA11
1	1		53	63	31	43	54	64	32	44			
2	--		53	63	31	41	54	64	32	42			
--	2		53	63	31	41	54	64	32	42			
1	1		51	63	31	41	52	64	32	42			3RH29 21-DA11 + 3RH29 21-DA02
--	2		51	63	31	41	52	64	32	42			
Lateral auxiliary switches for contactor relays													
--	2		--	--	--	--	--	--	--	42Z	33X	24	3RH29 21-DA02
1	1		--	--	--	--	--	--	--	51X	42X	33X	3RH29 21-DA11
2	--		--	--	--	--	--	--	--	60Z	51X	42X	3RH29 21-DA20
Lateral auxiliary switches, Solid-state compatible for size S00													
1	1		21	--	--	11	11	--	--	--	--	--	3RH29 11-2DE11
1	1		41	53	23	31	42	54	24	32			3RH29 11-2DE11
Lateral auxiliary switches, Solid-state compatible for size S00 to S3													
1	1		21	12	22	11	11	22	22	--	--	--	3RH29 21-2DE11
1	1		51	63	33	41	52	64	34	42			3RH29 21-2DE11
Lateral auxiliary switches, Solid-state compatible for contactor relays													
1	1		--	--	--	--	--	--	--	51X	42X	33X	3RH29 21-DE11

¹⁾ Combinations according to EN 50012, EN 50011 and IEC 60947-5-1 are in bold print. All combinations comply with EN 50005.

Internal circuit diagrams (applicable to screw, spring and ring lug connection)

Sizes S6 to S12
Terminal designations according to EN 50 012
3RT10 5 to 3RT10 7, 3RT12, 3RT14 contactors

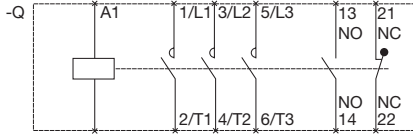

3RT1. 5, 3RT1. 6, 3RT1. 7 contactors (sizes S6, S10, S12)
 With 3RH19 21-1DA11 2-pole auxiliary switch blocks, laterally mountable
2 NO + 2 NC

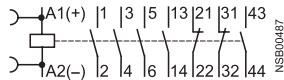

3RH19 21-.../XA...4-pole auxiliary switch blocks, for snapping onto the front 2)
2 NO + 2 NC
 22

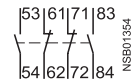

3RH19 21-...DA11, 3RH19 21-2DE11 first laterally mountable auxiliary switch block (solid-state compatible)

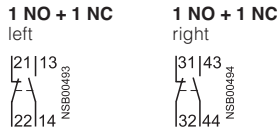

3RH19 21-...JA11, 3RH19 21-2JE11 second laterally mountable auxiliary switch block (solid-state compatible)
 (only for sizes S3 to S12)

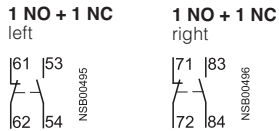

Contactors with 4 main contacts, sizes S3
Terminal designations acc. to EN 50 005
3RT13/23 and 3RT15/25 contactors



(3RH19 21 auxiliary switch blocks acc. to EN 50 005 can be snapped on)

3RT26 capacitor contactors

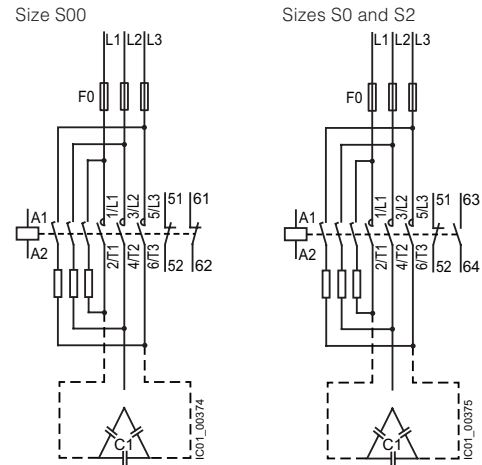

Surge suppressor (plug-in direction coded; exception: marked +/- for 3RT19 16-1T... diode assembly) **for sizes S2 to S3**

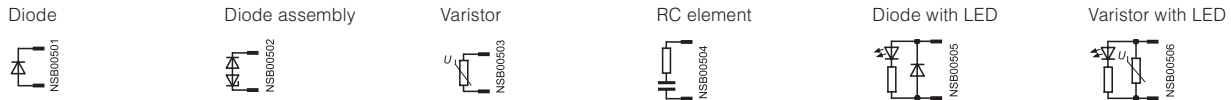

1) 3RH29 auxiliaries are intended to be used only with 3RT2 or 3RH2 base devices.
 3RH19 auxiliaries are intended to be used only with 3RT1 or 3RH1 base devices.
 2) Not for 3RT12. vacuum contactors

3RT1 Contactors

3RT1 contactors and accessories

Internal circuit diagrams (applicable to screw connection and Spring-type terminal connection)

*Accessories for size S6¹⁾ to S12 contactors
Terminal designations acc. to EN 50 005*

3RH19 21- . CA.. auxiliary switch blocks, single-pole,
for snapping onto the front ²⁾

1 NO



1 NC



3RH19 21-1CD.. auxiliary switch blocks, single-pole,
with make-before-break contacts, for snapping onto the front ¹⁾

1 NO



1 NC



(terminal designations according to EN 50 005 or EN 50 012)

*Accessories for size S0 to S12 contactors
Terminal designations acc. to EN 50 005*

3RH19 21- . EA.. first laterally mountable auxiliary switch blocks (left)

2 NO



1 NO + 1 NC



2 NC



3RH19 21- . EA.. first laterally mountable auxiliary switch blocks (right)

2 NO



1 NO + 1 NC



2 NC



3RH19 21- . KA.. second laterally mountable auxiliary switch blocks (left)
(only for sizes S3 to S12)

2 NO



1 NO + 1 NC



2 NC



3RH19 21- . KA.. second laterally mountable auxiliary switch blocks (right)
(only for sizes S3 to S12)

2 NO



1 NO + 1 NC



2 NC



1) RH29 auxiliaries are intended to be used only with 3RT2 or 3RH2 base devices.
3RH19 auxiliaries are intended to be used only with 3RT1 or 3RH1 base devices.
2) Not for 3RT12. vacuum contactors

3RT Contactors and 3RH2 Control Relays

Accessories for size S00 to S3

Circuit diagrams

Accessories for size S3 contactors and control relays

Solid-state time-delay blocks
(see configuring aid on page 2/38)

3RT19 16-2C...
ON-delay
Size S00

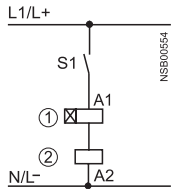

3RT19 16-2D...
OFF-delay (with auxiliary voltage)
Size S00

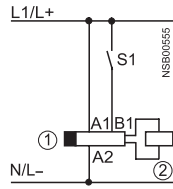

Sizes S2 to S12
3RT19 16-2E.../2F.../2G... solid-state, time-delay auxiliary switch blocks

1 NO + 1 NC
ON-delay

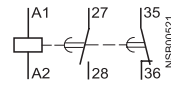

1 NO + 1 NC
OFF-delay

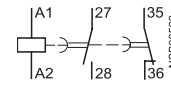

2 NO
WYE-delta function

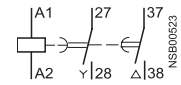

(Integrated varistors not shown)

3RT19 26-2C...
ON-delay
Sizes S0 to S3

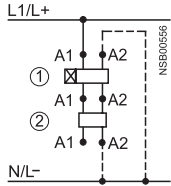

3RT19 26-2D...
OFF-delay (with auxiliary voltage)
Sizes S0 to S3

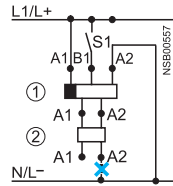

A2 can only be connected to N(L-) via the time-delay relay.
x don't connect

- ① Time-delay block
- ② Contactor

A2 can be connected to N(L-) via either the contactor or the time-delay relay.
- - - optional connection

Designation	Circuit diagram
3RA2811-.CW10 ON-delay	
3RA2812-.DW10 OFF-delay with auxiliary voltage	
3RA2813-.AW10 ON-delay, 1 CO contact	
3RA2813-.FW10 ON-delay, 1 NC contact/ 1 NO contact	

Designation	Circuit diagram
3RA2814-.AW10 OFF-delay, 1 CO contact	
3RA2814-.FW10 OFF-delay with auxiliary voltage, 1 NC contact/ 1 CO contact	
3RA2815-.AW10 OFF-delay without auxiliary voltage, 1 CO contact	
3RA2815-.FW10 OFF-delay without auxiliary voltage, 1 NC contact/ 1 NO contact	

3RT29 accessories are intended to be used only with 3RT2 or 3RH2 base devices.
3RT19 auxiliaries are intended to be used only with 3RT1 or 3RH1 base devices.

3RA Contactor Assemblies

3RA23 contactor assemblies for reversing

Circuit diagrams

Size S00 to S0 Main circuit

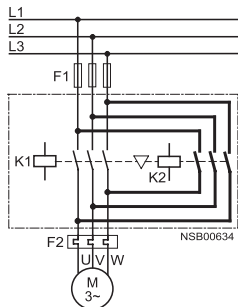

The 3RA2913-2AA. (S00) and 3RA2913-2AA (S0) installation kit contains wiring connectors for connecting the main conducting paths, the mechanical interlock and two connecting clips for the contactors.

Control circuit (sizes S00 and S0)

(terminal designations of contactors according to EN 50 012)

for momentary-contact operation

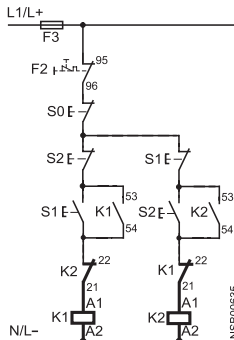

for maintained-contact operation

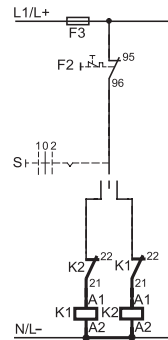

Sizes S2 to S3 Main circuit

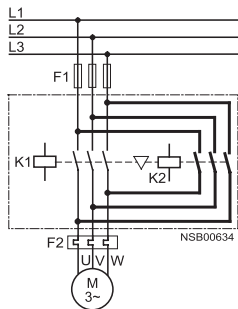

The 3RA19 13-2A installation kits contain, among other things, the wiring connectors on the top and bottom for connecting the main conducting paths.

Control circuit

(terminal designations of contactors according to EN 50 005)

for momentary-contact operation

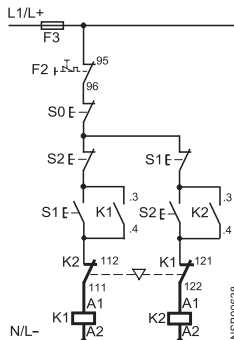

for maintained-contact operation

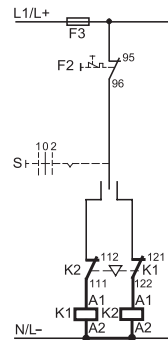

The 3RA19 24-2B mechanical interlock contains one NC contact for the NC contact interlock for each contactor

Position of terminals

Sizes S2 to S3

Terminal designations according to EN 50 005

3RA19 24-2B mechanical interlock (laterally mountable), integrated in reversing contactor assemblies (reversing starters), contains one NC contact for the electrical interlock for each contactor

2 NC

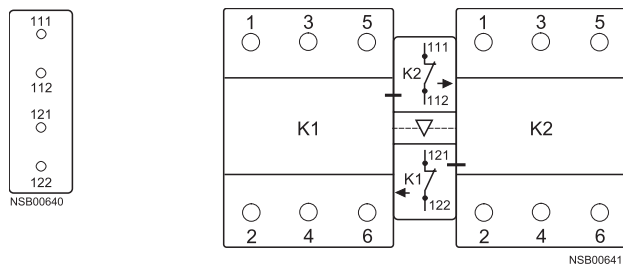

- S0 "OFF" button
- S1 "Clockwise ON" button
- S2 "Counterclockwise ON" button
- S "CW-OFF-CCW" button

- K1 Clockwise contactor
- K2 Counterclockwise contactor

- F1 Fuses for main circuit
- F3 Fuses for control circuit
- F2 Overload relay

3RA Contactor Assemblies

Circuit Diagrams for WYE-delta switching

Circuit diagrams

Size S00 / S0 Main circuit

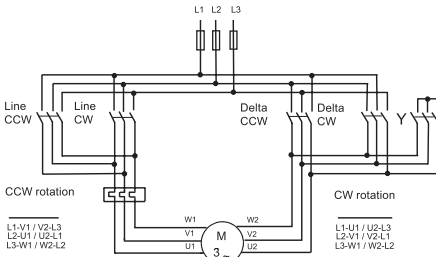

Control circuits with 3RA2816-0EW20 function module (set of three) snapped onto the front

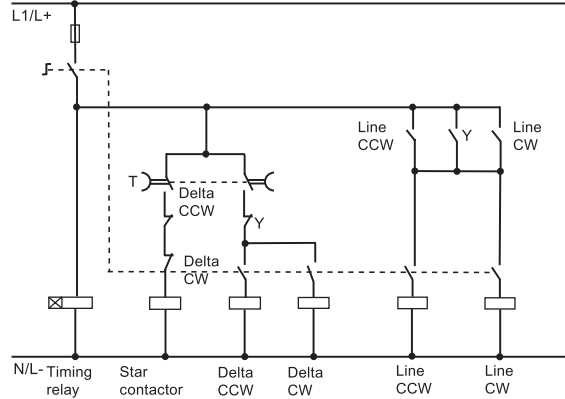

Sizes S2 to S3 Main circuit

Sizes S2 and S3

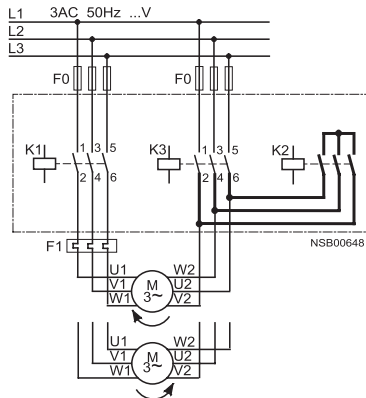

3RA2816-0EW20

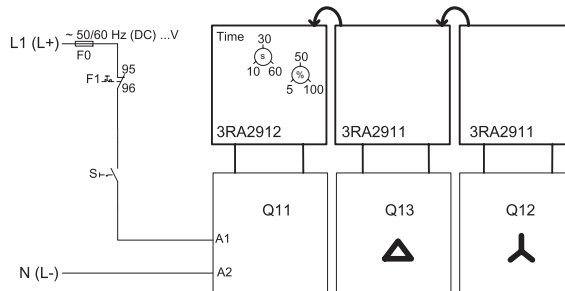

Control circuits with 3RP15 7. time-delay relay, laterally mounted (typical circuits) for momentary-contact operation

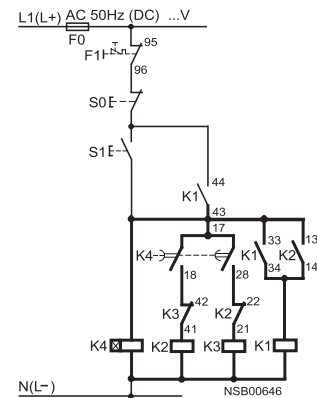

for maintained-contact operation

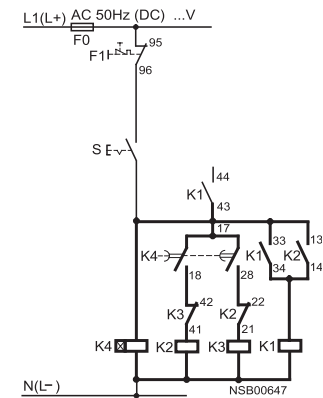

Contact element 17/18 is only closed on the star step; the contact element is open on the delta step and when de-energized.

- S0 "OFF" button
- S1 "ON" button
- S Maintained-contact switch
- K1 Line contactor
- K2 Star contactor
- K3 Delta contactor
- K4 Solid-state, time-delay auxiliary switch block or time-delay relay
- F0 Fuses
- F1 Overload relay

3T Contactors

3TF68 and 3TF69 vacuum contactors

Internal circuit diagrams

3TF68 44 and 3TF69 44 contactors

4 NO + 4 NC
AC operation
max. complement of auxiliary switches

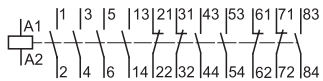

3TF68 33 and 3TF69 33 contactors

3 NO + 3 NC
DC operation
max. complement of auxiliary switches

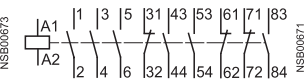

Auxiliary switch blocks 3TY7 681-1G

for coil reconnection, 3TF68 and 3TF69, DC economy circuit



Auxiliary switch blocks 3TY7 561-1AA00

first auxiliary switch block left or right mounted on left mounted on right



Auxiliary switch blocks 3TY7 561-1KA00

second auxiliary switch block left or right mounted on left mounted on right



Auxiliary switch blocks 3TY7 561-1EA00

with make-before-break contacts mounted on left mounted on right



Auxiliary switch blocks 3TY7 561-1.

solid-state compatible aux. switch block mounted on left mounted on right



Interface for control by PLC 3TX7 090-0D

with surge suppression

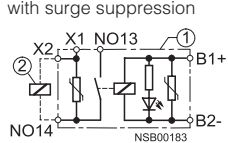

Circuit diagrams for DC economy circuit - maintained-contact operation

3TF68 33 and 3TF69 33 contactors

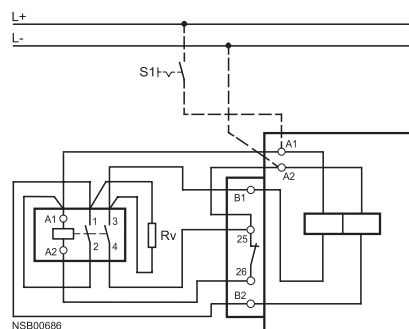

Terminal designations according to EN 50 012.

Coupling Relays

3RH21 coupling for switching auxillary circuits

Terminal diagrams

DC operation

L+ is to be connected to coil terminal A1.

3RH21 coupling relays for auxiliary circuits, size S00

Terminal designations according to EN 50 011

(it is not possible to snap on an auxiliary switch block)

Surge suppressor can be mounted

4 NO

Ident no.: 40E

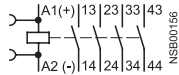

3 NO + 1 NC

31E

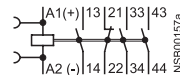

2 NO + 2 NC

22E

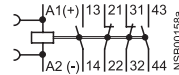

Suppressor Diode integrate

4 NO

Ident no.:40E

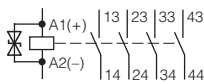

3 NO + 1 NC

31E

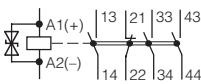

2 NO + 2 NC

22E

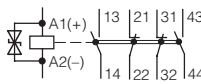

Diode integrated

4 NO

Ident no.:40E

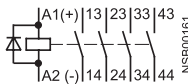

3 NO + 1 NC

31E

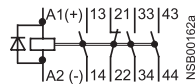

2 NO + 2 NC

22E

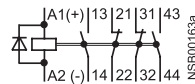

Position of terminals

Size S00

3RH21 coupling relays

4 NO

Ident no.: 40E

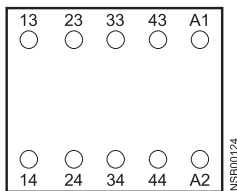

3 NO + 1 NC

31E

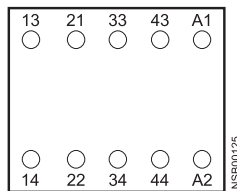

2 NO + 2 NC

22E

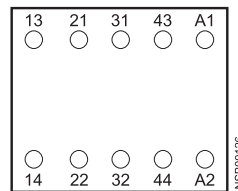

3RH19 21- . DA11 first laterally mountable auxiliary switch block¹⁾

mountable on left or right

1 NO + 1 NC

left

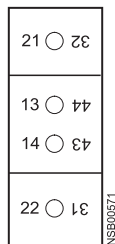

right

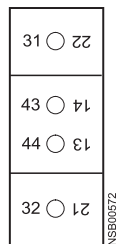

3RH19 21- . JA11 second laterally mountable auxiliary switch block¹⁾

mountable on left or right (only for sizes S3 to S12)

1 NO + 1 NC

left

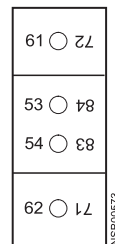

right

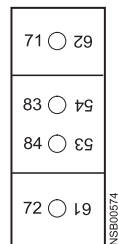

1) Note the location digit.
Can only be used if no 4-pole auxiliary switch block is snapped onto the front.

3RH2 Control & Latching Relays

3RH2 Terminal Designations

Terminal designations according to EN 50 011

3RH21 control relays

4 NO

Ident no.: 40E

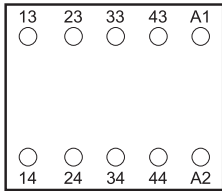

3 NO + 1 NC

31E

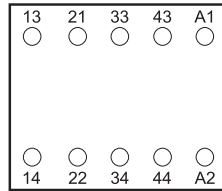

2 NO + 2 NC

22E

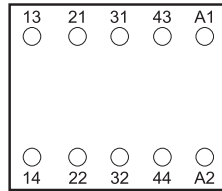

3RH21 40 control relays

with 3RH19 11-1GA... auxiliary switch blocks snapped onto the front

8 NO

Ident no.: 80E

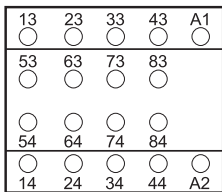

7 NO + 1 NC

71E

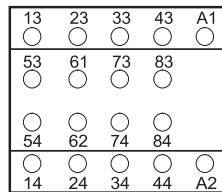

6 NO + 2 NC

62E

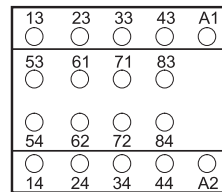

5 NO + 3 NC

53E

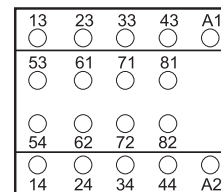

4 NO + 4 NC

Ident no.: 44E

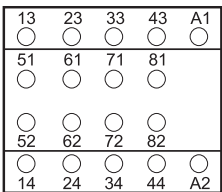

3RH24 latched control relays

4 NO

Ident no.: 40E

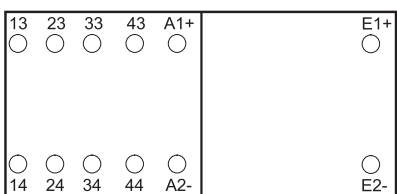

3 NO + 1 NC

31E

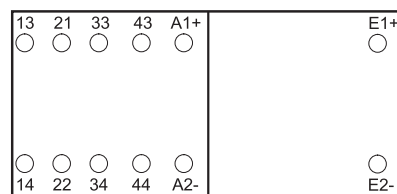

2 NO + 2 NC

Ident no.: 22E

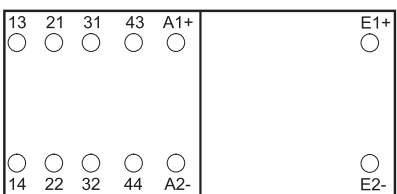

3RT Contactors and 3RH Control Relays

3RT2 contactors and accessories

Position of terminals (applicable to screw connection and Cage Clamp connection)

Size S0 0

Terminal designations according to EN 50 012

3RT20 1 contactors, 3RT20 1 coupling relays,

1 NO

Ident. no. 10E

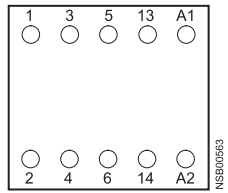

NSB00563

1 NC

01

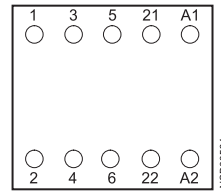

NSB00564

Sizes S3 to S12

Terminal designations according to EN 50 012

3RT 20 3, 3RT20 4, 3RT124 46 contactors,

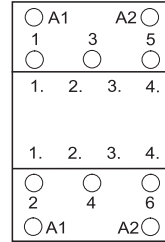

NSB00565

3RT20 1 contactors (with 1 NO)

with auxiliary switch blocks snapped onto the front
3RH19 11-. H...

1 NO + 1 NC

Ident. no.: 11

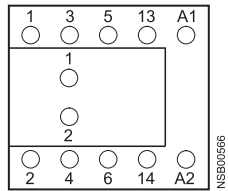

NSB00566

2 NO + 2 NC

22

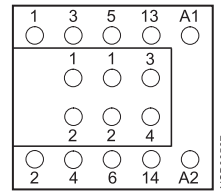

NSB00567

2 NO + 3 NC

Ident. no.: 23

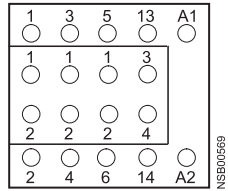

NSB00569

3 NO + 2 NC

32

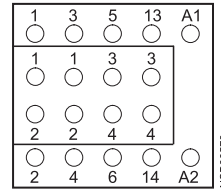

NSB00570

Size S0

Terminal designations according to EN 50 012

3RT20 2 Contactors with 1NO + 1NC
3RT20 2 Coupling Relays

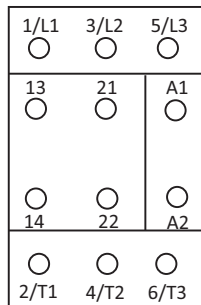

3RT20 2 Contactors with 3NO + 3NC

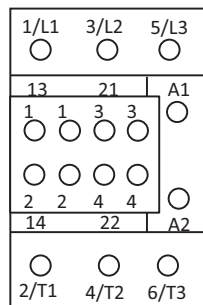

Size S2

Terminal designations according to EN 50 012

3RT20 3 Contactors with 1NO + 1NC
3RT20 3 Coupling Relays

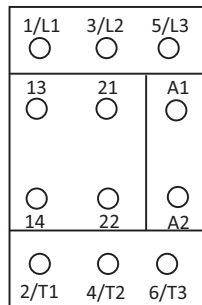

3RT20 3 Contactors with 3NO + 3NC

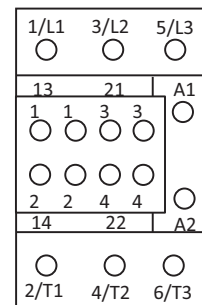

3RT Contactors

3RT1/2 contactors and accessories

Position of terminals (applicable to screw connection and Spring-type connection)

Accessories for size S3 to S12 contactors

Terminal designations according to EN 50 005 or EN 50 012

3RH19 21- . CA.. auxiliary switch blocks, single-pole,
for snapping onto the front

1 NO

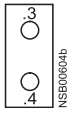

1 NC

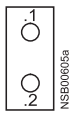

1 NO



with extended
contact-making

1 NC



with extended
contact-making

3RT Contactors

3RT1/2

Position of terminals

Accessories for size S2 to S12 contactors
Terminal designations acc. to EN 50 005

3RH19 21- . EA.. first laterally mountable auxiliary switch blocks (left)

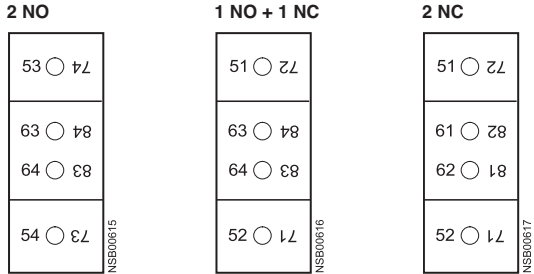

3RH19 21- . EA.. first laterally mountable auxiliary switch blocks (right)

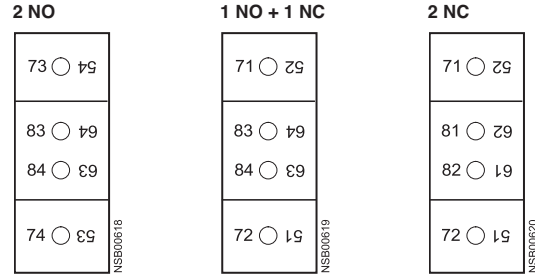

3RH19 21- . KA.. second laterally mountable auxiliary switch blocks (left)
(only for sizes S3 to S12; can only be used if no auxiliary switches are snapped onto the front)

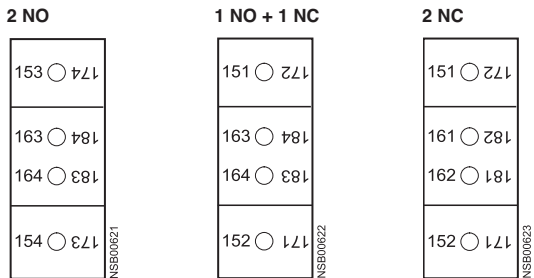

3RH19 21- . KA.. second laterally mountable auxiliary switch blocks (right)
(only for sizes S3 to S12; can only be used if no auxiliary switches are snapped onto the front)

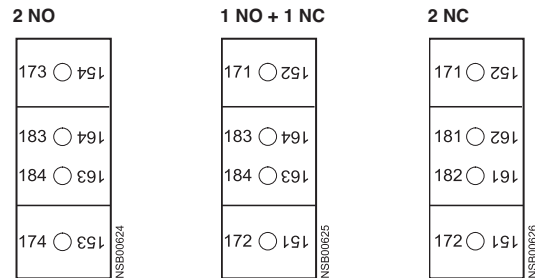

Accessories for size S3 to S12 contactors
Terminal designations acc. to DIN 46 199 Part 5

3RT19 26-2E.../2F.../2G... solid-state, time-delay auxiliary switch blocks

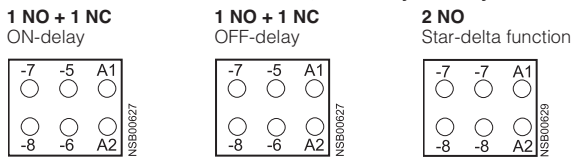

3RT26 capacitor contactors

Size S00
with 4-pole auxiliary switch block mounted on the front

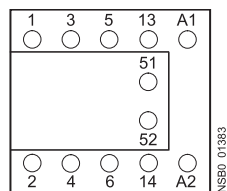

The auxiliary switch block comprises 3 leading contacts (not shown) and one unassigned NO contact.

Sizes S2 and S3
with 4-pole auxiliary switch block mounted on the front

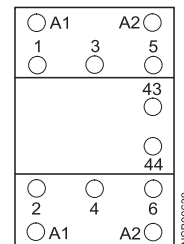

The auxiliary switch block comprises 3 leading contacts (not shown) and one unassigned NO contact.

3RT1 Contactors

3RT1 contactors and accessories

Position of terminals (applicable to screw connection and Spring-type terminal connection)

Sizes S6 to S12

3RT1.5, 3RT1.6, 3RT1.7 contactors

- with conventional op. mechanism (3RT1...-A...)

with laterally mountable auxiliary switch blocks 3RH19 21-1DA11 (for 2 NO + 2 NC, incl. in contactor) 3RH19 21-1JA11 (expandable to 4 NO + 4 NC)

2 NO + 2 NC or 4 NO + 4 NC

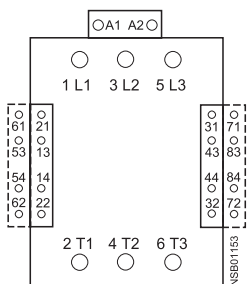

- with solid-state op. mechanism (3RT1...-N...)

with laterally mountable auxiliary switch blocks 3RH19 21-1DA11 (for 2 NO + 2 NC, incl. in contactor) 3RH19 21-1JA11 (expandable to 4 NO + 4 NC)

2 NO + 2 NC or 4 NO + 4 NC

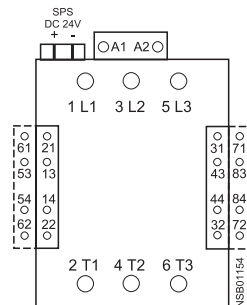

- with solid-state op. mechanism (3RT1...-P...)

with laterally mountable auxiliary switch blocks 3RH19 21-1DA11 (for 1 NO + 1 NC, incl. in contactor) 3RH19 21-1JA11 (expandable to 2 NO + 2 NC)

1 NO + 1 NC or 2 NO + 2 NC

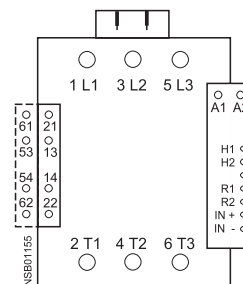

3RT23 and 3RT25 contactors

4 NO

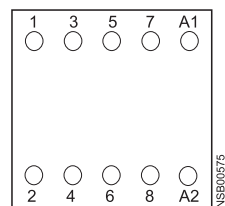

2 NO + 2 NC

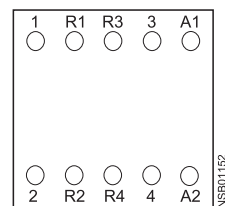

3RT13 and 3RT15 contactors

4 NO

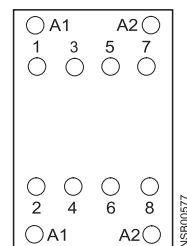

Size S0 with integrated 1NO + 1NC aux (13/14 + 21/22) and only one set of A1+A2 on front

2 NO + 2 NC

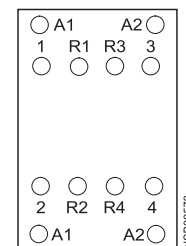

3T Contactors

3TF68 and 3TF69 vacuum contactors, 3-pole

Position of terminals

AC operation

3TF68 and 3TF69 contactors
4 NO + 4 NC

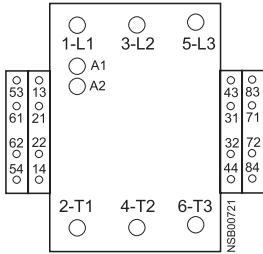

DC operation

3TF68 and 3TF69 contactors
3 NO + 3 NC
max. complement of auxiliary switches

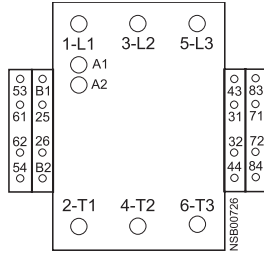

Solid-state compatible auxiliary switch blocks

3TY7 561-1. for lateral mounting onto
size 6 to 14 contactors

mounted
on left

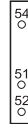

mounted
on right



3RT20 contactors, 3-pole

Dimension drawings

3RT2.1.-1 contactor and 3RH21.-1 contactor relays
 Size S00 and NEMA Size 0, screw connection
 with surge suppressor and auxiliary switch block

Lateral clearance from earthed parts = 6 mm

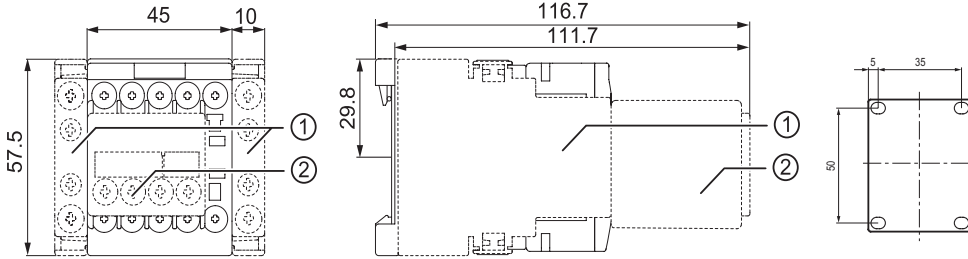

- 1) Laterally mountable auxiliary switch block 3RH2911-1DA.. / -1DE.. / -1EE..
- 2) Auxiliary switch block for mounting on the front 3RH2911-1FA.. / -1GA.. / -1HA.. / -1NF..

3RT2.1.-2 contactor and 3RH21.-2 contactor relay
 Size S00, Spring-type terminal connection
 with auxiliary switch block

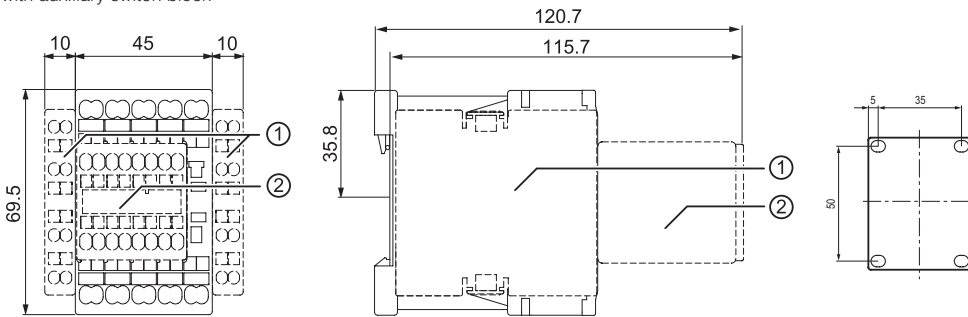

- 1) Laterally mountable auxiliary switch block 3RH2911-2DA.. / -2DE.. / -2EE..
- 2) Auxiliary switch block for mounting on the front 3RH2911-2FA.. / -2GA.. / -2HA.. / -2NF..

3RT2.2.-1 contactors Size S0 and NEMA Size 1,
 (screw-type connection system) with auxiliary switch blocks mounted and other accessories

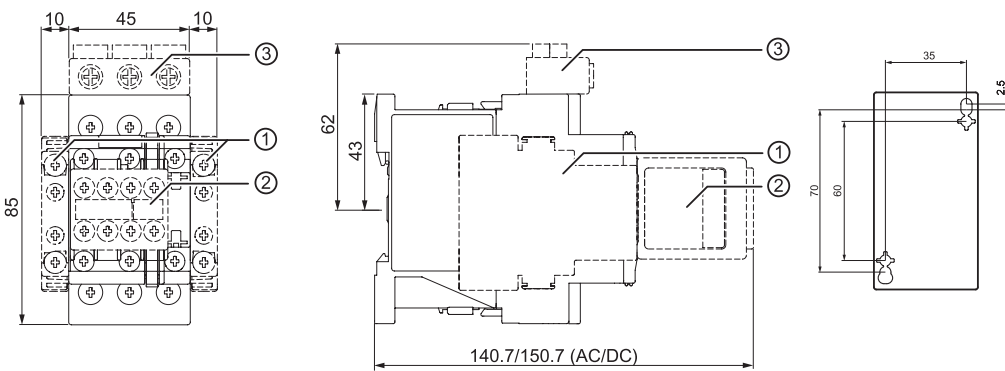

- 1) Laterally mountable auxiliary switch block 3RH2921-1DA.. / -1DE..
- 2) Auxiliary switch block for mounting on the front 3RH2911-1FA.. / -1GA.. / -1HA.. / -1NF..
- 3) 3-phase infeed terminal 3RV2925-5AB

For specific dimensions, 2D / 3D CAD files and technical data, please visit www.siemens.com/cax

3RT20 contactors, 3-pole

Dimension drawings

3RT2.2-2 and 3RT202-.....0LA2 contactors

Size S0 (spring-loaded connection) with auxiliary switch blocks mounted

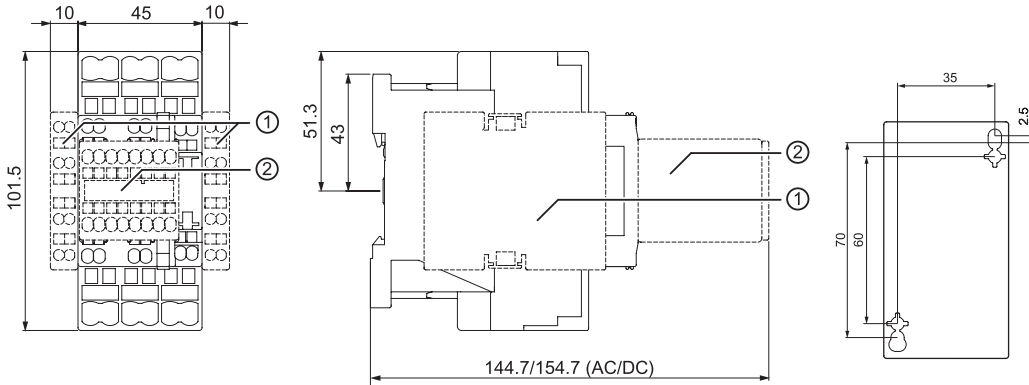

- For size S0:**
- 1) Laterally mountable auxiliary switch block 3RH2921-2DA.. / -2DE..
 - 2) Auxiliary switch block for mounting on the front 3RH2911-2FA.. / -2GA.. / -2HA.. / -2NF..

3RT20 3 contactors

Size S2 and NEMA Size 2, screw connection with surge suppressor, auxiliary switch blocks and mounted overload relay

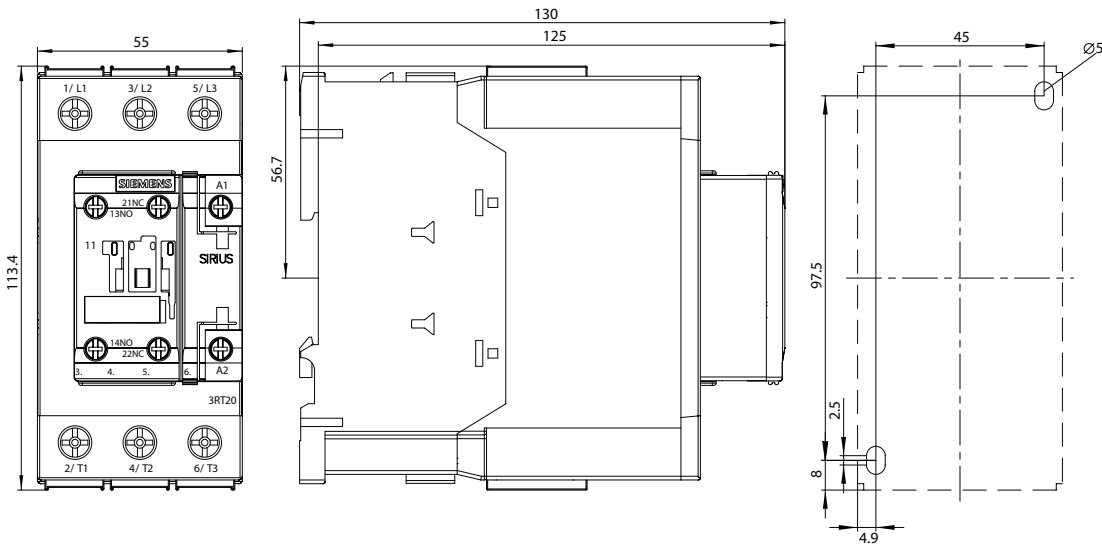

For specific dimensions, 2D / 3D CAD files and technical data, please visit www.siemens.com/cax

For size S2:

- a = 0 mm with varistor < 240 V, diode assembly
- a = 3.5 mm with varistor > 240 V
- a = 17 mm with RC element
- b = DC 15 mm deeper than AC

- 1) Auxiliary switch block, laterally mountable
- 2) Auxiliary switch block, mountable on the front (1, 2 and 4-pole)
- 3) Surge suppressor
- 4) Drilling pattern

3RT20 and 3RT24 contactors, 3-pole

Dimension drawings

3RT20 3 contactors

Size S2, Spring-type terminal connection with surge suppressor, auxiliary switch blocks and mounted overload relay

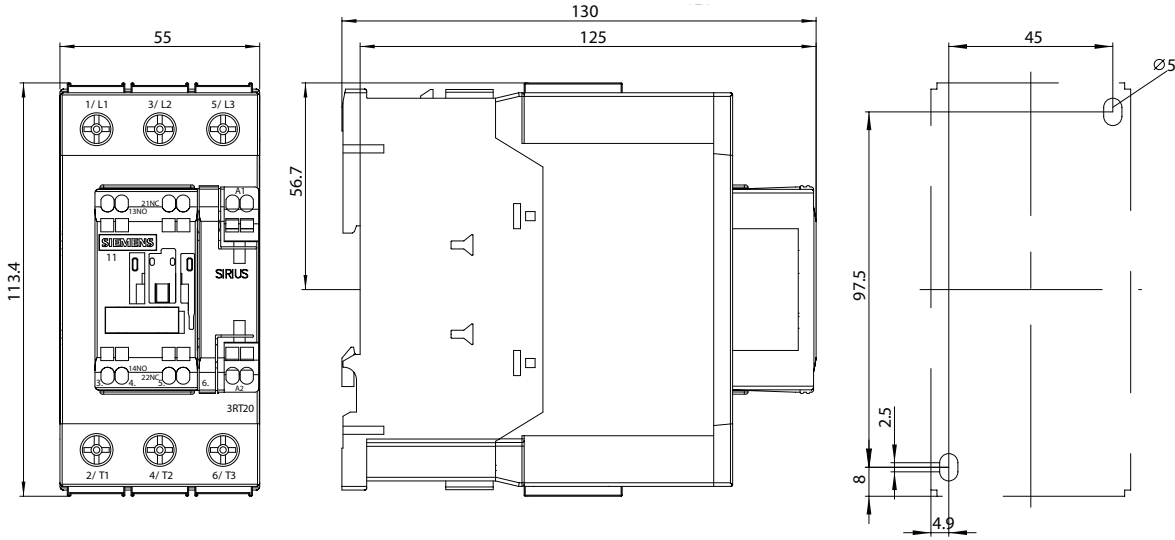

For specific dimensions, 2D / 3D CAD files and technical data, please visit www.siemens.com/cax

For size S2:

- a = 0 mm with varistor < 240 V, diode assembly
- a = 3.5 mm with varistor > 240 V
- a = 17 mm with RC element
- b = DC 15 mm deeper than AC

- 1) Auxiliary switch block, laterally mountable
- 2) Auxiliary switch block, mountable on the front (1, 2 and 4-pole)
- 3) Surge suppressor
- 4) Drilling pattern

3RT20 4, 3RT24 46 contactors

Size S3 and NEMA Size 3, screw connection with surge suppressor, auxiliary switch blocks and mounted overload relay

Lateral clearance from earthed parts = 6 mm

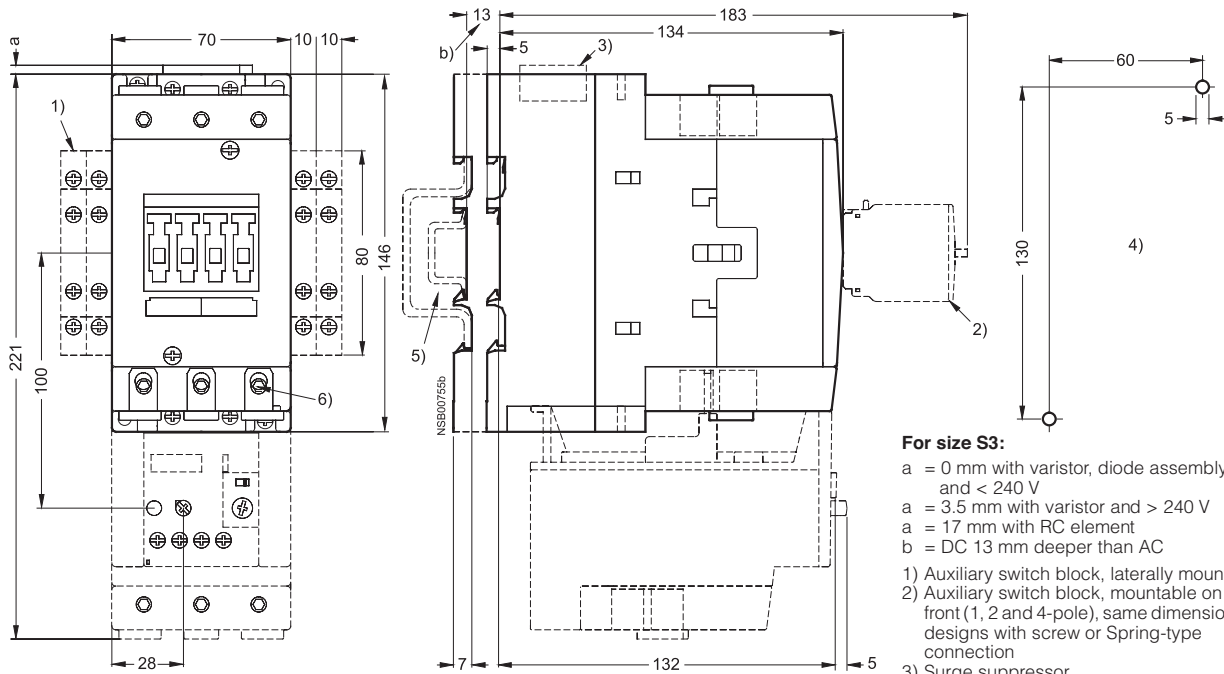

For size S3:

- a = 0 mm with varistor, diode assembly and < 240 V
- a = 3.5 mm with varistor and > 240 V
- a = 17 mm with RC element
- b = DC 13 mm deeper than AC

- 1) Auxiliary switch block, laterally mountable
- 2) Auxiliary switch block, mountable on the front (1, 2 and 4-pole), same dimensions for designs with screw or Spring-type connection
- 3) Surge suppressor
- 4) Drilling pattern
- 5) For mounting on 35 mm standard mounting rail (15 mm deep) acc. to EN 50 022 or 75 mm standard mounting rail acc. to EN 50 023
- 6) Hexagon socket screw 4 mm

For specific dimensions, 2D / 3D CAD files and technical data, please visit www.siemens.com/cax

3RT20 contactors, 3-pole

Dimension drawings

3RT20 4 contactors,
Size S3, Spring-type terminal connection
 with surge suppressor, auxiliary switch blocks
 and mounted overload relay

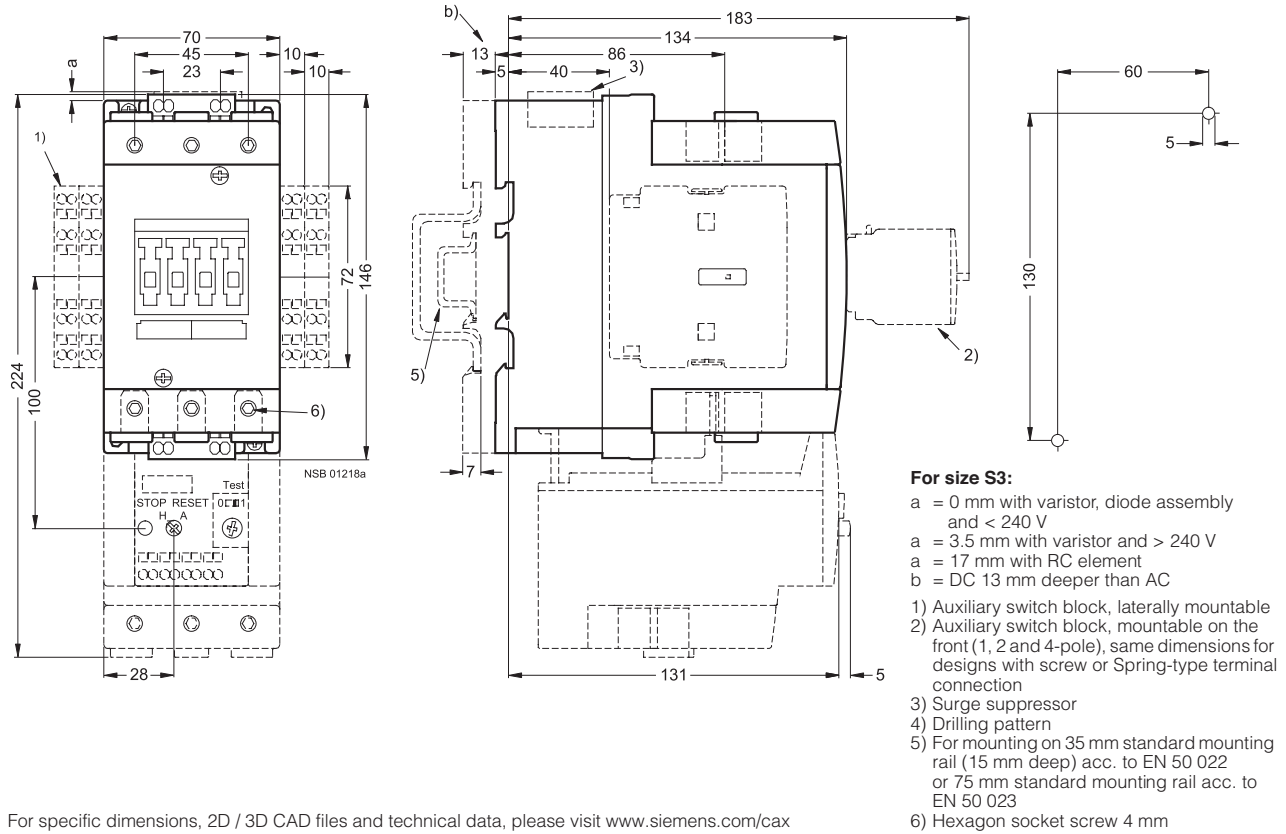

For specific dimensions, 2D / 3D CAD files and technical data, please visit www.siemens.com/cax

3RT10 and 3RT14 contactors, 3-pole

Dimension drawings

3RT10 5, 3RT14 5 contactors
Size S6 and NEMA Size 4

with auxiliary switch block, laterally mountable and mountable on the front,
mounted overload relay and box terminals,
laterally mounted electronics module with remaining lifetime indication

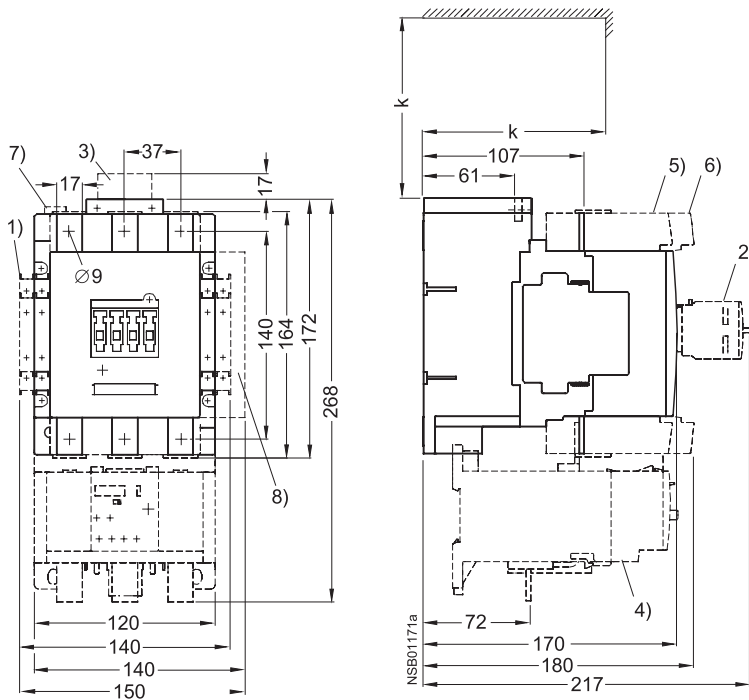

Clearance from earthed parts with
directly mounted overload relay:
lateral: 10 mm
front: 20 mm

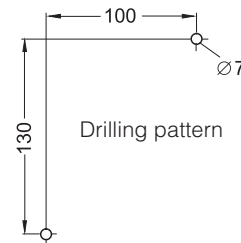

For size S6:

k = 120 mm (minimum clearance for removing the withdrawable coil)

- 1) Second auxiliary switch block, laterally mountable
- 2) Auxiliary switch block, mountable on the front
- 3) RC element
- 4) 3RB10 overload relay, mounted
- 5) 3RT19 55-4G box terminal block (hexagon socket 4 mm)
- 6) 3RT19 56-4G box terminal block (hexagon socket 4 mm)
- 7) PLC connection DC 24 V and changeover switch (with 3RT1...-N)
- 8) Electronics module with remaining lifetime indication (auxiliary switch block not mountable on right-hand side)

For specific dimensions, 2D / 3D CAD files and technical data, please visit www.siemens.com/cax

3RT10 and 3RT14 contactors, 3-pole

Dimension drawings

3RT10 6, 3RT14 6 contactors

Size S10

with auxiliary switch block, laterally mountable and mountable on the front, mounted overload relay and box terminals, laterally mounted electronics module with remaining lifetime indication

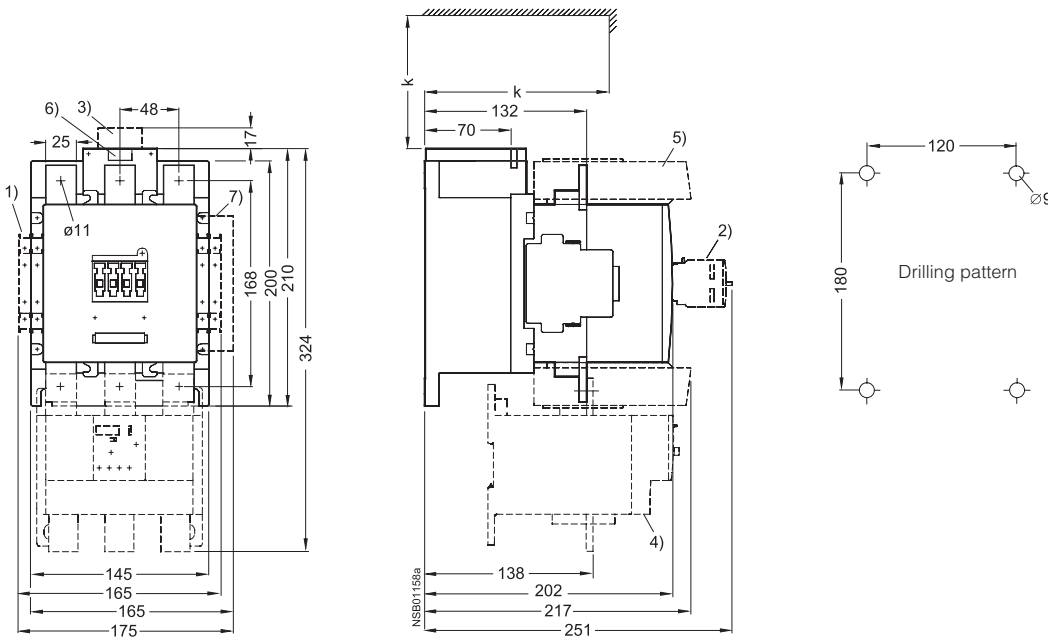

3RT10 7, 3RT14 7 contactors

Size S12

with auxiliary switch block, laterally mountable and mountable on the front, mounted overload relay and box terminals, laterally mounted electronics module with remaining lifetime indication

For sizes S10 and S12:

Clearance from earthed parts with directly mounted overload relay:
lateral: 10 mm
front: 20 mm

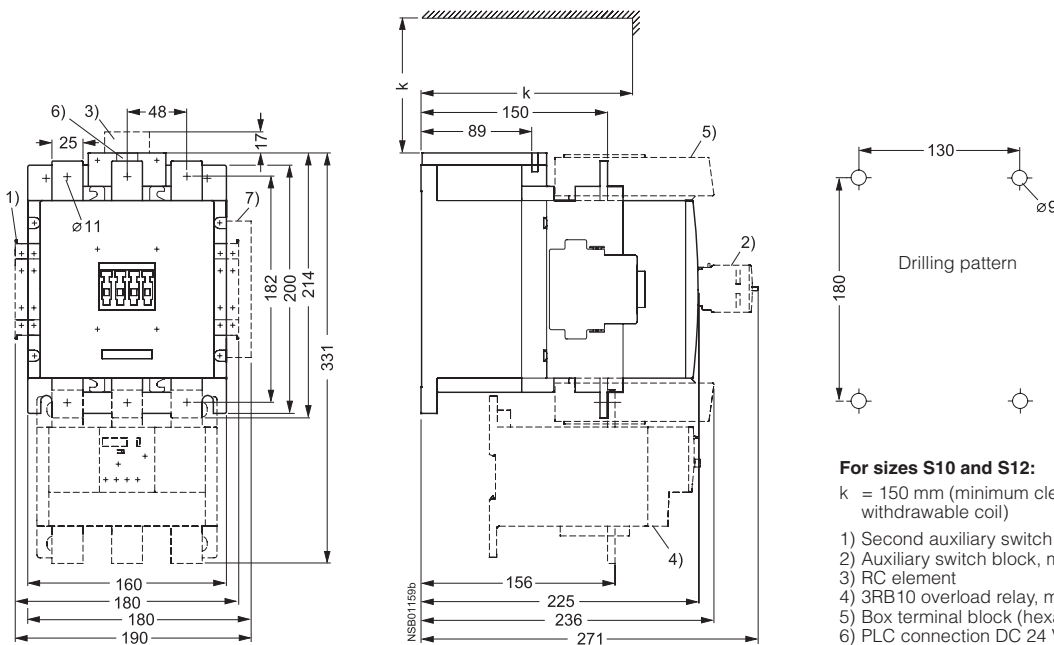

For sizes S10 and S12:

k = 150 mm (minimum clearance for removing the withdrawable coil)

- 1) Second auxiliary switch block, laterally mountable
- 2) Auxiliary switch block, mountable on the front
- 3) RC element
- 4) 3RB10 overload relay, mounted
- 5) Box terminal block (hexagon socket 6 mm)
- 6) PLC connection DC 24 V and changeover switch (with 3RT1...-N)
- 7) Electronics module with remaining lifetime indication (auxiliary switch block not mountable on right-hand side)

For specific dimensions, 2D / 3D CAD files and technical data, please visit www.siemens.com/cax

3RT12 vacuum contactors, 3-pole

Dimension drawings

3RT12 6 vacuum contactors
Size S10

with auxiliary switch block, laterally mountable,
mounted overload relay and box terminals,
laterally mounted electronics module with remaining lifetime indication

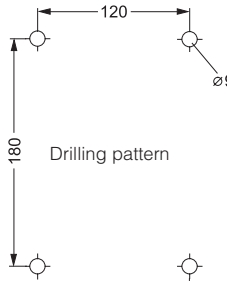
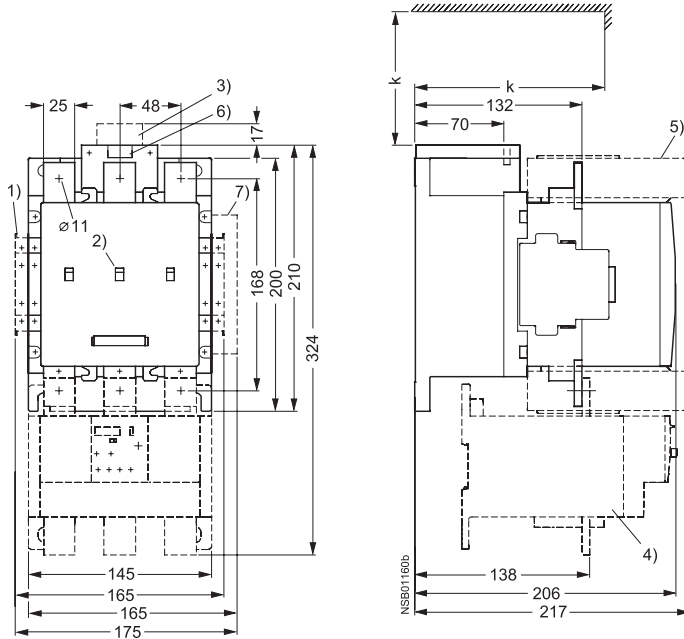

Detail
Contact erosion indicator for vacuum interrupters

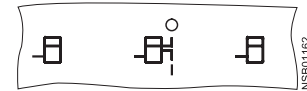

3RT12 7 vacuum contactors
Size S12

with auxiliary switch block, laterally mountable,
mounted overload relay and box terminals,
laterally mounted electronics module with remaining lifetime indication

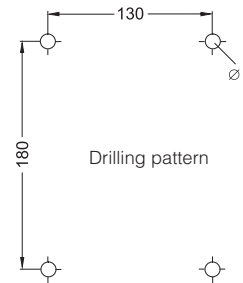
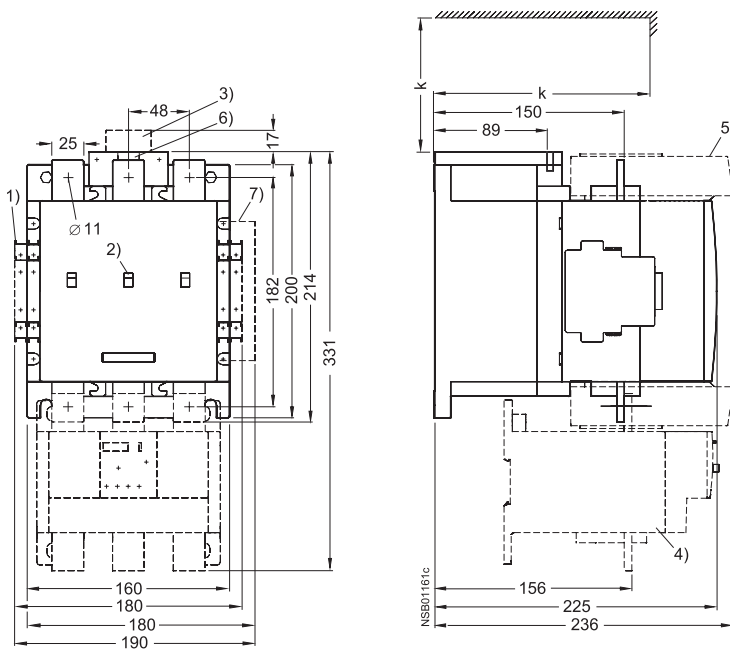

For sizes S10 and S12:

k = 150 mm (minimum clearance for removing the withdrawable coil)

- 1) Second auxiliary switch block, laterally mountable
- 2) Position and contact erosion indicator
- 3) RC element
- 4) 3RB10 overload relay, mounted
- 5) Box terminal block (hexagon socket 6 mm)
- 6) PLC connection DC 24 V and changeover switch (with 3RT1...-N)
- 7) Electronics module with remaining lifetime indication (auxiliary switch block not mountable on right-hand side)

For specific dimensions, 2D / 3D CAD files and technical data, please visit www.siemens.com/cax

3RT23 and 3RT25 contactors, 4-pole

Dimension drawings

3RT23 1 and 3RT25 1 contactors

Size S00, screw connection with surge suppressor and auxiliary switch block

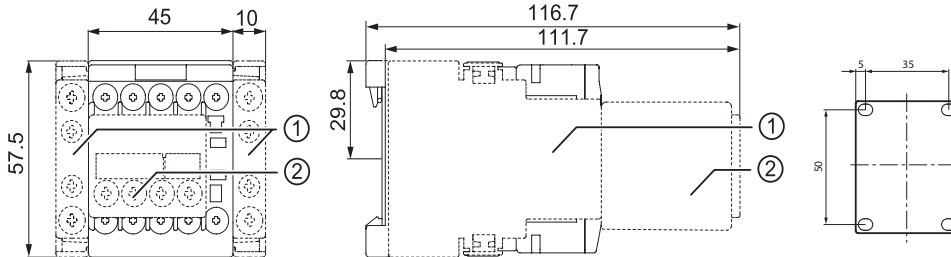

Lateral clearance from earthed parts = 6 mm

For size S00:

- 1) Laterally mountable auxiliary switch block 3RH2911-1DA.. / -1DE.. / -1EE..
- 2) Auxiliary switch block for mounting on the front 3RH2911-1FA.. / -1GA.. / -1HA.. / -1NF..

3RT23 2 and 3RT25 2 contactors

Size S0 with coil terminal module and auxiliary switch block

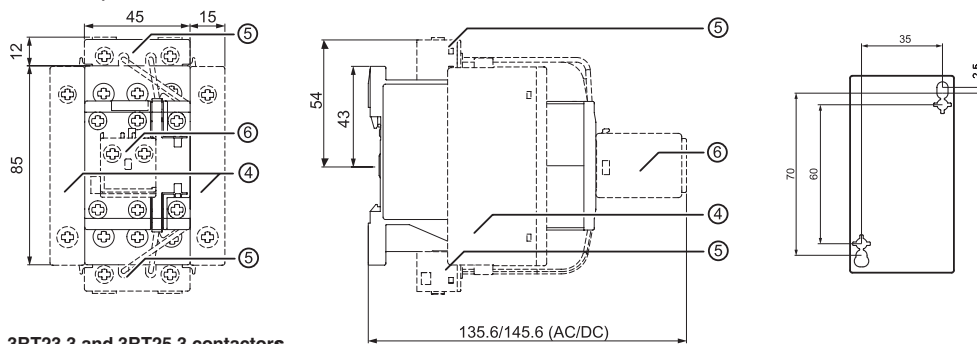

For size S0:

- 4) 4-pole contactor for switching 4 resistive loads 3RT232. 4-pole pole-changing contactor for changing the polarity of hoisting gear motors (2 NO contacts and 2 NC contacts) 3RT252.
- 5) Coil terminal module 3RT2926-4RA11/-4RB11
- 6) Auxiliary switch block for mounting on the front 3RH2911-1AA.. / -1BA

3RT23 3 and 3RT25 3 contactors

Size S2 with surge suppressor and auxiliary switch block

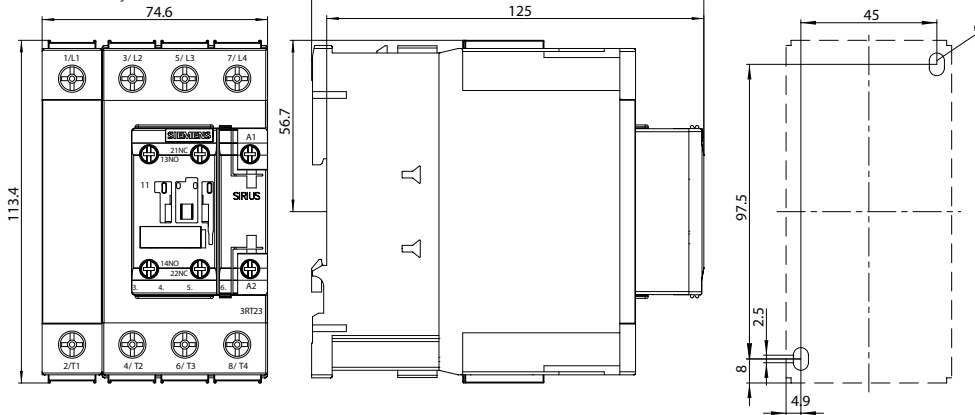

For sizes S2 and S3:

- a = 0 mm with varistor < 240 V
 - a = 3.5 mm with varistor > 240 V
 - a = 17 mm with RC element and diode assembly
 - b = S2: DC 15 mm deeper than AC
 - S3: DC 13 mm deeper than AC
- 1) Auxiliary switch block, laterally mountable (right or left)
 - 2) Auxiliary switch block, mountable on the front, (1, 2 and 4-pole, also 3RH19 21-1FE22 solid-state compatible design)
 - 3) Surge suppressor
 - 4) Drilling pattern
 - 5) For mounting on 35 mm standard mounting rail (15 mm deep) acc. to EN 50 022 or, in the case of size S3, 75 mm standard mounting rail acc. to EN 50 023
 - 6) Hexagon socket screw 4 mm

3RT23 4 contactors

Size S3 with surge suppressor and auxiliary switch block

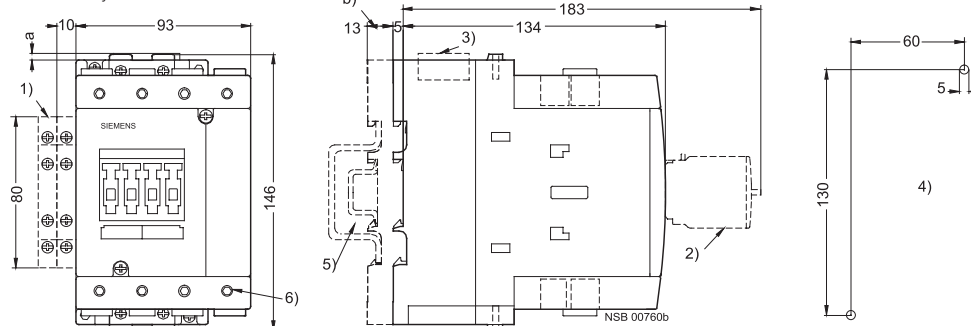

For specific dimensions, 2D / 3D CAD files and technical data, please visit www.siemens.com/cax

3RT16 capacitor contactors

Dimension drawings

3RT16 17 capacitor contactors
Size S00

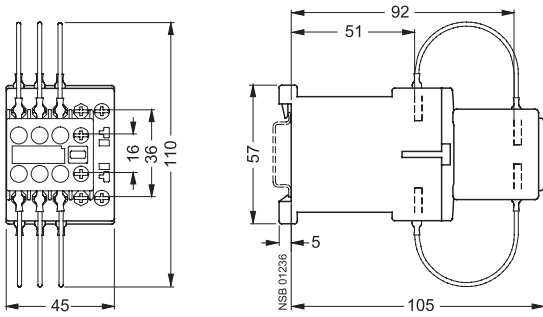

3RT16 27 capacitor contactors
Size S0

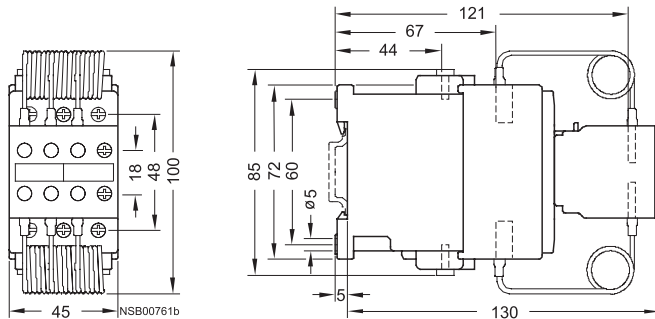

3RT16 47 capacitor contactors
Size S3

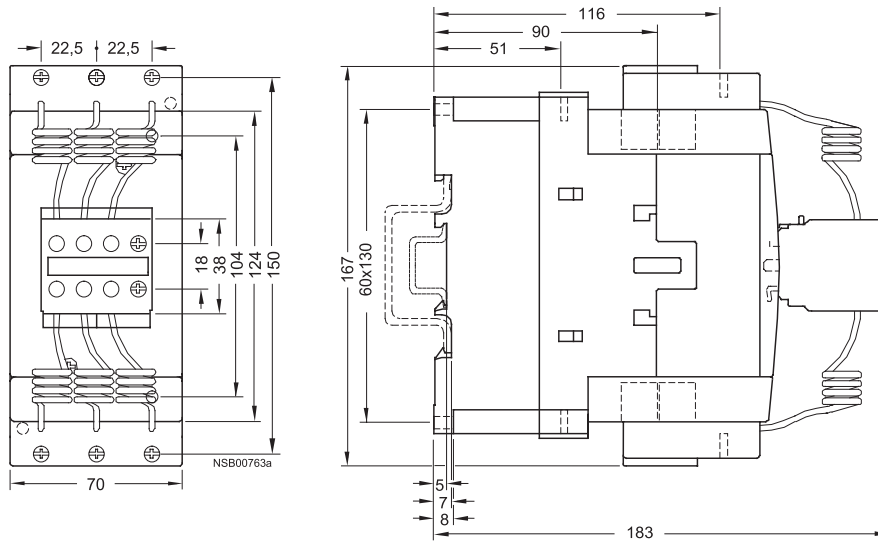

For specific dimensions, 2D / 3D CAD files and technical data, please visit www.siemens.com/cax

3RA23 contactor assemblies for reversing

Dimension drawings

Size S00 / 3RA231

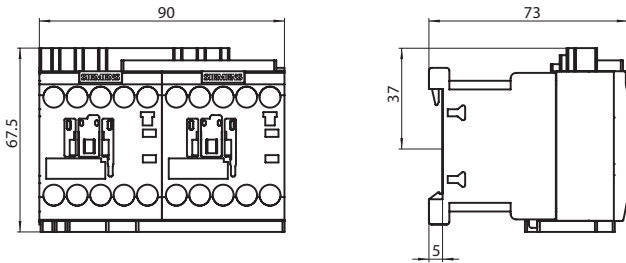

Size S0 / 3RA232

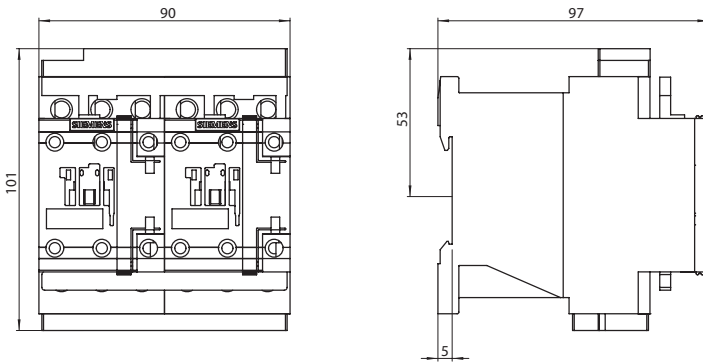

Size S2 / 3RA233

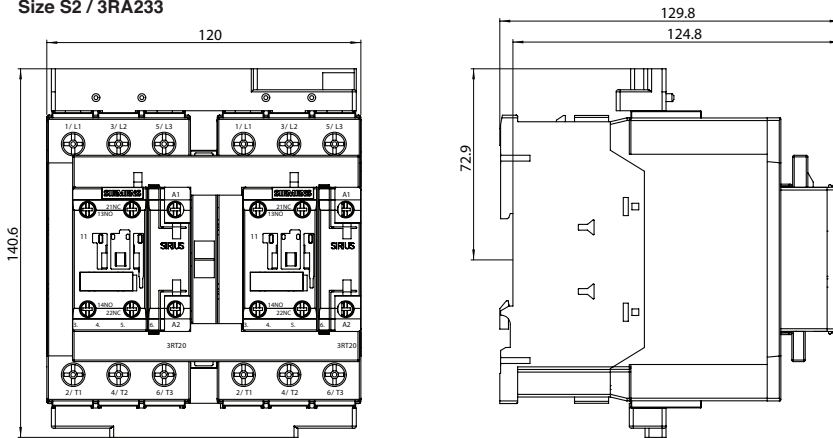

Size S3 / 3RA234

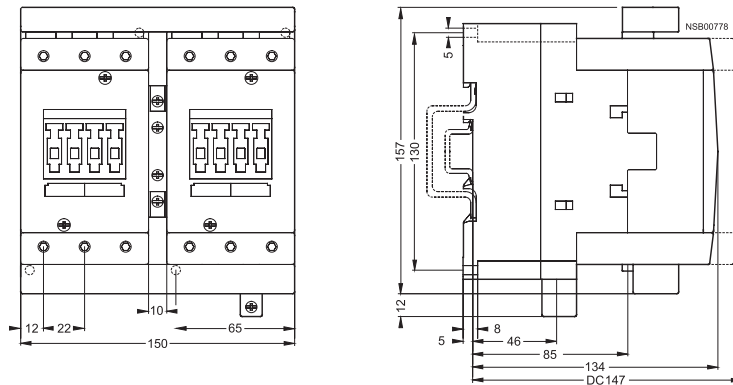

For specific dimensions, 2D / 3D CAD files and technical data, please visit www.siemens.com/cax

3RA13 contactor assemblies for reversing

Dimension drawings

Size S6

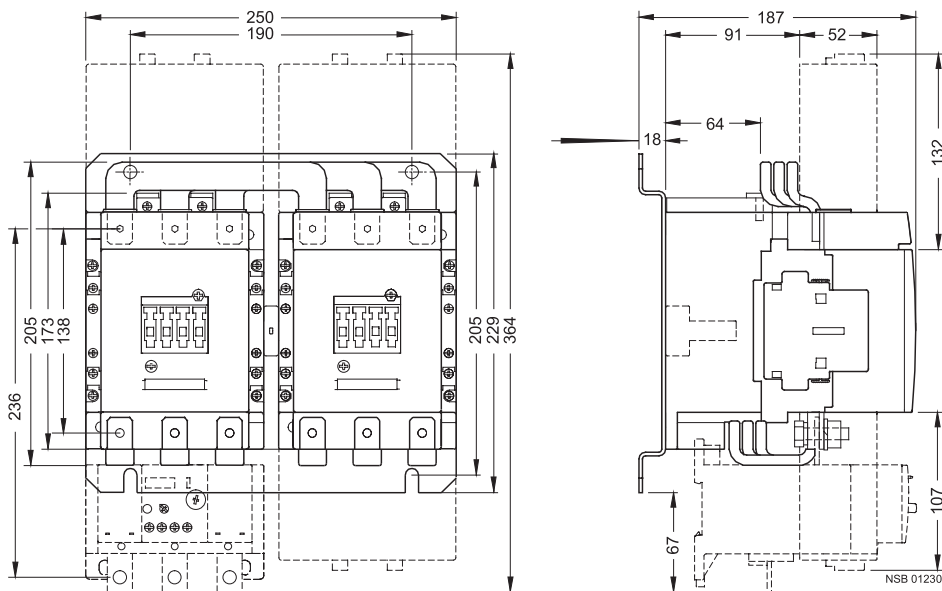

Size S10

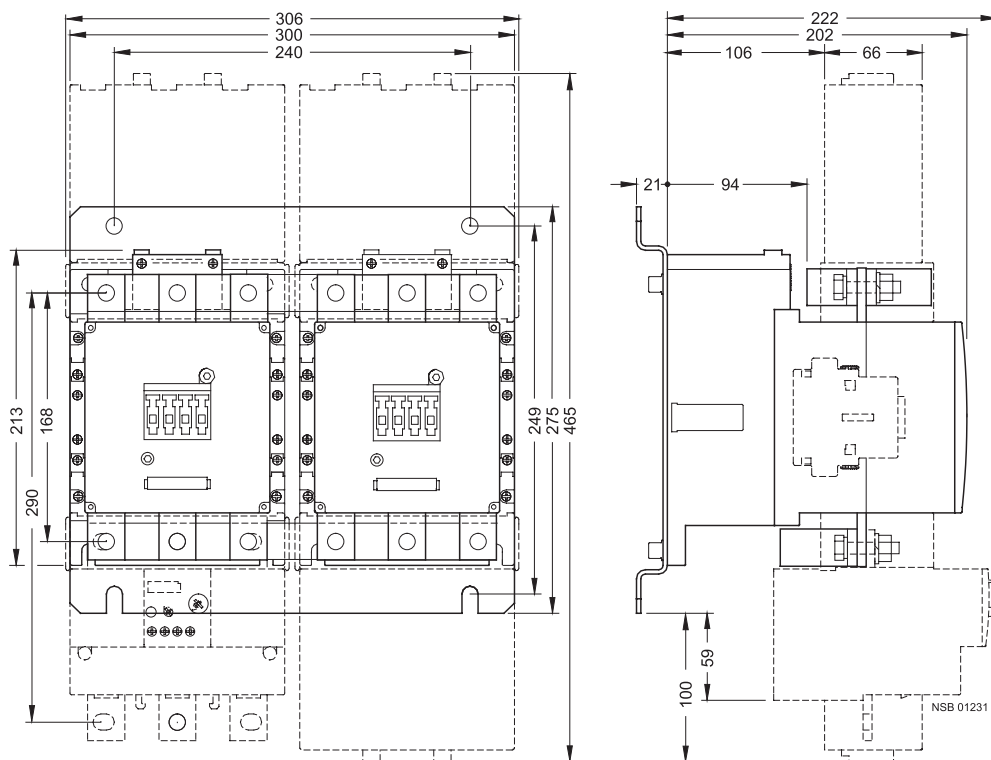

The assemblies shown on this page are for customer assembly with individual components.

3RA13 contactor assemblies for reversing

Dimension drawings

Size S12

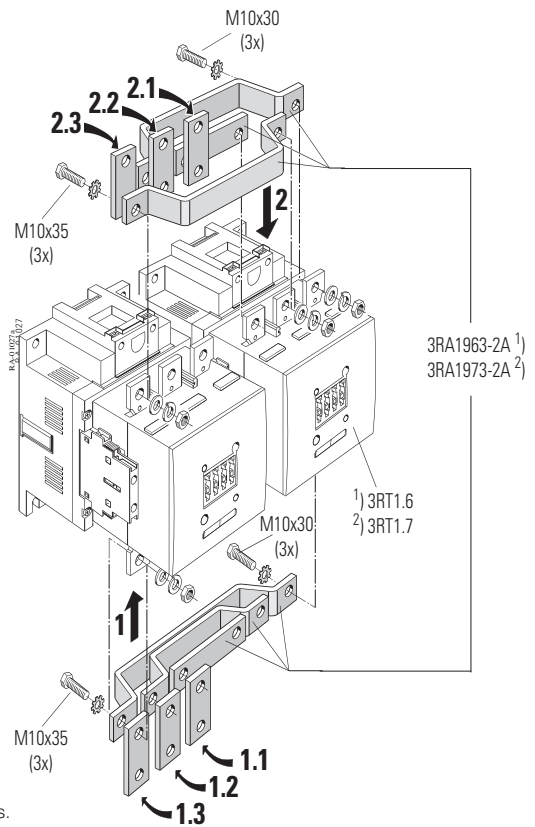
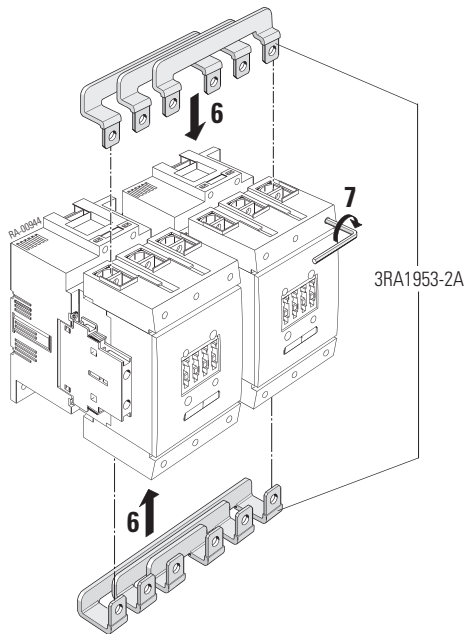
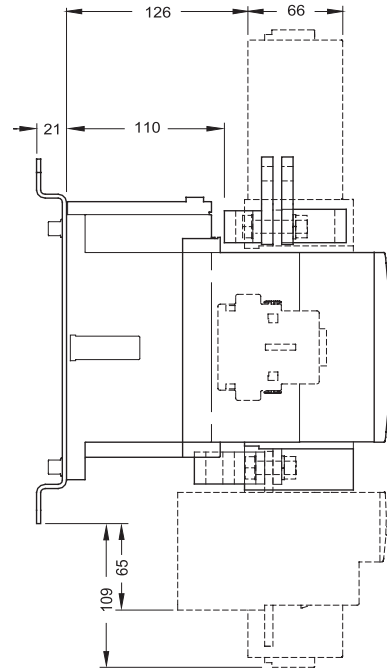
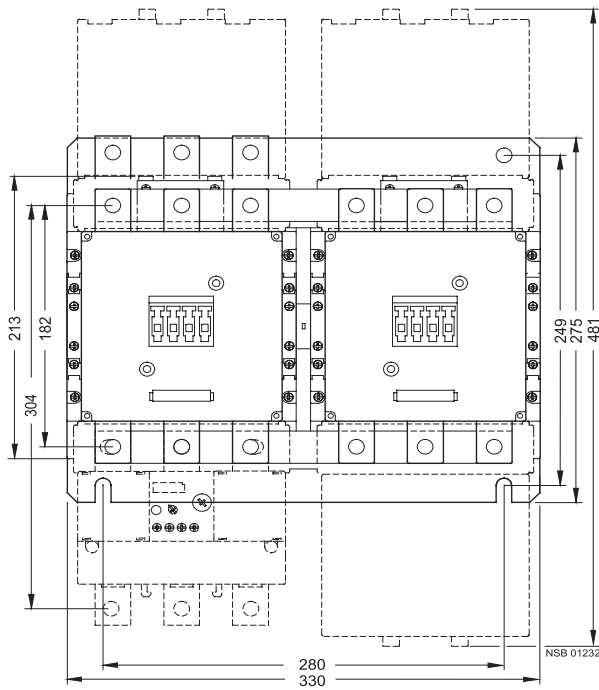

The assemblies shown on this page are for customer assembly with individual components.

3TF68 and 3TF69 vacuum contactors, 3TC4 and 3TC5 DC contactors

Dimension drawings

3TF68 vacuum contactors

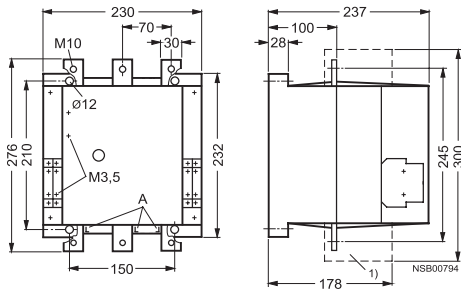

Detail
A = Contact erosion indicator for vacuum interrupter contacts

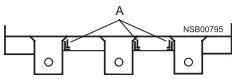

3TF69 vacuum contactors

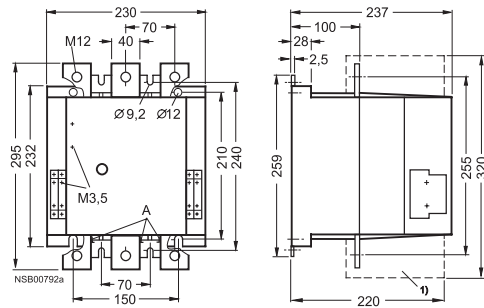

Detail
A = Contact erosion indicator for vacuum interrupter contacts

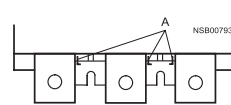

3TC4 and 3TC5 contactors

3TC44 contactors
Size 2, AC and DC operation

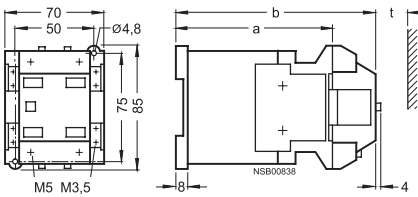

t = minimum clearance from insulated components: 15 mm (600 V and 750 V)
from grounded components: 30 mm (600 V and 750 V)

	a	b
DC operation	109	141
AC operation	68	100

3TC48 contactors
Size 4, AC and DC operation

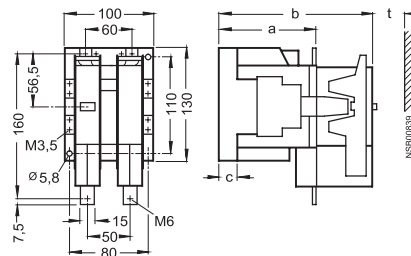

t = minimum clearance from insulated components: 15 mm (600 V),
20 mm (750 V)
from grounded components: 35 mm (600 V),
55 mm (750 V)

	a	b	c
DC operation	112	180	21.5
AC operation	86	154	23.5

3TC52 contactors
Size 8, AC and DC operation

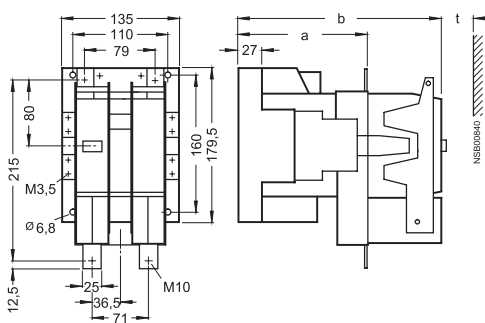

t = minimum clearance from insulated components: 20 mm (600 V and 750 V)
from grounded components: 70 mm (600 V and 750 V)

	a	b
DC operation	147	232
AC operation	115	200

3TC56 contactors
Size 12, AC and DC operation

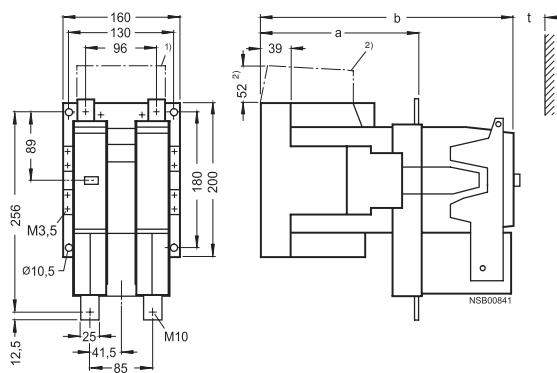

t = minimum clearance from insulated components: 25 mm (600 V and 750 V)
from grounded components: 80 mm (600 V),
100 mm (750 V)

	a	b
DC operation	200	310
AC operation	141	251

1) With box terminals for laminated copper bars (accessories).

2) DC operation only

Accessories for 3RT2 contactors

Dimension drawings

Terminal cover for box terminals for size S2, 3RT29 36-4EA2

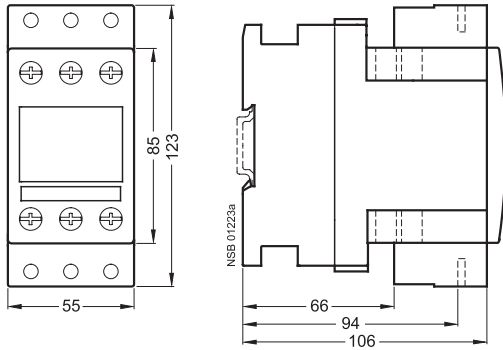

Terminal cover for box terminals for size S3, 3RT19 46-4EA2

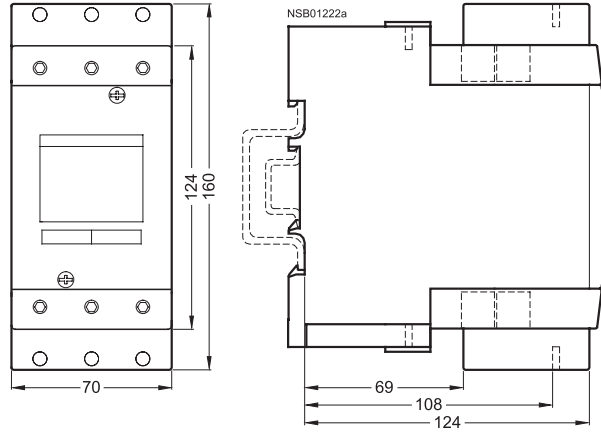

Terminal cover for cable lug and bar connection for size S3, 3RT19 46-4EA1

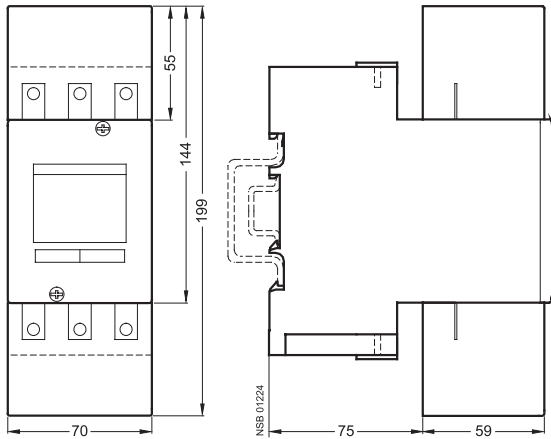

Auxiliary conductor terminal, 3-pole 3RT19 46-4F Size S3 mounted on contactor

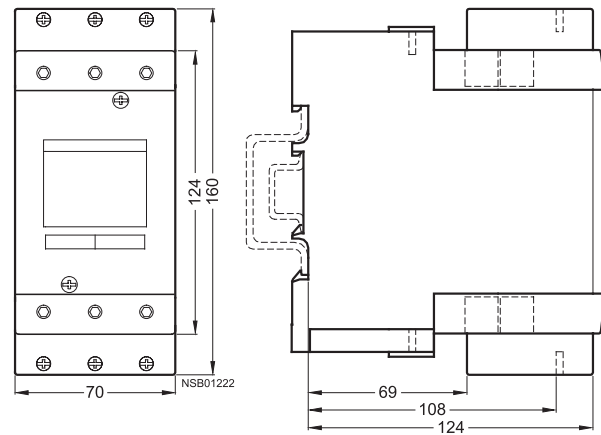

For specific dimensions, 2D / 3D CAD files and technical data, please visit www.siemens.com/cax

Dimension drawings

3RA19.2-2A baseplates for reversing contactor assemblies

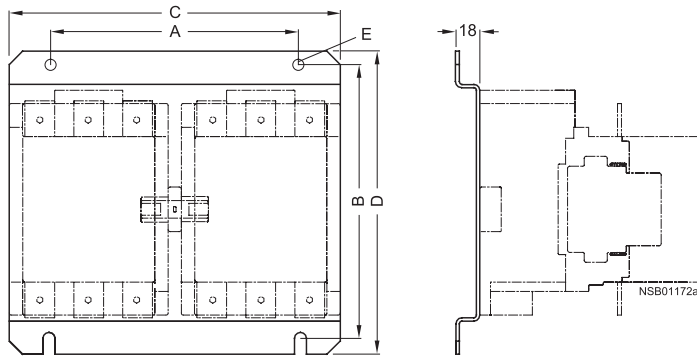

	A	B	C	D	E
S6	190	205	250	229	9
S10	240	249	300	275	11
S12	280	249	330	275	11

3RA19.2-2E, 3RA19.2-2F baseplates for star-delta assemblies

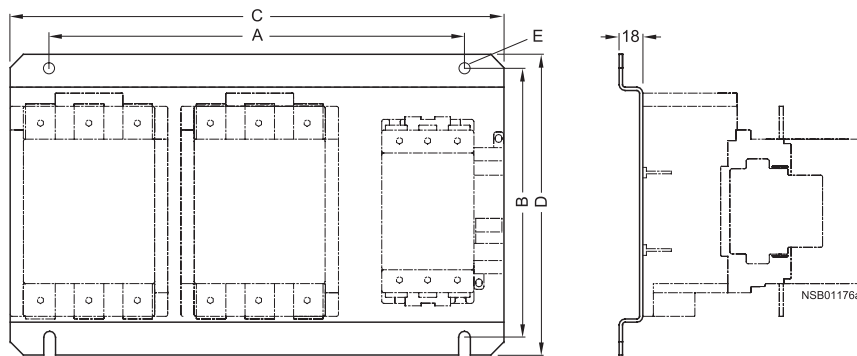

	A	B	C	D	E
S6-S6-S3	316	205	376	229	9
S6-S6-S6	343	205	403	229	9
S10-S10-S6	393	250	453	275	11
S10-S10-S10	423	250	483	275	11
S12-S12-S10	450	250	510	275	11
S12-S12-S12	465	250	525	275	11

For specific dimensions, 2D / 3D CAD files and technical data, please visit www.siemens.com/cax

3RH21 and 3RH24 control relays

Dimension drawings

3RH21 control relays

Size S00, with screw connections

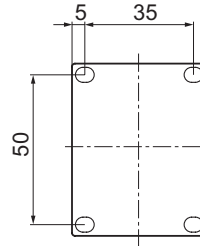
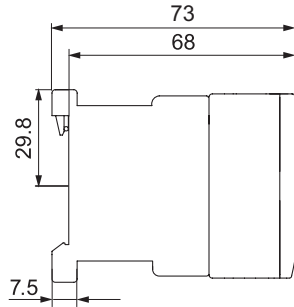
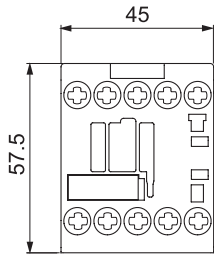

Lateral clearance from earthed parts = 6 mm

3RH24 latched control relays

Size S00

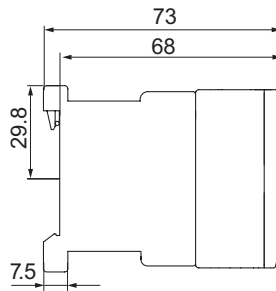
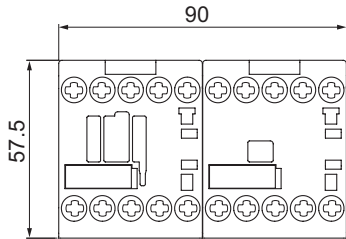

3RH21 coupling relay

Dimension drawings

Size S00, with screw connections, with surge suppressor

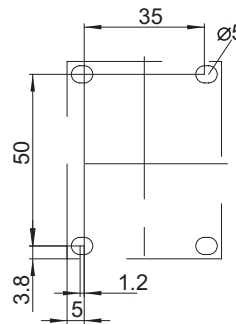
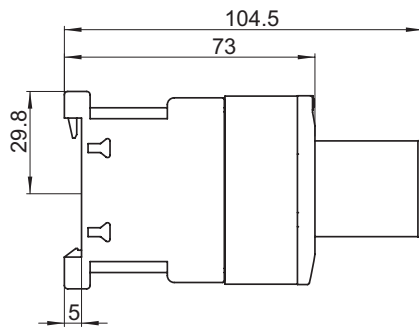
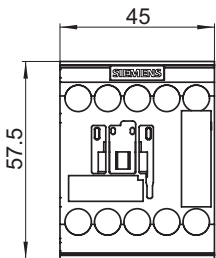

- 1) Surge suppressor
- 2) Drilling pattern

Deviating dimensions for coupling relays with Spring-type terminal connections

Height: 69.5 mm

For specific dimensions, 2D / 3D CAD files and technical data, please visit www.siemens.com/cax

