

- NOTES**
- 1) TERMINALS RECOMMENDED ARE PRE-INSULATED & MUST BE CRIMPED USING APPROVED TOOLING. AMP PLOG OR PLASTI GRIP FUNNEL ENTRY (RING TONGUE) FOR M4 FIXING STUD.
 - 2) FOR OUTLINE & PANEL DRILLING, SEE 2995X10004 (A4).
 - 3) CONNECTIONS TO THIS COMMUNICATIONS FACILITY IS BY SCREENED, TWISTED PAIR CABLE. ON SITE WHEN WIRING OTHER FACILITIES ENSURE THAT THESE TERMINALS ARE NOT OBSCURED BY OTHER WIRE RUNS.
 - 4) CONTACTS SHOWN THUS  ARE INTERNAL RELAY CASE ASSEMBLY CONTACTS AND CLOSE WHEN THE RELAY CHASSIS IS WITHDRAWN FROM THE CASE.
 - 5) FOR THE RELAY CASE ASSEMBLY SEE 2436G40048

SUPPLIER	PART NUMBER	CABLE SIZE
AMP	342103	0.25-1.6mm ²
AMP	342143	1.0-2.6mm ²

ABBREVIATIONS

I-CURRENT INPUTS
V-VOLTAGE INPUTS
BI-BINARY INPUTS
BO-BINARY OUTPUTS
CO-CHANGE OVER BINARY OUTPUT CONTACTS
NO-NORMALLY OPEN BINARY OUTPUT CONTACTS
NC-NORMALLY CLOSED BINARY OUTPUT CONTACTS

COMMUNICATIONS IDENTIFICATION	
COM1	RS485 (ON BLOCK 'B' TERMINALS 14,16,18 & 20)
COM2	USB TYPE 'B' PORT (ON RELAY FRONT LABEL)
COM3	ETHERNET(X2) PORTS (ON REAR COMMS MODULE)

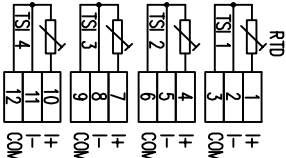

CONNECTOR 1

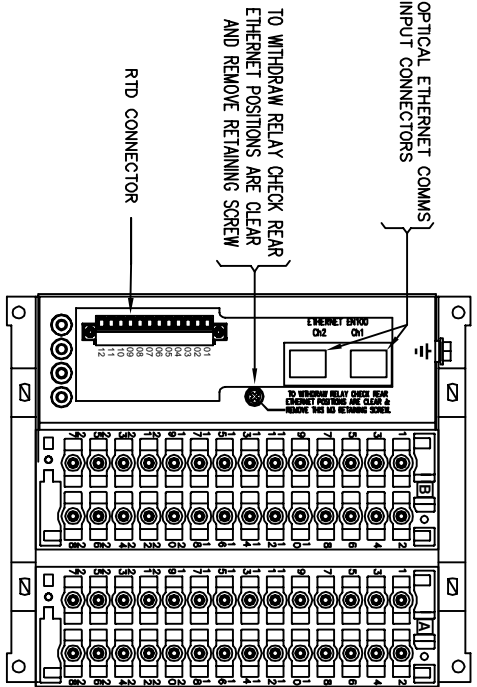
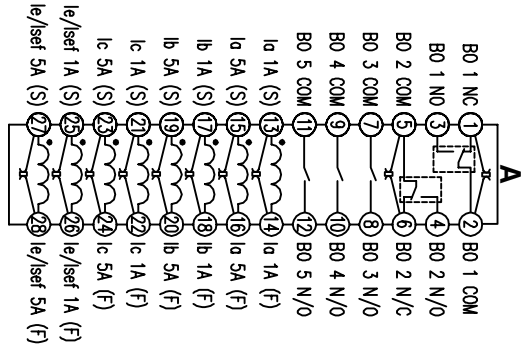
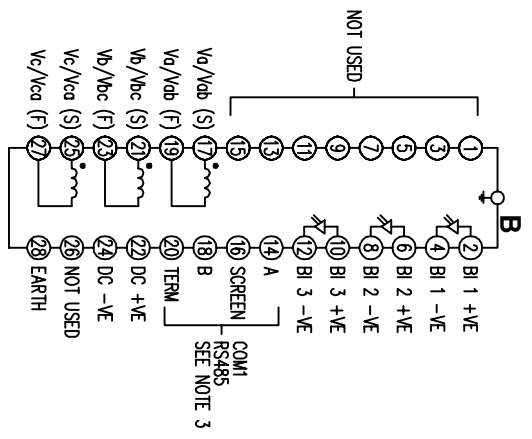
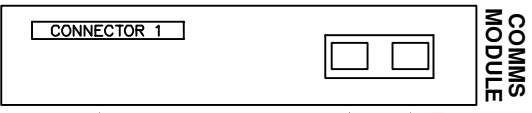

RELAY VIEWED FROM REAR

FOR INTERNAL USE ONLY
UNCONTROLLED COPY
NOT SUBJECT TO UPDATE

Rev.	Change	Date	Name	FINISH	Material	Material Scale	Value/Range														
1A	DRAWING RELEASED		AMAR		NTS																
<table border="1"> <thead> <tr> <th>DRN. BY</th> <th>CHKD. BY</th> <th>APPD. BY</th> <th>EM. EA. PRO. R&D</th> </tr> </thead> <tbody> <tr> <td>AMAR</td> <td>JOHN SF</td> <td>JAVANT J</td> <td></td> </tr> </tbody> </table>				DRN. BY	CHKD. BY	APPD. BY	EM. EA. PRO. R&D	AMAR	JOHN SF	JAVANT J		<table border="1"> <thead> <tr> <th>Name</th> <th>Id</th> </tr> </thead> <tbody> <tr> <td>AMAR</td> <td>AMAR</td> </tr> </tbody> </table>				Name	Id	AMAR	AMAR		
DRN. BY	CHKD. BY	APPD. BY	EM. EA. PRO. R&D																		
AMAR	JOHN SF	JAVANT J																			
Name	Id																				
AMAR	AMAR																				
<table border="1"> <thead> <tr> <th>UNSPECIFIED TOLERANCES (UNLESS STATED)</th> <th>TOLERANCE</th> </tr> </thead> <tbody> <tr> <td>0-4</td> <td>F0.1</td> </tr> <tr> <td>0.4-3</td> <td>F0.2</td> </tr> <tr> <td>3-30</td> <td>F0.5</td> </tr> <tr> <td>30+</td> <td>F1.0</td> </tr> </tbody> </table>				UNSPECIFIED TOLERANCES (UNLESS STATED)	TOLERANCE	0-4	F0.1	0.4-3	F0.2	3-30	F0.5	30+	F1.0	<table border="1"> <thead> <tr> <th>Docu. No.</th> <th>Docu. No.</th> </tr> </thead> <tbody> <tr> <td>2436W40067</td> <td>7SR17</td> </tr> </tbody> </table>				Docu. No.	Docu. No.	2436W40067	7SR17
UNSPECIFIED TOLERANCES (UNLESS STATED)	TOLERANCE																				
0-4	F0.1																				
0.4-3	F0.2																				
3-30	F0.5																				
30+	F1.0																				
Docu. No.	Docu. No.																				
2436W40067	7SR17																				
<p>TERMINAL ID & WIRING DIAGRAM FOR 7SR17 4CT+3VT+3BI+5BO(2CO+3NO), OPTICAL ETH(X2), 4 RTD</p>				<p>1A</p>																	