

REVISION	DATE	BY	DATE	BY
		DRAWN	05/01/24	GP
		CHEK'D		
		VERIF'D		

Siemens Industry, Inc. Building Technologies Division	
CUSTOMER	
ORDER NO.	DWG. NO.
	1D1Y167CTP1
	SH 1 OF 2

SIEMENS

CATALOG NO. 1D1Y167CTP1
 SERIAL NO. SERIES H
 167 kVA 60 Hz 1 PHASE
 5.4 % IMP AT 170 °C

150 °C RISE 30 °C AVG. AMBIENT
 220 °C TEMP CLASS 40 °C MAX. AMBIENT



PRIMARY (H1 H3 H2 H4) 240X480V V
 SECONDARY(X4 X2 X3 X1) 120/240V V

WINDING MATERIAL CU
 ENCLOSURE TYPE NEMA-3R
 WEIGHT 1150 LBS

SPACINGS BETWEEN ENCLOSURE AND ANY ADJACENT WALL SHALL BE A MINIMUM OF 6 INCHES
 UNIT MEETS TP1-1996 EFFICIENCY

SUITABLE FOR INDOOR OR OUTDOOR LOCATIONS
 DO NOT INSTALL IN AREAS ACCESSIBLE TO PUBLIC
 FOR INSTALLATION SEE INSTRUCTION MANUAL

NEMA Class ANN Dry Type Transformer Siemens Industry, Inc. Norcross, GA

E112313 LR 3902
 LISTED DISTRIBUTION TRANSFORMER 77US



1D1Y167CTP1

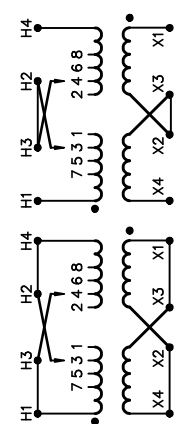

HAM1006

VOLTS	INPUT LINE ON H1 & H4 CONNECT
504	H2-1, H3-2
492	H3-2, H2-3
480	H2-3, H3-4
468	H3-4, H2-5
456	H2-5, H3-6
444	H3-6, H2-7
432	H2-7, H3-8
252	H2-1, H3-2
240	H2-3, H3-4
228	H2-5, H3-6
216	H2-7, H3-8

VOLTS	CONNECT	OUTPUT LINE
120	X1-X3, X2-X4	X1-X4
240	X2-X3	X1-X4
240/120	X2-X3	X1-X2-X4

FRONT VIEW

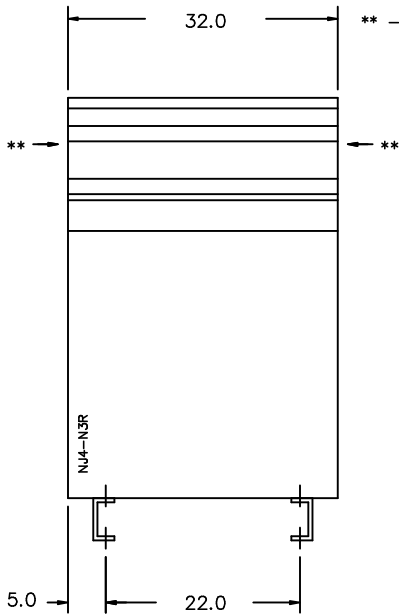

** - Recommended cable entry locations only
cutouts & gland plates not provided.

SIDE VIEW

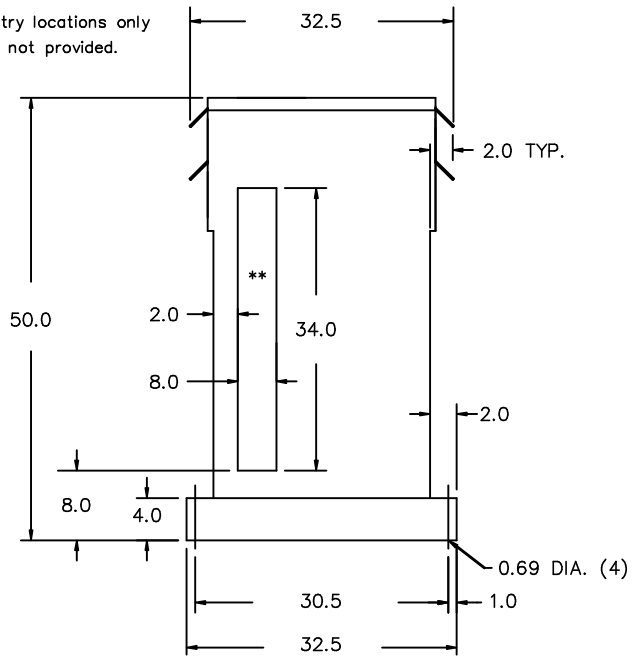

All Dimensions in inches

ENCLOSURE COLOR : ANSI 61 GREY - OUTDOOR

H.V.1. TERMINAL DETAIL

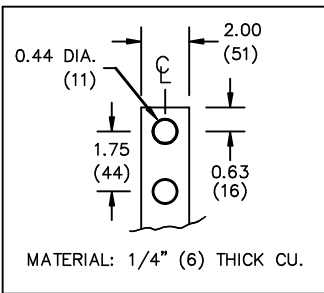

L.V.1. TERMINAL DETAIL

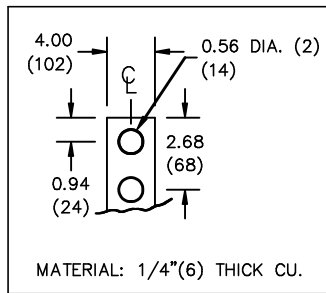

CUSTOMER NOTES:

- HV1 TERMINATED AT TOP FRONT
- LV1 TERMINATED AT BOTTOM FRONT

Siemens Industry, Inc.
Building Technologies Division

REVISION	DATE	BY	DATE	BY
		DRAWN	05/01/24	GP
		CHEK'D		
		VERIF'D		

CUSTOMER	
ORDER NO.	DWG. NO. 1D1Y167CTP1
SH 2 OF 2	

0.2 jwen 2010/01/21 13:28