



SIEMENS

Industrial Solutions and Services

PCS 7 Driver Block Siprotec 7SJ6x Mapping 3-4

Driver Block for
SIMATIC S7-400 / PCS7 V6
connected with
SIEMENS SIPROTEC4
Multifunction Protection relay
over Profibus DP with Y-Switch
IT Plant Solutions

Further information:

Siemens AG
Industrial Solutions and Services
IT Plant Solutions Produkte
I&S IS E&C MES AC22
Siemensstraße 84
76187 Karlsruhe

Contact: H. Allart
Phone: +49 (721) 595 6052
Fax: +49 (721) 595 6383
E-Mail: gunther.seckinger@siemens.com
WWW: www.siemens.com/PCS7-Bausteine/

Contents	Page
1. Software-Requirements and use conditions	3
2. Solution principle	4
3. Installation.....	5
3.1. Step 7 block library	5
3.2. SIMATIC MANAGER – Hardware Config.....	6
3.2.1. GSD-File	6
3.2.2. Hardware catalog.....	7
3.2.3. Hardware Configuration.....	8
3.2.4. Project planning tips	10
3.3. Device parameterisation multifunction protection relay	11
3.3.1. Parameterisation für 7SJ6x	11
3.3.2. Messages structures with the Mapping 3-4.....	13
3.4. WinCC Faceplate.....	15
3.4.1. Setting the Faceplate in the Graphics Designer	18
3.4.2. Languages	19
3.4.3. Clients-server or stand-alone projects.....	19
3.4.4. View: Standard	20
3.4.5. View: Measured values	21
3.4.6. View: Messages 0 / Metered measurands	22
3.4.7. View: Messages 1.....	23
3.4.8. View: WinCC Alarms	24
4. Description of the function blocks	25
4.1. Function block Y_S_2.....	25
4.1.1. CFC Representation	25
4.1.2. Function and Operating principle.....	25
4.1.3. Calling OBs.....	26
4.1.4. Start-up Characteristics	26
4.1.5. Error Handling.....	27
4.1.6. Message Characteristics	28
4.1.7. I/O list of the Y_S_2 block	29
4.2. Function block 7SJ6X_M34.....	30
4.2.1. Function	30
4.2.2. CFC representation	30
4.2.3. Operating principle.....	31
4.2.4. Calling OBs.....	32
4.2.5. Start up characteristics	32
4.2.6. Error handling	33
4.2.7. Message Characteristics	34
4.2.8. Parameters for Status and control words and bytes	35
4.2.9. Scaling of measured values and divisors	37
4.2.10. cos phi	37
4.2.11. WinCC parameter QMSG_0 and QMSG_1.....	38
4.2.12. I/O list of the 7SJ6X_M34.....	39

1. Software-Requirements and use conditions

The library requires **SIMATIC STEP7 V5**.
The blocks are executable in the CPU S7-41X.

A license is necessary for the use of the driver library.

To use the blocks, you will need a license for each CPU.

The necessary GSD file is delivered by Siemens.

2. Solution principle

Redundant mode with Y-Link

The devices SIPROTEC 4 (7SJ6x) are connected with the Y-Link device to SIMATIC S7 H.

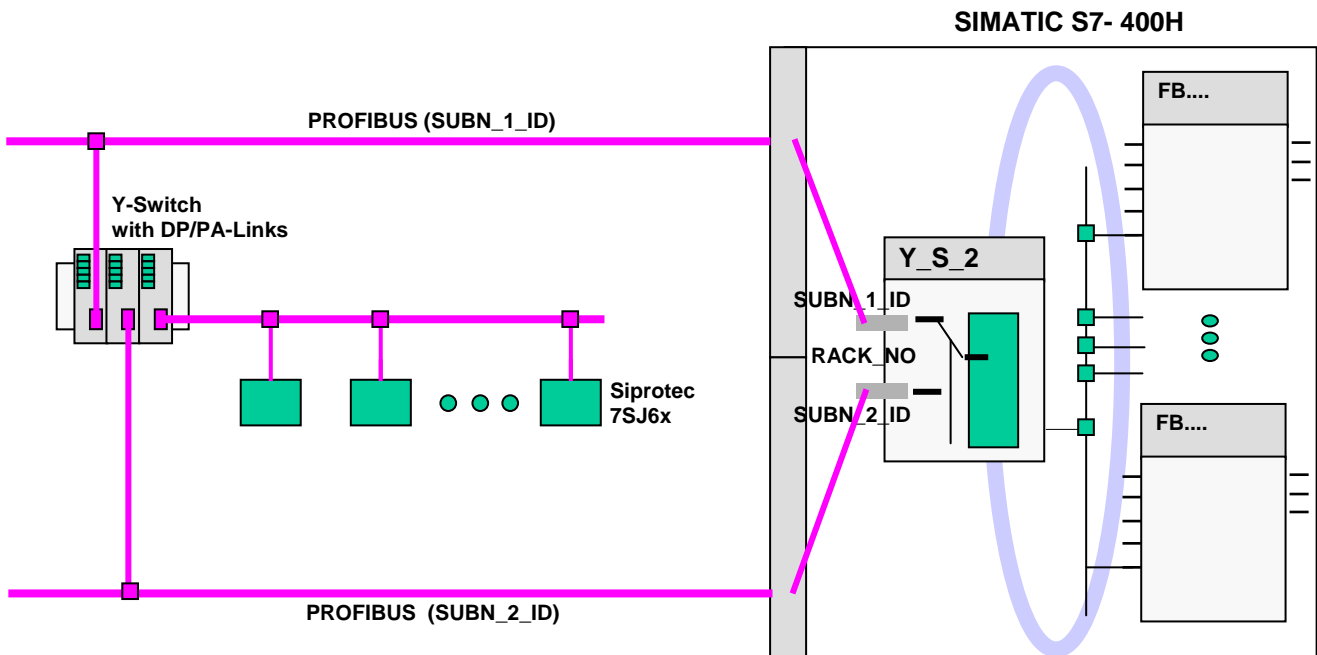

The hardware needed for the Y-link system is listed in the following table.

Component	Amount	Reference number
PS 407 10A	2	6ES7 307-1BA00-0AA0
SIMATIC DP/PA Link IM 157	2	6ES7 157-0AA82-0XA0
Y-COUPLER	1	6ES7 197-1LB00-0XA0
Bus module BM IM 157/ IM157	1	6ES7 195-7HD80-0XA0
Bus module Y-Coupler	1	6ES7 654-7HY00-0XA0

This documentation concerns SIPROTEC4-Devices:

Device 7SJ6x	Firmware As of Version	PROFIBUS-DP communication module as of Version
7SJ6x	04.46.01	04.00.06

Where 7SJ6x is 7SJ61, 7SJ62, 7SJ63 and 7SJ64 devices implementing mapping 3-4.

3. Installation

3.1. Step 7 block library

The block is supplied as archived Step 7 library with the file name **Lib_PCS7_SIP_7SJ6X_M34_V10_[Y2].zip** (xx: version).

The library is retrieved over the SIMATIC MANAGER. As target directory the catalogue **SIEMENS\STEP7\S7libs** is indicated.

After the installation the driver blocks are available in the block library **SIP_7SJ6x_M34_Y2_Vxx**.

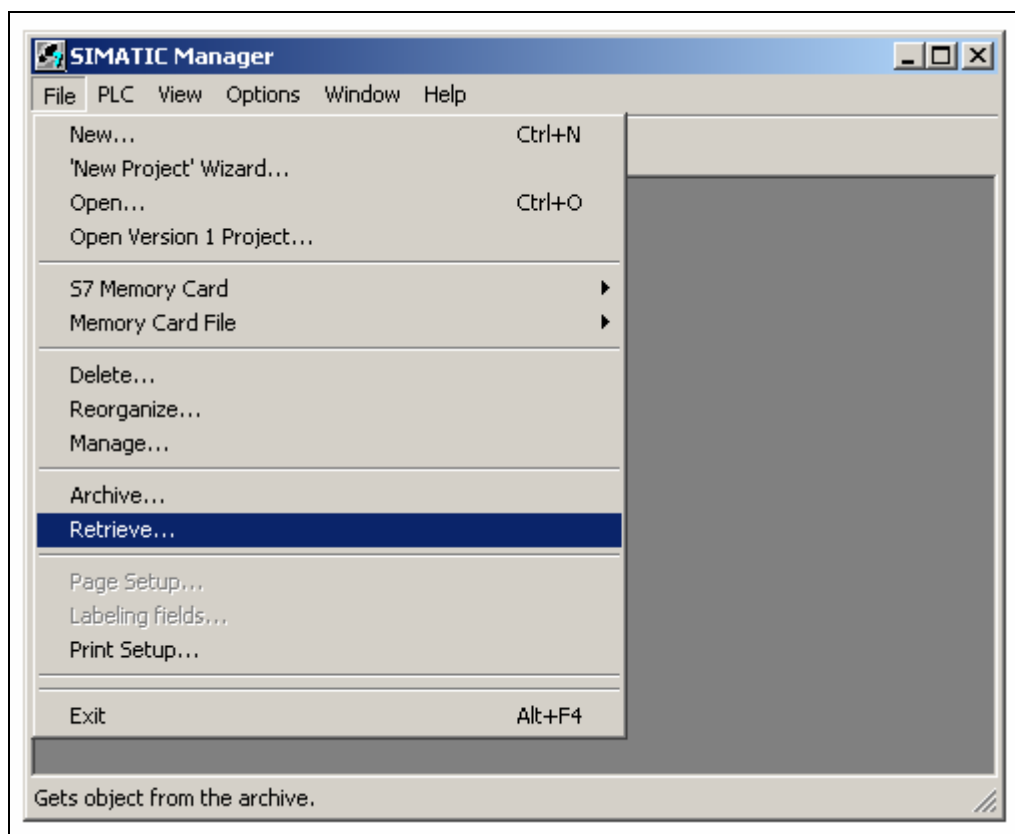

Picture 3-1 Retrieve PCS7 library

3.2. SIMATIC MANAGER – Hardware Config

3.2.1. GSD-File

You receive the actual necessary GSD file with the device from Siemens, or over the PNO (Profibus Nutzer Organisation). The following list gives some examples of gsd files.

GSD file name	Module type	Hardware version
Siem80a1.gsd	RS 485 interface	Up to version 3
Siem80bc.gsd	Fibre-optical interface	Up to version 3
Si1_80a1.gsd	RS 485 interface	From version 4
Si1_80bc.gsd	Fibre-optical interface	From version 4

Copy the GSD-Files in the Step7-directory **S7data\Gsd**.

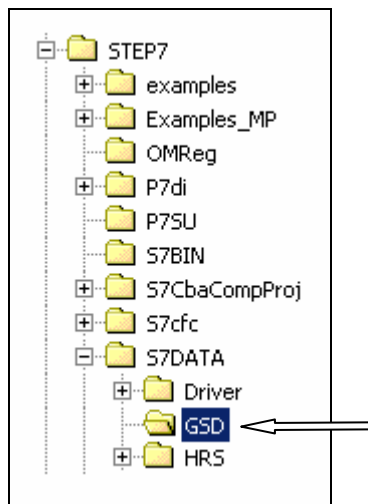

In order to insert the device in the SIMATIC Hardware catalogue (Profibus-DP) in SIMATIC - Manager (Hardware Config), you have to activate in the menu „options“ the following:

‘Options → Update Catalog’

You can also install directly the gs* files by using the “Install new gsd” function.

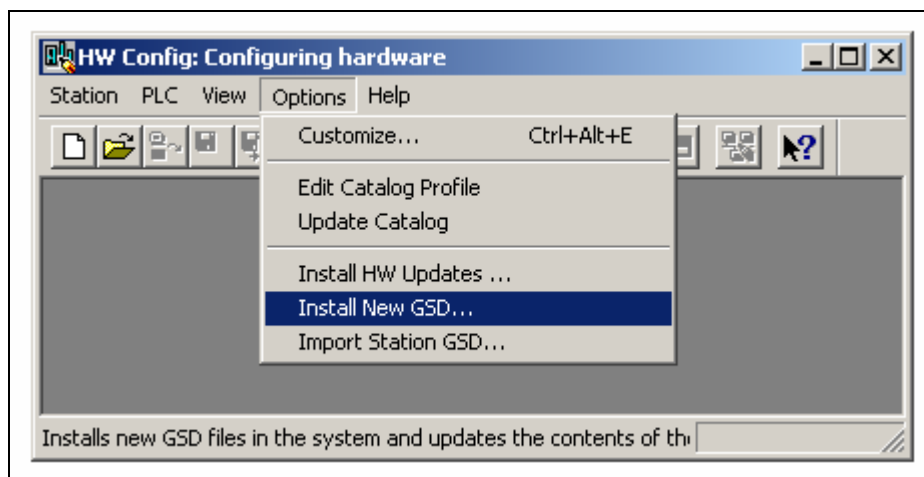

3.2.2. Hardware catalog

To configure the Hardware you have to select the DP slave Siprotec from the folder Siprotec. If an optical fibre module is used, the device as also to be configured with digsi.

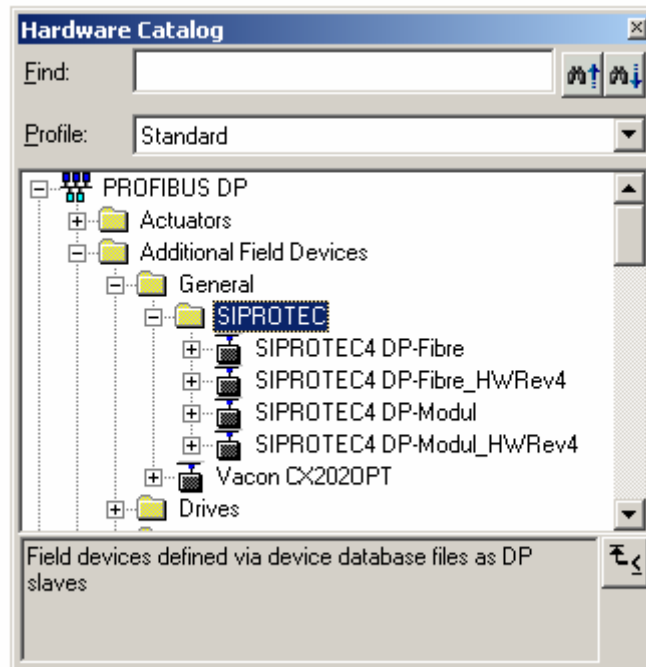

For a redundant system you also need to use the DP/PA link IM 157 with the identification number given previously.

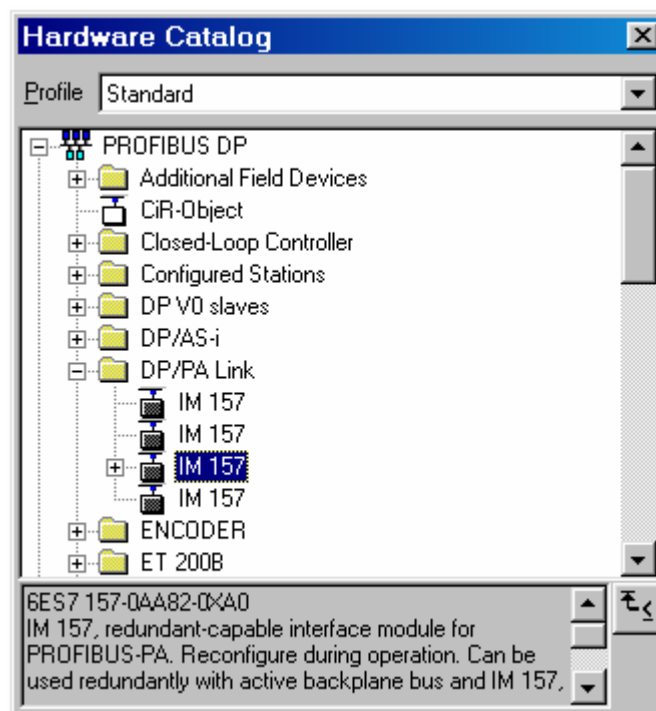

3.2.3. Hardware Configuration

Stand-alone CPU:

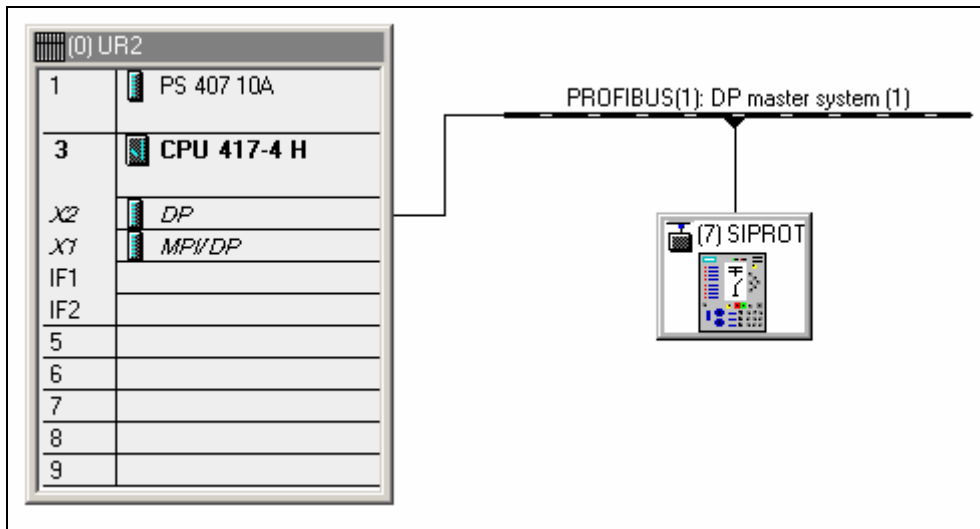

Picture 3-2 HW configuration with one Siprotec device

Redundant System:

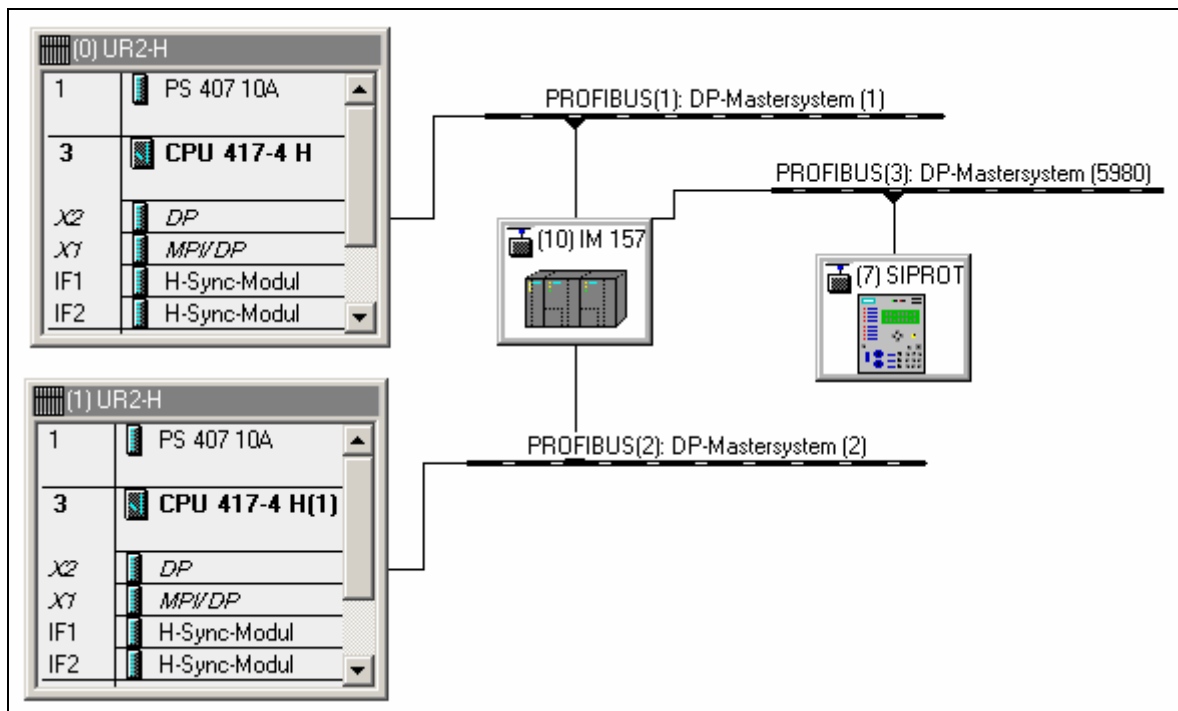

Siprotec device with an H-System

The Profibus DP/PA Link must be configured as DP Master system:

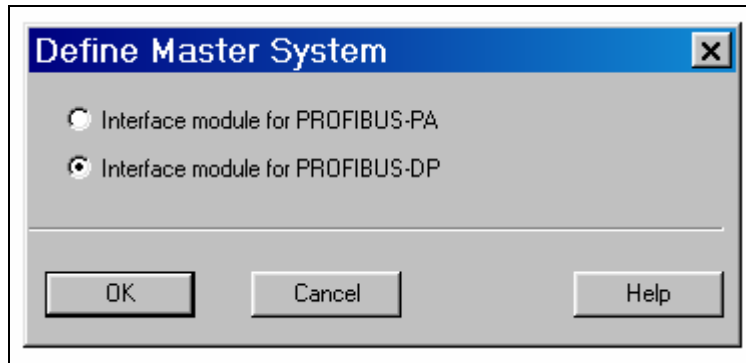

The Profibus Master system (CP or at the CPU) must be configured as DP Master system:

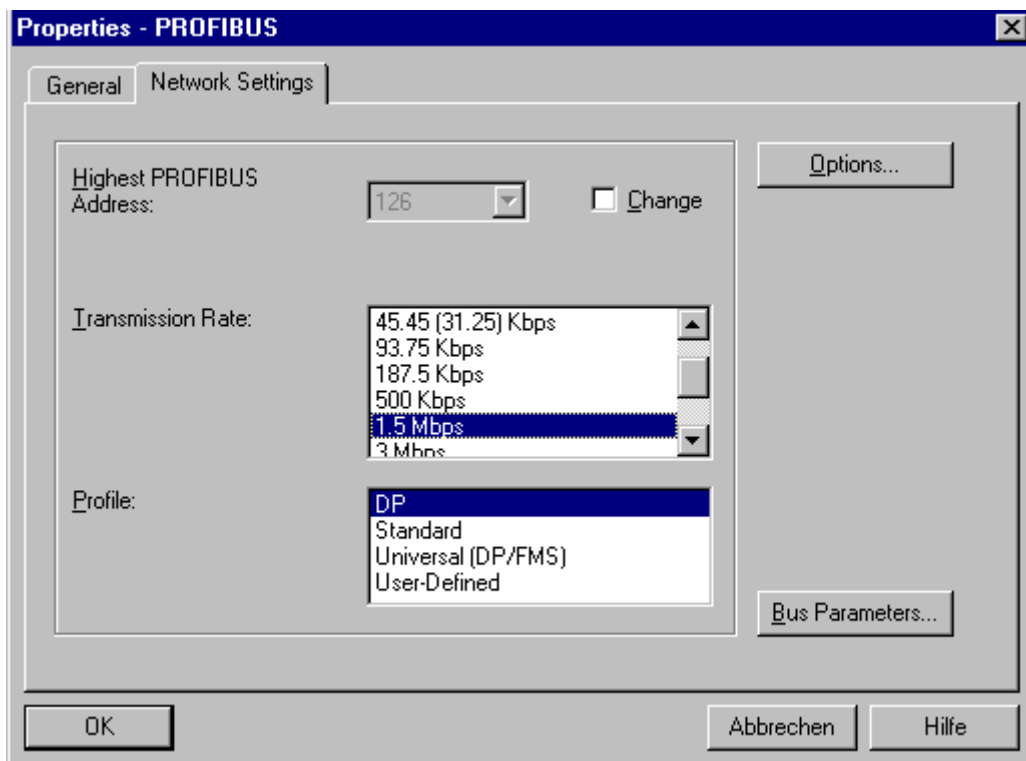

By projection over the DP Master system, you can choose the slave addresses between 3 and 125.



ATTENTION!!

- ***When there are many different devices projected over the DP bus, the devices, which work with the Y-link, have to be addressed first.***
That means that they get the lower addresses.
- The number of slaves that you can project over the DP bus is limited:
 - Up to 64 devices can be connected to the Y-link
 - The total of modules belonging to the devices connected to the Y-link is limited to 236
 - The Profibus telegram supports a maximum of 244 input bytes and 244 output bytes.

By the configuration of the PROFIBUS-DP Slave of the SIPROTEC4-Device, starting point is standard mapping for the device parameterisation:

7SJ6x standard mapping 3-4	Telegram data:
	- 28 Bytes Input - 2 Bytes Output

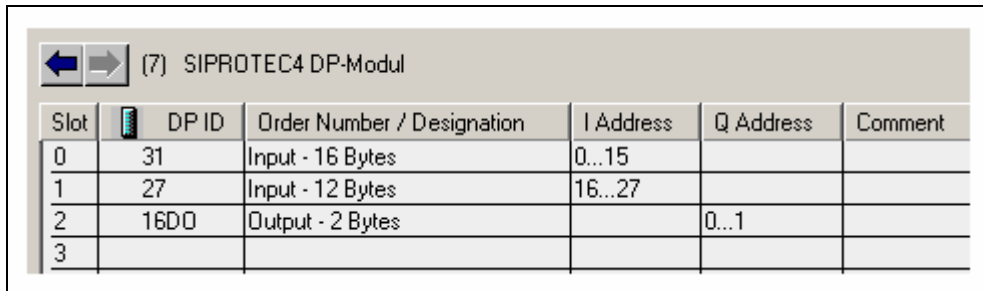

Slot	DP ID	Order Number / Designation	I Address	Q Address	Comment
0	31	Input - 16 Bytes	0...15		
1	27	Input - 12 Bytes	16...27		
2	16DO	Output - 2 Bytes		0...1	
3					

Picture 3-3 Configuration of the Siprotec 4 DP modules for 7SJ6x with mapping 3-4

3.2.4. Project planning tips

Run sequence:

Before to download in the CPU, you have to check the run sequence (see CFC Menu: Edit\Run sequence).

In all OBs (70, 72, 82, 85, 86, 100, 122, cyclic interrupt OB), **Y_S_2** driver block have to be projected at the beginning of the sequence.

The driver blocks of device such as **7SJ6X_M34**,... etc has to be projected after it.

You have also to pay attention to the fact that RACK or SUBNET Block have not to be integrated before.

HKIR:

You have to use CPU Firmware as of 3.0. By HKIR, you have the possibility to erase or to insert slaves over the non redundant bus. For the Y Link, that means a telegram construction change. To be sure that the present slaves won't be disturbed during the HKIR, you can set the input **LGCADRON** to 1 before this action. You have also to check before, that **LGCADR_0**, **LGCADR_1**... match the logical addresses in Hardware Config. You can reset the input **LGCADRON** after the HKIR. In any case, the input **RACK_NO** must be always correctly parameterised, also when **LGCADRON** is switched on (for the diagnosis analysis).

3.3. Device parameterisation multifunction protection relay

To parameterise the device you have to use the software **DIGSI valid from Version 4.21**.

Each device has many possibilities of standard mapping, which provide an assignment of device data object to Profibus DP telegram position. This standard allocation will be changed for the transfer of the measured values over Profibus DP and the display of the FB-Parameter.

The change of the measured value conversion in device (scaling) takes place in DIGSI-Manager \ Parameter \ Assignment in Object properties- Dialog window of the measured value through choice of a scaling index.

The unit of the measured value will be automatically assigned and act by primary values in accordance with the parameterised nominal values of the primary power system (DIGSI: Power system data1 and Power system data 2).

Attention: After change of bus specific parameters (for example PROFIBUS-DP Slave address) all scaling will be reset to the default values using DIGSI till V4.3.

3.3.1. Parameterisation für 7SJ6x

Starting with standard mapping 3-4 of the device 7SJ6x, the measured values have to be allocated to the target system interface as follow using DIGSI:

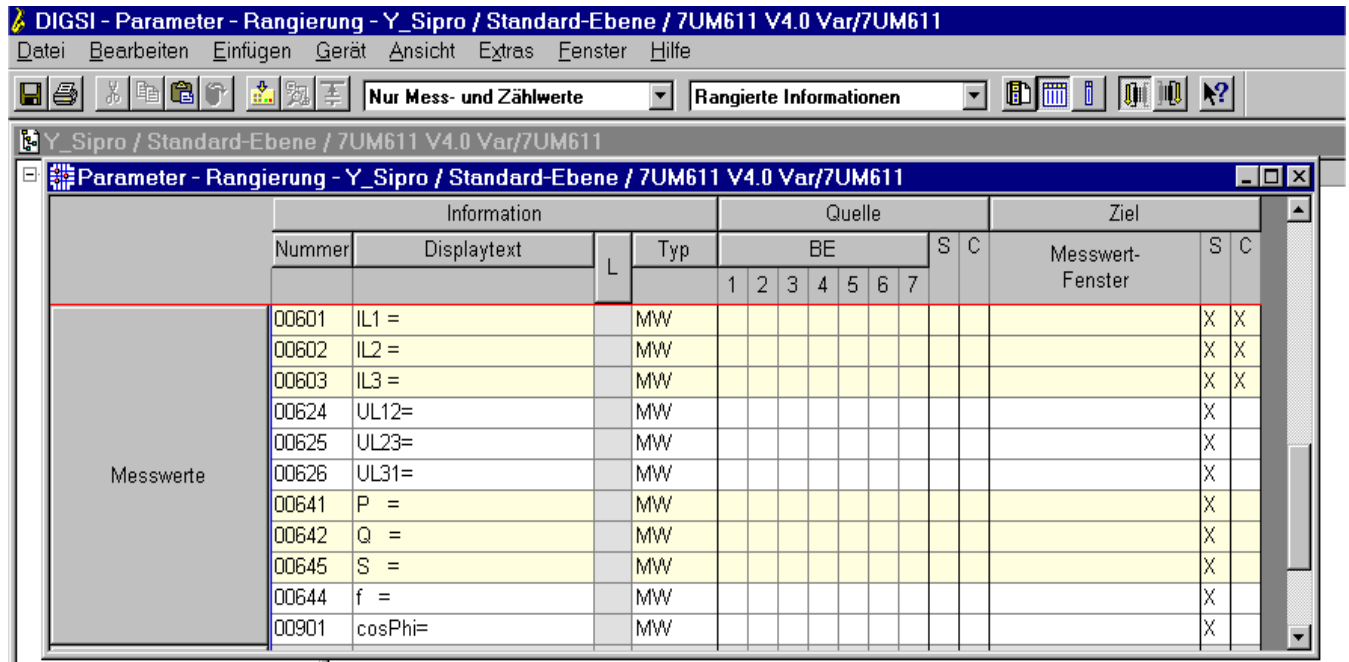

	Information		L	Typ	Quelle							S	C	Ziel		
	Nummer	Displaytext			BE									Messwert-Fenster	S	C
					1	2	3	4	5	6	7					
Messwerte	00601	IL1 =		MW											X	X
	00602	IL2 =		MW											X	X
	00603	IL3 =		MW											X	X
	00624	UL12=		MW											X	
	00625	UL23=		MW											X	
	00626	UL31=		MW											X	
	00641	P =		MW											X	
	00642	Q =		MW											X	
	00645	S =		MW											X	
	00644	f =		MW											X	
	00901	cosPhi=		MW											X	

The interface has also to be configured:

- Standard Mapping 3-4
- DP address
- Gsd file (siem80a1 -> PNO = 0x80A1)
- Other settings (for optical fibre module)

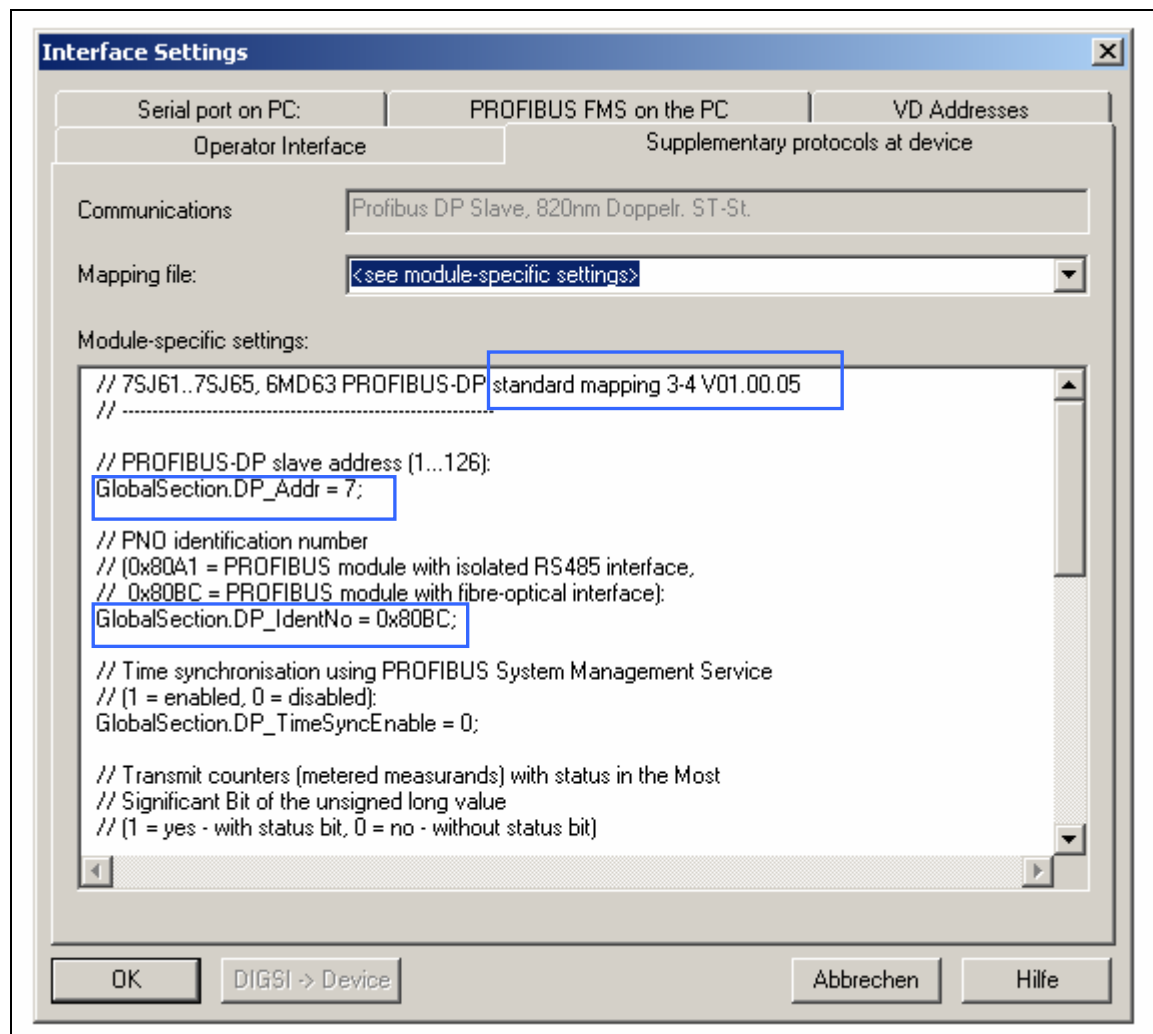

3.3.2. Messages structures with the Mapping 3-4

Messages in output directions: Function Block ⇒ Device

Double commands / Single commands / internal commands / User defined commands or taggings

Offset	Designation of the Siprotec objects	Comments	Internal Object No
0 / 0	52Breaker OFF	52 breaker	-
0 / 1	52Breaker ON		
0 / 2	Disc.Swit. OFF	Disconnect Switch	-
0 / 3	Disc.Swit. ON		
0 / 4	GndSwit. OFF	Ground Switch	-
0 / 5	GndSwit. ON		
0 / 6	<user-defined> OFF	Not pre-allocated	-
0 / 7	<user-defined> ON		
1 / 0	Group A	Activation of setting group A	-
1 / 1	Group A		
1 / 2	Group B	Activation of setting group B	-
1 / 3	Group B		
1 / 4	<user-defined> OFF	Not pre-allocated	-
1 / 5	<user-defined> ON		
1 / 6	<user-defined> OFF	Not pre-allocated	-
1 / 7	<user-defined> ON		

Messages in input direction: Device ⇒ Function Block

Double point indications / User-defined single-point indications or taggings

Offset	Designation of the Siprotec objects	Comments	Internal Object No
0 / 0	52Breaker OFF	Checkback indication 52 breaker	-
0 / 1	52Breaker ON		
0 / 2	Disc.Swit. OFF	Checkback indication Disconnect Switch	-
0 / 3	Disc.Swit. ON		
0 / 4	GndSwit. OFF	Checkback indication Ground Switch	-
0 / 5	GndSwit. ON		
0 / 6	<user-defined>	Not pre-allocated	-
0 / 7	<user-defined>	Not pre-allocated	-
1 / 0	<user-defined>	Not pre-allocated	-
1 / 1	<user-defined>	Not pre-allocated	-
1 / 2	<user-defined>	Not pre-allocated	-
1 / 3	<user-defined>	Not pre-allocated	-
1 / 4	<user-defined>	Not pre-allocated	-
1 / 5	<user-defined>	Not pre-allocated	-
1 / 6	<user-defined>	Not pre-allocated	-
1 / 7	<user-defined>	Not pre-allocated	-

Protection Status / Diagnosis

Offset	Designation of the Siprotec objects	Comments	Internal Object No
2 / 0	50-2 TRIP	1 = 50-2 TRIP	1805
2 / 1	50-1 TRIP	1 = 50-1 TRIP	1815
2 / 2	50Ns-2 TRIP	1 = 50Ns-2 TRIP	1223
2 / 3	50Ns-1 TRIP	1 = 50Ns-1 TRIP	1226
2 / 4	49 Th O/L TRIP	1 = 49 Thermal overload TRIP	1521
2 / 5	49 O/L T° Alarm	1 = 49 Overload alarm! Near thermal TRIP	1516
2 / 6	67-2 TRIP	1 = 67-2 TRIP	2649
2 / 7	67-1 TRIP	1 = 67-1 TRIP	2665
3 / 0	Device OK	1 = Update of the device replica in the Siprotec device completed after initial start or restart	51
3 / 1	ProtActive	1 = At least one protection function is active	52
3 / 2	Settings calc.	1 = Error with a summary alarm ON	70
3 / 3	Error	1 = Alarm summary event ON	140
3 / 4	Warning	1 = Relay PICKUP (summary alarm)	160
3 / 5	Relay Pickup	1 = Relay general Trip command (summary alarm)	501
3 / 6	Relay Trip	1 = Relay GENERAL TRIP command	511
3 / 7	Data valid	1 = data in the Profibus DP message are valid.	-

Measured values / metered measurands

Offset	Designation of the Siprotec objects	Comments	Scaling	Internal Object No
4	Va-b =	Va-b	32767 → 327.67 kV	624
6	Ia =	Ia	32767 → 3276.7 A	601
8	Ib =	Ia	32767 → 3276.7 A	602
10	Ic =	Ia	32767 → 3276.7 A	603
12	INs Reac =	Reactive round current in isol. systems	32767 → 3276.7 A	702
14	P =	P (Active power)	32767 → 327.67 MW	641
16	Q =	Q (Reactive power)	32767 → 327.67 MVAR	642
18	PF =	Power factor	32767 → 3.2767	901
20	WpForward =	Wp Forward (Metered measurand derived from measured value)	2 ³¹ -1 → 2 ³¹ -1 impulses	924
24	WqForward =	Wq Forward (Metered measurand derived from measured value)	2 ³¹ -1 → 2 ³¹ -1 impulses	925

For a complete description of the Mapping 3-4, please refer to the document "Communication module, Profibus DP, Bus mapping" for the Siprotec device 7SJ61..7SJ64.

3.4. WinCC Faceplate

Copy the distributed file **SIP_7SJ6X_M34.OCX** in the folder \<WinNT>\ SYSTEM32 and the WinCC Graphic-Documents „@PG_7SJ6X_M34.PDL” and „@PL_7SJ6X_M34.PDL” in the folder ...\\<project name>\wincproj\<wincproj name>\GraCS.

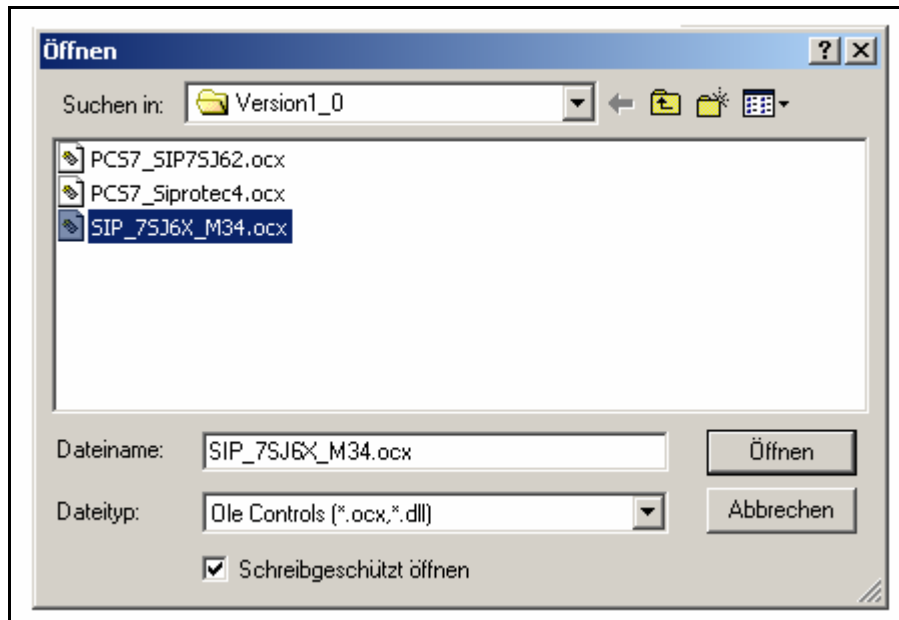

Picture 3-4 Selection of the OCX for Siprotec 7SJ6x Mapping 3-4

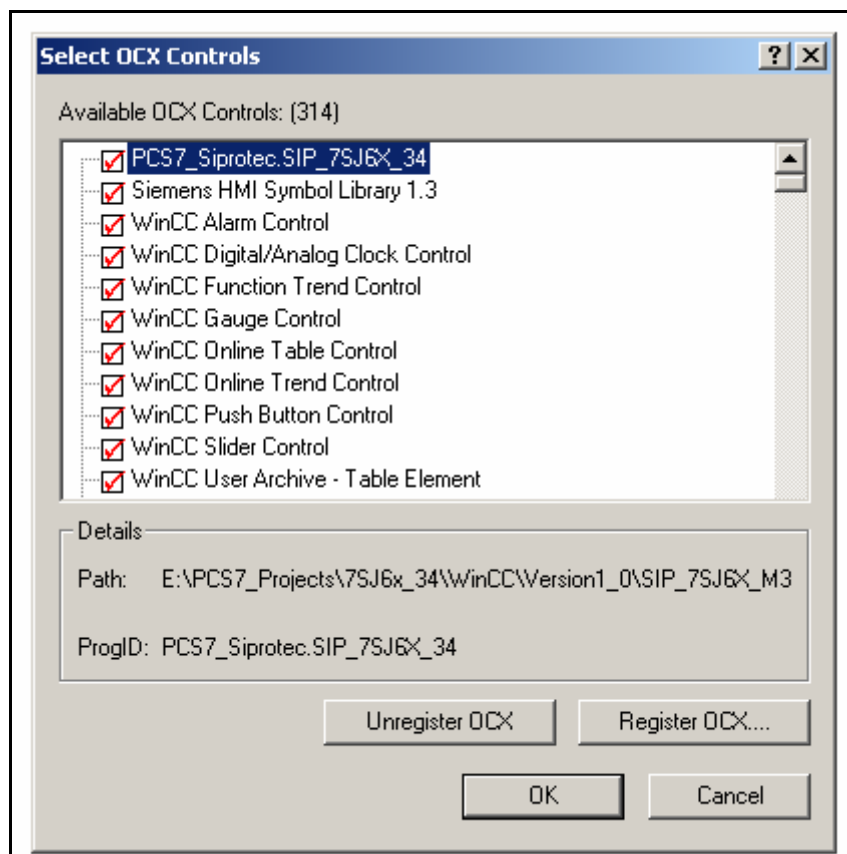

Picture 3-5 Registration of the OCX

The registration of the SIP_7SJ6X_M34.OCX is to be made in the WinCC Graphics Designer. After the SIP_7SJ6X_M34.OCX is successfully registered (PCS7_Siprotec. SIP_7SJ6X_M34) and after it is built in a process image, you start a dynamic wizard to connect the OCX with a structure/instance name. After you placed the faceplate, open the Property Page of the Siprotec 7SJ6x Mapping 3-4 faceplate with a double-click.

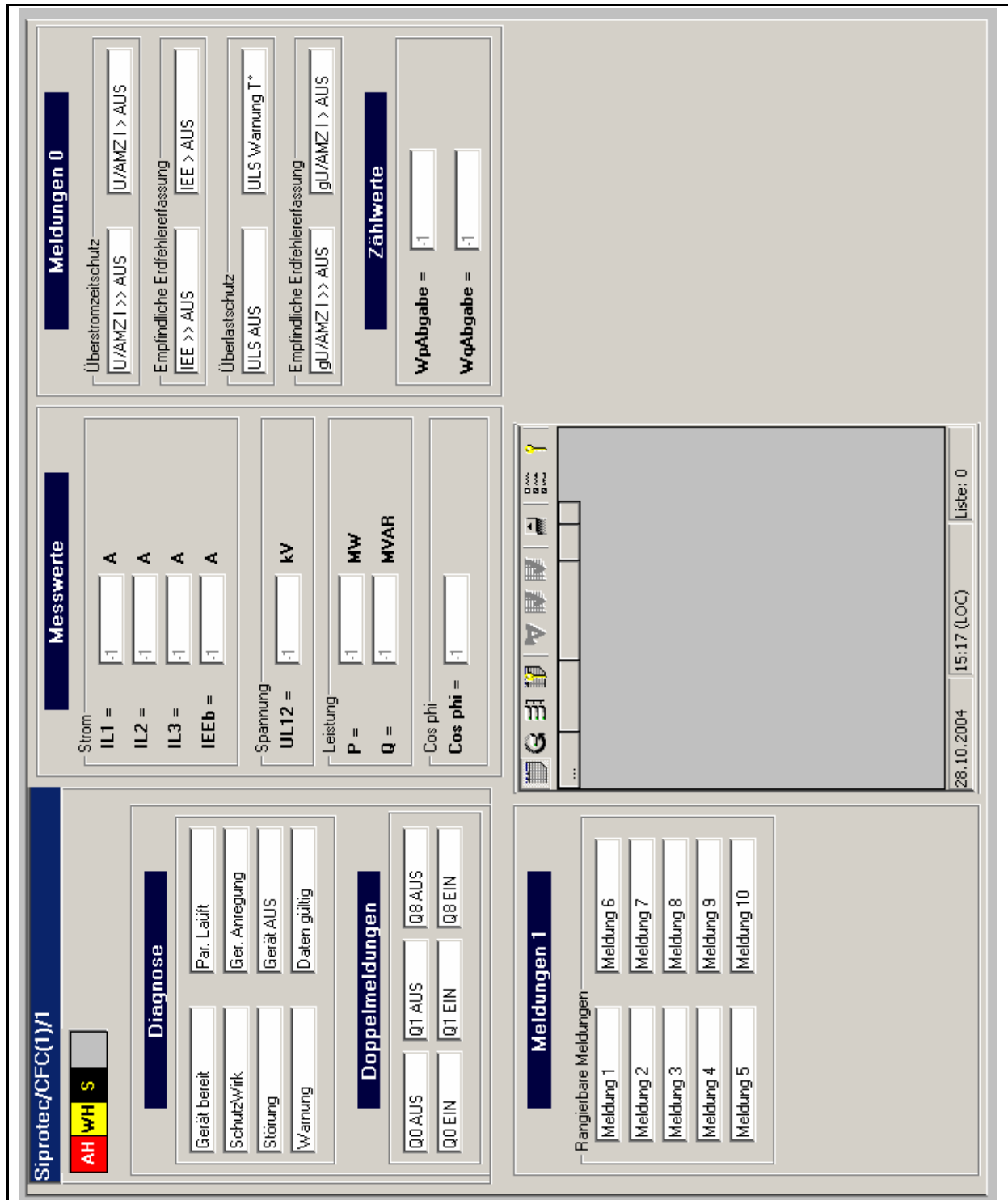

Picture 3-6 Loop view of the faceplate

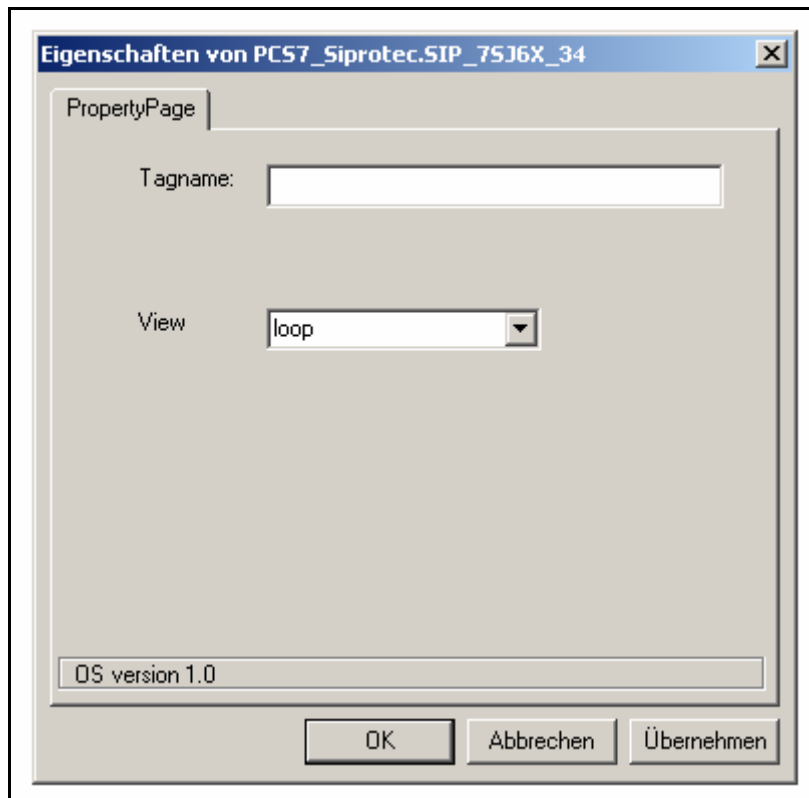

Picture 3-7 Properties window of the OCX

With the setting „view“ you chose between faceplate, symbol or loop view.

3.4.1. Setting the Faceplate in the Graphics Designer

If the faceplate is placed directly in a graphics designer picture and if you want to change in the faceplate to the Loop-view (if you click on the Loop-button during the WinCC-Runtime) the following steps are necessary:

- open „Properties“ of the Faceplate (right mouse click on the faceplate → Properties)
- click in the window „Object Properties“ in the shape „Events“ onto „Object Events“
- Insert in „Execute in the case of ShowKreisbild“ the following bold printed part into the C-Action:

```

#include "apdefap.h"
void ShowKreisbild(char* IpszPictureName, char* IpszObjectName , char* PIC_0, char*
TAG_0)
{
// WINCC:TAGNAME_SECTION_START
// syntax: #define TagNameInAction "DMTagName"
// next TagID : 1
// WINCC:TAGNAME_SECTION_END

// WINCC:PICNAME_SECTION_START
// syntax: #define PicNameInAction "PictureName"
// next PicID : 1
// WINCC:PICNAME_SECTION_END

#pragma code("ssmrt.dll")
#include "ssmrt.h"
#pragma code()
CMN_ERROR Err;
char szReturnPath[_MAX_PATH] = "";
if (SSMRTOpenTopField2 (
SSMGetScreen(IpszPictureName),PIC_0,
TOP_ATTACHTOWORKFIELD,
szReturnPath, sizeof(szReturnPath),
&Err) != FALSE)
{
SetFaceplateTagName(szReturnPath, "@Faceplate",TAG_0);
}
}
    
```

Is the Faceplate to be opened with a button for example, you can use the wizard "Picture selection via measurement point" to create this function.

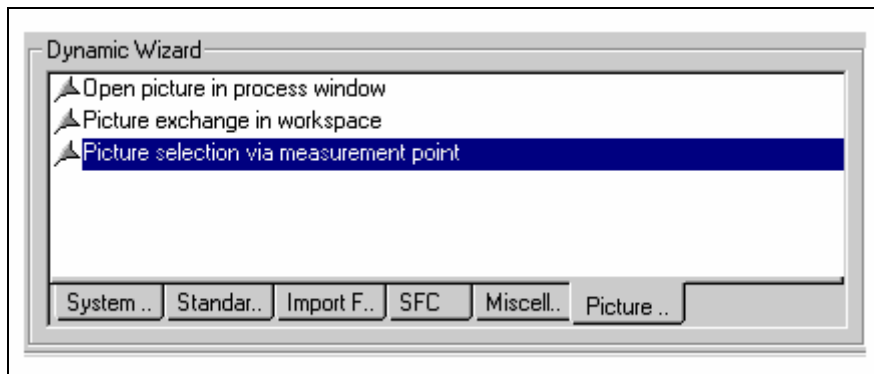

Picture 3-8 Wizard "Picture selection via measurement point"

This wizard is made of 5 steps. In the third step, you have to choose the structure that will be called (in this case 7SJ6X_M34). In the 4th step, you have to choose the measurement point (instance), and the display type (Group Display, Loop Display).

In the case of a Group Display the picture @PG_7SJ6X_M34.pdl is needed and will be opened when you press the button. The Loop-View can be opened directly from the Loop-Button in the faceplate, because the C-Action is already included in the Object Event "ShowKreisbild" of the picture "@PG_7SJ6X_M34.PDL".

3.4.2. Languages

The faceplate is compatible with the following languages:

- German (default)
- English

3.4.3. Clients-server or stand-alone projects

The faceplate is designed for stand-alone projects as well as clients-server projects.

Remark: on the OS client side, the tag names are displayed without servers prefixes.

3.4.4. View: Standard

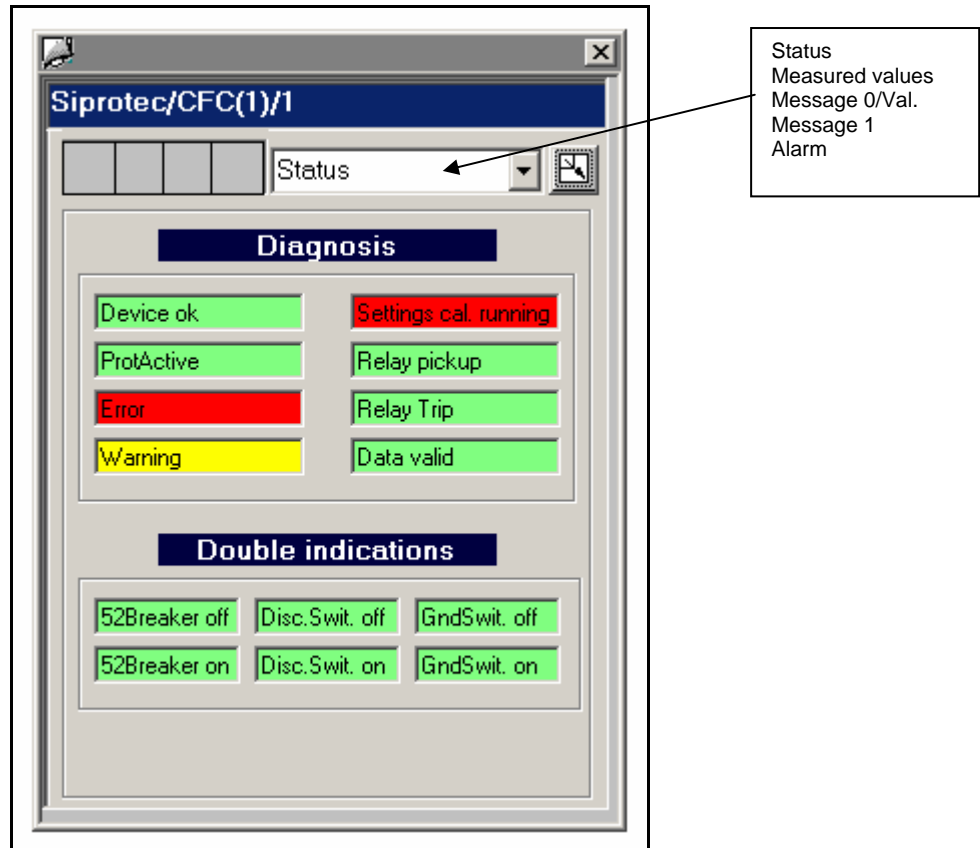

Picture 3-9 OCX view: status

The different status are displayed here with the status value = 1. Otherwise, if the status value is 0 , the color of the status box is grey.

The diagnosis information correspond to the diagnosis (Offset 3/0 to 3/7) of the device.

The double point indications correspond to the annunciations (Offset 0/0 to 0/5) of the device.

Element	Block parameter	
	read	
Device OK	QMSG_1	Byte 1 / Bit 0
ProtActive	QMSG_1	Byte 1 / Bit 1
Settings calc. Running	QMSG_1	Byte 1 / Bit 2
Error	QMSG_1	Byte 1 / Bit 3
Warning	QMSG_1	Byte 1 / Bit 4
Relay Pickup	QMSG_1	Byte 1 / Bit 5
Relay Trip	QMSG_1	Byte 1 / Bit 6
Data valid	QMSG_1	Byte 1 / Bit 7
52Breaker off	QMSG_0	Byte 0 / Bit 0
52Breaker on	QMSG_0	Byte 0 / Bit 1
Disc. Swit off	QMSG_0	Byte 0 / Bit 2
Disc. Swit on	QMSG_0	Byte 0 / Bit 3
GndSwit off	QMSG_0	Byte 0 / Bit 4
GndSwit on	QMSG_0	Byte 0 / Bit 5

3.4.5. View: Measured values

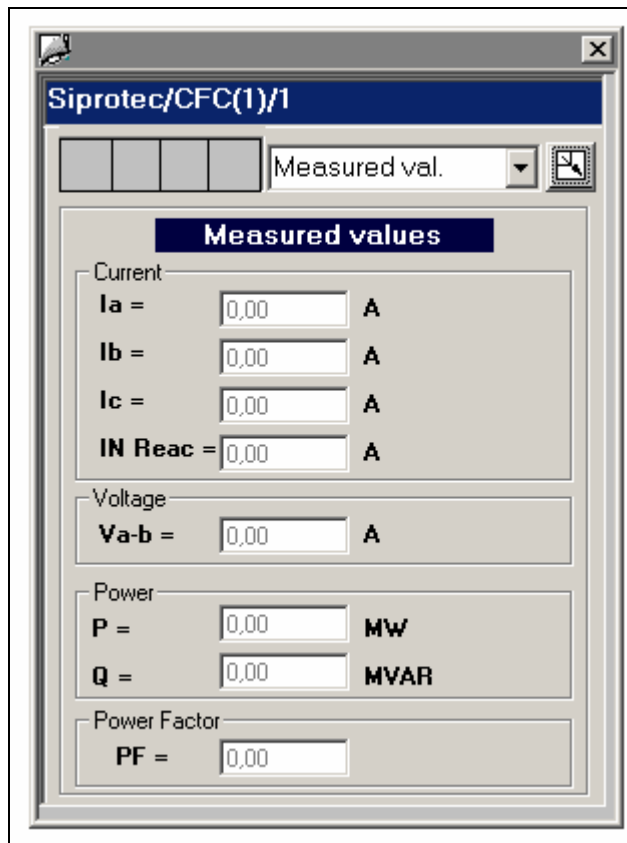

Picture 3-10 OCX view: Measured values

Element	Comment	Block parameter
		Read
Ia	Ia	IL1
Ib	Ia	IL2
Ic	Ia	IL3
IN Reac	Reactive round current in isol. systems	IE
Va-b	Va-b	UL12
P	Active power	P
Q	Reactive power	Q
PF	Power factor	Cosphi

3.4.6. View: Messages 0 / Metered measurands

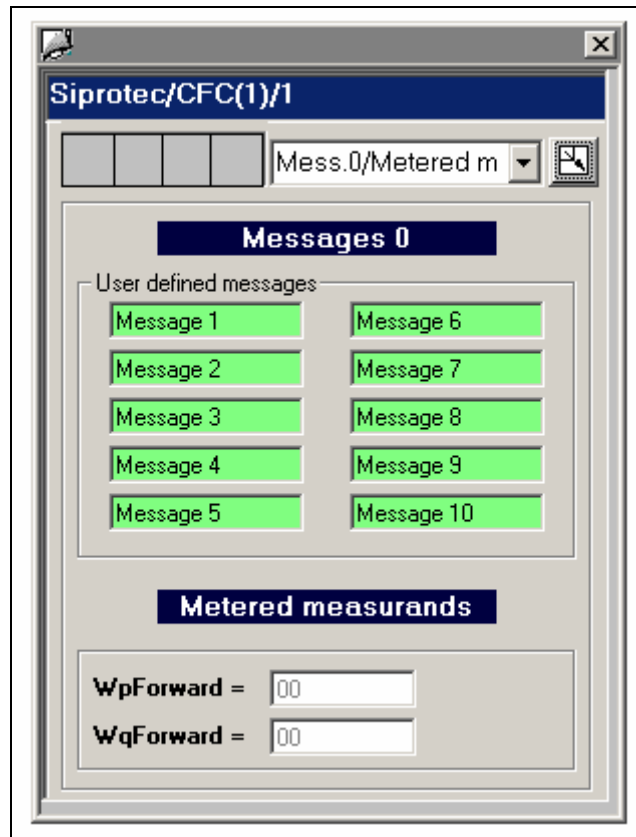

Picture 3-11 OCX view: Messages 0 / Metered measurands

Element	Block parameter	
	read	
Message 1	QMSG_0	Byte 0 / Bit 6
Message 2	QMSG_0	Byte 0 / Bit 7
Message 3	QMSG_0	Byte 1 / Bit 0
Message 4	QMSG_0	Byte 1 / Bit 1
Message 5	QMSG_0	Byte 1 / Bit 2
Message 6	QMSG_0	Byte 1 / Bit 3
Message 7	QMSG_0	Byte 1 / Bit 4
Message 8	QMSG_0	Byte 1 / Bit 5
Message 9	QMSG_0	Byte 1 / Bit 6
Message 10	QMSG_0	Byte 1 / Bit 7
WpForward	WpAbgabe	
WqForward	WqAbgabe	

The messages 1 to 10 correspond to the user-defined single-point indications (or taggings) with the offset 0/6 to 1/7.

If the value of the indication is 1, the background of the status box is green otherwise grey.

3.4.7. View: Messages 1

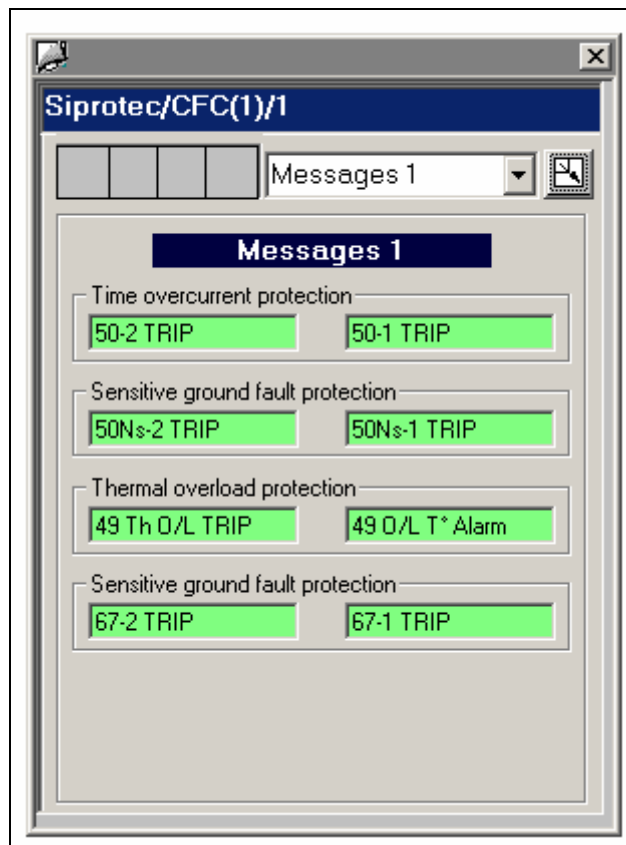

Picture 3-12 OCX view: Messages 1

Element	Block parameter read	
50-2 TRIP	QMSG_1	Byte 0 / Bit 0
50-1 TRIP	QMSG_1	Byte 0 / Bit 1
50Ns-2 TRIP	QMSG_1	Byte 0 / Bit 2
50Ns-1 TRIP	QMSG_1	Byte 0 / Bit 3
49 Th O/L TRIP	QMSG_1	Byte 0 / Bit 4
49 O/L T° Alarm	QMSG_1	Byte 0 / Bit 5
67-2 TRIP	QMSG_1	Byte 0 / Bit 6
67-1 TRIP	QMSG_1	Byte 0 / Bit 7

3.4.8. View: WinCC Alarms

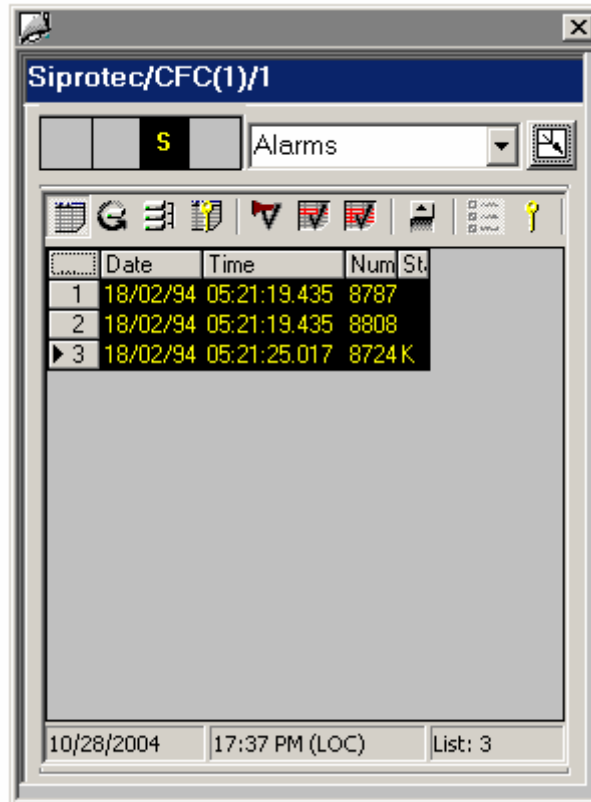

Picture 3-13 OCX view: WinCC alarms

4. Description of the function blocks

4.1. Function block Y_S_2

Type / Number FB 452

4.1.1. CFC Representation

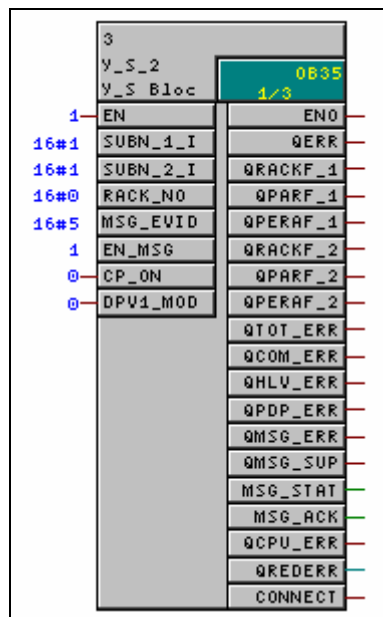

4.1.2. Function and Operating principle

The function block **Y_S_2** forms the interface between the Y-link also known as Y-Switch (2 DP/PA Links + Y-Coupler) and the blocks of the SIMATIC PCS7 libraries. It also can be interconnected with other SIMATIC S7 blocks.

It can only be used on a SIMATIC S7 with PROFIBUS-DP master properties. Beyond it the CPU must possess the reporting ability with **ALARM_8P**.

For all the devices connected to a Y-link, the associated function blocks have to be connected via the output **RACK_CONNECT** to the **Y_S_2** block with the input **CONNECT**.

The inputs **RACK_NO** (Y-link Profibus address), **SUBN_1_ID** (primary DP-Master number) and **SUBN_2_ID** (redundant DP-Master number) must be specified like projected in Hardware Configuration.

The input **CP_ON** must be set to 1, if the PROFIBUS DP connection is realised with CPs (e.g. CP 443-5 Ext.).

With the input **EN_MSG=1** the PLC Process Control Messages will be enabled.

If the DP master is configured with the DP mode "DPv1", the input **DPV1_MODE** must be set to 1 otherwise it has to be set to 0.

In addition the function **FC 501** (GET_DBN) have to exist in the block folder of the project.

4.1.3. Calling OBs

The block can be installed alternatively in the following OBs:

- Watchdog interrupt OB: e.g. OB35

The block must be installed with the same instance in the following OBs:

- OB70 for Periphery redundancy failure
- OB72 for CPU redundancy failure
- OB82 for diagnosis interrupt recognition
- OB85 for I/O access failure over Process image
- OB86 for rack or line failure recognition
- OB100 for start-up recognition
- OB122 for I/O access error recognition

Caution

The OBs listed in the preceding paragraph must be loaded into the AS, as otherwise the AS will call the respective OB when one of the triggering events occurs, and – if it finds no OB – will switch to STOP. In project design with CFC this is handled automatically, provided you are using **Y_S_2** driver blocks. To ensure that the CPU remains in RUN when one of these events occurs, the local data stacks (priority classes) belonging to the OBs must be increased accordingly (see manual: “System software for S7-300/400, system and standard functions”). These are to be changed in Hardware Config/CPU/Properties/local data. If the local data stack overflows the CPU switches to Stop.

4.1.4. Start-up Characteristics

In cold start/start-up the block determines, on the basis of **SUBN_1_ID** and **RACK_NO** or, in redundancy case, of **SUBN_2_ID** and **RACK_NO**, whether a device with the properties of a Y-Switch is connected to the PROFIBUS-DP. In the event of an error **QPARF_1** or **QPARF_2** is set to 1 (see „Error Handling“).

4.1.5. Error Handling

The block algorithm handles the following cases:

Parameter	Description
QPARF_1 = 1	Parameter setting error primary DP/PA Link. Wrong DP station number (SUBN_1_ID, RACK_NO)
QPARF_2 = 1	Parameter setting error redundant DP/PA Link. Wrong DP-station number (SUBN_2_ID, RACK_NO)
QPERAF_1 = 1	Periphery accesses failure. The block was unable to access primary DP/PA Link.
QPERAF_2 = 1	Periphery accesses failure. The block was unable to access redundant DP/PA Link.
QRACKF_1 = 1	DP device failure. No communication with primary DP/PA Link. Possible causes are: PROFIBUS-DP failed, primary Link failed, not switched on, no link to the PROFIBUS-DP.
QRACKF_2 = 1	DP device failure. No communication with redundant DP/PA Link. Possible causes are: PROFIBUS-DP failed, redundant Link failed, not switched on, no link to the PROFIBUS-DP.
QTOT_ERR = 1	No communication to both DP/PA Links
QHLV_ERR = 1	Start-up delay of IM157 active (no communication)
QPDP_ERR = 1	Missing parameterisation, station unknown (no Communication)
QCOM_ERR = 1	Communication error to at least one station.

Note

In the event of a parameter assignment error or DP device failure, access is no longer made to the belonging DP/PA Link (primary or redundant). After the fault has been rectified, the block automatically resumes communication with DP/PA Link.

4.1.6. Message Characteristics

With the input **EN_MSG=1** you can enable the PLC Process Control Messages. In the table you will find the message texts of the driver block **Y_S_2** and their allocation to the driver block parameters.

Message number	Block parameter	Default message text	Message class
1	QRACKF_1	Comm. Failure primary DP/PA Link	S
2	QRACKF_2	Comm. Failure redundant DP/PA Link	S
3	QPERAF_1	Periph. failure primary DP/PA Link	S
4	QPERAF_2	Periph. failure redundant DP/PA Link	S
5	QPARF_1	Param. failure primary DP/PA Link	S
6	QPARF_2	Param. failure redundant DP/PA Link	S
7	QCOM_ERR	Failure in at least one station	S
8	QTOT_ERR	Comm. Failure primary and redundant DP/PA Link	S

Over the ten associated values of **ALARM_8P** the three first one are occupied with **SUBN_1_ID**, **SUBN_2_ID** and **RACK_NO**. In associated value 4 the active Subnet number and in associated value 5 the active Rack number are copied. The other associated values are free. The following table presents the allocation of the associated values to the driver block parameters.

Associated value	Block parameter
1	SUBN_1_ID
2	SUBN_2_ID
3	RACK_NO
4	BEGL5 (active Subnet number)
5	BEGL6 (active Rack number)
6	Free
7	Free
8	Free
9	Free
10	Free

4.1.7. I/O list of the Y_S_2 block

Type	I/O Name	Data Type	Default	Comment within Interface
I	SUBN_1_ID	BYTE	1	Subnet ID primary Module
I	RACK_NO	WORD	0	Rack Number Module
I	SUBN_2_ID	BYTE	1	Subnet ID red. Module
I	MSG_EVID	DWORD	2	Message ID
I	EN_MSG	BOOL	1	Enable 1=Alarming
I	CP_ON	BOOL	0	1=Y-Link over CP
I	DPV1_MODE	BOOL	0	1 = DPv1 mode otherwise S7 compatible
O	QERR	BOOL	1	1=Error
O	QMSG_ERR	BOOL	0	ALARM_8P Error
O	QMSG_SUP	BOOL	0	1=Message Suppression active
O	MSG_STAT	WORD	0	ALARM_8P: STATUS Output
O	MSG_ACK	WORD	0	ALARM_8P: ACK_STATE Output
O	QRACKF_1	BOOL	0	1=Rack Failure prim. gateway
O	QPERAF_1	BOOL	0	1=I/O Module Access Failure prim. gateway
O	QPARF_1	BOOL	0	1=Parameter Assignment Error prim. gateway
O	QRACKF_2	BOOL	0	1=Rack Failure red. gateway
O	QPERAF_2	BOOL	0	1=I/O Module Access Failure red. gateway
O	QPARF_2	BOOL	0	1=Parameter Assignment Error red. gateway
O	CONNECT	BOOL	0	Connect to slave
O	QCOM_ERR	BOOL	0	1=Slave Communication failure
O	QHLV_ERR	BOOL	0	1=Delay for active IM157
O	QPDP_ERR	BOOL	0	1=Default parameterisation
O	QCPU_ERR	BOOL	0	1= CPU error
O	QREDERR	INT	0	CPU error code
O	QTOT_ERR	BOOL	0	1=Total failure

4.2. Function block 7SJ6X_M34

Type / Number FB 476

4.2.1. Function

The **7SJ6X_M34** block forms the interface between the Siprotec devices 7SJ6x (i.e. 61, 62, 63, 64) with Mapping 3-4 and the blocks of the SIMATIC PCS7 libraries. It can also be interconnected with other SIMATIC S7 blocks.

It can only be used on one SIMATIC S7 with PROFIBUS-DP master properties. The CPU has to support the ALARM_8P functionalities.

4.2.2. CFC representation

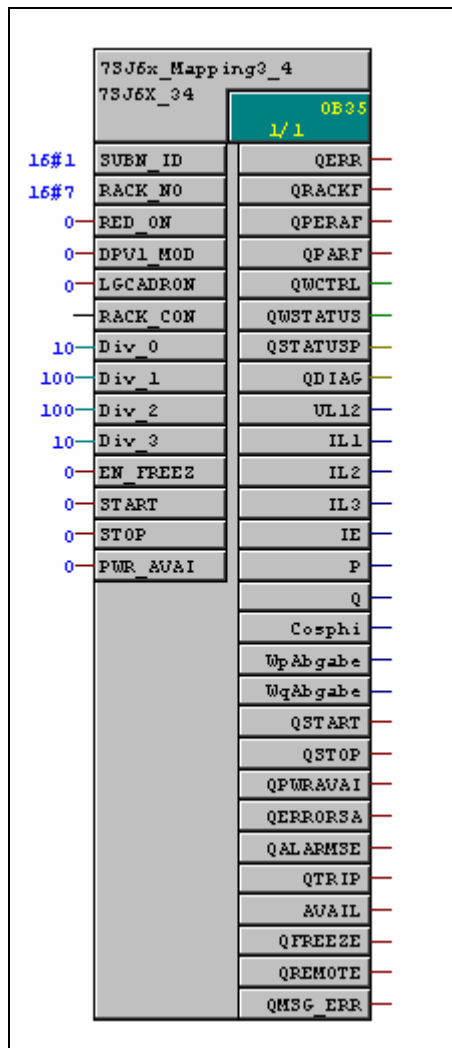

4.2.3. Operating principle

As configured in the HW Config, the Profibus DP address of the device and the Subnet ID must be parameterised over the input parameters **RACK_NO** and **SUBN_ID**.
If the DP master is configured with the DP mode "DPV1", the input **DPV1_MODE** must be set to 1 otherwise it has to be set to 0.

With the input **EN_MSG=1** the PLC Process Control Messages will be enabled.

The block **7SJ6X_M34** can be used redundant (connected to Y Link) or not redundant.

Non-redundant system:

In a non-redundant system **RED_ON** must be set to „0“.

Redundant system:

The input **SUBN_ID** is not active in this configuration.

The input parameter **RACK_CONNECT** has to be connected to the output parameter **CONNECT** of the **Y_S_2** Block.

The output **QRACKF** may be set to 1 if special events occur at the **Y_S_2** block:

- QTOT_ERR = 1 or QPDP_ERR = 1 or QHLV_ERR = 1
- Diagnostics analysis.

You can also choose to give manually the logical addresses for inputs / outputs over the parameters **LGCADR_0**,.... To use this parameter, you have to set **LGCADRON** = 1.



You have to pay attention that all the devices connected to the Y-Switch have their corresponding function blocks 7SJ6X_M34 connected to the Y_S_2 block and are correctly parameterised.

4.2.4. Calling OBs

The block can be installed alternatively in the following OBs:

- Watchdog interrupt OB: e.g. OB35

The block must be installed with the same instance in following OBs:

- OB85 for priority class error
- OB86 for rack or line failure recognition
- OB100 for start-up recognition
- OB122 for I/O access error recognition

Caution

The OBs listed in the preceding paragraph must be loaded into the AS, as otherwise the AS will call the respective OB when one of the triggering events occurs, and – if it finds no OB – will switch to STOP. In project design with CFC this is handled automatically, provided you are using these blocks. To ensure that the CPU remains in RUN when one of these events occurs, the local data stacks (priority classes) belonging to the OBs must be increased accordingly (see manual: "System software for S7-300/400, system and standard functions"). These are to be changed in Hardware Config/CPU/Properties/local data. If the local data stack overflows the CPU switches to Stop.

4.2.5. Start up characteristics

A distinction is made between:

Cold start

The block is called for the first time from the OB in which it is inserted. The OB in question is usually the one in which the normal process oriented processing occurs (e. g. the wake-up alarm-OB). The block assumes the status corresponding to the input parameters. The values may be pre- assigned (see also I/O strip) or already planned values for which you have set the parameters in the CFC, for example. The cold start characteristics are not described specially, unless the block deviates from this rule.

Start-up

The block is processed once when the CPU is started up. This is achieved by calling the block from a start-up OB (where it is additionally installed automatically via the ES or via the STEP7 manually by you). In this case, the start-up is described.

The block determines, on the basis of **SUBN_ID** and **RACK_NO** (or only of **RACK_NO** in redundant mode), whether a device with the properties of an Siprotec is connected to the Profibus-DP. In the event of an error **QPARF** (and QPARF2 in redundant mode) is set to 1 (see „Error Handling“).

4.2.6. Error handling

You will find the error display in the ES CFC plan on the Boolean block output ENO. The value corresponds to the BIE (binary result in STEP 7- AWL after termination of the block) or the OK bit (in SCL format) and signifies:

- ENO=BIE=OK=1 (TRUE) -> the result of the block is OK.
- ENO=BIE=OK=0 (FALSE) -> the result, or the framework conditions for calculation (e.g. input values, modes etc.) are invalid.

Additionally, for FBs you will find the inverted BIE stored in the output QERR of the instance DB.
 QERR = NOT ENO.

The block algorithm handles the following cases:

Parameter	Description
QPARF = 1	Parameter setting error. If the primary DP station number (SUBN_ID, RACK_NO) is wrong, the output is set equal to 1.
QPARF2 = 1	Parameter setting error. If the redundant DP station number (SUBN_ID2, RACK_NO) is wrong, the output is set equal to 1.
QRACKF = 1	DP device failure. No communication with the device. Causes are: PROFIBUS-DP failed, Device failed, off, no link to PROFIBUS-DP.
QPERAF = 1	Periphery access failure. The block was unable to access the device.

In redundant mode, if **QPARF**= 1 and **QPARF2** = 1, the configuration of the function block is wrong or the **Y_S_2** block is returning a general error.

Note

Access is no longer made to the device in the event of a parameter assignment error or DP device failure. After the fault has been rectified, the block automatically resumes communication with device.

The fault messages of the device must be reset by means of fault acknowledgement.

Diagnostic data relating to fault messages can be read only via the parameter assignment interface.

4.2.7. Message Characteristics

In the table you will find the message texts of the driver block and their allocation to the driver block parameters.

Message No.	Block parameter	Default message text	Message class
1	QRACKF	DP-device failure	S
2	QPARF	Parameter failure	S
3	QPERAF	Access failure	S
4	QERRORSA	Alarm	A
5	QALARMSE	Warning	W

Over the associated values of ALARM_8P are transmitted several data or parameters values which are listed in the following table.

Associated value	Block parameter
1	Act. SUBN_ID
2	Act. RACK_NO

4.2.8. Parameters for Status and control words and bytes

Status words and bytes: Device ⇒ Function Block

Parameter	description	Offset (Siprotec / Mapping 3-4)
QWSTATUS	Annunciations / indications	0 / 0 to 1 / 7
QSTATUSP	Protection status	2 / 0 to 2 / 7
QDIAG	Diagnosis	3 / 0 to 3 / 7

Example of the parameter QDIAG: Diagnosis

Over the status byte **QDIAG** will be displayed the following states:

QDIAG Bit	Designation	Comments	Internal Object No
0	Device OK	1 = Update of the device replica in the Siprotec device completed after initial start or restart	51
1	ProtActive	1 = At least one protection function is active	52
2	Settings Calc.	1 = settings calculation is running	70
3	Error Sum Alarm	1 = Error with a summary alarm ON	140
4	Alarm Sum event	1 = Alarm summary event ON	160
5	Relay PICKUP	1 = Relay PICKUP (summary alarm)	501
6	Relay Trip	1 = Relay general Trip command (summary alarm)	511
7	Data valid	1 = data in the Profibus DP message are valid.	-

Example of the parameter QWSTATUS (byte 0)

Over the status byte **QWSTATUS** will be displayed the following states:

QWSTATUS Bit	Parameter	Designation	Comments
0	Q0_0	52Breaker OFF	Checkback indication 52 breaker
1	Q0_1	52Breaker ON	
2	Q1_0	Disc. Swit. OFF	Checkback indication disconnect Switch
3	Q1_1	Disc. Swit. ON	
4	Q8_0	GndSwit. OFF	Checkback indication ground Switch
5	Q8_1	GndSwit. ON	
6	-	<user-defined>	Not pre-allocated
7	-	<user-defined>	Not pre-allocated

Control word: Function Block ⇒ Device

Parameter	description	Offset (Siprotec / Mapping 3-4)
QWCTRL	Control word	0 / 0 to 1 / 7

QWCTRL Bit	Parameter	Designation	Internal Object No
0	CMD0_OFF	52 breaker	-
1	CMD0_ON		
2	CMD1_OFF	Disconnect Switch	-
3	CMD1_ON		
4	CMD8_OFF	Ground Switch	-
5	CMD8_ON		
6	CMDS_OFF	Single command (User defined) (offset 0/6, 0/7)	-
7	CMDS_ON		
8	CX0_OFF	Internal command (Offset 1/0, 1/1)	-
9	CX0_ON		
10	CX1_OFF	Internal command (Offset 1/2, 1/3)	-
11	CX1_ON		
12	CX2_OFF	User defined Single command (Offset 1/4, 1/5)	-
13	CX2_ON		
14	CX3_OFF	User defined Single command (Offset 1/6, 1/7)	-
16	CX3_ON		

4.2.9. Scaling of measured values and divisors

Measured values are transferred via PROFIBUS-DP between the SIPROTEC device and the PROFIBUS-DP master as integer values (two bytes) but they are in general available in the SIPROTEC device in floating-point format as a percent-age referred to the parameterised nominal values of the primary equipment. The scaling factor you choose via the **DIGSI-Manager**.

The measured value in the SIPROTEC device (floating-point format) is multiplied by the scaling factor before transformation to an integer value (for PROFIBUS-DP). It is possible to transfer fractional digits by multiplication by a multiple of 10 in the integer value with that.

(Manual „SIPROTEC Communication module, PROFIBUS-DP - Communication profile“)

With the FB inputs „divisors“ you fit the measured value representation at the FB outputs as requested:

- Div_0** : Current (Ia, Ib, Ic i.e. IL1, IL2, IL3)
- Div_1** : Voltage (Va-b i.e. UL12)
- Div_2** : Power (P, Q,)
- Div_3** : Power factor (Cosphi)

4.2.10. cos phi

Case EN_ROUND = 1 and Div_3 > 0, the output Cosphi is rounded. This is done to the second position after decimal point.

Example:

Cosphi with EN_ROUND = 0	Cosphi with EN_ROUND = 1
0,9990	1,00
0,9950	1,00
0,9949	0,99
0,9060	0,91

4.2.11. WinCC parameter QMSG_0 and QMSG_1

QMSG_0 (Bit)	Parameter	Parameter bit	Comment
0	QWSTATUS	0	52Breaker OFF
1	QWSTATUS	1	52Breaker ON
2	QWSTATUS	2	Disc.Swit. OFF
3	QWSTATUS	3	Disc.Swit. ON
4	QWSTATUS	4	GndSwit. OFF
5	QWSTATUS	5	GndSwit. ON
6	QWSTATUS	6	<user-defined>
7	QWSTATUS	7	<user-defined>
8	QWSTATUS	8	<user-defined>
9	QWSTATUS	9	<user-defined>
10	QWSTATUS	10	<user-defined>
11	QWSTATUS	11	<user-defined>
12	QWSTATUS	12	<user-defined>
13	QWSTATUS	13	<user-defined>
14	QWSTATUS	14	<user-defined>
15	QWSTATUS	15	<user-defined>

QMSG_1 (Bit)	Parameter	Parameter bit	Comment
0	QSTATUSP	0	50-2 TRIP
1	QSTATUSP	1	50-1 TRIP
2	QSTATUSP	2	50Ns-2 TRIP
3	QSTATUSP	3	50Ns-1 TRIP
4	QSTATUSP	4	49 Th O/L TRIP
5	QSTATUSP	5	49 O/L T° Alarm
6	QSTATUSP	6	67-2 TRIP
7	QSTATUSP	7	67-1 TRIP
8	QDIAG	0	Device OK
9	QDIAG	1	ProtActive
10	QDIAG	2	Settings calc.
11	QDIAG	3	Error
12	QDIAG	4	Warning
13	QDIAG	5	Relay Pickup
14	QDIAG	6	Relay Trip
15	QDIAG	7	Data valid

4.2.12. I/O list of the 7SJ6X_M34

I/O	Parameter	Type	Def. Val.	Comment
I	SUBN_ID	BYTE	1	Subnet-Number Profibus DP
I	RACK_NO	WORD	0	DP slave address of the Siprotec device
I	RED_ON	BOOL	0	1 = Redundancy ON
I	EN_MSG	BOOL	1	1 = Enable Alarming
I	DPV1_MODE	BOOL	1	1 = DPV1, 0 = S7 compatible
I	LGCADRON	BOOL	0	1 = Logical address ON (only by red.)
I	RACK_CONNECT	ANY	0	Connect to Y block
I	MSG_EVID	DWORD	0	Message ID
IO	LGCADR_0	INT	0	Logical address for module 0 (only by red.)
IO	LGCADR_1	INT	0	Logical address for module 1 (only by red.)
IO	LGCADR_2	INT	0	Logical address for module 2 (only by red.)
I	Div_0	DINT	10	Divisor 0: Current (Ia, Ib, Ic, IN_Reac)
I	Div_1	DINT	100	Divisor 1: Voltage (Vab)
I	Div_2	DINT	100	Divisor 2: Power (P,Q)
I	Div_3	DINT	10	Divisor 3: Power factor (PF)
I	EN_FREEZE	BOOL	0	1 = Freeze Measurands and messages
I	CMD0_OFF	BOOL	0	1 = 52 Breaker OFF
I	CMD0_ON	BOOL	0	1 = 52 Breaker ON
I	CMD1_OFF	BOOL	0	1 = Disconnect switch OFF
I	CMD1_ON	BOOL	0	1 = Disconnect switch ON
I	CMD8_OFF	BOOL	0	1 = Ground switch OFF
I	CMD8_ON	BOOL	0	1 = Ground switch ON
I	CMDS_OFF	BOOL	0	1 = Single Command OFF
I	CMDS_ON	BOOL	0	1 = Single Command ON
I	CX0_OFF	BOOL	0	1 = Command OFF (User defined or internal command 0)
I	CX0_ON	BOOL	0	1 = Command ON (User defined or internal command 0)
I	CX1_OFF	BOOL	0	1 = Command OFF (User defined or internal command 1)
I	CX1_ON	BOOL	0	1 = Command ON (User defined or internal command 1)
I	CX2_OFF	BOOL	0	1 = Command OFF (User defined or internal command 2)
I	CX2_ON	BOOL	0	1 = Command ON (User defined or internal command 2)
I	CX3_OFF	BOOL	0	1 = Command OFF (User defined or internal command 3)
I	CX3_ON	BOOL	0	1 = Command ON (User defined or internal command 3)
O	QERR	BOOL	1	1 = Error
O	QRACKF	BOOL	0	1 = Rack Failure
O	QPERAF	BOOL	0	1 = Periphery Access Failure
O	QPARF	BOOL	0	1 = Parameter Assignment Error
O	QPARF2	BOOL	0	1 = Parameter Assignment Error (for redundant bus)
O	QWCTRL	WORD	0	Control word (sent to device)
O	QWSTATUS	WORD	0	Indications/Status (Offset 0/0 to 1/7)
O	QSTATUSP	BYTE	0	Status/Protection (Offset 2/0 to 2/7)
O	QDIAG	BYTE	0	Diagnosis (Offset 3/0 to 3/7)

O	UL12	REAL	0	Va-b
O	IL1	REAL	0	Current Phase Ia
O	IL2	REAL	0	Current Phase Ib
O	IL3	REAL	0	Current Phase Ic
O	IE	REAL	0	Reactive ground current in isol. Systems
O	P	REAL	0	Active power P
O	Q	REAL	0	Reactive power Q
O	Cosphi	REAL	0	Power factor
O	WpAbgabe	REAL	0	Wp forward
O	WqAbgabe	REAL	0	Wq forward
O	Q0_0	BOOL	0	Feedback Q0 OFF
O	Q0_1	BOOL	0	Feedback Q0 ON
O	Q1_0	BOOL	0	Feedback Q1 OFF
O	Q1_1	BOOL	0	Feedback Q1 ON
O	Q8_0	BOOL	0	Feedback Q8 OFF
O	Q8_1	BOOL	0	Feedback Q8 ON
O	QSTART	BOOL	0	1 = Motor Start command
O	QSTOP	BOOL	0	1 = Motor Stop command
O	QPWRAVAIL	BOOL	0	1 = Signal for internal processing within Siprotec
O	QERRORSA	BOOL	0	1 = Error with a summary alarm ON (Error Sum Alarm)
O	QALARMSE	BOOL	0	1 = Alarm summary event ON (Alarm Sum Event)
O	QTRIP	BOOL	0	1 = Circuit breaker tripped (1:Trip, 0:Healthy)
O	AVAIL	BOOL	0	Status of trip circuit supervision (1 = Available)
O	QFREEZE	BOOL	0	1 = Freeze measurands and messages activated
O	QREMOTE	BOOL	0	1 = Remote, 0 = Local
O	QMSG_ERR	BOOL	0	ALARM_8P Error
O	QMSG_SUP	BOOL	0	1 = Message Suppression active
O	QMSG_0	WORD	0	Message word 0 (WinCC)
O	QMSG_1	WORD	0	Message word 1 (WinCC)
O	MSG_STAT	WORD	0	ALARM_8P: STATUS Output
O	MSG_ACK	WORD	0	ALARM_8P: ACK_STATE Output

Further information:

Published by Siemens AG
Date of Print: 16.07.2004
Industrial Solutions and Services
IT Plant Solutions
IT PS 12 P2
Siemensstraße 84
76187 Karlsruhe, Germany
Tel.: +49 (721) 595 6052
Fax: +49 (721) 595 6383
E-Mail: ITPS-Produkte.khe@siemens.com
www.siemens.com/PCS7-Bausteine