



REVISION	DATE	BY	DATE	BY
		DRAWN	08/07/17	CY
		CHEK'D		
		VERIF'D		

Confidential - Property of Siemens Industry, Inc. Building Technologies Division		
CUSTOMER		
ORDER NO.	DWG. NO.	
	1D1Y050BCTP1	SH 1 OF 2

SIEMENS

<p>CATALOG NO. 1D1Y050BCTP1</p> <p>SERIAL NO. SERIES H</p> <p>50 kVA 60 Hz 1 PHASE</p> <p>2.6 % IMP AT 100 °C</p> <p>80 °C RISE °C AVG. AMBIENT</p> <p>220 °C TEMP CLASS °C MAX. AMBIENT</p> <p>PRIMARY (H1 H3 H2 H4) 240X480 V</p> <p>SECONDARY(X4 X2 X3 X1) 120/240 V</p> <p>WINDING MATERIAL CU</p> <p>ENCLOSURE TYPE NEMA-3R WEIGHT 600 LBS</p> <p>ENERGY EFFICIENCY NEMA TP 1-2002</p> <p>SPACINGS BETWEEN ENCLOSURE AND ANY ADJACENT WALL SHALL BE A MINIMUM OF 6 INCHES</p> <p>SUITABLE FOR INDOOR OR OUTDOOR LOCATIONS DO NOT INSTALL IN AREAS ACCESSIBLE TO PUBLIC FOR INSTALLATION SEE INSTRUCTION MANUAL</p> <p>NEMA Class ANN Dry Type Transformer Siemens Industry, Inc. Norcross, GA</p>	<div style="text-align: center; margin-bottom: 10px;">  LR 3902  TP 1-2002 </div> <p>LISTED DISTRIBUTION TRANSFORMER 77US TYPE F E112313</p>
---	---

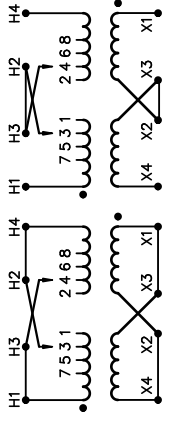

HAM1006

VOLTS	INPUT LINE ON H1 & H4	CONNECT
504	H2-1, H3-2	CONNECT
492	H3-2, H2-3	CONNECT H2 TO H3 FOR SERIES PRIMARY
480	H2-3, H3-4	
468	H3-4, H2-5	
456	H2-5, H3-6	
444	H3-6, H2-7	
432	H2-7, H3-8	CONNECT
252	H2-1, H3-2	CONNECT H1 TO H3 AND H2 TO H4 FOR PARALLEL PRIMARY
240	H2-3, H3-4	
228	H2-5, H3-6	
216	H2-7, H3-8	

VOLTS	CONNECT	OUTPUT LINE
120	X1-X3, X2-X4	X1-X4
240	X2-X3	X1-X4
240/120	X2-X3	X1-X2-X4

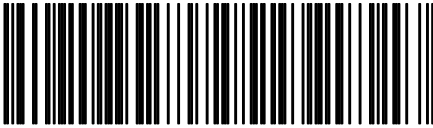

1D1Y050BCTP1

dsu0082e1

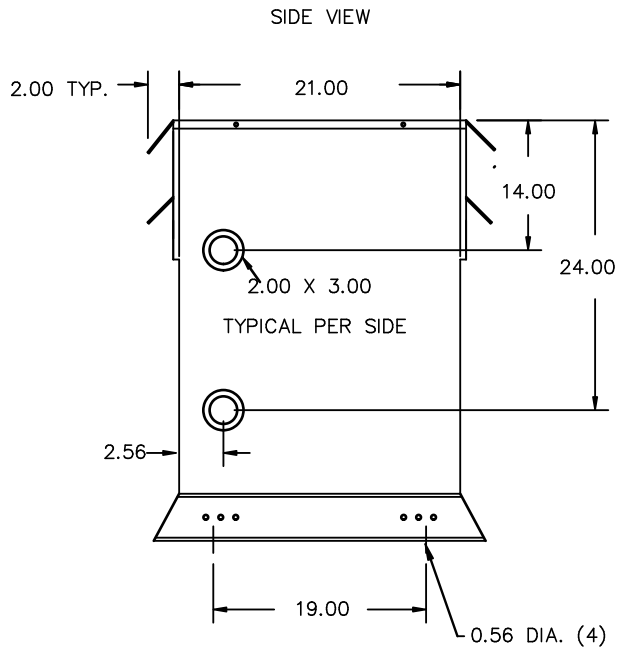
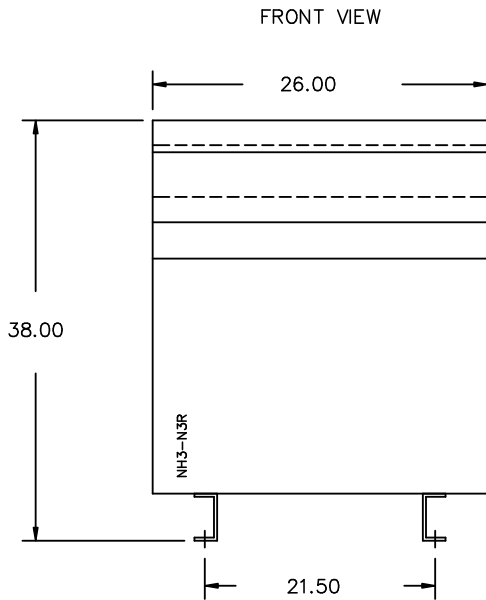

All Dimensions in inches

ENCLOSURE COLOR :ANSI 61 GREY – OUTDOOR

H.V.1. TERMINAL DETAIL

L.V.1. TERMINAL DETAIL

MECHANICAL TYPE LUGS INCLUDED
SUITABLE FOR 350MCM-6 CU/AL
CONDUCTORS
1 CONDUCTOR PER PHASE

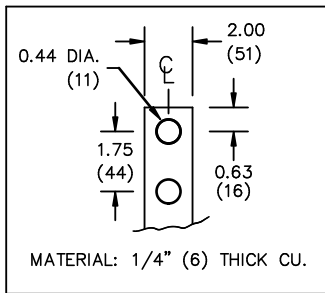

CUSTOMER NOTES:

- HV1 TERMINATED AT TOP FRONT
- LV1 TERMINATED AT BOTTOM FRONT

Confidential – Property of
Siemens Industry, Inc.
Building Technologies Division

REVISION	DATE	BY	DATE	BY
			08/07/17	CY

CUSTOMER	
ORDER NO.	DWG. NO.
	1D1Y050BCTP1