

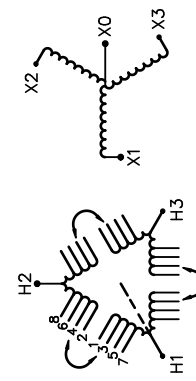

REVISION	DATE	BY	DATE	BY
		DRAWN	16/03/30	PP
		CHEK'D		
		VERIF'D		

Confidential - Property of Siemens Industry, Inc.	
CUSTOMER	
ORDER NO.	DWG. NO.
	3F3Y500FCLN3D16 SH 1 OF 2

SIEMENS

<p>CATALOG NO. 3F3Y500FCLN3D16</p> <p>SERIAL NO. SERIES H</p> <p>500 kVA 60 Hz 3 PHASE</p> <p>5.2 % IMP AT 135 °C</p> <p>115 °C RISE 30 °C AVG. AMBIENT</p> <p>220 °C TEMP CLASS 40 °C MAX. AMBIENT</p> <p>PRIMARY (H1 H2 H3) 480V V 10 kV BIL</p> <p>SECONDARY(X0 X1 X2 X3) 208Y/120V V 10 kV BIL</p> <p>WINDING MATERIAL CU</p> <p>ENCLOSURE TYPE 3R WEIGHT 3050LBS</p> <p>ENERGY EFFICIENCY EXCEEDS CSA C802.2-2012 DOE 10 CFR PART 431:2016</p> <p>SPACINGS BETWEEN ANY VENTILATED ENCLOSURE PANEL AND ANY ADJACENT WALL SHALL BE A MINIMUM OF 12 INCHES</p> <p>SOUND LEVEL IS 3 DB LOWER THAN NEMA ST20 REQUIRMENTS</p> <p>SUITABLE FOR INDOOR OR OUTDOOR LOCATIONS BEFORE HANDLING, INSTALLING AND OPERATING; SEE INSTRUCTION MANUAL</p> <p>NEMA Class ANN Dry Type Transformer Siemens Industry, Inc. Norcross, GA <small>dsu0086e</small></p>	 <p>VOLTS CONNECT</p> <p>504 1-2</p> <p>492 2-3</p> <p>480 3-4</p> <p>468 4-5</p> <p>456 5-6</p> <p>444 6-7</p> <p>432 7-8</p>	<p>TYPE K</p>   <p>DRY TYPE TRANSFORMER</p> <p>SEISMIC QUALIFICATIONS, FLOOR MOUNT ONLY OSP-0136-10 IBC 2012/ASCE 7-10 SDS<=2.0g z/h=1 p=1.5</p>
---	---	---



FRONT VIEW

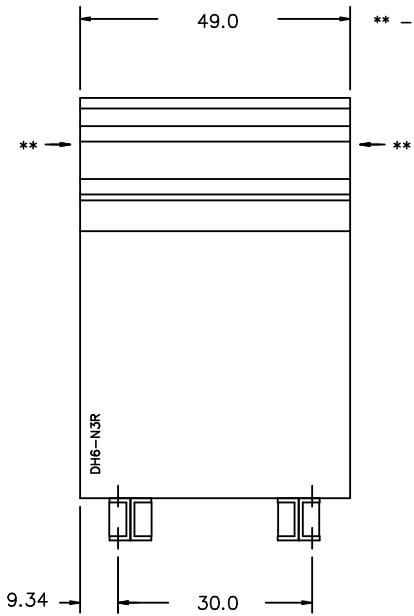

** - Recommended cable entry locations only
cutouts & gland plates not provided.

SIDE VIEW

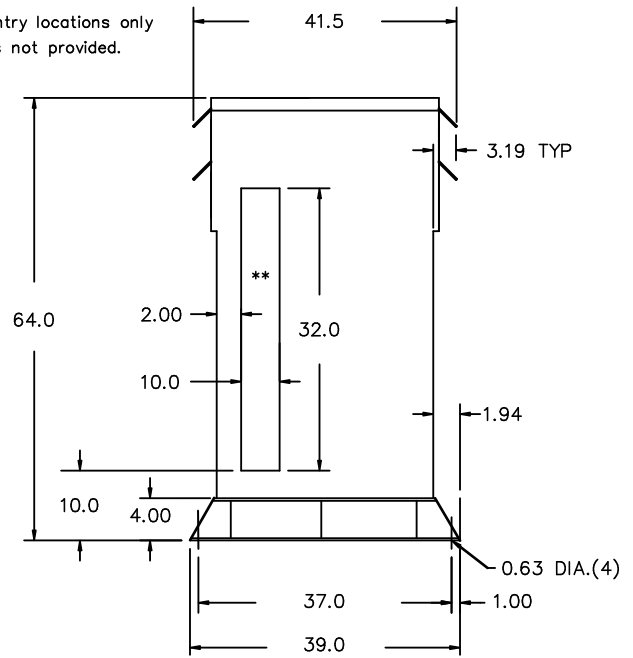

All Dimensions in inches

ENCLOSURE COLOR : ANSI 61 GREY - OUTDOOR

H.V.1. TERMINAL DETAIL

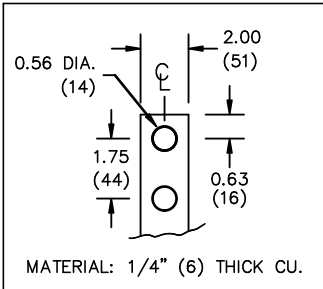

L.V.1. TERMINAL DETAIL

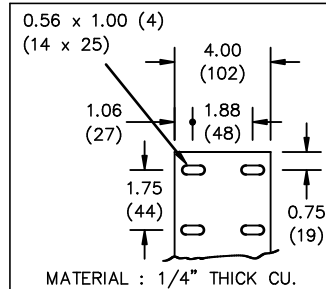

CUSTOMER NOTES:

- HV1 TERMINATED AT TOP FRONT
- LV1 TERMINATED AT BOTTOM FRONT

Confidential - Property of
Siemens Industry, Inc.

REVISION	DATE	BY	DATE	BY
		DRAWN	16/03/30	PP
		CHEK'D		
		VERIF'D		

CUSTOMER	
ORDER NO.	DWG. NO. 3F3Y500FCLN3D16 SH 2 OF 2