

# SITRAIN: Digital Industry Training Academy

South Africa

# Training Portfolio Overview

## Standardized Product-Related Training



Based on products and systems of Sector Industry

## Customer-Tailored Training



Based on customer specific applications and locations

Oriented on different target groups

Focus on hands on training

Worldwide trainer certification and qualification standards

## Consulting and E-learning



Skills Gap Audits –  
Competence development

E-learning offering

## Training Equipment



Based on products and systems of Sector Industry

Designed for optimized learning support

SITRAIN Digital Industry offers you learning paths, courses and certified degrees on the following topics:



**1** Industrial Automation  
Systems SIMATIC

**2** Industrial  
Communications

**3** Operator Control and Monitoring  
Systems SIMATIC HMI

**4** Digital Enterprise

**5** Drive Technology  
SINAMICS

**6** Motion Control

**7** Process Instrumentation

**8** Process Control Systems SIMATIC  
PCS 7 and SIMATIC PCS neo

# 1

## Industrial Automation Systems **SIMATIC**

SIMATIC S7-1500, TIA Portal,  
SIMATIC S7-300/-400, SIMATIC S7-1200





# Latest Automation Systems

## TIA-Portal Software & 1200/1500 PLC's

SIEMENS

TIA Portal

**SIEMENS**  
*Ingenuity for life*



# Latest Automation Systems TIA-Portal Software & 1500 PLC

**SIEMENS**  
*Ingenuity for life*



# Trainings for SIMATIC S7-1500 in the TIA Portal



**SIEMENS**  
Ingenuity for life

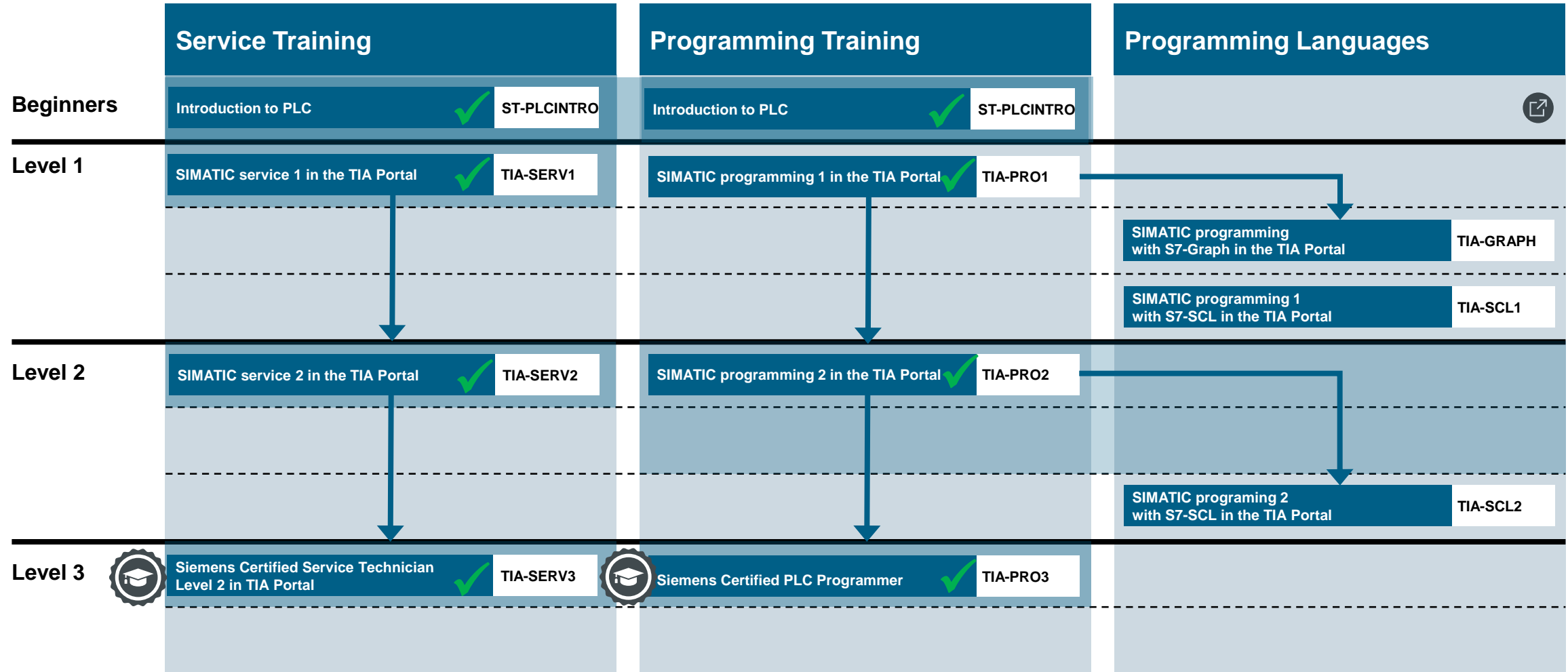



# Latest Automation Systems TIA-Portal Networking

**SIEMENS**  
*Ingenuity for life*

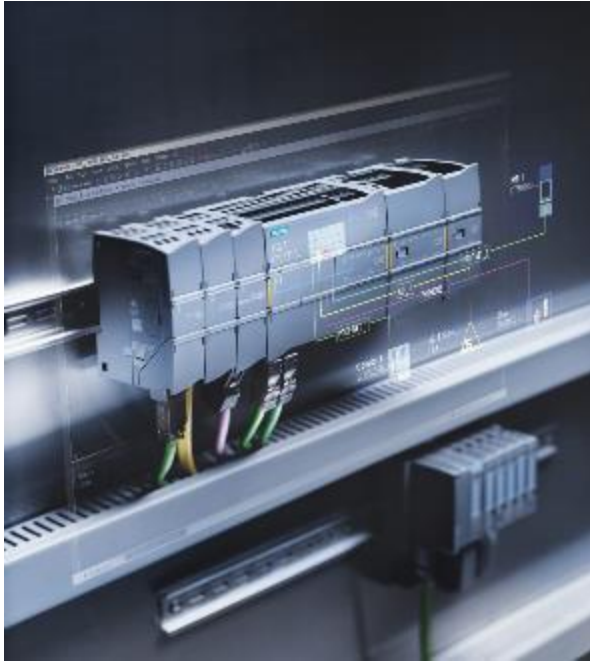



# Trainings for SIMATIC S7-1500 in the TIA Portal



**SIEMENS**  
Ingenuity for Life

	Communication	
Level 1		
	SIMATIC programming 1 in the TIA Portal ✓	TIA-PRO1
	PROFINET with Industrial Ethernet in the TIA Portal ✓	IK-TIAPN
	OPC UA – Basics and Configuration	IK-OPCUA1
Level 2		
Level 3		



The contents of a course in a field with coloured background are recommended requirements for attending the courses connected by arrows.



Courses offered in South Africa

# Latest Automation Systems TIA-WinCC (Operator Panels & SCADA)

**SIEMENS**  
*Ingenuity for life*



# Trainings for SIMATIC S7-1500 in the TIA Portal



**SIEMENS**  
Ingenuity for life

	Operate and Monitoring	
Level 1		
	SIMATIC WinCC SCADA in the TIA Portal	✓ TIA-WCCS
	SIMATIC WinCC on the machine level in the TIA Portal	✓ TIA-WCCM
Level 2		
	SIMATIC WinCC on the machine level in the TIA Portal system course 2	TIA-WCCM2
Level 3		



The contents of a course in a field with coloured background are recommended requirements for attending the courses connected by arrows.

✓ Courses offered in South Africa

# Latest Automation Systems TIA-Portal Motion Control

**SIEMENS**  
*Ingenuity for life*





# Trainings for SIMATIC S7-1500 in the TIA Portal



**SIEMENS**  
*Ingenuity for life*

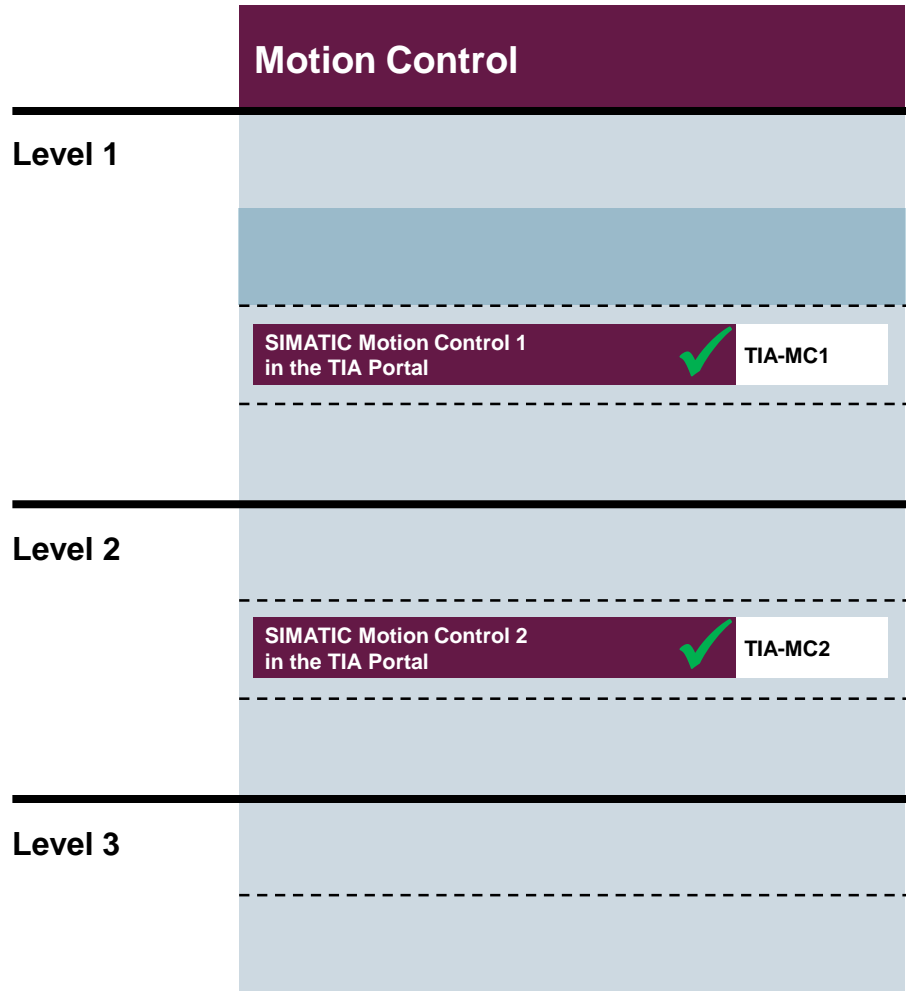

The contents of a course in a field with coloured background are recommended requirements for attending the courses connected by arrows.

 Courses offered in South Africa

# Classic Automation Systems STEP 7 Software & 300/400 PLC's



**SIEMENS**  
*Ingenuity for life*



# Trainings for SIMATIC S7-300/-400 STEP 7 V5.x





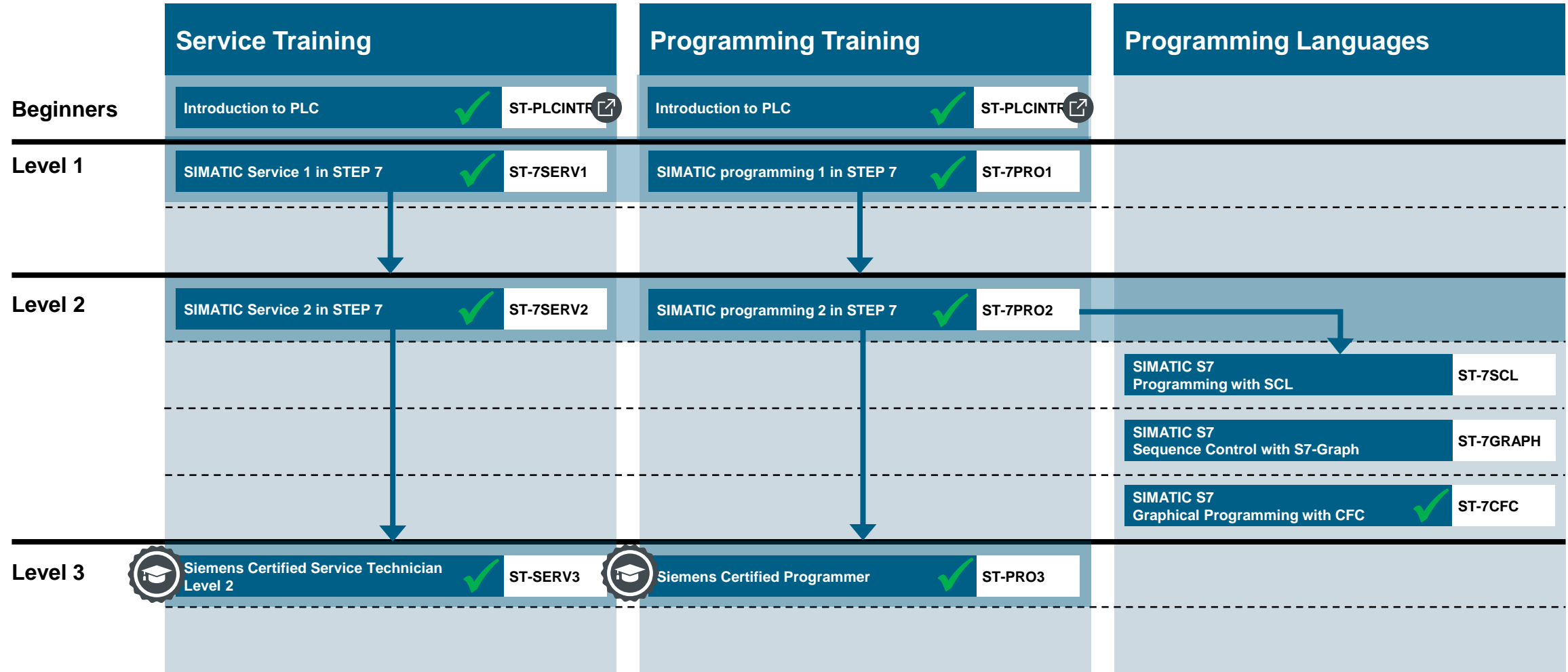

**SIEMENS**  
Ingenuity for life



# Trainings for SIMATIC S7-300/-400 STEP 7 V5.x

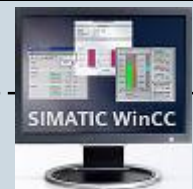

	Communication	Operate and Monitoring	Safety
<b>Beginners</b>	Introduction to Profibus, Profinet and Ethernet ✓ SCT-S7NETSIA		
<b>Level 1</b>	Actuator Sensor Interface Course ✓ IK-ASISYS		
<b>Level 2</b>	SIMATIC programming 2 in Classic STEP7 ✓ ST-7PRO2 PROFINET System Course ✓ ST-ETHERPR PROFIBUS System Course ✓ ST-PRIFIBU	SIMATIC WinCC flexible System Course 1 ✓ ST-WINCCFLEX SIMATIC WinCC System Course ✓ ST-WINCC SIMATIC WinCC flexible System Course 2 ✓ ST-WINCCFLEX ADV	Programming of safety related SIMATIC S7 controller via Distributed Safety ✓ ST-PPDS
<b>Level 3</b>	 	 	



The contents of a course in a field with coloured background are recommended requirements for attending the courses connected by arrows.

✓ Courses offered in South Africa



# Specialized Training Fault Finding and Diagnostics

**SIEMENS**  
*Ingenuity for life*

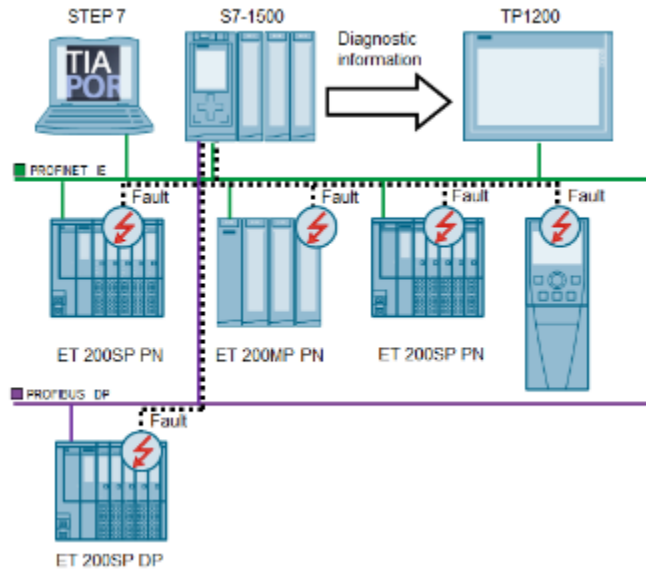

# Trainings focusing on faultfinding and diagnostics

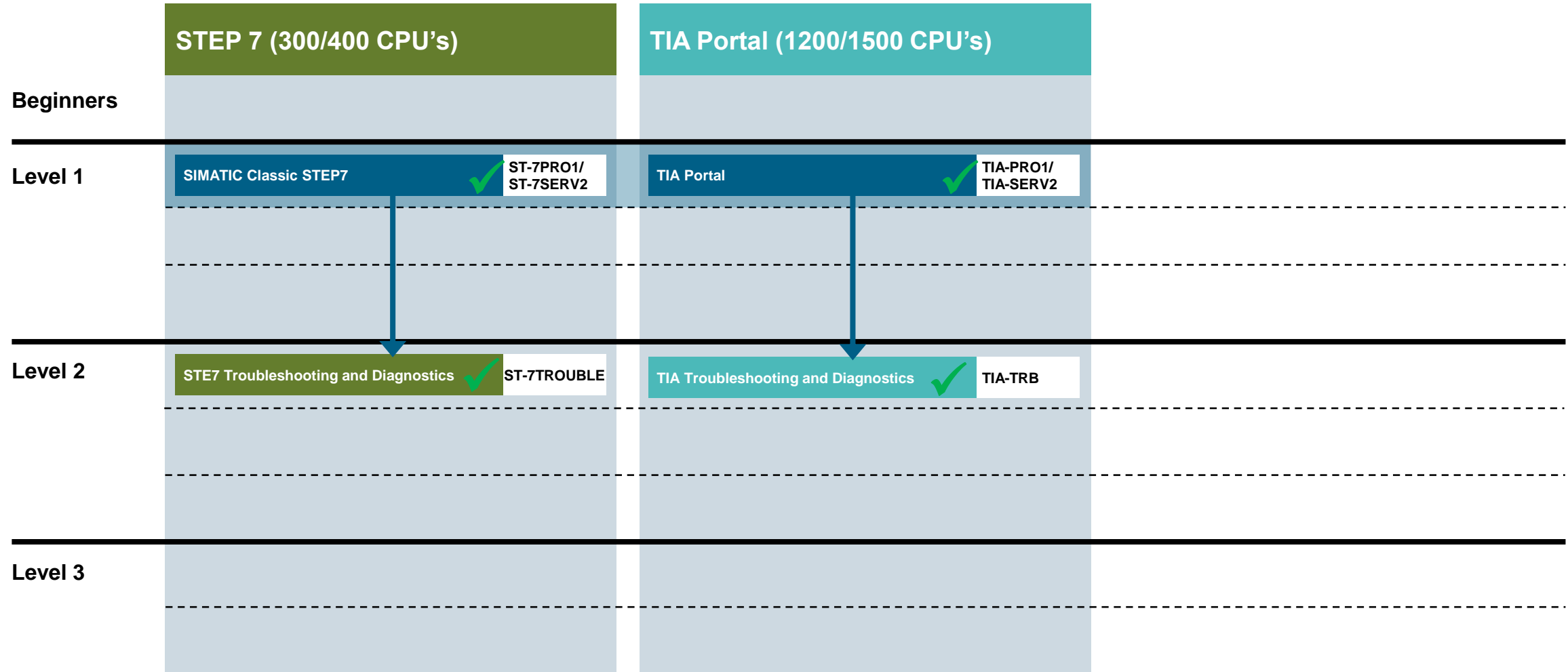

The contents of a course in a field with coloured background are recommended requirements for attending the courses connected by arrows.

Courses offered in South Africa

# Latest Automation Systems TIA-Portal Software & 1200 PLC (Micro Automation)

**SIEMENS**  
*Ingenuity for life*



# Trainings for SIMATIC S7-1200

	Programmers, commissioning engineer, maintenance personnel, operators			
Level 1	<table border="1"><tr><td>SIMATIC S7-1200 Basic Course</td><td>✓</td><td>TIA-MICRO1</td></tr></table>	SIMATIC S7-1200 Basic Course	✓	TIA-MICRO1
SIMATIC S7-1200 Basic Course	✓	TIA-MICRO1		
Level 2	<table border="1"><tr><td>SIMATIC S7-1200 Advanced Course</td><td>✓</td><td>TIA-MICRO2</td></tr></table>	SIMATIC S7-1200 Advanced Course	✓	TIA-MICRO2
SIMATIC S7-1200 Advanced Course	✓	TIA-MICRO2		



**SIEMENS**  
*Ingenuity for life*



# 2

## Industrial Communication

PROFINET, PROFIBUS, Industrial Ethernet,  
OPC and Industrial Remote Communication



# Trainings for Industrial Communication

	PROFINET	PROFIBUS	ASI
<b>Beginners</b>	Introduction to Profibus, Profinet and Ethernet ✓ SCT-S7NETSIA		
<b>Level 1</b>			Actuator Sensor Interface Course ✓ IK-ASISYS
<b>Level 2</b>	PROFINET with Industrial Ethernet in TIA Portal ✓ TIA-PN PROFINET System Course for STEP7 ✓ ST-ETHERPR	PROFIBUS System Course for STEP7 ✓ ST-PROFIBU	



The contents of a course in a field with coloured background are recommended requirements for attending the courses connected by arrows.



Courses offered in South Africa

# Certified Profibus International Courses



	PROFINET		PROFIBUS	
Level 1	Certified Installer ✓ CPN-INS	Certified Installer ✓ CPI-INS		
Level 2	Certified Engineer ✓ CPN-ENG	Certified Installer with Troubleshooting ✓ CPI-INT		
		Certified Installer with Engineer ✓ CPI-INE		





# 3

## Operator Control and Monitoring Systems **SIMATIC HMI**

SIMATIC WinCC in the TIA Portal,  
SIMATIC WinCC V7.x





# Trainings for Operator Control and Monitoring Systems SIMATIC HMI (Operator Panels and SCADA)



	SIMATIC WinCC V7.x	SIMATIC WinCC in the TIA Portal – Machine level	SIMATIC WinCC in the TIA Portal – SCADA
Level 1	SIMATIC programming 1 in STEP 7 ✓ ST-7PRO1	SIMATIC programming 1 in the TIA Portal ✓ TIA-PRO1	SIMATIC programming 1 in the TIA Portal ✓ TIA-PRO1
	SIMATIC WinCC System Course ✓ ST-BWINCCS	SIMATIC WinCC on the machine level in the TIA Portal ✓ TIA-WCCM	SIMATIC WinCC SCADA in the TIA Portal ✓ TIA-WCCS
Level 2		SIMATIC WinCC on the machine level in the TIA Portal System Course 2 TIA-WCCM2	
		SiVArc – Options of Automatic Visualization Generation ✓ TIA-SIVARC	



The contents of a course in a field with coloured background are recommended requirements for attending the courses connected by arrows.

✓ Courses offered in South Africa

# 4

## Digital Enterprise

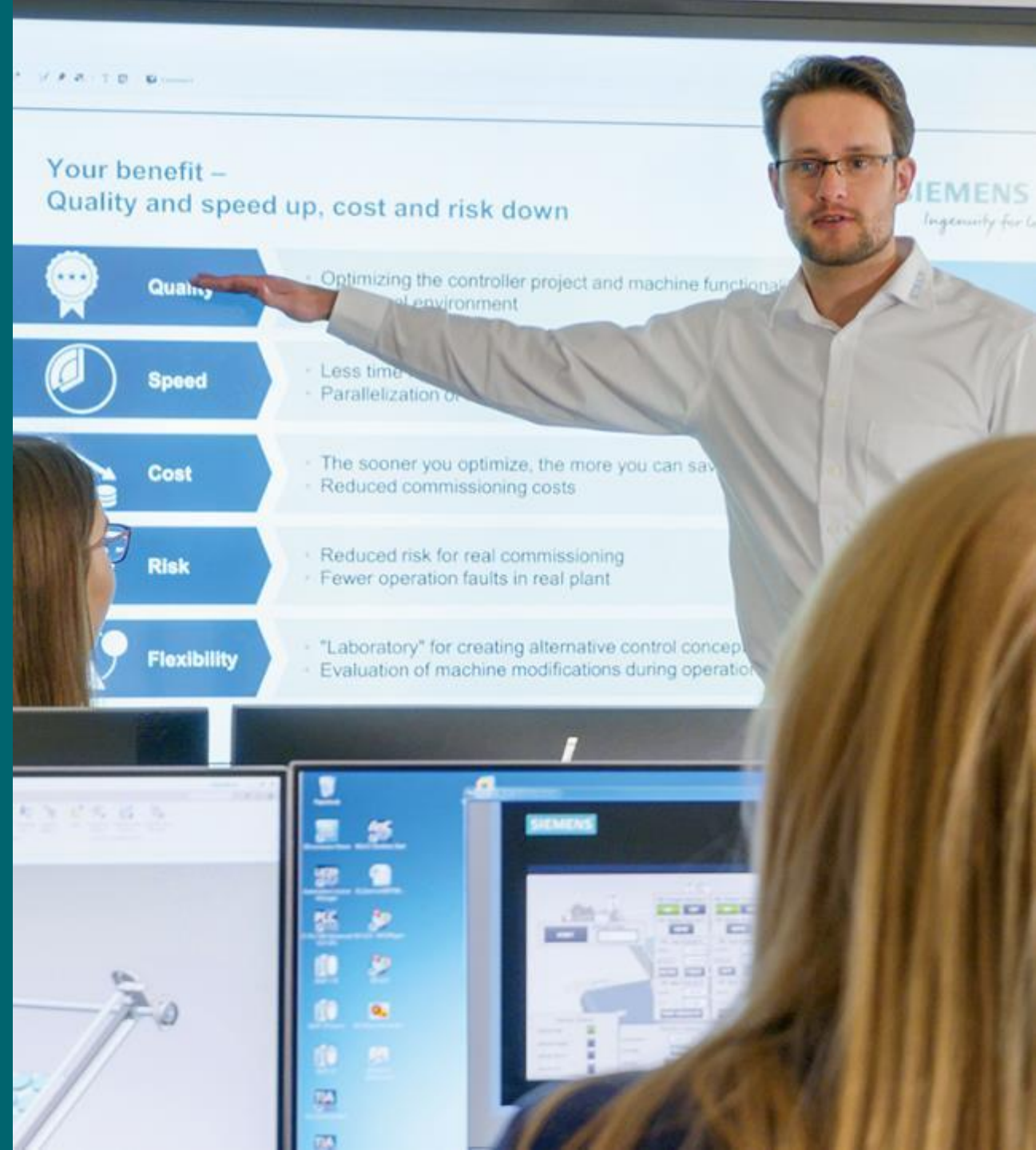



# Digital Enterprise TIA in the DE

**SIEMENS**  
*Ingenuity for life*



# Trainings for the Digital Enterprise

	Trainings for Totally Integrated Automation in the Digital Enterprise	Totally Integrated Automation in the Digital Enterprise – Basics	Totally Integrated Automation in the Digital Enterprise – Code Generation
Level 1	TIA in the DE – Introduction Compact ✓ DI-INTROC	TIA in the DE – Introduction to Standardization ✓ DI-STAND	
		Basics of Industrial Security In the factory automation ST-SECFA1	SIMATIC programming 1 in the TIA Portal ✓ TIA-PRO1
		OPC UA – Basics and Configuration IK-OPCUA1	TIA Portal Openness Programming 1 DI-OPEN1
Level 2			SIMATIC programming 2 in the TIA Portal ✓ TIA-PRO2
			TIA in the DE – Automatic execution of engineering tasks ✓ DI-AUTOEN
			TIA Portal Openness Programming 2 DI-OPEN2







The contents of a course in a field with coloured background are recommended requirements for attending the courses connected by arrows.

✓ Courses offered in South Africa

# Trainings for the Digital Enterprise



	Totally Integrated Automation in the Digital Enterprise – Virtual Commissioning	Totally Integrated Automation in the Digital Enterprise – Specialization Courses	Digitalization in the Process Automation
Level 1			SIMATIC PCS 7 Integrated Engineering and Simulation ST-PCS7INS
			SIMATIC PCS 7 System Course  ST-PCS7SYS
Level 2	SIMATIC programming 2 in the TIA Portal  TIA-PRO2		SIMATIC PCS 7 Plant Automation Accelerator Workshop for beginners ST-PCS7PAA
	TIA in the DE – Virtual Commissioning for Machines  DI-VIRTCOM	SiVArc – Options of Automatic Visualization Generation  TIA-SIVARC	SIMIT in Process Automation ST-PCS7SIM
	SIMIT in Discrete Automation Technology for Beginners DI-SIMITFA	Energy management with SIMATIC Energy Suite TIA-EMES	PROFINET and H-Systems in the Process Automation ST-PCS7PNH



The contents of a course in a field with coloured background are recommended requirements for attending the courses connected by arrows.

 Courses offered in South Africa



# 5

## Drive Technology **SINAMICS**

Low Voltage Converter

SINAMICS G120, SINAMICS S120

SINAMICS G130 / G150 / S150

SINAMICS DCM

SINAMICS Medium Voltage Converter

SIMOTICS Motors



# Drives & Switchgear SINAMICS G120

**SIEMENS**  
*Ingenuity for life*



# Trainings for SINAMICS G120

	Planners, decision makers and sales personnel	Commissioning engineer, programmers	Service personnel, maintenance personnel
<b>Basics</b>	Introduction to Drives ✓ DR-DRV-FUN	Introduction to Drives ✓ DR-DRV-FUN	Introduction to Drives ✓ DR-DRV-FUN
<b>Level 1</b>		SINAMICS G120 – Parameterizing and Commissioning ✓ DR-G12-PM	SINAMICS G120 – Parameterizing and Commissioning ✓ DR-G12-PM
<b>Level 2</b>		SINAMICS G120 – Parameterizing Advanced ✓ DR-G12-PA	



The contents of a course in a field with coloured background are recommended requirements for attending the courses connected by arrows.

✓ Courses offered in South Africa

# Drives & Switchgear SINAMICS S120

**SIEMENS**  
*Ingenuity for life*





# Trainings for SINAMICS S120



	Planners, decision makers and sales personnel	Commissioning engineer, programmers	Service personnel, maintenance personnel
<b>Basics</b>	Introduction to Drives ✓ DR-DRV-FUN	Introduction to Drives ✓ DR-DRV-FUN	Introduction to Drives ✓ DR-DRV-FUN
<b>Level 1</b>	SINAMICS S120 – Planning and Engineering ✓ DR-S12-PL	SINAMICS S120 – Parameterizing and Commissioning in the TIA Portal ✓ DR-S12-PMT	SINAMICS S120 – Diagnostics and Service ✓ DR-S12-DG
	SIMOTICS Motion Control Motors – Planning and Engineering DR-MCM-PL	SINAMICS S120 – Parameterizing and Commissioning ✓ DR-S12-PM	
	SIMOGEAR Geared Motors – Planning and Engineering DR-SGM-PL	SINAMICS S120 – Upgrade to TIA Portal and Startdrive ✓ DR-S12-UP	
<b>Level 2</b>		SINAMICS S120 – Parameterizing Advanced DR-S12-PA	SINAMICS S120 – Diagnostics at Chassis- and Cabinet Units DR-S12-CHA
		SINAMICS S120 – Parameterizing Safety Integrated DR-S12-SAF	SINAMICS S120 – Diagnostics PROFINET and PROFIBUS DR-S12-NET
		SINAMICS S120 – Parameterizing and Optimization DR-S12-OPT	



The contents of a course in a field with coloured background are recommended requirements for attending the courses connected by arrows



Courses offered in South Africa





# Drives & Switchgear SINAMICS G150 / G130 / S150

**SIEMENS**  
*Ingenuity for life*



# Trainings for SINAMICS G150 / G130 / S150

	Service personnel, maintenance personnel	
<b>Basics</b>	Introduction to Drives 	DR-DRV-FUN
<b>Level 1</b>	SINAMICS G150 / G130 / S150 – Diagnostics and Service 	DR-G15-DG



The contents of a course in a field with coloured background are recommended requirements for attending the courses connected by arrows.



 Courses offered in South Africa

# Drives & Switchgear SINAMICS DCM

**SIEMENS**  
*Ingenuity for life*



# Trainings for SINAMICS DCM

	Service personnel, maintenance personnel	
Basics	Introduction to Drives 	DR-DRV-FUN
Level 1	SINAMICS DCM – Diagnostics and Service 	DR-DCM-DG
Level 2	SINAMICS DCM – Parameterizing Advanced	DR-DCM-PA



The contents of a course in a field with coloured background are recommended requirements for attending the courses connected by arrows.

 Courses offered in South Africa

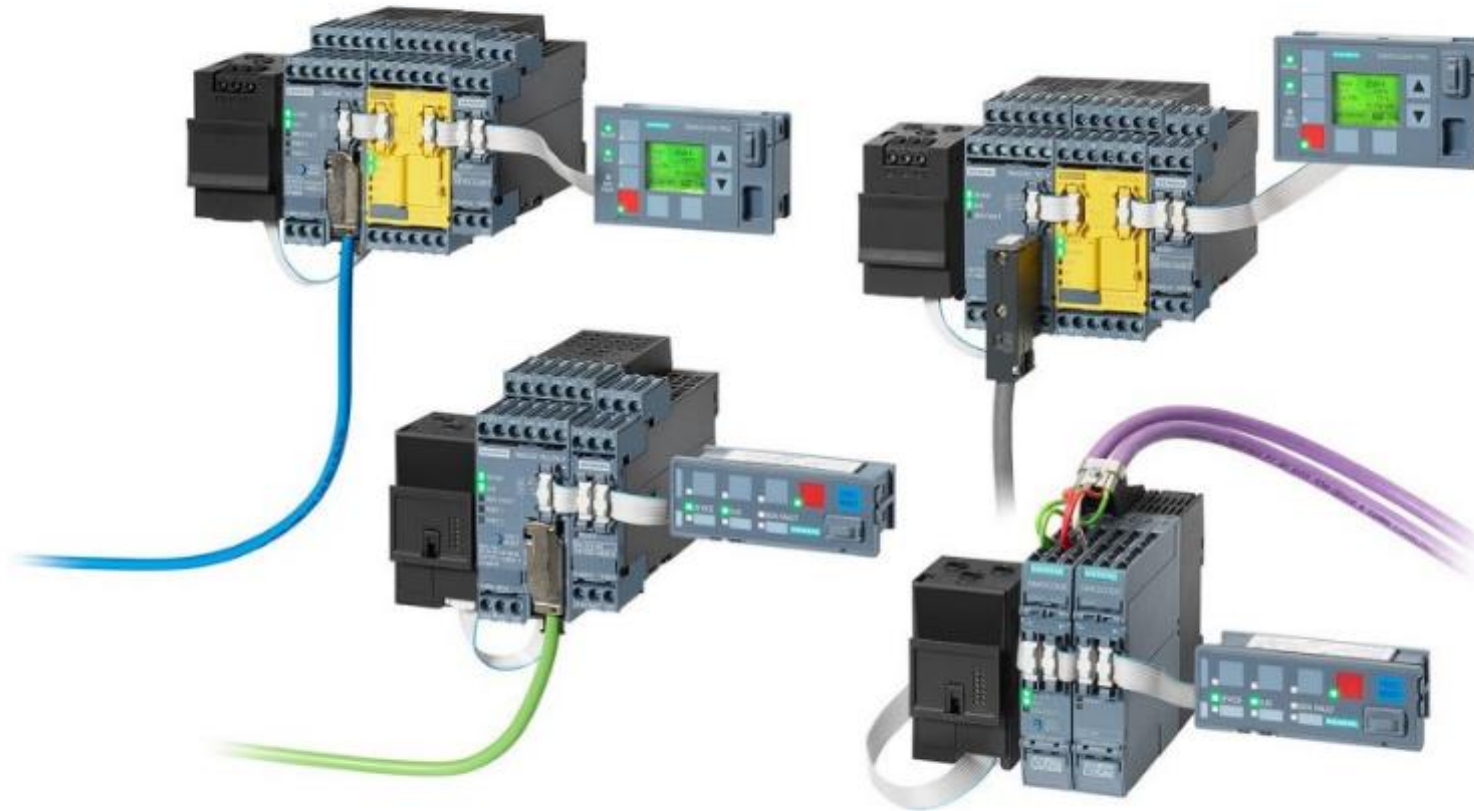

# Drives & Switchgear SIMOCODE PRO V

**SIEMENS**  
*Ingenuity for life*





# Trainings for SIMOCODE PRO V

	Service personnel, maintenance personnel	
Basics	Introduction to Drives 	DR-DRV-FUN
Level 1	SIMOCODE PRO V- Commissioning and Diagnostics 	SD-SIMOPRO
Level 2		



The contents of a course in a field with coloured background are recommended requirements for attending the courses connected by arrows.



 Courses offered in South Africa

# Drives & Switchgear SINAMICS Medium Voltage Converter

**SIEMENS**  
*Ingenuity for life*



# Trainings for SINAMICS Medium Voltage Converter

	Service personnel, maintenance personnel	
<b>Basics</b>	Introduction to Drives 	DR-DRV-FUN
<b>Level 1</b>	SINAMICS Perfect Harmony GH150 – Diagnostics and Service 	DR-GH15-DG
	SINAMICS Perfect Harmony GH180 – Diagnostics and Service 	DR-GH18-DG
	SINAMICS GL150 – Diagnostics and Service	DR-GL15-DG
	SINAMICS GM150 – Diagnostics and Service	DR-GM15-DG
	SINAMICS SL150 – Diagnostics and Service	DR-SL15-DG
	SINAMICS SM150 – Diagnostics and Service	DR-SM15-DG



The contents of a course in a field with coloured background are recommended requirements for attending the courses connected by arrows.



Courses offered in South Africa

6

# Motion Control





# Latest Automation Systems Motion Control

**SIEMENS**  
*Ingenuity for life*



# Trainings for Motion Control SIMOTION

	Commissioning engineer, programmers	Service personnel, maintenance personnel
<b>Level 1</b>	<p>SIMOTION – Programming and Commissioning ✓ MC-SMO-PM</p>	<p>SIMOTION und SINAMICS S120 – Diagnostic and Service ✓ MC-SMO-DG</p>
<b>Level 2</b>	<p>SIMOTION – Programming Advanced ✓ MC-SMO-PA</p>	

# Trainings for Motion Control SIMATIC TIA Portal

Commissioning engineer, programmers	
Level 1	SIMATIC programming 1 in the TIA Portal ✓ TIA-PRO1
	SIMATIC – Motion Control 1 in the TIA Portal ✓ TIA-MC1
Level 2	SIMATIC – Motion Control 2 in the TIA Portal ✓ TIA-MC2



The contents of a course in a field with coloured background are recommended requirements for attending the courses connected by arrows.

✓ Courses offered in South Africa

# 7

## Process Instrumentation Courses



# Trainings for Process Instrumentation

	Instrumentation Tech's & Maintenance	
<b>Basics</b>	Fundamentals of Process Instrumentation	PI-FUN ✓
<b>Level 1</b>	Flow Instruments	PI-FLOW ✓
	Level Instruments	PI-LVL ✓
	Weighing Instruments	PI-WNG ✓
	Pressure, Temperature and Positioners	PI-PTP ✓
<b>Level 2</b>		





# 8

## Process Control Systems **SIMATIC PCS 7** **SIMATIC PCS neo**

SIMATIC PCS 7, SIMATIC PCS neo



# Latest Automation Systems PCS7

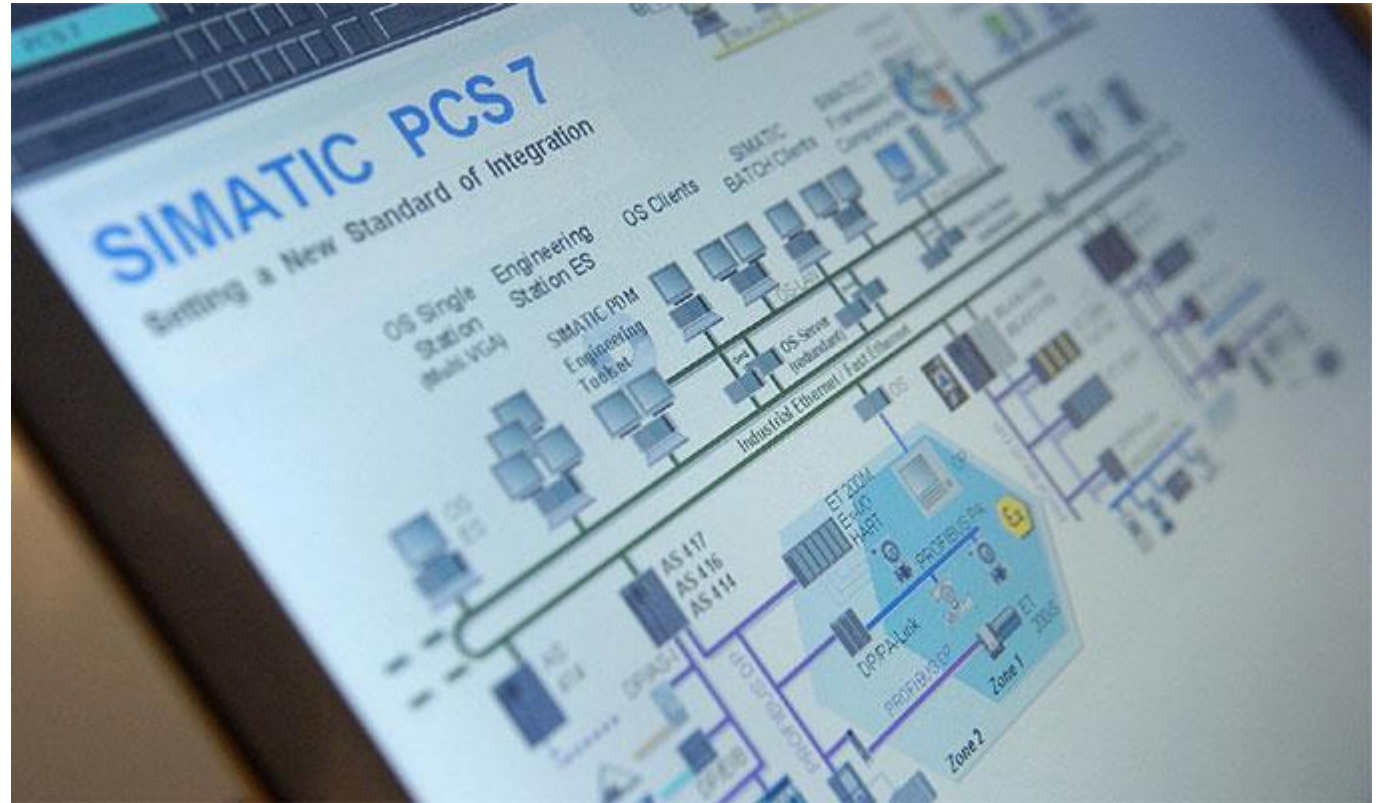

# Trainings for SIMATIC PCS 7

	Planning and Engineering	Extensions and Technology	Service
Level 1			SIMATIC PCS 7 Service 1 ✓ ST-PCS7SR
	SIMATIC PCS 7 System Course ✓ ST-PCS7SYS		
	Siemens SIMATIC PCS 7 Basic Engineer ✓ CP-PCS7-1		
Level 2	SIMATIC PCS 7 AS-Engineering ✓ ST-PCS7ASE	PCS 7 Batch Course ST-PCS7BAT	
	SIMATIC PCS 7 OS-Engineering ✓ ST-PCS7OSE	Introduction of the technologic libraries in SIMATIC PCS 7 ST-PCS7LIB	
	Siemens Certified SIMATIC PCS 7 Engineer CP-PCS7-2		





# Trainings for SIMATIC PCS 7



	Safety	Digital Enterprise for the Process Automation
Level 1		
	SIMATIC PCS 7 System Course ST-PCS7SYS	
Level 2	SIMATIC PCS 7 Process Safety ST-PCS7SAF	SIMATIC PCS 7 – Integrated Engineering and Simulation ST-PCS7INS
		SIMATIC PCS 7 Plant Automation Accelerator Workshop for beginners ST-PCS7PAA
		SIMIT in Process Automation ST-PCS7SIM
		PROFINET and H-Systems in the Process Automation ST-PCS7PNH

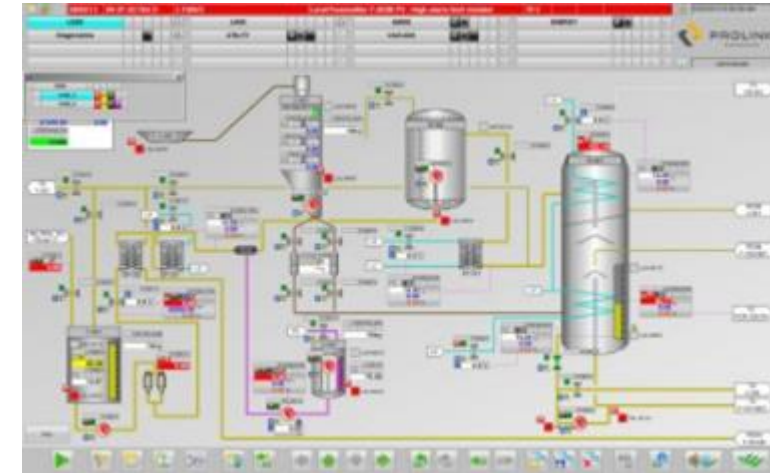

The contents of a course in a field with coloured background are recommended requirements for attending the courses connected by arrows.



Courses offered in South Africa



# Trainings for SIMATIC PCS neo

Future of the Process Automation	
<b>Level 1</b>	<b>SIMATIC PCS neo System Training for Beginners</b> NEO-BASIC
<b>Level 2</b>	<b>SIMATIC PCS neo System Training for PCS 7 Engineers</b> NEO-SYSUP



# SITRAIN – Training for Industry

## Thank you for your attention!

**SIEMENS**  
*Ingenuity for life*



We'll help you!

All product related info: 0860 80 80 80

Training information:

Tel: 011 652 3206

Or... on the Internet - *Online booking*

<https://new.siemens.com/za/en/product-services/services/industry/sitrain/sitrain-personal.html>