

# Function Relays, Interfaces and Converters

# 11

Industrial Control Product Catalog 2019

Section

## contents

Section Overview	11/2–11/3	Insulation monitoring	
<b>Temperature Monitoring Relays</b>		General data	11/83–11/84
3RS10, 3RS11, 3RS20, 3RS21		For ungrounded AC networks	11/85–11/86
Overview	11/4	For ungrounded DC and AC networks	11/87–11/91
Technical specifications	11/5–11/7	Level monitoring sensors	11/92
Relays, analogically adjustable for 1 sensor	11/8–11/9	Speed monitoring	11/93–11/95
Relays, digitally adjustable for 1 sensor	11/10–11/11	Accessories	11/96
Relays, digitally adjustable for up to 3 sensors	11/12–11/13	<b>Monitoring Relays For Stand-alone Installation for IO-Link</b>	
Accessories	11/14	3UG48 General data	11/97–11/99
3RS14, 3RS15		Line monitoring	11/100–11/102
Overview	11/15	Voltage monitoring	11/103–11/105
Technical specifications	11/16–11/19	Current monitoring	11/106–11/108
Relays, digitally adjustable for 1 sensor	11/20–11/22	Power factor and active current monitoring	11/109–11/112
Relays, digitally adjustable for up to 3 sensors	11/23–11/25	Residual-current monitoring relays	11/113–11/115
<b>Thermistor Motor Protection</b>		Speed monitoring	11/116–11/118
Overview	11/26	Accessories	11/119
Benefits and Application	11/27	<b>Coupling Relays – Narrow Design</b>	
Technical specifications	11/28–11/29	3RQ3 Overview	11/120
Function Diagrams	11/30	Benefits	11/121
Technical Data	11/31–11/32	Technical specifications	11/122–11/123
3RN2 Selection and ordering data	11/33	Circuit diagrams	11/124
Accessories	11/34	Selection and ordering data	11/125–11/127
<b>Timing Relays</b>		Accessories	
General Data	11/35	<b>Coupling Relays with Industrial Enclosure</b>	
3RP25 Timing Relays, 17.5 mm and 22.5 mm		3RQ2 Overview	11/128
Overview	11/36–11/37	Technical specifications	11/129
Technical specifications	11/39	Selection and ordering data	11/130
Circuit diagrams	11/40–11/44	Accessories	11/130
Functions	11/45–11/50	<b>Signal Converters/Interface Converters</b>	
Selection and ordering data	11/51	3RS70 Overview	11/132
Accessories	11/52	Technical specifications	11/133–11/135
3RP20 Timing Relays, 45mm		Circuit diagrams	11/136
Overview	11/53	Selection and Ordering	11/137
Technical specifications	11/54	Accessories	11/138
Functions	11/55–11/56	<b>Power Relays</b>	
Selection and ordering data	11/57	3TG10	
Accessories	11/58	Overview	11/139
7PV15 Timing Relays, 17.5mm		Selection and ordering data	11/139
Overview	11/59	Technical specifications	11/140–11/141
Technical specifications	11/60	Accessories, Circuit Diagrams, Dimensions	11/142
Circuit diagrams	11/60–11/61	<b>Plug-in Relays</b>	
Functions	11/62–11/63	3TX71	
Selection and ordering data	11/64	Selection and ordering data	11/143–11/146
<b>Monitoring Relays for Stand-alone Installation</b>		Technical specifications	11/147–11/148
3UG45, 3UG46 General data	11/65–11/66	Circuit diagrams	11/149–11/151
Line monitoring	11/67–11/71	Dimensions	11/152–11/158
Voltage monitoring	11/72–11/74	LZS	
Current monitoring	11/75–11/76	Selection and ordering data	11/159–11/163
Power factor and active current monitoring	11/77–11/79	Technical specifications	11/164–11/166
Residual-current monitoring relays	11/80–11/81		
3UL23 residual-current transformers	11/82		

contents

3RS10/3RS20 temperature monitoring relays

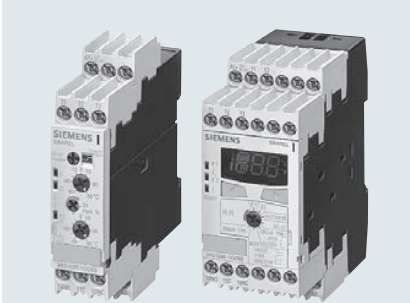

3RS10/3RS20 temperature monitoring relay for RTD or Thermocouple Page

- Selection and ordering data**
- Overview 11/4
  - Screw and Spring-type connection 11/5

Technical data	11/7
Configuration	11/8
Functions	11/9
Circuit diagrams	11/10
Dimension drawings	11/11

3RN2 thermistor motor protection



3RN20 thermistor motor protection for PTC temperature detectors Page

- Selection and ordering data**
- Overview 11/26
  - Screw and Spring-type connection 11/27
  - Accessories 11/28

Technical data	11/28
Function diagrams	11/29
Functions	11/30
Circuit diagrams	11/31
Dimension drawings	11/33

3RP20 timing



3RP20 timing relays Page

- Selection and ordering data**
- Overview 11/53
  - Screw and Spring-type connection 11/57

Technical data	11/54
Function diagrams	11/55

Timing Relays



3RP25 timing relays Page

- Selection and ordering data**
- Overview 11/36
  - Screw and Spring-type connection 11/51

Technical data	11/39
Circuit diagrams	11/40
Function diagrams	11/45



7PV solid-state relay Page

- Selection and ordering data**
- Screw connection 11/40
  - Accessories 11/40

Technical data	11/40
Dimension drawings	11/40



3RA28 and 3RT19 time delay blocks for mounting on 3RT contactors

- Selection and ordering data**
- See Section 2, page 2/70

contents

3UG3/4 monitoring relays



For electrical quantities

Selection and ordering data

- Selection Data 11/66

Overview	11/65
Technical data	11/67
Dimension drawings	11/68

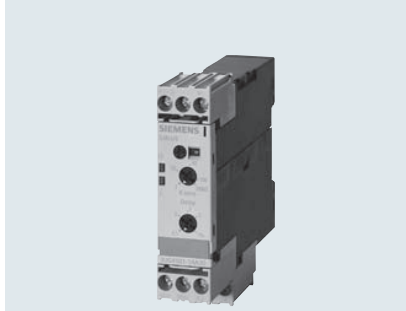

For non-electrical quantities

Selection and ordering data

- Selection Data 11/92

Overview	11/92
Technical data	11/93
Dimension drawings	11/94

Coupling relays and interfaces



3RQ3 slim design  
3RQ2 standard width

Selection and ordering data

- 3RQ3 Selection Data 11/125
- 3RQ2 Selection Data 11/130

Overview	11/120
Technical data	11/122
Accessories	11/128

Coupling relays and interfaces



3RS70 signal converter

Selection and ordering data

- Screw and Spring-type connection 11/137

Overview	11/132
Technical data	11/133
Circuit diagrams	11/136



3TG10 power relay,  
20A max. resistance load pole

Selection and ordering data

- AC and DC operation, hum-free  
With screw connection or tab connector 11/139
- Accessories 11/142

Application	11/139
Technical data	11/140
Circuit diagrams	11/142
Position of terminals	11/142
Dimension drawings	11/142



3TX71 and LZ series

Selection and ordering data

- AC and DC operation 11/143

Technical data	11/147
Circuit diagrams	11/149
Dimension drawings	11/152

Overview

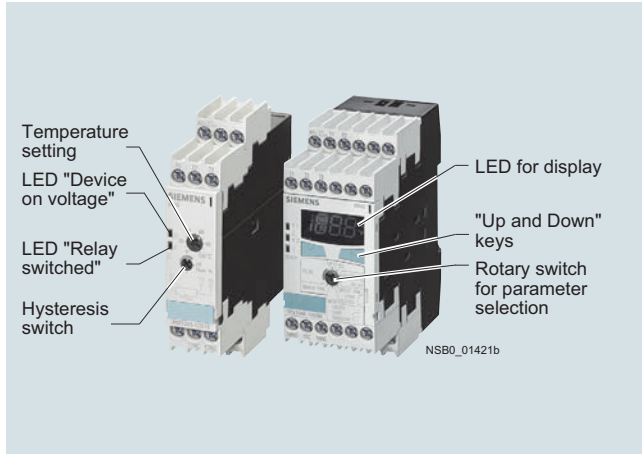

SIRIUS 3RS temperature monitoring relays

More information

Homepage, see [www.usa.siemens.com/relays](http://www.usa.siemens.com/relays)  
 Industry Mall, see [www.siemens.com/product?3RS10](http://www.siemens.com/product?3RS10)

The 3RS10, 3RS11, 3RS20 and 3RS21 temperature monitoring relays can be used for measuring temperatures in solid, liquid and gas media. The temperatures are acquired by means of sensors in the medium, evaluated by the device and monitored for overshoot, undershoot or location within a specified range (window function).

The range comprises adjustable analog units with one or two threshold values, digital units for 1 sensor, which are also a good alternative to temperature controllers for the low-end range, and digital units for up to 3 sensors which have been optimized for monitoring large motors.

Article No. scheme

Product versions		Article number										
<b>Temperature monitoring relays</b>		<b>3RS</b>	<input type="checkbox"/>	<input type="checkbox"/>	<input type="checkbox"/>	<input type="checkbox"/>	<input type="checkbox"/>	<input type="checkbox"/>	<input type="checkbox"/>	<input type="checkbox"/>	<b>0</b>	
Device type	e.g. 10 = analogically adjustable, 1 sensor		<input type="checkbox"/>	<input type="checkbox"/>								
Version and type of sensor	e.g. 00 = one threshold value, Pt100 sensor			<input type="checkbox"/>	<input type="checkbox"/>							
Connection type	Screw terminals								<b>1</b>			
	Spring-type terminals (push-in)								<b>2</b>			
Number and type of outputs	e.g. C = 1 NO + 1 NC									<input type="checkbox"/>		
Control supply voltage	e.g. D = 24 V AC/DC									<input type="checkbox"/>		
Measuring range	e.g. 0 = -50 ... +50 °C										<input type="checkbox"/>	
Example		<b>3RS</b>	<b>1</b>	<b>0</b>	<b>0</b>	<b>0</b>	<b>-</b>	<b>1</b>	<b>C</b>	<b>D</b>	<b>0</b>	<b>0</b>

Note:

The Article No. scheme shows an overview of product versions for better understanding of the logic behind the article numbers.

For your orders, please use the article numbers quoted in the selection and ordering data.



Technical specifications

More information

Technical specifications, see <https://support.industry.siemens.com/cs/ww/en/ps/16369/td>  
 Manual and internal circuit diagrams, see <https://support.industry.siemens.com/cs/ww/en/view/54999309>

FAQs, see <https://support.industry.siemens.com/cs/ww/en/ps/16369/faq>

Connection of resistance-type thermometers

Two-wire measurement

When two-wire temperature sensors are used, the resistances of the sensor and wiring are added. The resulting systematic error must be taken into account when the signal evaluation unit is calibrated. A jumper must be clamped between terminals T2 and T3 for this purpose.

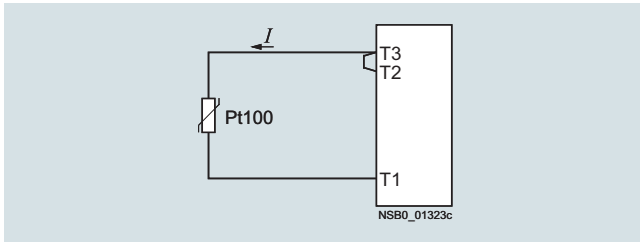

Wiring errors

The errors that are generated by the wiring comprise approximately 2.5 K/Ω. If the resistance of the cable is not known and cannot be measured, the wiring errors can also be estimated using the following table.

Temperature drift dependent on the length and cross-section of the cable with Pt100 sensors and an ambient temperature of 20 °C, in K:

Cable length in m	Cross-section mm <sup>2</sup>			
	0.5	0.75	1	1.5
Temperature drift in K:				
0	0	0	0	0
10	1.8	1.2	0.9	0.6
25	4.5	3.0	2.3	1.5
50	9.0	6.0	4.5	3.0
75	13.6	9.0	6.8	4.5
100	18.1	12.1	9.0	6.0
200	36.3	24.2	18.1	12.1
500	91.6	60.8	45.5	30.2

Example: On a Pt100 sensor with a cable length of 10 m and a conductor cross-section of 1 mm<sup>2</sup> the temperature drift equals 0.9 K.

Three-wire measurement

To minimize the effects of the line resistances, a three-wire circuit is often used. Using the additional cable, two measuring circuits can be formed of which one is used as a reference. The signal evaluation unit can then automatically calculate the line resistance and take it into account.

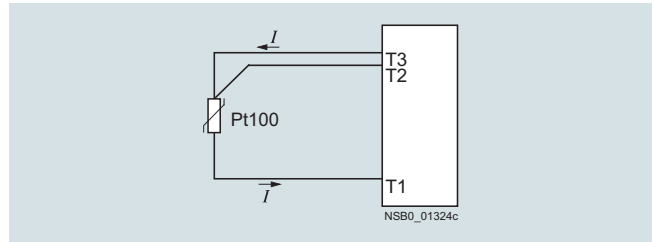

Connection of thermocouples

Based on the thermo-electrical effect, a differential temperature measurement will be performed between the measuring point and the signal evaluation unit.

This principle assumes that the signal evaluation unit knows the temperature at the clamping point (T2). For this reason, the 3RS11 temperature monitoring relay has an integral compensator that determines this comparison temperature and builds it into the result of the measurement. The thermal sensors and cables must be insulated therefore.

The absolute temperature is therefore calculated from the ambient temperature of the signal evaluation unit and the temperature difference measured by the thermocouple.

Temperature detection is therefore possible (T1) without needing to know the precise ambient temperature of the clamping point at the signal evaluation unit (T2).

The connecting cable is only permitted to be extended using connecting leads that are made from the same material as the thermocouple. If a different type of conductor is used, an error will result in the measurement.

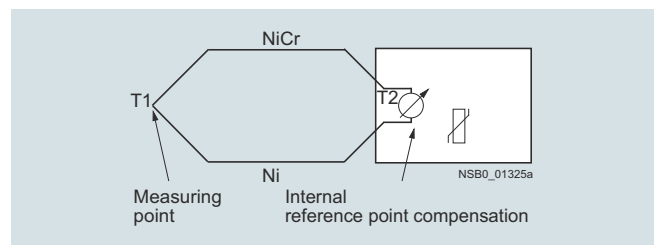

**Principle of operation**

Once the temperature has reached the set threshold value  $\vartheta_1$ , the output relay K1 changes its switching state as soon as the set time  $t$  has elapsed (K2 responds in the same manner to  $\vartheta_2$ ). The delay time can only be adjusted with digital units (on analog units  $t = 0$ ).

The relays return to their original state as soon as the temperature reaches the set hysteresis value.

**Temperature overshoot**

Closed-circuit principle

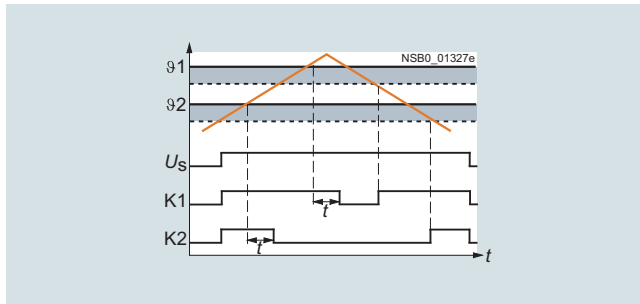

**Temperature undershoot**

Closed-circuit principle

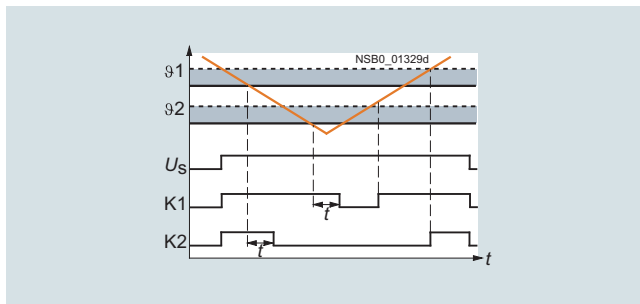

**Range monitoring (digital units only)**

Once the temperature has reached the upper threshold value  $\vartheta_1$ , the output relay K1 changes its switching state as soon as the temperature reaches the set hysteresis value.

K2 responds in the same manner to the lower threshold value of  $\vartheta_2$ .

Closed-circuit principle

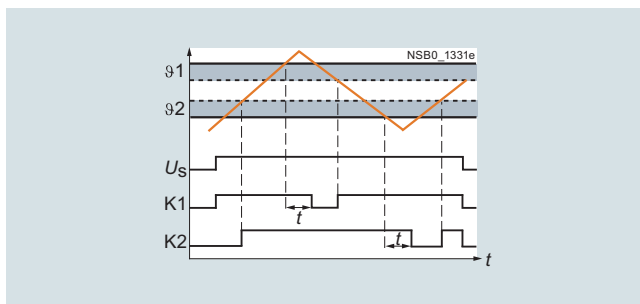

**Principle of operation with memory function (3RS1042, 3RS1142) based on the example of temperature overshoot**

Once the temperature has reached the set threshold value  $\vartheta_1$ , the output relay K1 changes its switching state as soon as the set time  $t$  has elapsed (K2 responds in the same manner to  $\vartheta_2$ ). The relays only return to the original state when the temperature falls below the set hysteresis value and when terminals Y3-Y4 have been briefly jumpered.

Closed-circuit principle

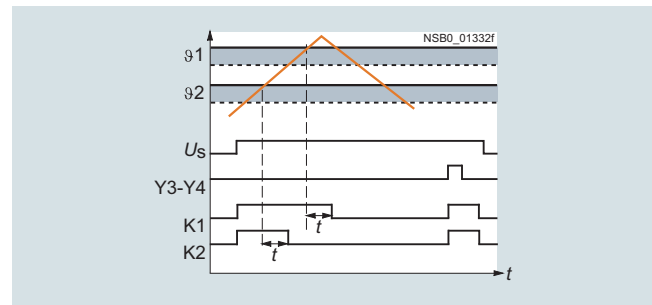

**Characteristic curves**

For resistance sensors

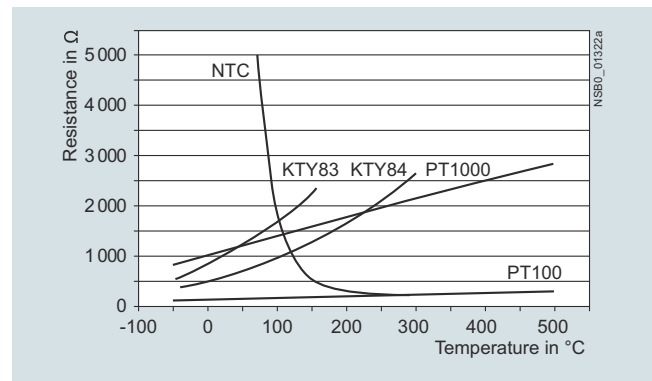

The short-circuit and open-circuit detection as well as the measuring range is limited, depending on the sensor type.

Measuring ranges in ̑C for resistance sensors

Sensor type	Short circuit	Open circuit	3RS1040/ 3RS1041 Measuring range in ̑C	3RS1042 Measuring range in ̑C
Pt100	✓	✓	-50 ... +500	-50 ... +750
Pt1000	✓	✓	-50 ... +500	-50 ... +500
KTY83-110	✓	✓	-50 ... +175	-50 ... +175
KTY84	✓	✓	-40 ... +300	-40 ... +300
NTC <sup>1)</sup>	✓	--	80 ... 160	80 ... 160

- ✓ Detection possible
- Detection not possible

<sup>1)</sup> NTC type: B57227-K333-A1 (100 ̑C: 1.8 k̑; 25 ̑C: 32.762 k̑).

**Characteristic curves**

For thermocouples

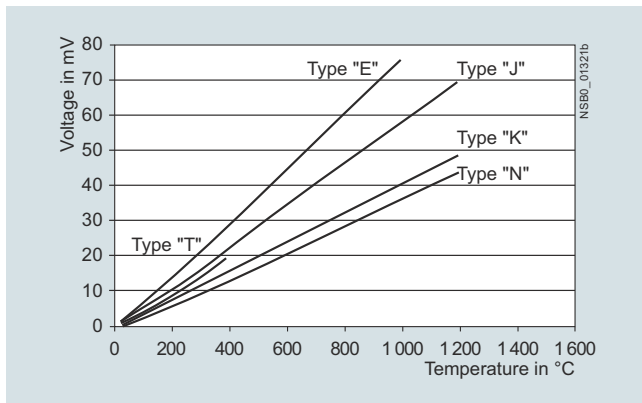

Characteristic curves for sensor types J, K, T, E, N

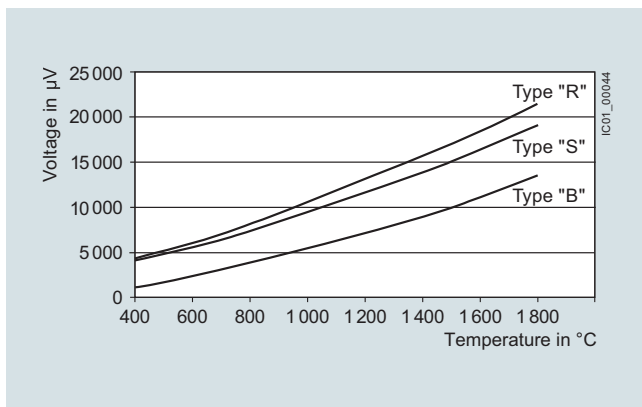

Characteristic curves for sensor types S, R and B

Measuring range in °C for thermocouples

Sensor type	Short circuit	Open circuit	3RS1140 Measuring range in °C	3RS1142 Measuring range in °C
J	--	✓	-99 ... +999	-99 ... +1 200
K	--	✓	-99 ... +999	-99 ... +1 350
T	--	✓	-99 ... +400	-99 ... +400
E	--	✓	-99 ... +999	-99 ... +999
N	--	✓	-99 ... +999	-99 ... +999
S	--	✓	--	0 ... 1 750
R	--	✓	--	0 ... 1 750
B	--	✓	--	400 ... 1 800

✓ Detection possible  
 -- Detection not possible

Type		3RS10, 3RS11 analog	3RS10, 3RS11, 3RS20, 3RS21 digital
<b>General technical specifications</b>			
Dimensions (W x H x D)			
• Screw terminals	mm	22.5 x 102 x 91	45 x 106 x 91
• Spring-type terminals	mm	22.5 x 103 x 91	45 x 108 x 91
<b>Permissible ambient temperature</b>			
• During operation	°C	-25 ... +60	
<b>Connection type</b>		<b>Screw terminals</b>	
• Terminal screw		M3 (for standard screwdriver, size 2 and Pozidriv 2)	
• Solid	mm <sup>2</sup>	1 x (0.5 ... 4)/2 x (0.5 ... 2.5)	
• Finely stranded with end sleeve	mm <sup>2</sup>	1 x (0.5 ... 2.5)/2 x (0.5 ... 1.5)	
• AWG cables, solid or stranded	AWG	2 x (20 ... 14)	
<b>Connection type</b>		<b>Spring-type terminals</b>	
• Solid	mm <sup>2</sup>	2 x (0.25 ... 1.5)	
• Finely stranded, with end sleeve acc. to DIN 46228	mm <sup>2</sup>	2 x (0.25 ... 1.5)	
• Finely stranded	mm <sup>2</sup>	2 x (0.25 ... 1.5)	
• AWG cables, solid or stranded	AWG	2 x (24 ... 16)	

## Overview



SIRIUS 3RS analog temperature monitoring relays for 1 sensor

The 3RS10, 3RS11 analog temperature monitoring relays can be used for measuring temperatures in solid, liquid and gas media. The temperature is detected by the sensors in the medium, evaluated by the device and monitored for overshoot or undershoot. When the threshold values are reached, the output relay switches on or off depending on the parameterization.

## Benefits

- All devices except for 24 V AC/DC feature electrical separation
- Extremely easy operation using a rotary potentiometer
- Adjustable hysteresis
- Adjustable working principle for devices with 2 threshold values
- All versions with removable terminals
- All versions with screw terminals, many versions alternatively with spring-type terminals

## Application

The analogically adjustable SIRIUS 3RS10, 3RS11 temperature monitoring relays can be used in almost any application in which temperature overshoot or undershoot is not permitted, e.g. in the monitoring of set temperature limits and the output of alarm messages for:

- Motor and system protection
- Control cabinet temperature monitoring
- Freeze monitoring
- Temperature limits for process variables e.g. in the packaging industry or electroplating
- Controlling equipment and machines such as heating, climate and ventilation systems, solar collectors, heat pumps or warm water supplies
- Motor, bearing and gear oil monitoring
- Monitoring of coolants

## Technical specifications





Type		3RS1000, 3RS1010	3RS1100, 3RS1101	3RS1020, 3RS1030	3RS1120, 3RS1121
<b>Auxiliary circuit</b>					
<b>Rated operational currents <math>I_e</math></b>					
• AC-15/24 ... 250 V	A	3			
• DC-13 at					
- 24 V	A	1			
- 125 V	A	0.2			
- 250 V	A	0.1			
<b>Measuring accuracy at 20 °C ambient temperature (T20)</b>		< ± 5% of full-scale value			
<b>Reference point accuracy</b>	K	--	< ± 5	--	< ± 5
<b>Deviations due to ambient temperature</b>		< 2	< 3	< 2	< 3
In % of the measuring range					
<b>Hysteresis settings</b>					
• For temperature 1	%	2 ... 20 from upper limit of scale			
• For temperature 2	%	5 from upper limit of scale			
<b>Sensor circuit</b>					
<b>Typical sensor current</b>					
• Pt100	mA	1	--	1	--
<b>Open-circuit detection</b>		No			
<b>Short-circuit detection</b>		No			
<b>Three-wire conductor connection<sup>1)</sup></b>		Yes	--	Yes	--
<b>Enclosure</b>					
<b>Rated insulation voltage <math>U_i</math> (pollution degree 3)</b>	V	300			

<sup>1)</sup> Two-wire connection of resistance sensors with wire jumper between T2 and T3.

**Selection and ordering data**

- For temperature monitoring with resistance sensors or thermocouples
- Temperature range -55 °C to +1 000 °C, depending on the sensor type
- Wide voltage range versions are electrically separated
- Analogically adjustable, setting accuracy ± 5%
- Versions with 2 separately adjustable threshold values and adjustable open/closed-circuit principle
- Hysteresis for threshold value 1 is adjustable (2 to 20%), hysteresis for threshold value 2 is non-adjustable (5%)
- 1 NC + 1 NO for versions with one threshold value
- 1 CO for threshold value 1 and 1 NO for threshold value 2

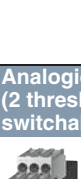
PU (UNIT, SET, M) = 1  
PS\* = 1 unit

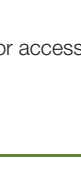
Sensors	Function	Measuring range	Rated control supply voltage $U_s$ 50/60 Hz AC	SD	Screw terminals		SD	Spring-type terminals			
					Article No.	Price per PU		Article No.	Price per PU		
<p><b>Analogically adjustable, 1 threshold value, width 22.5 mm; closed-circuit principle; without memory; 1 NO + 1 NC</b></p>											
 3RS1000-1CD10	Pt100 (resistance sensor)	Overshoot	- 50 ... + 50	24 AC/DC	10	3RS1000-1CD00	10	3RS1000-2CD00	10		
			0 ... + 100	110/230 AC	10	3RS1000-1CK00	10	3RS1000-2CK00	10		
			0 ... + 200	24 AC/DC	10	3RS1000-1CD10	10	3RS1000-2CD10	10		
		 3RS1000-2CD10	Type J (thermo-couple)	Overshoot	0 ... + 200	24 AC/DC	10	3RS1100-1CD20	10	3RS1100-2CD20	10
					0 ... + 600	110/230 AC	10	3RS1100-1CK20	10	---	---
					0 ... + 200	24 AC/DC	10	3RS1010-1CD20	10	---	---
Undershoot	- 50 ... + 50			110/230 AC	10	3RS1010-1CK00	10	---	---		
	0 ... + 100			24 AC/DC	10	3RS1010-1CD10	10	---	---		
	0 ... + 200			110/230 AC	10	3RS1010-1CK10	10	---	---		
 3RS1100-2CD20	Type K (thermo-couple)	Overshoot	0 ... + 200	24 AC/DC	10	3RS1101-1CD20	10	---	---		
			0 ... + 600	110/230 AC	10	3RS1101-1CK20	10	---	---		
			0 ... + 200	24 AC/DC	10	3RS1101-1CD30	10	---	---		
		Undershoot	- 50 ... + 50	110/230 AC	10	3RS1101-1CK30	10	---	---		
			0 ... + 100	24 AC/DC	10	3RS1101-1CD40	10	---	---		
			0 ... + 200	110/230 AC	10	3RS1101-1CK40	10	---	---		
<p><b>Analogically adjustable for warning and disconnection (2 threshold values), 22.5 mm width; open/closed-circuit principle switchable; without memory; 1 NO + 1 CO</b></p>											
 3RS1020-1DD00	Pt100 (resistance sensor)	Overshoot	- 50 ... + 50	24 AC/DC	10	3RS1020-1DD00	10	---	---		
			0 ... + 100	24 ... 240 AC/DC	10	3RS1020-1DW00	10	---	---		
			0 ... + 200	24 AC/DC	10	3RS1020-1DD10	10	---	---		
		 3RS1120-2DD20	Overshoot	0 ... + 200	24 ... 240 AC/DC	10	3RS1020-1DW10	10	---	---	
				0 ... + 600	24 AC/DC	10	3RS1020-1DD20	10	---	---	
				0 ... + 200	24 ... 240 AC/DC	2	3RS1020-1DW20	10	3RS1020-2DW20	10	
Undershoot	- 50 ... + 50		24 AC/DC	10	3RS1030-1DD00	10	---	---			
	0 ... + 100		24 ... 240 AC/DC	10	3RS1030-1DW00	10	---	---			
	0 ... + 200		24 AC/DC	10	3RS1030-1DD10	10	---	---			
 3RS1030-1DD20	Overshoot	0 ... + 200	24 ... 240 AC/DC	10	3RS1030-1DW10	10	---	---			
		0 ... + 600	24 AC/DC	10	3RS1030-1DD20	10	---	---			
		0 ... + 200	24 ... 240 AC/DC	10	3RS1030-1DW20	10	3RS1030-2DD20	10			
	Undershoot	- 50 ... + 50	24 ... 240 AC/DC	10	3RS1120-1DD20	10	---	---			
		0 ... + 100	24 ... 240 AC/DC	10	3RS1120-1DW20	10	---	---			
		0 ... + 200	24 AC/DC	10	3RS1120-1DD30	10	---	---			
Type J (thermo-couple)	0 ... + 600	24 ... 240 AC/DC	10	3RS1120-1DW30	10	---	---				
	0 ... + 200	24 ... 240 AC/DC	10	3RS1121-1DW20	10	---	---				
	0 ... + 600	24 ... 240 AC/DC	10	3RS1121-1DW30	10	---	---				
Type K (thermo-couple)	+ 500 ... + 1 000	24 AC/DC	10	3RS1121-1DD40	10	---	---				

For accessories, see page 11/14.

## Overview



SIRIUS 3RS digital temperature monitoring relay for 1 sensor

The 3RS10, 3RS11, 3RS20 and 3RS21 temperature monitoring relays can be used for measuring temperatures in solid, liquid and gas media. The temperatures are acquired by means of sensors in the medium, evaluated by the device and monitored for overshoot, undershoot or location within a specified range (window function). The 3RS10 and 3RS11 units indicate the measured temperature in °C, the 3RS20 and 3RS21 units in °F.

The units are also an excellent alternative to temperature controllers in the low-end performance range (two- or three-point control).

## Benefits

- Very simple operation without complicated menu selections
- Two- or three-point control can be parameterized quickly
- All versions with removable terminals
- All versions with screw or spring-type terminals

## Application

The temperature monitoring relays can be used in almost any application in which temperature overshoot or undershoot is not permitted, e.g. in the monitoring of set temperature limits and the output of alarm messages for:

- Plant and environment protection
- Temperature limits for process variables e.g. in the packaging industry or electroplating
- Temperature limits for district heating plants
- Exhaust temperature monitoring
- Controlling equipment and machines such as heating, climate and ventilation systems, solar collectors, heat pumps or warm water supplies
- Motor, bearing and gear oil monitoring
- Monitoring of coolants

## Technical specifications

Type		3RS1040, 3RS1042, 3RS2040	3RS1140, 3RS2140	3RS1142
<b>Auxiliary circuit</b>				
<b>Rated operational currents <math>I_e</math></b>				
• AC-15/24 ... 250 V	A	3		
• DC-13 at:				
- 24 V	A	1		
- 125 V	A	0.2		
- 250 V	A	0.1		
<b>Evaluation unit</b>				
<b>Measuring accuracy at 20 °C ambient temperature (T20)</b>		< ± 2 K, ± 1 digit	< ± 5 K, ± 1 digit	< ± 7 K, ± 1 digit
<b>Reference point accuracy</b>		--	< ± 5 K	
<b>Deviations due to ambient temperature</b>	%	0.05 °C per K deviation from T20		
In % of measuring range				
<b>Measuring cycle</b>	ms	500		
<b>Hysteresis settings</b> for temperature	K	1 ... 99, for both values		
<b>Adjustable delay time</b>	s	0 ... 999		
<b>Sensor circuit</b>				
<b>Typical sensor current</b>				
• Pt100	mA	1	--	--
• Pt1000/KTY83/KTY84/NTC	mA	0.2	--	--
<b>Open-circuit detection</b>		Yes <sup>1)</sup>	Yes	Yes
<b>Short-circuit detection</b>		Yes	No	No
<b>Three-wire conductor connection</b>		Yes <sup>2)</sup>	--	--
<b>Enclosure</b>				
<b>Rated insulation voltage <math>U_i</math></b> (pollution degree 3)	V AC	300		



<sup>1)</sup> Not for NTC type B57227-K333-A1 (100 °C: 1.8 kΩ; 25 °C: 32.762 kΩ).

<sup>2)</sup> Two-wire connection of resistance sensors with wire jumper between T2 and T3.



**Selection and ordering data**

- For temperature monitoring with resistance sensors or thermocouples
- Temperature range dependent on sensor type
- Wide voltage range versions are electrically separated
- Non-volatile
- Short-circuit and open-circuit detection in sensor circuit
- Digitally adjustable, with illuminated LCD
- Overshoot, undershoot or range monitoring adjustable
- Exact sensor type can be set
- 2 separately adjustable threshold values
- 1 hysteresis applies to both thresholds (0 to 99 K)
- 1 delay time applies to both thresholds (0 to 999 s)
- Adjustable open/closed-circuit principle
- Adjustable Manual/remote RESET
- Permanent display of actual value in °C or °F and tripping state
- 1 CO contact each per threshold value
- 1 NO for sensor monitoring

PU (UNIT, SET, M) = 1  
PS\* = 1 unit

Sensors	Measuring range (measuring range limit depends on the sensor)	Rated control supply voltage $U_s$ 50/60 Hz AC	SD	Screw terminals 	SD	Spring-type terminals 	
		V	d	Article No.	Price per PU	Article No.	Price per PU

**Temperature monitoring relay, digitally adjustable, 2 threshold values, width 45 mm, 1 CO + 1 NO, memory function possible with external jumper, device parameters are non-volatile**

	Pt100/1000; KTY83/84; NTC (resistance sensors) <sup>1)</sup>	- 50 ... + 500 °C	24 AC/DC	2	<b>3RS1040-1GD50</b>	2	<b>3RS1040-2GD50</b>
			24 ... 240 AC/DC	2	<b>3RS1040-1GW50</b>	2	<b>3RS1040-2GW50</b>
		- 58 ... + 932 °F	24 AC/DC	10	<b>3RS2040-1GD50</b>	10	<b>3RS2040-2GD50</b>
			24 ... 240 AC/DC	10	<b>3RS2040-1GW50</b>	10	<b>3RS2040-2GW50</b>
	TYPE J, K, T, E, N (thermocouple)	- 99 ... + 999 °C	24 AC/DC	2	<b>3RS1140-1GD60</b>	10	<b>3RS1140-2GD60</b>
			24 ... 240 AC/DC	2	<b>3RS1140-1GW60</b>	10	<b>3RS1140-2GW60</b>
		- 99 ... + 1 830 °F	24 AC/DC	10	<b>3RS2140-1GD60</b>	15	<b>3RS2140-2GD60</b>
			24 ... 240 AC/DC	10	<b>3RS2140-1GW60</b>	15	<b>3RS2140-2GW60</b>

**Temperature monitoring relay, digitally adjustable, 2 threshold values, width 45 mm, 1 CO + 1 NO, tripping state and device parameters are non-volatile**

	Pt100/1000; KTY83/84; NTC (resistance sensors) <sup>1)</sup>	- 50 ... + 750 °C	24 AC/DC	10	<b>3RS1042-1GD70</b>	10	<b>3RS1042-2GD70</b>
			24 ... 240 AC/DC	2	<b>3RS1042-1GW70</b>	10	<b>3RS1042-2GW70</b>
	TYPE J, K, T, E, N, R, S, B (thermocouple)	- 99 ... + 1 800 °C	24 AC/DC	10	<b>3RS1142-1GD80</b>	10	<b>3RS1142-2GD80</b>
			24 ... 240 AC/DC	2	<b>3RS1142-1GW80</b>	10	<b>3RS1142-2GW80</b>

<sup>1)</sup> NTC type: B57227-K333-A1 (100 °C: 1.8 kΩ; 25 °C: 32.762 kΩ).

For accessories, see page 11/14.



## Overview



SIRIUS 3RS digital temperature monitoring relay for up to 3 sensors

The 3RS10, 3RS20 temperature monitoring relays can be used for measuring temperatures in solid, liquid and gas media. The temperature is detected by the sensor in the medium, evaluated by the device and monitored for overshoot or undershoot or for staying within an operating range (window function). The 3RS10 units indicate the measured temperature in °C, the 3RS20 units in °F. The evaluation unit can evaluate up to 3 resistance sensors at the same time and is specially designed for monitoring motor windings and bearings.

## Benefits

- Very simple operation without complicated menu selections
- Space-saving with 45 mm width
- Two- or three-point control can be parameterized quickly
- All versions with removable terminals
- All versions with screw or spring-type terminals

## Application

The 3RS10, 3RS20 temperature monitoring relays can be used in almost any application in which several temperatures have to be monitored simultaneously for overshoot or undershoot or within a range.

Monitoring of set temperature limits and output of alarm messages for:

- Plant and environment protection
- Temperature limits for process variables e.g. in the packaging industry or electroplating
- Controlling equipment and machines such as heating, climate and ventilation systems, solar collectors, heat pumps or warm water supplies
- Motor, bearing and gear oil monitoring
- Monitoring of coolants

## Technical specifications

Type	3RS1041, 3RS2041	
<b>Auxiliary circuit</b>		
<b>Rated operational currents <math>I_e</math></b>		
• AC-15/24 ... 250 V	A	3
• DC-13 at		
- 24 V	A	1
- 125 V	A	0.2
- 250 V	A	0.1
<b>DIAZED fuse protection</b>		
• Operational class gG	A	4
<b>Evaluation unit</b>		
<b>Measuring accuracy at 20 °C ambient temperature (T20)</b>		< ± 2 K, ± 1 digit
<b>Deviations due to ambient temperature</b> In % of measuring range	%	0.05 per K deviation from T20
<b>Measuring cycle</b>	ms	500
<b>Hysteresis settings</b> for temperature 1		1 ... 99 K, for both values
<b>Adjustable delay time</b>	s	0 ... 999
<b>Sensor circuit</b>		
<b>Typical sensor current</b>		
• Pt100	mA	1
• Pt1000/KTY83/KTY84/NTC	mA	0.2
<b>Open-circuit detection</b>		Yes <sup>1)</sup>
<b>Short-circuit detection</b>		Yes
<b>Three-wire conductor connection</b>		Yes <sup>2)</sup>
<b>Enclosure</b>		
<b>Rated insulation voltage <math>U_i</math></b> (pollution degree 3)	V AC	300



<sup>1)</sup> Not for NTC type B57227-K333-A1 (100 °C: 1.8 kΩ; 25 °C: 32.762 kΩ).

<sup>2)</sup> Two-wire connection of resistance sensors with wire jumper between T2 and T3.

### Selection and ordering data

- For temperature monitoring of solids, liquids, and gases
- For two- and three-conductor resistance sensors or thermocouples
- Temperature range dependent on sensor type
  - for 3RS10: - 50 to + 500 °C
  - for 3RS20: - 58 to + 932 °F
- Wide voltage range versions are electrically separated
- Non-volatile
- Short-circuit and open-circuit detection in sensor circuit
- Digitally adjustable, with illuminated LCD
- Overshoot, undershoot or range monitoring adjustable
- Exact sensor type and number of sensors can be set
- 2 separately adjustable threshold values
- 1 hysteresis; applies to both thresholds (0 to 99 K)
- 1 delay time; applies to both thresholds (0 to 999 s)
- Adjustable open-/closed-circuit principle
- With connectable and disconnectable error memory
- Permanent display of actual value in °C or °F and tripping state
- 1 CO contact each per threshold value
- 1 NO for sensor monitoring

PU (UNIT, SET, M) = 1  
PS\* = 1 unit

Sensors	Number of sensors	Measuring range (limit of measuring range dependent on sensor)	Rated control supply voltage $U_s$	SD	Screw terminals 	SD	Spring-type terminals 		
			V	d	Article No.	Price per PU	d	Article No.	Price per PU

### Motor monitoring relays, digitally adjustable for up to 3 sensors, width 45 mm; 1 CO + 1 CO + 1 NO



Pt100/1000;  
KTY83/84;  
NTC  
(resistance sensors)<sup>1)</sup>





3RS1041-1GW50

<sup>1)</sup> NTC type: B57227-K333-A1 (100 °C: 1.8 kΩ; 25 °C: 32.762 kΩ).

For accessories, see page 11/14.

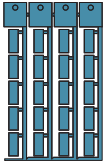
<b>3RS1041-1GW50</b>	2	<b>3RS1041-2GW50</b>
<b>3RS2041-1GW50</b>	15	<b>3RS2041-2GW50</b>

**Selection and ordering data**

Use	Version	SD	Article No.	Price per PU	PU (UNIT, SET, M)	PS*
<b>Blank labels</b>						
 3RT1900-1SB20	For 3RS10, 3RS11, 3RS20, 3RS21	<b>Unit labeling plates</b> For SIRIUS devices 20 mm x 7 mm, pastel turquoise	20	<b>3RT1900-1SB20</b>		100 340 units
	For 3RS10, 3RS11, 3RS20, 3RS21	<b>Adhesive labels</b> for SIRIUS devices • 19 mm x 6 mm, pastel turquoise • 19 mm x 6 mm, zinc yellow	15	<b>3RT1900-1SB60</b>		100 3 060 units
			15	<b>3RT1900-1SD60</b>		100 3 060 units
<b>Push-in lugs and covers</b>						
 3RP1903	For 3RS10, 3RS11, 3RS20, 3RS21	<b>Push-in lugs</b> For screw fixing, 2 units are required for each device	5	<b>3RP1903</b>		1 10 units
 3RP1902	For 22.5 mm wide 3RS10, 3RS11, 3RS20, 3RS21	<b>Sealable covers</b> For securing against unauthorized adjustment of setting knobs	5	<b>3RP1902</b>		1 5 units
<b>Tools for opening spring-type terminals</b>						
 3RA2908-1A	For auxiliary circuit connections	<b>Screwdrivers</b> For all SIRIUS devices with spring-type terminals; 3.0 mm x 0.5 mm; length approx. 200 mm, titanium gray/black, partially insulated	2	<b>Spring-type terminals</b>  <b>3RA2908-1A</b>		1 1 unit

For matching sensors, see [www.usa.siemens.com/temperature](http://www.usa.siemens.com/temperature)

Overview

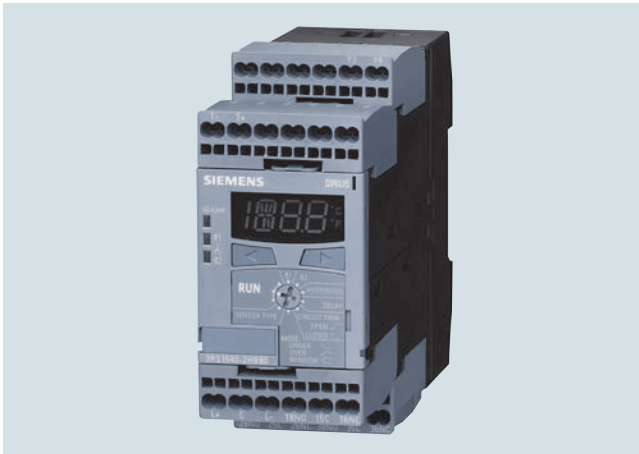

SIRIUS 3RS14, 3RS15 temperature monitoring relay

More information

Homepage, see [www.siemens.com/relays](http://www.siemens.com/relays)  
 Industry Mall, see [www.siemens.com/product?3RS14](http://www.siemens.com/product?3RS14)

The temperature monitoring relays for IO-Link are used to measure temperatures in solid, liquid and gas media.

The temperatures are acquired by means of sensors in the medium, evaluated by the device and monitored up to two limit values for overshooting or undershooting a working range (window function).

In addition to warnings and disconnection in case of temperature deviations, the devices can also be used as a temperature controller (one-point, two-point or three-point control).

The devices differ from one another in terms of the type and number of connectable temperature sensors.

- 3RS14: Connection for resistance sensor
- 3RS15: Connection for thermocouples

Function	Temperature monitoring relays		
	3RS1440	3RS1441	3RS1540
<b>Connectable sensor type</b>			
Number of sensors monitored	1	3	1
Resistance sensor	✓	✓	--
Thermocouples	--	--	✓
<b>Temperature monitoring</b>			
Temperature monitoring – overshoot	✓	✓	✓
Temperature monitoring – undershoot	✓	✓	✓
Number of adjustable limit values	2	2	2

- ✓ Function supported
- Function not supported

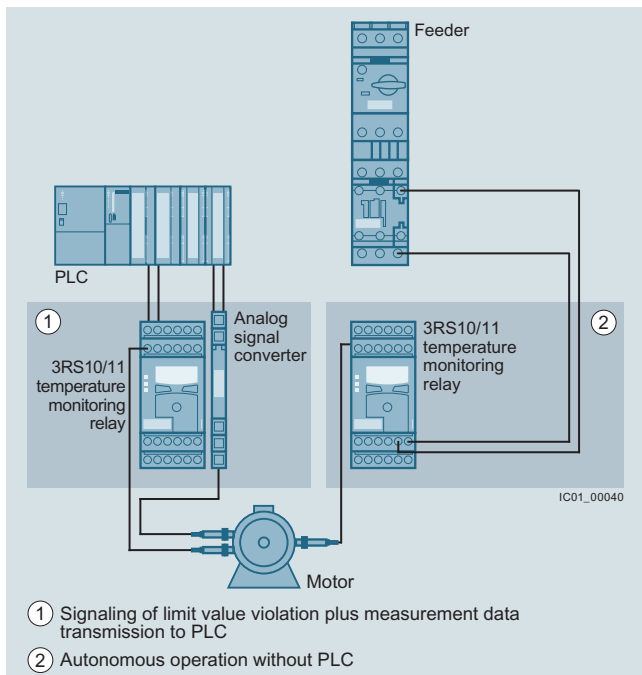

Conventional temperature monitoring relays

Notes:

Devices required for the communication via IO-Link:

- Any controller that supports IO-Link (e.g. ET 200SP with CPU or S7-1200), see [Catalog ST 70](#).

Each monitoring relay requires an IO-Link channel.

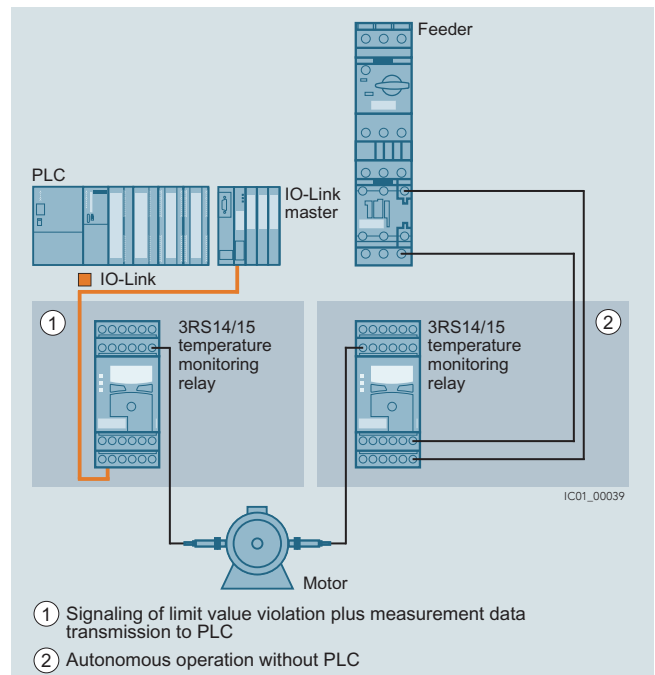

Temperature monitoring relays for IO-Link

Notes on security

In order to protect plants, systems, machines and networks against cyber threats, it is necessary to implement – and continuously maintain – a holistic, state-of-the-art industrial security concept. Siemens products and solutions represent only one component of such a concept.

For more information on Industrial Security, see [www.usa.siemens.com/industrialsecurity](http://www.usa.siemens.com/industrialsecurity).

## Relays

# SIRIUS 3RS14, 3RS15 Temperature Monitoring Relays for IO-Link

### General data

#### Article No. scheme

Product versions	Article number
<b>Temperature monitoring relays</b>	<b>3RS</b> □ □ □ □ - □ □ □ □ 0
Device type	e.g. 14 = digitally adjustable, 1 sensor □ □
Version and type of sensor	e.g. 40 = one threshold value, Pt100/Pt1000, KTY83/KTY84, NTC □ □
Connection type	Screw terminals
	Spring-type terminals (push-in)
Number and type of outputs	e.g. H = 1 CO □
Control supply voltage	e.g. B = 24 V DC □
Measuring range	e.g. 5 = -50 ... +750 °C □
Example	<b>3RS 1 4 4 0 - 1 H B 5 0</b>

#### Note:

The Article No. scheme shows an overview of product versions for better understanding of the logic behind the article numbers.

For your orders, please use the article numbers quoted in the selection and ordering data.

### Technical specifications

#### More information

Technical specifications, see <https://support.industry.siemens.com/cs/ww/en/ps/16370/td>  
 Manual and internal circuit diagrams, see <https://support.industry.siemens.com/cs/ww/en/view/54375463>

FAQs, see <https://support.industry.siemens.com/cs/ww/en/ps/16370/faq>

#### Connection for resistance sensors

##### Two-wire measurement

When two-wire temperature sensors are used, the resistances of the sensor and wiring are added. The resulting systematic error must be taken into account when the signal evaluation unit is calibrated. A jumper must be clamped between terminals T2 and T3 for this purpose.

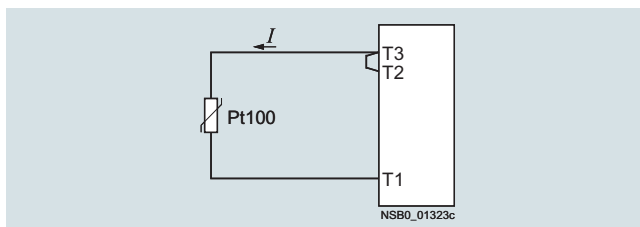

##### Wiring errors

The errors that are generated by the wiring comprise approximately 2.5 K/. If the resistance of the cable is not known and cannot be measured, the wiring errors can also be estimated using the following table.

Temperature drift dependent on the length and cross-section of the cable with Pt100 sensors and an ambient temperature of 20 °C, in K:

Cable length in m	Cross-section mm <sup>2</sup>			
	0.5	0.75	1	1.5
	Temperature drift in K:			
0	0	0	0	0
10	1.8	1.2	0.9	0.6
25	4.5	3.0	2.3	1.5
50	9.0	6.0	4.5	3.0
75	13.6	9.0	6.8	4.5
100	18.1	12.1	9.0	6.0
200	36.3	24.2	18.1	12.1
500	91.6	60.8	45.5	30.2

Example: On a Pt100 sensor with a cable length of 10 m and a conductor cross-section of 1 mm<sup>2</sup> the temperature drift equals 0.9 K.

##### Three-wire measurement

To minimize the effects of the line resistances, a three-wire circuit is often used. Using the additional cable, two measuring circuits can be formed of which one is used as a reference. The signal evaluation unit can then automatically calculate the line resistance and take it into account.

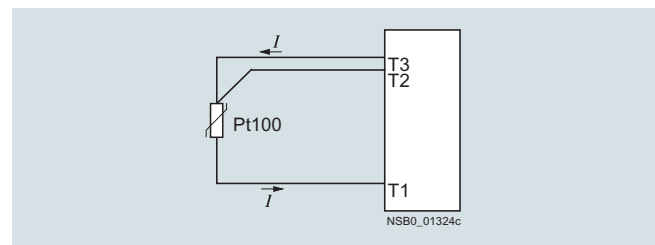

General data

**Connection of thermocouples**

Based on the thermo-electrical effect, a differential temperature measurement will be performed between the measuring point and the signal evaluation unit.

This principle assumes that the signal evaluation unit knows the temperature at the clamping point (T2). For this reason, the 3RS15 temperature monitoring relay has an integral compensator that determines this comparison temperature and builds it into the result of the measurement. The thermal sensors and cables must be insulated therefore.

The absolute temperature is therefore calculated from the ambient temperature of the signal evaluation unit and the temperature difference measured by the thermocouple.

Temperature detection is therefore possible (T1) without needing to know the precise ambient temperature of the clamping point at the signal evaluation unit (T2).

The connecting cable is only permitted to be extended using connecting leads that are made from the same material as the thermocouple. If a different type of conductor is used, an error will result in the measurement.

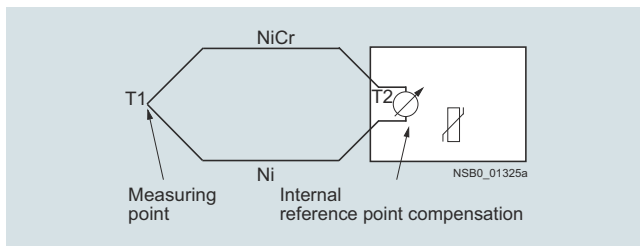

**Principle of operation**

When the temperature has reached the set upper limit value  $\vartheta_1$ , the K1 output relay changes its switching state after the configured time  $t$  has expired. The delay time can be adjusted. The K2 output relay responds in the same manner to the lower limit value of  $\vartheta_2$ .

The output relays return immediately to their original state (the RESET response is configured at Auto RESET) once the temperature reaches the respective hysteresis value.

Both thresholds  $\vartheta_1$  and  $\vartheta_2$  can be parameterized for overshooting or undershooting. This makes it possible to use a limit value for issuing an alarm signal to announce that a limit value is about to be overshoot or undershot. The other limit value can be used for disconnection or to implement two-point or three-point control.

**Note:**

The "Temperature monitoring mode" parameter can be used to set the desired type of monitoring (monitoring for overshooting or undershooting or range monitoring).

With the closed-circuit principle selected

Temperature overshoot

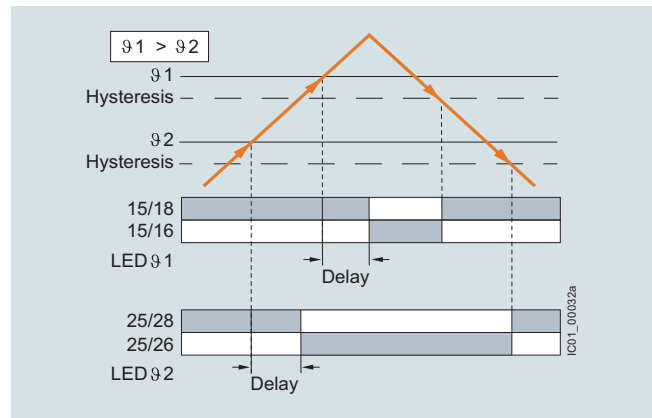

Temperature undershoot

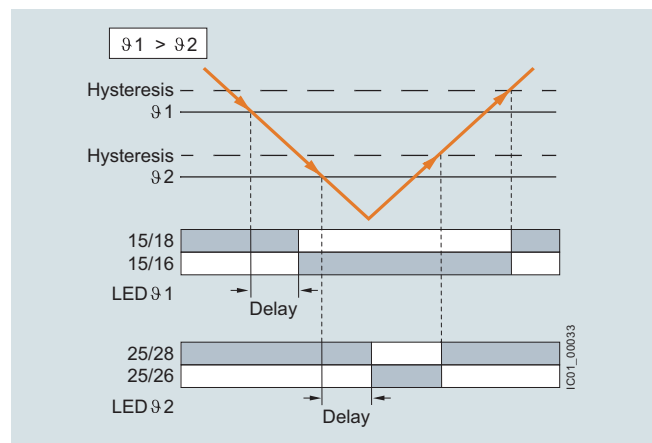

Range monitoring

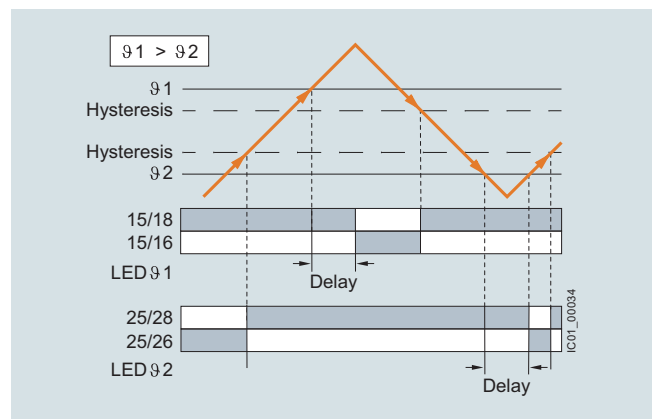

**Memory function**

The digitally adjustable temperature monitoring relays for IO-Link have a memory function. The memory function is illustrated below by the example of a temperature overshoot.

When the temperature has reached the set limit value  $\vartheta_1$ , the output relay K1 changes its switching state after the configured time  $t$  has expired (output relay K2 responds to  $\vartheta_2$  in the same way).

The temperature monitoring relays for IO-Link respond as described below:

- With temperature monitoring relays for IO-Link the memory function is activated as standard (RESET). The output relays only return to the original state when the temperature falls below the set hysteresis value and when one of the following steps is performed:
  - Brief jumpering of the Y3/Y4 terminals
  - Set the rotary knob to "RUN" position and press the right-hand arrow key
  - Perform a RESET via IO-Link
- If the Y3/Y4 terminals are permanently jumpered, the memory function is deactivated (Auto RESET). The output relays return immediately to their original state once a previously occurred fault has been rectified and the temperature falls below the respective hysteresis value.

With the closed-circuit principle selected

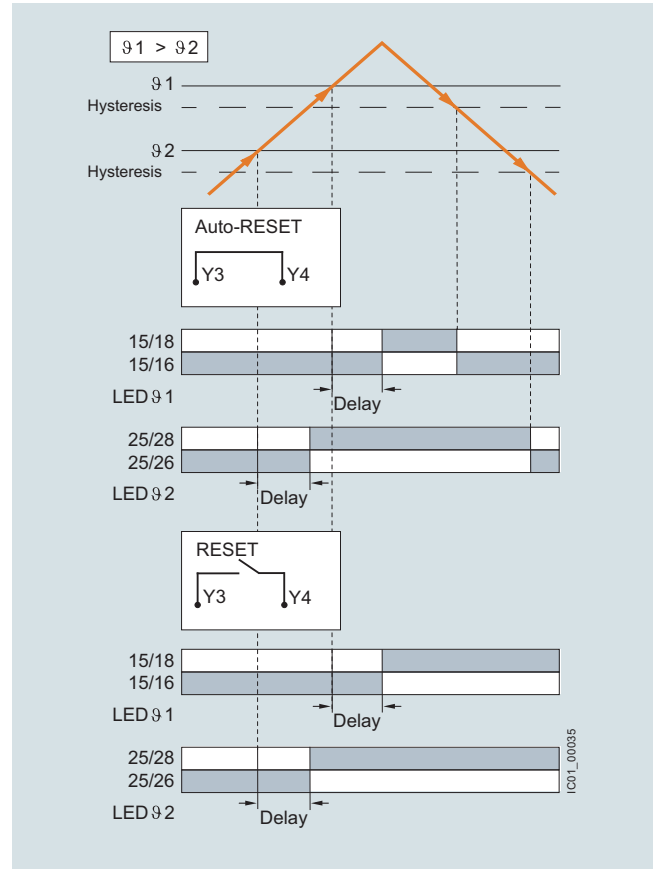

**Characteristic curves**

For resistance sensors

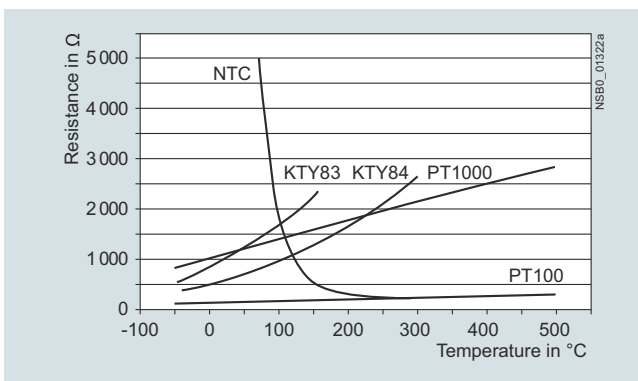

The short-circuit and open-circuit detection as well as the measuring range is limited, depending on the sensor type. Measuring ranges for resistance sensors

Sensor type	Short circuit	Open circuit	3RS1440, 3RS1441	
			Measuring range in °C	Measuring range in °F
Pt100	✓	✓	-50 ... +750	-58 ... +1 382
Pt1000	✓	✓	-50 ... +500	-58 ... +932
KTY83-110	✓	✓	-50 ... +175	-58 ... +347
KTY84	✓	✓	-40 ... +300	-40 ... +572
NTC <sup>1)</sup>	✓	--	+80 ... +160	+176 ... +320

- ✓ Detection possible
- Detection not possible

<sup>1)</sup> NTC type: B57227-K333-A1 (100 °C: 1.8 kΩ; 25 °C: 32.762 kΩ).



General data

For thermocouples

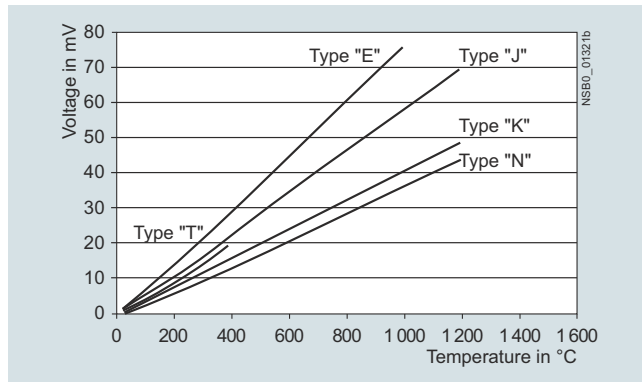

Characteristic curves for sensor types K, N, J, E and T

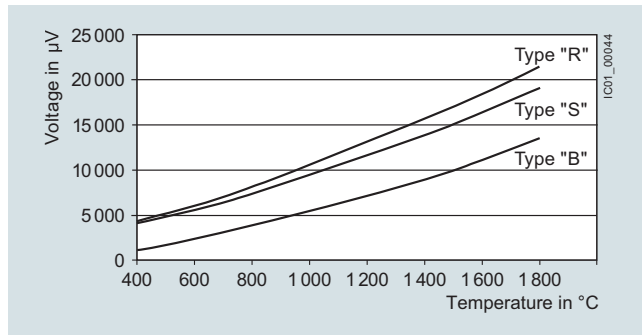

Characteristic curves for sensor types S, R and B

Measuring ranges for thermocouples

Sensor type	Short circuit	Open circuit	3RS1540 Measuring range in °C	Measuring range in °F
K	--	✓	-99 ... +1 350	-146.2 ... +2 462
N	--	✓	-99 ... +1 300	-146.2 ... +2 372
J	--	✓	-99 ... +1 200	-146.2 ... +2 192
E	--	✓	-99 ... +999	-146.2 ... +1 830.2
T	--	✓	-99 ... +400	-146.2 ... +752
S	--	✓	0 ... 1 750	32 ... 3 182
R	--	✓	0 ... 1 750	32 ... 3 182
B	--	✓	400 ... 1 800	752 ... 3 272

- ✓ Detection possible
- Detection not possible

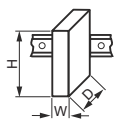
Type	3RS14, 3RS15	
<b>General technical specifications</b>		
Dimensions (W x H x D)		
• Screw terminals	mm	45 x 106 x 91
• Spring-type terminals	mm	45 x 108 x 91
		
<b>Permissible ambient temperature</b>		
• During operation	°C	-25 ... +60
<b>Connection type</b>		<b>Screw terminals</b>
• Terminal screw		M3 (for standard screwdriver, size 2 and Pozidriv 2)
• Solid	mm <sup>2</sup>	1 x (0.5 ... 4), 2 x (0.5 ... 2.5)
• Finely stranded with end sleeve	mm <sup>2</sup>	1 x (0.5 ... 2.5), 2 x (0.5 ... 1.5)
• AWG cables, solid or stranded	AWG	2 x (20 ... 14)
• Tightening torque	Nm	0.8 ... 1.2
<b>Connection type</b>		<b>Spring-type terminals</b>
• Solid	mm <sup>2</sup>	2 x (0.25 ... 1.5)
• Finely stranded, with end sleeve acc. to DIN 46228	mm <sup>2</sup>	2 x (0.25 ... 1.5)
• Finely stranded	mm <sup>2</sup>	2 x (0.25 ... 1.5)
• AWG cables, solid or stranded	AWG	2 x (24 ... 16)

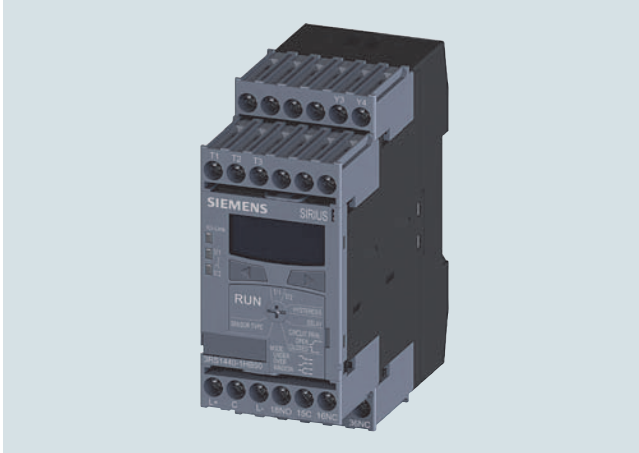
**Overview**

SIRIUS 3RS1440 digital monitoring relay for 1 sensor

The 3RS14 and 3RS15 temperature monitoring relays for IO-Link are used to measure temperatures in solid, liquid and gas media. The temperatures are acquired by means of sensors in the medium, evaluated by the device and monitored for overshooting or undershooting a working range (window function). The digital temperature monitoring relays have two separately adjustable limit values, are non-volatile and can be operated as desired using the open- or closed-circuit principle.

The devices differ in terms of the number of temperature sensors which can be evaluated. The 3RS1440 and 3RS1540 for IO-Link temperature monitoring relays can be digitally adjusted for one sensor and represent an alternative to temperature controllers in the low-end range (two-point or three-point control).

The devices with two-point control can, for example, be used as a thermostat. The devices with three-point control can, for example, independently switch between heating and cooling.

The 3RS1441 temperature monitoring relays for IO-Link can be digitally adjusted to evaluate up to three resistance sensors at one time. The devices were designed specifically for monitoring motor windings and positions.

The temperature monitoring relays are powered through the control supply voltages IO-Link (L+) and ground (L-) or via an external 24 V DC power supply.

**Monitoring**

When the temperature has reached the set limit value  $\vartheta_1$ , the output relay K1 changes its switching state after the configured time  $t$  has expired (output relay K2 responds to  $\vartheta_2$  in the same way). The delay time can be adjusted.

The output relays return immediately to their original state once the temperature reaches the respective hysteresis value.

When the temperature has reached the upper limit value  $\vartheta_1$ , the output relay K1 changes its switching state after the configured time  $t$  has expired. The output relay returns immediately to its original state once the temperature reaches the respective hysteresis value.

The K2 output relay responds in the same manner to the lower limit value of  $\vartheta_2$ . Both thresholds  $\vartheta_1$  and  $\vartheta_2$  can be parameterized for overshooting or undershooting. This makes it possible to use a limit value for issuing an alarm signal to announce that a limit value is about to be overshoot or undershot.

**Note:**

The "Temperature monitoring mode" parameter can be used to set the desired type of monitoring (monitoring for overshooting or undershooting or range monitoring).

**Benefits**

- Very simple operation without complicated menu selections
- Two- or three-point control can be parameterized quickly
- All versions with removable terminals
- All versions with screw or spring-type terminals

**Application**

The temperature monitoring relays can be used in almost any application in which temperature overshoot or undershoot is not permitted, e.g. in the monitoring of set temperature limits and the output of alarm messages for:

- Plant and environment protection
- Temperature limits for process variables e.g. in the packaging industry or electroplating
- Temperature limits for district heating plants
- Exhaust temperature monitoring
- Controlling equipment and machines such as heating, climate and ventilation systems, solar collectors, heat pumps or warm water supplies
- Motor, bearing and gear oil monitoring
- Monitoring of coolants

## Technical specifications

Type		3RS1440	3RS1540
<b>Auxiliary circuit</b>			
<b>Rated operational currents <math>I_e</math></b>			
• AC-15/24 ... 250 V	A	3	
• DC-13 at			
- 24 V	A	1	
- 125 V	A	0.2	
- 250 V	A	0.1	
<b>Evaluation unit</b>			
<b>Measuring accuracy at 20 °C ambient temperature (T20)</b>		< ± 2 K, ± 1 digit	< ± 5 K, ± 1 digit
<b>Reference point accuracy</b>		--	< ± 5 K
<b>Deviations due to ambient temperature</b> In % of measuring range	%	0.05 °C per K deviation from T20	
<b>Measuring cycle</b>	ms	500	
<b>Hysteresis settings</b> for temperature	K	1 ... 99, for both values	
<b>Adjustable delay time</b>	s	0 ... 999.9	
<b>Sensor circuit</b>			
<b>Typical sensor current</b>			
• Pt100	mA	1	--
• Pt1000/KTY83/KTY84/NTC	mA	0.2	--
<b>Open-circuit detection</b>		✓ <sup>1)</sup>	✓
<b>Short-circuit detection</b>		✓	--
<b>Three-wire conductor connection</b>		✓ <sup>2)</sup>	--
<b>Enclosure</b>			
<b>Rated insulation voltage <math>U_i</math></b> Pollution degree 2	V AC	300	

✓ Available

-- Not available

1) Not for NTC type B57227-K333-A1 (100 °C: 1.8 kΩ; 25 °C: 32.762 kΩ).

2) Two-wire connection of resistance sensors with wire jumper between T2 and T3.

**Selection and ordering data**

- To monitor temperatures with a resistance sensor or thermocouple
- Temperature range dependent on sensor type  
- 99 to + 1 800 °C or - 146.2 to + 3 272 °F
- Short-circuit and open-circuit detection in sensor circuit
- Adjustable via IO-Link and locally, with illuminated LCD
- Power supply with 24 V DC via IO-Link or external auxiliary voltage
- Overshoot, undershoot or range monitoring adjustable
- Exact sensor type can be set
- 2 limit values, can be adjusted separately
- Adjustable open-/closed-circuit principle
- Can be adjusted by Manual or remote RESET (via an external contact)
- Actual value, tripping state for control displayed and conveyed, adjustable in °C or °F
- 1 CO contact per limit value
- 1 CO contact for monitoring sensors and devices

PU (UNIT, SET, M) = 1  
PS\* = 1 unit



3RS1440-1HB50





3RS1540-1HB80



3RS1440-2HB50



3RS1540-2HB80

Sensors	Measuring range (limit of measuring range dependent on sensor)	Adjustable hysteresis for 91 and 92	Tripping delay time adjustable for 91 and 92 DELAY	Supply voltage $U_s$	SD	Screw terminals 	SD	Spring-type terminals 		
		K	s	V DC	d	Article No.	Price per PU	d	Article No.	Price per PU
<b>Temperature monitoring relay, digitally adjustable for a sensor, non-volatile fault storage can be selected</b>										
Pt100/Pt1000, KTY83/KTY84, NTC (resistance sensor) <sup>1)</sup>	- 50 ... + 750 °C or - 58 ... + 1 382 °F	0 ... 99	0 ... + 999.9	24	2	<b>3RS1440-1HB50</b>	2	<b>3RS1440-2HB50</b>		
Type B, E, J, K, N, R, S, T (thermocouples)	- 99 ... + 1 800 °C or - 146.2 ... + 3 272 °F	0 ... 99	0 ... + 999.9	24	2	<b>3RS1540-1HB80</b>	2	<b>3RS1540-2HB80</b>		

<sup>1)</sup> NTC type B57227-K333-A1 (100 °C: 1.8 kΩ; 25 °C: 32.762 kΩ).

For accessories, see page 11/14.

## Overview

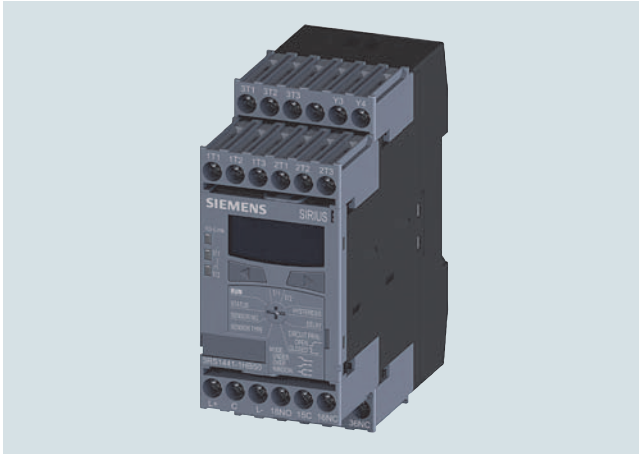

SIRIUS 3RS1441 digital temperature monitoring relay for up to 3 sensors

The 3RS14 temperature monitoring relays can be used to measure temperatures in solid, liquid and gas media. The temperatures are acquired by means of sensors in the medium, evaluated by the device and monitored for overshooting or undershooting a working range (window function).

The devices can be parameterized to indicate the measured temperature in °C or °F. The 3RS1441 evaluation unit can evaluate up to 3 resistance sensors at the same time.

## Benefits

- Very simple operation without complicated menu selections
- Space-saving with 45 mm width
- Two- or three-point control can be parameterized quickly
- All versions with removable terminals
- All versions with screw or spring-type terminals

## Application

The 3RS1441 temperature monitoring relays can be used almost anywhere where several temperatures must be monitored at one time for overshooting, undershooting or staying within a certain range.

Monitoring of set temperature limits and output of alarm messages for:

- Plant and environment protection
- Temperature limits for process variables e.g. in the packaging industry or electroplating
- Controlling equipment and machines such as heating, climate and ventilation systems, solar collectors, heat pumps or warm water supplies
- Motor, bearing and gear oil monitoring
- Monitoring of coolants

## Technical specifications

Type	3RS1441	
<b>Auxiliary circuit</b>		
<b>Rated operational currents <math>I_e</math></b>		
• AC-15/24 ... 250 V	A	3
• DC-13 at		
- 24 V	A	1
- 125 V	A	0.2
- 250 V	A	0.1
<b>DIAZED fuse protection</b>		
• Operational class gG	A	4
<b>Evaluation unit</b>		
<b>Measuring accuracy at 20 °C ambient temperature (T20)</b>		< ±2 K, ±1 digit
<b>Deviations due to ambient temperature</b> In % of measuring range	%	0.05 per K deviation from T20
<b>Measuring cycle</b>	ms	500
<b>Hysteresis settings</b> for temperature 1	K	1 ... 99, for both values
<b>Adjustable delay time</b>	s	0 ... 999.9
<b>Sensor circuit</b>		
<b>Typical sensor current</b>		
• Pt100	mA	1
• Pt1000/KTY83/KTY84/NTC	mA	0.2
<b>Open-circuit detection</b>		✓ <sup>1)</sup>
<b>Short-circuit detection</b>		✓
<b>Three-wire conductor connection</b>		✓ <sup>2)</sup>
<b>Enclosure</b>		
<b>Rated insulation voltage <math>U_i</math></b> Pollution degree 2	V AC	300

✓ Available

<sup>1)</sup> Not for NTC type B57227-K333-A1 (100 °C: 1.8 kΩ; 25 °C: 32.762 kΩ).

<sup>2)</sup> Two-wire connection of resistance sensors with wire jumper between T2 and T3.

# SIRIUS 3RS14, 3RS15 Temperature Monitoring Relays for IO-Link

Relays, digitally adjustable for up to 3 sensors

### Selection and ordering data

- For temperature monitoring with up to 3 resistance sensors
- Temperature range dependent on sensor type  
- 50 to + 750 °C or - 58 to + 1 382 °F
- Short-circuit and open-circuit detection in sensor circuit
- Adjustable via IO-Link and locally, with illuminated LCD
- Power supply with 24 V DC via IO-Link or external auxiliary voltage
- Overshoot, undershoot or range monitoring adjustable
- Exact sensor type and number of sensors can be set
- 2 limit values, can be adjusted separately
- Adjustable open-/closed-circuit principle
- Can be adjusted by manual or remote RESET (via an external contact)
- Actual value, tripping state for control displayed and conveyed, adjustable in °C or °F
- 1 CO contact per limit value
- 1 CO contact for monitoring sensors and devices



PU (UNIT, SET, M) = 1  
PS\* = 1 unit



3RS1441-1HB50



3RS1441-2HB50

Sensors	Number of sensors that can be set	Measuring range (limit of measuring range dependent on sensor)	Adjustable hysteresis for 91 and 92	Tripping delay time adjustable for 91 and 92 DELAY	Supply voltage $U_s$	SD	<b>Screw terminals</b> 	SD	<b>Spring-type terminals</b> 		
			K	s	V DC	d	Article No.	Price per PU	d	Article No.	Price per PU





**Temperature monitoring relay, digitally adjustable for up to 3 sensors, non-volatile fault storage can be selected**

Pt100/Pt1000, KTY83/KTY84, NTC (resistance sensor) <sup>1)</sup>	1 ... 3 sensors	-50 ... +750 °C or -58 ... +1 382 °F	0 ... 99	0 ... 999.9	24	2	<b>3RS1441-1HB50</b>	2	<b>3RS1441-2HB50</b>
--	-----------------	--------------------------------------	----------	-------------	----	---	----------------------	---	----------------------

<sup>1)</sup> NTC type: B57227-K333-A1 (100 °C: 1.8 kΩ; 25 °C: 32.762 kΩ).

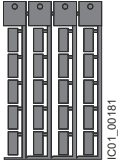
For accessories, see page 11/25.

**Selection and ordering data**

Use	Version	SD	Article No.	Price per PU	PU (UNIT, SET, M)	PS*
<b>Blank labels</b>						
 3RT2900-1SB20	For 3RS14 and 3RS15	<b>Unit labeling plates</b> For SIRIUS devices 20 mm x 7 mm, titanium gray	20	<b>3RT2900-1SB20</b>	100	340 units
	For 3RS14 and 3RS15	<b>Adhesive labels</b> for SIRIUS devices <ul style="list-style-type: none"> <li>• 19 mm x 6 mm, pastel turquoise</li> <li>• 19 mm x 6 mm, zinc yellow</li> </ul>	15	<b>3RT1900-1SB60</b>	100	3 060 units
			15	<b>3RT1900-1SD60</b>	100	3 060 units
<b>Push-in lugs and covers</b>						
 3RP1903	For 3RS14 and 3RS15	<b>Push-in lugs</b> For screw fixing, 2 units are required for each device	5	<b>3RP1903</b>	1	10 units
<b>Tools for opening spring-type terminals</b>						
 3RA2908-1A	For auxiliary circuit connections	<b>Screwdrivers</b> For all SIRIUS devices with spring-type terminals 3.0 mm x 0.5 mm, length approx. 200 mm, titanium gray/black, partially insulated	2	<b>Spring-type terminals</b>  <b>3RA2908-1A</b>	1	1 unit

For matching sensors, see [www.usa.siemens.com/temperature](http://www.usa.siemens.com/temperature).



## Overview



SIRIUS 3RN2 thermistor motor protection

### More information

Homepage, see [www.usa.siemens.com/relays](http://www.usa.siemens.com/relays)  
 Industry Mall, see [www.siemens.com/product?3RN2](http://www.siemens.com/product?3RN2)  
 For the conversion tool, e.g. from 3RN1 to 3RN2, see [www.siemens.com/sirius/conversion-tool](http://www.siemens.com/sirius/conversion-tool)

Thermistor motor protection devices are used for direct monitoring of the motor winding temperature. For this purpose, the motors are equipped with temperature-dependent resistors (PTC) that are directly installed in the motor winding and abruptly change their resistance at their temperature limit.

### Article No. scheme

Product versions		Article number								
Thermistor motor protection relay with PTC sensor, type A		3RN20 □ □ - □ □ □ □ □								
Number and version of the sensor circuits	1 sensor circuit, supply voltage = root voltage	0								
	1 sensor circuit	1								
	2 sensor circuits for warning and disconnection	2								
RESET	Auto RESET	0								
	Manual RESET, with open-circuit and short-circuit detection	1								
	Manual/Auto/Remote RESET, non-volatile, with open-circuit and short-circuit detection	2								
	Manual/Auto/Remote RESET, non-volatile, with open-circuit and short-circuit detection, with protective separation	3								
Connection method	Screw terminals			1						
	Spring-type terminals (push-in)			2						
Auxiliary switches	1 CO					A				
	2 CO					B				
	1 NO + 1 NC					C				
	1 NO + 1 CO					D				
	2 CO, hard gold-plated					G				
Rated control supply voltage	24 V AC/DC					A	3			
	24 ... 240 V AC/DC					W	3			
Response to failure	Monostable						0			
	Bistable						1			
Example		3RN20	0	0	-	1	A	A	3	0

### Note:

The Article No. scheme is presented here merely for information purposes and for better understanding of the logic behind the article numbers.

### Versions

SIRIUS 3RN2 thermistor motor protection relays are available in the following versions:

- 3RN2000 compact evaluation unit
- 3RN2010 compact/standard evaluation unit
- 3RN2012-.BW31 bistable evaluation unit
- 3RN2011, 3RN2012-...30, 3RN2013 standard evaluation unit with ATEX approval
- 3RN2023 evaluation unit with ATEX approval and 2 sensor circuits for warning and disconnection

They comply with

- IEC 60947-8. Low-voltage switchgear and controlgear – Part 8: "Control units for built-in thermal protection (PTC) for rotating electrical machines"
- IEC 61000-6-2, IEC 61000-6-4. "Electromagnetic compatibility for industrial-process measurement and control equipment"

The 3RN2 thermistor motor protection relays with ATEX approval fulfill SIL1 in compliance with EN 50495.

The terminals of the auxiliary contacts are designated in accordance with EN 60947-1.

3RN2 evaluation units are suitable for snap-on mounting onto TH 35 standard mounting rails according to IEC 60715 or for screw fixing using an adapter (accessory).

For your orders, please use the article numbers quoted in the selection and ordering data.

**Benefits**

- Thanks to direct motor protection, overdimensioning of the motors is not necessary
- No settings on the device are necessary
- Semiconductor compatible output thanks to versions with hard gold-plated contacts
- Rapid error diagnosis thanks to versions that indicate open and short circuits in the sensor circuit
- All versions with removable terminals
- All versions with screw or spring-type terminals with push-in functionality

**Application**

Direct motor protection through temperature monitoring of the motor winding offers 100% motor protection even under the most difficult ambient conditions, without the need to make adjustments on the device. Versions with hard gold-plated contacts ensure, in addition, a high switching reliability that is even higher than an electronic control.

Direct motor protection

- At increased ambient temperatures
- When switching frequency is too high
- When start up and braking procedures are too long

**ATEX approval for operation in areas subject to explosion hazard**

The SIRIUS 3RN2011, 3RN2012-...30, 3RN2013 and 3RN2023 thermistor motor protection relays for PTC sensors are certified according to ATEX Ex II (2) G and D for environments with explosive gas or dust loads.

**Motor protection using current- and temperature-dependent protective devices**

IEC 60204 stipulates that motors must be protected from overheating at a rating of 0.5 kW and higher. The protection can take the form of overload protection, overtemperature protection or current limiting.

For motors with frequent starting and braking and in environments where cooling may be impaired (e.g. by dust), it is recommended to use the overtemperature protection option in the form of a protective device coordinated with this mode of operation. A good choice in this case is the use of 3RN2 thermistor motor protection devices.

On rotor-critical motors, overtemperature detection in the stator windings can lead to delayed and hence inadequate protection. In this case the standards stipulate additional protection, e.g. by means of an overload relay.

This combination of thermistor motor protection and an overload relay is recommended for full motor protection in case of frequent starting and braking of motors, irregular intermittent duty or excessive switching frequency. To prevent premature tripping of the overload relay in such operating conditions, a higher setting than that normally required for the operational current is chosen. The overload relay then performs stall protection, and the 3RN2 thermistor motor protection relay monitors the temperature of the motor windings.

Application	Motor protection		
	Only current-dependent, e.g. with overload relay	Temperature-dependent only, e.g. with thermistor motor protection relay	Current- and temperature-dependent
Motor protection in case of			
Overloading in uninterrupted duty	✓	✓	✓
Long start up and braking operations	○	✓	✓
Irregular intermittent duty	○	✓	✓
Excessively high switching frequency	○	✓	✓
Single-phase operation and current unbalance	✓	✓	✓
Voltage and frequency fluctuations	✓	✓	✓
Stalling of the rotor	✓	✓	✓
Switching on a stalled rotor of a stator-critical motor	✓	✓	✓
Switching on a stalled rotor of a rotor-critical motor	✓	○	✓
Elevated ambient temperature	--	✓	✓
Impeded cooling	--	✓	✓

- ✓ Full protection
- Conditional protection
- No protection

## Technical specifications

## More information

Technical specifications, see <https://support.industry.siemens.com/cs/ww/en/ps/24302/td>  
 Operating instructions and internal circuit diagrams, see <https://support.industry.siemens.com/cs/ww/en/ps/24302/man>

FAQs, see <https://support.industry.siemens.com/cs/ww/en/ps/24302/faq>  
 For more information on explosion protection (ATEX), see [www.siemens.com/sirius/atex](http://www.siemens.com/sirius/atex)

## Type A PTC temperature sensor

If a Type A temperature sensor is connected to a Type A evaluation unit, compliance with the operating temperatures is assured (on pick-up and reset) according to IEC 60947-8.

The characteristic curves of the Type A temperature sensors are described in IEC 60947-8, EN 44081 and EN 44082 standards.

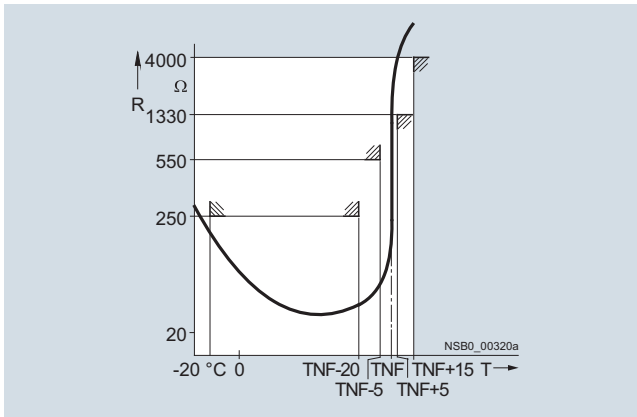

Characteristic curve of the 3RN2 evaluation unit

## Bimetallic switch

In some applications, bimetallic switches (e.g. Klixon, Thermo-click) are used as sensors instead of PTC temperature sensors. Bimetallic switches are temperature- and current-dependent NC contacts and are available for different temperature ranges. Because bimetallic switches have practically no resistance below their opening temperature, short-circuit detection is not possible when using bimetallic switches. A bimetallic switch can be used for versions 3RN2000 and 3RN2010 on the SIRIUS thermistor motor protection relay.

## Note:

Never use bimetallic switches in applications subject to an explosion hazard! Because of their non-standardized tripping characteristic, bimetallic switches must not be used in applications where there is an explosion hazard. Use Type A PTC sensors instead!

## Use in hazardous areas

Increased danger in hazardous areas means it is necessary to observe the following notes and standards carefully:

- EN 60079-14/VDE 0165-1 for electrical apparatus for explosive gas atmospheres
- EN 60079-17 Explosive atmospheres – Electrical installations inspection and maintenance
- EN 50495 Safety devices required for the safe functioning of equipment with respect to explosion risks

The following SIRIUS 3RN2 thermistor motor protection relays with short-circuit detection are approved for Equipment Group II, Category (2) in Area "G" (areas in which potentially explosive gas, vapor, mist, or air mixtures are present) and are additionally approved for Area "D" (areas containing combustible dust):

- 3RN2011
- 3RN2012-...30
- 3RN2013
- 3RN2023

PTB 15 ATEX 3011 ex II (2) G (Ex E) (EX d) (Ex px)  
 PTB 15 ATEX 3011 ex II (2) D (Ex T) (Ex p)

For 3RN2 thermistor motor protection relays, the EC type examination certificate is available for Group II, Category (2) G [Ex e] [Ex d] [Ex px] and D [Ex t] [Ex p]. The number is PTB 15 ATEX 3011.

SIRIUS 3RN2 thermistor motor protection relays are not intended for installation in hazardous areas. If they are installed in a potentially explosive atmosphere, the SIRIUS 3RN2 thermistor motor protection relays must be adapted to the applicable type of protection.

The machine or plant must shut down immediately if the SIRIUS 3RN2 thermistor motor protection relay is tripped, even if connected through a frequency converter. This must be implemented with circuitry.

SIRIUS 3RN2 thermistor motor protection relays with functional safety in accordance with EN 50495 are suitable for protecting explosion-proof motors/machines.

On evaluation units with a supply voltage of 24 V AC/DC, you must ensure electrical separation with a battery network or a power supply unit with electrical separation (e.g. isolating transformer) (does not apply to 3RN2013-BA30).

A SIRIUS 3RN2 thermistor motor protection relay set to "automatic RESET" mode will be reset automatically after the recovery time has elapsed, without the RESET button being pressed. An additional ON button has to be used to ensure that the motor does not start up automatically following tripping. "Automatic RESET" mode must not be used in applications where there is a risk of personal injury or damage to property if the motor restarts unexpectedly.

**⚠ NOTICE!**

When used in a hazardous area, the thermistor motor protection relay must not be operated with automatic RESET (terminal Y1 and Y2 permanently jumpered).

A risk analysis must be performed for the complete plant or machine. If this analysis yields a lower hazard potential (category 1), all SIRIUS 3RN2 thermistor motor protection relays can be used, provided the safety regulations are observed.

**⚠ WARNING!**

All work involved in connecting, commissioning and maintenance must be carried out by qualified, responsible personnel. Improper handling may result in serious personal injury and considerable damage to property.

**Cable routing**

The measuring circuit leads must be routed as separate control cables. It is not permitted to use cores from the supply line of the motor or any other main supply cables. If extreme inductive or capacitive interference is expected as a result of power lines routed in parallel, shielded control cables must be used.

Maximum length of sensor circuit cables for evaluation units without short-circuit detection in the sensor circuit:

Cable cross-section	3RN2000, 3RN2010
2.5 mm <sup>2</sup>	2 x 2800 m
1.5 mm <sup>2</sup>	2 x 1500 m
0.5 mm <sup>2</sup>	2 x 500 m

Maximum length of sensor circuit cables for evaluation units with short-circuit detection<sup>1)</sup>

Cable cross-section	3RN2011, 3RN2012, 3RN2013, 3RN2023
2.5 mm <sup>2</sup>	2 x 250 m
1.5 mm <sup>2</sup>	2 x 150 m
0.5 mm <sup>2</sup>	2 x 50 m

<sup>1)</sup> A short circuit in the sensor circuit will be detected up to this maximum cable length.

**Principle of operation**

SIRIUS 3RN2 thermistor motor protection relays are thermal protection devices that are suitable, in combination with type A PTC thermistors, for monitoring temperatures of electrical drives, transformer windings, oils, bearings, air, etc.

The most frequent application is monitoring of three-phase motors in which the motor manufacturer has fitted a PTC sensor into every winding overhang and in which these PTC sensors are connected in series.

The SIRIUS 3RN2 thermistor motor protection relays operate in accordance with the closed-circuit principle and therefore monitor themselves for loss of supply voltage. The exceptions are the warning output on 3RN2023, which always works on the open-circuit principle and the bistable relays of the 3RN2012-.BW31, which always retain the last switching state.

A micro-interruption in the power supply of less than 30 ms does not change the status of the output relays.

For devices with the "Manual RESET" function, the test function can be activated and a trip simulated by pressing the blue Test/RESET button for > 2 seconds.

The 3RN2011, 3RN2012, 3RN2013 and 3RN2023 devices are additionally equipped with open-circuit and short-circuit detection in the sensor circuit. The unit will trip in the event of a short-circuit (resistance in sensor circuit < 10 Ω) or open circuit in the sensor circuit (dynamic open-circuit detection). Tripping as the result of a short-circuit in the sensor circuit is indicated by a flickering red LED (TRIPPED). In the event of a short-circuit in the sensor circuit for warning on the 3RN2023, the yellow warning LED (WARNING) flickers. The devices with dynamic open-circuit detection evaluate the rise time of the sensor circuit resistance. If the sensor circuit resistance rises from 3 300 Ω to 12 kΩ within 200 ms, the unit will not only trip, but also indicate the open circuit via a flashing red LED (TRIPPED). In the event of an open circuit in a sensor circuit, the yellow warning LED (WARNING) flashes for the 3RN2023.

All evaluation units (except for the 3RN2000 compact evaluation unit) feature electrical separation between the control circuit and the sensor circuit. The relay outputs are also electrically separated from all other circuits. The 3RN2013 and 3RN2023 evaluation units incorporate protective electrical separation between all circuits up to  $U_i = 300$  V.

**3RN2000 compact evaluation unit**

The compact unit, which is only 17.5 mm wide, is equipped with a red LED (TRIPPED) for the tripped indicator and a changeover contact. After the unit has tripped, it is automatically reset once the thermistors have cooled down. The root of the changeover contact is connected to the control voltage (terminal 11 is connected to terminal A1). This unit is particularly suitable in circuits in which the control circuit and signaling circuit have the same potential, e.g. in local control boxes.

**3RN2010, 3RN2011, 3RN2012 and 3RN2013 compact/standard evaluation units**

The units are equipped with two LEDs (READY and TRIPPED) for an operating and tripped display and are available with either 1 NO + 1 NC contacts (3RN2010, overall width 17.5 mm) or with 2 CO contacts. Depending on the version, they are available with Auto RESET (3RN2010), Manual/Remote RESET (3RN2011) or Manual/Auto and Remote RESET (3RN2012 and 3RN2013). Remote RESET can be achieved by connecting an external pushbutton with a normally-open function to terminals Y1 and Y2. If terminals Y1 and Y2 are jumpered, the unit is automatically reset once the thermistors have cooled down (Auto RESET). 3RN2012 and 3RN2013 are non-volatile. This means a previous trip remains stored in the event of a control supply voltage failure – the thermistor motor protection relay remains in the safe state with an opened output relay until it is intentionally reset by pressing the TEST/RESET button of the unit or an external pushbutton.

**3RN2023 "warning and disconnection" evaluation units**

Two sensor circuits can be connected to one 3RN2023 evaluation unit that act on two separate output relays with 1 NO contact for warning and 1 CO contact for disconnection. Thermistors with different rated response temperatures TNF are used to implement the "Warning" and "Disconnection" functions. When sensor circuit 2 for "Warning" responds, a yellow LED is lit and when the "Disconnection" circuit responds, a red LED is lit. The sensor circuits have a different reset response and operating behavior: The "Warning" thermistor sensor circuit 2 (terminals 2T1, T2) works only with Auto RESET and according to the open-circuit principle (output relay K2, NO contact). The "Disconnection" thermistor sensor circuit 1, (terminals 1T1, T2) can be changed from Manual RESET to Auto RESET by jumpering terminals Y1 and Y2. Remote RESET is implemented by connecting an external pushbutton with a normally-open function to these terminals.

Function diagrams

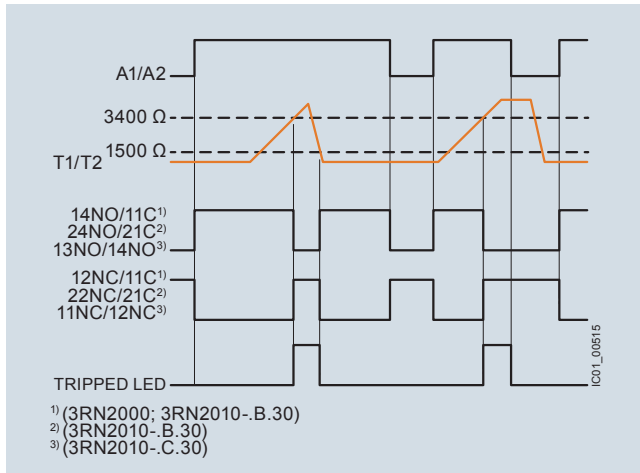

3RN2000, 3RN2010

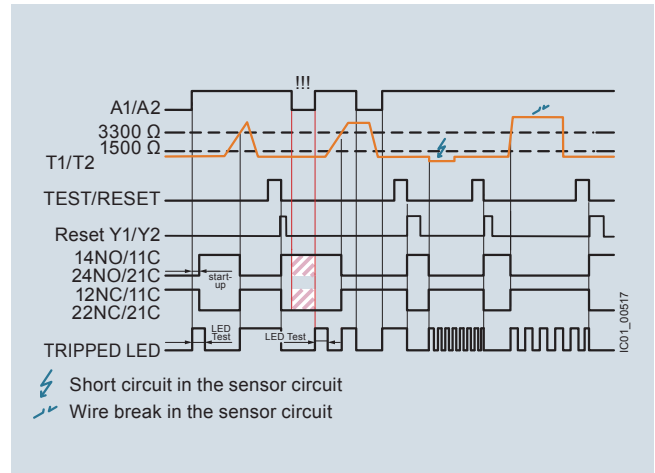

3RN2012-.BW31: resetting via the TEST/RESET button or external pushbutton

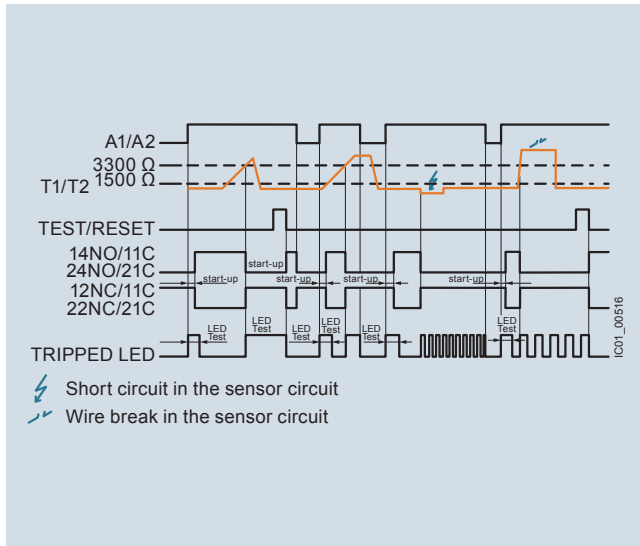

3RN2011: resetting via external pushbutton or interruption of the supply voltage

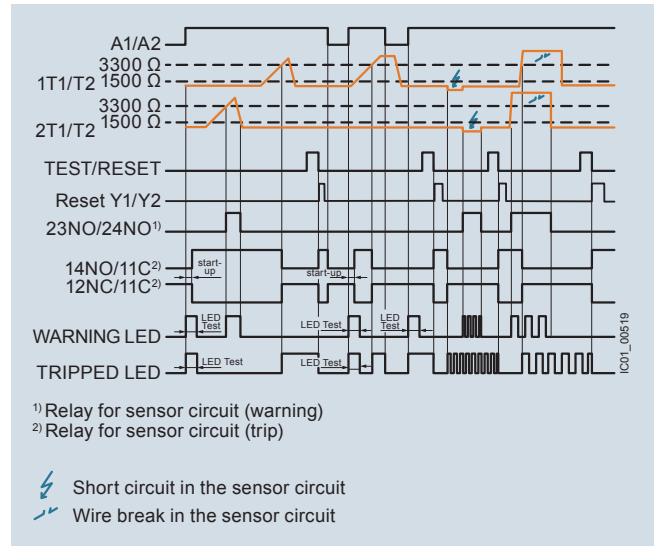

3RN2023: resetting via the TEST/RESET button or external pushbutton

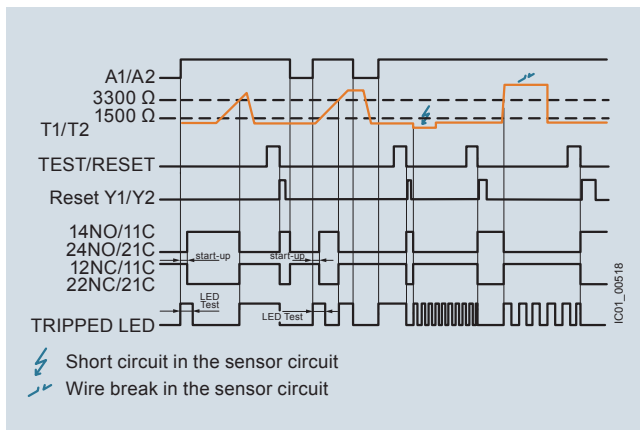

3RN2012-.B.30, 3RN2013: resetting via the TEST/RESET button or external pushbutton

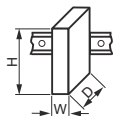

Article number	<b>3RN2000-.A, 3RN2010-.C</b>	<b>3RN201-.B, 3RN2013-.G, 3RN2023-.D</b>
Width x height x depth	mm 100 × 17.5 × 90	100 × 22.5 × 90



Article number	<b>3RN2000-.AA30</b>	<b>3RN2000-.AW30, 3RN2010-.BW30, 3RN2010-.CW30</b>	<b>3RN2010-.BA30, 3RN2010-.CA30</b>	<b>3RN2011-.BA30, 3RN2012-.BA30</b>	<b>3RN2011-.BW30, 3RN2012-.BW30</b>	<b>3RN2012-.BW31</b>	<b>3RN2013-.BA30</b>	<b>3RN2013-.BW30, 3RN2013-.GW30</b>	<b>3RN2023-.DW30</b>
----------------	----------------------	--	---	---	---	----------------------	----------------------	---	----------------------

General technical specifications									
Type of electrical isolation		None	Isolated				Protective separation		
Electrical endurance (operating cycles) for AC-15 at 230 V		100 000							
Mechanical endurance (operating cycles)		10 000 000							
Insulation voltage for overvoltage category III according to IEC 60664 for pollution degree 3 / rated value	V	300							
Impulse withstand voltage, rated value	kV	4				6			
Minimum mains failure buffering time	ms	40						30	
Pollution degree		3							
Degree of protection		IP20							
Vibration resistance acc. to IEC 60068-2-27		11g/15 ms							
Vibration resistance acc. to IEC 60068-2-6		10 ... 55 Hz; 0.35 mm							
Type of mounting		For screw-fixing and snap-on mounting to 35 mm standard mounting rail							
• Mounting position		Any							
• Installation altitude at height above sea level, maximum	m	2 000							
Ambient temperature during operation	°C	-25 ... +60							
Relative humidity during operation, maximum	%	70							
ATEX									
Ex device group and Ex category according to ATEX product directive 2014/34/EU		--		II 2G, II 2D	--		II 2G, II 2D		
Safety device type according to IEC 61508-2		--		Type B	--		Type B		
Safety integrity level (SIL) according to IEC 61508		--		SIL1	--		SIL1		
Performance level (PL) according to EN ISO 13849-1		--		c	--		c		
T1 value for proof test interval or service duration according to IEC 61508	y	--		3	--		3		
Measuring circuit									
Number of measuring circuits		1						2	
Relative measuring accuracy	%	9		2					
Maximum number of sensors in series		6							
Cable length of sensor, maximum	m	2 800		250					
Thermistor resistance response value	Ω	1 500 ... 1 650		1 500 ... 1 550					
Thermistor resistance return value	Ω	3 400 ... 3 600		3 300 ... 3 350					

Article number	3RN2000- .AA30	3RN2000- .AW30, 3RN2010- .BW30, 3RN2010- .CW30	3RN2010- .BA30, 3RN2010- .CA30	3RN2011- .BA30, 3RN2012- .BA30	3RN2011- .BW30, 3RN2012- .BW30	3RN2012- .BW31	3RN2013- .BA30	3RN2013- .BW30, 3RN2013- .GW30	3RN2023- .DW30
<b>Control circuit</b>									
<b>Current carrying capacity of the output relay</b>									
• At AC-15 at 250 V at 50/60 Hz	A	3							
• At DC-13 at 24 V	A	1							
• At DC-13 at 125 V	A	0.2							
• At DC-13 at 250 V	A	0.1							
<b>Thermal current of the non-solid-state contact blocks, maximum</b>	A	5							
<b>Continuous current of the output relay's DIAZED fuse link</b>	A	6							
<b>Supply voltage</b>									
<b>Control supply voltage</b>									
• At AC									
- At 50 Hz rated value	V	24 ... 24	24 ... 240	24 ... 24	24 ... 240		24 ... 24	24 ... 240	
- At 60 Hz rated value	V	24 ... 24	24 ... 240	24 ... 24	24 ... 240		24 ... 24	24 ... 240	
• At DC, rated value	V	24 ... 24	24 ... 240	24 ... 24	24 ... 240		24 ... 24	24 ... 240	
<b>Operating range factor of the control supply voltage, rated value</b>									
• At AC at 50 Hz		0.85 ... 1.1							
• At AC at 60 Hz		0.85 ... 1.1							
• At DC		0.85 ... 1.1							

Article number	3RN20..-1	3RN20..-2
<b>Type of electrical connection</b>	 Screw terminals	 Spring-type terminals (push-in)
<b>Tightening torque</b>	Nm 0.6 ... 0.8	--
<b>Type of connectable conductor cross-sections</b>		
• Solid	mm <sup>2</sup> 1x (0.5 ... 4.0 mm <sup>2</sup> ), 2x (0.5 ... 2.5 mm <sup>2</sup> )	1x (0.5 ... 4 mm <sup>2</sup> )
• Finely stranded with end sleeve	mm <sup>2</sup> 1x (0.5 ... 4 mm <sup>2</sup> ), 2x (0.5 ... 1.5 mm <sup>2</sup> )	1x (0.5 ... 2.5 mm <sup>2</sup> )
• For AWG cables		
- Solid	AWG 1x (20 ... 12), 2x (20 ... 14)	1x (20 ... 12)
- Stranded	AWG --	1x (20 ... 12)



**Selection and ordering data**



3RN2000-1AA30      3RN2010-1BA30      3RN2011-1BA30      3RN2012-1BW30      3RN2023-1DW30

Product function	Number of CO contacts for auxiliary contacts	Number of NO contacts for auxiliary contacts	Number of NC contacts for auxiliary contacts	Material of switching contacts	Control supply voltage For AC at 50 Hz rated value	Control supply voltage For DC, rated value	SD	Article No.	PU (UNIT, SET, M)	PS*
					V	V	d			

**Compact evaluation unit, suitable for bimetallic switch**

**Terminal A1 jumpered with root of changeover contact**

Auto RESET	1	0	0	AgSnO2	24 ... 24	24 ... 24	2	<b>3RN2000-□AA30</b>	1	1 unit
					24 ... 240	24 ... 240	2	<b>3RN2000-□AW30</b>	1	1 unit
	0	1	1	AgSnO2	24 ... 24	24 ... 24	2	<b>3RN2010-□CA30</b>	1	1 unit
					24 ... 240	24 ... 240	2	<b>3RN2010-□CW30</b>	1	1 unit

**Standard evaluation unit, suitable for bimetallic switch**

Auto RESET	2	0	0	AgSnO2	24 ... 24	24 ... 24	2	<b>3RN2010-□BA30</b>	1	1 unit
					24 ... 240	24 ... 240	2	<b>3RN2010-□BW30</b>	1	1 unit

**Bistable evaluation unit, open-circuit and short-circuit detection in the sensor circuit**

**Does not trigger in the event of control supply voltage failure**

Auto RESET	2	0	0	AgSnO2	24 ... 240	24 ... 240	2	<b>3RN2012-□BW31</b>	1	1 unit
Manual RESET										
External RESET										
Error memory										

**Standard evaluation unit with ATEX approval, open-circuit and short-circuit detection in the sensor circuit<sup>1)</sup>**

Manual RESET	2	0	0	AgSnO2	24 ... 24	24 ... 24	2	<b>3RN2011-□BA30</b>	1	1 unit
External RESET					24 ... 240	24 ... 240	2	<b>3RN2011-□BW30</b>	1	1 unit

**Non-volatile<sup>3)</sup>**

Auto RESET	2	0	0	AgSnO2	24 ... 24	24 ... 24	2	<b>3RN2012-□BA30</b>	1	1 unit
Manual RESET					24 ... 240	24 ... 240	2	<b>3RN2012-□BW30</b>	1	1 unit
External RESET										
Error memory										

**Protective separation, non-volatile<sup>2)3)</sup>**

Auto RESET	2	0	0	AgSnO2	24 ... 24	24 ... 24	2	<b>3RN2013-□BA30</b>	1	1 unit
Manual RESET					24 ... 240	24 ... 240	2	<b>3RN2013-□BW30</b>	1	1 unit
External RESET										
Error memory				AgSnO2 Hard gold-plated	24 ... 240	24 ... 240	2	<b>3RN2013-□GW30</b>	1	1 unit

**Evaluation unit with ATEX approval and 2 sensor circuits for warning and disconnection, open-circuit and short-circuit detection in both sensor circuits**

**Protective separation, non-volatile<sup>2)3)</sup>**

Auto RESET	1	1	0	AgSnO2	24 ... 240	24 ... 240	2	<b>3RN2023-□DW30</b>	1	1 unit
Manual RESET										
External RESET										
Error memory										

**Type of electrical connection**

- Screw terminals
- Spring-type terminals (push-in)







1  
2

<sup>1)</sup> For 3RN2011: The unit can be reset with the RESET button or by disconnecting the control supply voltage.

<sup>2)</sup> Protective separation up to 300 V acc. to DIN/VDE 0160, IEC 60947-1.

<sup>3)</sup> Protection against voltage failure or non-volatile fault storage means that previous tripping due to a fault remains stored even if the control supply voltage fails. The monitoring device is not reset if the voltage fails. With an active fault, meaning a fault which has not been manually confirmed, an automatic restart of the plant upon recovery of the power is prevented therefore and plant safety increased as the result.

Accessories

Version	SD	Article No.	PU (UNIT, SET, M)	PS*
d				
<b>Terminals for SIRIUS devices in the industrial standard mounting rail enclosure</b>				
 3ZY1122-1BA00	<b>Removable terminals</b>		<b>Screw terminals</b> 	
	• 2-pole, up to 2 x 2.5 mm <sup>2</sup> or 1 x 4 mm <sup>2</sup>	2	<b>3ZY1122-1BA00</b>	1 6 units
	<b>Spring-type terminals (push-in)</b> 			
	• 2-pole, up to 1 x 4 mm <sup>2</sup> or 2 x 1.5 mm <sup>2</sup>	2	<b>3ZY1122-2BA00</b>	1 6 units
<b>Accessories for enclosures</b>				
 3ZY1311-0AA00	<b>Push-in lugs</b> For wall mounting		<b>3ZY1311-0AA00</b>	
		2		1 10 units
 3ZY1440-1AA00	<b>Coding pins</b> For removable terminals of SIRIUS devices in the industrial standard mounting rail enclosure. They enable the mechanical coding of terminals, see Manual "SIRIUS 3RN2 thermistor motor protection", <a href="https://support.industry.siemens.com/cs/ww/en/ps/24302/man">https://support.industry.siemens.com/cs/ww/en/ps/24302/man</a>		<b>3ZY1440-1AA00</b>	
		2		1 12 units
<b>Tools for opening spring-type terminals</b>				
 3RA2908-1A	<b>Screwdrivers</b> For all SIRIUS devices with spring-type terminals  3.0 mm x 0.5 mm, length approx. 200 mm, titanium gray/black, partially insulated		<b>Spring-type terminals (push-in)</b> 	
		2	<b>3RA2908-1A</b>	1 1 unit

**Overview**

7PV15, SIRIUS 3RP25 and SIRIUS 3RP20 timing relays

Electronic timing relays are used in control, starting, and protective circuits for all switching operations involving time delays. Their fully developed concept and space-saving, compact design make the SIRIUS 3RP timing relays ideal modules for control cabinet, switchgear and control manufacturers in the industry.

With their narrow design, the 7PV15 timing relays are ideal in particular for use in heating, ventilation and air-conditioning systems and in compressors. All 7PV15 timing relays in this enclosure version are suitable for snap-on mounting onto TH 35 standard mounting rails according to IEC 60175. The enclosure complies with DIN 43880.

**Benefits**

- Clear-cut basic range with five basic units in the case of the 7PV15 timing relays, and seven basic units in the case of the 3RP timing relays
- Logistic advantages provided by versions with wide voltage range and wire setting range
- No tools required for assembly or disassembly on standard mounting rails
- Cadmium-free relay contacts
- Recyclable, halogen-free enclosure
- Optimum price/performance ratio
- Versions with logical separation
- Low variance: One design for distribution boards and for control cabinets
- Compliance with EMC requirements for buildings
- Environmentally friendly laser inscription instead of printing containing solvents
- Timing relays suitable for the 3RT miniature contactors allow smaller tier spacing
- Versions with screw terminals or alternatively with spring-type terminals

**Application****Timing relays with ON-delay**

- Interference pulse suppression (gating of interference pulses)
- Gradual startup of motors so as not to overload the power supply

**Timing relays with OFF-delay**

- Generation of overtravel functions following removal of voltage
- Gradual, delayed shutdown, e.g. of motors or fans, to allow a plant to be shut down selectively

**Wye-delta timing relay**

- Switchover of motors from wye to delta with a dead interval of 50 ms to prevent phase-to-phase short circuits

**Multifunctional timing relays**

- Maximum flexibility, with a device for every application
- Available with relay and semiconductor output

# Timing Relays

## 3RP25 timing relays

### Overview

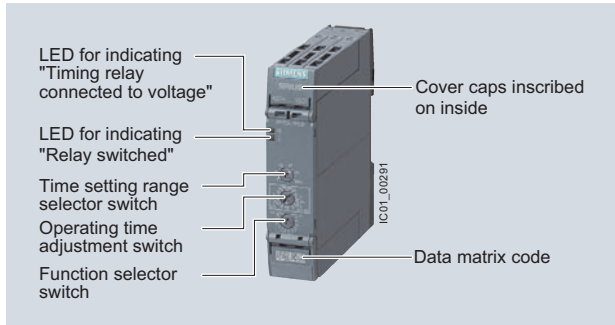

SIRIUS 3RP25 timing relays

Electronic timing relays for general use in control systems and mechanical engineering with:

- 1 or 2 CO, 1 NO (semiconductor) or 3 NO
- Monofunction or multifunction
- Combination voltage
- Wide voltage range
- Single or selectable time setting ranges
- Switch position indication and voltage indication by LED

### Standards

The timing relays comply with:

- IEC 60721-3-3 "Classification of environmental conditions"
- IEC 61812-1/DIN VDE 0435 Part 201 "Specified time relays for industrial use"
- IEC 61000-6-2, IEC 61000-6-3 and IEC 61000-6-4 "Electromagnetic compatibility"
- IEC 60947-5-1 "Low-voltage switchgear and controlgear – Electromechanical control circuit devices"

### 3RP2505 multifunctional timing relays

The functions of the 3RP2505 multifunctional timing relays can be set by means of the function selector switch. Whether both CO contacts are switched in parallel or one CO contact with a delay and one instantaneously and the choice of time setting range are set by means of the time setting range selector switch. The exact operating time can be adjusted with the operating time switch.

With a set of foil labels the timing relay can be legibly marked with the functions which can be selected on the timing relay. This is supplied together with the multifunctional timing relay.

The same potential must be applied to terminals A. and B.

Functions, [see the overview of functions on page 11/37](#).

### Note:

The activation of loads parallel to the start input is permissible when using AC/DC control voltage ([see diagram](#)).

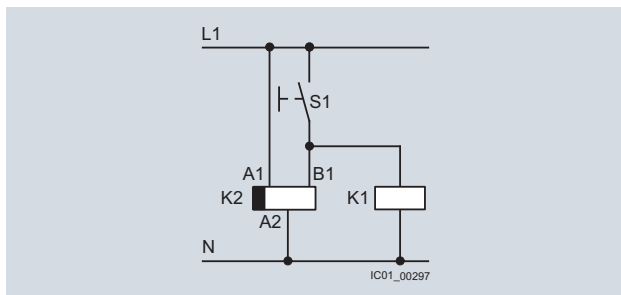

Diagram

### Accessories



Push-in lugs for wall mounting



Sealable cover 17.5 mm



Sealable cover 22.5 mm

**Two setting options for implementing the multifunctions (A-M):**

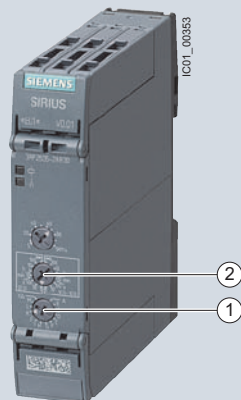

- ① Determination of 13 functions by the setting A to M, with 1 CO, 1 NO, 2 CO that switch in parallel.
- ② Extended function variance by selecting the time range and determining, whether 2 CO switch in parallel or whether 1 CO switches with delay + 1 CO switches immediately (1 CO + 1 CO)

Setting the functions on the device

**Overview of functions of the 3RP2505 multifunctional timing relay**

Identification letter	13 functions 1 CO, 1 NO (semiconductor) or 2 CO switched in parallel	27 functions 13 functions (A - M) 2 CO switched in parallel + 13 functions (A - M) 1 CO delayed + 1 CO instantaneous (1 CO + 1 CO) and wye-delta function
A	ON-delay	ON-delay and instantaneous contact
B	OFF-delay with control signal	OFF-delay with control signal and instantaneous contact
C	ON-delay/OFF-delay with control signal	ON-delay/OFF-delay with control signal and instantaneous contact
D	Flashing, symmetrical, starting with interval	Flashing, symmetrical, starting with interval and instantaneous contact
E	Passing make contact, interval relay	Passing make contact, interval relay and instantaneous contact
F	Retriggerable interval relay with deactivated control signal (passing break contact with control signal)	Retriggerable interval relay with deactivated control signal (passing break contact with control signal) and instantaneous contact
G	Passing make contact, with control signal, not retriggerable (pulse-forming with control signal)	Passing make contact, with control signal, not retriggerable (pulse-forming with control signal) and instantaneous contact
H	Additive ON-delay, instantaneous OFF with control signal	Additive ON-delay, instantaneous OFF with control signal and instantaneous contact
I	Additive ON-delay with control signal	Additive ON-delay with control signal and instantaneous contact
J	Flashing, symmetrical, starting with pulse	Flashing, symmetrical, starting with pulse and instantaneous contact
K	Pulse-delayed (fixed pulse (at 1 s) and settable pulse delay)	Pulse-delayed (fixed pulse (at 1 s) and settable pulse delay) and instantaneous contact
L	Pulse-delayed with control signal (fixed pulse (at 1 s) and settable pulse delay)	Pulse-delayed with control signal (fixed pulse (at 1 s) and settable pulse delay) and instantaneous contact
M	Retriggerable interval relay with activated control signal (watchdog)	Retriggerable interval relay with activated control signal and instantaneous contact (watchdog)
--	--	Wye-delta function

Note:

Conversion tool e.g. from 3RP15 to 3RP25, see [www.siemens.com/sirius/conversion-tool](http://www.siemens.com/sirius/conversion-tool).

# Timing Relays

## 3RP25 timing relays, 17.5 mm and 22.5 mm

**Article No. scheme**

Digit of the Article No.	1 <sup>st</sup> - 5 <sup>th</sup>	6 <sup>th</sup>	7 <sup>th</sup>	-	8 <sup>th</sup>	9 <sup>th</sup>	10 <sup>th</sup>	11 <sup>th</sup>	12 <sup>th</sup>
	□□□□□	□	□	-	□	□	□	□	0
<b>Timing relays in industrial enclosure 17.5 mm and 22.5 mm</b>	<b>3 R P 25</b>								
<b>Functions/time setting ranges</b>		□	□						
<b>Connection type</b>					□				
<b>Contacts</b>						□			
<b>Rated control supply voltage</b>							□	□	
<b>Example</b>	<b>3 R P 25</b>	<b>0</b>	<b>5</b>	<b>-</b>	<b>1</b>	<b>A</b>	<b>W</b>	<b>3</b>	<b>0</b>

Note:

The Article No. scheme is presented here merely for information purposes and for better understanding of the logic behind the article numbers.

For your orders, please use the article numbers quoted in the catalog in the Selection and ordering data.

**Benefits**

- Easy stock keeping and logistics thanks to low variance of devices
- Reduced space requirement in the control cabinet thanks to variants in width 17.5 mm and 22 mm
- Consistent for all functions thanks to wide voltage range from 12 to 240 V AC/DC
- Up to 27 functions according to IEC 61812 in the multifunctional timing relay with wide voltage range
- Multifunctional timing relay with semiconductor output for high switching frequencies, bounce-free and wear-free switching

**Application**

Timing relays are used in control, starting, and protective circuits for all switching operations involving time delays. They guarantee a high level of functionality and a high repeat accuracy of timer settings.

**Enclosure version**

All timing relays are suitable for snap-on mounting onto TH 35 standard mounting rails according to IEC 60715 or for screw fixing.

# Timing Relays



3RP25 timing relays, 17.5 mm and 22.5 mm

## Technical specifications

<b>Type</b>		<b>3RP2505-.A, 3RP2505-.C, 3RP251., 3RP2525-.A, 3RP2527, 3RP253., 3RP255.</b>	<b>3RP2505-.B, 3RP2505-.R, 3RP2525-.B, 3RP254., 3RP256., 3RP257.</b>
Width	mm	17.5	22.5
Height	mm	100	100
Depth	mm	90	90



Type		<b>3RP25...-AB30, 3RP25...-AW30, 3RP25...-BB30, 3RP25...-BW30, 3RP25...-NW30, 3RP25...-SW30</b>	<b>3RP25...-BT20, 3RP25...-NM20</b>	<b>3RP25...-CW30</b>	<b>3RP25...-EW30</b>	<b>3RP25...-RW30</b>
<b>Insulation voltage</b> For overvoltage category III According to IEC 60664 For pollution degree 3, rated value	V AC	300	500	300	--	300
<b>Ambient temperature</b> • During operation • During storage	°C	-25 ... +60 -40 ... +85				-40 ... +70
<b>Operating range factor</b> Of the control supply voltage, rated value • At AC - At 50 Hz - At 60 Hz • At DC		0.85 ... 1.1 0.85 ... 1.1 0.85 ... 1.1	--	0.85 ... 1.1	0.85 ... 1.1	0.7 ... 1.1 0.7 ... 1.1 0.7 ... 1.1
<b>Switching capacity current</b> With inductive load	A	0.01 ... 3	0.01 ... 3	0.01 ... 1	0.01 ... 6	0.01 ... 3
<b>Operational current of the auxiliary contacts</b> • At AC-15 - At 24 V - At 250 V - At 400 V • At DC-12 - At 24 V - At 125 V - At 250 V • At DC-13 - At 24 V - At 125 V - At 250 V	A	3 3 -- -- -- -- 1 0.2 0.1	3 3 3 -- -- -- 1 0.2 0.1	1 1 -- 1 -- -- -- -- --	-- -- -- -- -- -- -- -- --	3 3 -- -- -- -- 1 0.2 0.1
<b>Uninterrupted thermal current <math>I_{th}</math></b>	A	5	5	1	0.6	5
<b>Mechanical endurance</b> (Operating cycles) Typical		10 x 10 <sup>6</sup>				
<b>Electrical endurance</b> For AC-15 at 230 V, typical		1 x 10 <sup>5</sup>				

Type	<b>3RP25</b>	
<b>Connection type</b>	 <b>Screw terminals</b>	
• Design of thread of connection screw	M3	
• Solid	mm <sup>2</sup>	1 x (0.5 ... 4.0)/2 x (0.5 ... 2.5)
• Finely stranded with end sleeve	mm <sup>2</sup>	1 x (0.5 ... 4)/2 x (0.5 ... 1.5)
• Solid for AWG cables	AWG	1 x (20 ... 12), 2 x (20 ... 14)
• Stranded for AWG cables	AWG	1 x (20 ... 12), 2 x (20 ... 14)
• Tightening torque	Nm	0.6 ... 0.8
<b>Connection type</b>	 <b>Spring-type terminals</b>	
• Solid	mm <sup>2</sup>	1 x (0.5 ... 4)
• Finely stranded with end sleeve	mm <sup>2</sup>	1 x (0.5 ... 2.5)
• AWG cables, solid	AWG	1 x (20 ... 12)

# Timing Relays

## 3RP25 timing relays, 17.5 mm and 22.5 mm

### Internal circuit diagrams 3RP25

Multifunction 3RP2505-.A, 13 functions, 1 CO

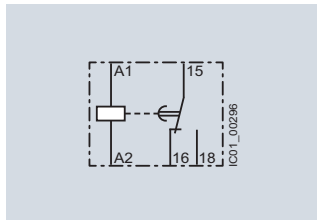

3RP2505-.A (A)  
ON-delay

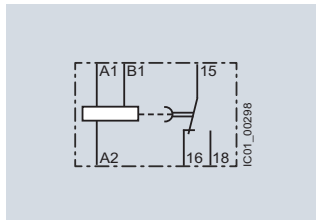

3RP2505-.A (B)  
OFF-delay with control signal

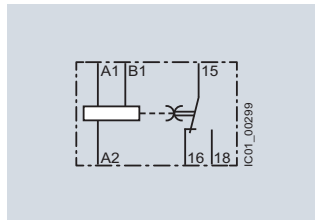

3RP2505-.A (C)  
ON-delay/OFF-delay  
with control signal

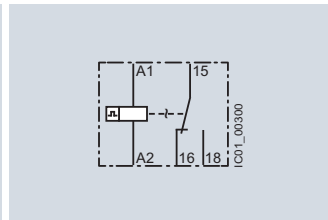

3RP2505-.A (D)  
Flashing, symmetrical,  
starting with interval

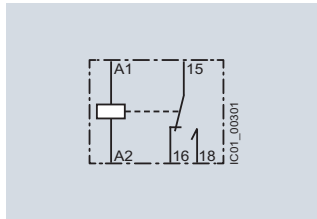

3RP2505-.A (E)  
Passing make contact, interval relay

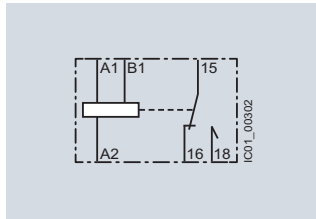

3RP2505-.A (F)  
Retriggerable interval relay with  
deactivated control signal (passing  
break contact with control signal)

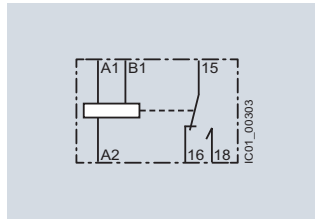

3RP2505-.A (G)  
Passing make contact with  
control signal, not retriggerable  
(pulse-forming with control signal)

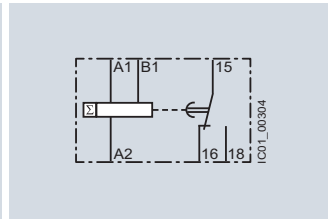

3RP2505-.A (H)  
Additive ON-delay, instantaneous OFF  
with control signal

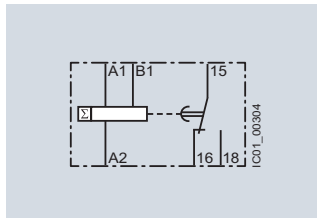

3RP2505-.A (I)  
Additive ON-delay with control signal

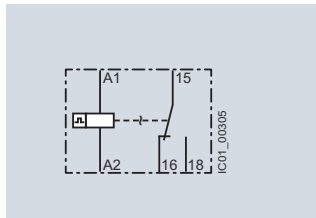

3RP2505-.A (J)  
Flashing, symmetrical,  
starting with pulse

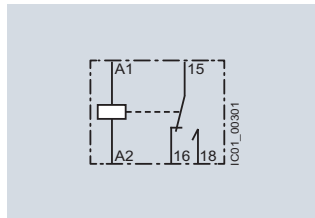

3RP2505-.A (K)  
Pulse-delayed (fixed pulse (at 1 s)  
and settable pulse delay)

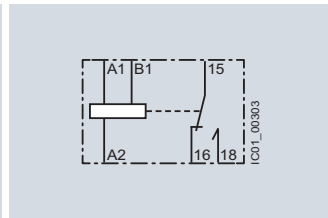

3RP2505-.A (L)  
Pulse-delayed with control signal (fixed  
pulse (at 1 s) and settable pulse delay)

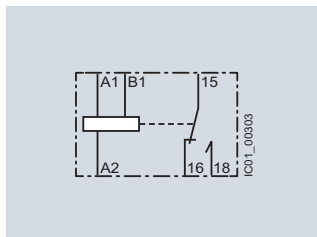

3RP2505-.A (M)  
Retriggerable interval relay with  
activated control signal (watchdog)



# Timing Relays

3RP25 timing relays, 17.5 mm and 22.5 mm

Multifunction 3RP2505-.C, 13 functions, 1 NO (semiconductor)

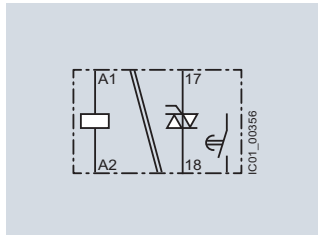

3RP2505-.C (A)  
ON-delay

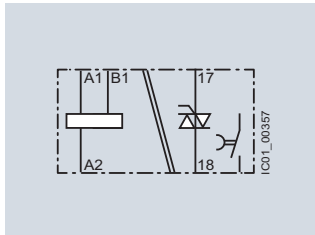

3RP2505-.C (B)  
OFF-delay with control signal

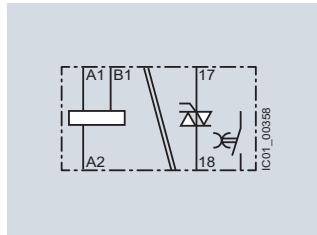

3RP2505-.C (C)  
ON-delay/OFF-delay with control signal

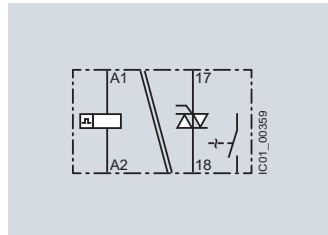

3RP2505-.C (D)  
Flashing, symmetrical, starting with interval

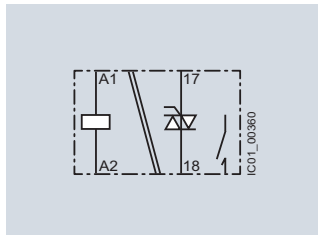

3RP2505-.C (E)  
Passing make contact, interval relay

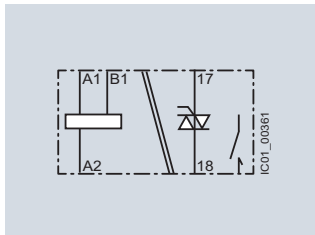

3RP2505-.C (F)  
Retriggerable interval relay with deactivated control signal (passing break contact with control signal)

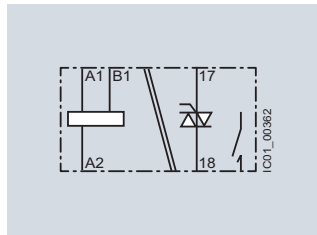

3RP2505-.C (G)  
Passing make contact with control signal, not retriggerable (pulse-forming with control signal)

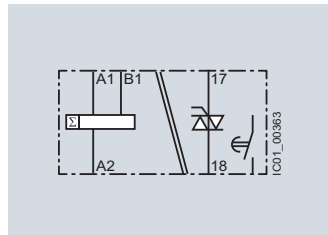

3RP2505-.C (H)  
Additive ON-delay, instantaneous OFF with control signal

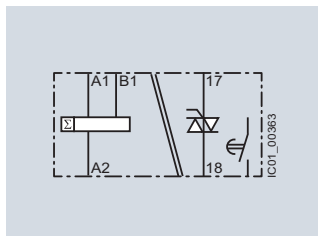

3RP2505-.C (I)  
Additive ON-delay with control signal

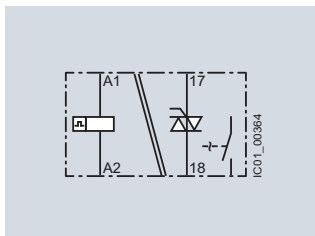

3RP2505-.C (J)  
Flashing, symmetrical, starting with pulse

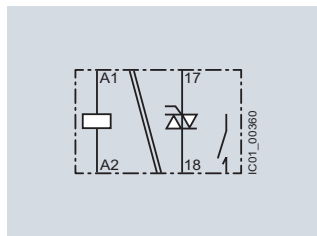

3RP2505-.C (K)  
Pulse-delayed (fixed pulse (at 1 s) and settable pulse delay)

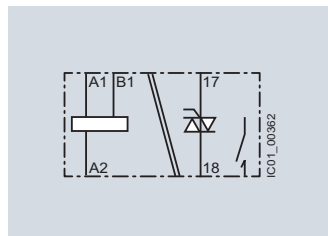

3RP2505-.C (L)  
Pulse-delayed with control signal (fixed pulse (at 1 s) and settable pulse delay)

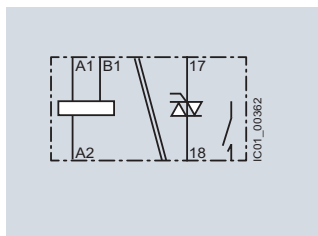

3RP2505-.C (M)  
Retriggerable interval relay with activated control signal (watchdog)

# Timing Relays

## 3RP25 timing relays, 17.5 mm and 22.5 mm

Multifunction 3RP2505-.B, 27 functions, 2 CO switched in parallel with delay/  
 multifunction 3RP2505-.R, 13 functions, 2 CO positively driven, and switched in parallel with delay (see also note below)

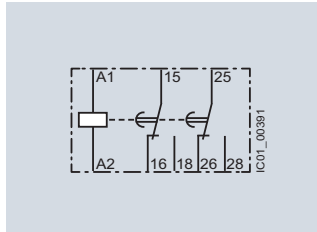

3RP2505-.B (A)  
ON-delay

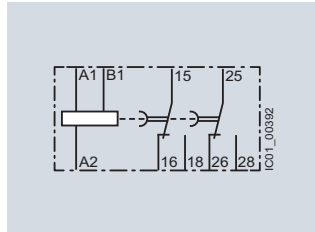

3RP2505-.B (B)  
OFF-delay with control signal

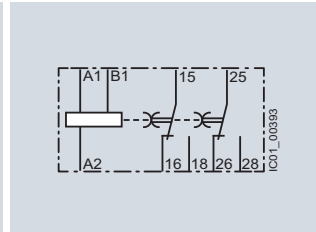

3RP2505-.B (C)  
ON-delay/OFF-delay  
with control signal

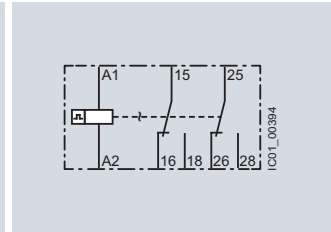

3RP2505-.B (D)  
Flashing, symmetrical,  
starting with interval

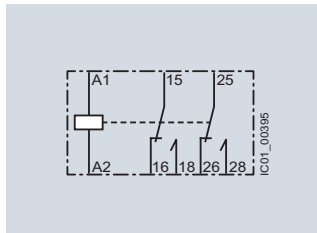

3RP2505-.B (E)  
Passing make contact, interval relay

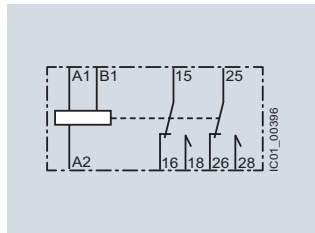

3RP2505-.B (F)  
Retriggerable interval relay with  
deactivated control signal (passing  
break contact with control signal)

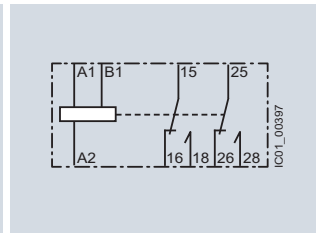

3RP2505-.B (G)  
Passing make contact with  
control signal, not retriggerable  
(pulse-forming with control signal)

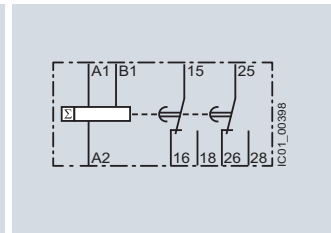

3RP2505-.B (H)  
Additive ON-delay, instantaneous OFF  
with control signal

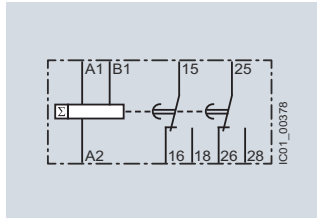

3RP2505-.B (I)  
Additive ON-delay with control signal

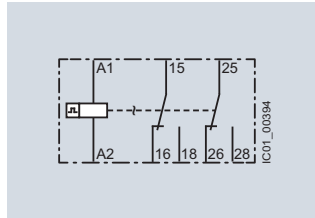

3RP2505-.B (J)  
Flashing, symmetrical,  
starting with pulse

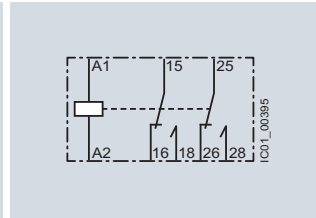

3RP2505-.B (K)  
Pulse-delayed (fixed pulse (at 1 s)  
and settable pulse delay)

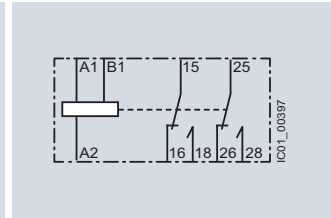

3RP2505-.B (L)  
Pulse-delayed with control signal (fixed  
pulse (at 1 s) and settable pulse delay)

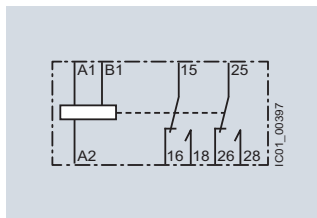

3RP2505-.B (M)  
Retriggerable interval relay with  
activated control signal (watchdog)

**Note:**

3RP2505-.RW30 has 13 functions (A to M) like 3RP2505-.B switched in parallel with delay, but with positively driven contacts. The circuit diagrams are identical except for the representation of the symbols for these contacts, see also the example on the right for 3RP2505-.RW30 of the function (A) with ON-delay.

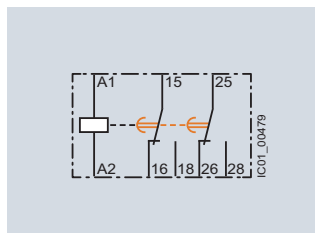

3RP2505-.B (A)  
ON-delay

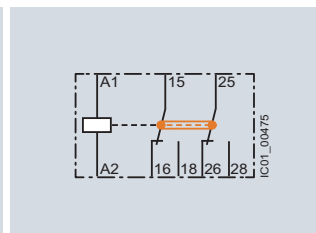

3RP2505-.R (A)  
with positively driven contacts  
ON-delay

# Timing Relays

## 3RP25 timing relays, 17.5 mm and 22.5 mm

Multifunction 3RP2505-.B, 27 functions, 1 CO delayed + 1 CO instantaneous (continued)

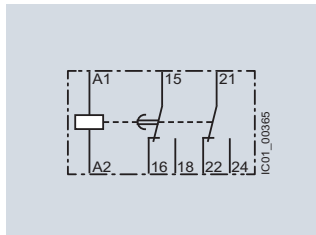

3RP2505-B (A)  
ON-delay and instantaneous contact

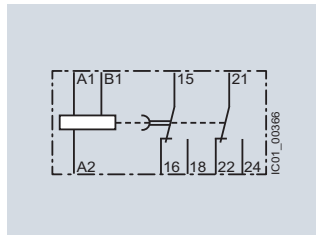

3RP2505-B (B)  
OFF-delay with control signal and instantaneous contact

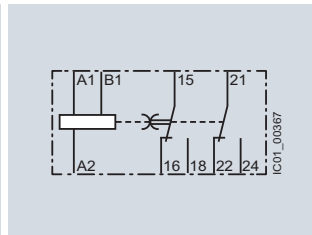

3RP2505-B (C)  
ON-delay/OFF-delay with control signal and instantaneous contact

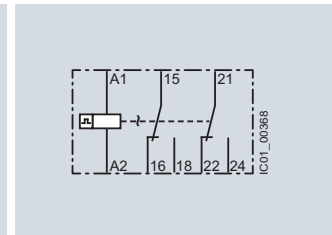

3RP2505-B (D)  
Flashing, symmetrical, starting with interval and instantaneous contact

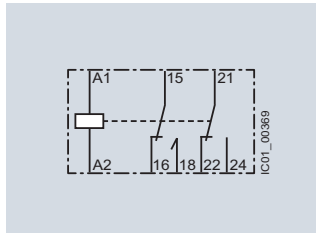

3RP2505-B (E)  
Passing make contact, interval relay and instantaneous contact

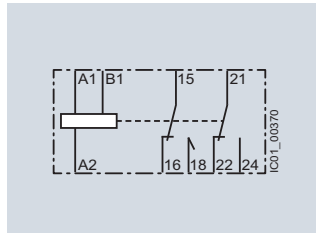

3RP2505-B (F)  
Retriggerable interval relay with deactivated control signal (passing break contact with control signal) and instantaneous contact

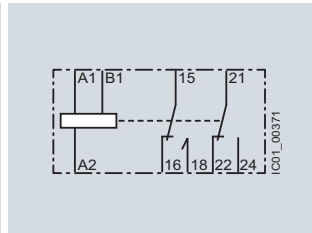

3RP2505-B (G)  
Passing make contact with control signal, not retriggerable (pulse-forming with control signal) and instantaneous contact

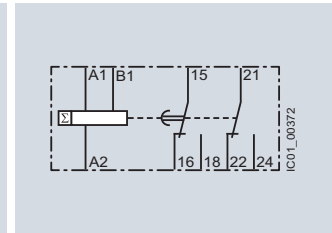

3RP2505-B (H)  
Additive ON-delay, instantaneous OFF with control signal and instantaneous contact

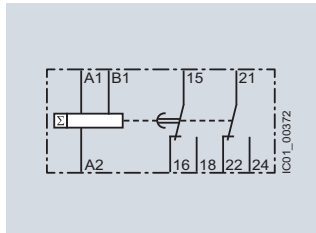

3RP2505-B (I)  
Additive ON-delay with control signal and instantaneous contact

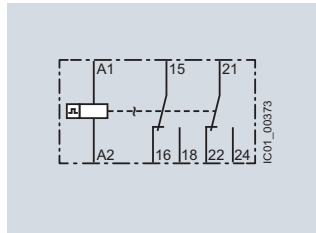

3RP2505-B (J)  
Flashing, symmetrical, starting with pulse and instantaneous contact

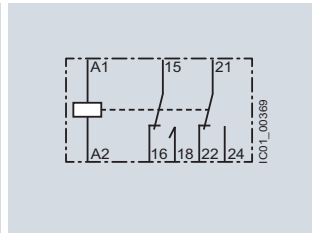

3RP2505-B (K)  
Pulse-delayed (fixed pulse (at 1 s) and settable pulse delay) and instantaneous contact

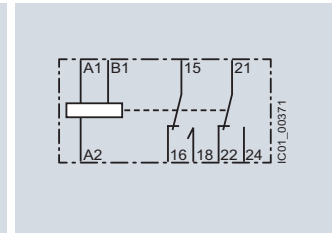

3RP2505-B (L)  
Pulse-delayed with control signal (fixed pulse (at 1 s) and settable pulse delay) and instantaneous contact

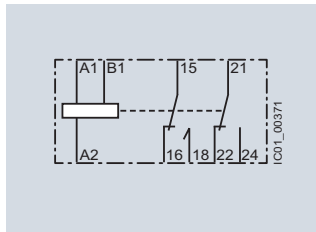

3RP2505-B (M)  
Retriggerable interval relay with activated control signal and instantaneous contact (watchdog)

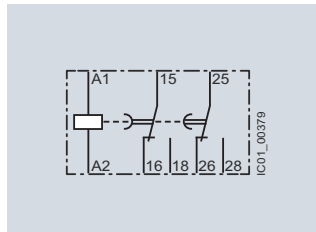

3RP2505-B  
Wye-delta function

# Timing Relays

## 3RP25 timing relays, 17.5 mm and 22.5 mm

Monofunctions 3RP251. up to 3RP257.<sup>1)</sup>

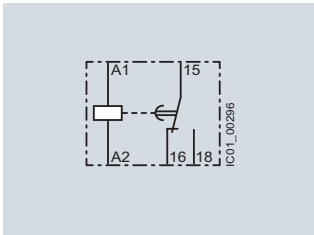

3RP251., 3RP2525-A  
ON-delay

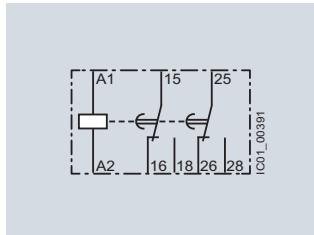

3RP2525-B  
ON-delay

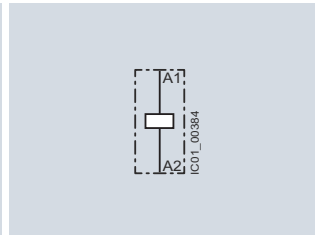

3RP2527  
ON-delay, two-wire design

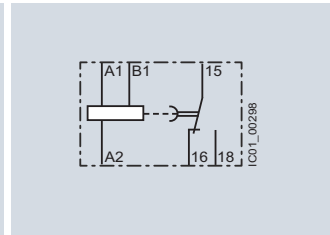

3RP2535  
OFF-delay with control signal

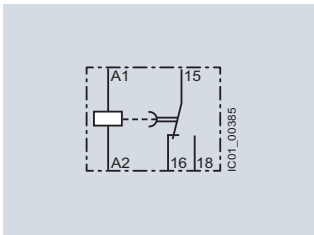

3RP2540-A (N)<sup>1)</sup>  
OFF-delay

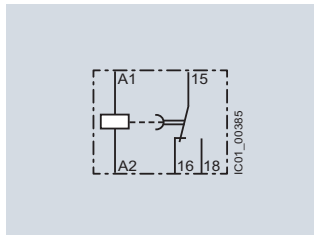

3RP2540-A (O)<sup>1)</sup>  
Positive passing make contact

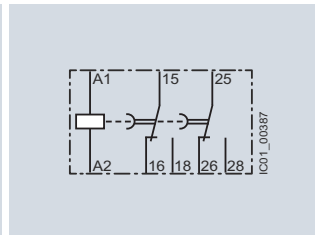

3RP2540-B (N)<sup>1)</sup>  
OFF-delay

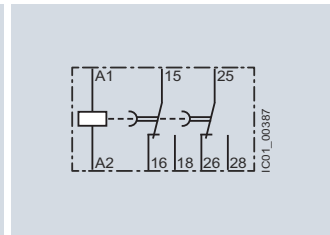

3RP2540-B (O)<sup>1)</sup>  
Positive passing make contact

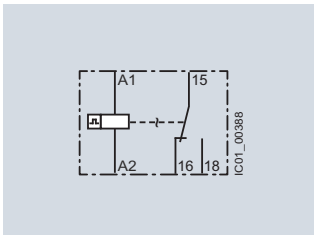

3RP2555  
Flashing, asymmetrical, starting with interval (clock-pulse relay)

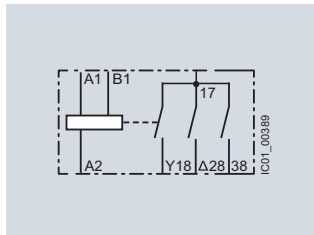

3RP2560  
Wye-delta function with overtravel function (idling)

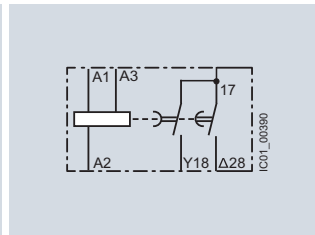

3RP257.  
Wye-delta function

<sup>1)</sup> 3RP2540 has a double function:  
Function N = OFF-delay  
Function O = Positive passing make contact.

### 3RP25 function diagrams

Multifunction 3RP2505-.A, 1 CO, 13 functions and 3RP2505-.C, 1 NO (semiconductor), 13 functions

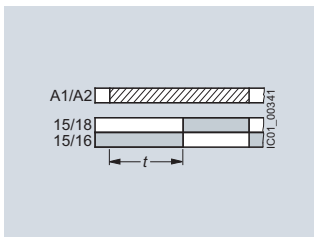

**A**  
ON-delay

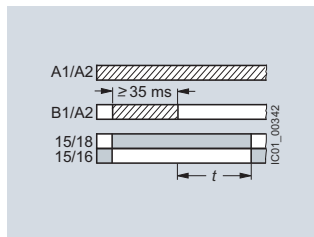

**B**  
OFF-delay with control signal

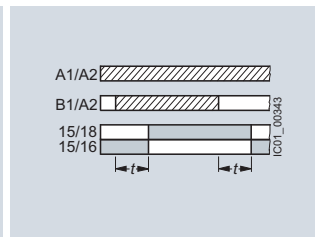

**C**  
ON-delay/OFF-delay with control signal

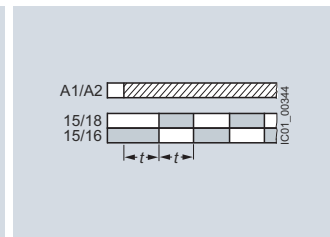

**D**  
Flashing, symmetrical, starting with interval

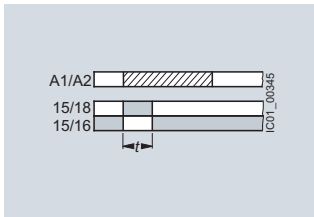

**E**  
Passing make contact, interval relay

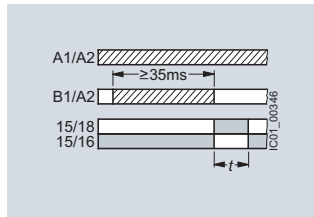

**F**  
Retriggerable interval relay with deactivated control signal (passing break contact with control signal)

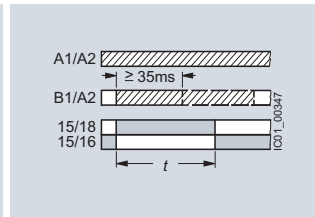

**G**  
Passing make contact with control signal, not retriggerable (pulse-forming with control signal)

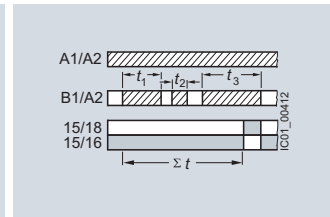

**H**  
Additive ON-delay, instantaneous OFF with control signal

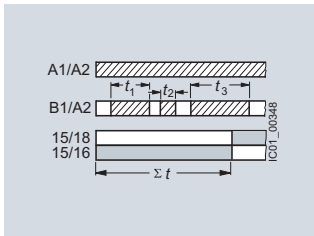

**I**  
Additive ON-delay, with control signal

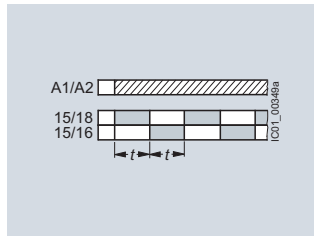

**J**  
Flashing, symmetrical, starting with pulse

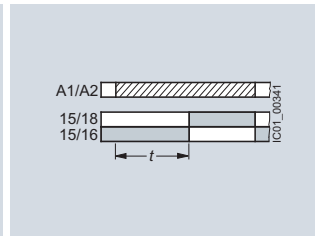

**K**  
Pulse-delayed (fixed pulse (at 1 s) and settable pulse delay)

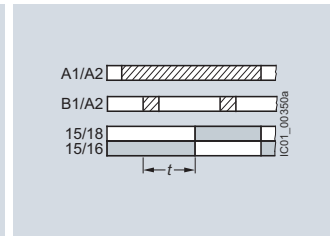

**L**  
Pulse-delayed with control signal (fixed pulse (at 1 s) and settable pulse delay)

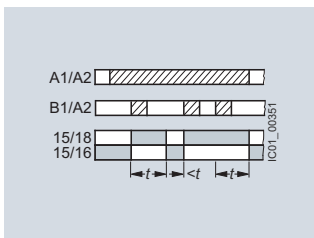

**M**  
Retriggerable interval relay with activated control signal (watchdog)

Legend

- A ... M** Identification letters
- Timing relay energized
- Contact closed
- Contact open

# Timing Relays

3RP25 timing relays, 17.5 mm and 22.5 mm

Multifunction 3RP2505-.B, 13 functions, 2 CO positively driven and switched in parallel with delay

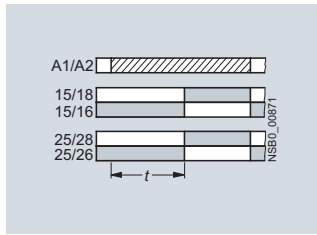

**A**  
ON-delay

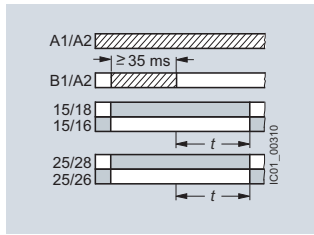

**B**  
OFF-delay with control signal

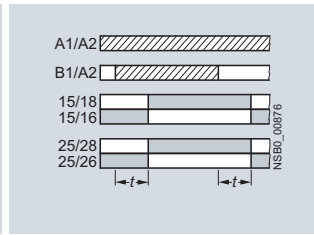

**C**  
ON-delay/OFF-delay with control signal

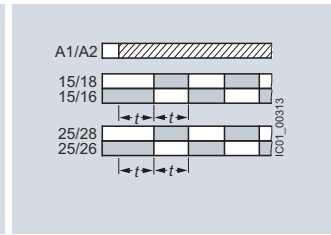

**D**  
Flashing, symmetrical, starting with interval

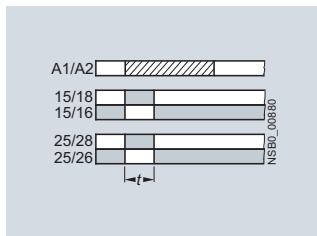

**E**  
Passing make contact, interval relay

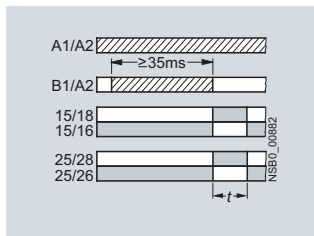

**F**  
Retriggerable interval relay with deactivated control signal (passing break contact with control signal)

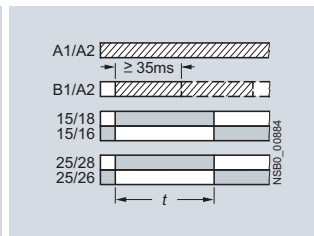

**G**  
Passing make contact with control signal, not retriggerable (pulse-forming with control signal)

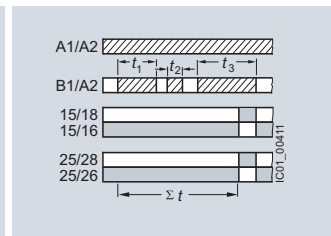

**H**  
Additive ON-delay, instantaneous OFF with control signal

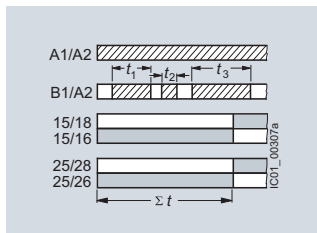

**I**  
Additive ON-delay with control signal

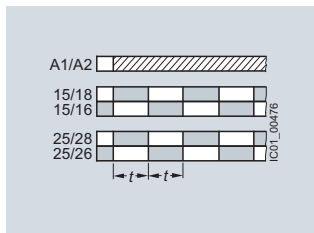

**J**  
Flashing, symmetrical, starting with pulse

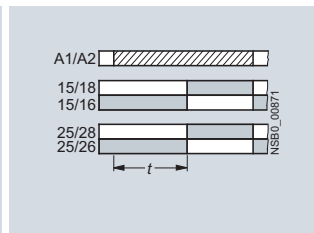

**K**  
Pulse-delayed (fixed pulse at 1 s and settable pulse delay)

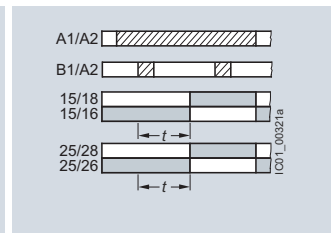

**L**  
Pulse-delayed with control signal (fixed pulse at 1 s and settable pulse delay)

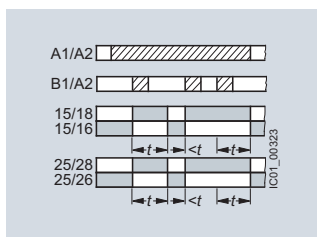

**M**  
Retriggerable interval relay with activated control signal (watchdog)

**Legend**

- A ... M** Identification letters
- Timing relay energized
- Contact closed
- Contact open

Multifunction 3RP2505-.B, 27 functions, 2 CO

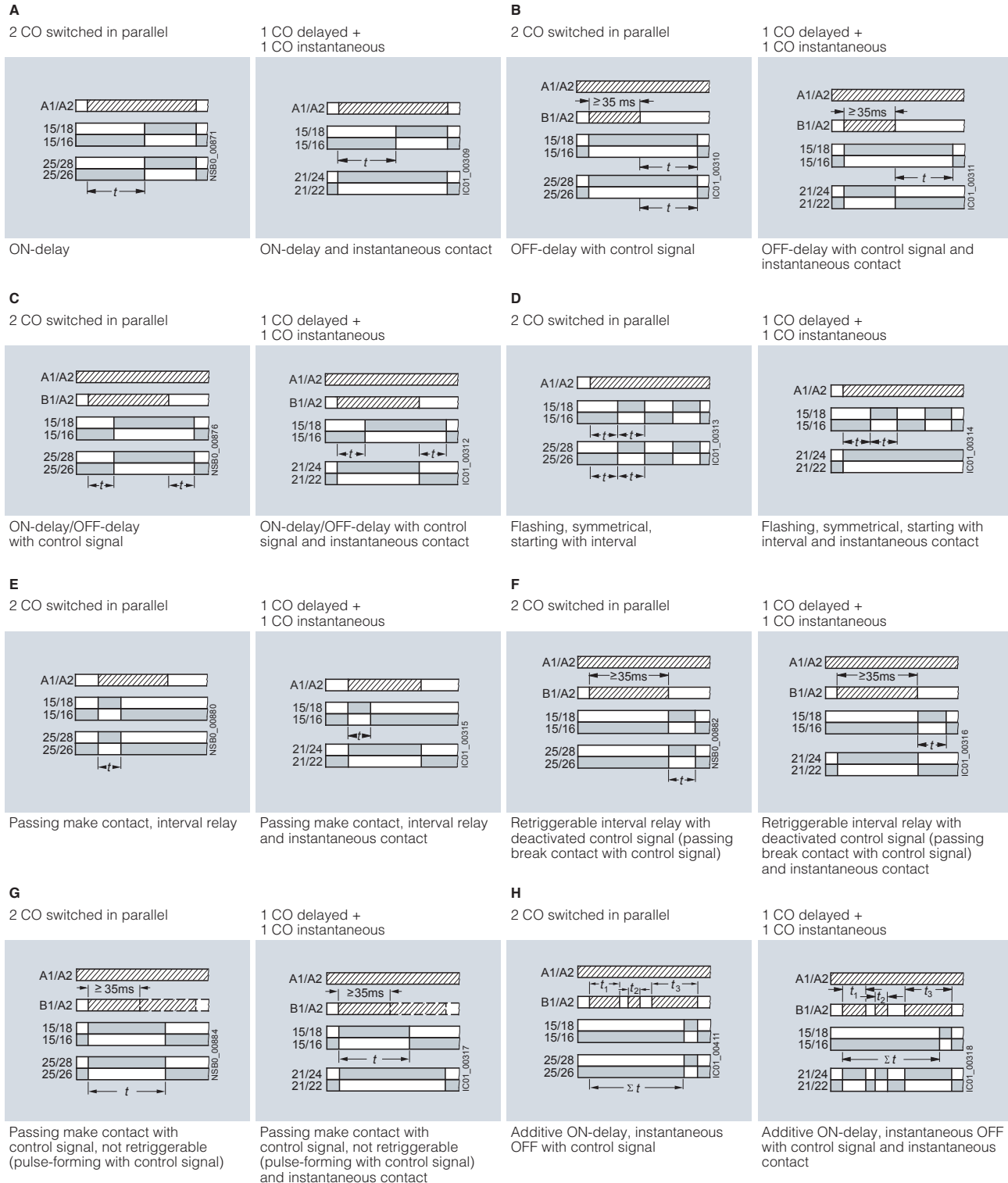

Legend

- A ... M** Identification letters
- Timing relay energized
- Contact closed
- Contact open

Multifunction 3RP2505-.B, 27 functions, 2 CO (continued)

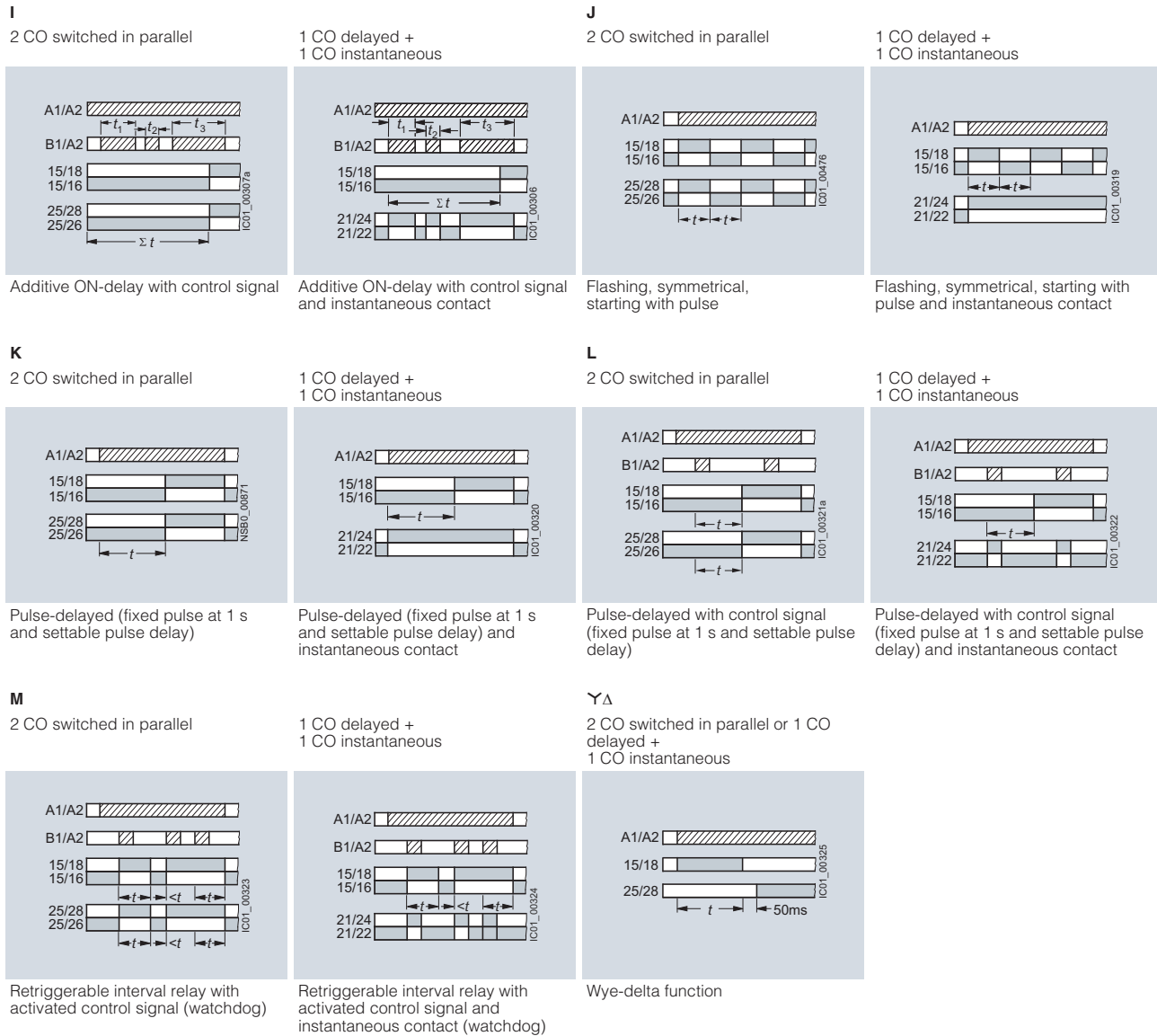

Legend

- A ... M** Identification letters
- Timing relay energized
- Contact closed
- Contact open



# Timing Relays

## 3RP25 timing relays, 17.5 mm and 22.5 mm

Monofunctions 3RP251.. up to 3RP257.<sup>1)</sup>

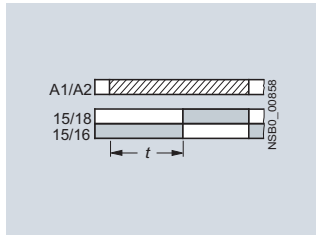

3RP251-.AW30, 1 CO, ON-delay

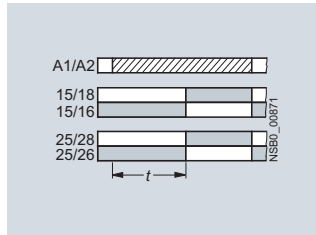

3RP2525-..W30, 2 CO, ON-delay

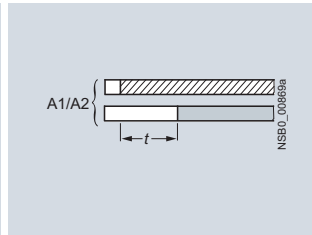

3RP2527-.EW30, 1 NO (semiconductor), ON-delay

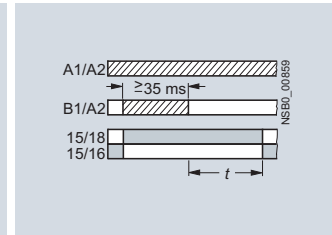

3RP2535-.AW30, 1 CO, OFF-delay with control signal

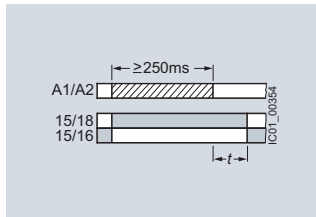

3RP2540-.A.30, 1 CO, OFF-delay (N)<sup>1)</sup>

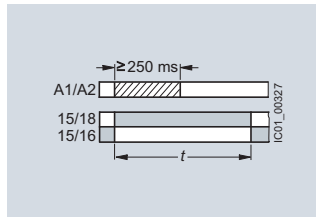

3RP2540-.A.30, 1 CO, positive passing make contact (O)<sup>1)</sup>

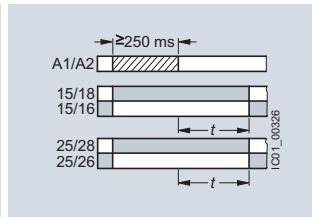

3RP2540-.B.30, 2 CO, OFF-delay (N)<sup>1)</sup>

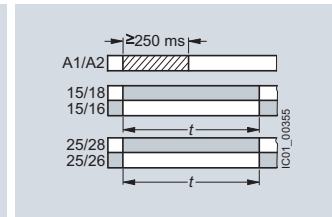

3RP2540-.B.30, 2 CO, positive passing make contact (O)<sup>1)</sup>

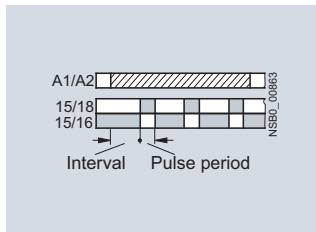

3RP2555-.AW30, 1 CO, flashing, asymmetrical, starting with interval (clock-pulse relay)

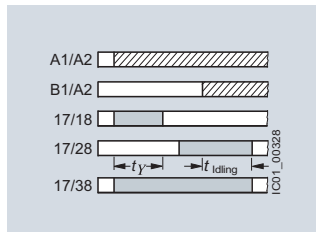

3RP2560-.SW30, 3 NO, wye-delta function with overtravel function (idling)

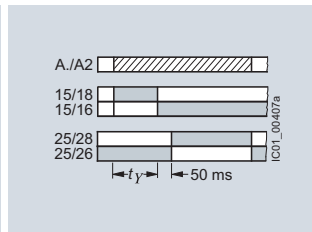

3RP257-.NM20, 2 NO, wye-delta function

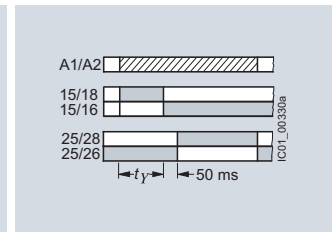

3RP257-.NM30, 2 NO, wye-delta function

**Legend**

- Timing relay energized
- Contact closed
- Contact open

<sup>1)</sup> 3RP2540 has a double function:  
Function N = OFF-delay  
Function O = positive passing make contact.

### Possibilities of operation of the 3RP2560-.SW30 timing relay

Operation 1: Start contact B./A2 is open when control supply voltage A./A2 is applied

The control supply voltage is applied to A./A2 and there is no control signal on B./A2. This starts the  $\Upsilon\Delta$  timing. The idling time (coasting time) is started by applying a control signal to B./A2. When the set time  $t_{idling}$  (30 ... 600 s) has elapsed, the output relays (17/38 and 17/28) are reset. If the control signal on B./A2 is switched off (minimum OFF period 270 ms), a new timing is started.

Note:

Observe response time (dead time) of 400 ms on energizing control supply voltage until contacts 17/18 and 17/16 close.

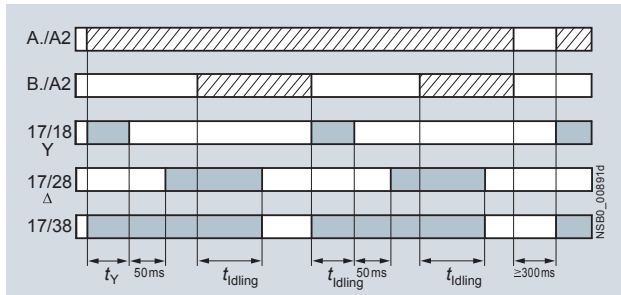

Operation 1

Operation 2: Start contact B./A2 is closed when control supply voltage A./A2 is applied

If the control signal B./A2 is already present when the control supply voltage A./A2 is applied, **no** timing is started. The timing is only started when the control signal B./A2 is switched off.

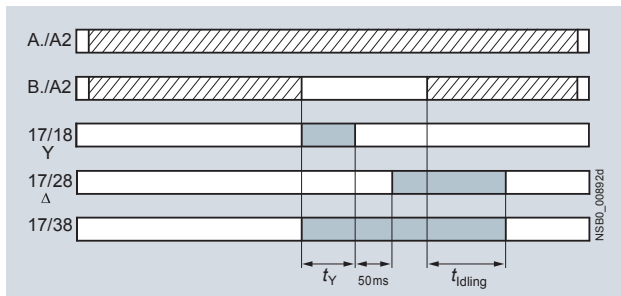

Operation 2

Operation 3: Start contact B./A2 closes while star time is running

If the control signal B./A2 is applied again during the star time, the idling time starts and the timing is terminated normally.

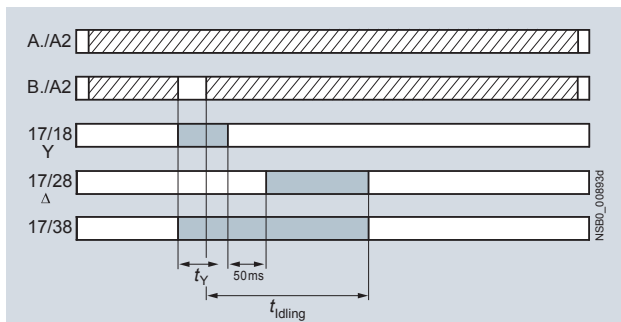

Operation 3

Operation 4: Start contact B./A2 opens while delta time is running and is applied again

If the control signal on B./A2 is applied and switched off again during the delta time, although the idling time has not yet elapsed, the idling time (coasting time) is reset to zero. If the control signal is re-applied to B./A2, the idling time is restarted.

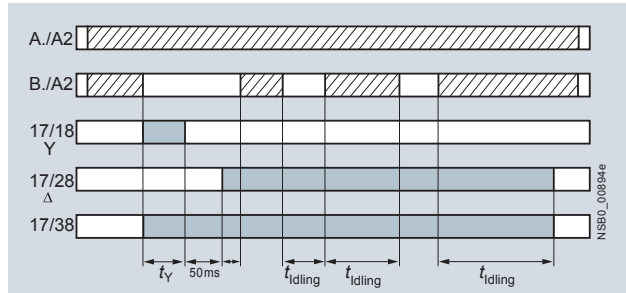

Operation 4

Legend

- Timing relay energized
- Contact closed
- Contact open

$t_Y$  = Star time 1 ... 20 s

$t_{idling}$  = Idling time (coasting time) 30 ... 600 s

Note:

The following applies to all operations: The pressure switch controls the timing via B./A2.

### Application example based on standard operation

(operation 1): For example, use of 3RP2560 for compressor control

Frequent starting of compressors strains the network, the machine, and the increased costs for the operator. The new timing relay prevents frequent starting at times when there is high demand for compressed air. A special control circuit prevents the compressor from being switched off immediately when the required air pressure in the tank has been reached. Instead, the valve in the intake tube is closed and the compressor runs in "Idling" mode, i.e. in no-load operation for a specific time which can be set from 30 ... 600 s.

If the pressure falls within this time, the motor does not have to be restarted again, but can return to nominal load operation from no-load operation.

If the pressure does not fall within this idling time, the motor is switched off.

The pressure switch controls the timing via B./A2.

The control supply voltage is applied to A./A2 and the start contact B./A2 is open, i.e. there is no control signal on B./A2 when the control supply voltage is applied. The pressure switch signals "too little pressure in system" and starts the timing by way of terminal B./A2. The compressor is started, enters  $\Upsilon\Delta$  operation, and fills the pressure tank.

When the pressure switch signals "sufficient pressure", the control signal B./A2 is applied, the idling time (coasting time) is started, and the compressor enters no-load operation for the set period of time from 30 ... 600 s. The compressor is then switched off. The compressor is only restarted if the pressure switch responds again (low pressure).

# Timing Relays

3RP25 timing relays, 17.5 mm and 22.5 mm

## Selection and ordering data

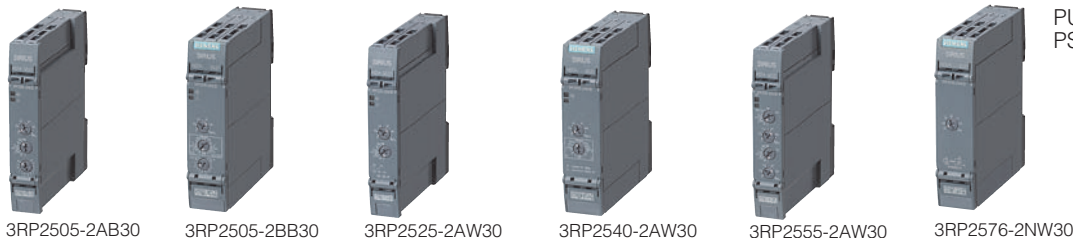

PU (UNIT, SET, M) = 1  
PS\* = 1 unit

Number of NO contacts		Number of CO contacts		Semi-conduc-tor output	Adjustable time	Control supply voltage		DT	Screw terminals		DT	Spring-type terminals (push-in)	
Instan-taneous switch-ing	De-layed switch-ing	Instan-taneous switch-ing	De-layed switch-ing			At AC 50/60 Hz	At DC		Article No.	Price per PU		Article No.	Price per PU

### 3RP2505-.A and 3RP2505-.C timing relays, 13 functions

The functions can be adjusted by means of function selector switches on the device. With a set of foil labels the timing relay can be legibly marked with the functions which can be selected on the timing relay. This is supplied together with the multifunctional timing relay. The same potential must be applied to terminals A. and B. Functions, [see the overview functions on page 11/37](#).

0	0	0	1	--	0.05 s ... 100 h	24	24	A	<b>3RP2505-1AB30</b>	A	<b>3RP2505-2AB30</b>
						12 ... 240	12 ... 240	A	<b>3RP2505-1AW30</b>	A	<b>3RP2505-2AW30</b>
0	1	0	0	✓	0.05 s ... 100 h	12 ... 240	12 ... 240	A	<b>3RP2505-1CW30</b>	A	<b>3RP2505-2CW30</b>

### 3RP2505-.R timing relays suitable for railway applications, 13 functions

Start of delivery planned for 11/2015

The functions can be adjusted by means of function selector switches on the device. With a set of foil labels the timing relay can be legibly marked with the functions which can be selected on the timing relay. This is supplied together with the multifunctional timing relay. The same potential must be applied to terminals A. and B. Functions, [see the overview functions on page 11/37](#).

0	0	--	2 <sup>1)</sup>	--	0.05 s ... 100 h	24 ... 240	24 ... 240	A	<b>3RP2505-1RW30</b>	A	<b>3RP2505-2RW30</b>
---	---	----	-----------------	----	------------------	------------	------------	---	----------------------	---	----------------------

### 3RP2505-.B timing relay, 27 functions

The functions can be adjusted by means of function selector switches on the device. With a set of foil labels the timing relay can be legibly marked with the functions which can be selected on the timing relay. This is supplied together with the multifunctional timing relay. The same potential must be applied to terminals A. and B. Functions, [see the overview functions on page 11/37](#).

0	0	--	2 <sup>2)</sup>	--	0.05 s ... 100 h	24	24	A	<b>3RP2505-1BB30</b>	A	<b>3RP2505-2BB30</b>
						400 ... 440	--	A	<b>3RP2505-1BT20</b>	A	<b>3RP2505-2BT30</b>
						12 ... 240	12 ... 240	A	<b>3RP2505-1BW30</b>	A	<b>3RP2505-2BW30</b>

### 3RP251. and 3RP252. timing relays, ON-delay

0	0	0	1	--	0.5 ... 10 s	12 ... 240	12 ... 240	A	<b>3RP2511-1AW30</b>	A	<b>3RP2511-2AW30</b>
					1 ... 30 s	12 ... 240	12 ... 240	A	<b>3RP2512-1AW30</b>	A	<b>3RP2512-2AW30</b>
					5 ... 100 s	12 ... 240	12 ... 240	A	<b>3RP2513-1AW30</b>	A	<b>3RP2513-2AW30</b>
					0.05 s ... 100 h	12 ... 240	12 ... 240	A	<b>3RP2525-1AW30</b>	A	<b>3RP2525-2AW30</b>
0	0	0	2	--	0.05 s ... 100 h	24	24	A	<b>3RP2525-1BB30</b>	A	<b>3RP2525-2BB30</b>
						12 ... 240	12 ... 240	A	<b>3RP2525-1BW30</b>	A	<b>3RP2525-2BW30</b>
0	1	0	0	✓	0.05 s ... 240 s	12 ... 240	12 ... 240	A	<b>3RP2527-1EW30</b>	A	<b>3RP2527-2EW30</b>

### 3RP2535 timing relays, OFF-delay with control signal

0	0	0	1	--	0.05 s ... 100 h	12 ... 240	12 ... 240	A	<b>3RP2535-1AW30</b>	A	<b>3RP2535-2AW30</b>
---	---	---	---	----	------------------	------------	------------	---	----------------------	---	----------------------

### 3RP2540 timing relays, OFF-delay, without control signal, non-volatile, passing make contact

0	0	0	1	--	0.05 s ... 600 s	24	24	A	<b>3RP2540-1AB30</b>	A	<b>3RP2540-2AB30</b>
						12 ... 240	12 ... 240	A	<b>3RP2540-1AW30</b>	A	<b>3RP2540-2AW30</b>
0	0	0	2	--	0.05 s ... 600 s	24	24	A	<b>3RP2540-1BB30</b>	A	<b>3RP2540-2BB30</b>
						12 ... 240	12 ... 240	A	<b>3RP2540-1BW30</b>	A	<b>3RP2540-2BW30</b>

### 3RP2555 timing relays, clock-pulse relay, flashing, asymmetrical

0	0	0	1	--	0.05 s ... 100 h	12 ... 240	12 ... 240	A	<b>3RP2555-1AW30</b>	A	<b>3RP2555-2AW30</b>
---	---	---	---	----	------------------	------------	------------	---	----------------------	---	----------------------

### 3RP2560 timing relays, wye-delta function with overtravel function (idling)

1	2	0	0	--	1 ... 20 s	12 ... 240	12 ... 240	A	<b>3RP2560-1SW30</b>	A	<b>3RP2560-2SW30</b>
---	---	---	---	----	------------	------------	------------	---	----------------------	---	----------------------

### 3RP257. timing relays, wye-delta function

1	1	0	0	--	1 ... 20 s	380 ... 440 <sup>3)</sup>	--	A	<b>3RP2574-1NM20</b>	A	<b>3RP2574-2NM20</b>
						12 ... 240	12 ... 240	A	<b>3RP2574-1NW30</b>	A	<b>3RP2574-2NW30</b>
1	1	0	0	--	3 ... 60 s	380 ... 440 <sup>3)</sup>	--	A	<b>3RP2576-1NM20</b>	A	<b>3RP2576-2NM20</b>
						12 ... 240	12 ... 240	A	<b>3RP2576-1NW30</b>	A	<b>3RP2576-2NW30</b>

- ✓ Available
- Not available

1) Positively-driven contacts.

2) Optionally 1 CO delayed + 1 CO instantaneous.

3) With 3RP2574-.NM20 and 3RP2576-.NM20, connection of 200 ... 240 V AC, 50/60 Hz control voltage is also possible.

For accessories, [see page 11/52](#).

Accessories

Version	DT	Article No.	Price per PU	PU (UNIT, SET, M)	PS*
<b>Accessories for enclosures</b>					
<b>Sealing covers</b>					
 3ZY1321-1AA00	• 17.5 mm	A	<b>3ZY1321-1AA00</b>	1	5 units
 3ZY1321-2AA00	• 22.5 mm	A	<b>3ZY1321-2AA00</b>	1	5 units
 3ZY1311-0AA00	<b>Push-in lugs</b> For wall mounting	A	<b>3ZY1311-0AA00</b>	1	10 units
 3ZY1440-0AA00	<b>Coding pins</b> For removable terminals of SIRIUS devices in the industrial standard mounting rail enclosure; enable the mechanical coding of terminals	A	<b>3ZY1440-1AA00</b>	1	12 units
<b>Terminals for SIRIUS devices in the industrial standard mounting rail enclosure</b>					
 3ZY1122-1BA00	<b>Removable terminals</b> • 2-pole, screw terminals 1 x 4 mm <sup>2</sup>	A	<b>Screw terminals</b>  <b>3ZY1122-1BA00</b>	1	6 units
 3ZY1122-2BA00	• 2-pole, push-in terminals 1 x 4 mm <sup>2</sup>	A	<b>Spring-type terminals (push-in)</b>  <b>3ZY1122-2BA00</b>	1	6 units
<b>Tools for opening spring-type terminals</b>					
 3RA2908-1A	<b>Screwdrivers</b> For all SIRIUS devices with spring-type terminals; 3,0 mm x 0.5 mm; length approx. 200 mm, titanium gray/black, partially insulated	A	<b>Spring-type terminals</b>  <b>3RA2908-1A</b>	1	1 unit

# Timing Relays

3RP20 timing relays, 45 mm

## Overview

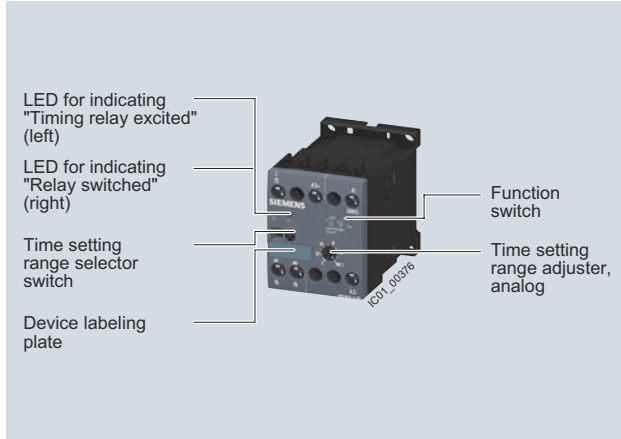

SIRIUS 3RP20 timing relays

SIRIUS 3RP20 electronic timing relays for use in control systems and mechanical engineering with:

- 1 or 2 CO contacts
- Multifunction or monofunction
- Wide voltage range or combination voltage
- Single or selectable time setting ranges
- Switch position indication and voltage indication by LED

### Standards

The timing relays comply with:

- IEC 60721-3-3 "Classification of environmental conditions"
- IEC 61812-1 "Time relays for industrial and residential use"
- IEC 61000-6-2 and EN 61000-6-4 "Electromagnetic compatibility"
- IEC 60947-5-1 "Low-voltage switchgear and controlgear – Electromechanical control circuit devices"
- IEC 60947-1, Appendix N "Protective separation"

### Multifunction

The functions of the 3RP2005 multifunctional timing relays can be set by means of the function selector switch. Insert labels can be used to adjust different functions of the timing relay clearly and unmistakably. The corresponding labels can be ordered as an accessory. The same potential must be applied to terminals A. and B.

For functions, see 3RP2901 label set, page 11/58.

#### Note:

The activation of loads parallel to the start input is not permissible when using AC control voltage (see diagrams).

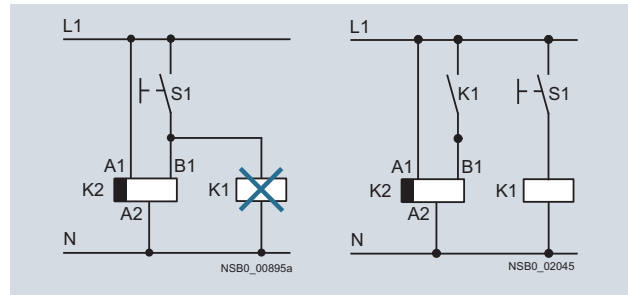

Diagrams

### Accessories

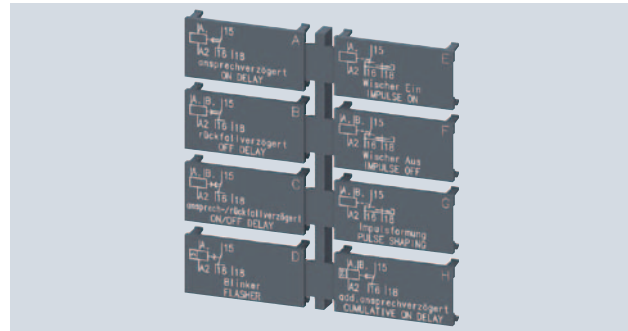

Label set for marking the multifunctional relay

### Article No. scheme

Digit of the Article No.	1st - 5th	6th	7th	8th	9th	10th	11th	12th
	□□□□□	□	□	-	□	□	□	0
SIRIUS timing relays, enclosure 45 mm	3 R P 2 0							
Functions/time setting ranges		□	□					
Connection type					□			
Contacts						□		
Rated control supply voltage							□	□
Example	3 R P 2 0 5 - 1 A P 3 0							

#### Note:

The Article No. scheme is presented here merely for information purposes and for better understanding of the logic behind the article numbers.

For your orders, please use the article numbers quoted in the catalog in the Selection and ordering data.

### Benefits

- Suitable for 3RT miniature contactors
- Uniform design
- Ideal for small distance between standard mounting rails and/or for low mounting depth, e.g. in control boxes
- Labels are used on the multifunctional time relay to document the function that has been set



# Timing Relays

## 3RP20 timing relays, 45 mm

### Application

Timing relays are used in control, starting, and protective circuits for all switching operations involving time delays. They guarantee a high level of functionality and a high repeat accuracy of timer settings.

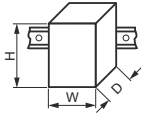
### Technical specifications

Type	3RP2005, 3RP2025		
Dimensions (W x H x D)		mm	45 x 57 x 73
<b>Rated insulation voltage</b> Pollution degree 3 Overvoltage category III	V AC	300	
<b>Permissible ambient temperature</b> • During operation • During storage	°C	-25 ... +60 -40 ... +85	
<b>Operating range at excitation<sup>1)</sup></b>		0.85 ... 1.1 x U <sub>s</sub> at AC; 0.8 ... 1.25 x U <sub>s</sub> at DC; 0.95 ... 1.05 times the rated frequency	
<b>Mechanical endurance</b>	Operating cycles	10 x 10 <sup>6</sup>	
<b>Electrical endurance at I<sub>ε</sub></b>	Operating cycles	1 x 10 <sup>5</sup>	
<b>Connection type</b>	 <b>Screw terminals</b>		
• Terminal screw • Solid • Finely stranded with end sleeve • Stranded • AWG cables • Tightening torque	mm <sup>2</sup> mm <sup>2</sup> AWG AWG Nm	M3 (for standard screwdriver, size 2 and Pozidriv 2) 2 x (0.5 ... 1.5) <sup>2)</sup> , 2 x (0.75 ... 2.5) <sup>2)</sup> 2 x (0.5 ... 1.5) <sup>2)</sup> , 2 x (0.75 ... 2.5) <sup>2)</sup> 2 x (0.5 ... 1.5) <sup>2)</sup> , 2 x (0.75 ... 2.5) <sup>2)</sup> 2 x (18 ... 14) 0.8 ... 1.2	
<b>Connection type</b>	 <b>Spring-type terminals</b>		
• Solid • Finely stranded with end sleeve • Finely stranded without end sleeve • AWG cables, solid or stranded • Max. external diameter of the conductor insulation	mm <sup>2</sup> mm <sup>2</sup> mm <sup>2</sup> AWG mm	2 x (0.25 ... 2.5) 2 x (0.25 ... 1.5) 2 x (0.25 ... 2.5) 2 x (24 ... 14) 3.6	

1) If nothing else is stated.

2) If two different conductor cross-sections are connected to one clamping point, both cross-sections must lie in one of the ranges specified.

### 3RP20 internal circuit diagrams

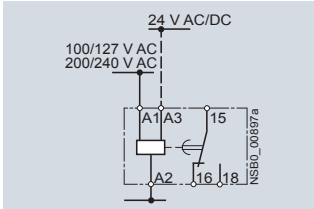
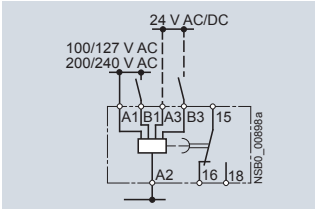
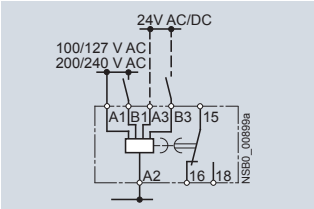
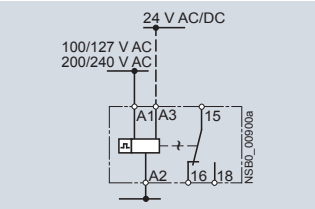
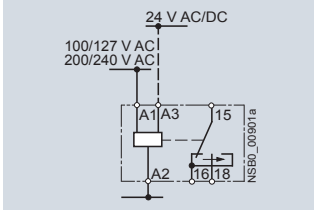
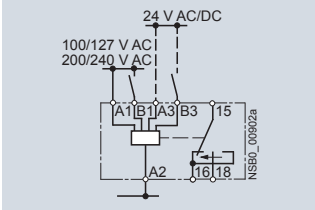
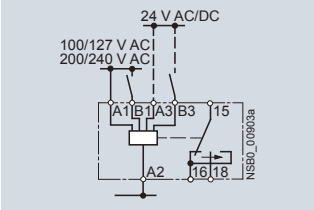
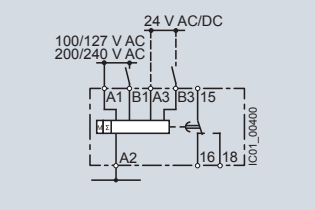
			
3RP2005, 3RP2025 ON-delay	3RP2005 OFF-delay with control signal	3RP2005 ON-delay and OFF-delay with control signal	3RP2005 Flashing, starting with interval
			
3RP2005 Passing make contact	3RP2005 Passing break contact with control signal	3RP2005 Pulse-forming with control signal	3RP2005 Additive ON-delay with control signal

**3RP20 function diagrams and 3RP2901 label set**

1 CO contact

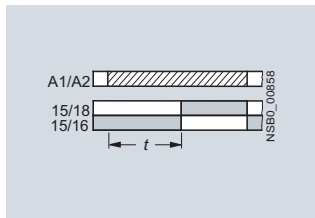

**A**  
3RP2005-.A, 3RP2025  
ON-delay

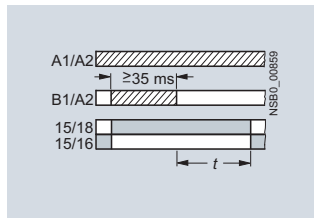

**B<sup>1)</sup>**  
3RP2005-.A  
OFF-delay with control signal

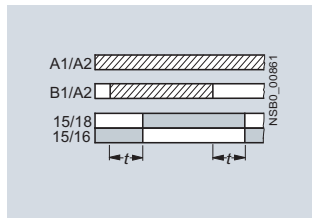

**C<sup>1)</sup>**  
3RP2005-.A  
ON-delay and OFF-delay  
with control signal ( $t = t_{on} = t_{off}$ )

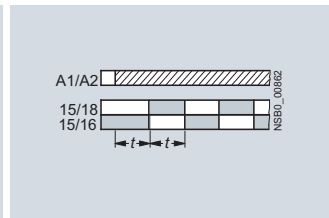

**D**  
3RP2005-.A  
Flashing, starting with interval  
(pulse/interval 1:1)

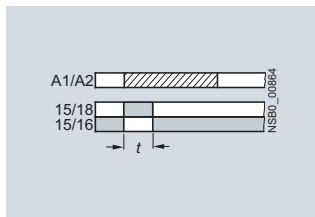

**E**  
3RP2005-.A  
Passing make contact

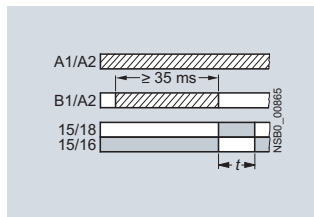

**F<sup>1)</sup>**  
3RP2005-.A  
Passing break contact  
with control signal

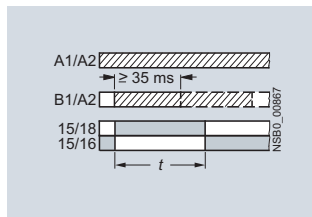

**G<sup>1)</sup>**  
3RP2005-.A  
Pulse-forming with control signal  
(pulse generation at the output does  
not depend on duration of energizing)

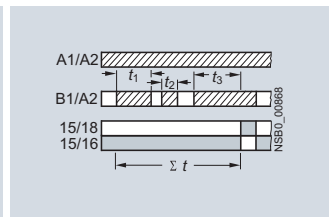

**H<sup>1)</sup>**  
3RP2005-.A  
Additive ON-delay with control signal

Legend

**A ... H** Identification letters for 3RP2005

▨ Timing relay energized

■ Contact closed

□ Contact open

<sup>1)</sup> Note on function with start contact: A new control signal at terminal B, after the operating time has started, resets the operating time to zero (retriggerable). This does not apply to G, G● and H●, which are not retriggerable.

# Timing Relays

## 3RP20 timing relays, 45 mm

2 CO contacts

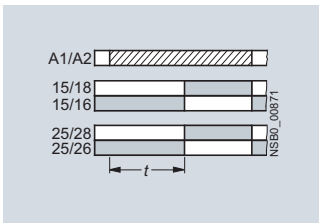

**A**  
3RP2005-B  
ON-delay

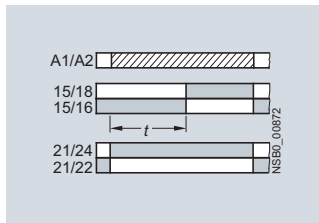

**A•**  
3RP2005-B  
ON-delay and instantaneous contact

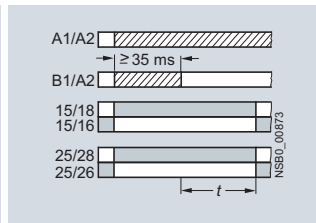

**B1)**  
3RP2005-B  
OFF-delay with control signal

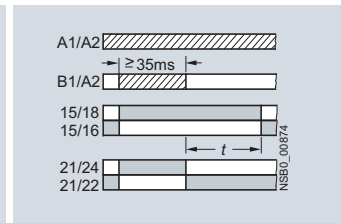

**B•1)**  
3RP2005-B  
OFF-delay with control signal and instantaneous contact

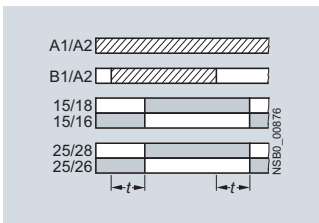

**C1)**  
3RP2005-B  
ON-delay and OFF-delay with control signal ( $t = t_{on} = t_{off}$ )

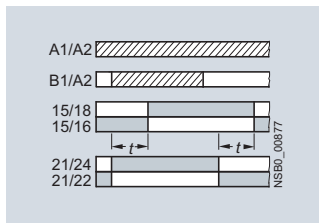

**C•1)**  
3RP2005-B  
ON-delay and OFF-delay with control signal and instantaneous contact ( $t = t_{on} = t_{off}$ )

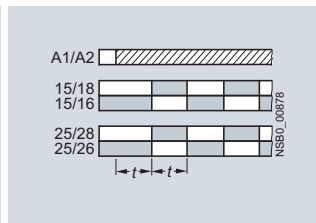

**D**  
3RP2005-B  
Flashing, starting with interval (pulse/interval 1:1)

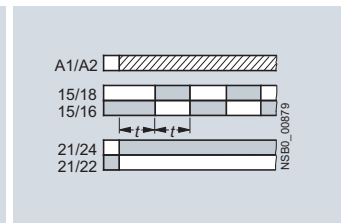

**D•**  
3RP2005-B  
Flashing, starting with interval (pulse/interval 1:1) and instantaneous contact

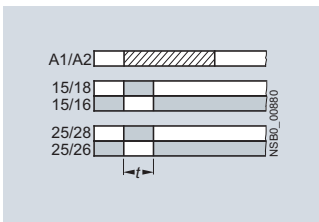

**E**  
3RP2005-B  
Passing make contact

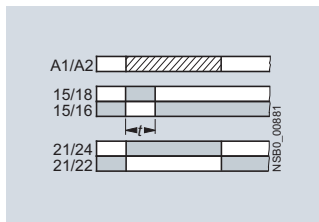

**E•**  
3RP2005-B  
Passing make contact and instantaneous contact

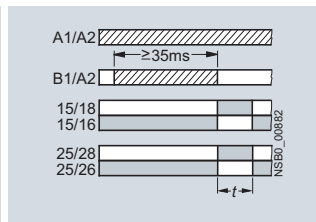

**F1)**  
3RP2005-B  
Passing break contact with control signal

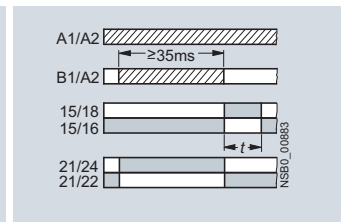

**F•1)**  
3RP2005-B  
Passing break contact with control signal and instantaneous contact

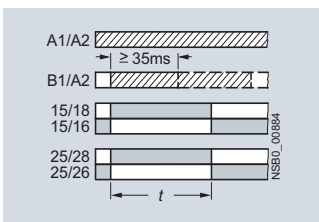

**G1)**  
3RP2005-B  
Pulse-forming with control signal (pulse generation at the output does not depend on duration of energizing)

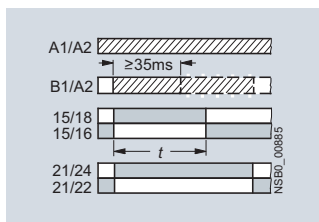

**G•1)**  
3RP2005-B  
Pulse-forming with control signal and instantaneous contact (pulse generation at the output does not depend on duration of energizing)

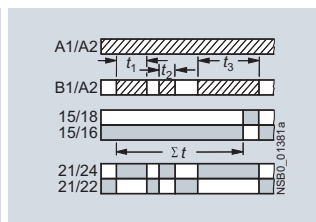

**H•1)**  
3RP2005-B  
Additive ON-delay with control signal and instantaneous contact

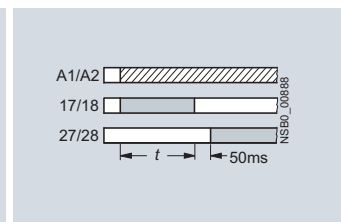

**YΔ**  
3RP2005-B  
Wye-delta function

Legend

**A ... H** Identification letters for 3RP2005

- ▨ Timing relay energized
- Contact closed
- Contact open

1) Note on function with start contact: A new control signal at terminal B, after the operating time has started, resets the operating time to zero (retriggerable). This does not apply to G, G• and H•, which are not retriggerable.



# Timing Relays

## 3RP20 timing relays, 45 mm

### Selection and ordering data

PU (UNIT, SET, M) = 1  
PS\* = 1 unit



3RP2005-1AP30



3RP2005-1BW30



3RP2005-2AP30



3RP2025-2BW30

Version	Time setting range $t$	Rated control supply voltage $U_s$	DT	Screw terminals	DT	Spring-type terminals
		50/60 Hz AC	DC			
		V	V	Article No.	Price per PU	Article No. Price per PU

### 3RP2005 timing relays, multifunction, 15 time setting ranges

The functions can be adjusted by means of rotary switches. Insert labels can be used to adjust different functions of the 3RP2005 timing relay clearly and unmistakably. The corresponding labels can be ordered as an accessory. The same potential must be applied to terminals A. and B. For functions, see 3RP2901 label set, page 11/58.

With LED and 1 CO contact <sup>1)</sup> , 8 functions	0.05 ... 1 s 0.15 ... 3 s 0.5 ... 10 s	24/100 ... 127 24/200 ... 240	24 24	▶	▶	▶
With LED and 2 CO contacts, 16 functions	1.5 ... 30 s 0.05 ... 1 min 5 ... 100 s 0.15 ... 3 min 0.5 ... 10 min 1.5 ... 30 min 0.05 ... 1 h 5 ... 100 min 0.15 ... 3 h 0.5 ... 10 h 1.5 ... 30 h 5 ... 100 h $\infty$ <sup>2)</sup>	24 ... 240 <sup>3)</sup>	24 ... 240 <sup>4)</sup>	▶	▶	▶

### 3RP2025 timing relays, ON-delay, 15 time setting ranges

With LED and 1 CO contact <sup>1)</sup>	0.05 ... 1 s 0.15 ... 3 s 0.5 ... 10 s 1.5 ... 30 s 0.05 ... 1 min 5 ... 100 s 0.15 ... 3 min 0.5 ... 10 min 1.5 ... 30 min 0.05 ... 1 h 5 ... 100 min 0.15 ... 3 h 0.5 ... 10 h 1.5 ... 30 h 5 ... 100 h $\infty$ <sup>2)</sup>	24/100 ... 127 24/200 ... 240	24 24	▶	▶	▶
---	---	----------------------------------	----------	---	---	---

For accessories, see page 11/58.

- 1) Units with protective separation.
- 2) With switch position  $\infty$  no timing. For test purposes (ON/OFF function) on site. Relay is constantly on when activated, or relay remains constantly off when activated. Depending on which function is set.
- 3) Operating range 0.8 to 1.1 x  $U_s$ .
- 4) Operating range 0.7 to 1.1 x  $U_s$ .

# Timing Relays

## 3RP20 timing relays, 45 mm

### Accessories

Version	Function	Identifi- cation letter	Use	DT	Article No.	Price per PU	PU (UNIT, SET, M)	PS*
---------	----------	-------------------------------	-----	----	-------------	-----------------	-------------------------	-----

#### Label sets for 3RP20

Accessories for 3RP20 (not included in the scope of supply).  
The label set offers the possibility of labeling timing relays with the set function in English and German.



3RP2901-0A

1 label set (1 unit) with 8 functions	ON-delay	A	For devices with 1 CO	C	<b>3RP2901-0A</b>		1	5 units
	OFF-delay with control signal	B						
	ON-delay and OFF-delay with control signal	C						
	Flashing, starting with interval	D						
	Passing make contact	E						
	Passing break contact with control signal	F						
	Pulse-forming with control signal	G						
	Additive ON-delay with control signal	H						



3RP2901-0B

1 label set (1 unit) with 16 functions	ON-delay	A	For devices with 2 CO contacts	C	<b>3RP2901-0B</b>		1	5 units
	OFF-delay with control signal	B						
	ON-delay and OFF-delay with control signal	C						
	Flashing, starting with interval	D						
	Passing make contact	E						
	Passing break contact with control signal	F						
	Pulse-forming with control signal	G						
	ON-delay and instantaneous contact	A•						
	OFF-delay with control signal and instantaneous contact	B•						
	ON-delay and OFF-delay with control signal and instantaneous contact	C•						
	Flashing, starting with interval, and instantaneous contact	D•						
	Passing make contact and instantaneous contact	E•						
	Passing break contact with control signal and instantaneous contact	F•						
	Pulse-forming with control signal and instantaneous contact	G•						
	Additive ON-delay with control signal and instantaneous contact	H•						
	Wye-delta function	YΔ						

#### Blank inscription labels for 3RP20

Blank labels, 20 mm x 7 mm, pastel turquoise			For 3RP20	D	<b>3RT1900-1SB20</b>		100	340 units
---	--	--	-----------	---	----------------------	--	-----	-----------

# Timing Relays

7PV15 timing relays in enclosure, 17.5 mm

## Overview



7PV15 timing relay

Electronic timing relays for general use and in control systems, mechanical engineering and infrastructure with:

- 1 or 2 CO contacts
- Multifunction or monofunction
- Wide voltage range or combination voltage
- Single or selectable time setting ranges
- Switch position indication and voltage indication by LED

### Standards

The timing relays comply with:

- IEC 60721-3-3 "Classification of environmental conditions"
- IEC 61812-1 "Time relays for industrial and residential use"
- IEC 61000-6-2 and EN 61000-6-4 "Electromagnetic compatibility"
- IEC 60947-5-1 "Low-voltage switchgear and controlgear – Electromechanical control circuit devices"
- DIN 43880 "Built-in equipment for electrical installations; overall dimensions and related mounting dimensions"

### Multifunction

The functions of the 7PV1508-1A multifunctional timing relays can be set by means of rotary switches. The identification letters A to G are printed on the front alongside the rotary selector switch of the unit. The related function can be found in the form of a bar graph on the side of the device.

### Enclosure version

All timing relays are suitable for snap-on mounting onto TH 35 standard mounting rails according to IEC 60715. The enclosure complies with DIN 43880, 1 MW.

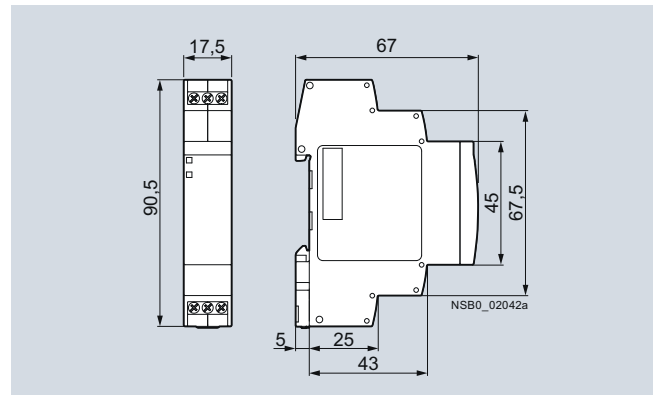

Dimensions

### Note:

The activation of loads parallel to the start input is not permissible when using AC control voltage (see diagrams).

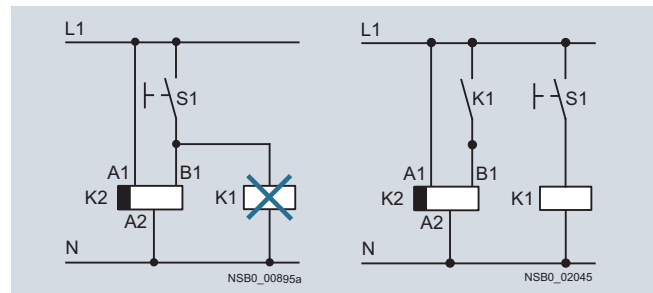

Diagrams

### Article No. scheme

Digit of the Article No.	1st - 5th	6th	7th	8th	9th	10th	11th	12th
	□□□□□	□	□	-	□	□	□	0
<b>Timing relays in industrial enclosure, 17.5 mm</b>	<b>7 P V 1 5</b>							
<b>Functions/time setting ranges</b>	□	□						
<b>Connection type</b>				□				
<b>Contacts</b>					□			
<b>Rated control supply voltage</b>						□	□	
<b>Example</b>	<b>7 P V 1 5</b>	<b>0</b>	<b>8</b>	<b>-</b>	<b>1</b>	<b>A</b>	<b>W</b>	<b>3 0</b>

### Note:

The Article No. scheme is presented here merely for information purposes and for better understanding of the logic behind the article numbers.

For your orders, please use the article numbers quoted in the catalog in the Selection and ordering data.

# Timing Relays

7PV15 timing relays in enclosure, 17.5 mm

### Benefits

- Wide voltage range 12 to 240 V AC/DC
- High switching capacity, e.g. AC-15 at 230 V, 3 A
- Combination voltage, e.g. 24 V AC/DC and 200 to 240 V AC
- Changes to the time setting range during operation
- Changes to the function in the de-energized state
- High level of functionality and a high repeat accuracy of timer settings
- Integrated surge suppressor
- Function charts printed on the side of the device for reliable device adjustment

### Application

Timing relays are used in control, starting and protective circuits for all switching operations involving time delays, e.g. in non-residential buildings, airports, industrial buildings etc.

### Technical specifications

<b>Type</b>		<b>7PV15</b>
<b>Rated insulation voltage</b> Pollution degree 2, overvoltage category III	V AC	300
<b>Permissible ambient temperature</b>		
• During operation	°C	-25 ... +55
• During storage	°C	-40 ... +70
<b>Operating range at excitation<sup>1)</sup></b>		0.85 ... 1.1 x $U_N$ at V AC/DC, 50/60 Hz 0.8 ... 1.25 x $U_N$ 24 V DC 0.95 ... 1.05 times the rated frequency
<b>Rated operational current <math>I_o</math></b>		
• AC-15 at 24 ... 240 V, 50 Hz	A	3
• DC-13 at		
- 24 V	A	1
- 125 V	A	0.2
<b>Uninterrupted thermal current <math>I_{th}</math></b>	A	5
<b>Mechanical endurance</b>	Operating cycles	1 x 10 <sup>6</sup>
<b>Electrical endurance at <math>I_e</math></b>	Operating cycles	1 x 10 <sup>5</sup>
<b>Connection type</b>		 <b>Screw terminals</b>
• Terminal screw		M3 (for standard screwdriver, size 2 and Pozidriv 2)
• Solid	mm <sup>2</sup>	1 x (0.2 ... 2.5)
• Finely stranded with end sleeve	mm <sup>2</sup>	1 x (0.25 ... 1.5)
• Finely stranded without end sleeve	mm <sup>2</sup>	1 x (0.2 ... 1.5)
• AWG cables, solid or stranded	AWG	1 x (24 ... 14)
• Tightening torque	Nm	0.4 ... 0.5

<sup>1)</sup> If nothing else is stated.

### 7PV15 internal circuit diagrams

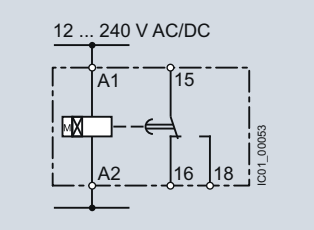
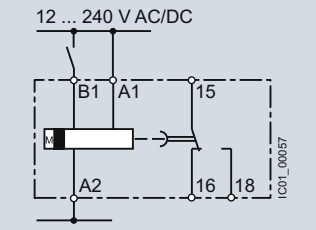
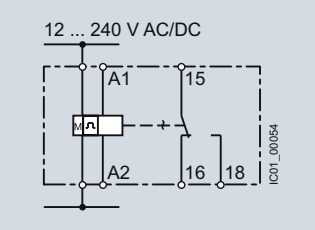
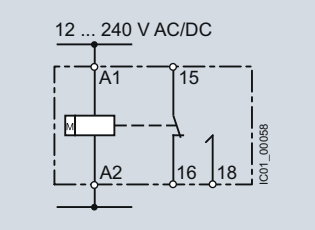
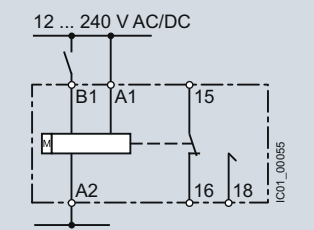
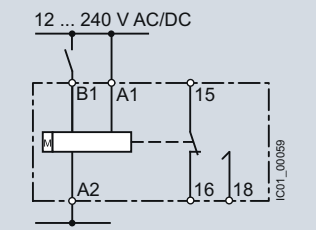
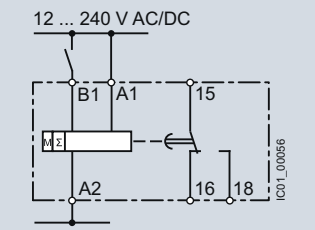
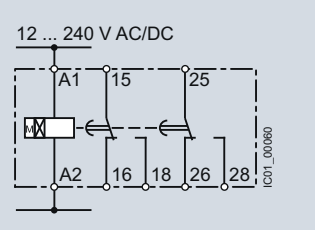
 <p>12 ... 240 V AC/DC</p> <p>7PV1508-1AW30 ON-delay</p>	 <p>12 ... 240 V AC/DC</p> <p>7PV1508-1AW30 OFF-delay</p>	 <p>12 ... 240 V AC/DC</p> <p>7PV1508-1AW30 Flashing, starting with interval</p>	 <p>12 ... 240 V AC/DC</p> <p>7PV1508-1AW30 Passing make contact</p>
 <p>12 ... 240 V AC/DC</p> <p>7PV1508-1AW30 Passing break contact with control signal</p>	 <p>12 ... 240 V AC/DC</p> <p>7PV1508-1AW30 Pulse-forming with control signal</p>	 <p>12 ... 240 V AC/DC</p> <p>7PV1508-1AW30 Additive ON-delay with control signal</p>	 <p>12 ... 240 V AC/DC</p> <p>7PV1508-1BW30 ON-delay</p>

# Timing Relays

7PV15 timing relays in enclosure, 17.5 mm

## 7PV15 internal circuit diagrams (continued)

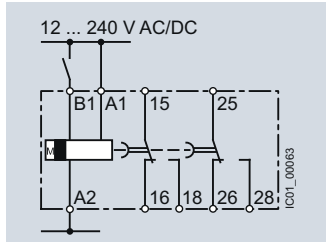

7PV1508-1BW30  
OFF-delay  
with control signal

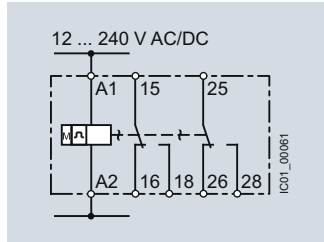

7PV1508-1BW30  
Flashing,  
starting with interval

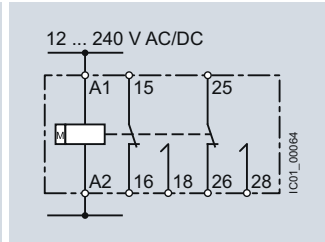

7PV1508-1BW30  
Passing make contact

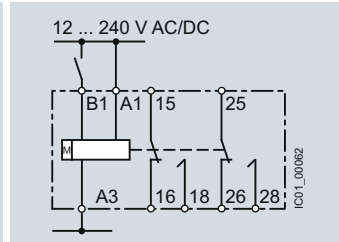

7PV1508-1BW30  
Pulse-forming  
with control signal

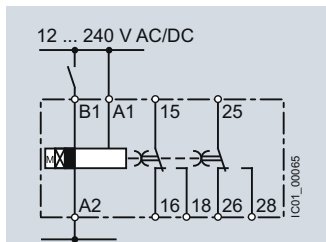

7PV1508-1BW30  
ON and OFF-delay

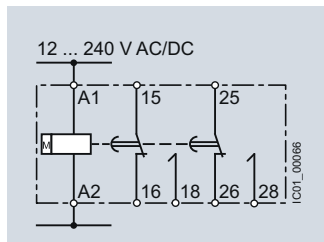

7PV1508-1BW30  
Fixed pulse after ON-delay

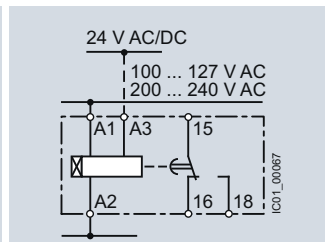

7PV151.-1AQ30, 7PV151.-1AP30  
ON-delay

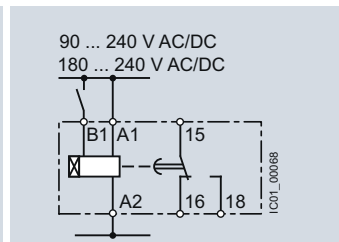

7PV1518-1AJ30, 7PV1518-1AN30  
ON-delay

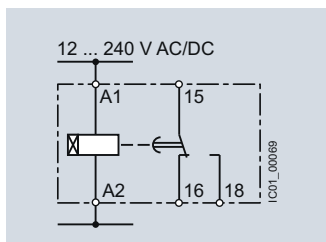

7PV1518-1AW30  
ON-delay

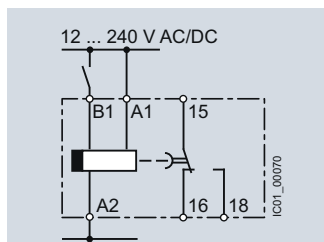

7PV1538-1AW30  
OFF-delay  
with control signal

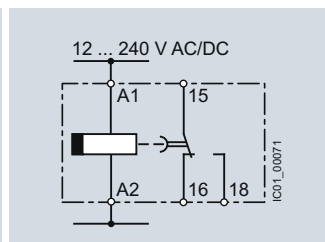

7PV1540-1AW30  
OFF-delay  
without control signal

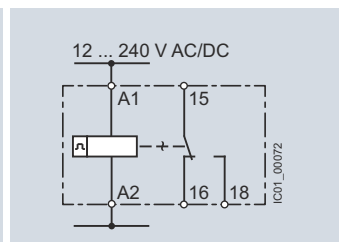

7PV1558-1AW30  
Clock-pulse relay

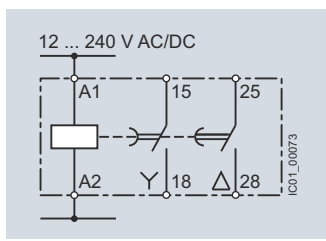

7PV1578-1BW30  
Wye-delta

# Timing Relays

7PV15 timing relays in enclosure, 17.5 mm

## 7PV15 function diagrams

1 CO contact

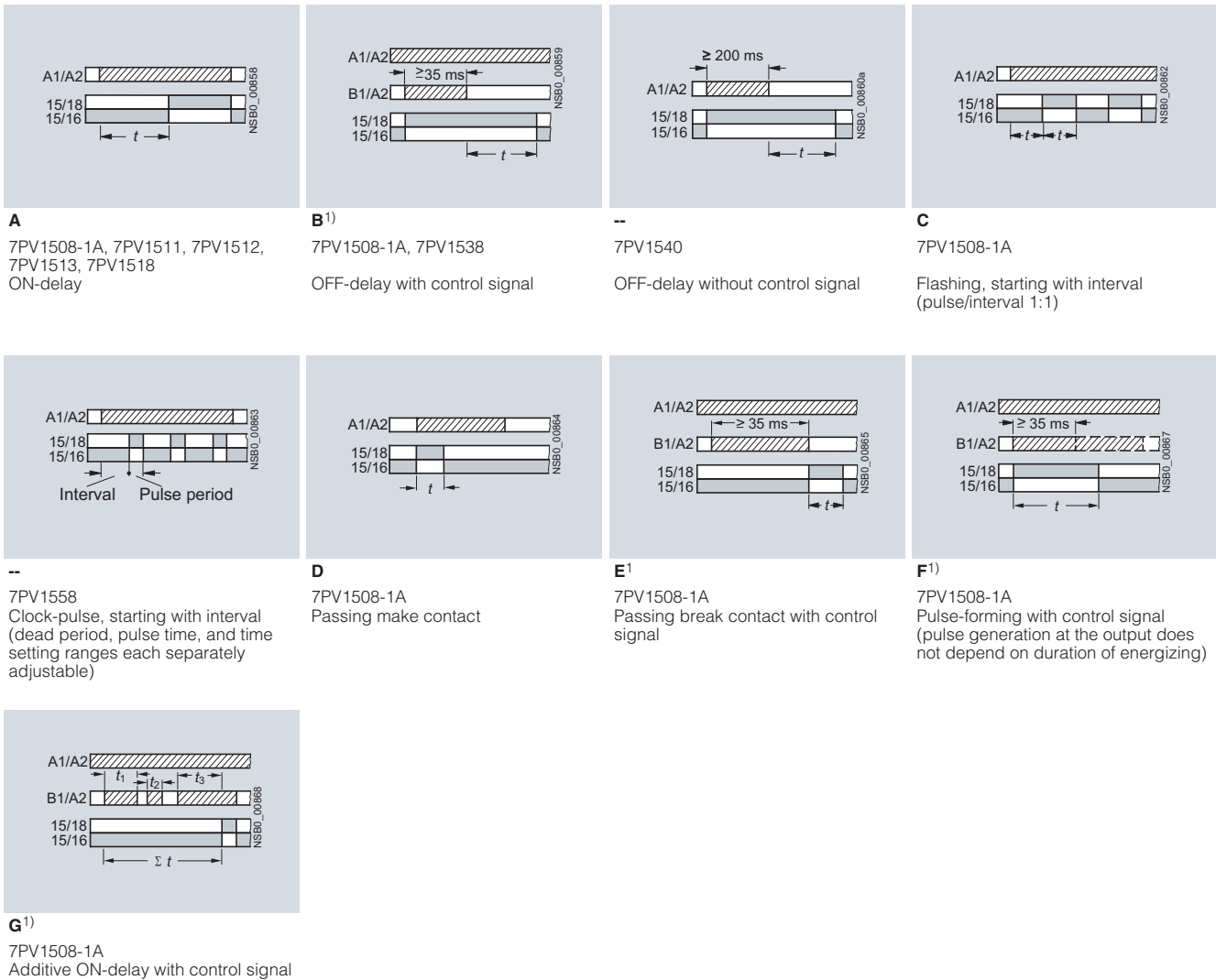

Legend

**A ... G** Identification letters for 7PV1508

- Timing relay energized
- Contact closed
- Contact open

<sup>1)</sup> Note on function with start contact: A new control signal at terminal B, after the operating time has started, resets the operating time to zero (retriggerable). This does not apply to E, F and G, which are not retriggerable.

Note:

With the 7PV1508-1A multifunctional relay the identification letters A to G are printed on the front alongside the rotary selector switch of the unit. The related function can be found in the form of a bar graph on the side of the device.

# Timing Relays

## 7PV15 timing relays in enclosure, 17.5 mm

### 2 CO contacts

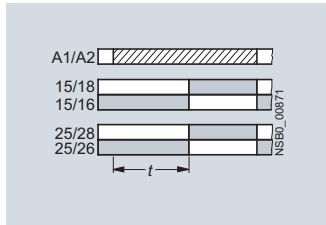

**A**  
7PV1508-1B  
ON-delay

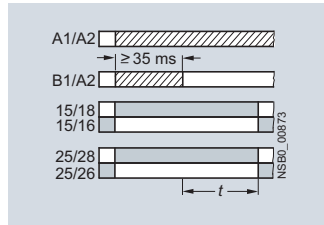

**B<sup>1)</sup>**  
7PV1508-1B  
OFF-delay with control signal

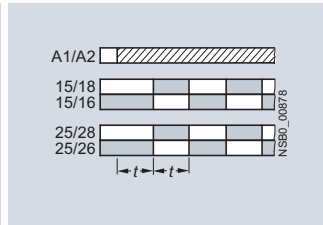

**C**  
7PV1508-1B  
Flashing, starting with interval  
(pulse/interval 1:1)

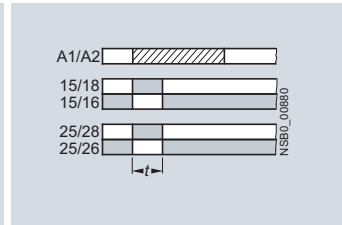

**D**  
7PV1508-1B  
Passing make contact

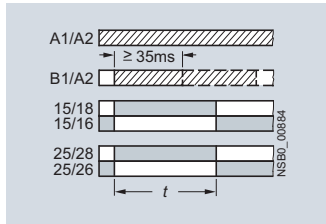

**F<sup>1)</sup>**  
7PV1508-1B  
Pulse-forming with control signal  
(pulse generation at the output does  
not depend on duration of  
energizing)

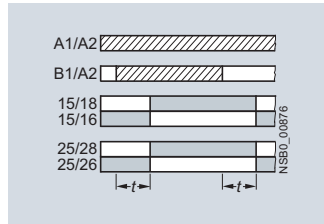

**H<sup>1)</sup>**  
7PV1508-1B  
ON-delay and OFF-delay  
with control signal

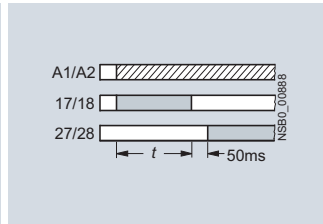

**I**  
7PV1508-1B  
Fixed pulse after ON-delay

### 2 NO contacts

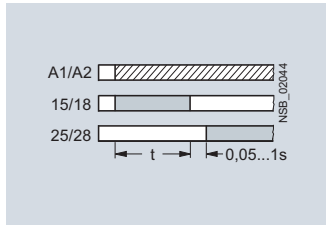

--  
7PV1578  
Wye-delta function<sup>2)</sup>

#### Legend

**A ... D, F, H, I** Identification letters for 7PV1508

- Timing relay energized
- Contact closed
- Contact open

<sup>1)</sup> Note on function with start contact: A new control signal at terminal B, after the operating time has started, resets the operating time to zero (retriggerable). This does not apply to E, F and G, which are not retriggerable.

<sup>2)</sup> With 7PV1578 the contacts 16 and 26 are not needed for the wye-delta function.

#### Note:

With the 7PV1508-1B multifunctional relay the identification letters A to D, F, H, I are printed on the front alongside the rotary selector switch of the unit. The related function can be found in the form of a bar graph on the side of the device.

# Timing Relays

7PV15 timing relays in enclosure, 17.5 mm

### Selection and ordering data



Version	Time setting range $t$ adjustable by rotary switch to	Rated control supply voltage $U_s$	DT	Screw terminals	PU (UNIT, SET, M)	PS*
		50/60 Hz AC V	DC V	Article No.	Price per PU	
<b>7PV1508 timing relays, multifunction, 7 time setting ranges</b>						
The functions can be adjusted by means of rotary switches. The same potential must be applied to terminals A. and B.						
With LED and 1 CO contact, 7 functions	0.05 ... 1 s 0.5 ... 10 s 5 ... 100 s	12 ... 240	12 ... 240	▶ <b>7PV1508-1AW30</b>	1	1 unit
With LED and 2 CO contacts, 7 functions	30 s ... 10 min 3 min ... 1 h 30 min ... 10 h 5 ... 100 h	12 ... 240	12 ... 240	▶ <b>7PV1508-1BW30</b>	1	1 unit
<b>7PV151. timing relays, ON-delay, 1 time setting range</b>						
With LED and 1 CO contact	0.05 ... 1 s	24/200 ... 240	24	▶ <b>7PV1511-1AP30</b>	1	1 unit
	0.5 ... 10 s	24/100 ... 127	24	▶ <b>7PV1512-1AQ30</b>	1	1 unit
		24/200 ... 240	24	▶ <b>7PV1512-1AP30</b>	1	1 unit
	5 ... 100 s	24/100 ... 127	24	▶ <b>7PV1513-1AQ30</b>	1	1 unit
		24/200 ... 240	24	▶ <b>7PV1513-1AP30</b>	1	1 unit
<b>7PV1518 timing relays, ON-delay, 7 time setting ranges</b>						
With LED and 1 CO contact	0.05 ... 1 s	12 ... 240	12 ... 240	▶ <b>7PV1518-1AW30</b>	1	1 unit
	0.5 ... 10 s	90 ... 127	90 ... 127	▶ <b>7PV1518-1AJ30</b>	1	1 unit
	5 ... 100 s	180 ... 240	180 ... 240	▶ <b>7PV1518-1AN30</b>	1	1 unit
	30 s ... 10 min 3 min ... 1 h 30 min ... 10 h 5 ... 100 h					
<b>7PV1538 timing relays, OFF-delay, with control signal, 7 time setting range</b>						
With LED and 1 CO contact	0.05 ... 1 s 0.5 ... 10 s 5 ... 100 s 30 s ... 10 min 3 min ... 1 h 30 min ... 10 h 5 ... 100 h	12 ... 240	12 ... 240	▶ <b>7PV1538-1AW30</b>	1	1 unit
<b>7PV1540 timing relays, OFF-delay, without control signal, 7 time setting ranges</b>						
With LED and 1 CO contact	0.05 ... 1 s 0.15 ... 3s 0.3 ... 6 s 0.5 ... 10 s 1.5 ... 30 s 3 ... 60 s 5 ... 100 s	12 ... 240	12 ... 240	▶ <b>7PV1540-1AW30</b>	1	1 unit
<b>7PV1558 timing relays, clock-pulse relay, 7 time setting ranges</b>						
With LED and 1 CO contact	0.05 ... 1 s 0.5 ... 10 s 5 ... 100 s 30 s ... 10 min 3 min ... 1 h 30 min ... 10 h 5 ... 100 h	12 ... 240	12 ... 240	▶ <b>7PV1558-1AW30</b>	1	1 unit
<b>7PV1578 timing relays, wye-delta function, 7 time setting ranges</b>						
With LED and 2 NO contacts, dead interval 0.05 ... 1 s adjustable	0.05 ... 1 s 0.5 ... 10 s 5 ... 100 s 30 s ... 10 min 3 min ... 1 h 30 min ... 10 h 5 ... 100 h	12 ... 240	12 ... 240	▶ <b>7PV1578-1BW30</b>	1	1 unit



Overview



SIRIUS 3UG4 monitoring relay

More information

Homepage, see [www.usa.siemens.com/relays](http://www.usa.siemens.com/relays)  
 Industry Mall, see [www.siemens.com/product?3UG45](http://www.siemens.com/product?3UG45)  
 For the conversion tool, e.g. from 3UG3 to 3UG4, see [www.siemens.com/sirius/conversion-tool](http://www.siemens.com/sirius/conversion-tool)

The field-proven SIRIUS monitoring relays for electrical and mechanical variables enable constant monitoring of all important characteristic quantities that provide information about the functional capability of a plant. Both sudden disturbances and gradual changes, which may indicate the need for maintenance, are detected. Thanks to their relay outputs, the monitoring relays permit direct disconnection of the affected system components as well as alerting (e.g. by switching a warning lamp).

Thanks to adjustable delay times the monitoring relays can respond very flexibly to brief faults such as voltage dips or load changes. This avoids unnecessary alarms and disconnections while enhancing plant availability.

The individual 3UG4 monitoring relays offer the following functions in various combinations:

- Undershooting and/or overshooting of liquid levels
- Phase sequence
- Phase failure, neutral conductor failure
- Phase asymmetry
- Undershooting and/or overshooting of limit values for voltage
- Undershooting and/or overshooting of limit values for current
- Undershooting and/or overshooting of limit values for power factor
- Monitoring of the active current or the apparent current
- Monitoring of the residual current
- Monitoring of the insulation resistance
- Undershooting and/or overshooting of limit values for speed

Article No. scheme

Product versions	Article number
<b>Monitoring relays</b>	<b>3UG4</b> <input type="checkbox"/> <input type="checkbox"/> <input type="checkbox"/> - <input type="checkbox"/> <input type="checkbox"/> <input type="checkbox"/> <input type="checkbox"/> <b>0</b>
Type of setting e.g. 5 = analogically adjustable	<input type="checkbox"/>
Functions e.g. 11 = line monitoring	<input type="checkbox"/> <input type="checkbox"/>
Connection type	Screw terminals <b>1</b>
	Spring-type terminals <b>2</b>
Contacts e.g. A = 1 CO contact	<input type="checkbox"/>
Supply voltage e.g. N2 = 160 ... 260 V AC	<input type="checkbox"/> <input type="checkbox"/>
Example	<b>3UG4 5 1 1 - 1 A N 2 0</b>

Note:

The Article No. scheme shows an overview of product versions for better understanding of the logic behind the article numbers.

For your orders, please use the article numbers quoted in the selection and ordering data.

## Benefits

- Customary screw and spring-type terminals for quick and reliable wiring
- Fast commissioning thanks to menu-guided parameterization and actual value display for limit value determination
- Reduced space requirement in the control cabinet thanks to a consistent width of 22.5 mm
- Parameterizable monitoring functions, delay times, RESET response, etc.
- Reduced stockkeeping thanks to minimized variance and large measuring ranges
- Wide-voltage power supply units for global applicability
- Device replacement without renewed wiring thanks to removable terminals
- Reliable system diagnostics thanks to actual value display and connectable fault memory
- Rapid diagnostics thanks to unambiguous error messages on the display

## Application

The SIRIUS 3UG4 monitoring relays monitor the most diverse electrical and mechanical quantities in the feeder, and provide reliable protection against damage in the plant. For this purpose, they offer freely parameterizable limit values and diverse options for adapting to the respective task, and in the event of a fault, they provide clear diagnostics information.

The digitally adjustable products also display the current measured values direct on the device. This not only facilitates the display of valuable plant status information during operation, it also enables adjustment of the monitored limit values in accordance with the actual conditions.

The positive result: More selective avoidance of production faults – sustained increases in availability and productivity.

The 3UG4 monitoring relays are available for the following applications:

- Line and single-phase voltage monitoring
- Single-phase current monitoring or power factor and active current monitoring
- Residual current monitoring
- Insulation monitoring
- Level monitoring
- Speed monitoring



## Technical specifications

### More information

Technical specifications, see <https://support.industry.siemens.com/cs/ww/en/ps/16367/td>

FAQs, see <https://support.industry.siemens.com/cs/ww/en/ps/16367/faq>

Manual and internal circuit diagrams, see <https://support.industry.siemens.com/cs/ww/en/view/54397927>

Type	3UG	
<b>General data</b>		
Dimensions (W x H x D)		
• For 2 terminal blocks - Screw terminals - Spring-type terminals	mm	22.5 x 83 x 91
	mm	22.5 x 84 x 91
• For 3 terminal blocks - Screw terminals - Spring-type terminals	mm	22.5 x 92 x 91
	mm	22.5 x 94 x 91
• For 4 terminal blocks - Screw terminals - Spring-type terminals	mm	22.5 x 103 x 91
	mm	22.5 x 103 x 91
<b>Permissible ambient temperature</b>		
• During operation	°C	-25 ... +60
<b>Connection type</b>		 <b>Screw terminals</b>
• Terminal screw • Solid • Finely stranded with end sleeve • AWG cables, solid or stranded	mm <sup>2</sup>	M3 (for standard screwdriver, size 2 and Pozidriv 2)
	mm <sup>2</sup>	1 x (0.5 ... 4)/2 x (0.5 ... 2.5)
	AWG	1 x (0.5 ... 2.5)/2 x (0.5 ... 1.5) 2 x (20 ... 14)
<b>Connection type</b>		 <b>Spring-type terminals</b>
• Solid • Finely stranded, with end sleeve acc. to DIN 46228 • Finely stranded • AWG cables, solid or stranded	mm <sup>2</sup>	2 x (0.25 ... 1.5)
	mm <sup>2</sup>	2 x (0.25 ... 1.5)
	mm <sup>2</sup>	2 x (0.25 ... 1.5)
	AWG	2 x (24 ... 16)

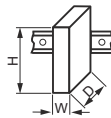

## Overview



SIRIUS 3UG4615 monitoring relay

Electronic line monitoring relays provide maximum protection for mobile machines and plants or for unstable networks. Network and voltage faults can thus be detected early and rectified before far greater damage ensues.

Depending on the version, the relays monitor phase sequence, phase failure with and without N conductor monitoring, phase asymmetry, undervoltage or overvoltage.

Phase asymmetry is evaluated as the difference between the greatest and the smallest phase voltage relative to the greatest phase voltage. Undervoltage or overvoltage exists when at least one phase voltage deviates by 20% from the set rated system voltage or the directly set limit values are overshoot or undershot. The rms value of the voltage is measured.

With the 3UG4617 or 3UG4618 relay, a wrong direction of rotation can also be corrected automatically.

## Benefits

- Can be used without auxiliary voltage in any network from 160 to 630 V AC worldwide thanks to wide voltage range
- Variably adjustable to overshoot, undershoot or range monitoring
- Freely configurable delay times and RESET response
- Width 22.5 mm
- Permanent display of actual value and line fault type on the digital versions
- Automatic correction of the direction of rotation by distinguishing between power system faults and wrong phase sequence
- All versions with removable terminals
- All versions with screw or spring-type terminals

## Application

The relays are used above all for mobile equipment, e.g. air conditioning compressors, refrigerating containers, building site compressors and cranes.

Function	Application
Phase sequence	<ul style="list-style-type: none"> <li>• Direction of rotation of the drive</li> </ul>
Phase failure	<ul style="list-style-type: none"> <li>• A fuse has tripped</li> <li>• Failure of the control supply voltage</li> <li>• Broken cable</li> </ul>
Phase asymmetry	<ul style="list-style-type: none"> <li>• Overheating of the motor due to asymmetrical voltage</li> <li>• Detection of asymmetrically loaded networks</li> </ul>
Undervoltage	<ul style="list-style-type: none"> <li>• Increased current on a motor with corresponding overheating</li> <li>• Unintentional resetting of a device</li> <li>• Network collapse, particularly with battery power</li> </ul>
Overvoltage	<ul style="list-style-type: none"> <li>• Protection of a plant against destruction due to overvoltage</li> </ul>

## Technical specifications

### 3UG4511 monitoring relays

The 3UG4511 phase sequenced relay monitors the phase sequence in a three-phase network. No adjustments are required for operation. The device has an internal power supply and works using the closed-circuit principle. If the phase sequence at the terminals L1-L2-L3 is correct, the output relay picks up after the delay time has elapsed and the LED is lit. If the phase sequence is wrong, the output relay remains in its rest position.

#### Note:

When one phase fails, connected loads (motor windings, lamps, transformers, coils, etc.) create a feedback voltage at the terminal of the failed phase due to the network coupling. Because the 3UG4511 relays are not resistant to voltage feedback, such a phase failure is not detected. Should this be required, then the 3UG4512 monitoring relay must be used.

### Correct phase sequence

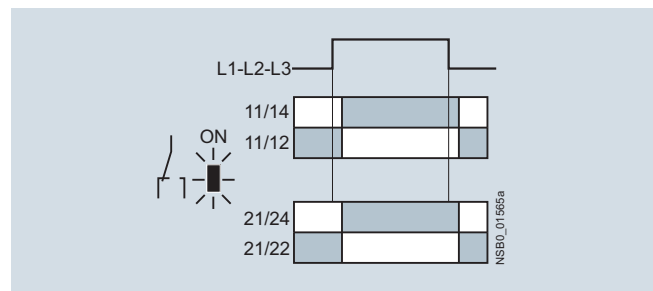

### Wrong phase sequence

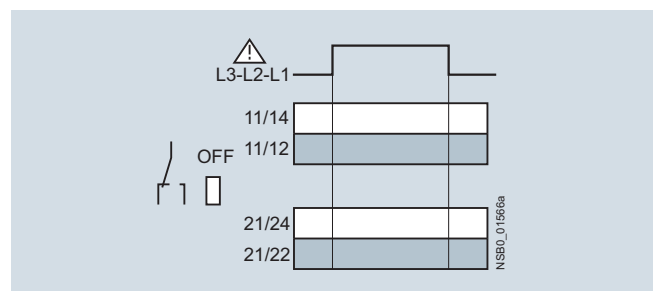

# 3UG45, 3UG46 Monitoring Relays for Stand-Alone Installation

## Line monitoring

### 3UG4512 monitoring relays

The 3UG4512 line monitoring relay monitors three-phase networks with regard to phase sequence, phase failure and phase unbalance of 10%. Thanks to a special measuring method, a phase failure is reliably detected in spite of the wide voltage range from 160 to 690 V AC and feedback through the load of up to 90%. The device has an internal power supply and works using the closed-circuit principle. No adjustments are required. If the line voltage is switched on, the green LED will light up. If the phase sequence at the terminals L1-L2-L3 is correct, the output relay picks up. If the phase sequence is wrong, the red LED flashes and the output relay remains in its rest position. If a phase fails, the red LED is permanently lit and the output relay drops.

**Note:**

The red LED is a fault diagnostic indicator and does not show the current relay status. The 3UG4512 monitoring relay is suitable for line frequencies of 50/60 Hz.

Phase failure

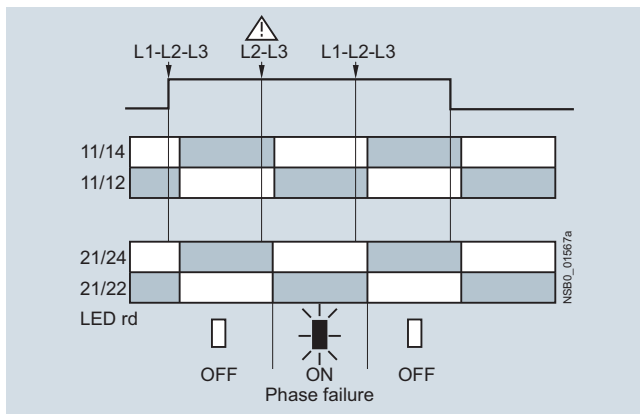

Wrong phase sequence

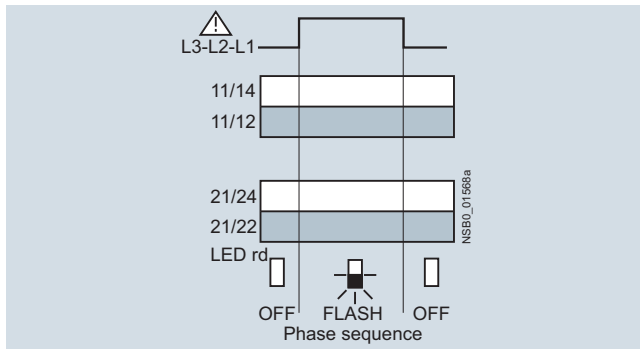

### 3UG4513 monitoring relays

The 3UG4513 line monitoring relay monitors three-phase networks with regard to phase sequence, phase failure, phase asymmetry and undervoltage of 20%. The device has an internal power supply and works using the closed-circuit principle. The hysteresis is 5%. The integrated response delay time T is adjustable from 0 to 20 s and responds to undervoltage. If the direction is incorrect, the device switches off immediately. Thanks to a special measuring method, a phase failure is reliably detected in spite of the wide voltage range from 160 to 690 V and feedback through the load of up to 80%. If the line voltage is switched on, the green LED will light up. If the phase sequence at the terminals L1-L2-L3 is correct, the output relay picks up. If the phase sequence is wrong, the red LED flashes and the output relay remains in its rest position. If a phase fails, the red LED is permanently lit and the output relay drops.

**Note:**

The red LED is a fault diagnostic indicator and does not show the current relay status. The 3UG4513 monitoring relay is suitable for line frequencies of 50/60 Hz.

Phase failure and undervoltage

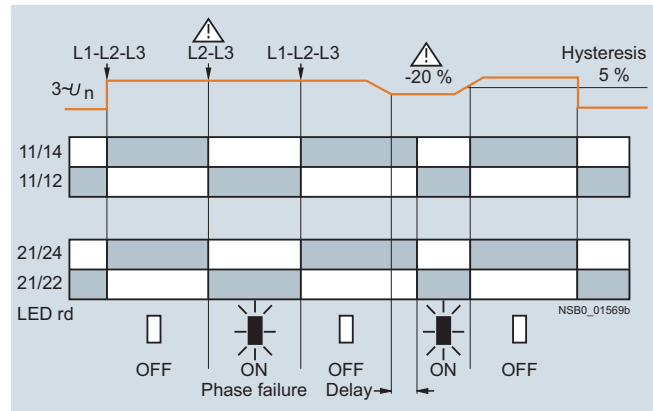

Wrong phase sequence

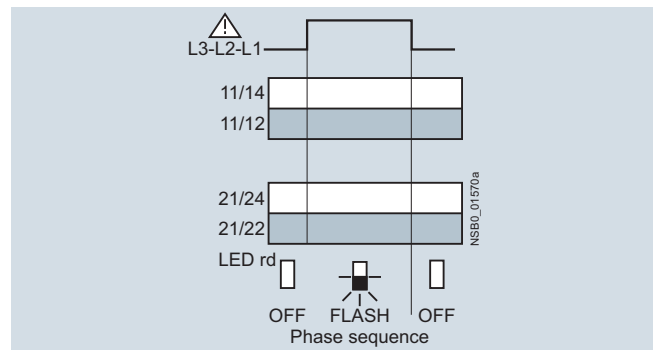

# 3UG45, 3UG46 Monitoring Relays for Stand-Alone Installation

## Line monitoring

### 3UG4614 monitoring relays

The 3UG4614 line monitoring relay has a wide voltage range input and an internal power supply. The device is equipped with a display and is parameterized using three buttons. The unit monitors three-phase networks with regard to phase asymmetry from 5 to 20%, phase failure, undervoltage and phase sequence. The hysteresis is adjustable from 1 to 20 V. In addition the device has a response delay and ON-delay from 0 to 20 s in each case. The integrated response delay time responds to phase asymmetry and undervoltage. If the direction is incorrect, the device switches off immediately. Thanks to a special measuring method, a phase failure is reliably detected in spite of the wide voltage range from 160 to 690 V and feedback through the load of up to 80%.

The 3UG4614 monitoring relay can be operated on the basis of either the open-circuit or closed-circuit principle and with Manual or Auto RESET.

With the closed-circuit principle selected

Wrong phase sequence

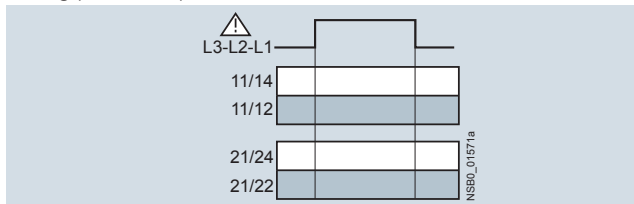

Phase failure

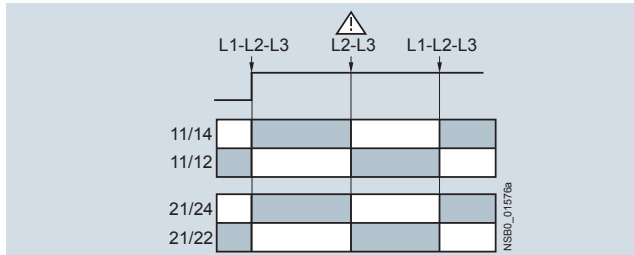

Undervoltage

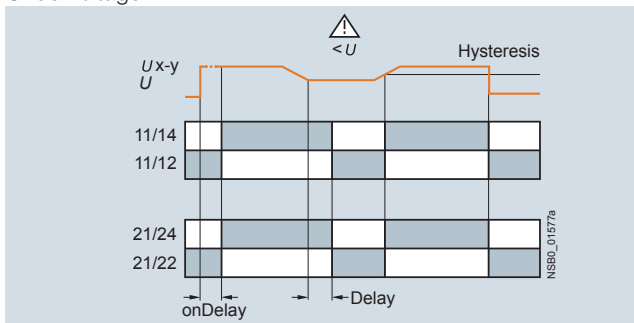

Unbalance

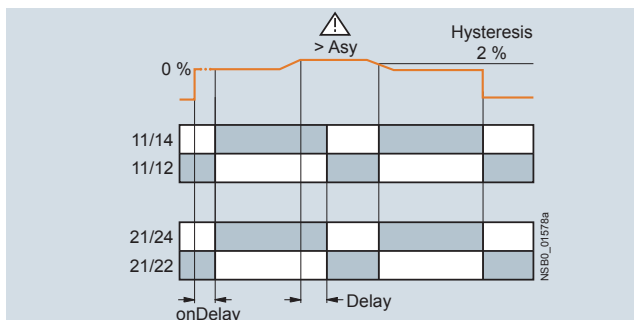

### 3UG4615/3UG4616 monitoring relays

The 3UG4615/3UG4616 line monitoring relay has a wide voltage range input and an internal power supply. The device is equipped with a display and is parameterized using three buttons. The 3UG4615 device monitors three-phase networks with regard to phase failure, undervoltage, overvoltage and phase sequence. The 3UG4616 monitoring relay monitors the neutral conductor as well. The hysteresis is adjustable from 1 to 20 V. In addition the device has two separately adjustable delay times for overvoltage and undervoltage from 0 to 20 s in each case. If the direction of rotation is incorrect, the device switches off immediately. Thanks to a special measuring method, a phase failure is reliably detected in spite of the wide voltage range from 160 to 690 V and feedback through the load of up to 80%.

The 3UG4615/3UG4616 monitoring relay can be operated on the basis of either the open-circuit or closed-circuit principle and with Manual or Auto RESET.

With the closed-circuit principle selected

Wrong phase sequence

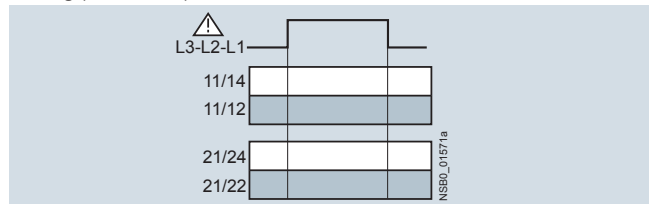

Phase failure

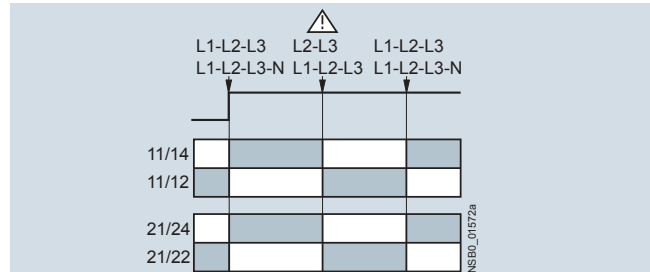

Undervoltage

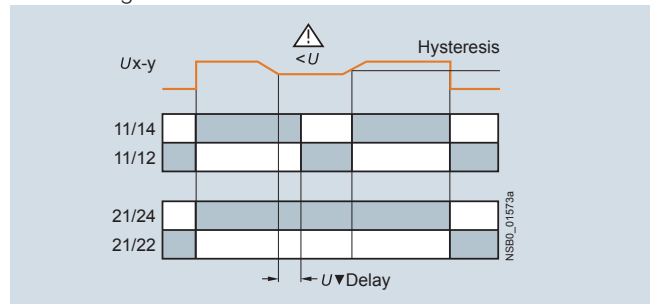

Overvoltage

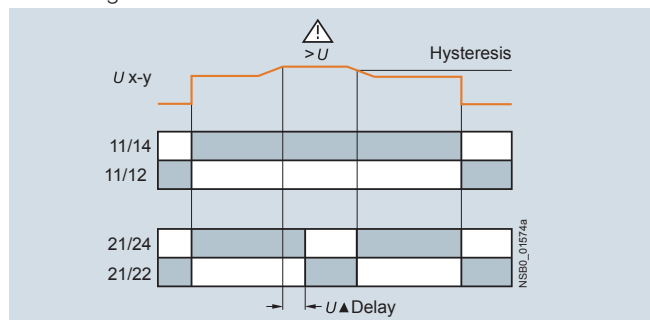

# 3UG45, 3UG46 Monitoring Relays for Stand-Alone Installation

## Line monitoring

### 3UG4617/3UG4618 monitoring relays

The 3UG4617/3UG4618 line monitoring relay has an internal power supply and can automatically correct a wrong direction of rotation. Thanks to a special measuring method, a phase failure is reliably detected in spite of the wide voltage range from 160 to 690 V AC and feedback through the load of up to 80%. The device is equipped with a display and is parameterized using three buttons. The 3UG4617 line monitoring relay unit monitors three-phase networks with regard to phase sequence, phase failure, phase unbalance, undervoltage and overvoltage. The 3UG4618 monitoring relay monitors the neutral conductor as well. The hysteresis is adjustable from 1 to 20 V. In addition the device has delay times from 0 to 20 s in each case for overvoltage, undervoltage, phase failure and phase unbalance. The 3UG4617/3UG4618 monitoring relay can be operated on the basis of either the open-circuit or closed-circuit principle and with Manual or Auto RESET.

The one changeover contact is used for warning or disconnection in the event of power system faults (voltage, asymmetry), the other responds only to a wrong phase sequence. In conjunction with a contactor reversing assembly it is thus possible to change the direction automatically.

With the closed-circuit principle selected

#### Phase failure

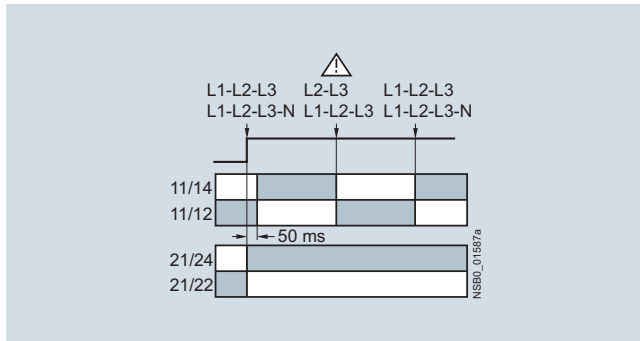

#### Undervoltage

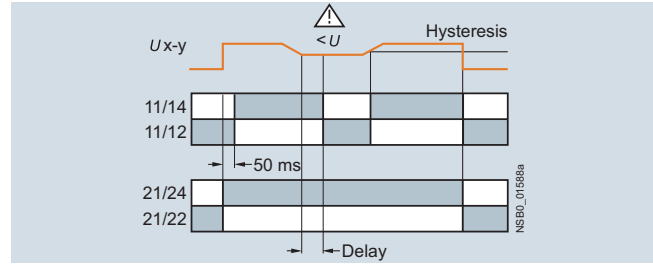

#### Overvoltage

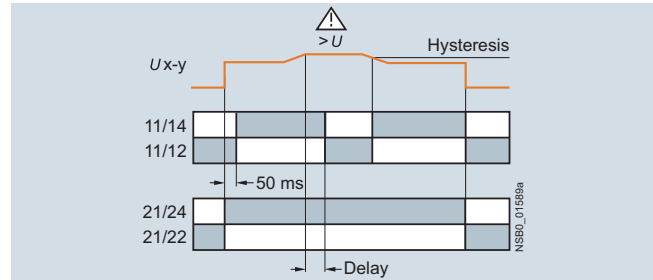

#### Unbalance

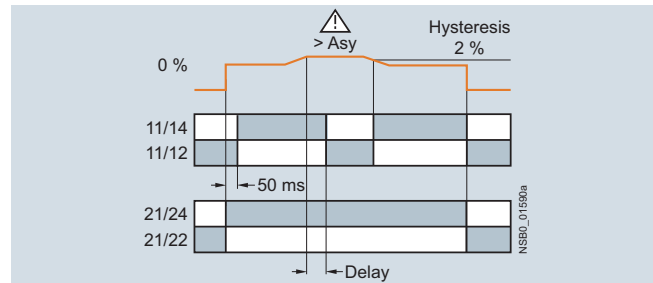

Type	3UG4511 ... 3UG4513, 3UG4614 ... 3UG4618	
<b>General data</b>		
Rated insulation voltage $U_i$	V	690
Pollution degree 3 Overvoltage category III acc. to VDE 0110		
Rated impulse withstand voltage $U_{imp}$	kV	6
<b>Control circuit</b>		
Load capacity of the output relay		
• Thermal current $I_{th}$	A	5
Rated operational current $I_e$ at		
• AC-15/24 ... 400 V	A	3
• DC-13/24 V	A	1
• DC-13/125 V	A	0.2
• DC-13/250 V	A	0.1
Minimum contact load at 17 V DC	mA	5
Electrical endurance AC-15	Million operating cycles	0.1
Mechanical endurance	Million operating cycles	10

**Selection and ordering data**

PU (UNIT, SET, M) = 1  
PKG\* = 1 UNIT



3UG4511-1AP20    3UG4615-1CR20    3UG4616-1CR20    3UG4617-1CR20    3UG4618-1CR20    3UG4511-2BP20    3UG4512-2BR20

Adjustable hysteresis	Under-voltage detection	Over-voltage detection	Stabilization time adjustable stDEL	Tripping delay time adjustable Del	Version of auxiliary contacts	Measurable line voltage <sup>1)</sup>	SD	Screw terminals	SD	Spring-type terminals	
			s	s	CO contact	V	d	Article No.	Price per PU	Article No.	Price per PU

<b>Monitoring of phase sequence</b>											
Auto RESET											
--	--	--	--	--	1	160 ... 260 AC	2	3UG4511-1AN20	2	3UG4511-2AN20	
					2		2	3UG4511-1BN20	2	3UG4511-2BN20	
					1	320 ... 500 AC	2	3UG4511-1AP20	2	3UG4511-2AP20	
					2		2	3UG4511-1BP20	2	3UG4511-2BP20	
					1	420 ... 690 AC	2	3UG4511-1AQ20	5	3UG4511-2AQ20	
					2		2	3UG4511-1BQ20	5	3UG4511-2BQ20	
<b>Monitoring of phase sequence, phase failure and phase unbalance</b>											
Auto RESET, closed-circuit principle, unbalance threshold permanently 10%											
--	--	--	--	--	1	160 ... 690 AC	2	3UG4512-1AR20	2	3UG4512-2AR20	
					2		2	3UG4512-1BR20	2	3UG4512-2BR20	
<b>Monitoring of phase sequence, phase failure, unbalance and undervoltage</b>											
Analogically adjustable, Auto RESET, closed-circuit principle, asymmetry and undervoltage threshold permanently 20%											
5% of set value	✓	--	--	0.1 ... 20	2	160 ... 690 AC	2	3UG4513-1BR20	2	3UG4513-2BR20	
Digitally adjustable, Auto RESET or Manual RESET, open-circuit or closed-circuit principle, asymmetry threshold 0 or 5 ... 20%											
adjustable 1 ... 20 V	✓	--	--	0.1 ... 20	0.1 ... 20	160 ... 690 AC	2	3UG4614-1BR20	2	3UG4614-2BR20	
<b>Monitoring of phase sequence, phase failure, overvoltage and undervoltage</b>											
Digitally adjustable, Auto RESET or Manual RESET, open-circuit or closed-circuit principle											
adjustable 1 ... 20 V	✓	✓	--	0.1 ... 20 <sup>2)</sup>	2 <sup>2)</sup>	160 ... 690 AC	2	3UG4615-1CR20	2	3UG4615-2CR20	
<b>Monitoring of phase sequence, phase and N conductor failure, overvoltage and undervoltage</b>											
Digitally adjustable, Auto RESET or Manual RESET, open-circuit or closed-circuit principle											
adjustable 1 ... 20 V	✓	✓	--	0.1 ... 20 <sup>2)</sup>	2 <sup>2)</sup>	90... 400 AC against N	2	3UG4616-1CR20	2	3UG4616-2CR20	
<b>Automatic correction of the direction of rotation in case of wrong phase sequence, phase failure, unbalance, overvoltage and undervoltage</b>											
Digitally adjustable, Auto RESET or Manual RESET, open-circuit or closed-circuit principle, asymmetry threshold 0 or 5 ... 20%											
adjustable 1 ... 20 V	✓	✓	--	0.1 ... 20	2 <sup>3)</sup>	160 ... 690 AC	2	3UG4617-1CR20	2	3UG4617-2CR20	
<b>Automatic correction of the direction of rotation in case of wrong phase sequence, phase and N conductor failure, phase unbalance, overvoltage and undervoltage</b>											
Digitally adjustable, Auto RESET or Manual RESET, open-circuit or closed-circuit principle, asymmetry threshold 0 or 5 ... 20%											
adjustable 1 ... 20 V	✓	✓	--	0.1 ... 20	2 <sup>3)</sup>	90 ... 400 AC against N	2	3UG4618-1CR20	2	3UG4618-2CR20	

✓ Function available  
-- Function not available

<sup>1)</sup> Absolute limit values.

<sup>2)</sup> 1 CO contact each and one tripping delay time each for  $U_{min}$  and  $U_{max}$ .

<sup>3)</sup> 1 CO contact each for power system fault and phase sequence correction.

For accessories, see page 11/96



## Overview



SIRIUS 3UG4631 monitoring relay

The relays monitor single-phase AC voltages (rms value) and DC voltages against the set threshold value for overshoot and undershoot. The devices differ with regard to their power supply (internal or external).

## Benefits

- Versions with wide voltage supply range
- Variably adjustable to overshoot, undershoot or range monitoring
- Freely configurable delay times and RESET response
- Width 22.5 mm
- Display of ACTUAL value and status messages
- All versions with removable terminals
- All versions with screw or spring-type terminals

## Application

- Protection of a plant against destruction due to overvoltage
- Switch-on of a plant at a defined voltage and higher
- Protection from undervoltage due to overloaded control supply voltages, particularly with battery power
- Threshold switch for analog signals from 0.1 to 10 V

## Technical specifications

### 3UG4631/3UG4632 monitoring relays

The 3UG4631/3UG4632 voltage monitoring relay is supplied with an auxiliary voltage of 24 V AC/DC or 24 to 240 V AC/DC and performs overshoot, undershoot or range monitoring of the voltage depending on parameterization. The device is equipped with a display and is parameterized using three buttons.

The measuring range extends from 0.1 to 60 V or 10 to 600 V AC/DC. The threshold values for overshoot or undershoot can be freely configured within this range. If one of these threshold values is reached, the output relay responds according to the set principle of operation as soon as the delay time has elapsed. This delay time  $U_{Del}$  can be set from 0.1 to 20 s. The hysteresis can be set from 0.1 to 30 V or 0.1 to 300 V. The device can be operated on the basis of either the open-circuit or closed-circuit principle and with Manual or Auto RESET. One output changeover contact is available as signaling contact.

With the closed-circuit principle selected

### Overvoltage

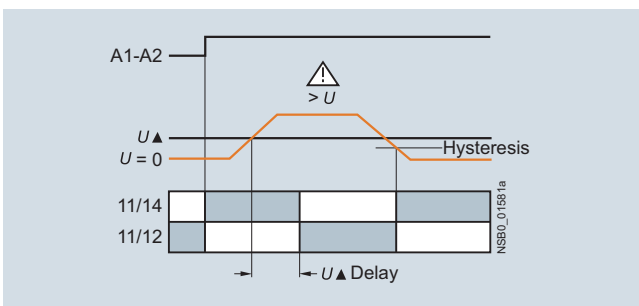

### Undervoltage

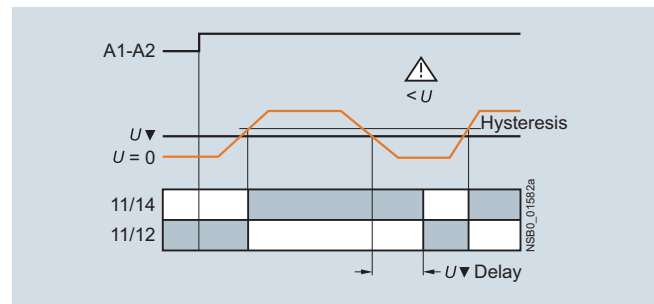

### Range monitoring

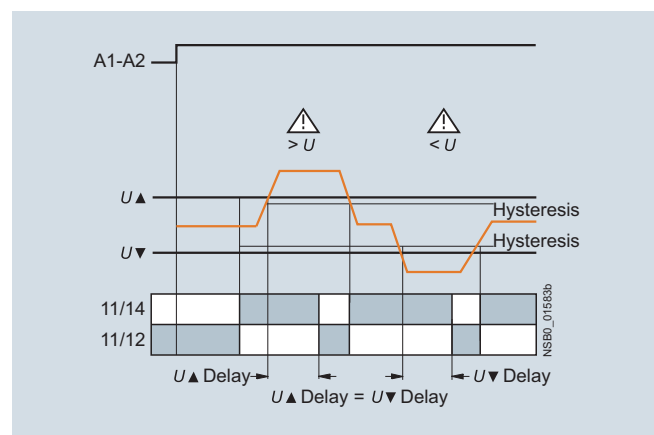



## Voltage monitoring

### 3UG4633 monitoring relay

The 3UG4633 voltage monitoring relay has an internal power supply and performs overshoot, undershoot or range monitoring of the voltage depending on parameterization. The device is equipped with a display and is parameterized using three buttons.

The operating and measuring range extends from 17 to 275 V AC/DC. The threshold values for overshoot or undershoot can be freely configured within this range. If one of these threshold values is reached, the output relay responds according to the set principle of operation as soon as the tripping delay time has elapsed. This delay time  $U_{Del}$  can also be adjusted, just like the ON-delay time  $on_{Del}$ , from 0.1 to 20 s.

The hysteresis is adjustable from 0.1 to 150 V. The device can be operated on the basis of either the open-circuit or closed-circuit principle and with Manual or Auto RESET. One output change-over contact is available as signaling contact.

With the closed-circuit principle selected

#### Overvoltage

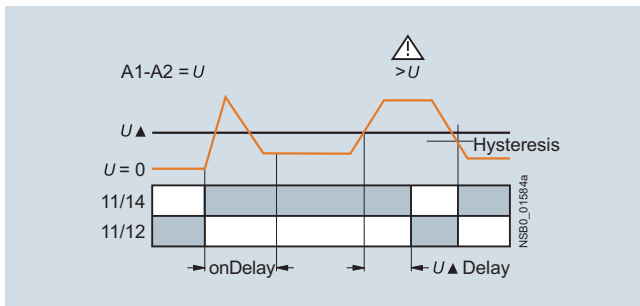

#### Undervoltage

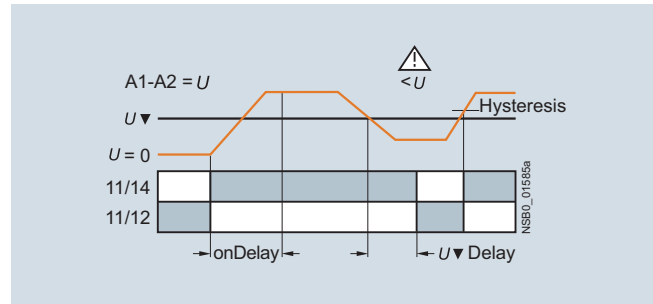

#### Range monitoring

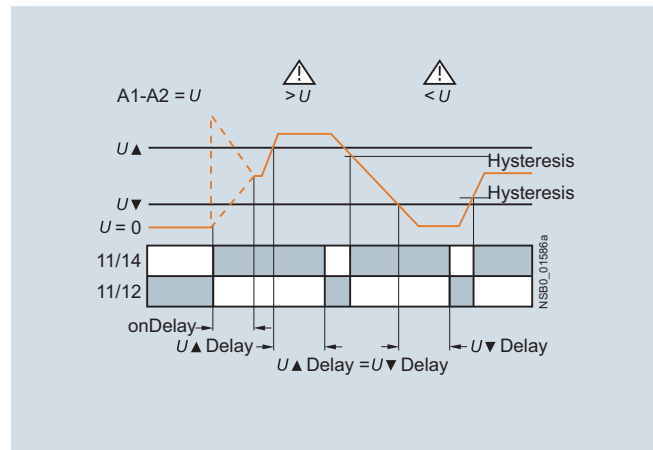

Type		3UG4631	3UG4632	3UG4633
<b>General data</b>				
<b>Rated insulation voltage <math>U_i</math></b>	V	690		
Pollution degree 3 Overvoltage category III acc. to VDE 0110				
<b>Rated impulse withstand voltage <math>U_{imp}</math></b>	kV	6		
<b>Measuring circuit</b>				
<b>Permissible measuring range</b> single-phase AC/DC voltage	V	0.1 ... 68	10 ... 650	17 ... 275
<b>Measuring frequency</b>	Hz	40 ... 500		
<b>Setting range</b> single-phase voltage	V	0.1 ... 60	10 ... 600	17 ... 275
<b>Control circuit</b>				
<b>Load capacity of the output relay</b>				
• Thermal current $I_{th}$	A	5		
<b>Rated operational current <math>I_e</math> at</b>				
• AC-15/24 ... 400 V	A	3		
• DC-13/24 V	A	1		
• DC-13/125 V	A	0.2		
• DC-13/250 V	A	0.1		
<b>Minimum contact load</b> at 17 V DC	mA	5		

### Selection and ordering data

- Digitally adjustable, with illuminated LCD
- Auto or Manual RESET
- Open- or closed-circuit principle
- 1 CO contact



PU (UNIT, SET, M) = 1  
 PKG\* = 1 UNIT



3UG4631-1AA30



3UG4633-2AL30

Measuring range	Adjustable hysteresis	Rated control supply voltage $U_s$	SD	Screw terminals 	SD	Spring-type terminals 	
V	V	V	d	Article No.	Price per PU	Article No.	Price per PU
<b>Internal power supply without auxiliary voltage, separately adjustable ON-delay and tripping delay 0.1 ... 20 s</b>							
17 ... 275 AC/DC	0.1 ... 150	17 ... 275 AC/DC <sup>1)</sup>	2	<b>3UG4633-1AL30</b>	2	<b>3UG4633-2AL30</b>	
<b>Externally supplied with auxiliary voltage, tripping delay adjustable 0.1 ... 20 s</b>							
0.1 ... 60 AC/DC	0.1 ... 30	24 AC/DC	2	<b>3UG4631-1AA30</b>	2	<b>3UG4631-2AA30</b>	
10 ... 600 AC/DC	0.1 ... 300		2	<b>3UG4632-1AA30</b>	2	<b>3UG4632-2AA30</b>	
0.1 ... 60 AC/DC	0.1 ... 30	24 ... 240 AC/DC	2	<b>3UG4631-1AW30</b>	2	<b>3UG4631-2AW30</b>	
10 ... 600 AC/DC	0.1 ... 300		2	<b>3UG4632-1AW30</b>	2	<b>3UG4632-2AW30</b>	

<sup>1)</sup> Absolute limit values.

For accessories, see page 11/96

## Overview



SIRIUS 3UG4622 monitoring relay

The relays monitor single-phase AC currents (rms value) and DC currents against the set threshold value for overshoot and undershoot. They differ with regard to their measuring ranges and control supply voltage types.

## Benefits

- Versions with wide voltage supply range
- Variably adjustable to overshoot, undershoot or range monitoring
- Freely configurable delay times and RESET response
- Width 22.5 mm
- Display of ACTUAL value and status messages
- All versions with removable terminals
- All versions with screw or spring-type terminals

## Application

- Overcurrent and undercurrent monitoring
- Monitoring the functionality of electrical loads
- Open-circuit monitoring
- Threshold switch for analog signals from 4 to 20 mA

## Technical specifications

### 3UG4621/3UG4622 monitoring relays

The 3UG4621 or 3UG4622 current monitoring relay is supplied with an auxiliary voltage of 24 V AC/DC or 24 to 240 V AC/DC and performs overshoot, undershoot or range monitoring of the current depending on parameterization. The device is equipped with a display and is parameterized using three buttons.

The measuring range extends from 3 to 500 mA or 0.05 to 10 A. The rms value of the current is measured. The threshold values for overshoot or undershoot can be freely configured within this range. If one of these threshold values is reached, the output relay responds according to the set principle of operation as soon as the tripping delay time  $I_{Del}$  has elapsed. This time and the ON-delay time  $on_{Del}$  are adjustable from 0.1 to 20 s.

The hysteresis is adjustable from 0.1 to 250 mA or 0.01 to 5 A. The device can be operated with Manual or Auto RESET and on the basis of either the open-circuit or closed-circuit principle. You can decide here whether the output relay is to respond when the supply voltage  $U_s = ON$  is applied, or not until the lower measuring range limit of the measuring current ( $I > 3 \text{ mA}/50 \text{ mA}$ ) is reached. One output changeover contact is available as signaling contact.

With the closed-circuit principle selected upon application of the control supply voltage

### Current overshoot

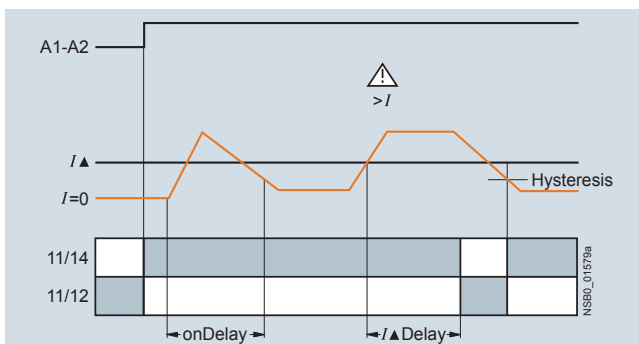

### Current undershoot

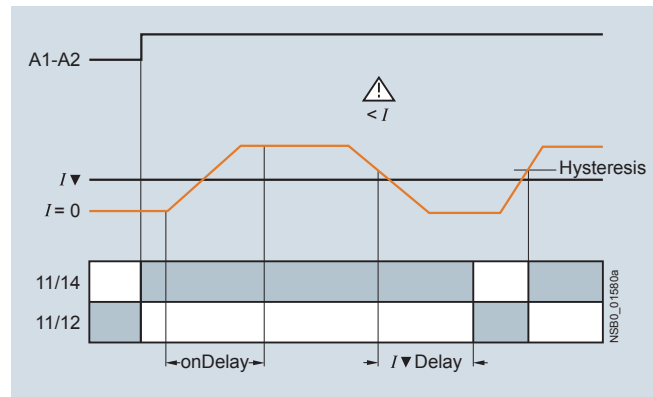

### Range monitoring

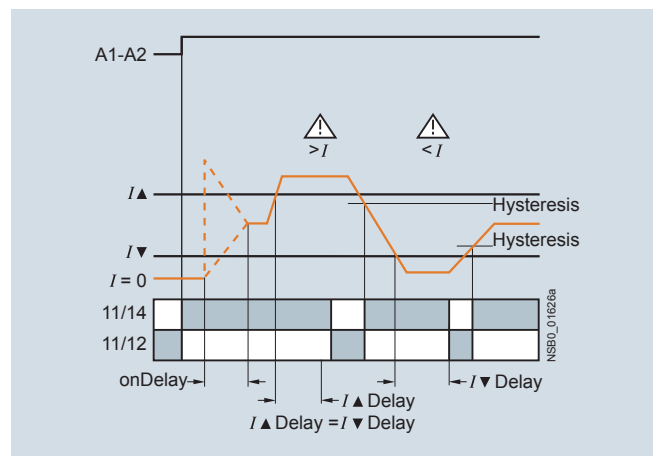

## Current monitoring

Type		3UG4621-AA	3UG4621-AW	3UG4622-AA	3UG4622-AW
<b>General data</b>					
<b>Rated insulation voltage <math>U_i</math></b>	V	690			
Pollution degree 3; overvoltage category III according to VDE 0110					
<b>Rated impulse withstand voltage <math>U_{imp}</math></b>	kV	6			
<b>Measuring circuit</b>					
<b>Measuring range for single-phase AC/DC current</b>	A	0.003 ... 0.6		0.05 ... 15	
<b>Measuring frequency</b>	Hz	40 ... 500			
<b>Setting range for single-phase current</b>	A	0.003 ... 0.5		0.05 ... 10	
<b>Load supply voltage</b>	V	24	Max. 300 <sup>1)</sup> Max. 500 <sup>2)</sup>	24	Max. 300 <sup>1)</sup> Max. 500 <sup>2)</sup>
<b>Control circuit</b>					
<b>Load capacity of the output relay</b>					
• Thermal current $I_{th}$	A	5			
<b>Rated operational current <math>I_e</math> at</b>					
• AC-15/24 ... 400 V	A	3			
• DC-13/24 V	A	1			
• DC-13/125 V	A	0.2			
• DC-13/250 V	A	0.1			
<b>Minimum contact load at 17 V DC</b>	mA	5			

1) With protective separation.

2) With simple separation.

### Selection and ordering data

- Digitally adjustable, with illuminated LCD
- Auto or Manual RESET
- Open- or closed-circuit principle
- 1 CO contact



PU (UNIT, SET, M) = 1  
PKG\* = 1 UNIT



3UG4621-1AA30



3UG4622-2AW30

Measuring range	Adjustable hysteresis	Rated control supply voltage $U_s$	SD	Screw terminals 	SD	Spring-type terminals 			
		V	d	Article No.	Price per PU	d	Article No.	Price per PU	
<b>Monitoring of undercurrent and overcurrent, start up delay and tripping delay times can be adjusted separately 0.1 ... 20 s</b>									
3 ... 500 mA AC/DC	0.1 ... 250 mA	24 AC/DC <sup>1)</sup>	2	<b>3UG4621-1AA30</b>	2	<b>3UG4621-2AA30</b>			
0.05 ... 10 A AC/DC	0.01 ... 5 A		2	<b>3UG4622-1AA30</b>	2	<b>3UG4622-2AA30</b>			
3 ... 500 mA AC/DC	0.1 ... 250 mA	24 ... 240 AC/DC <sup>2)</sup>	2	<b>3UG4621-1AW30</b>	2	<b>3UG4621-2AW30</b>			
0.05 ... 10 A AC/DC	0.01 ... 5 A		2	<b>3UG4622-1AW30</b>	2	<b>3UG4622-2AW30</b>			

1) No electrical separation. Load supply voltage 24 V.

2) Electrical separation between control circuit and measuring circuit. Load supply voltage for protective separation max. 300 V, for simple separation max. 500 V.

For accessories, see page 11/96

With AC currents  $I > 10$  A it is possible to use 4NC current transformers as an accessory.

## Overview



SIRIUS 3UG4641 monitoring relay

The 3UG4641 power factor and active current monitoring device enables the load monitoring of motors.

Whereas power factor (p.f.) monitoring is used above all for monitoring no-load operation, the active current monitoring option can be used to observe and evaluate the load factor over the entire torque range.

## Technical specifications

### 3UG4641 monitoring relay

The 3UG4641 monitoring relay is self-powered and serves the single-phase monitoring of the power factor or performs overshoot, undershoot or range monitoring of the active current depending on how it is parameterized. The load to be monitored is connected upstream of the IN terminal. The load current flows through the terminals IN and Ly/N. The setting range for the power factor is 0.1 to 0.99 and for the active current  $I_{res}$  it is 0.2 to 10 A. If the control supply voltage is switched on and no load current flows, the display will show  $I < 0.2$  and a symbol for overrange, underrange or range monitoring. If the motor is now switched on and the current exceeds 0.2 A, the set ON-delay time begins. During this time, if the set limit values are undershot or exceeded, this does not lead to a relay reaction of the changeover contact. If the operational flowing active current and/or the power factor value falls below or exceeds the respective set threshold value, the spike delay begins. When this time has expired, the relay changes its switch position. The relevant measured variables for overshooting and undershooting in the display flash. If monitoring for active current undershoot is switched off ( $I_{res} \nabla = \text{OFF}$ ), and if the load current undershoots the lower measuring range threshold (0.2 A), the CO contacts remain unchanged. If a threshold value is set for the monitoring of active current undershooting, then undershooting of the measuring range threshold (0.2 A) will result in a response of the CO contacts.

The relay operates either according to the open-circuit or closed-circuit principle. If the device is set to Auto RESET (Memory = No), depending on the set principle of operation, the switching relay returns to its initial state and the flashing ends when the hysteresis threshold is reached.

If Manual RESET is selected in the menu (Memory = Yes), the switching relay remains in its current switching state and the current measured value and the symbol for undershooting and overshooting continues to flash, even when the measured variable reaches a permissible value again. This stored fault status can be reset by simultaneously pressing the UP▲ and DOWN▼ keys for 2 seconds, or by switching the supply voltage off and back on again.

## Benefits

- Can be used worldwide thanks to wide voltage range from 90 to 690 V (absolute limit values)
- Monitoring of even small single-phase motors with a no-load supply current below 0.5 A
- Simple determination of threshold values by the direct collection of measured variables on motor loading
- Range monitoring and active current measurement enable detection of cable breaks between control cabinets and motors, as well as phase failures
- Power factor (p.f.) or  $I_{res}$  (active current) can be selected as the measurement principle
- Width 22.5 mm
- All versions with removable terminals

## Application

- No-load monitoring and load shedding, such as in the event of a V-belt tear
- Underload monitoring in the low-end performance range, e.g. in the event of pump no-load operation
- Monitoring of overload, e.g. due to a dirty filter system
- Simple power factor monitoring in power systems for control of compensation equipment
- Broken cable between control cabinet and motor

### With the closed-circuit principle selected

Response in the event of undershooting the measuring range limit

- With activated monitoring of  $I_{res} \nabla$

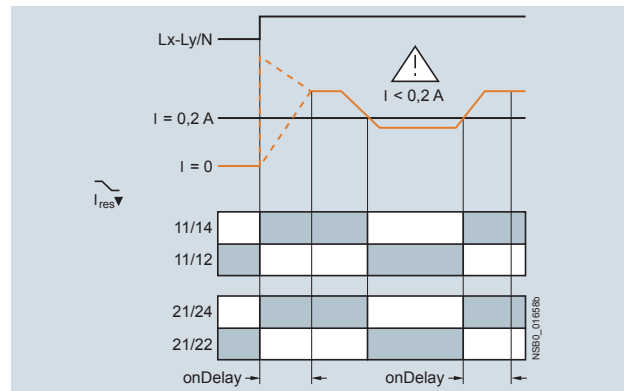

- With deactivated monitoring of active current undershooting

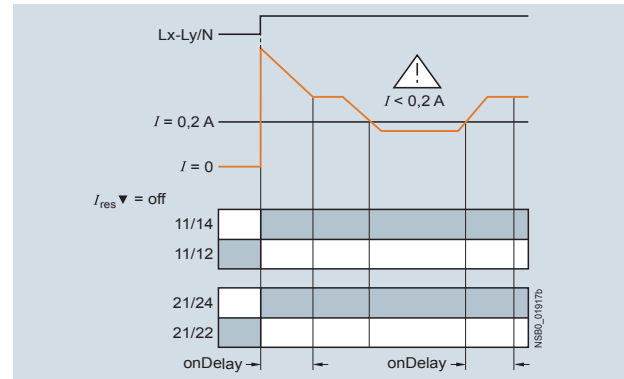

Overshooting of active current

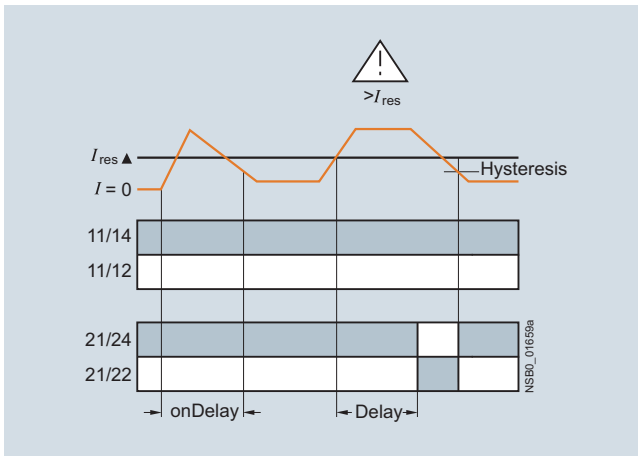

Overshooting of power factor

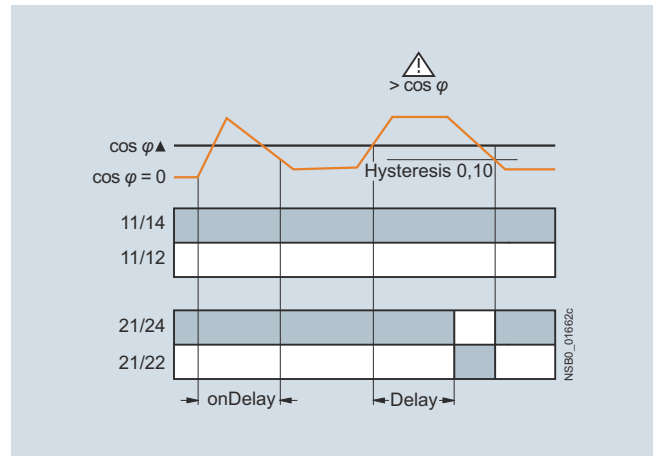

Undershooting of active current

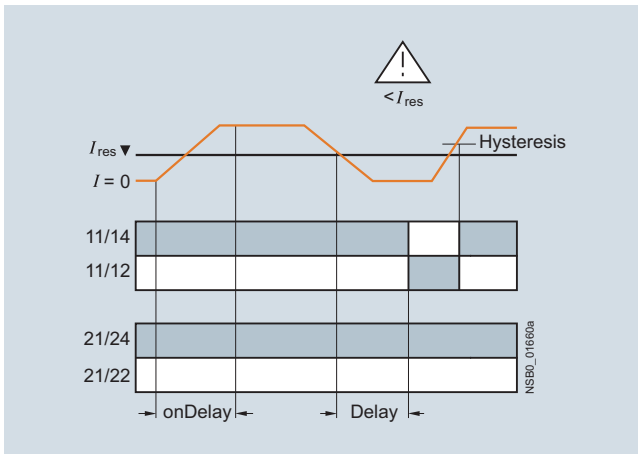

Undershooting of power factor

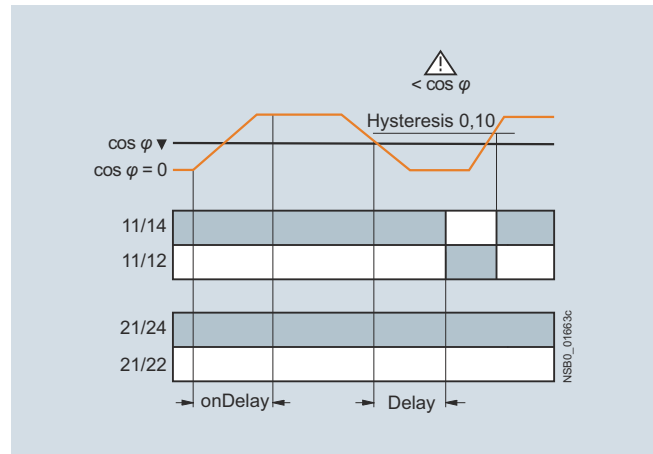

Range monitoring of active current

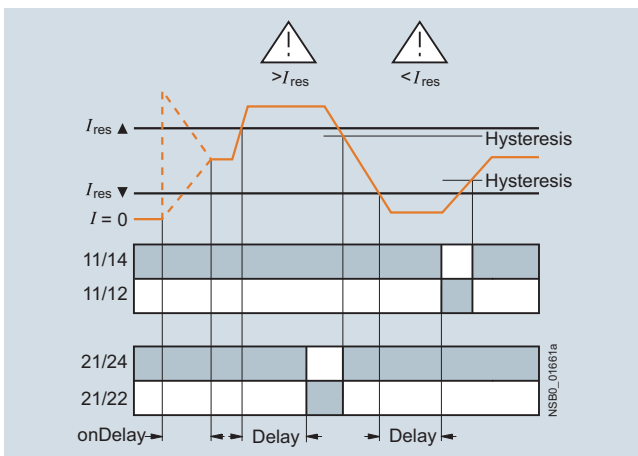

Range monitoring of power factor

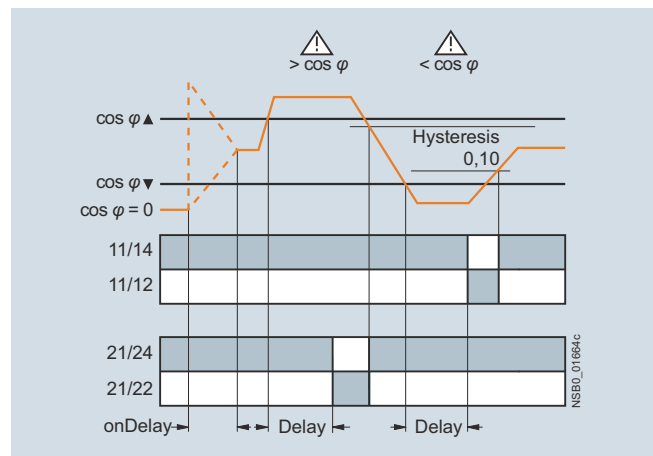

# 3UG45, 3UG46 Monitoring Relays for Stand-Alone Installation

## Power factor and active current monitoring

Type	3UG4641	
<b>General data</b>		
<b>Rated insulation voltage <math>U_i</math></b> Pollution degree 3 Overvoltage category III acc. to VDE 0110	V	690
<b>Rated impulse withstand voltage <math>U_{imp}</math></b>	kV	6
<b>Control circuit</b>		
<b>Number of CO contacts for auxiliary contacts</b>		2
<b>Load capacity of the output relay</b>		
• Thermal current $I_{th}$	A	5
<b>Rated operational current <math>I_e</math> at</b>		
• AC-15/24 ... 400 V	A	3
• DC-13/24 V	A	1
• DC-13/125 V	A	0.2
• DC-13/250 V	A	0.1
<b>Minimum contact load at 17 V DC</b>	mA	5

### Selection and ordering data

- For monitoring the power factor and the active current  $I_{res}$  (p.f.  $\times I$ )
- Suitable for single- and three-phase currents
- Digitally adjustable, with illuminated LCD
- Overshoot, undershoot or range monitoring adjustable
- Upper and lower threshold value can be adjusted separately
- Permanent display of actual value and tripping state
- 1 changeover contact each for undershoot/overshoot

PU (UNIT, SET, M) = 1  
 PKG\* = 1 UNIT

Measuring range		Adjustable hysteresis		ON-delay time adjustable onDel	Tripping delay time adjustable	Rated control supply voltage $U_s$ <sup>1)</sup>	SD	Screw terminals	SD	Spring-type terminals		
For power factor	For active current $I_{res}$	For power factor	For active current $I_{res}$		$I \blacktriangle Del / I \blacktriangledown Del, \varphi \blacktriangle Del / \varphi \blacktriangledown Del$	50/60 Hz AC						
P.f.	A	P.f.	A	s	s	V	d	Article No.	Price per PU	d	Article No.	Price per PU
0.10 ... 0.99	0.2 ... 10.0	0.1	0.1 ... 2.0	0 ... 99	0.1 ... 20.0	90 ... 690	2	<b>3UG4641-1CS20</b>		2	<b>3UG4641-2CS20</b>	

<sup>1)</sup> Absolute limit values.

For accessories, see page 11/96

With AC active currents  $I_{res} > 10$  A it is possible to use 4NC current transformers as an accessory, see Catalog LV 10.

## Overview



SIRIUS 3UG4625 monitoring relay

The 3UG4625 residual-current monitoring relays are used in conjunction with the 3UL23 residual-current transformers for monitoring plants in which higher residual currents are increasingly expected due to ambient conditions. Monitoring encompasses pure AC residual currents or AC residual currents with a pulsating DC fault current component (transformer type A in accordance with DIN VDE 0100-530/IEC TR 60755).

## Technical specifications

### 3UG4625 monitoring relays

The main conductor, and any neutral conductor to which a load is connected, are routed through the opening of the annular ring core of a residual-current transformer. A secondary winding is placed around this annular strip-wound core to which the monitoring relay is connected.

If operation of a plant is fault-free, the sum of the inflowing and outward currents equals zero. No current is then induced in the secondary winding of the residual-current transformer.

However, if an insulation fault occurs downstream of the residual current operated circuit breaker, the sum of the inflowing currents is greater than that of the outward currents. The differential current – i.e. the residual current – induces a secondary current in the secondary winding of the transformer. This current is evaluated in the monitoring relay and is used on the one hand to display the actual residual current and on the other, to switch the relay if the set warning or tripping threshold is overshoot.

If the measured residual current exceeds the set warning value, the associated changeover contact instantly changes the switching state and an indication appears on the display.

If the measured residual current exceeds the set tripping value, the set delay time begins and the associated relay symbol flashes. On expiry of this time, the associated changeover contact changes the switching state.

#### ON-delay time for motor start

To be able to start a drive when a residual current is detected, the output relays switch to the OK state for an adjustable ON-delay time depending on the selected open-circuit principle or closed-circuit principle.

The changeover contacts do not react if the set threshold values are overshoot during this period.

## Benefits

- Worldwide use thanks to wide voltage range from 24 to 240 V AC/DC
- High measuring accuracy of  $\pm 7.5\%$
- Permanent self-monitoring
- Variable threshold values for warning and disconnection
- Freely configurable delay times and RESET response
- Permanent display of the actual value and fault diagnostics via the display
- High level of flexibility and space saving through installation of the transformer inside or outside the control cabinet
- Width 22.5 mm
- All versions with removable terminals
- All versions with screw or spring-type terminals

## Application

Monitoring of plants in which residual currents can occur, e.g. due to dust deposits or moisture, porous cables and leads, or capacitive residual currents.

With the closed-circuit principle selected

Residual current monitoring with Auto RESET (Memory = no)

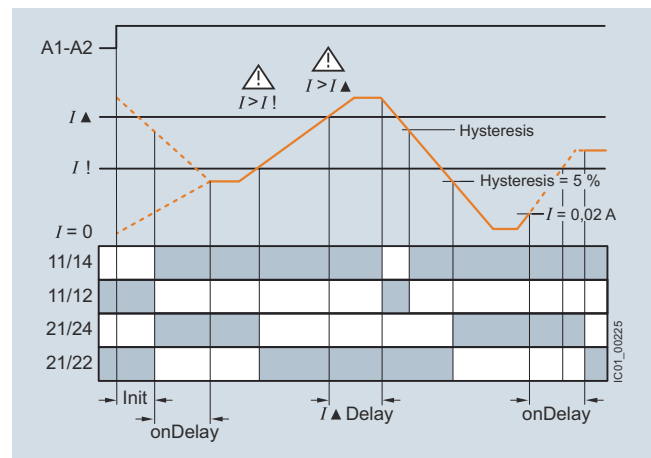

If the device is set to Auto RESET, the relay switches back to the OK state for the tripping value once the value falls below the set hysteresis threshold and the display stops flashing.

The associated relay changes its switching state if the value falls below the fixed hysteresis value of 5% of the set warning value.

Any overshoots are therefore not stored.



# 3UG45, 3UG46 Monitoring Relays for Stand-Alone Installation

## Residual-current monitoring relays

Residual current monitoring with Manual RESET (Memory = yes)

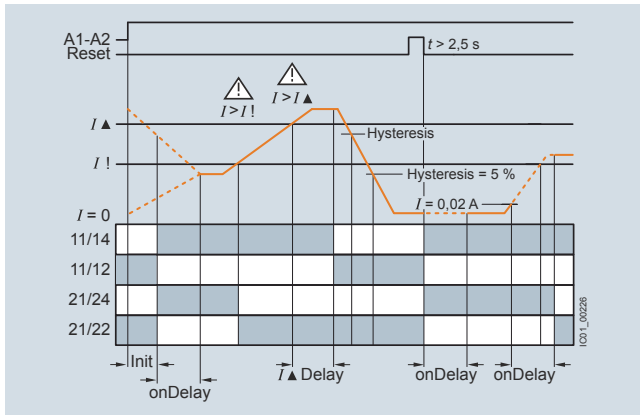

If Manual RESET is selected in the menu, the output relays remain in their current switching state and the current measured value and the symbol for overshooting continues to flash, even when the measured residual current returns to a permissible value. This stored fault status can be reset by simultaneously pressing the UP▲ and DOWN▼ keys for > 2 seconds, or by switching the supply voltage off and back on again.

**Note:**

Do not ground the neutral conductor downstream of the residual-current transformer as otherwise residual current monitoring functions can no longer be ensured.

<b>Type</b>	<b>3UG4625-1CW30, 3UG4625-2CW30</b>	
<b>General data</b>		
<b>Insulation voltage for overvoltage category III to IEC 60664 for pollution degree 3, rated value</b>	V	300
<b>Impulse withstand voltage, rated value <math>U_{imp}</math></b>	kV	4
<b>Control circuit</b>		
<b>Number of CO contacts for auxiliary contacts</b>		2
<b>Thermal current of the non-solid-state contact blocks, maximum</b>	A	5
<b>Current carrying capacity of the output relay</b>		
• At AC-15 at 250 V at 50/60 Hz	A	3
• At DC-13		
- At 24 V	A	1
- At 125 V	A	0.2
- At 250 V	A	0.1
<b>Operational current at 17 V, minimum</b>	mA	5

**Selection and ordering data**

- For monitoring residual currents from 0.03 to 40 A, from 16 to 400 Hz
- For 3UL23 residual-current transformers with feed-through opening from 35 to 210 mm
- Permanent self-monitoring
- Certified in accordance with IEC 60947, functionality corresponds to IEC 62020
- Digitally adjustable, with illuminated LCD

- Permanent display of actual value and tripping state
- Separately adjustable limit value and warning threshold
- 1 changeover contact each for warning threshold and tripping threshold

PU (UNIT, SET, M) = 1  
PS\* = 1 unit



3UG4625-1CW30



3UG4625-2CW30

Measurable current	Adjustable response value current	Switching hysteresis	Adjustable ON-delay time	Control supply voltage			SD	Screw terminals		SD	Spring-type terminals	
				For AC at 50 Hz rated value	For AC at 60 Hz rated value	At DC rated value		Article No.	Price per PU		Article No.	Price per PU
A	A	%	s	V	V	V	d			d		
0.01 ... 43	0.03 ... 40	0 ... 50	0 ... 20	24 ... 240	24 ... 240	24 ... 240	2	<b>3UG4625-1CW30</b>		2	<b>3UG4625-2CW30</b>	

For accessories, see page 11/96

For 3UL23 residual-current transformers, see page 11/82.

Overview



SIRIUS 3UL23 residual-current transformer

The 3UL23 residual-current transformers detect residual currents in machines and plants. They are suitable for pure AC residual currents or AC residual currents with a pulsating DC fault current component (transformer type A in accordance with DIN VDE 0100-530/IEC TR 60755).

Together with the 3UG4625, 3UG4825 residual-current monitoring relays for IO-Link or the SIMOCODE 3UF motor management and control device they enable residual-current and ground-fault monitoring.

The 3UL2302-1A and 3UL2303-1A residual-current transformers with a feed-through opening from 35 to 55 mm can be mounted in conjunction with the 3UL2900 accessories on a TH 35 standard mounting rail according to IEC 60715.

Selection and ordering data

Diameter of the bushing opening	Connectable cross-section of the connecting terminal	SD	Screw terminals	PU (UNIT, SET, M)	PS*
mm	mm <sup>2</sup>	d	Article No.	Price per PU	
<b>Residual-current transformers (essential accessories for 3UG4625, 3UG4825)</b>					
35	2.5	2	<b>3UL2302-1A</b>	1	1 unit
55	2.5	2	<b>3UL2303-1A</b>	1	1 unit
80	2.5	2	<b>3UL2304-1A</b>	1	1 unit
110	2.5	2	<b>3UL2305-1A</b>	1	1 unit
140	2.5	2	<b>3UL2306-1A</b>	1	1 unit
210	4	2	<b>3UL2307-1A</b>	1	1 unit

Accessories

Version	SD	Article No.	Price per PU	PU (UNIT, SET, M)	PS*
	d				
 <b>Adapters</b> For mounting onto standard rail for 3UL23 to diameter 55 mm	2	<b>3UL2900</b>		1	2 units

3UL2900

## Overview



SIRIUS 3UG458. insulation monitor

Insulation monitoring relays are used for monitoring the insulation resistance between ungrounded single or three-phase AC supplies and a protective conductor.

Ungrounded, i.e. isolated networks (IT networks) are always used where high demands are placed on the reliability of the power supply, e.g. emergency lighting systems. IT systems are supplied via an isolating transformer or by power supply sources such as batteries or a generator. While an initial insulation fault between a phase conductor and the ground effectively grounds the conductor, as a result no circuit has been closed, so it is possible to continue work in safety (single-fault safety). However, the fault must be rectified as quickly as possible before a second insulation fault occurs (e.g. according to DIN VDE 0100-410). For this purpose insulation monitoring relays are used, which constantly measure the resistance to ground of the phase conductor and the neutral conductor, reporting a fault immediately if insulation resistance falls below the set value so that either a controlled shutdown can be performed or the fault can be rectified without interrupting the power supply.

### Two device series

- 3UG4581 insulation monitoring relays for ungrounded AC networks
- 3UG4582 and 3UG4583 insulation monitoring relays for ungrounded DC and AC networks

## Benefits

- Devices for AC and DC systems
- All devices have a wide control supply voltage range
- Direct connection to networks with mains voltages of up to 690 V AC and 1 000 V DC by means of a voltage reducer module
- For AC supply systems: Frequency range 15 to 400 Hz
- Monitoring of broken conductors
- Monitoring of setting errors
- Safety in use thanks to integrated system test after startup
- Option of resetting and testing (by means of button on front or using control contact)
- New predictive measurement principle allows very fast response times

## Application

IT networks are used, for example:

- In emergency power supplies
- In safety lighting systems
- In industrial production facilities with high availability requirements (chemical industry, automobile manufacturing, printing plants)
- In shipping and railways
- For mobile generators (aircraft)
- For renewable energies, such as wind energy and photovoltaic power plants
- In the mining industry

## Technical specifications

### More information

For manuals, see  
 • <https://support.industry.siemens.com/cs/ww/en/view/54382552>  
 • <https://support.industry.siemens.com/cs/ww/en/view/54382528>

Type	3UG4581-1AW30	3UG4582-1AW30	3UG4583-1CW30
<b>General data</b>			
<b>Setting range for the setpoint response values</b>			
• 1 ... 100 kΩ	✓	✓	✓
• 2 ... 200 kΩ	--	--	✓
<b>Rated voltage of the network being monitored</b>			
• 0 ... 250 V AC	--	✓	--
• 0 ... 440 V AC	✓	--	✓
• 0 ... 690 V AC	--	--	✓ <sup>1)</sup>
• 0 ... 300 V DC	--	✓	--
• 0 ... 600 V DC	--	--	✓
• 0 ... 1 000 V DC	--	--	✓ <sup>1)</sup>
<b>Max. leakage capacitance of the system</b>			
• 10 μF	✓	✓	--
• 20 μF	--	--	✓
<b>Output contacts</b>			
• 1 CO	✓	✓	--
• 2 CO or 1 CO + 1 CO, adjustable	--	--	✓
<b>Number of limit values</b>			
• 1	✓	✓	--
• 1 or 2, adjustable	--	--	✓
<b>Principle of operation</b>	Closed-circuit principle	Closed-circuit principle	Open-circuit/closed-circuit principle, adjustable
<b>Rated control supply voltage</b>			
• 24 ... 240 V AC/DC	✓	✓	✓
<b>Rated frequency</b>			
• 15 ... 400 Hz	--	✓	✓
• 50/60 Hz	✓	--	--
<b>Auto or Manual RESET</b>	✓ Adjustable	✓ Adjustable	✓ Adjustable
<b>Remote RESET</b>	✓ Via control input	✓ Via control input	✓ Via control input
<b>Non-volatile error memory</b>	--	--	✓ Adjustable
<b>Broken wire detection</b>	--	--	✓ Adjustable
<b>Replacement for</b>			
Rated control supply voltage $U_s$	Voltage range of the network being monitored		
<b>3UG3081-1AK20</b> 110 ... 130/220 ... 240 V AC/DC	3 x 230/400 V AC	✓	--
<b>3UG3081-1AW30</b> 24 ... 240 V AC/DC	3 x 230/400 V AC	✓	--
<b>3UG3082-1AW30</b> 24 ... 240 V AC/DC	24 ... 240 V DC	--	✓

✓ Available  
 -- Not available

<sup>1)</sup> With voltage reducer module.

**Overview**

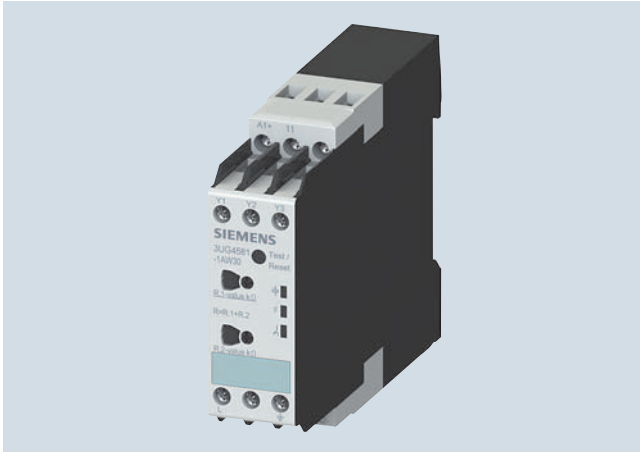

SIRIUS 3UG4581 insulation monitor

The 3UG4581 insulation monitoring relays are used to monitor insulation resistance according to IEC 61557-8 in ungrounded AC networks with rated voltages of up to 400 V.

These devices can monitor control circuits (single-phase) and main circuits (three-phase).

They measure insulation resistances between system cables and system ground. If the value falls below the threshold value, the output relays are switched to fault status.

In the case of 3UG4581 a higher-level DC measuring signal is used. The higher-level DC measuring signal and the resulting current are used to determine the value of the insulation resistance of the network which is to be measured.

**Technical specifications**



**3UG4581 monitoring relay**

With the closed-circuit principle selected

Insulation resistance monitoring without fault storage, with Auto RESET

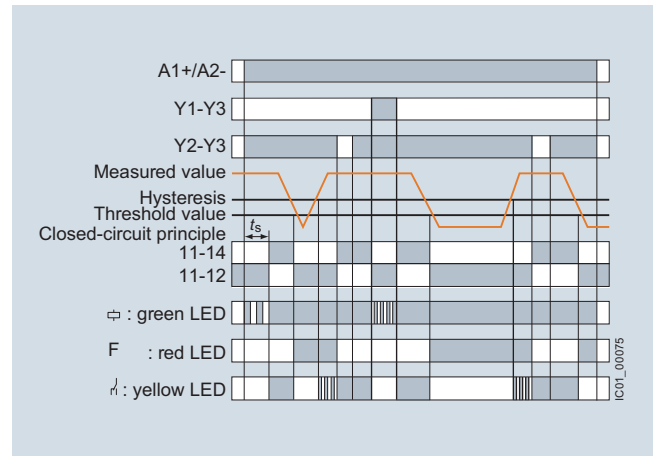
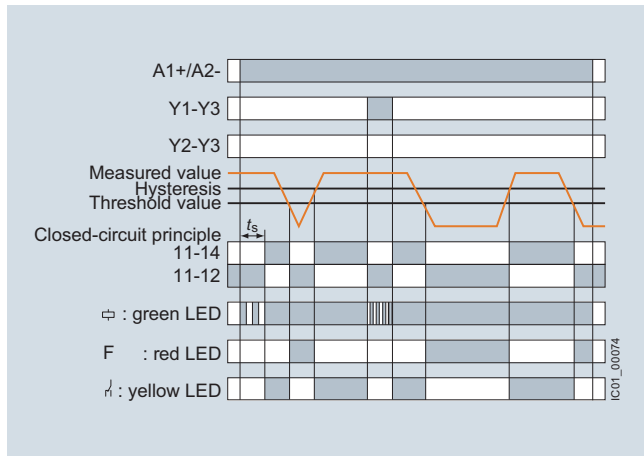
Insulation resistance monitoring with fault storage and Manual RESET

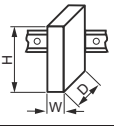

<b>Type</b>	<b>3UG4581</b>	
Dimensions (W x H x D)	mm	22.5 x 100 x 100
		
<b>Connection type</b>	 <b>Screw terminals</b>	
<ul style="list-style-type: none"> <li>Solid</li> <li>Finely stranded with end sleeve</li> <li>AWG cables, solid or stranded</li> </ul>	mm <sup>2</sup> mm <sup>2</sup> AWG	2 x (0.5 ... 4) 2 x (0.75 ... 2.5) 2 x (20 ... 14)
<b>General data</b>		
<b>Rated insulation voltage <math>U_i</math></b>	V	400 supply circuit/measuring circuit
Pollution degree 3		
Overvoltage category III acc. to IEC 60664		
<b>Rated impulse withstand voltage <math>U_{imp}</math></b>	kV	6
<b>Rated control supply voltage</b>	V	24 ... 240 AC/DC
<b>Rated frequency</b>	Hz	15 ... 400
<b>Measuring circuit</b>		
<b>Rated line voltage of the network being monitored</b>	V	0 ... 400
<b>Rated frequency of the network being monitored</b>	Hz	50 ... 60
<b>Setting range for insulation resistance</b>	k $\Omega$	1 ... 100
<b>Control circuit</b>		
<b>Load capacity of the output relay</b>		
<ul style="list-style-type: none"> <li>Thermal current <math>I_{th}</math></li> </ul>	A	4
<b>Rated operational current <math>I_e</math> at</b>		
<ul style="list-style-type: none"> <li>AC-15/24 ... 400 V</li> <li>DC-13/24 V</li> </ul>	A	3
	A	2
<b>Minimum contact load at 24 V DC</b>	mA	10

### Selection and ordering data

- Auto or Manual RESET
- Closed-circuit principle
- 1 CO contact
- Fault memory adjustable using control input (Y2-Y3)
- Reset by means of button on front or using control input (Y2-Y3)
- Test by means of button on front or using control input (Y1-Y3)

Rated line voltage $U_n$	Measuring range $U_e$	Rated control supply voltage $U_s$	System leakage capacitance	SD	Screw terminals 	PU (UNIT, SET, M)	PS*
V AC	k $\Omega$	V	$\mu$ F	d	Article No.	Price per PU	

### Insulation monitors for ungrounded AC networks

0 ... 400	1 ... 100	24 ... 240 AC/DC	Max. 10	5	<b>3UG4581-1AW30</b>		1	1 unit
-----------	-----------	------------------	---------	---	----------------------	--	---	--------



3UG4581-1AW30

For accessories, see page 11/96

# 3UG45, 3UG46 Monitoring Relays for Stand-Alone Installation

Insulation monitoring for ungrounded DC and AC networks

## Overview

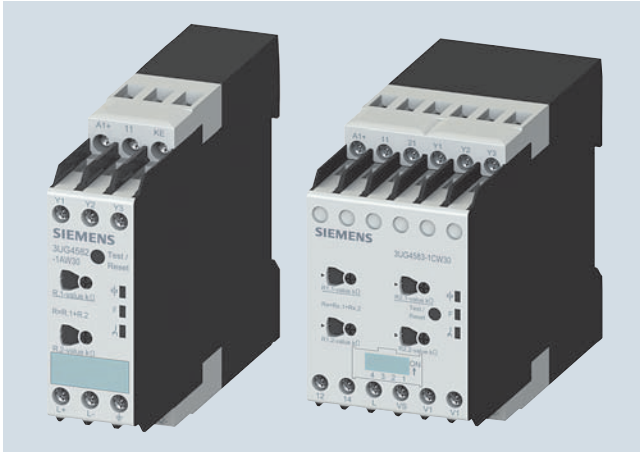

SIRIUS 3UG4582 and 3UG4583 insulation monitors

The 3UG4582 and 3UG4583 insulation monitoring relays are used to monitor insulation resistance in ungrounded IT AC or DC networks according to IEC 61557-8.

They measure insulation resistances between system cables and system ground. If the value falls below the threshold value, the output relays are switched to fault status. With these devices, which are suitable for both AC and DC networks, a pulsed test signal is fed into the network to be monitored and the isolation resistance is determined.

The pulsed test signal changes its form according to insulation resistance and network loss capacitance. The changed form is used to predict the changed insulation resistance.

If the predicted insulation resistance matches the insulation resistance calculated in the next measurement cycle, and is lower than the threshold value, the output relays are activated or deactivated, depending on the device configuration. This measurement principle is also suitable for identifying symmetrical insulation faults.

### 3UG4983 voltage reducer module

The 3UG4983 passive voltage reducer module can be used to allow the 3UG4583 insulation monitoring relay to be used for insulation monitoring of IT networks with rated voltages of up to 690 V AC and 1 000 V DC.

## Technical specifications

### 3UG4582 monitoring relays

With the closed-circuit principle selected

Insulation resistance monitoring without fault storage, with Auto RESET

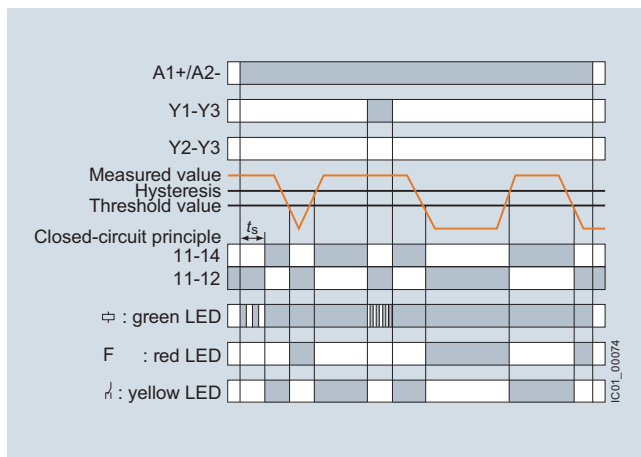

Insulation resistance monitoring with fault storage and Manual RESET

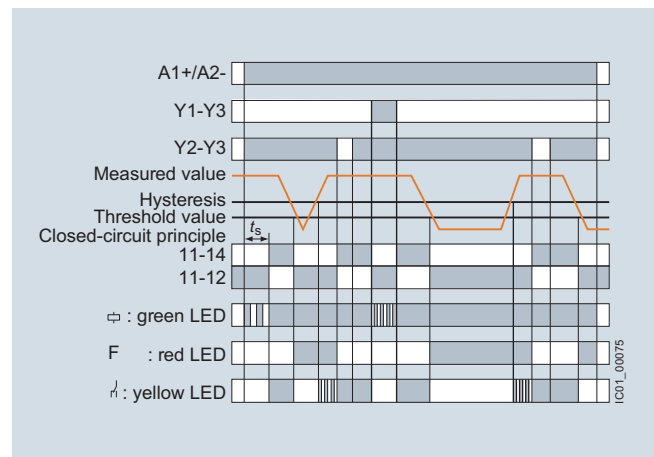

### 3UG4583 monitoring relays

With the closed-circuit principle selected

Insulation resistance monitoring without fault storage, with Auto RESET

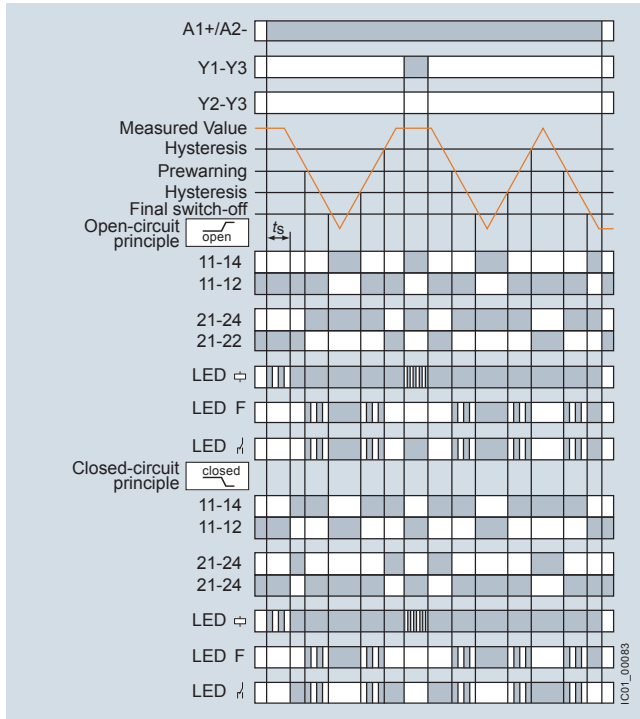

Insulation resistance monitoring with fault storage and Manual RESET

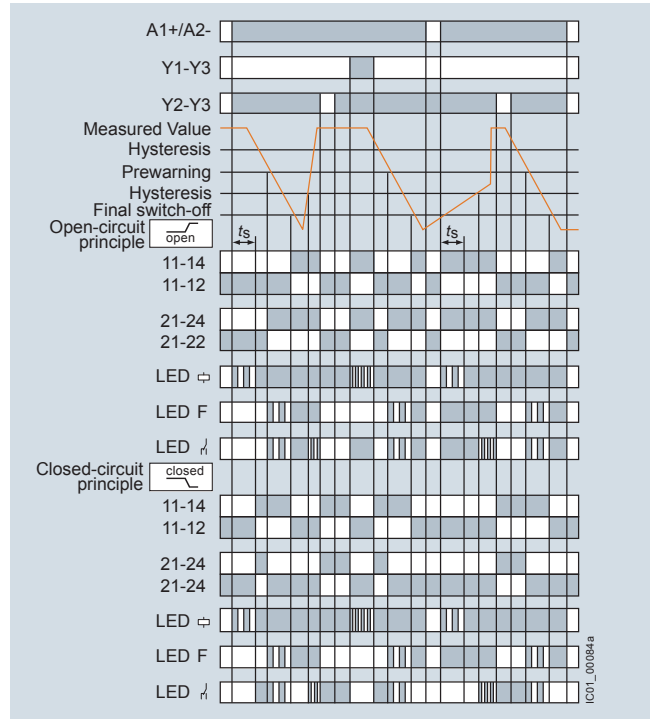

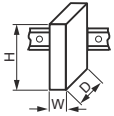
Type		3UG4582	3UG4583
Dimensions (W x H x D)	 mm	22.5 x 100 x 100	45 x 100 x 100
Connection type		⊕ Screw terminals	
• Solid	mm <sup>2</sup>	2 x (0.5 ... 4)	
• Finely stranded with end sleeve	mm <sup>2</sup>	2 x (0.75 ... 2.5)	
• AWG cables, solid or stranded	AWG	2 x (20 ... 14)	
<b>General data</b>			
Rated insulation voltage $U_i$	V	400 supply circuit/measuring circuit, 300 supply circuit/output circuit	400 supply circuit/measuring circuit, 300 supply circuit/output circuit, 300 output circuit 1/output circuit 2
Pollution degree 3			
Overvoltage category III acc. to IEC 60664			
Rated impulse withstand voltage $U_{imp}$	kV	6	
Rated control supply voltage	V AC/DC	24 ... 240	
Rated frequency	Hz	15 ... 400	
<b>Measuring circuit</b>			
Rated line voltage of the network being monitored	V	0 ... 250 AC, 0 ... 300 DC	0 ... 300 AC, 0 ... 690 AC with 3UG49 83, 0 ... 600 DC, 0 ... 1 000 DC with 3UG49 83
Rated frequency of the network being monitored	Hz	DC or 15 ... 400	
Setting range for insulation resistance	k	1 ... 100	1 ... 100, 2 ... 200 for 2nd limit value (disconnectable)
<b>Control circuit</b>			
Number of CO contacts for auxiliary contacts		1	2 or 1 + 1, adjustable
Load capacity of the output relay			
• Thermal current $I_{th}$	A	4	
Rated operational current $I_e$ at			
• AC-15/24 ... 400 V	A	3	
• DC-13/24 V	A	2	
Minimum contact load at 24 V DC	mA	10	



### Selection and ordering data

- Auto or Manual RESET
- Rated control supply voltage  $U_s$  24 ... 240 V AC/DC
- 3UG4582: Closed-circuit principle  
3UG4583: Open-circuit or closed-circuit principle, adjustable
- 1 or 2 CO contacts
- Fault memory adjustable using control input (Y2-Y3)
- Reset by means of button on front or using control input (Y2-Y3)
- Test by means of button on front or using control input (Y1-Y3)
- 3UG4583: Non-volatile fault storage can be configured
- 3UG4583: 2 separate limit values (e.g. for warning and disconnection) or 2 CO contacts for one limit value (e.g. for a local alarm and signaling to the PLC via separate circuits) can be configured

Note:

With the 3UG4983-1A coupling unit, connection to networks with voltages of up to 690 V AC and 1 000 V DC is possible, see below.

	Rated line voltage $U_n$	System leakage capacitance	Output relays	Measuring range $U_e$	Broken wire detection in the measuring range	SD	Screw terminals		PU (UNIT, SET, M)	PS*
							Article No.	Price per PU		
	V	$\mu$ F		k $\Omega$		d				
<b>3UG4582 insulation monitors</b>										
	0 ... 250 AC, 0 ... 300 DC	Max. 10	1 CO	1 ... 100	✓	5	<b>3UG4582-1AW30</b>		1	1 unit
<b>3UG4583 insulation monitors</b>										
	0 ... 400 AC, 0 ... 600 DC <sup>1)</sup>	Max. 20	2 CO or 1 CO + 1 CO, adjustable	1 ... 100, 2 ... 200 for 2nd limit value, adjustable	✓ Adjustable	5	<b>3UG4583-1CW30</b>		1	1 unit
<b>Voltage reducer module for 3UG4583</b>										
	For extending the network voltage range to max. 690 V AC and 1 000 V DC					5	<b>3UG4983-1A</b>		1	1 unit

3UG4983-1A  
✓ Available

<sup>1)</sup> With 3UG4983-1A voltage reducer module suitable also for the insulation monitoring of IT networks of up to 690 V AC and 1 000 V DC.

For accessories, see page 11/96

## Overview



SIRIUS 3UG4501 monitoring relay

The 3UG4501 level monitoring relay is used in combination with 2- or 3-pole sensors to monitor the levels of conductive liquids.

## Benefits

- Can be used worldwide thanks to wide voltage range from 24 to 240 V (absolute limit values)
- Individually shortenable 2- and 3-pole wire electrodes for easy mounting from above/below
- Bow electrodes for installation from the side, for larger filling levels and minimum space requirements
- Can be flexibly adapted to different conductive liquids through analog setting of the sensitivity from 2 to 200 kΩ
- Compensation for wave movements through tripping delay times from 0.1 to 10 s
- Upstream or downstream function selectable
- All versions with removable terminals
- All versions with screw or spring-type terminals

## Application

- Single-point and two-point level monitoring
- Overflow protection
- Dry run protection
- Leak monitoring

## Technical specifications

### 3UG4501 monitoring relays

The principle of operation of the 3UG4501 level monitoring relay is based on measuring the electrical resistance of the liquid between two immersion sensors and a reference terminal. If the measured value is lower than the sensitivity set at the front, the output relay changes its switching state. In order to exclude electrolytic phenomena in the liquid, the sensors are supplied with alternating current.

#### Two-point control

The output relay changes its switching state as soon as the liquid level reaches the maximum sensor, while the minimum sensor is submerged. The relay returns to its original switching state as soon as the minimum sensor no longer has contact with the liquid.

#### OVER, two-point control

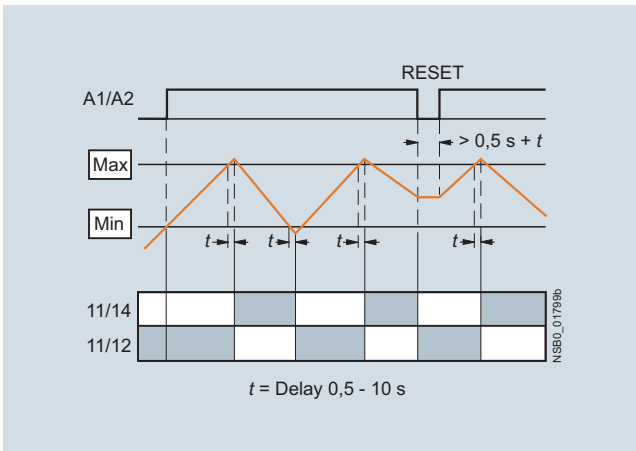

#### UNDER, two-point control

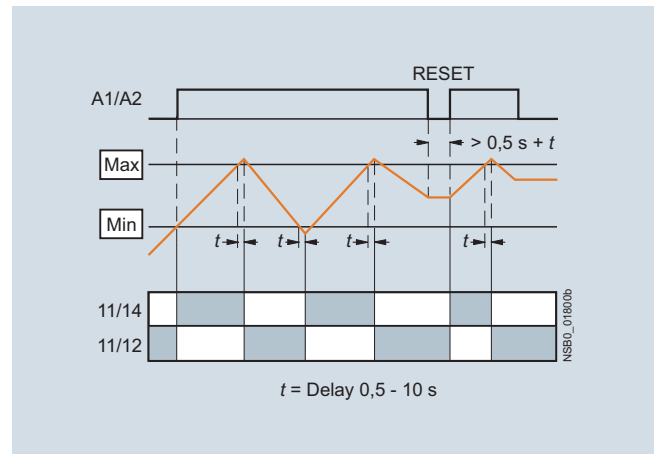

#### Note:

It is also possible to connect other resistance sensors to the Min and Max terminals in the range 2 to 200 kΩ, e.g. photoresistors, temperature sensors, encoders based on resistance, etc. The monitoring relay can therefore also be used for other applications as well as for monitoring the levels of liquids.

### Single-point control

If only one level is being controlled, the terminals for Min and Max on the monitoring relay are bridged. The output relay changes its switching state as soon as the liquid level is reached and returns to its original switching state once the sensor no longer has contact with the liquid.

In order to prevent premature tripping of the switching function caused by wave motion or frothing, even though the set level has not been reached, it is possible to delay this function by 0.5 to 10 s.

For safe resetting, the control supply voltage must be interrupted for at least the set delay time of +0.5 s.

### OVER, single-point control

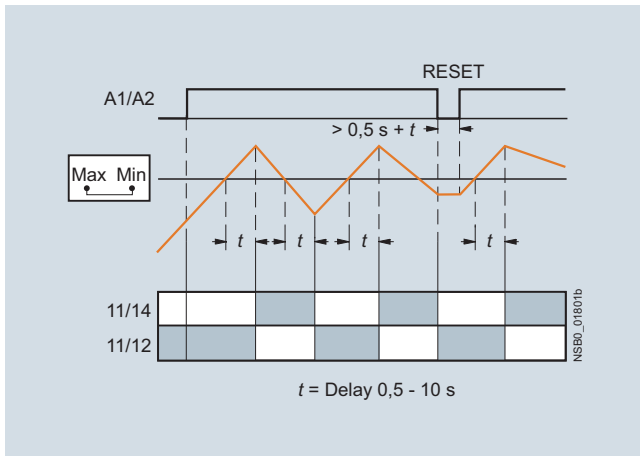

### UNDER, single-point control

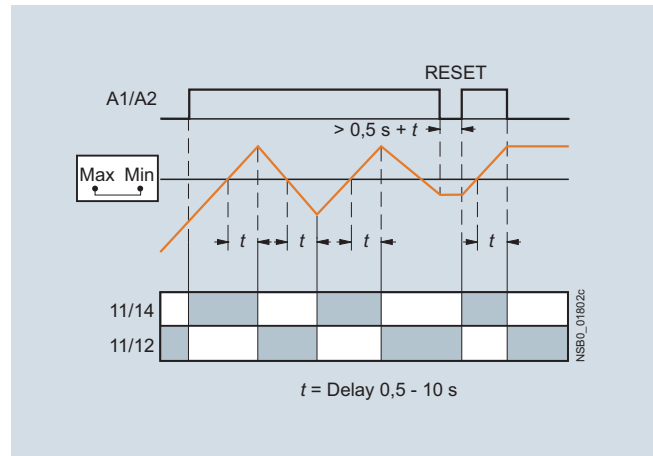



Type	3UG4501	
<b>General data</b>		
<b>Rated insulation voltage <math>U_i</math></b>	V	300
Pollution degree 3 Overvoltage category III acc. to VDE 0110		
<b>Rated impulse withstand voltage <math>U_{imp}</math></b>	kV	4
<b>Measuring circuit</b>		
<b>Electrode current, max.</b> (typ. 70 Hz)	mA	1
<b>Electrode voltage, max.</b> (typ. 70 Hz)	V	15
<b>Sensor feeder cable</b>	m	Max. 100
<b>Conductor capacitance of sensor cable<sup>1)</sup></b>	nF	Max. 10
<b>Control circuit</b>		
<b>Load capacity of the output relay</b>		
Thermal current $I_{th}$	A	5
<b>Rated operational current <math>I_e</math> at</b>		
• AC-15/24 ... 400 V	A	3
• DC-13/24 V	A	1
• DC-13/125 V	A	0.2
• DC-13/250 V	A	0.1
<b>Minimum contact load at 17 V DC</b>	mA	5

<sup>1)</sup> The sensor cable does not necessarily have to be shielded, but we do not recommend installing this cable parallel to the power supply lines. It is also possible to use a shielded cable, whereby the shield has to be connected to the M terminal.

### Selection and ordering data

- For level monitoring of electrically conductive liquids
  - Control principle: inlet or sequence control adjustable per rotary switch
  - Single-point and two-point control possible
  - Analogically adjustable sensitivity (specific resistance of the liquid)
  - Analogically adjustable tripping delay time
  - 1 yellow LED for displaying the relay state
  - 1 green LED for displaying the applied control supply voltage
  - 1 CO contact
- PU (UNIT, SET, M) = 1  
PKG\* = 1 UNIT

Sensitivity	Tripping delay time	Rated control supply voltage $U_s$	SD	Screw terminals 		Spring-type terminals 	
				Article No.	Price per PU	Article No.	Price per PU
2 ... 200	0.5 ... 10	V	d	<b>3UG4501-1AA30</b>	2	<b>3UG4501-2AA30</b>	2
		AC/DC	d				
		24 <sup>1)</sup>	2				
		24 ... 240	2	<b>3UG4501-1AW30</b>	2	<b>3UG4501-2AW30</b>	2

<sup>1)</sup> The rated control supply voltage and the measuring circuit are not electrically separated.

For accessories, [see page 11/96](#)

## Overview



SIRIUS 3UG4651 monitoring relay

The 3UG4651 monitoring relay is used in combination with a sensor to monitor motor drives for overspeed and/or under-speed.

Furthermore, the monitoring relay is ideal for all functions where a continuous pulse signal needs to be monitored (e.g. belt travel monitoring, completeness monitoring, passing monitoring, clock-time monitoring).

## Benefits

- Can be used worldwide thanks to wide voltage range from 24 to 240 V (absolute limit values)
- Variably adjustable to overshoot, undershoot or range monitoring
- Freely configurable delay times and RESET response
- Permanent display of actual value and fault type
- Use of up to 10 sensors per rotation for extremely slowly rotating motors
- 2- or 3-wire sensors and sensors with a mechanical switching output or semiconductor output can be connected
- Auxiliary voltage for sensor integrated
- All versions with removable terminals
- All versions with screw or spring-type terminals

## Application

- Slip or tear of a belt drive
- Overload monitoring
- Transport monitoring for completeness

## Technical specifications

### 3UG4651 monitoring relay

The speed monitoring relay operates according to the principle of period duration measurement.

In the monitoring relay, the time between two successive rising edges of the pulse encoder is measured and compared to the minimum and/or maximum permissible period duration calculated from the set limit values for the speed.

Thus, the period duration measurement recognizes any deviation in speed after just two pulses, even at very low speeds or in the case of extended pulse gaps.

By using up to ten pulse encoders evenly distributed around the circumference, it is possible to shorten the period duration, and in turn the response time. By taking into account the number of sensors in the monitoring relay, the speed continues to be indicated in rpm.

#### ON-delay time for motor start

To be able to start a motor drive, and depending on whether the open-circuit or closed-circuit principle is selected, the output relay switches to the GO state during the ON-delay time, even if the speed is still below the set value.

The ON-delay time is started by either switching on the auxiliary voltage or, if the auxiliary voltage is already applied, by actuating the respective NC contact (e.g. auxiliary contact).

#### Speed monitoring with Auto RESET (Memory = no)

If the device is set to Auto RESET, the output relay switches to the GO state, once the adjustable hysteresis threshold is reached in the range of 0.1 to 99.9 rpm and the flashing stops. Any overshoots or undershoots are therefore not stored.

#### Speed monitoring with Manual RESET (Memory = yes)

If Manual RESET is selected in the menu, the output relay remains in its current switching state and the current measured value and the symbol for overshooting/undershooting continue to flash, even when the speed returns to a permissible value. This stored fault status can be reset by simultaneously pressing the UP▲ and DOWN▼ keys for > 2 s, by connecting the RESET device terminal to 24 V DC or by switching the control supply voltage off and back on again.

Speed monitoring

With the closed-circuit principle selected

Range monitoring without enable input

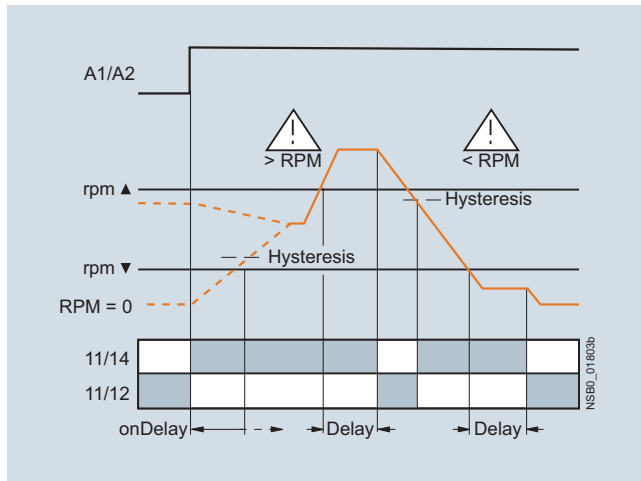

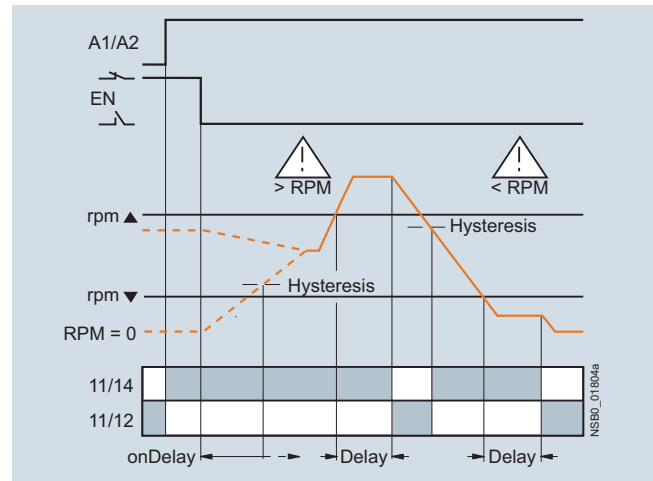

Range monitoring with enable input



Type	3UG4651	
<b>General data</b>		
Rated insulation voltage $U_i$	V	300
Pollution degree 3 Overvoltage category III acc. to VDE 0110		
Rated impulse withstand voltage $U_{imp}$	kV	4
<b>Measuring circuit</b>		
<b>Sensor supply</b>		
• For 3-wire sensor (24 V/0 V)	mA	Max. 50
• For 2-wire NAMUR sensor (8V2)	mA	Max. 8.2
<b>Signal input</b>		
• IN1	k $\Omega$	16, 3-wire sensor, pnp operation
• IN2	k $\Omega$	1, floating contact, 2-wire NAMUR sensor
<b>Voltage level</b>		
• For level 1 at IN1	V	4.5 ... 30
• For level 0 at IN1	V	0 ... 1
<b>Current level</b>		
• For level 1 at IN2	mA	> 2.1
• For level 0 at IN2	mA	< 1.2
Minimum pulse duration of signal	ms	5
Minimum interval between 2 pulses	ms	5
<b>Control circuit</b>		
Number of CO contacts for auxiliary contacts		1
<b>Load capacity of the output relay</b>		
Thermal current $I_{th}$	A	5
<b>Rated operational current <math>I_e</math> at</b>		
• AC-15/24 ... 400 V	A	3
• DC-13/24 V	A	1
• DC-13/125 V	A	0.2
• DC-13/250 V	A	0.1
Minimum contact load at 17 V DC	mA	5

### Selection and ordering data







- For speed monitoring in revolutions per minute (rpm)
  - Two- or three-wire sensor with mechanical or electronic switching output can be connected
  - Two-wire NAMUR sensor can be connected
  - Sensor supply 24 V DC/50 mA integrated
  - Input frequency 0.1 to 2 200 pulses rpm (0.0017 to 36.7 Hz)
  - With or without enable signal for the drive to be monitored
  - Digitally adjustable, with illuminated LCD
  - Overshoot, undershoot or range monitoring adjustable
  - Number of pulses per revolution can be adjusted
  - Upper and lower threshold value can be adjusted separately
  - Auto, manual or remote RESET options after tripping
  - Permanent display of actual value and tripping state
  - 1 CO contact
- PU (UNIT, SET, M) = 1  
PKG\* = 1 UNIT

Measuring range	Hysteresis	ON-delay time	Tripping delay time	Pulses per revolution	Rated control supply voltage $U_s$ AC/DC	SD	Screw terminals 		Spring-type terminals 	
							Article No.	Price per PU	Article No.	Price per PU
0.1 ... 2 200 rpm	OFF 0.1 ... 99.9 rpm	0 ... 900 s	0.1 ... 99.9 s	1 ... 10	24 <sup>1)</sup> V	d	<b>3UG4651-1AA30</b>	2	<b>3UG4651-2AA30</b>	d
					24 ... 240 V	2	<b>3UG4651-1AW30</b>	2	<b>3UG4651-2AW30</b>	

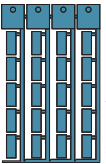
<sup>1)</sup> The rated control supply voltage and the measuring circuit are not electrically separated.

For accessories, see page 11/96

Selection and ordering data

	Use	Version	SD	Article No.	Price per PU	PU (UNIT, SET, M)	PS*
<b>Blank labels</b>							
 3RT1900-1SB20	For 3UG4	<b>Unit labeling plates</b> For SIRIUS devices 20 mm x 7 mm, pastel turquoise	20	<b>3RT1900-1SB20</b>		100	340 units
	For 3UG4	<b>Adhesive labels</b> for SIRIUS devices • 19 mm x 6 mm, pastel turquoise • 19 mm x 6 mm, zinc yellow	15	<b>3RT1900-1SB60</b>		100	3 060 units
			15	<b>3RT1900-1SD60</b>		100	3 060 units
<b>Push-in lugs and covers</b>							
 3RP1903	For 3UG4	<b>Push-in lugs</b> For screw fixing, 2 units are required for each device	5	<b>3RP1903</b>		1	10 units
	For 3UG4	<b>Sealable covers</b> For securing against unauthorized adjustment of setting knobs	5	<b>3RP1902</b>		1	5 units
 3RP1902	For 3UG45	<b>Sealing foil</b> For securing against unauthorized adjustment of setting knobs		<b>3TK2820-0AA00</b>		1	1 unit
<b>Covers for insulation monitoring relays</b>							
 3UG4981-0C	For 3UG4581 and 3UG4582	<b>Sealable, transparent covers</b>	5	<b>3UG4981-0C</b>		1	1 unit
	For 3UG4583		5	<b>3UG4983-0C</b>		1	1 unit
 3UG4983-0C							
<b>Tools for opening spring-type terminals</b>							
 3RA2908-1A	For auxiliary circuit connections	<b>Screwdrivers</b> For all SIRIUS devices with spring-type terminals; 3.0 mm x 0.5 mm; length approx. 200 mm, titanium gray/black, partially insulated	2	<b>Spring-type terminals</b>		1	1 unit
		<b>3RA2908-1A</b>					

Note:

For products for mechanical bearing monitoring, e.g. condition monitoring systems, see [www.siemens.com/siplus-cms](http://www.siemens.com/siplus-cms).



## Overview



SIRIUS 3UG48 monitoring relays

## More information

Homepage, see [www.usa.siemens.com/relays](http://www.usa.siemens.com/relays)

Industry Mall, see [www.siemens.com/product?3UG48](http://www.siemens.com/product?3UG48)

For the conversion tool, e.g. from 3UG3 to 3UG4, see [www.siemens.com/sirius/conversion-tool](http://www.siemens.com/sirius/conversion-tool)

The SIRIUS 3UG4 monitoring relays for electronic and mechanical variables monitor all important characteristics that allow conclusions to be drawn about the functionality of a plant. Both sudden disturbances and gradual changes, which may indicate the need for maintenance, are detected.

Thanks to their relay outputs, the monitoring relays permit direct disconnection of the affected system components and alerting, e.g. by the triggering of a warning light. Thanks to adjustable delay times the 3UG4 monitoring relays can respond very flexibly to brief faults such as voltage dips or load changes and can thus avoid unnecessary alarms and disconnections and increase system availability.

**3UG48 monitoring relays for IO-Link**

The SIRIUS 3UG48 monitoring relays for IO-Link also offer many other options based upon the monitoring functions of the tried-and-tested SIRIUS 3UG4 monitoring relays:

- Measured value transmission to a controller, including resolution and unit, may be parameterizable as to which value is cyclically transmitted
- Transmission of alarm flags to a controller
- Full diagnosis capability by inquiry as to the cause of the fault in the diagnosis data record
- Remote parameterization is also possible, in addition to or instead of local parameterization
- Rapid parameterization of the same devices by duplication of the parameterization in the controller
- Parameter transmission through uploading to a controller by IO-Link call or by parameter server (if IO-Link master from IO-Link Specification V1.1 and higher is used)
- Consistent central data storage in the event of parameter change locally or via a controller
- Automatic reparameterizing when devices are exchanged
- Blocking of local parameterization via IO-Link possible
- Faults are saved in parameterizable and non-volatile fashion to prevent an automatic start up after voltage failure and to make sure diagnostics data is not lost

- Integration into the automation level provides the option of parameterizing the monitoring relays at any time via a display unit, or displaying the measured values in a control room or locally at the machine/control cabinet

Even without communication via IO-Link the devices continue to function fully autonomously:

- Parameterization can take place locally at the device, independently of a controller.
- In the event of failure or before the controller becomes available the monitoring relays work as long as the control supply voltage (24 V DC) is present.
- If the monitoring relays are operated without the controller, the 3UG48 monitoring relays have, thanks to the integrated SIO mode, an additional semiconductor output, which switches when the adjustable warning threshold is exceeded.

Thanks to the combination of autonomous monitoring relay function and integrated IO-Link communication, redundant sensors and/or analog signal converters – which previously took over the transmission of measured values to a controller, leading to considerable extra cost and wiring outlay – are no longer needed.

Because the output relays are still present, the monitoring relays increase the functional reliability of the system, since only the controller can fulfill the control tasks if the current measured values are available, whereas the output relays can also be used for the disconnection of the system if limit values that cannot be reached during operation are exceeded.

The individual 3UG48 monitoring relays for IO-Link offer the following functions in different combinations:

- Phase sequence
- Phase failure, neutral conductor failure
- Phase asymmetry
- Undershooting and/or overshooting of limit values for voltage
- Undershooting and/or overshooting of limit values for current
- Undershooting and/or overshooting of power factor limit values
- Monitoring of the active current or the apparent current
- Monitoring of the residual current
- Undershooting and/or overshooting of limit values for speed

Note:

For more information on the IO-Link bus system, [click here](#).

Notes on security

In order to protect plants, systems, machines and networks against cyber threats, it is necessary to implement – and continuously maintain – a holistic, state-of-the-art industrial security concept. Siemens products and solutions represent only one component of such a concept.

For more information on Industrial Security, see [www.usa.siemens.com/industrialsecurity](http://www.usa.siemens.com/industrialsecurity).

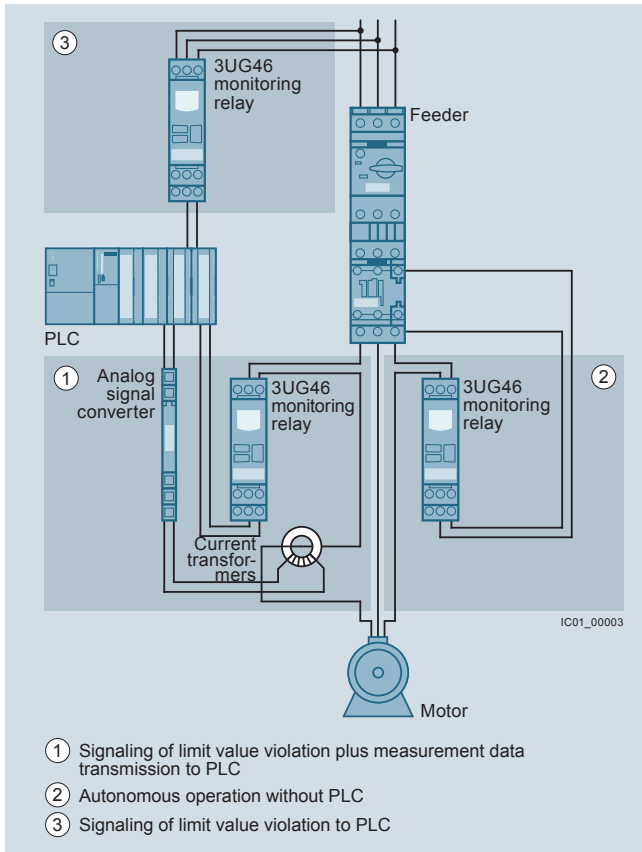

Use of conventional monitoring relays

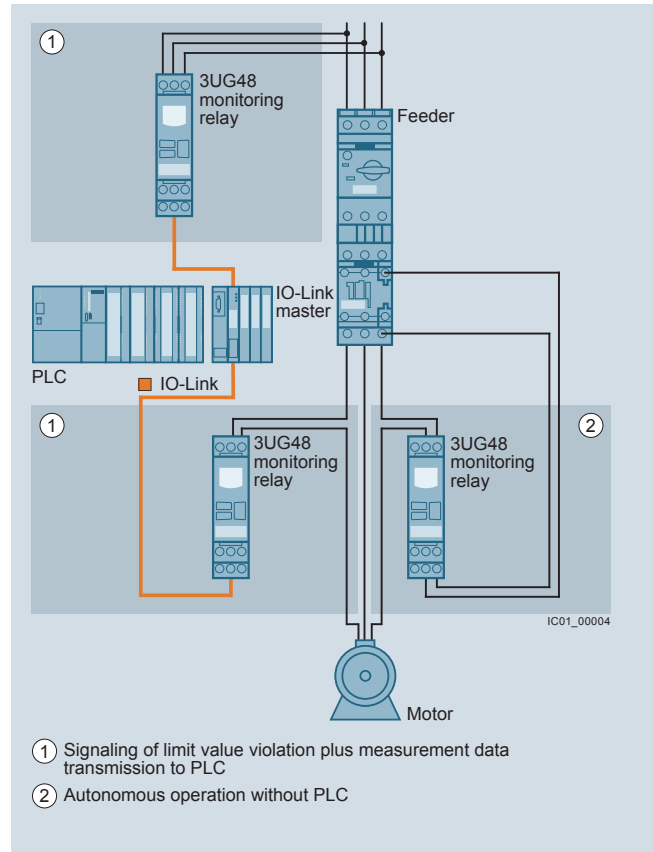

Monitoring relays for IO-Link

**Notes:**

- Devices required for the communication via IO-Link:
- Any controller that supports the IO-Link (e.g. ET 200SP with CPU or S7-1200).
  - IO-Link master (e.g. CM 4xIO-Link for SIMATIC ET 200SP or SM 1278 for S7-1200).

Each monitoring relay requires an IO-Link channel.

**Article No. scheme**

Product versions		Article number	
<b>3UG4 monitoring relay with IO-Link</b>		<b>3UG4</b>	<input type="checkbox"/> <input type="checkbox"/> <input type="checkbox"/> - <input type="checkbox"/> <input type="checkbox"/> <input type="checkbox"/> <input type="checkbox"/> <b>0</b>
Type of setting	e.g. 8 = analogically adjustable	<input type="checkbox"/>	
Functions	e.g. 15 = line monitoring	<input type="checkbox"/> <input type="checkbox"/>	
Connection type	Screw terminals		<b>1</b>
	Spring-type terminals (push-in)		<b>2</b>
Contacts	e.g. A = 1 CO contact	<input type="checkbox"/>	
Supply voltage	e.g. A4 = 160 ... 690 V AC		<input type="checkbox"/> <input type="checkbox"/>
Example		<b>3UG4</b>	<b>8 1 5 - 1 A A 4 0</b>

**Note:**

The Article No. scheme shows an overview of product versions for better understanding of the logic behind the article numbers.

For your orders, please use the article numbers quoted in the selection and ordering data.

**Benefits**

- Simple cyclical transmission of the current measured values, relay switching states and events to a controller
- Remote parameterization
- Automatic reparameterizing when devices are exchanged
- Simple duplication of identical or similar parameterizations
- Reduction of control current wiring
- Elimination of testing costs and wiring errors
- Reduction of configuration work
- Integration in TIA means clear diagnostics if a fault occurs
- Cost saving and space saving in control cabinet due to the elimination of AI and IO modules as well as analog signal converters and duplicated sensors



## Application

The use of SIRIUS monitoring relays for IO-Link is particularly recommended for machines and plants in which these relays, in addition to their monitoring function, are to be connected to the automation level for the rapid, simple and fault-free provision of the current measured values and/or for remote parameterization.

The monitoring relays can either relieve the controller of monitoring tasks or, as a second monitoring entity in parallel to and independent of the controller, increase the reliability in the process or in the system. In addition, the elimination of AI and IO modules allows the width of the controller to be reduced despite significantly expanded functionality.

## Technical specifications

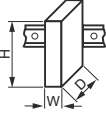
More information	
Technical specifications, see <a href="https://support.industry.siemens.com/cs/ww/en/ps/16368/td">https://support.industry.siemens.com/cs/ww/en/ps/16368/td</a> Manual and internal circuit diagrams, see <a href="https://support.industry.siemens.com/cs/ww/en/view/54375430">https://support.industry.siemens.com/cs/ww/en/view/54375430</a>	FAQs, see <a href="https://support.industry.siemens.com/cs/ww/en/ps/16368/faq">https://support.industry.siemens.com/cs/ww/en/ps/16368/faq</a>

Type	3UG48	
<b>General technical specifications</b>		
Dimensions (W x H x D)		
<ul style="list-style-type: none"> <li>For 3 terminal blocks                             <ul style="list-style-type: none"> <li>- Screw terminals</li> <li>- Spring-type terminals</li> </ul> </li> <li>For 4 terminal blocks                             <ul style="list-style-type: none"> <li>- Screw terminals</li> <li>- Spring-type terminals</li> </ul> </li> </ul>		mm 22.5 x 92 x 91
		mm 22.5 x 94 x 91
	mm 22.5 x 103 x 91	mm 22.5 x 103 x 91
<b>Permissible ambient temperature</b>		
• During operation	°C	-25 ... +60
<b>Connection type</b>		 <b>Screw terminals</b>
<ul style="list-style-type: none"> <li>Terminal screw</li> <li>Solid</li> <li>Finely stranded with end sleeve</li> <li>AWG cables, solid or stranded</li> <li>Tightening torque</li> </ul>	mm <sup>2</sup>	M3 (for standard screwdriver, size 2 and Pozidriv 2)
	mm <sup>2</sup>	1 x (0.5 ... 2.5), 2 x (0.5 ... 2.5)
	AWG	1 x (0.5 ... 2.5), 2 x (0.5 ... 1.5)
	Nm	2 x (20 ... 14) 0.8 ... 1.2
<b>Connection type</b>		 <b>Spring-type terminals</b>
<ul style="list-style-type: none"> <li>Solid</li> <li>Finely stranded, with end sleeve acc. to DIN 46228</li> <li>Finely stranded</li> <li>AWG cables, solid or stranded</li> </ul>	mm <sup>2</sup>	2 x (0.25 ... 1.5)
	mm <sup>2</sup>	2 x (0.25 ... 1.5)
	mm <sup>2</sup>	2 x (0.25 ... 1.5)
	AWG	2 x (24 ... 16)

## Overview

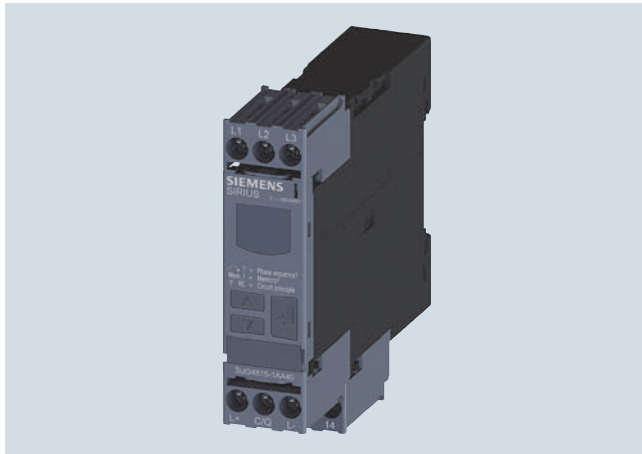

SIRIUS 3UG4815 monitoring relay

Solid-state line monitoring relays provide maximum protection for mobile machines, plants and hoisting equipment or for unstable networks. Network and voltage faults can thus be detected early and rectified before far greater damage ensues.

The line monitoring relays with IO-Link monitor phase sequence, phase failure (with or without N conductor monitoring), phase asymmetry and undervoltage and/or overvoltage.

Phase asymmetry is evaluated as the difference between the greatest and the smallest phase voltage relative to the greatest phase voltage. Undervoltage or overvoltage exist if the set limit values for at least one phase voltage are overshoot or undershot. The rms value of the voltage is measured.

## Benefits

- Can be used in any network from 160 to 630 V AC worldwide thanks to wide voltage range
- Variably adjustable to overshoot, undershoot or range monitoring
- Freely configurable delay times and RESET response
- Width 22.5 mm
- Display and transmission of actual value and network fault type to controller
- All versions with removable terminals
- All versions with screw or spring-type terminals

## Application

The relays are used above all for mobile equipment, e.g. air conditioning compressors, refrigerating containers, building site compressors and cranes.

Function	Application
Phase sequence	<ul style="list-style-type: none"> <li>• Direction of rotation of the drive</li> </ul>
Phase failure	<ul style="list-style-type: none"> <li>• A fuse has tripped</li> <li>• Failure of the control supply voltage</li> <li>• Broken cable</li> </ul>
Phase asymmetry	<ul style="list-style-type: none"> <li>• Overheating of the motor due to asymmetrical voltage</li> <li>• Detection of asymmetrically loaded networks</li> </ul>
Undervoltage	<ul style="list-style-type: none"> <li>• Increased current on a motor with corresponding overheating</li> <li>• Unintentional resetting of a device</li> <li>• Network collapse, particularly with battery power</li> </ul>
Oversvoltage	<ul style="list-style-type: none"> <li>• Protection of a plant against destruction due to oversvoltage</li> </ul>

## Technical specifications

### 3UG4815/3UG4816 monitoring relays

The 3UG4815 and 3UG4816 line monitoring relays have a wide voltage range input and are supplied with power through IO-Link or from an external 24 V DC source.

The device is equipped with a display and is parameterized using three buttons. The 3UG4815 monitoring relay monitors three-phase networks with regard to phase sequence, phase failure, phase asymmetry, undervoltage and overvoltage. The 3UG4816 monitoring relay monitors the neutral conductor as well. The hysteresis is adjustable from 1 to 20 V.

The device has two separately adjustable delay times for overvoltage and undervoltage and for line stabilization. If the direction of rotation is incorrect or a phase fails, the device switches off immediately. Thanks to a special measuring method, a phase failure is reliably detected in spite of the wide voltage range from and potentially high feedback through the load.

The 3UG4815 and 3UG4816 monitoring relays can be operated on the basis of either the open-circuit or closed-circuit principle and with Manual or Auto RESET.

If Manual RESET is selected in the menu (Memory = Yes), the switching relay remains in its current switching state and the current measured value and the symbol for undershooting and overshooting continues to flash, even when the measured variable reaches a permissible value again. This stored fault status can be reset by simultaneously pressing the UP▲ and DOWN▼ keys for 2.5 s.

With Manual RESET through IO-Link it is possible in addition to set whether error signals are to be deleted when the control supply voltage is switched off and on (as remote RESET) or whether the signals are to be permanently saved even in a voltage failure, with confirmation possible only through local RESET or via IO-Link.

With the closed-circuit principle selected

Wrong phase sequence

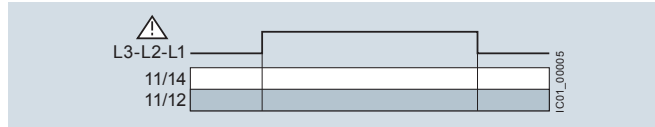

Phase failure

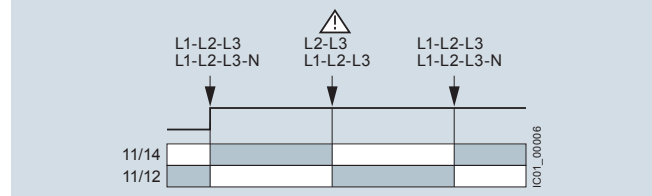

Undervoltage

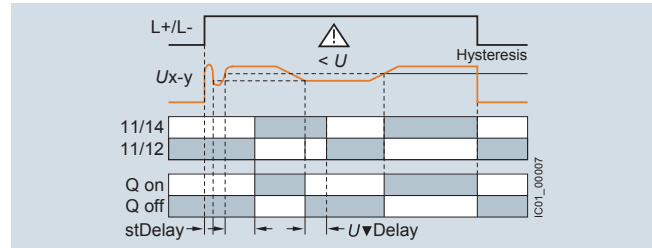

Overvoltage

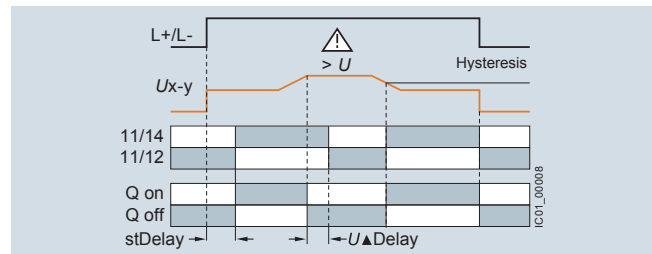

Type	3UG4815, 3UG4816	
<b>General technical specifications</b>		
<b>Rated insulation voltage <math>U_i</math></b>	V	690
Pollution degree 2 Overvoltage category III acc. to VDE 0110		
<b>Rated impulse withstand voltage <math>U_{imp}</math></b>	kV	6
<b>Control circuit</b>		
<b>Load capacity of the output relay</b>		
• Thermal current $I_{th}$	A	5
<b>Rated operational current <math>I_e</math> at</b>		
• AC-15/24 ... 400 V	A	3
• DC-13 at		
- 24 V	A	1
- 125 V	A	0.2
- 250 V	A	0.1
<b>Minimum contact load at 17 V DC</b>	mA	5
<b>Electrical endurance AC-15</b>	Million operating cycles	0.1
<b>Mechanical endurance</b>	Million operating cycles	10

# 3UG48 Monitoring Relays for Stand-Alone Installation for IO-Link

## Line monitoring

### Selection and ordering data

- Adjustable via IO-Link and locally, with illuminated LCD
- Power supply with 24 V DC via IO-Link or external auxiliary voltage
- Auto or Manual RESET
- Open- or closed-circuit principle
- 1 CO contact, 1 semiconductor output (in SIO mode)

PU (UNIT, SET, M) = 1  
 PKG\* = 1 UNIT

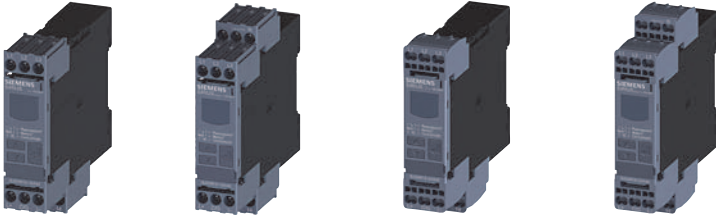

3UG4815-1AA40      3UG4816-1AA40      3UG4815-2AA40      3UG4816-2AA40

Adjustable hysteresis	Under-voltage detection	Over-voltage detection	Stabilization time adjustable stDEL	Tripping delay time adjustable Del	Version of auxiliary contacts	Measurable line voltage <sup>1)</sup>	SD	Screw terminals	SD	Spring-type terminals	
V			s	s		VAC	d	Article No.	Price per PU	Article No.	Price per PU
<b>Monitoring of phase sequence, phase failure, phase asymmetry, overvoltage and undervoltage</b>											
1 ... 20	✓	✓	0.1 ... 999.9	0.1 ... 999.9	1 CO + 1 Q <sup>2)</sup>	160 ... 690	2	<b>3UG4815-1AA40</b>	2	<b>3UG4815-2AA40</b>	
<b>Monitoring of phase sequence, phase and N conductor failure, phase asymmetry, overvoltage and undervoltage</b>											
1 ... 20	✓	✓	0.1 ... 999.9	0.1 ... 999.9	1 CO + 1 Q <sup>2)</sup>	90 ... 400 to N	2	<b>3UG4816-1AA40</b>	2	<b>3UG4816-2AA40</b>	

✓ Function supported

<sup>1)</sup> Absolute limit values.

<sup>2)</sup> In SIO mode.

For accessories, see page 11/119

## Overview

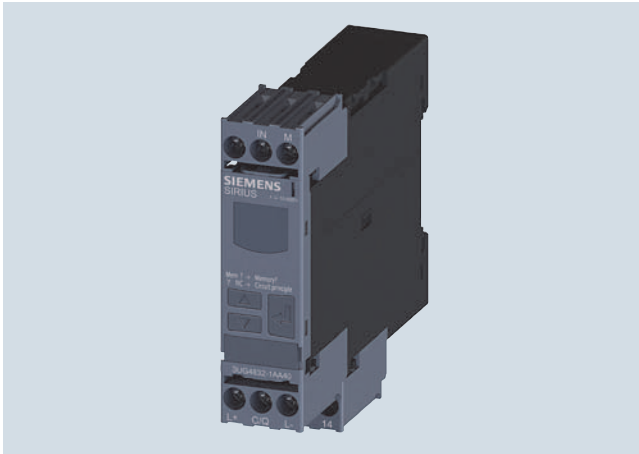

SIRIUS 3UG4832 monitoring relays

The relays monitor single-phase AC voltages (rms value) and DC voltages against the set limit value for overshoot and undershoot.

## Benefits

- Variably adjustable to overshoot, undershoot or range monitoring
- Freely configurable delay times and RESET response
- Width 22.5 mm
- Display and transmission of actual value and status messages to controller
- All versions with removable terminals
- All versions with screw or spring-type terminals

## Application

- Protection of a plant against destruction due to overvoltage
- Switch-on of a plant at a defined voltage and higher
- Protection from undervoltage due to overloaded control supply voltages, particularly with battery power

## Technical specifications

### 3UG4832 monitoring relays

The 3UG4832 voltage monitoring relays are supplied with power through IO-Link or with an external auxiliary voltage of 24 V DC and perform overshoot, undershoot or range monitoring of the voltage depending on parameterization. The devices are equipped with a display and are parameterized by means of three buttons or through IO-Link.

The measuring range extends from 10 to 600 V AC/DC. The limit values for overshoot or undershoot can be freely configured within this range. If one of these limit values is reached, the output relay responds according to the set principle of operation as soon as the delay time has elapsed. This tripping delay time  $U\blacktriangle$  Del/ $U\blacktriangledown$ Del can be set from 0 to 999.9 s, as can the ON-delay time onDel. The hysteresis is adjustable from 0.1 to 300 V.

The device can be operated on the basis of either the open-circuit or closed-circuit principle and with Manual or Auto RESET. One output changeover contact is available as a signaling contact, and a semiconductor output is available in addition in SIO mode.

If Manual RESET is selected in the menu (Memory = Yes), the switching relay remains in its current switching state and the current measured value and the symbol for undershooting and overshooting continues to flash, even when the measured variable reaches a permissible value again. This stored fault status can be reset by simultaneously pressing the UP $\blacktriangle$  and DOWN $\blacktriangledown$  keys for 2.5 s.

With Manual RESET through IO-Link it is possible in addition to set whether error signals are to be deleted when the control supply voltage is switched off and on (as remote RESET) or whether the signals are to be permanently saved even in a voltage failure, with confirmation possible only through local RESET or via IO-Link.

### With the closed-circuit principle selected

#### Overvoltage

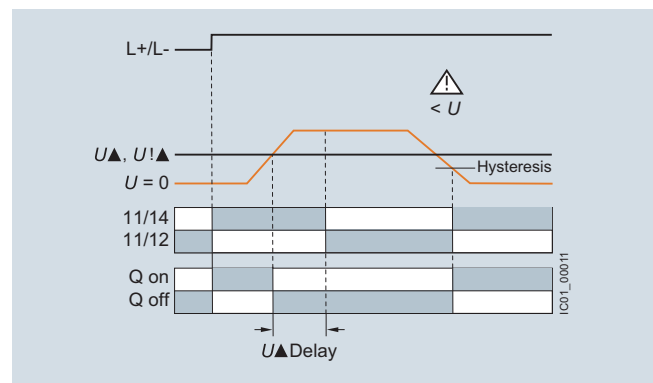

#### Undervoltage

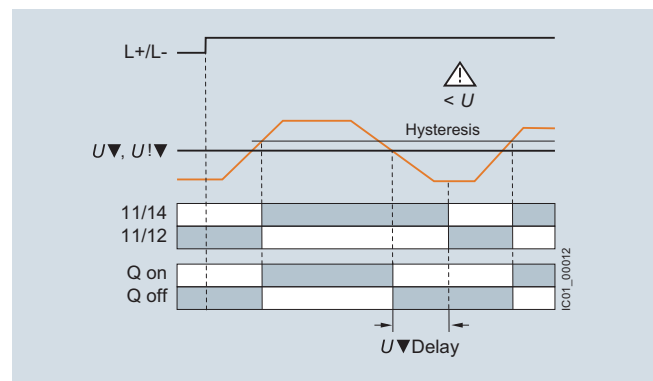

Voltage monitoring

With the closed-circuit principle selected

Range monitoring

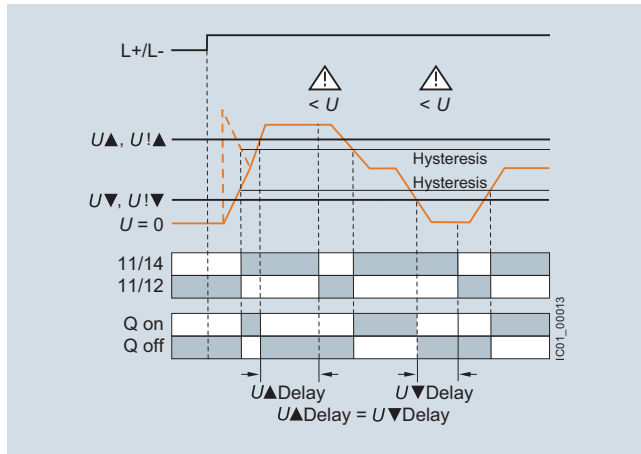

Type	3UG4832	
<b>General technical specifications</b>		
<b>Rated insulation voltage <math>U_i</math></b>	V	690
Pollution degree 2 Overvoltage category III acc. to VDE 0110		
<b>Rated impulse withstand voltage <math>U_{imp}</math></b>	kV	6
<b>Measuring circuit</b>		
<b>Permissible measuring range</b> single-phase AC/DC voltage	V	10 ... 690
<b>Measuring frequency</b>	Hz	40 ... 500
<b>Setting range</b> single-phase voltage	V	10 ... 600
<b>Control circuit</b>		
<b>Load capacity of the output relay</b>		
• Thermal current $I_{th}$	A	5
<b>Rated operational current <math>I_e</math> at</b>		
• AC-15/24 ... 400 V	A	3
• DC-13 at		
- 24 V	A	1
- 125 V	A	0.2
- 250 V	A	0.1
<b>Minimum contact load</b> at 17 V DC	mA	5



# 3UG48 Monitoring Relays for Stand-Alone Installation for IO-Link

## Voltage monitoring

### Selection and ordering data

- Adjustable via IO-Link and locally, with illuminated LCD
- Power supply with 24 V DC via IO-Link or external auxiliary voltage
- Auto or Manual RESET
- Open- or closed-circuit principle
- 1 CO contact, 1 semiconductor output (in SIO mode)



PU (UNIT, SET, M) = 1  
 PKG\* = 1 UNIT



3UG4832-1AA40



3UG4832-2AA40

Measuring range	Adjustable hysteresis	ON-delay time adjustable onDel	Tripping delay time separately adjustable $U\blacktriangle\text{Del}/U\blacktriangledown\text{Del}$	SD	Screw terminals 	SD	Spring-type terminals 	
V AC/DC	V	s	s	d	Article No.	Price per PU	Article No.	Price per PU
<b>Monitoring of voltage for overshoot or undershoot</b>								
10 ... 600	0.1 ... 300	0 ... 999.9	0 ... 999.9	2	<b>3UG4832-1AA40</b>	2	<b>3UG4832-2AA40</b>	

For accessories, [see page 11/119](#).

## Overview



SIRIUS 3UG4822 monitoring relays

The relays monitor single-phase AC (rms value) and DC currents against the set limit value for overshoot and undershoot.

## Benefits

- Variably adjustable to overshoot, undershoot or range monitoring
- Freely configurable delay times and RESET response
- Width 22.5 mm
- Display and transmission of actual value and status messages to controller
- All versions with removable terminals
- All versions with screw or spring-type terminals

## Application

- Overcurrent and undercurrent monitoring
- Monitoring the functionality of electrical loads
- Monitoring for broken conductors

## Technical specifications

### 3UG4822 monitoring relays

The 3UG4822 current monitoring relays are supplied with power through IO-Link or with an external voltage of 24 V DC and perform overshoot, undershoot or range monitoring of the current depending on the parameterization. The devices are equipped with a display and are parameterized using three buttons.

The measuring range extends from 0.05 to 10 A. For larger AC currents the measuring range can be extended by using commercially available current transformers. Using the adjustable transformer factor, the display of the measured primary currents up to 750 A instead of the secondary currents (max. 1 A or 5 A) is possible.

The rms value of the current is measured. The limit values for overshoot or undershoot can be freely configured within this range. If one of these limit values is reached, the output relay responds according to the set principle of operation as soon as the delay time  $I\blacktriangle\text{Del}/I\blacktriangledown\text{Del}$  has elapsed. This time and the ON-delay time  $\text{onDel}$  are adjustable from 0 to 999.9 s.

The hysteresis is adjustable from 0.01 to 5 A. The device can be operated with Manual or Auto RESET and on the basis of either the open-circuit or closed-circuit principle. You can decide here whether the output relay is to respond when the supply voltage  $U_s = \text{ON}$  is applied, or not until the lower measuring range limit of the measuring current ( $I > 50 \text{ mA}$ ) is reached. One output changeover contact is available as a signaling contact, and a semiconductor output is available in addition in SIO mode.

If Manual RESET is selected in the menu (Memory = Yes), the switching relay remains in its current switching state and the current measured value and the symbol for undershooting and overshooting continues to flash, even when the measured variable reaches a permissible value again. This stored fault status can be reset by simultaneously pressing the UP  $\blacktriangle$  and DOWN  $\blacktriangledown$  keys for 2.5 s.

With Manual RESET through IO-Link it is possible in addition to set whether error signals are to be deleted when the control supply voltage is switched off and on (as remote RESET) or whether the signals are to be permanently saved even in a voltage failure, with confirmation possible only through local RESET or via IO-Link.

With the closed-circuit principle selected upon application of the control supply voltage

### Current overshoot

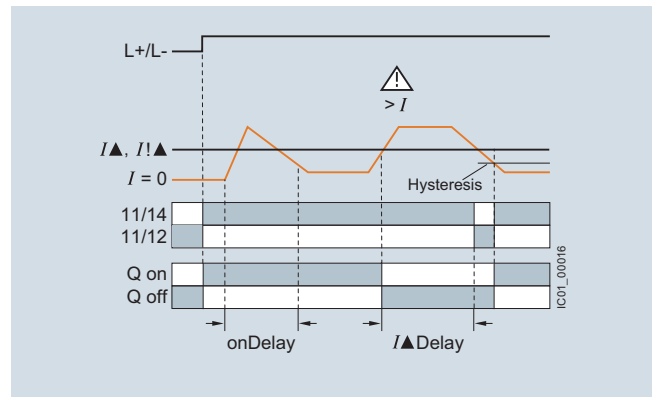

### Current undershoot

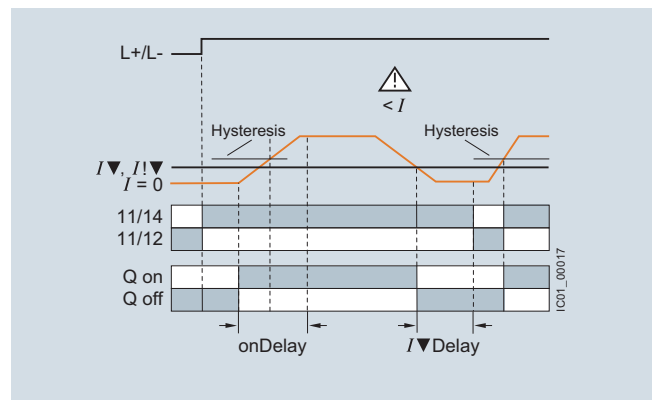

## Current monitoring

With the closed-circuit principle selected upon application of the control supply voltage

Range monitoring

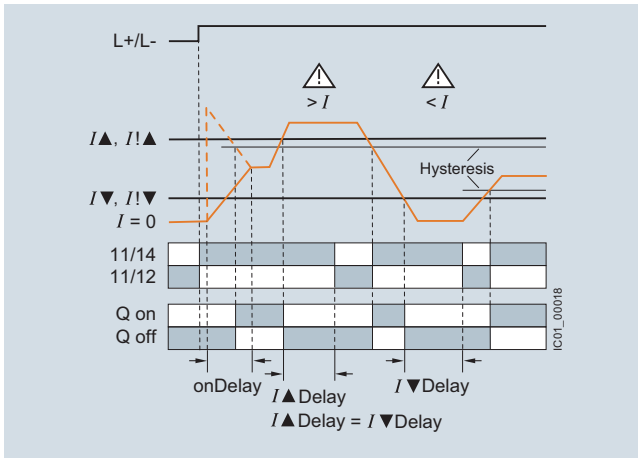

Type	3UG4822	
<b>General technical specifications</b>		
<b>Rated insulation voltage <math>U_i</math></b>	V	690
Pollution degree 2 Overvoltage category III acc. to VDE 0110		
<b>Rated impulse withstand voltage <math>U_{imp}</math></b>	kV	6
<b>Measuring circuit</b>		
<b>Measuring range</b> for single-phase AC/DC current	A	0.05 ... 15
<b>Measuring frequency</b>	Hz	40 ... 500
<b>Setting range</b> for single-phase current	A	0.05 ... 10
<b>Load supply voltage</b>	V	Max. 300 (with protective separation) Max. 500 (with simple separation)
<b>Control circuit</b>		
<b>Load capacity of the output relay</b>	A	5
• Thermal current $I_{th}$		
<b>Rated operational current <math>I_e</math> at</b>	A	3
• AC-15/24 ... 400 V		
• DC-13 at		
- 24 V	A	1
- 125 V	A	0.2
- 250 V	A	0.1
<b>Minimum contact load</b> at 17 V DC	mA	5

# 3UG48 Monitoring Relays for Stand-Alone Installation for IO-Link

## Current monitoring

### Selection and ordering data



- Adjustable via IO-Link and locally, with illuminated LCD
  - Power supply with 24 V DC via IO-Link or external auxiliary voltage
  - Adjustable converter factor to display the measured primary current when an external current transformer is used
  - Auto or Manual RESET
  - Open- or closed-circuit principle
  - 1 CO contact, 1 semiconductor output (in SIO mode)
- PU (UNIT, SET, M) = 1  
 PKG\* = 1 UNIT



3UG4822-1AA40



3UG4822-2AA40

Measuring range	Adjustable hysteresis	ON-delay time adjustable onDel	Tripping delay time separately adjustable /▲Del/▼Del	SD	Screw terminals 	SD	Spring-type terminals 	
A AC/DC	A	s	s	d	Article No.	Price per PU	Article No.	Price per PU
<b>Monitoring of current for overshooting and undershooting</b>								
0.05 ... 10	0.01 ... 5	0.1 ... 999.9	0.1 ... 999.9	2	<b>3UG4822-1AA40</b>	2	<b>3UG4822-2AA40</b>	

For accessories, see page 11/119.

For AC currents  $I > 10$  A it is possible to use commercially available current transformers, e.g. the Siemens 4NC current transformer, as accessories, see Catalog LV 10.

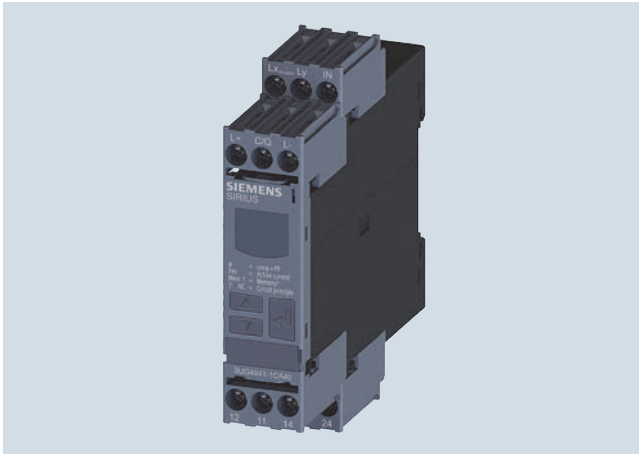
**Overview**

SIRIUS 3UG4841 monitoring relay

The 3UG4841 power factor and active current monitoring devices enable the load monitoring of motors.

Whereas power factor (p.f.) monitoring is used above all for monitoring no-load operation, the active current monitoring option can be used to observe and evaluate the load factor over the entire torque range.

**Technical specifications****3UG4841 monitoring relays**

The 3UG4841 monitoring relays are supplied with power through IO-Link or with an external auxiliary voltage of 24 V DC and are used for performing overshoot, undershoot or range monitoring of the power factor and/or the resulting active current, depending on parameterization. The load to be monitored is connected upstream of the IN terminal. The load current flows through the terminals IN and Ly/N. The setting range for the power factor is 0 to 0.99 and for the active current  $I_{res}$  it is 0.2 to 10 A. If the control supply voltage is switched on and no load current flows, the display will show  $I < 0.2$  and a symbol for overrange, under-range or range monitoring. If the motor is now switched on and the current exceeds 0.2 A, the set ON-delay time  $onDel$  begins. During this time, if the set limit values are undershot or exceeded, this does not lead to a relay reaction of the changeover contact. If the operational flowing active current and/or the p.f. value falls below or exceeds the respective set threshold value, the tripping delay time begins. When this time has expired, the relay changes its switch position. The relevant measured variables for overshooting and undershooting in the display flash. If monitoring for active current undershoot is switched off ( $I_{res} \blacktriangledown = OFF$ ), and if the load current undershoots the lower measuring range threshold (0.2 A), the CO contacts remain unchanged. If a threshold value is set for the monitoring of active current undershooting, then undershooting of the measuring range threshold (0.2 A) will result in a response of the CO contacts.

**Benefits**

- Monitoring of even small single-phase motors with a no-load supply current below 0.5 A
- Simple determination of threshold values by the direct collection of measured variables on motor loading
- Range monitoring and active current measurement enable detection of cable breaks between control cabinets and motors, as well as phase failures
- Power factor and/or  $I_{res}$  (active current) can be selected as the measurement principle
- Width 22.5 mm
- Display and transmission of actual value and status messages to controller
- All versions with removable terminals
- All versions with screw or spring-type terminals

**Application**

- No-load monitoring and load shedding, such as in the event of a V-belt tear
- Underload monitoring in the low-end performance range, e.g. in the event of pump no-load operation
- Monitoring of overload, e.g. due to a dirty filter system
- Power factor monitoring in networks for control of compensation equipment
- Broken cable between control cabinet and motor

The relay operates either according to the open-circuit or closed-circuit principle.

If the device is set to Auto RESET (Memory = No), depending on the set principle of operation, the switching relay returns to its initial state and the flashing ends when the hysteresis threshold is reached.

If Manual RESET is selected in the menu (Memory = Yes), the switching relay remains in its current switching state and the current measured value and the symbol for undershooting and overshooting continues to flash, even when the measured variable reaches a permissible value again. This stored fault status can be reset by simultaneously pressing the UP▲ and DOWN▼ keys for 2.5 s.

With Manual RESET through IO-Link it is possible in addition to set whether error signals are to be deleted when the control supply voltage is switched off and on (as remote RESET) or whether the signals are to be permanently saved even in a voltage failure, with confirmation possible only through local RESET or via IO-Link.

## Power factor and active current monitoring

With the closed-circuit principle selected

Response in the event of undershooting the measuring range limit with activated monitoring of  $I_{res}$  ▼

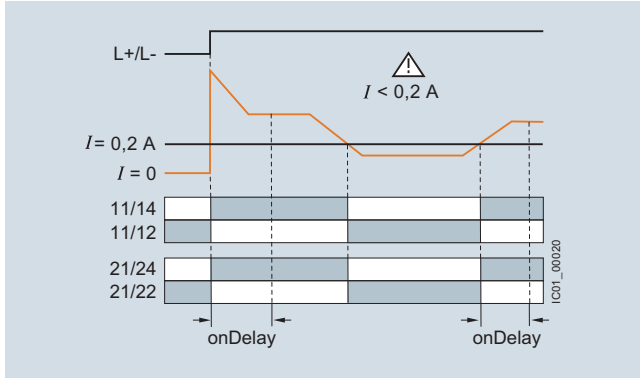

Overshooting of active current

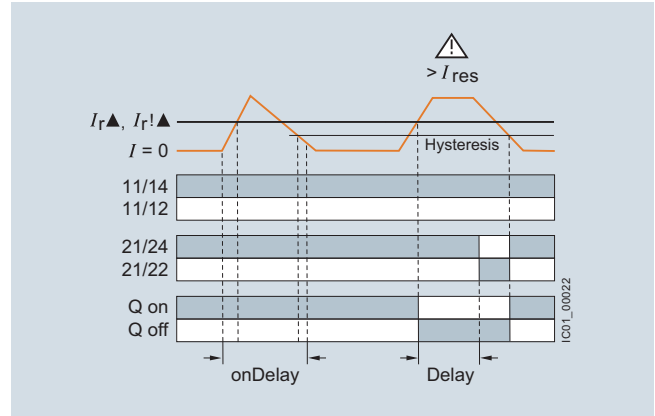

Response in the event of undershooting the measuring range limit with deactivated monitoring of active current undershooting

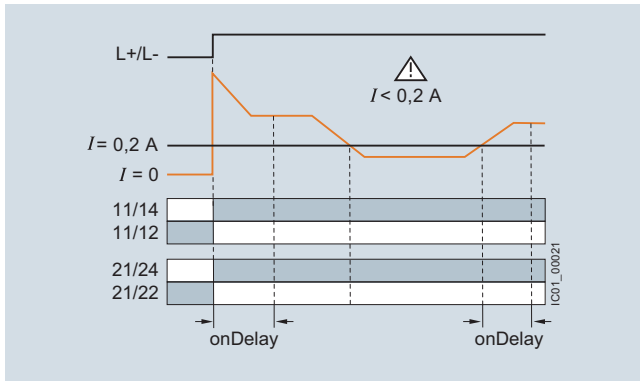

Undershooting of active current

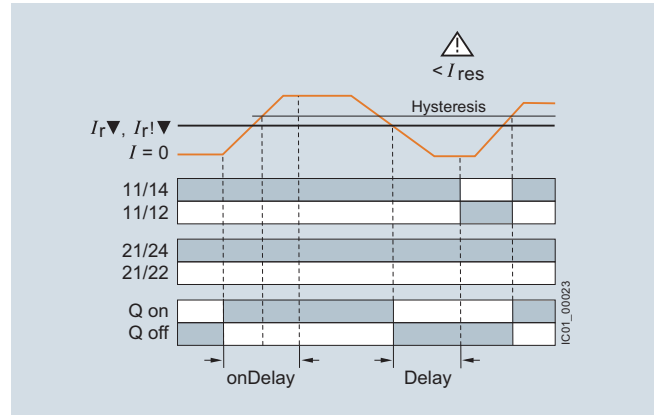

Range monitoring of active current

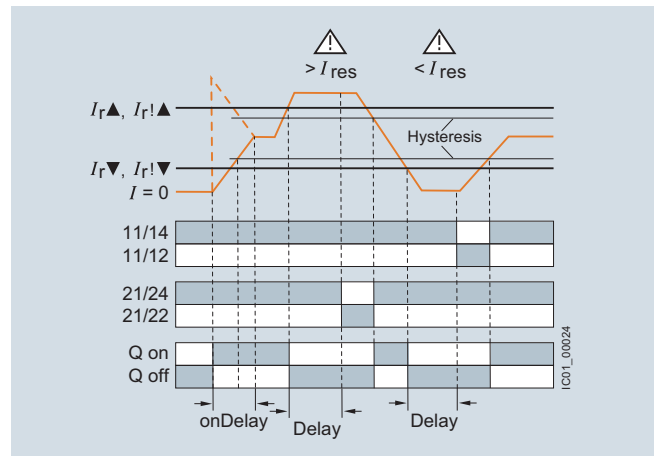

With the closed-circuit principle selected

Overshooting of power factor

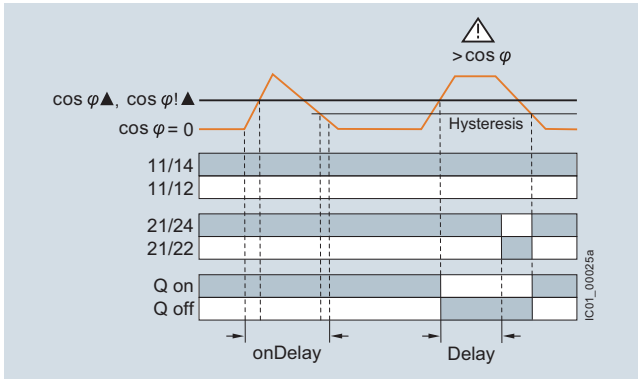

Range monitoring of power factor

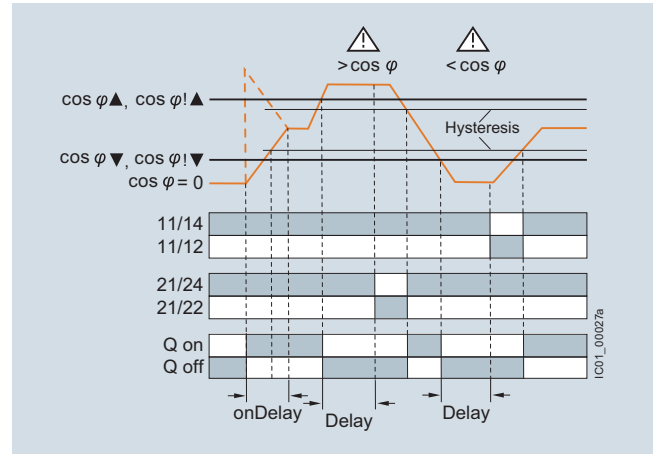

Undershooting of power factor

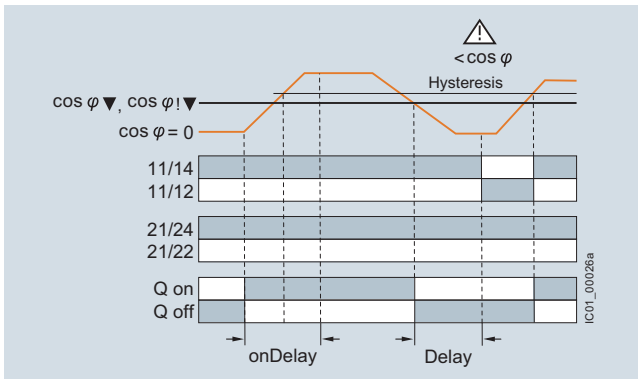

Type	3UG4841	
<b>General technical specifications</b>		
<b>Rated insulation voltage <math>U_i</math></b>	V	690
Pollution degree 2 Overvoltage category III according to IEC 60664-1		
<b>Rated impulse withstand voltage <math>U_{imp}</math></b>	kV	6
<b>Control circuit</b>		
<b>Number of CO contacts for auxiliary contacts</b>		2
<b>Load capacity of the output relay</b>		
• Thermal current $I_{th}$	A	5
<b>Rated operational current <math>I_e</math> at</b>		
• AC-15/24 ... 400 V	A	3
• DC-13 at		
- 24 V	A	1
- 125 V	A	0.2
- 250 V	A	0.1
<b>Minimum contact load at 17 V DC</b>	mA	5

# 3UG48 Monitoring Relays for Stand-Alone Installation for IO-Link

## Power factor and active current monitoring

### Selection and ordering data

- For monitoring the power factor and the active current  $I_{res}$  (p.f.  $\times I$ )
  - Suitable for single- and three-phase currents
  - Adjustable via IO-Link and locally, with illuminated LCD
  - Power supply with 24 V DC via IO-Link or external auxiliary voltage
  - Overshoot, undershoot or range monitoring adjustable
  - Upper and lower limit values can be adjusted separately
  - Permanent display of actual value and tripping state
  - 1 CO contact each for undershoot and overshoot, 1 semiconductor output (in SIO mode)
- PU (UNIT, SET, M) = 1  
 PKG\* = 1 UNIT



3UG4841-1CA40



3UG4841-2CA40

Measuring range		Voltage range of the measuring voltage <sup>1)</sup>	Hysteresis		ON-delay time adjustable onDel	Tripping delay time separately adjustable	SD	Screw terminals	SD	Spring-type terminals	
For power factor	For active current $I_{res}$	50/60 Hz AC	Adjustable for power factor	Adjustable for active current $I_{res}$	s	U $\Delta$ Del/ U $\nabla$ Del, $\phi$ $\Delta$ Del/ $\phi$ $\nabla$ Del	d	Article No.	Price per PU	Article No.	Price per PU
P.f.	A	V	P.f.	A	s	s	d				
<b>Monitoring of power factor and active current for overshooting or undershooting</b>											
0.1 ... 0.99	0.2 ... 10	90 ... 690	0.1 ... 0.2	0.1 ... 3	0 ... 999.9	0 ... 999.9	2	<b>3UG4841-1CA40</b>	2	<b>3UG4841-2CA40</b>	

<sup>1)</sup> Absolute limit values.

For accessories, see page 11/119.

For AC active currents  $I_{res} > 10$  A it is possible to use commercially available current transformers, e.g. Siemens 4NC current transformers, as accessories, see Catalog LV 10.



## Overview

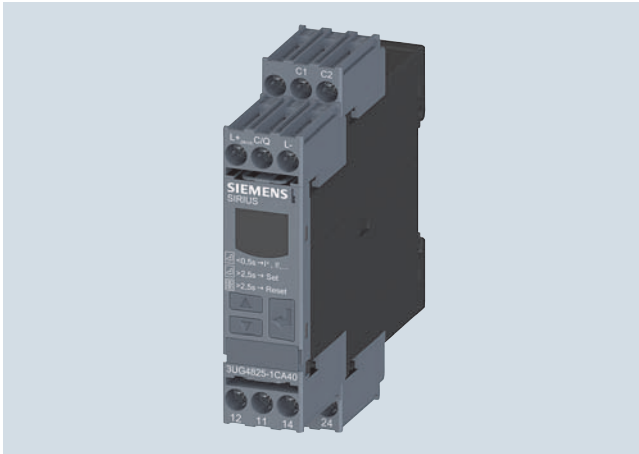

SIRIUS 3UG4825 monitoring relay

The 3UG4825 residual-current monitoring relays are used in conjunction with the 3UL23 residual-current transformers for monitoring plants in which higher residual currents are increasingly expected due to ambient conditions. Monitoring encompasses pure AC residual currents or AC residual currents with a pulsating DC fault current component (transformer type A in accordance with DIN VDE 0100-530/IEC TR 60755).

## Benefits

- High measuring accuracy of  $\pm 7.5\%$
- Permanent self-monitoring
- Parameterization of the devices locally or via IO-Link possible
- Variable threshold values for warning and disconnection
- Freely configurable delay times and RESET response
- Display and transmission of actual value and status messages to controller
- High level of flexibility and space saving through installation of the transformer inside or outside the control cabinet
- Width 22.5 mm
- All versions with removable terminals
- All versions with screw or spring-type terminals

## Application

Monitoring of plants in which residual currents can occur, e.g. due to dust deposits or moisture, porous cables and leads, or capacitive residual currents.

## Technical specifications

### 3UG4825 monitoring relays

The main conductor, and any neutral conductor to which a load is connected, are routed through the opening of the annular ring core of a residual-current transformer. A secondary winding is placed around this annular strip-wound core to which the monitoring relay is connected.

If operation of a plant is fault-free, the sum of the inflowing and outward currents equals zero. No current is then induced in the secondary winding of the residual-current transformer.

However, if an insulation fault occurs downstream of the residual current operated circuit breaker, the sum of the inflowing currents is greater than that of the outward currents. The differential current – the residual current – induces a secondary current in the secondary winding of the transformer. This current is evaluated in the monitoring relay and is used on the one hand to display the actual residual current and on the other, to switch the relay if the set warning or tripping threshold is overshoot.

If the measured residual current exceeds the set warning value, the associated changeover contact instantly changes the switching state and an indication appears on the display.

If the measured residual current exceeds the set tripping value, the set delay time begins and the associated relay symbol flashes. On expiry of this time, the associated changeover contact changes the switching state.

#### ON-delay time for motor start

To be able to start a drive when a residual current is detected, the output relays switch to the OK state for an adjustable ON-delay time depending on the selected open-circuit principle or closed-circuit principle.

The changeover contacts do not react if the set threshold values are overshoot during this period.

With the closed-circuit principle selected

Residual current monitoring with Auto RESET (Memory = no)

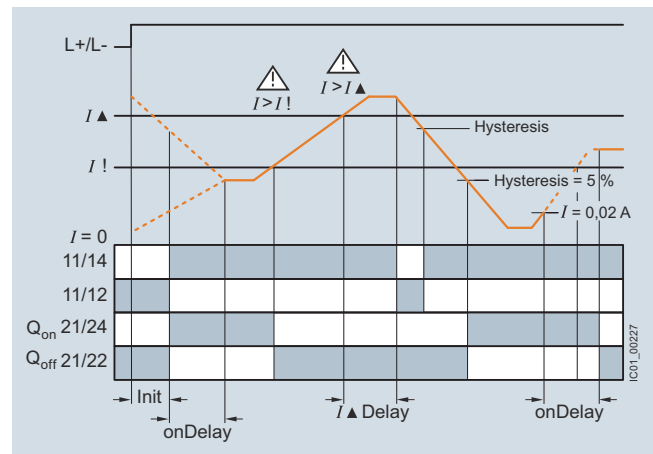

If the device is set to Auto RESET, the relay switches back to the OK state for the tripping value once the value falls below the set hysteresis threshold and the display stops flashing.

The associated relay changes its switching state if the value falls below the fixed hysteresis value of 5% of the warning value.

Any overshoots are therefore not stored.

## Residual-current monitoring relays

Residual current monitoring with Manual RESET (Memory = yes)

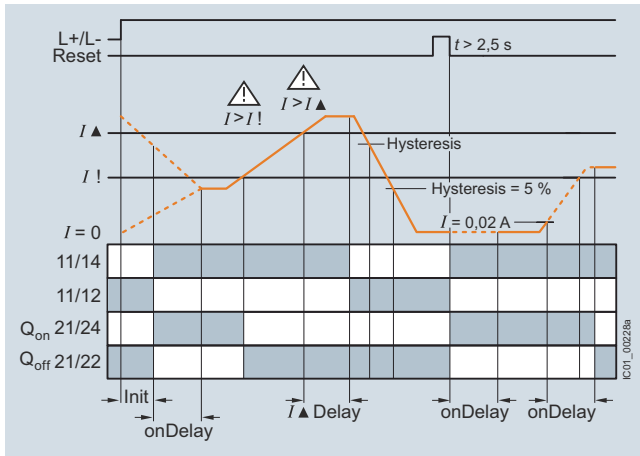

If Manual RESET is selected in the menu, the output relays remain in their current switching state and the current measured value and the symbol for overshooting continues to flash, even when the measured residual current returns to a permissible value. This stored fault status can be reset by simultaneously pressing the UP▲ and DOWN▼ keys for > 2 seconds, or by switching the supply voltage off and back on again.

**Note:**

The neutral conductor must not be grounded downstream of the summation current transformer as this may impair the function of the residual-current monitoring device.

Type	3UG4825-1CA40, 3UG4825-2CA40	
<b>General data</b>		
Insulation voltage for overvoltage category III to IEC 60664 for pollution degree 3 rated value	V	300
Impulse withstand voltage, rated value $U_{imp}$	kV	4
<b>Control circuit</b>		
Number of CO contacts for auxiliary contacts		2
Thermal current of the non-solid-state contact blocks, maximum	A	5
<b>Current carrying capacity of the output relay</b>		
• At AC-15 at 250 V at 50/60 Hz	A	3
• At DC-13		
- At 24 V	A	1
- At 125 V	A	0.2
- At 250 V	A	0.1
Operational current at 17 V, minimum	mA	5

# 3UG48 Monitoring Relays for Stand-Alone Installation for IO-Link

## Residual-current monitoring relays

### Selection and ordering data

- For monitoring residual currents from 0.03 to 40 A, from 16 to 400 Hz
- For 3UL23 residual-current transformers with feed-through opening from 35 to 210 mm
- Permanent self-monitoring
- Certified in accordance with IEC 60947, functionality corresponds to IEC 62020
- Digitally adjustable, with illuminated LCD
- Permanent display of actual value and tripping state
- Separately adjustable limit value and warning threshold
- 1 changeover contact each for warning threshold and tripping threshold



PU (UNIT, SET, M) = 1  
PS\* = 1 unit



3UG4825-1CA40



3UG4825-2CA40

Measurable current	Adjustable response value current	Switching hysteresis	Adjustable ON-delay time	Control supply voltage At DC rated value	SD	Screw terminals 	SD	Spring-type terminals 	
A	A	%	s	V	d	Article No.	Price per PU	Article No.	Price per PU
0.01 ... 43	0.03 ... 40	0 ... 50	0 ... 999.9	24	2	<b>3UG4825-1CA40</b>		<b>3UG4825-2CA40</b>	

For accessories, see page 11/119.

For 3UL23 residual-current transformers and accessories for 3UL23, see page 11/82.

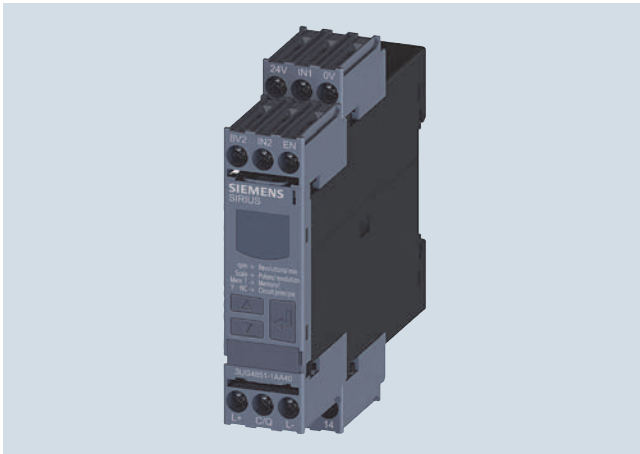
**Overview**

SIRIUS 3UG4851 monitoring relay

3UG4851 monitoring relays are used in combination with a sensor to monitor drives for overspeed and/or underspeed.

Furthermore, the monitoring relays are ideal for all functions where a continuous pulse signal needs to be monitored (e.g. belt travel monitoring, completeness monitoring, passing monitoring, clock-time monitoring).

**Benefits**

- Variably adjustable to overshoot, undershoot or range monitoring
- Freely configurable delay times and RESET response
- Display and transmission of actual value and fault type to controller
- Use of up to 10 sensors per rotation for extremely slowly rotating motors
- 2- or 3-wire sensors and sensors with a mechanical switching output or semiconductor output can be connected
- Auxiliary voltage for sensor integrated
- All versions with removable terminals
- All versions with screw or spring-type terminals

**Application**

- Slip or tear of a belt drive
- Overload monitoring
- Transport monitoring for completeness

**Technical specifications****3UG4851 monitoring relays**

The speed monitoring relay operates according to the principle of period duration measurement.

In the monitoring relay, the time between two successive rising edges of the pulse encoder is measured and compared to the minimum and/or maximum permissible period duration calculated from the set limit values for the speed.

Thus, the period duration measurement recognizes any deviation in speed after just two pulses, even at very low speeds or in the case of extended pulse gaps.

By using up to ten pulse encoders evenly distributed around the circumference, it is possible to shorten the period duration, and in turn the response time. By taking into account the number of sensors in the monitoring relay, the speed continues to be indicated in rpm.

**ON-delay time for motor start**

To be able to start a motor drive, and depending on whether the open-circuit or closed-circuit principle is selected, the output relay switches to the GO state during the ON-delay time, even if the speed is still below the set value.

The ON-delay time is started by either switching on the auxiliary voltage or, if the auxiliary voltage is already applied, by actuating the respective NC contact (e.g. auxiliary contact).

**Speed monitoring with Auto RESET (Memory = no)**

If the device is set to Auto RESET, the output relay switches to the GO state, once the adjustable hysteresis threshold is reached in the range of 1 to 99.9 rpm and the flashing stops. Any overshoots or undershoots are therefore not stored.

**Speed monitoring with Manual RESET (Memory = yes)**

If Manual RESET is selected in the menu, the output relay remains in its current switching state and the current measured value and the symbol for overshooting/undershooting continue to flash, even when the speed returns to a permissible value. This stored fault status can be reset by simultaneously pressing the UP▲ and DOWN▼ keys for > 2.5 s or by connecting the RESET device terminal to 24 V DC.

With Manual RESET through IO-Link it is possible in addition to set whether error signals are to be deleted when the control supply voltage is switched off and on (as remote RESET) or whether the signals are to be permanently saved even in a voltage failure, with confirmation possible only through local RESET or via IO-Link.

Speed monitoring

With the closed-circuit principle selected

Range monitoring without enable input

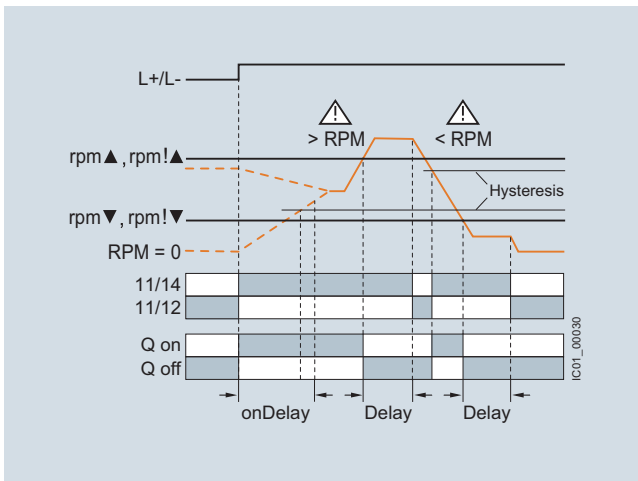

Range monitoring with enable input

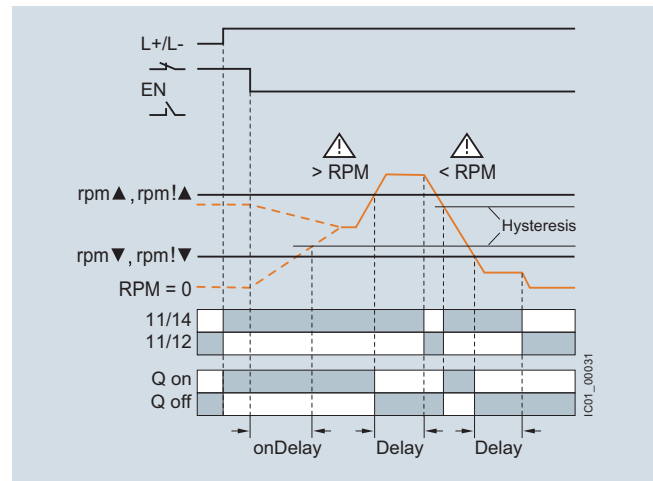

Type	3UG4851	
<b>General technical specifications</b>		
Rated insulation voltage $U_i$	V	300
Pollution degree 2 Overvoltage category III acc. to VDE 0110		
Rated impulse withstand voltage $U_{imp}$	kV	4
<b>Measuring circuit</b>		
<b>Sensor supply</b>		
• For 3-wire sensor (24 V/0 V)	mA	Max. 50
• For 2-wire NAMUR sensor (8V2)	mA	Max. 8.2
<b>Signal input</b>		
• IN1	kΩ	16, 3-wire sensor, pnp operation
• IN2	kΩ	1, floating contact, 2-wire NAMUR sensor
<b>Voltage level</b>		
• For level 1 at IN1	V	4.5 ... 30
• For level 0 at IN1	V	0 ... 1
<b>Current level</b>		
• For level 1 at IN2	mA	> 2.1
• For level 0 at IN2	mA	< 1.2
Minimum pulse duration of signal	ms	5
Minimum interval between 2 pulses	ms	5
<b>Control circuit</b>		
Number of CO contacts for auxiliary contacts		1
<b>Load capacity of the output relay</b>		
Thermal current $I_{th}$	A	5
<b>Rated operational current <math>I_o</math> at</b>		
• AC-15/24 ... 250 V	A	3
• DC-13 at		
- 24 V	A	1
- 125 V	A	0.2
- 250 V	A	0.1
Minimum contact load at 17 V DC	mA	5

# 3UG48 Monitoring Relays for Stand-Alone Installation for IO-Link

## Speed monitoring

### Selection and ordering data

- For speed monitoring in revolutions per minute (rpm)
  - Two- or three-wire sensor with mechanical or electronic switching output can be connected
  - Two-wire NAMUR sensor can be connected
  - Sensor supply 24 V DC/50 mA integrated
  - Input frequency 0.1 to 2 200 pulses per minute (0.0017 to 36.7 Hz)
  - With or without enable signal for the drive to be monitored
  - Adjustable via IO-Link and locally, with illuminated LCD
  - Power supply with 24 V DC via IO-Link or external auxiliary voltage
  - Overshoot, undershoot or range monitoring adjustable
  - Number of pulses per revolution can be adjusted
  - Upper and lower limit values can be adjusted separately
  - Auto, manual or remote RESET options after tripping
  - Permanent display of actual value and tripping state
  - 1 CO contact, 1 semiconductor output (in SIO mode)
- PU (UNIT, SET, M) = 1  
 PKG\* = 1 UNIT



3UG4851-1AA40





3UG4851-2AA40

Measuring range	Adjustable hysteresis	ON-delay time adjustable onDel	Tripping delay time separately adjustable rpm▲Del/rpm▼Del	Pulses per revolution	SD	Screw terminals	SD	Spring-type terminals	
rpm	rpm	s	s		d	Article No.	Price per PU	Article No.	Price per PU
<b>Speed monitoring for overshooting and undershooting</b>									
0.1 ... 2 200	OFF 1 ... 99.9	0 ... 999.9	0 ... 999.9	1 ... 10	2	<b>3UG4851-1AA40</b>	2	<b>3UG4851-2AA40</b>	

For accessories, see page 11/119.

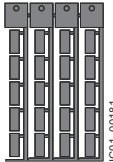
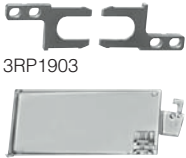
**Selection and ordering data**

Use	Version	SD	Article No.	Price per PU	PU (UNIT, SET, M)	PS*
<b>Blank labels</b>						
 3RT2900-1SB20	For 3UG48					
		<b>Unit labeling plates</b> For SIRIUS devices 20 mm x 7 mm, titanium gray	20	<b>3RT2900-1SB20</b>		100 340 units
	For 3UG48	<b>Adhesive labels</b> for SIRIUS devices • 19 mm x 6 mm, pastel turquoise • 19 mm x 6 mm, zinc yellow	15 15	<b>3RT1900-1SB60</b> <b>3RT1900-1SD60</b>		100 3 060 units 100 3 060 units
<b>Push-in lugs and covers</b>						
 3RP1903  3RP1902	For 3UG48					
		<b>Push-in lugs</b> For screw fixing, 2 units are required for each device	5	<b>3RP1903</b>		1 10 units
	For 3UG48	<b>Sealable covers</b> For securing against unauthorized adjustment of setting knobs	5	<b>3RP1902</b>		1 5 units
<b>Tools for opening spring-type terminals</b>						
 3RA2908-1A	For auxiliary circuit connections					
		<b>Screwdrivers</b> For all SIRIUS devices with spring-type terminals 3.0 mm x 0.5 mm, length approx. 200 mm, titanium gray/black, partially insulated	2	<b>3RA2908-1A</b>		1 1 unit

## Overview



SIRIUS 3RQ3 coupling relays

SIRIUS 3RQ3 coupling relays in narrow design are used for coupling control signals from and to a controller, and they are available in different versions:

- Coupling relays with relay output (not plug-in)
- Coupling relays with plug-in relays
- Coupling relays with semiconductor output (not plug-in)

**Coupling relays with relay output (not plug-in)****AC and DC operation**

IEC/EN 60947-5-1

The input and output coupling relays differ with regard to the positioning of the terminals and the LEDs.

**Coupling relays with plug-in relays****AC and DC operation**

IEC 60947-1

The coupling relays are plug-in, so the relay can be replaced quickly at the end of its service life without detaching the wiring.

**Coupling relays with semiconductor output (not plug-in)****AC and DC operation**

IEC 60947-1, EN 60664-1 and EN 50005;  
coupling relays with semiconductor output: EN 60747-5;  
programmable controllers: IEC 61131-2

The input and output coupling relays differ with regard to the positioning of the terminals and the LEDs.

The coupling relays with semiconductor output have extremely high contact reliability, so they are especially suitable for electronic systems.

For test purposes, versions are available with manual-0-automatic switches.



**Article No. scheme**

Product versions		Article number	
<b>Coupling relays with relay output (not plug-in)</b>		<b>3RQ30</b> □ 8 – □ A □ 0 □	
Design and type of output	Output coupler, without manual/automatic switch	1	
	Input coupler	3	
Type of electrical connection	Screw terminals	1	
	Spring-type terminals (push-in)	2	
Control supply voltage	24 V AC/DC		B
	115 V AC/DC		E
	230 V AC/DC		F
Material of switching contacts	e.g.		
	0 = AgSnO2		□
	1 = AgSnO2 hard gold-plated		□
Example		<b>3RQ30 1 8 – 1 A B 0 1</b>	

Product versions		Article number	
<b>Coupling relays with relay output (not plug-in)</b>		<b>3RQ30 1 8 – 2 A</b> □ 0 8 – 0 A A 0	
Railway version with extended operating range 0.7 ... 1.2 x U <sub>s</sub>			
Control supply voltage	24 V DC		M
	110 V DC		N
Example		<b>3RQ30 1 8 – 2 A M 0 8 – 0 A A 0</b>	

Product versions		Article number	
<b>Coupling relays with plug-in relays</b>		<b>3RQ31 1 8 –</b> □ A □ 0 □	
Type of electrical connection	Screw terminals	1	
	Spring-type terminals (push-in)	2	
Control supply voltage	24 V AC/DC		B
	115 V AC/DC		E
	230 V AC/DC		F
	24 V DC		M
Material of switching contacts	AgSnO2		0
	AgSnO2 hard gold-plated		1
Example		<b>3RQ31 1 8 – 1 A B 0 1</b>	

Product versions		Article number		Control supply voltage	Switching voltage of the semiconductor output
<b>Coupling relays with semiconductor output (not plug-in)</b>		<b>3RQ30</b> □ □ – □ S □ □ 0			
	Current carrying capacity of the semiconductor output				
Output coupler	• Without manual/automatic switch	1 mA ... 0.5 A	<b>3RQ30 5 0 –</b> □ S M 5 0	11 ... 30 V DC	10 ... 60 V DC
		5 mA ... 2 A	<b>3RQ30 5 2 –</b> □ S M 3 0	11 ... 30 V DC	10 ... 30 V DC
		1 mA ... 2 A	<b>3RQ30 5 2 –</b> □ S M 4 0	11 ... 30 V DC	10 ... 60 V DC
		5 mA ... 2 A	<b>3RQ30 5 2 –</b> □ S M 5 0	11 ... 30 V DC	20 ... 264 V AC
	• With manual/automatic switch	1 mA ... 3 A	<b>3RQ30 5 3 –</b> □ S G 3 0	110 ... 230 V AC/DC	10 ... 30 V DC
		5 mA ... 5 A	<b>3RQ30 5 5 –</b> □ S M 3 0	11 ... 30 V DC	10 ... 30 V DC
		5 mA ... 5 A	<b>3RQ30 6 5 –</b> □ S M 3 0	11 ... 30 V DC	10 ... 30 V DC
		Input coupler	10 mA ... 0.5 A	<b>3RQ30 7 0 –</b> □ S B 3 0	11 ... 30 V AC/DC
		<b>3RQ30 7 0 –</b> □ S G 3 0	110 ... 230 V AC/DC	10 ... 30 V DC	
Type of electrical connection	Screw terminals			1	
	Spring-type terminals (push-in)			2	
Example		<b>3RQ30 7 0 – 1 S B 3 0</b>			

**Note:**

These Article No. schemes show an overview of product versions for better understanding of the logic behind the article numbers.

For your orders, please use the article numbers quoted in the selection and ordering data.

**Benefits****General**

- All versions with screw terminals or spring-type terminals (push-in technology)
- TOP wiring with spring-type terminals (push-in) for quick and reliable wiring
- Low space requirements in the control cabinet thanks to a consistent width of 6.2 mm
- Reduced inventory due to fewer variants
- Clearly visible functional state of the coupling relay by green LED
- Integrated reverse polarity protection and EMC arc-suppression diode
- Standardized accessories across the entire 3RQ3 series
- Universal bridging option using connecting combs for all terminals
- Galvanic isolation plate for isolating different voltages for neighboring units
- Clip-on labels available as set for individual labeling

**Coupling relays with relay output (not plug-in)**

- Relays fixed in enclosure for increased contact reliability
- Device variants with hard gold-plated contacts, hence high contact reliability at low currents

**Coupling relays with plug-in relays**

- Fast replacement of the relays with existing wiring
- Shorter installation times thanks to certified complete units
- Individual relays available as spare parts
- Device variants with hard gold-plated contacts, hence high contact reliability at low currents

**Coupling relays with semiconductor output (not plug-in)**

- Long service life since there is no mechanical wear
- High switching frequency thanks to short make-break times
- Vibration-resistant
- No contact bounce
- Extremely high contact reliability
- Noise-free switching
- Low control power required
- Switching of DC and capacitive loads

**Application**

- Electrical separation between the input and output circuit
- Adjustment of different signal levels
- Signal amplification

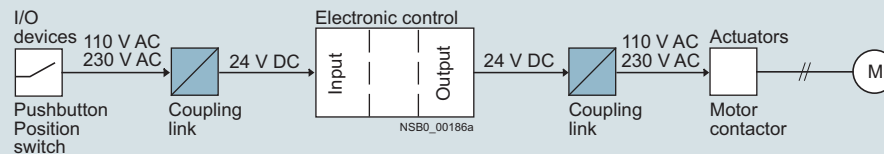

Application example motor controller

## Technical specifications

## More information

Technical specifications, see  
<https://support.industry.siemens.com/cs/ww/en/ps/16198/td>  
 FAQs, see <https://support.industry.siemens.com/cs/ww/en/ps/16198/faq>

Operating instructions, see  
<https://support.industry.siemens.com/cs/ww/en/ps/16198/man>

## Coupling relays with relay output (not plug-in)

Article number	3RQ30.8- .AB00	3RQ30.8- .AB01	3RQ30.8- .AE00	3RQ30.8- .AE01	3RQ30.8- .AF00	3RQ30.8- .AF01	3RQ3018- 2AM08-0AA0	3RQ3018- 2AN08-0AA0
----------------	-------------------	-------------------	-------------------	-------------------	-------------------	-------------------	------------------------	------------------------

## General technical specifications

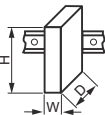
<b>Width x height x depth</b>		mm	6.2 x 93 x 72.5					
<b>Insulation voltage for overvoltage category III acc. to IEC 60664 for pollution degree 3</b>	V	300						
<b>Max. permissible voltage for protective separation between control circuit and auxiliary circuit</b>	V	300						
<b>Ambient temperature</b>								
• During operation	°C	-25 ... +60		-40 ... +70				
• During storage	°C	-40 ... +85						
<b>Degree of protection</b>	IP20							
<b>Version of the fuse link required for short-circuit protection of the auxiliary switch</b>	Fuse gG: 4 A							
<b>Operational current of the auxiliary contacts</b>								
• At AC-15								
- At 24 V	A	3						
- At 250 V	A	3						
• At DC-13								
- At 24 V	A	1						
- At 125 V	A	0.2						
- At 250 V	A	0.1						
<b>Contact reliability of the auxiliary contacts</b> (one contact failure per 100 million)		17 V, 5 mA	5 V, 1 mA	17 V, 5 mA	5 V, 1 mA	17 V, 5 mA	5 V, 1 mA	17 V, 5 mA
<b>Mechanical endurance (operating cycles) typical</b>	10 000 000							
<b>Electrical endurance (operating cycles) for AC-15 at 230 V typical</b>	100 000							
<b>Operating range factor of the control supply voltage, rated value</b>								
• At AC								
- At 50 Hz		0.8 ... 1.25		0.8 ... 1.1			--	
- At 60 Hz		0.8 ... 1.25		0.8 ... 1.1			--	
• At DC		0.8 ... 1.25		0.8 ... 1.1			0.7 ... 1.25	
<b>Active power input</b>	W	0.3	0.5	1			0.3	0.6
<b>Thermal current</b>	A	6						

## Coupling Relays

# Coupling Relays – Narrow Design

3RQ3



RELAYS, INTERFACES & CONVERTERS

11

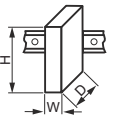
### Coupling relays with plug-in relay

Article number	3RQ3118-.AB00	3RQ3118-.AB01	3RQ3118-.AE00	3RQ3118-.AE01	3RQ3118-.AF00	3RQ3118-.AF01	3RQ3118-.AM00	3RQ3118-.AM01	
<b>General technical specifications</b>									
Width x height x depth			mm	6.2 x 93 x 76					
Insulation voltage for overvoltage category III acc. to IEC 60664 for pollution degree 3	V	300							
Max. permissible voltage for protective separation between control circuit and auxiliary circuit	V	300							
<b>Ambient temperature</b>									
• During operation	°C	-25 ... +60							
• During storage	°C	-40 ... +85							
<b>Degree of protection</b>		IP20							
<b>Version of the fuse link required for short-circuit protection of the auxiliary switch</b>		Fuse gG: 4 A							
<b>Operational current of the auxiliary contacts</b>									
• At AC-15									
- At 24 V	A	3							
- At 250 V	A	3							
• At DC-13									
- At 24 V	A	1							
- At 125 V	A	0.2							
- At 250 V	A	0.1							
<b>Contact reliability of the auxiliary contacts</b> (one contact failure per 100 million)		17 V, 5 mA	5 V, 1 mA	17 V, 5 mA	5 V, 1 mA	17 V, 5 mA	5 V, 1 mA	17 V, 5 mA	5 V, 1 mA
<b>Mechanical endurance (operating cycles) typical</b>		10 000 000							
<b>Electrical endurance (operating cycles) for AC-15 at 230 V typical</b>		100 000							
<b>Operating range factor of the control supply voltage, rated value</b>									
• At AC									
- At 50 Hz		0.8 ... 1.25		0.8 ... 1.1				--	
- At 60 Hz		0.8 ... 1.25		0.8 ... 1.1				--	
• At DC		0.8 ... 1.25		0.8 ... 1.1			0.8 ... 1.25		
<b>Active power input</b>	W	0.3		0.5		1		0.3	
<b>Thermal current</b>	A	6							

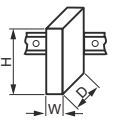
## Coupling relays with semiconductor output (not plug-in)

Article number	3RQ3050- .SM50	3RQ3052- .SM30	3RQ3052- .SM40	3RQ3052- .SM50	3RQ3053- .SG30	3RQ3055- .SM30	3RQ3065- .SM30	3RQ3070- .SB30	3RQ3070- .SG30
<b>General technical specifications</b>									
<b>Width x height x depth</b>							6.2 x 93 x 75	6.2 x 93 x 72.5	
<b>Insulation voltage for overvoltage category III acc. to IEC 60664 for pollution degree 3</b>	V	50			300	50		--	
<b>Ambient temperature</b>									
• During operation	°C	-25 ... +60							
• During storage	°C	-40 ... +85							
<b>Degree of protection</b>		IP20							
<b>Switching voltage of the semiconductor output</b>									
• At AC	V	--			20 ... 264	--			
• At DC	V	10 ... 60	10 ... 30	10 ... 60	--	10 ... 30			
<b>Current carrying capacity of the semiconductor output</b>									
• At AC		--			5 mA ... 2 A	--			
• At DC		1 mA ... 0.5 A	5 mA ... 2 A	1 mA ... 2 A	--	1 mA ... 3 A	5 mA ... 5 A	10 mA ... 0.5 A	
<b>Operating range factor of the control supply voltage, rated value</b>									
• At AC									
- At 50 Hz		--				1 ... 1	--	1 ... 1	
- At 60 Hz		--				1 ... 1	--	1 ... 1	
• At DC		1 ... 1							
<b>Active power input</b>	W	0.3				0.25	0.3	0.5	
<b>Thermal current</b>	A	0.5	2				3	5	0.5
Article number	<b>3RQ3...-1....</b>					<b>3RQ3...-2....</b>			
<b>Type of electrical connection for auxiliary and control circuits</b>	 Screw terminals					 Spring-type terminals (push-in)			
<b>Type of connectable conductor cross-sections</b>									
• Solid	1x (0.25 ... 2.5) mm <sup>2</sup>								
• Finely stranded									
- Without end sleeves	--					1x (0.25 ... 2.5) mm <sup>2</sup>			
- With end sleeves	1x (0.25 ... 1.5) mm <sup>2</sup>								
• Solid for AWG cables	1x (20 ... 14)								

Selection and ordering data

Type of voltage	Control supply voltage			Number of CO contacts for auxiliary contacts	Material of switching contacts	SD	Article No.	Price per PU	PU (UNIT, SET, M)	PS*
	At AC		At DC							
	At 50 Hz	At 60 Hz	V							

Coupling relays with relay output (not plug-in)

Output coupling links

AC/DC	24	24	24	1	AgSnO2	2	3RQ3018-□AB00	1	5 units
					AgSnO2 hard gold-plated	2	3RQ3018-□AB01		
	115	115	115	1	AgSnO2	2	3RQ3018-□AE00	1	5 units
	230	230	230	1	AgSnO2	2	3RQ3018-□AF00	1	5 units
DC	--	--	24	1	AgSnO2	2	3RQ3018-2AM08-0AA0	1	5 units
			110	1	AgSnO2	2	3RQ3018-2AN08-0AA0	1	5 units

Input coupling links

AC/DC	24	24	24	1	AgSnO2	2	3RQ3038-□AB00	1	5 units
					AgSnO2 hard gold-plated	2	3RQ3038-□AB01		
	115	115	115	1	AgSnO2	2	3RQ3038-□AE00	1	5 units
	230	230	230	1	AgSnO2	2	3RQ3038-□AF00	1	5 units
DC	--	--	24	1	AgSnO2	2	3RQ3038-□AF01	1	5 units
			110	1	AgSnO2 hard gold-plated	2	3RQ3038-□AF01	1	5 units

Coupling relays with plug-in relay

Output coupling links

AC/DC	24	24	24	1	AgSnO2	2	3RQ3118-□AB00	1	5 units
					AgSnO2 hard gold-plated	2	3RQ3118-□AB01		
	115	115	115	1	AgSnO2	2	3RQ3118-□AE00	1	5 units
	230	230	230	1	AgSnO2	2	3RQ3118-□AF00	1	5 units
DC	--	--	24	1	AgSnO2	2	3RQ3118-□AF01	1	5 units
			110	1	AgSnO2 hard gold-plated	2	3RQ3118-□AM00	1	5 units
DC	--	--	24	1	AgSnO2	2	3RQ3118-□AM01	1	5 units
			110	1	AgSnO2 hard gold-plated	2	3RQ3118-□AM01	1	5 units

Type of electrical connection

- Screw terminals
- Spring-type terminals (push-in)

Type of voltage	Control supply voltage			Current carrying capacity of the semiconductor output		Operating mode selectable via switch position	SD	Article No.	Price per PU	PU (UNIT, SET, M)	PS*
	At AC		At DC	At AC	At DC						
	At 50 Hz	At 60 Hz	V	A	A						

Coupling relays with semiconductor output (not plug-in)

Output coupling links

DC	--	--	11 ... 30 V	--	1 mA ... 0.5 A	--	2	3RQ3050-□SM50	1	5 units		
					5 mA ... 2 A	--	2	3RQ3052-□SM30			1	5 units
					1 mA ... 2 A	--	2	3RQ3052-□SM40			1	5 units
					5 mA ... 2 A	--	2	3RQ3052-□SM50			1	5 units
					5 mA ... 5 A	--	2	3RQ3055-□SM30			1	5 units
					Manual/Off/Automatic	--	2	3RQ3065-□SM30			1	5 units
AC/DC	110 ... 230 V	110 ... 230 V	110 ... 230 V	--	1 mA ... 3 A	--	2	3RQ3053-□SG30	1	5 units		





Input coupling links

AC/DC	11 ... 30 V	11 ... 30 V	11 ... 30 V	--	10 mA ... 0.5 A	--	2	3RQ3070-□SB30	1	5 units
AC/DC	110 ... 230 V	110 ... 230 V	110 ... 230 V	--	10 mA ... 0.5 A	--	2	3RQ3070-□SG30	1	5 units

Type of electrical connection

- Screw terminals
- Spring-type terminals (push-in)

Accessories

Version	SD	Article No.	Price per PU	PU (UNIT, SET, M)	PS*
<b>Galvanic isolation plates</b>					
 3RQ3900-0A	d	3RQ3900-0A		1	10 units
For electrical separation of different potentials when devices of different types are installed side by side					
<b>Connecting combs</b>					
 3RQ3901-0B					
For linking the same potentials, current carrying capacity for infeed max. 6 A					
	2	3RQ3901-0A		1	10 units
	2	3RQ3901-0B		1	10 units
	2	3RQ3901-0C		1	10 units
	2	3RQ3901-0D		1	10 units
<b>Clip-on labels<sup>1)</sup></b>					
 3RQ3902-0A					
For terminal and equipment labeling, white					
	2	3RQ3902-0A		100	2 000 units
	2	3RQ3902-0B		100	1 200 units
<b>Tools for opening spring-type terminals</b>					
 3RA2908-1A					
<b>Screwdriver</b> For all SIRIUS devices with spring-type terminals; 3,0 mm x 0.5 mm, length approx. 200 mm, titanium gray/black, partially insulated					
	2	3RA2908-1A		1	1 unit

<sup>1)</sup> PC labeling system for individual inscription of unit labeling plates available from Conta-Clip Verbindungstechnik GmbH (see page 16/16).

Coupling relays with plug-in relay	Control supply voltage	Material of switching contacts	Number of CO contacts for auxiliary contacts	SD	Article No.	Price per PU	PU (UNIT, SET, M)	PS*
Type	V			d				
<b>Replacement modules for 3RQ3118 coupling relays with plug-in relay</b>								
3RQ3118-.AM00	24 DC	AgSnO2	1	2	3TX7014-7BM00		1	15 units
3RQ3118-.AM01		AgSnO2 hard gold-plated		2	3TX7014-7BM02		1	15 units
3RQ3118-.AB00	24 AC/DC	AgSnO2	1	2	3TX7014-7BM00		1	15 units
3RQ3118-.AB01		AgSnO2 hard gold-plated		2	3TX7014-7BM02		1	15 units
3RQ3118-.AE00	115 AC/DC	AgSnO2	1	2	3TX7014-7BP00		1	15 units
3RQ3118-.AF00	230 AC/DC	AgSnO2						
3RQ3118-.AE01	115 AC/DC	AgSnO2 hard gold-plated	1	2	3TX7014-7BP02		1	15 units
3RQ3118-.AF01	230 AC/DC	AgSnO2 hard gold-plated						

## Overview



SIRIUS 3RQ2 coupling relays, screw terminals, 3 changeover contacts

### More information

Homepage, see [www.usa.siemens.com/relays](http://www.usa.siemens.com/relays)

Industry Mall, see [www.siemens.com/product?3RQ2](http://www.siemens.com/product?3RQ2)

For the conversion tool, e.g. from 3RS18 to 3RQ2, see [www.siemens.com/sirius/conversion-tool](http://www.siemens.com/sirius/conversion-tool)

3RQ2 coupling relays in their 22.5 mm industrial enclosure serve to couple control signals to and from a controller and replace the 3RS18 coupling relays. The 3RQ2 has an impressively high-quality industrial enclosure finished in modern titanium gray so that it fits in visually with the SIRIUS series of relays.

The series consists of devices with up to three changeover contacts with screw or spring-type terminals (push-in) and, with its wide voltage range from 24 to 240 V AC/DC, is a genuine highlight in the coupling relay market.

Thanks to terminal assignment that is identical to the previous version, existing products can easily be converted.

The reduced variety of components simplifies product selection and standardization.

Numerous accessories are available for the 3RQ2 coupling relays, for example replacement terminals, push-in lugs for wall mounting and coding pins.

### Article No. scheme

Product versions		Article number			
<b>Coupling relays, standard</b>		<b>3RQ2000</b> – □ □ □ 0 □			
Connection methods	Screw terminals	1			
	Spring-type terminals (push-in)	2			
Outputs	1 CO contact		A		
	2 CO contacts		B		
	3 CO contacts		C		
Rated control supply voltage	24 ... 240 V AC/DC		W		
Material of switching contacts	0 = AgSnO2				0
	1 = AgNi +Au				1
Example		<b>3RQ2000</b> – 1 C W 0 1			

### Note:

The Article No. scheme shows an overview of product versions for better understanding of the logic behind the article numbers.

For your orders, please use the article numbers quoted in the selection and ordering data.

### Benefits

- Permanent wiring thanks to removable terminals in screw or spring-type technology (push-in)
- Replacement of individual terminals minimizes wiring effort
- A product for all voltages from 24 to 240 V AC/DC
- Reduced costs thanks to fewer versions
- Especially high contact reliability even at low currents thanks to versions with hard gold-plated contacts
- International standards and certifications including CE, UL/CSA, EAC and confirmations for rail, and more

### Application

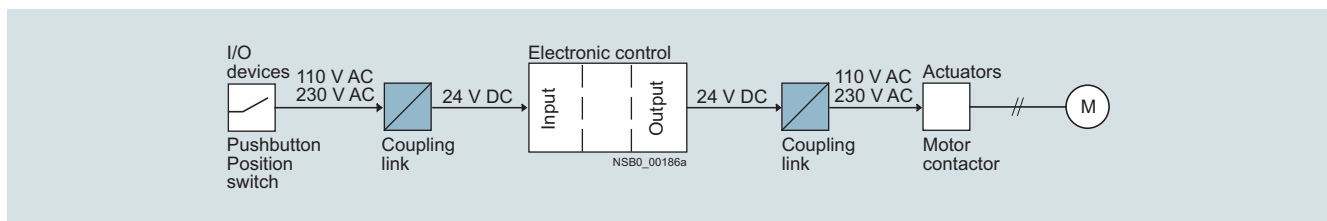

- Electrical separation between the input and output circuit
- Adjustment of different signal levels
- Signal amplification
- Contact multiplication



Application example motor controller

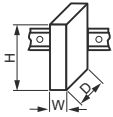

## Technical specifications

More information		
Technical specifications, see <a href="https://support.industry.siemens.com/cs/ww/en/ps/25158/td">https://support.industry.siemens.com/cs/ww/en/ps/25158/td</a>	Operating instructions, see <a href="https://support.industry.siemens.com/cs/ww/en/ps/25158/man">https://support.industry.siemens.com/cs/ww/en/ps/25158/man</a>	
Type	<b>3RQ2000-AW00</b> <b>3RQ2000-BW00</b> <b>3RQ2000-CW00</b>	<b>3RQ2000-CW01</b>
General data		
<b>Dimensions (W x H x D)</b>	 mm	22.5 x 100 x 90
<b>Insulation voltage for overvoltage category III acc. to IEC 60664 for pollution degree 3</b>	V	300
<b>Max. permissible voltage for protective separation between control circuit and auxiliary circuit acc. to IEC 60947-1</b>	V	300
<b>Ambient temperature</b>		
• During operation	°C	-25 ... +60
• During storage	°C	-40 ... +80
<b>Degree of protection</b>	IP20	
Control circuit		
<b>Control supply voltage</b>	V	24 ... 240 AC/DC; 50/60 Hz
<b>Operating range factor of control supply voltage</b>	0.7 ... 1.1	
Load circuit		
<b>Thermal current of the non-solid-state contact blocks, maximum</b>	A	5
<b>Current carrying capacity of the output relay</b>		
• At AC-15 at 250 V	A	3
• At DC-13 at 24 V	A	1
• At DC-13 at 125 V	A	0.2
• At DC-13 at 250 V	A	0.1
<b>Mechanical endurance (operating cycles) typical</b>	10 000 000	
<b>Electrical endurance (operating cycles) for AC-15 at 230 V, typical</b>	100 000	
<b>Material of switching contacts</b>	AgSnO2	AgNi + Au
Article number	<b>3RQ2000-1</b>	<b>3RQ2000-2</b>
<b>Type of electrical connection</b>	 <b>Screw terminals</b>	 <b>Spring-type terminals (push-in)</b>
<b>Type of connectable conductor cross-sections</b>		
• Solid	mm <sup>2</sup>	1x (0.5 ... 4.0 mm <sup>2</sup> ), 2x (0.5 ... 2.5 mm <sup>2</sup> )
• Finely stranded with end sleeve	mm <sup>2</sup>	1x (0.5 ... 4 mm <sup>2</sup> ), 2x (0.5 ... 1.5 mm <sup>2</sup> )
• Solid for AWG cables	AWG	1x (20 ... 12), 2x (20 ... 14)
<b>Tightening torque</b>	Nm	0.6 ... 0.8



## Coupling Relays

# Coupling Relays with Industrial Enclosure

SIRIUS 3RQ2 **NEW**

### Selection and ordering data

PU (UNIT, SET, M) = 1  
PS\* = 1 UNIT

	Control supply voltage		Number of CO contacts for auxiliary contacts	Material of switching contacts	SD	Screw terminals 		Spring-type terminals (push-in) 					
	at AC at 50 Hz	At DC				Article No.	Price per PU	Article No.	Price per PU				
	V	V	W		d								
<b>Coupling relays in industrial enclosure, 22.5 mm</b>													
 3RQ2000-1CW00	24 ... 240	24 ... 240	1	AgSnO2	2	2	3RQ2000-1AW00	2	3RQ2000-2AW00	2			
			2	AgSnO2	2						3RQ2000-1BW00	2	3RQ2000-2BW00
			3	AgSnO2	2						3RQ2000-1CW00	2	3RQ2000-2CW00
			3	AgNi + Au	2						3RQ2000-1CW01	2	3RQ2000-2CW01

### Accessories

#### More information

Operating instructions, see <https://support.industry.siemens.com/cs/ww/en/ps/25158/man>



Conversion tool, e.g. from 3RS18 to 3RQ2, see [www.siemens.com/sirius/conversion-tool](http://www.siemens.com/sirius/conversion-tool)

Version	SD	Article No.	Price per PU	PU (UNIT, SET, M)	PS*
	d				



#### Terminals for SIRIUS devices in the industrial standard mounting rail enclosure

 3ZY1122-1BA00	Removable terminals	SD	Screw terminals 		PU (UNIT, SET, M)	PS*
			Article No.	Price per PU		
	• 2-pole, up to 1 x 4 mm <sup>2</sup> or 2 x 2.5 mm <sup>2</sup>	2	3ZY1122-1BA00	1	6 units	
	• 2-pole, up to 1 x 4 mm <sup>2</sup> or 2 x 1.5 mm <sup>2</sup>	2	3ZY1122-2BA00	1	6 units	

#### Accessories for enclosures

 3ZY1450-1AB00	<b>Hinged cover</b> replacement cover, without terminal labeling, titanium gray, 22.5 mm wide	2	3ZY1450-1AB00	1	5 units
 3ZY1311-0AA00	<b>Push-in lugs</b> For wall mounting	2	3ZY1311-0AA00	1	10 units
 3ZY1440-1AA00	<b>Coding pins</b> For removable terminals of SIRIUS devices in the industrial standard mounting rail enclosure; they enable the mechanical coding of terminals	2	3ZY1440-1AA00	1	12 units

#### Tools for opening spring-type terminals

 3RA2908-1A	<b>Screwdrivers</b> For all SIRIUS devices with spring-type terminals 3.0 mm x 0.5 mm, length approx. 200 mm, titanium gray/black, partially insulated	2	<b>Spring-type terminals (push-in) </b> 3RA2908-1A	1	1 unit
---	--	---	--	---	--------

**More information****Code conversion table**

SIRIUS 3RS18 coupling relays				Comparison type SIRIUS 3RQ2 coupling relays			
Screw terminals	Spring-type terminals	Version	Contacts	Screw terminals	Spring-type terminals (push-in)	Version	Contacts
3RS1800-1AQ00	3RS1800-2AQ00	24 V AC/DC; 110 ... 120 V AC	1 CO contact	3RQ2000-1AW00	3RQ2000-2AW00	24 ... 240 V AC/DC	1 CO contact
3RS1800-1AP00	3RS1800-2AP00	24 V AC/DC; 220 ... 240 V AC	2 CO contacts	3RQ2000-1BW00	3RQ2000-2BW00	24 ... 240 V AC/DC	2 CO contacts
3RS1800-1BW00	3RS1800-2BW00	24 ... 240 V AC/DC					
3RS1800-1BQ00	3RS1800-2BQ00	24 V AC/DC; 110 ... 120 V AC					
3RS1800-1BP00	3RS1800-2BP00	24 V AC/DC; 220 ... 240 V AC	3 CO contacts	3RQ2000-1CW00	3RQ2000-2CW00	24 ... 240 V AC/DC	3 CO contacts
3RS1800-1HW00	3RS1800-2HW00	24 ... 240 V AC/DC					
3RS1800-1HQ00	3RS1800-2HQ00	24 V AC/DC; 110 ... 120 V AC					
3RS1800-1HP00	3RS1800-2HP00	24 V AC/DC; 220 ... 240 V AC	3 CO contacts, hard gold-plated	3RQ2000-1CW01	3RQ2000-2CW01	24 ... 240 V AC/DC	3 CO contacts, hard gold-plated
3RS1800-1HW01	3RS1800-2HW01	24 ... 240 V AC/DC					
3RS1800-1HQ01	3RS1800-2HQ01	24 V AC/DC; 110 ... 120 V AC					
3RS1800-1HP01	3RS1800-2HP01	24 V AC/DC; 220 ... 240 V AC					

### Overview



SIRIUS 3RS70 signal converters

#### More information

Homepage, see [www.usa.siemens.com/relays](http://www.usa.siemens.com/relays)  
 Industry Mall, see [www.siemens.com/product?3RS70](http://www.siemens.com/product?3RS70)  
 For the conversion tool, e.g. from 3RS17 to 3RS70, see [www.siemens.com/sirius/conversion-tool](http://www.siemens.com/sirius/conversion-tool)

Signal converters perform the coupling function for analog signals on both the input side and the output side. They are indispensable when processing analog values with electronic controls. Under harsh industrial conditions in particular, it is often necessary to transmit analog signals over long distances. Electrical separation is then needed as a result of the different power supplies. The resistance of the wiring causes potential differences and losses which must be prevented.

Electromagnetic disturbance and overvoltages can affect the signals on the input side in particular or even destroy the analog modules. All terminals of the 3RS70 signal converters are safe up to a voltage of 30 V DC and protected against switching poles. Short-circuit protection is an especially important function for the outputs.

The devices are EMC-tested according to

- IEC 61000-6-4 (generic standard for emitted interference)
- IEC 61000-6-2 (generic standard for interference immunity)

The analog signals comply with

- IEC 60381-1/2

### Article No. scheme

Product versions		Article number								
<b>Signal converters</b>		<b>3RS70</b>	<input type="checkbox"/>	<input type="checkbox"/>	-	<input type="checkbox"/>	<input type="checkbox"/>	<input type="checkbox"/>	<input type="checkbox"/>	<b>0 0 0</b>
Product function/type of input signal	Single-range converters, active	<b>0 0</b>								3-way separation, input 0 ... 10 V
		<b>0 2</b>								3-way separation, input 0 ... 20 mA,
		<b>0 3</b>								3-way separation, input 4 ... 20 mA,
	Switchable multi-range converters, active	<b>0 5</b>								3-way separation, 3 standard signals can be switched 0 ... 10 V, 0/4 ... 20 mA
	Switchable universal converters, active	<b>0 6</b>								3-way separation, 16 signals can be switched
	Single-range converters, passive	<b>2 0</b>								2-way separation, 4 ... 20 mA
	Switchable multi-range converters, active	<b>2 5</b>								3-way separation, with manual/automatic switch and setting potentiometer
Connection type	Screw terminals								<b>1</b>	
	Spring-type terminals (push-in)								<b>2</b>	
Type of output signal	0 ... 10 V									<b>A</b>
	0 ... 20 mA									<b>C</b>
	4 ... 20 mA									<b>D</b>
	Loop power isolator 4 ... 20 mA									<b>E</b>
	3 standard signals can be switched									<b>F</b>
	4 frequencies can be switched									<b>K</b>
Supply voltage	24 V AC/DC									<b>E</b>
	None									<b>T</b>
	24 ... 240 V AC/DC									<b>W</b>
Example		<b>3RS70</b>	<b>0 0</b>	<b>-</b>	<b>1</b>	<b>A</b>	<b>E</b>	<b>0 0</b>		

#### Note:

The Article No. scheme shows an overview of product versions for better understanding of the logic behind the article numbers.

For your orders, please use the article numbers quoted in the selection and ordering data.

**Benefits**

- Narrow width
- Easy-to-set universal converters
- Converters with frequency output
- All ranges are fully calibrated
- Universal family of devices – the perfect solution for every application
- Integrated manual/automatic switch with a setpoint generator
- Outputs are short-circuit-proof
- Up to 30 V – protected against damage caused by wiring errors

**Application**

- Signal converters are used in analog signal processing for
- Electrical separation
  - Conversion of normalized and non-normalized signals
  - Amplification and impedance adaptation
  - Conversion to a frequency for processing by a digital input
  - Overvoltage and EMC protection
  - Short-circuit protection of the outputs

**3RS7025 manual/automatic converter**

For special applications in which analog signals have to be simulated, or during plant commissioning when the actual process value is not yet available, the 3RS7025 devices feature an adjustable potentiometer for manual setpoint selection and a manual/automatic switch.

The potentiometer for the 3RS7025 devices is used to simulate analog output signals when the changeover switch is set to "Manual" and the control supply voltage is applied, without the need for an analog input signal. The scale ranges from 0 ... 100%.

Example: When it is set for an output of 4 ... 20 mA, the left stop on the potentiometer represents an output current of 4 mA and the right stop represents an output current of 20 mA. In the "Auto" switch position, the output signal follows the input signal proportionally regardless of the potentiometer setting.

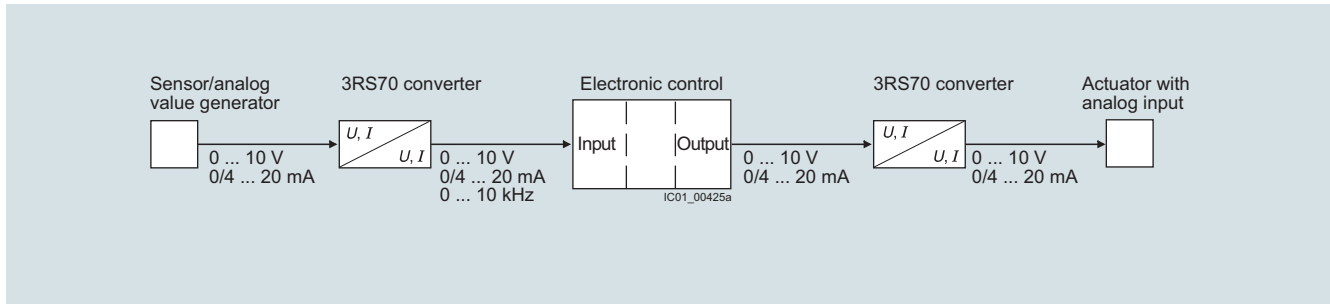

Application example of analog signal processing

## Technical specifications

## More information

Technical specifications, see  
<https://support.industry.siemens.com/cs/ww/en/ps/16691/td>

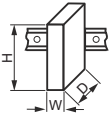

Circuit diagrams, see  
<https://support.industry.siemens.com/cs/ww/en/view/109475738>

Operating instructions, see  
<https://support.industry.siemens.com/cs/ww/en/view/109475738>

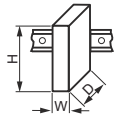
Article number	<b>3RS7000-.AE00</b>	<b>3RS7002-.AE00,</b> <b>3RS7003-.AE00</b>	<b>3RS7000-.CE00,</b> <b>3RS7000-.DE00</b>	<b>3RS7002-.CE00,</b> <b>3RS7002-.DE00,</b> <b>3RS7003-.CE00,</b> <b>3RS7003-.DE00</b>	<b>3RS7020-.ET00</b>
Product designation Product version	Single-range converters, active				Single-range converters, passive
<b>General data:</b>					
<b>Width x height x depth</b>		mm	6.2 x 93 x 72.5		6.2 x 93 x 71
<b>Ambient temperature</b>		°C	-25 ... +60		
• During operation		°C	-40 ... +80		
• During storage					
<b>Relative humidity during operation</b>		%	10 ... 95		
<b>Insulation voltage for overvoltage category III to IEC 60664 for pollution degree 3 rated value</b>		V	50		
<b>Active power input</b>		W	0.29		--
<b>Degree of protection</b>			IP20		
<b>Input:</b>					
<b>Input voltage</b>		V	30		
• Max.					
<b>Input impedance</b>					
• Of current input, maximum	Ω	--	100	--	100
• Of voltage input, minimum	kΩ	330	--	330	--
<b>Output:</b>					
<b>Load</b>					
• Maximum at current output	Ω	--	500		1 000
• Minimum at voltage output	kΩ	2	--		--
<b>Relative measuring accuracy</b>		%	0.1		
<b>Short-circuit-proof</b>			Yes		No

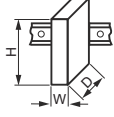
Article number		3RS7005- .FE00	3RS7005- .KE00	3RS7005- .FW00	3RS7005- .KW00	3RS7025- .FE00	3RS7025- .FW00
Product designation Product version		Switchable multi-range converters, active				Switchable multi-range converters, active, with manual/automatic switch and setting potentiometer	
<b>General data:</b>							
<b>Width x height x depth</b>	 mm	6.2 x 93 x 72.5		17.5 x 93 x 72.5		17.5 x 93 x 75	
<b>Ambient temperature</b>							
• During operation	°C	-25 ... +60					
• During storage	°C	-40 ... +80					
<b>Relative humidity during operation</b>	%	10 ... 95					
<b>Insulation voltage for overvoltage category III to IEC 60664 for pollution degree 3 rated value</b>	V	50		300		50 300	
<b>Active power input</b>	W	0.29		0.5 0.34		0.5	
<b>Degree of protection</b>		IP20					
<b>Input:</b>							
<b>Input voltage</b>							
• Max.	V	30					
<b>Input impedance</b>							
• Of current input, maximum	Ω	100					
• Of voltage input, minimum	kΩ	330					
<b>Output:</b>							
<b>Load</b>							
• Maximum at current output	Ω	500		500		500	
• Minimum at voltage output	kΩ	2		2		2	
<b>Relative measuring accuracy</b>	%	0.1					
<b>Short-circuit-proof</b>		Yes					

Article number	<b>3RS7006-FE00</b>	<b>3RS7006-FW00</b>
Product designation Product version	Switchable universal converters, active	
<b>General data:</b>		
<b>Width x height x depth</b>	 mm	17.5 × 93 × 72.5
<b>Ambient temperature</b>		
• During operation	°C	-25 ... +60
• During storage	°C	-40 ... +80
<b>Relative humidity during operation</b>	%	10 ... 95
<b>Insulation voltage for overvoltage category III to IEC 60664 for pollution degree 3 rated value</b>	V	50
<b>Active power input</b>	W	0.5
<b>Degree of protection</b>	IP20	
<b>Input:</b>		
<b>Input voltage</b>		
• Max.	V	30
<b>Input impedance</b>		
• Of current input, maximum	Ω	100
• Of voltage input, minimum	kΩ	330
<b>Output:</b>		
<b>Load</b>		
• Maximum at current output	Ω	500
• Minimum at voltage output	kΩ	2
<b>Relative measuring accuracy</b>	%	0.1
<b>Short-circuit-proof</b>	Yes	

Article number	<b>3RS70..-1....</b>	<b>3RS70..-2....</b>
<b>Type of electrical connection</b>	 <b>Screw terminals</b>	 <b>Spring-type terminals (push-in)</b>
<b>Type of connectable conductor cross-sections</b>		
• Solid	1x (0.25 ... 2.5 mm <sup>2</sup> )	1x (0.25 ... 2.5 mm <sup>2</sup> )
• Finely stranded	--	1x (0.25 ... 2.5 mm <sup>2</sup> )
- Without end sleeves	1x (0.25 ... 1.5 mm <sup>2</sup> )	1x (0.25 ... 1.5 mm <sup>2</sup> )
- With end sleeves	1x (20 ... 14)	1x (20 ... 14)
• Solid for AWG cables		



**Selection and ordering data**

Signal type At the input	At the output	Supply voltage	Width mm	SD d	Article No.	Price per PU	PU (UNIT, SET, M)	PS*
<b>Single-range converters</b>								
<i>Passive</i>								
<b>Type of electrical isolation, 2-way</b>								
4 ... 20 mA	4 ... 20 mA	--	6.2	2	<b>3RS7020-□ET00</b>		1	1 unit
<b>Single-range converters</b>								
<i>Active</i>								
<b>Type of electrical isolation, 3-way</b>								
0 ... 10 V	0 ... 10 V	24 V AC/DC	6.2	2	<b>3RS7000-□AE00</b>		1	1 unit
0 ... 20 mA	0 ... 10 V	24 V AC/DC	6.2	2	<b>3RS7002-□AE00</b>		1	1 unit
4 ... 20 mA	0 ... 10 V	24 V AC/DC	6.2	2	<b>3RS7003-□AE00</b>		1	1 unit
0 ... 10 V	0 ... 20 mA	24 V AC/DC	6.2	2	<b>3RS7000-□CE00</b>		1	1 unit
0 ... 20 mA	0 ... 20 mA	24 V AC/DC	6.2	2	<b>3RS7002-□CE00</b>		1	1 unit
4 ... 20 mA	0 ... 20 mA	24 V AC/DC	6.2	2	<b>3RS7003-□CE00</b>		1	1 unit
0 ... 10 V	4 ... 20 mA	24 V AC/DC	6.2	2	<b>3RS7000-□DE00</b>		1	1 unit
0 ... 20 mA	4 ... 20 mA	24 V AC/DC	6.2	2	<b>3RS7002-□DE00</b>		1	1 unit
4 ... 20 mA	4 ... 20 mA	24 V AC/DC	6.2	2	<b>3RS7003-□DE00</b>		1	1 unit
<b>Multi-range converters</b>								
<i>Active, switchable</i>								
<b>Type of electrical isolation, 3-way</b>								
0 ... 10 V, 0 ... 20 mA, 4 ... 20 mA	0 ... 10 V, 0 ... 20 mA, 4 ... 20 mA	24 V AC/DC 24 ... 240 V AC/DC	6.2 17.5	2 2	<b>3RS7005-□FE00</b> <b>3RS7005-□FW00</b>		1 1	1 unit 1 unit
		24 V AC/DC	6.2	2	<b>3RS7005-□KE00</b>		1	1 unit
		24 ... 240 V AC/DC	17.5	2	<b>3RS7005-□KW00</b>		1	1 unit
<b>Multi-range converters</b>								
<i>Active, with manual/automatic switch and setting potentiometer</i>								
<b>Type of electrical isolation, 3-way</b>								
0 ... 10 V, 0 ... 20 mA, 4 ... 20 mA	0 ... 10 V, 0 ... 20 mA, 4 ... 20 mA	24 V AC/DC 24 ... 240 V AC/DC	17.5 17.5	2 2	<b>3RS7025-□FE00</b> <b>3RS7025-□FW00</b>		1 1	1 unit 1 unit
<b>Universal converters</b>								
<i>Active, switchable</i>								
<b>Type of electrical isolation, 3-way</b>								
0 ... 60 mV, 0 ... 100 mV, 0 ... 300 mV, 0 ... 500 mV, 0 ... 1 V, 0 ... 2 V, 0 ... 5 V, 0 ... 10 V, 0 ... 20 V, 2 ... 10 V, 0 ... 5 mA, 0 ... 10 mA, 0 ... 20 mA, 4 ... 20 mA, -5 ... +5 mA, -20 ... +20 mA	0 ... 10 V, 0 ... 20 mA, 4 ... 20 mA	24 V AC/DC 24 ... 240 V AC/DC	17.5 17.5	2 2	<b>3RS7006-□FE00</b> <b>3RS7006-□FW00</b>		1 1	1 unit 1 unit
<b>Type of electrical connection</b>								
<ul style="list-style-type: none"> <li>• Screw terminals</li> <li>• Spring-type terminals (push-in)</li> </ul>								



3RS7000-1AE00



3RS7000-2AE00







3RS7005-1FW00



3RS7006-1FE00

**Accessories**

Version	SD	Article No.	Price per PU	PU (UNIT, SET, M)	PS*
<b>Galvanic isolation plates</b>					
		<b>Galvanic isolation plates</b> For electrical separation of different potentials when devices of different types are installed side by side		1	10 units
3RQ3900-0A	2	<b>3RQ3900-0A</b>			
<b>Connecting combs</b>					
		<b>Connecting combs</b> For linking the same potentials, current carrying capacity for infeed max. 6 A			
3RQ3901-0B	2	<b>3RQ3901-0A</b>		1	10 units
	2	<b>3RQ3901-0B</b>		1	10 units
	2	<b>3RQ3901-0C</b>		1	10 units
	2	<b>3RQ3901-0D</b>		1	10 units
<b>Clip-on labels</b>					
		<b>Clip-on labels</b> For terminal marking and equipment labeling, white			
	2	<b>3RQ3902-0A</b>		100	2 000 units
<b>Tools for opening spring-type terminals</b>					
		<b>Screwdrivers</b> For all SIRIUS devices with spring-type terminals; 3.0 mm x 0.5 mm; length approx. 200 mm, titanium gray/black, partially insulated			
3RA2908-1A	2	<b>3RA2908-1A</b>		1	1 unit
		<b>Spring-type terminals (push-in)</b> 			

# Function Relays, Interfaces and Converters

## Coupling Relays and Interfaces

### 3TG10 power relays

#### Overview

##### Version

The 3TG10 contactors with 4 main contacts are available with screw-type terminals or with 6.3 mm to 0.8 mm tab connectors. The designs with screw-type terminals are suitable for use in any climate and safe from touch to DIN VDE 0106 Part 100.

The 3TG10 contactors have a compact design. Their overall width is 36 mm.

#### Application

They are suitable for use in household appliances as well as for distribution boards in offices and residential buildings, owing to their hum-free construction. They can further be used in all areas where there is only a limited amount of space available, e.g. in air conditioners, heating systems, pumps and fans - basically in all simple electrical controls.

##### AC and DC operation

EN 60 947-4-1  
(VDE 0660 Part 102).

##### Surge suppression

The 3TG10 contactors are fitted with an integrated protective circuit for damping opening surges.

##### Overload and short-circuit protection

The 3UA7 overload relay can be used for overload protection (see NS E catalogue, available in German). This applies both for contactor mounting and for mounting as a single unit.

The data for short-circuit protection of the contactors without using an overload relay are provided in the technical data.

#### Selection and ordering data

Ratings Utilization category			Main contacts	Rated control supply voltage $U_c$	Order No.	List Price \$	Weight approx.	Pack
AC-1 maximum resistive load	Horsepower ratings of three-phase loads at 50 Hz 400 V	AC-3 maximum inductive current	Design 					
A	kW	A	NO NC				kg	Units

#### With screw connections, 4-pin for screwing and snapping onto 35 mm standard mounting rail · hum-free

##### • AC operation

	3TG10 ...0	20	5	8.4	4 -	230 V, 45–450 Hz 110 V, 45–450 Hz 24 V, 45–450 Hz	<b>3TG10 10-0AL2</b> <b>3TG10 10-0AG2</b> <b>3TG10 10-0AC2</b>	0.15	10
					3 1	230 V, 45–450 Hz 110 V, 45–450 Hz 24 V, 45–450 Hz	<b>3TG10 01-0AL2</b> <b>3TG10 01-0AG2</b> <b>3TG10 01-0AC2</b>	0.15	10

##### • DC operation

	20	5	8.4	4 -	DC 24 V	<b>3TG10 10-0BB4</b> <b>3TG10 01-0BB4</b>	0.15	10
				3 1	DC 24 V			

#### With tab connectors 6.3 x 0.8 mm, 4-pin for screwing and snapping onto 35 mm standard mounting rail · hum-free

##### • AC operation

	3TG10 ...-1	16	5	8.4	4 -	230 V, 45–450 Hz 110 V, 45–450 Hz 24 V, 45–450 Hz	<b>3TG10 10-1AL2</b> <b>3TG10 10-1AG2</b> <b>3TG10 10-1AC2</b>	0.14	10
					3 1	230 V, 45–450 Hz 110 V, 45–450 Hz 24 V, 45–450 Hz	<b>3TG10 01-1AL2</b> <b>3TG10 01-1AG2</b> <b>3TG10 01-1AC2</b>	0.14	10

##### • DC operation

	16	5	8.4	4 -	DC 24 V	<b>3TG10 10-1BB4</b> <b>3TG10 01-1BB4</b>	0.14	10
				3 1	DC 24 V			

1) The links for paralleling can be reduced by one pole. The rated operational currents are valid for each pole. The links for paralleling are insulated.

# Function Relays, Interfaces and Converters

## Coupling Relays and Interfaces

### 3TG10 power relays

Technical data					
General data					
<b>Mechanical endurance</b>	operating cycles				3 mill.
<b>Electrical endurance at <math>I_e</math></b>	operating cycles	AC-1 AC-3			0.1 million 0.4 million
<b>Rated insulation voltage <math>U_i</math></b> (pollution degree 3)			V		400
<b>Rated impulse withstand voltage <math>U_{imp}</math></b>			kV		4
<b>Safe isolation</b> acc. to DIN VDE 0106 Part 101 and A1 (draft 2/89) between coil and contacts			V		up to 300
<b>Permissible ambient temperature</b>	in operation <sup>1)</sup>		°C		-25 ... +55
	when stored		°C		-50 ... +80
<b>Degree of protection</b> acc. to IEC 60 947-1 and IEC 60 529 (VDE 0470 Part 1)					IP 00, coil system IP 20
<b>Power consumption of the coils</b> (with coil in cold state and $1.0 \times U_s$ )	AC operation 45 – 450 Hz		VA		4.4
	p.f.				0.9 (hum-free)
	DC operation		W		4
<b>Coil voltage tolerance</b>					$0.85$ to $1.1 \times U_s$
<b>Operating times</b> (break-time = opening time + arcing time)				AC operation	DC operation
	Closing	closing time	NO ms	10 ... 50	11 ... 50
		opening time	NC ms	5 ... 45	5 ... 45
	Opening	opening time	NO ms	20 ... 30	19 ... 35
		closing time	NC ms	20 ... 30	21 ... 39
	Arcing time		ms	10 to 15	
<b>Shock resistance</b>					
rectangular pulse	AC and DC operation		g/ms		5.1/5 and 3.5/10
sine pulse	AC and DC operation		g/ms		7.9/5 and 5.2/10
<b>Operating frequency <math>z</math></b> in operating cycles per hour					
Rated operation	No-load op. frequency		1/h	10000	
	for AC-1		1/h	1000	
	for AC-2		1/h	500	
	for AC-3		1/h	1000	
Short-circuit protection					
<b>Fuse links</b>					
Utilisation category gL/gG	NH	Type 3NA			
	DIAZED	Type 5SB			
	NEOZED	Type 5SE			
acc. to IEC 60 947-4-1 (DIN VDE 0660 Part 102)	Type of coordination "1"		A	25	
	Type of coordination "2"		A	10	
Miniature circuit-breaker	C-characteristic		A	10	
Load ratings with AC					
<b>AC-1 utilisation category, switching resistive load</b>					
<b>Rated operational current <math>I_e</math></b> at 55 °C to 400 V <sup>1)</sup>					
with screw connection			A	20	
with tab connector			A	16	
<b>Ratings <math>U_e</math></b> of three-phase loads p.f. = 1			V	400	230/220
with screw connection			kW	13	7.5
with tab connector			kW	10	6.0
Minimum conductor cross-section with $I_{e \text{ load}}$			mm <sup>2</sup>	2.5	

1) If the three main conducting paths are loaded with 20 A and  $I > 10$  A for the fourth conducting

path: the permissible ambient temperature is 40 °C.

# Function Relays, Interfaces and Converters

## Coupling Relays and Interfaces

### 3TG10 power relays

Technical data										
<b>Load ratings with AC</b>										
<b>AC-2 and AC-3 utilisation categories</b>										
Rated operational currents $I_e$ up to 400 V	A	8.4								
Ratings of motors with slipping or squirrel-cage rotor at 50 Hz and 60 Hz and at 400 V	kW	4								
<b>AC-5a utilisation category</b> (permissible supply impedance: $\geq 0.5 \Omega$ )										
<b>Switching gas discharge lamps</b> per main conducting path at 50 Hz 230 V										
		Uncorrected			Lead-lag					
Rating per lamp	W	18	36	58	18	36	58			
Rated operational current per lamp	A	0.37	0.43	0.67	2 x 0.11	2 x 0.21	2 x 0.32			
Number of lamps	unit	43	37	24	2 x 81	2 x 42	2 x 28			
<b>Switching gas discharge lamps with correction, electronic ballast</b> per main conducting path at 50 Hz 230 V										
		Parallel correction			Electr. ballast, 1 lamp		Electr. ballast, 2 lamps			
Rating per lamp	W	18	36	58	18	36	58	18	36	58
Capacitor	$\mu\text{F}$	4.5	4.5	7	6.8	6.8	10	10	10	22
Rated operational current per lamp	A	0.11	0.21	0.32	0.10	0.18	0.27	0.18	0.35	0.52
Number of lamps	unit	15	15	10	39	39	26	2 x 26	2 x 26	2 x 1
<b>AC-5b utilisation category, switching incandescent lamps</b> per main conducting path at 50 Hz 230 V										
	kW	1.6								
<b>Load ratings with DC</b>										
<b>DC-1 utilisation category, switching resistive load</b> ( $\frac{L}{R} \leq 1 \text{ ms}$ )										
<b>Rated operational current <math>I_e</math></b>										
		Conducting paths connected in series		1	2	3	4			
		up to 24 V	A	16	16	18	20			
		60 V	A	6	16	18	20			
		110 V	A	2	6	16	20			
		220 V/240 V	A	0.8	1.6	6	20			
<b>DC-3 and DC-5 utilisation categories, shunt and series motors</b> ( $\frac{L}{R} \leq 15 \text{ ms}$ )										
<b>Rated operational current <math>I_e</math></b>										
		Conducting paths connected in series		1	2	3	4			
		up to 24 V	A	10	16	16	18			
		60 V	A	0.5	5	16	16			
		110 V	A	0.15	0.35	10	10			
		220 V/240 V	A	–	–	1.75	2			
<b>Conductor cross-sections for designs</b>										
<b>with screw connections</b>										
Screw connection		M3								
Finely stranded with end sleeve (DIN 46 228, style A/D/C)	mm <sup>2</sup>	2 x (0.75 to 2.5)								
Solid	mm <sup>2</sup>	2 x (1 to 2.5)								
	mm <sup>2</sup>	1 x 4								
<b>with tab connectors</b>										
Finely stranded		6.3 to 1	mm <sup>2</sup>	0.5 to 1						
When using push-on contact acc. to DIN 46 245/46 247		6.3 to 2.5	mm <sup>2</sup>	1 to 2.5						
<b>Ⓢ and Ⓣ ratings (screw connection)</b>										
<b>Rated insulation voltage</b>										
	AC	V	600							
<b>Conventional thermal current</b>										
	Free air and enclosed	A	20							
<b>Maximum horsepower ratings</b> (Ⓢ and Ⓣ-approved values)										
Ratings of three-phase motors at 60 Hz										
				1-phase	3-phase					
	at 115 V	hp		1/2	–					
	200 V	hp		1	3					
	230 V	hp		1 1/2	3					
	460 V/575 V	hp		–	5					
	600 V	hp		–	5					

# Function Relays, Interfaces and Converters

## Coupling Relays and Interfaces

### 3TG10 power relays

#### Accessories

For contactor	Design		Order No.	List Price \$	Weight approx.	Pack
Type	Max. rated operational currents $I_{th}/AC-1$ (at 55 °C) of contactors	Max. conductor cross-sections	PG 101		kg	Units
	A	mm <sup>2</sup>				

#### Links for paralleling (star jumpers)

<ul style="list-style-type: none"> <li>• 3-pole without terminal <sup>1)2)</sup></li> </ul>						
3TG10	16 Star jumpers can be reduced by one pole	–	<b>3RT1 916-4BA31</b>		0.004	1
<ul style="list-style-type: none"> <li>• 3-pole with terminal <sup>1)3)</sup></li> </ul>						
3TG10	40	25	<b>3RT1 916-4BB31</b>		0.013	1
<ul style="list-style-type: none"> <li>• 4-pole with terminal <sup>1)4)</sup></li> </ul>						
3TG10	50	25	<b>3RT1 916-4BB41</b>		0.02	1

#### Circuit diagrams

##### Position of terminals

**3TG10 10**  
1 NO

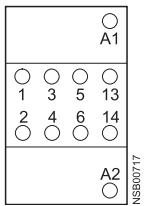

**3TG10 01**  
1 NC

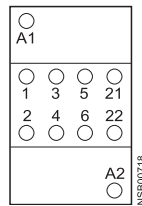

##### Internal circuit diagram

**3TG10 10**  
1 NO  
Ident. 10E

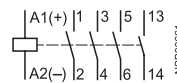

**3TG10 01**  
1 NC  
01E

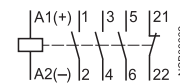

#### Dimension drawings

##### AC and DC operation

**3TG10 ..-0..**  
with screw connections

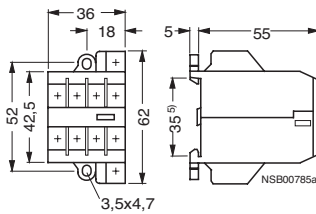

**3TG10 ..-1..**  
with tab connectors

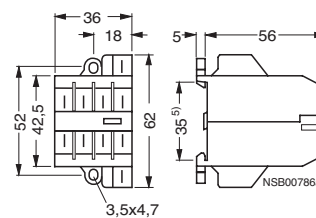

##### Accessories for 3TG10

**3RT19 16-4BB41 links for paralleling, 4-pole, with terminal**

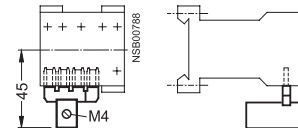

The links for paralleling can be reduced by one pole.

- 1) The links for paralleling can be reduced by one pole. The rated operational currents are valid for each pole. The links for paralleling are insulated.
- 2) Replacement type for 3TX44 90-2C.
- 3) Replacement type for 3TX44 90-2A.
- 4) Replacement type for 3TX44 90-2B.
- 5) Can be snapped onto 35 mm standard mounting rails.

### Selection and ordering data

Siemens offers two lines of plug-in style relays to meet your industrial needs – **3TX71** and **LZS**.



**3TX71** relays are available as open power, enclosed power and plug-in style relays. The plug-in family includes basic, premium and bifurcated styles, screw terminals only, and must be ordered as individual components; the selection guide shows which base and accessories belong with which relay. Basic style relays are the most economical and are equipped with a mechanical flag indicator only. Premium style relays offer LED and mechanical flag indication, push-to-test and a latching function for testing without power to the coil. Premium Bifurcated style relays are ideal for low minimum holding current requirements on the contacts (3mA vs. 100mA).



**LZS** plug-in relays can be ordered as complete units or as individual components and are available with screw or push-in terminals. Complete unit order numbers include the relay, base, LED (with surge suppression in 24VDC version) and retainer/ejector clip and are available with changeover contacts (1CO to 4CO) and coil voltages from 12VDC to 230VAC. PT & MT versions have a push-to-test and a latching function for testing without power to the coil. RT versions are miniature, only 15mm wide and feature 1CO or 2CO contacts. MT versions are 11-pin octal base relays, with 3CO contacts with or without LED and components must be ordered individually.

### Square Base (Narrow)

Contacts	Contact Rating (A)	Coil Voltage	Basic Relay	Premium Relay	Uses Socket 3TX7144-	Uses Clip 3TX7144-	Socket Access Set	Panel Mount Adaptor 3TX7144-	DIN Rail Mount Adaptor 3TX7144-
SPDT	15	12VDC	3TX7110-5BB03C	3TX7110-5JB03	4E7	1L7	B	3L5	3L4
		24 VDC	3TX7110-5BC03C	3TX7110-5JC03	4E7	1L7	B	3L5	3L4
		24 VAC	3TX7110-5BC13C	3TX7110-5JC13	4E7	1L7	B	3L5	3L4
		120 VAC	3TX7110-5BF13C	3TX7110-5JF13	4E7	1L7	B	3L5	3L4
		240 VAC	—	3TX7110-5JG13	4E7	1L7	B	3L5	3L4



### Square Base (Standard)

Contacts	Contact Rating (A)	Coil Voltage	Basic Relay	Premium Relay	Uses Socket 3TX7144-	Uses Clip 3TX7144-	Socket Access Set	Panel Mount Adaptor 3TX7144-
DPDT	12	24 VDC	3TX7111-3DC03C	3TX7111-3LC03	4E5	1L11	B	3L7
		24 VAC	3TX7111-3DC13C	3TX7111-3LC13	4E5	1L11	B	3L7
		120 VAC	3TX7111-3DF13C	3TX7111-3LF13	4E5	1L11	B	3L7
DPDT	15	12 VDC	3TX7114-5DB03C	3TX7114-5LB03	4E6	1L11	B	3L7
		24VDC	3TX7114-5DC03C	3TX7114-5LC03	4E6	1L11	B	3L7
		24VAC	3TX7114-5DC13C	3TX7114-5LC13	4E6	1L11	B	3L7
		120 VAC	3TX7114-5DF13C	3TX7114-5LF13	4E6	1L11	B	3L7
		240 VAC	—	3TX7114-5LH13	4E6	1L11	B	3L7
DPDT	10	12 VDC	3TX7115-5DB03C	—	4E4	1L12	A	—
		24VDC	3TX7115-5DC03C	3TX7115-5LC03	4E4	1L12	A	—
		24VAC	3TX7115-5DC13C	3TX7115-5LC13	4E4	1L12	A	—
		120 VAC	3TX7115-5DF13C	3TX7115-5LF13	4E4	1L12	A	—



Option	Basic	Premium
Mechanical Flag	✓	✓
Push To Test		✓
Lock Down Door		✓
LED		✓

Note: See page 11/145 for socket accessories.

Selection and ordering data



Square Base (Standard)

Contacts	Contact Rating (A)	Coil Voltage	Basic Relay	Premium Relay	Premium Bifurcated	Uses Socket 3TX7144-	Uses Clip 3TX7144-	Socket Access Set	Panel Mount Adaptor 3TX7144-	DIN Rail Mount Adaptor 3TX7144-
3PDT	15	24VDC	3TX7116-5FC03C	3TX7116-5NC03	—	4E8	1L9	A	1M3	1M4
		24VAC	3TX7116-5FC13C	3TX7116-5NC13	—	4E8	1L9	A	1M3	1M4
		120 VAC	3TX7116-5FF13C	3TX7116-5NF13	—	4E8	1L9	A	1M3	1M4
3PDT	10	24VDC	3TX7115-5FC03C	3TX7115-5NC03	—	4E4	1L12	A	—	—
		120 VAC	3TX7115-5FF13C	3TX7115-5NF13	—	4E4	1L12	A	—	—
4PDT	6A for Basic and Premium and 3A for Bifurcated	24VDC	3TX7111-3HC03C	3TX7111-3PC03	3TX7111-5PC03B	4E5	1L11	B	3L7	—
		24VAC	3TX7111-3HC13C	3TX7111-3PC13	3TX7111-5PC13B	4E5	1L11	B	3L7	—
		120 VAC	3TX7111-3HF13C	3TX7111-3PF13	3TX7111-5PF13B	4E5	1L11	B	3L7	—
		240 VAC	—	3TX7111-3PG13	—	4E5	1L11	B	3L7	—
4PDT	15	24VDC	3TX7117-5HC03C	3TX7117-5PC03	—	4E9	1L10	A	1M5	1M6
		24VAC	3TX7117-5HC13C	3TX7117-5PC13	—	4E9	1L10	A	1M5	1M6
		120 VAC	3TX7117-5HF13C	3TX7117-5PF13	—	4E9	1L10	A	1M5	1M6

Option	Basic	Premium	Premium Bifurcated
Mechanical Flag	✓	✓	✓
Push To Test		✓	✓
Lock Down Door		✓	✓
LED		✓	✓

Note: See page 11/145 for socket accessories.



# Function Relays, Interfaces and Converters

## Coupling Relays and Interfaces

### 3TX71 plug-in relays

#### Selection and ordering data



#### Standard Octal Base

Contacts	Contact Rating (A)	Coil Voltage	Basic Relay	Premium Relay	Uses Socket 3TX7144-	Uses Clip 3TX7144-	Socket Access Set
DPDT	10	12 VDC	3TX7112-1DB03C	3TX7112-1LB03	4E2	1L14	A
		24VDC	3TX7112-1DC03C	3TX7112-1LC03	4E2	1L14	A
		24VAC	3TX7112-1DC13C	3TX7112-1LC13	4E2	1L14	A
		120 VAC	3TX7112-1DF13C	3TX7112-1LF13	4E2	1L14	A
		240 VAC	3TX7112-1DG13C	3TX7112-1LG13	4E2	1L14	A
3PDT	10	24VDC	3TX7112-1FC03C	3TX7112-1NC03	4E3	1L14	A
		24VAC	3TX7112-1FC13C	3TX7112-1NC13	4E3	1L14	A
		120 VAC	3TX7112-1FF13C	3TX7112-1NF13	4E3	1L14	A
		240 VAC	—	3TX7112-1NG13	4E3	1L14	A



#### Hermetically Sealed

Contacts	Contact Rating (A)	Coil Voltage	Basic Relay	Uses Socket 3TX7144-	Uses Clip 3TX7144-	Socket Access Set
DPDT	12	24 VDC	3TX7127-5HC00	4E2	1L12	A
4PDT	3	24VDC	3TX7127-3HC00	4E5	1L11	B
		24VAC	3TX7127-3HC10	4E5	1L11	B
		120 VAC	3TX7127-3HF10	4E5	1L11	B
4PDT	5	12 VDC	3TX7127-3HB03	4E5	1L11	B
		24VDC	3TX7127-3HC03	4E5	1L11	B
		120 VAC	3TX7127-3HF13	4E5	1L11	B

#### Socket Accessories

Access. Series	MOV	MOV	R/C	R/C	Diode
	24VAC/DC	120VAC/DC	6-24VAC/DC	110-240VAC/DC	6-250VDC
A	3TX7144-H1	3TX7144-H20	3TX7144-H4	3TX7144-H5	3TX7144-H6
B	3TX7144-H9	3TX7144-H17	—	—	3TX7144-H12

Note: See socket accessories above.

Selection and ordering data

Open Power Relays

Contacts	Contact Rating (A)	Coil Voltage	Basic Relay	Metal Cover 7144-
SPST NO-DM	40	24VAC	3TX7130-0AC13	1M0
SPST NO-DM		120 VAC	3TX7130-0AF13	1M0
SPST NO-DM		240 VAC	3TX7130-0AH13	1M0
SPST NC-DM	40	120 VAC	3TX7130-0QF13	1M0
SPDT		24 VAC	3TX7130-0BC13	1M0
SPDT		120 VAC	3TX7130-0BF13	1M0
SPDT		240 VAC	3TX7130-0BH13	1M0
DPDT	40	277 VAC	3TX7130-0BS13	1M0
		24 VAC	3TX7130-0DC13	1M0
		120 VAC	3TX7130-0DF13	1M0
		240 VAC	3TX7130-0DH13	1M0
		277 VAC	3TX7130-0DS13	1M0
		12 VDC	3TX7130-0DB03	1M0
DPST NO	40	24 VDC	3TX7130-0DC03	1M0
		48 VDC	3TX7130-0DD03	1M0
		110 VDC	3TX7130-0DF03	1M0
		24 VAC	3TX7130-0CC13	1M0
		120 VAC	3TX7130-0CF13	1M0
		240 VAC	3TX7130-0CH13	1M0
DPDT (Mag Blowout)	40	12 VDC	3TX7130-0CB03	1M0
		24 VDC	3TX7130-0CC03	1M0
		48 VDC	3TX7130-0CD03	1M0
		120 VAC	3TX7130-0RF13	1M0
		12 VDC	3TX7130-0RB03	1M0
		24 VDC	3TX7130-0RC03	1M0
		48 VDC	3TX7130-0RD03	1M0
		110 VDC	3TX7130-0RF03	1M0



Enclosed Power Relays

Contacts	Contact Rating (A)	Coil Voltage	Basic Relay
DPST-NO	30	24VAC	3TX7131-4CC13
		120 VAC	3TX7131-4CF13
		230 VAC	3TX7131-4CH13
DPDT	30 NO/ 3 NC	12 VDC	3TX7131-4DB03
		24 VDC	3TX7131-4DC03
		24VAC	3TX7131-4DC13
		120 VAC	3TX7131-4DF13
		230 VAC	3TX7131-4DH13



Note: See page 11/145 for socket accessories.

# Function Relays, Interfaces and Converters

## Coupling Relays and Interfaces

### 3TX71 plug-in relays

#### General specifications

Contact Characteristics		Units	3TX7110		3TX7111			
Number and Type of Contacts			SPDT	SPDT	DPDT	DPDT	4PDT	4PDT
Contact Material			Silver Alloy	Silver Alloy	Silver Alloy	Silver Alloy	Silver Alloy	Silver Alloy
Thermal (Carrying) Current	A	15	3 (Bifurcated)	12	3 (Bifurcated)	6	3 (Bifurcated)	3 (Bifurcated)
Maximum Switching Voltage	V	300	300	300	300	300	300	300
Switching Current at Voltage	Resistive	15A @240V	3A @240V	—	3A @240V	6A @240V	3A @240V	3A @240V
	Resistive	15A @120V	—	12A @120V	3A @120V	6A @120V	3A @120V	3A @120V
	Resistive	15A @ 28	—	12A @ 28	3A @ 30	6A @ 28	3A @ 30	3A @ 30
	HP	1/2 @ 120VAC	—	1/3 @ 120VAC	1/16 @ 120VAC	1/3 @ 120VAC	1/16 @ 120VAC	1/16 @ 120VAC
	HP	1 @ 240VAC	—	—	—	1 @ 240VAC	—	—
Pilot Duty		B300	—	B300	—	B300	—	—
Minimum Switching Requirement	mA	100 @ 5VDC (.5W)	3 @ 17VDC (.4W)	100 @ 5VDC (.5W)	3 @ 17VDC (.4W)	100 @ 5VDC (.5W)	3 @ 17VDC (.4W)	3 @ 17VDC (.4W)
<b>Coil Characteristics</b>								
Voltage Range	AC	V	6...240	6...240	6...240	6...240	6...240	6...240
	DC	V	6...125	6...125	6...125	6...125	6...125	6...125
Operating Range	AC	%	85 to 110	85 to 110	85 to 110	85 to 110	85 to 110	85 to 110
	DC	%	80 to 110	80 to 110	80 to 110	80 to 110	80 to 110	80 to 110
Average Consumption	AC	VA	0.9	0.9	1.2	1.2	1.2	1.2
	DC	W	0.7	0.7	0.9	0.9	0.9	0.9
Drop-out Voltage Threshold	AC	%	15	15	15	15	15	15
	DC	%	10	10	10	10	10	10
<b>Performance Characteristics</b>								
Electrical Life (UL508)	Operations @ Rated Current	(Resistive)	100,000	100,000	200,000	200,000	200,000	200,000
Mechanical Life	Unpowered		10,000,000	10,000,000	10,000,000	10,000,000	10,000,000	10,000,000
Operating Time (response time)		ms	20	20	20	20	20	20
Dielectric Strength	Between Coil and Contact	V(rms)	2500	2500	2500	2500	2500	2500
	Between Poles	V(rms)	1500	1500	1500	1500	1500	1500
	Between Contacts	V(rms)	1500	1500	1500	1500	1500	1500
<b>Environment</b>								
Product Certifications	Standard Version		UL,RoHS	UL,RoHS	UL,RoHS	UL,RoHS	UL,RoHS	UL,RoHS
Ambient Air Temperature around the Device	Storage	°C	-40...+85	-40...+85	-40...+85	-40...+85	-40...+85	-40...+85
	Operational	°C	-40...+55	-40...+55	-40...+55	-40...+55	-40...+55	-40...+55
Vibration Resistance	Operational	g-n	3, 10 - 55 Hz	3, 10 - 55 Hz	3, 10 - 55 Hz	3, 10 - 55 Hz	3, 10 - 55 Hz	3, 10 - 55 Hz
Shock Resistance		g-n	10	10	10	10	10	10
Degree of Protection			IP40	IP40	IP40	IP40	IP40	IP40
Weight		grams	29	29	36	36	36	36

Contact Characteristics		Units	3TX7112	3TX7114	3TX7115	3TX7116	3TX7117	
Number and Type of Contacts			DPDT	3PDT	DPDT	DPDT	3PDT	4PDT
Contact Material			Silver Alloy	Silver Alloy	Silver Alloy	Silver Alloy	Silver Alloy	Silver Alloy
Thermal (Carrying) Current	A	10	10	15	10	10	15	15
Maximum Switching Voltage	V	300	300	300	300	300	300	300
Switching Current at Voltage	Resistive	10A @240V	10A @240V	12A @277V	10A @277V	10A @277V	12A @277V	12A @277V
	Resistive	10A @120V	10A @120V	15A @120V	10A @120V	10A @120V	15A @120V	15A @120V
	Resistive	10A @ 28	10A @ 28	12A @ 28	10A @ 28	10A @ 28	12A @ 28	12A @ 28
	HP	1/3 @ 120VAC	1/3 @ 120VAC	1/2 @ 120VAC	1/3 @ 120VAC	1/3 @ 120VAC	1/2 @ 120VAC	1/2 @ 120VAC
	HP	1/2 @ 240VAC	1/2 @ 240VAC	1 @ 240VAC	1/2 @ 240VAC	1/2 @ 240VAC	3/4 @ 240VAC	3/4 @ 240VAC
Pilot Duty		B300	B300	B300	B300	B300	B300	B300
Minimum Switching Requirement	mA	100 @ 5VDC (.5W)	100 @ 5VDC (.5W)	100 @ 5VDC (.5W)	100 @ 5VDC (.5W)	100 @ 5VDC (.5W)	100 @ 5VDC (.5W)	100 @ 5VDC (.5W)
<b>Coil Characteristics</b>								
Voltage Range	AC	V	6...240	6...240	6...240	6...240	6...240	6...240
	DC	V	6...125	6...125	6...125	6...125	6...125	6...125
Operating Range	AC	%	85 to 110	85 to 110	85 to 110	85 to 110	85 to 110	85 to 110
	DC	%	80 to 110	80 to 110	80 to 110	80 to 110	80 to 110	80 to 110
Average Consumption	AC	VA	1.2	1.2	1.2	1.2	1.5	1.5
	DC	W	0.9	0.9	0.9	0.9	1.4	1.5
Drop-out Voltage Threshold	AC	%	15	15	15	15	15	15
	DC	%	10	10	10	10	10	10
<b>Performance Characteristics</b>								
Electrical Life (UL508)	Operations @ Rated Current	(Resistive)	200,000	200,000	100,000	100,000	100,000	200,000
Mechanical Life	Unpowered		10,000,000	10,000,000	10,000,000	10,000,000	10,000,000	10,000,000
Operating Time (response time)		ms	20	20	20	20	20	20
Dielectric Strength	Between Coil and Contact	V(rms)	2500	2500	2500	2500	2500	2500
	Between Poles	V(rms)	1500	1500	1500	1500	1500	2500
	Between Contacts	V(rms)	1500	1500	1500	1500	1500	2500
<b>Environment</b>								
Product Certifications	Standard Version		UL,RoHS	UL,RoHS	UL,RoHS	UL,RoHS	UL,RoHS	UL,RoHS
Ambient Air Temperature around the Device	Storage	°C	-40...+85	-40...+85	-40...+85	-40...+85	-40...+85	-40...+85
	Operational	°C	-40...+55	-40...+55	-40...+55	-40...+55	-40...+55	-40...+55
Vibration Resistance	Operational	g-n	3, 10 - 55 Hz	3, 10 - 55 Hz	3, 10 - 55 Hz	3, 10 - 55 Hz	3, 10 - 55 Hz	3, 10 - 55 Hz
Shock Resistance		g-n	10	10	10	10	10	10
Degree of Protection			IP40	IP40	IP40	IP40	IP40	IP40
Weight		grams	89	89	36	88	88	60

General specifications

Contact Characteristics			Units	3TX7127			3TX7130	
Number and Type of Contacts				DPDT	4PDT	4PDT	All	
Contact Material				Silver Alloy	Fine Silver	Silver Alloy	Silver Alloy	
Thermal (Carrying) Current			A	12	3	5	40	
Maximum Switching Voltage			V	300	300	300	600	
Switching Current at Voltage			Resistive	12A @240V	3A @240V	12A @240V	40A @277V	
			Resistive	12A @120V	3A @120V	—	—	
			Resistive	12A @ 28	3A @ 30	—	40A @ 28	
			HP	1/3 @ 120VAC	1/16 @ 120VAC	—	—	
			HP	1/2 @ 240VAC	1/10 @ 240VAC	—	—	
Pilot Duty				B300	—	—	—	
Minimum Switching Requirement			mA	100 @ 5VDC (.5W)	10 @ 5VDC (.5W)	100 @ 5VDC (.5W)	1000 @ 12VAC/DC	
Coil Characteristics								
Voltage Range		AC	V	6...240	6...240	6...240	6...600	
		DC	V	6...125	6...125	6...125	6...600	
Operating Range		AC	%	85 to 110	85 to 110	85 to 110	85 to 110	
		DC	%	80 to 110	80 to 110	80 to 110	80 to 110	
Average Consumption		AC	VA	1.2	1.2	1.2	10	
		DC	W	0.9	0.9	0.9	4	
Drop-out Voltage Threshold		AC	%	15	15	15	10	
		DC	%	10	10	10	10	
Performance Characteristics								
Electrical Life (UL508)		Operations @ Rated Current	(Resistive)	100,000	100,000	100,000	100,000	
Mechanical Life		Unpowered		10,000,000	10,000,000	10,000,000	1,000,000	
Operating Time (response time)			ms	20	20	20	30	
Dielectric Strength		Between Coil and Contact		V(rms)	1,500	1240	1240	2200
		Between Poles		V(rms)	1,500	1240	1240	2200
		Between Contacts		V(rms)	1500	500	500	1500
Environment								
Product Certifications		Standard Version		UL,RoHS	UL,RoHS	UL,RoHS	UL	
Ambient Air Temperature around the Device		Storage	°C	-40...+85	-40...+85	-40...+85	-40...+85	
		Operational	°C	-40...+55	-40...+70	-40...+70	-40...+70	
Vibration Resistance		Operational	g-n	3, 10 - 55 Hz	3, 10 - 55 Hz	3, 10 - 55 Hz	3, 10 - 55 Hz	
Shock Resistance			g-n	10	10	10	—	
Degree of Protection				IP67	IP67	IP67	Open	
Weight			grams	130	45	45	227 to 312	

Contact Characteristics			Units	3TX7131			3TX7132	
Number and Type of Contacts				DPST-NO	DPDT	DPDT	SPDT	
Contact Material				Silver Alloy	Silver Alloy	Silver Alloy	Silver Alloy	
Thermal (Carrying) Current			A	30	30 DPDT-NO	3 DPDT-NC	30 SPDT-NO	
Maximum Switching Voltage			V	600	300	300	300	
Switching Current at Voltage			Resistive	20A @300V	30A @277V	3A @277V	30A @277V	
			Resistive	—	—	—	—	
			Resistive	20A @ 28	20A @ 28	3A @ 28	10A @ 28	
			HP	1/3 @ 120VAC	1 @ 120VAC	—	1 @ 120VAC	
			HP	1/2 @ 600VAC	3 @ 240VAC	—	2 @ 240VAC	
Pilot Duty				—	—	—	—	
Minimum Switching Requirement			mA	500 @ 12VAC/DC	500 @ 12VAC/DC	500 @ 12VAC/DC	1000 @ 12VAC/5VDC	
Coil Characteristics								
Voltage Range		AC	V	12...240	12...240	12...240	12...277	
		DC	V	6...110	6...110	6...110	5...110	
Operating Range		AC	%	85 to 120	85 to 120	85 to 120	85 to 120	
		DC	%	75 to 120	75 to 120	75 to 120	75 to 120	
Average Consumption		AC	VA	4	4	4	2.8	
		DC	W	1.7	1.7	1.7	1	
Drop-out Voltage Threshold		AC	%	10	10	10	10	
		DC	%	10	10	10	10	
Performance Characteristics								
Electrical Life (UL508)		Operations @ Rated Current	(Resistive)	100,000	100,000	100,000	100,000	
Mechanical Life		Unpowered		5,000,000	5,000,000	5,000,000	10,000,000	
Operating Time (response time)			ms	15	15	15	15	
Dielectric Strength		Between Coil and Contact		V(rms)	4000	4000	4000	2500
		Between Poles		V(rms)	2000	2000	2000	1500
		Between Contacts		V(rms)	1500	1500	1500	1500
Environment								
Product Certifications		Standard Version		UL	UL	UL	UL	
Ambient Air Temperature around the Device		Storage	°C	-40...+85	-40...+85	-40...+85	-40...+85	
		Operational	°C	-40...+55	-40...+55	-40...+55	-40...+55	
Vibration Resistance		Operational	g-n	3, 10 - 55 Hz	3, 10 - 55 Hz	3, 10 - 55 Hz	3, 10 - 55 Hz	
Shock Resistance			g-n	10	10	10	10	
Degree of Protection				—	—	—	—	
Weight			grams	86	86	86	33	

# Function Relays, Interfaces and Converters

## Coupling Relays and Interfaces

### 3TX71 plug-in relays

#### Circuit diagrams

**3TX7110**

SPDT

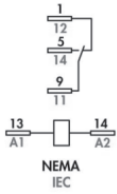

**3TX7111**

DPDT

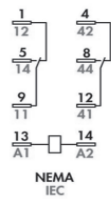

**3TX7111**

4PDT

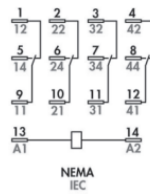

**3TX7112**

DPDT

AC COIL CIRCUIT

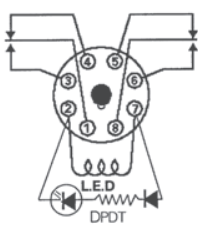

**3TX7112**

3PDT

AC COIL CIRCUIT

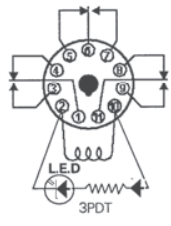

**3TX7112-1L, -1D**

DPDT

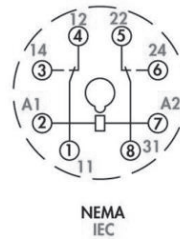

**3TX7112-1N, -1F**

3PDT

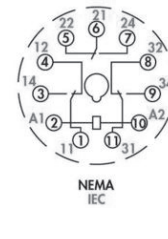

DC COIL CIRCUIT

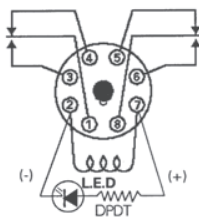

DC COIL CIRCUIT

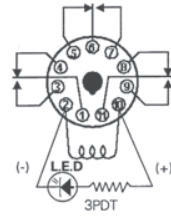

**3TX7114**

DPDT

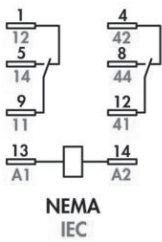

**3TX7115**

DPDT

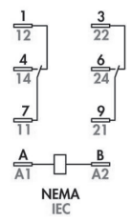

**3TX7115**

3PDT

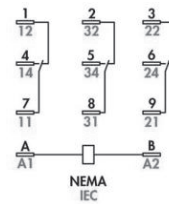

Circuit diagrams

3TX7116

3PDT

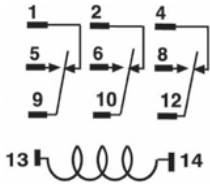

3TX7117

4PDT

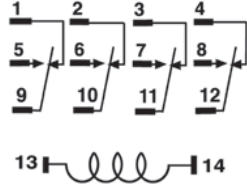

3TX7127

4PDT

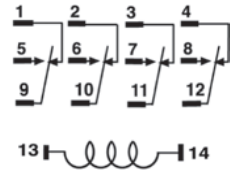

3TX7127 (DPDT)

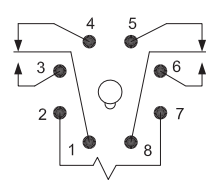

3TX7127 (3PDT)

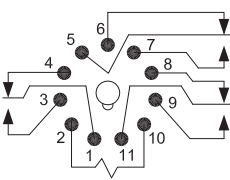

3TX7130

SPST-NO



3TX7130

SPDT

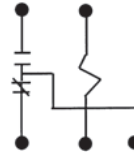

3TX7130

DPST-NO

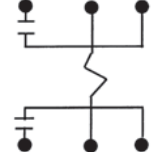

3TX7130

SPST-NC



SPST-NC-DB

3TX7130

DPDT

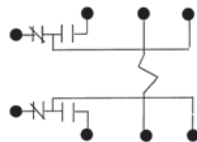

3TX7130 (DPDT)

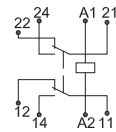

3TX7131 (DPST-NO) (AC)

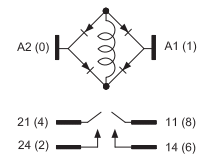

# Function Relays, Interfaces and Converters

## Coupling Relays and Interfaces

### 3TX71 plug-in relays

#### Circuit diagrams

**3TX7131 (DPST-NO) (DC)**

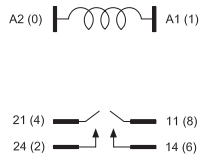

**3TX7131 (DPDT) (AC)**

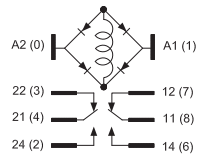

**3TX7131 (DPDT) (DC)**

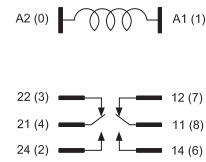

# Function Relays, Interfaces and Converters

## Coupling Relays and Interfaces

### 3TX71 plug-in relays

#### Dimension drawings

3TX7110 SPDT

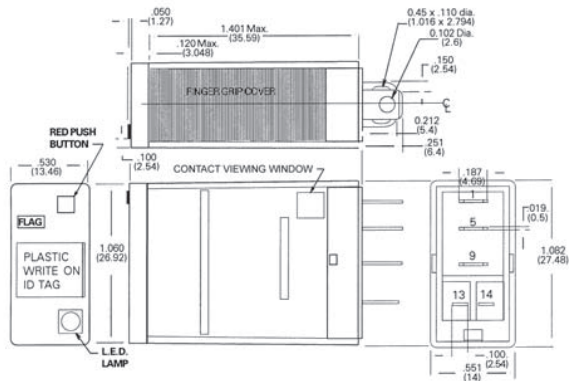

3TX7111 DPDT

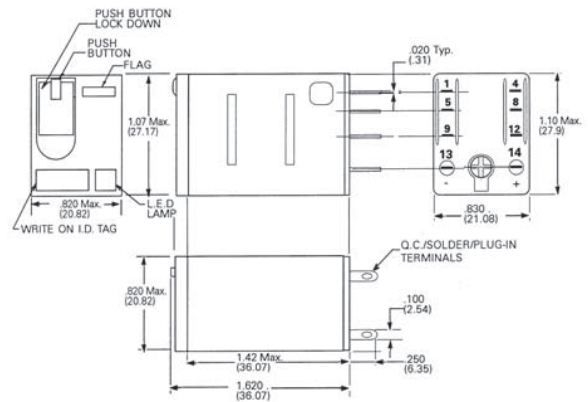

3TX7111 4PDT

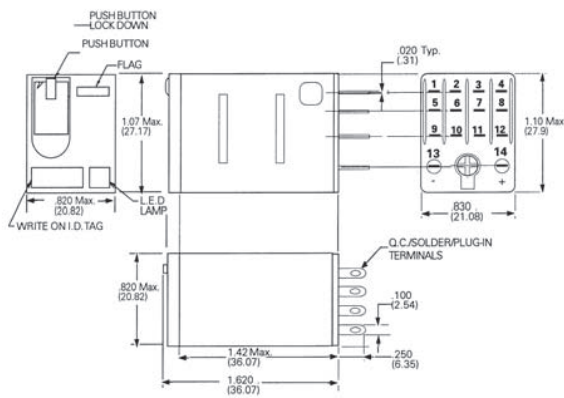

3TX7112 DPDT

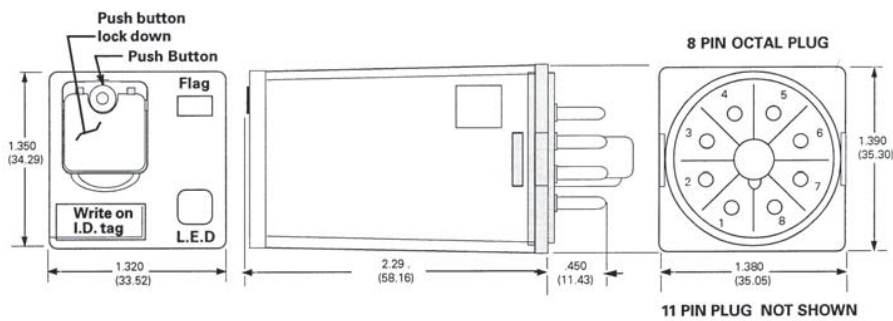



# Function Relays, Interfaces and Converters

## Coupling Relays and Interfaces

### 3TX71 plug-in relays

#### Dimension drawings

3TX7114 DPDT

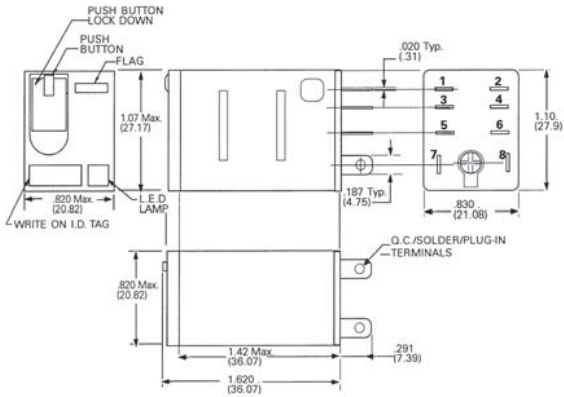

3TX7115 (DPDT) (clear cover)

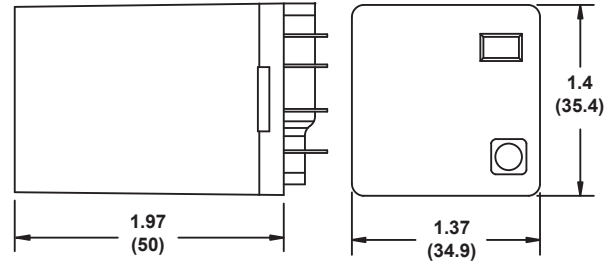

3TX7115 (DPDT) (full feature)

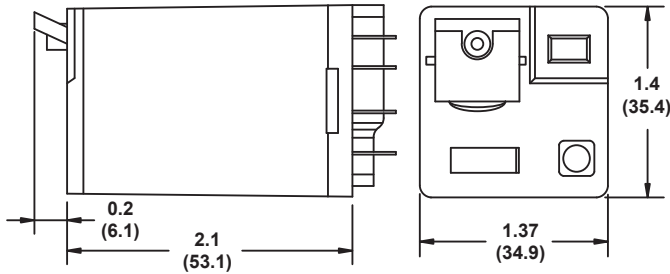

3TX7115 3PDT

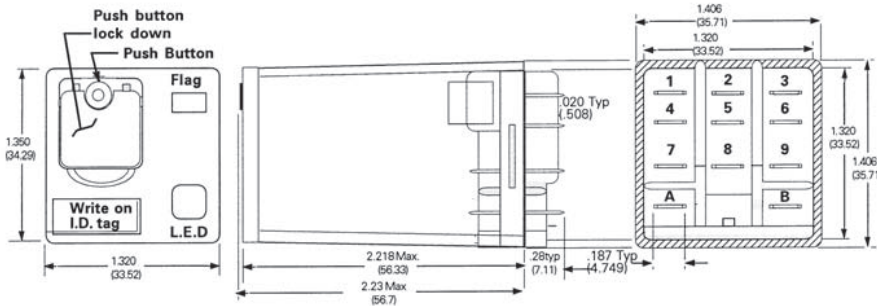

3TX7116 3PDT

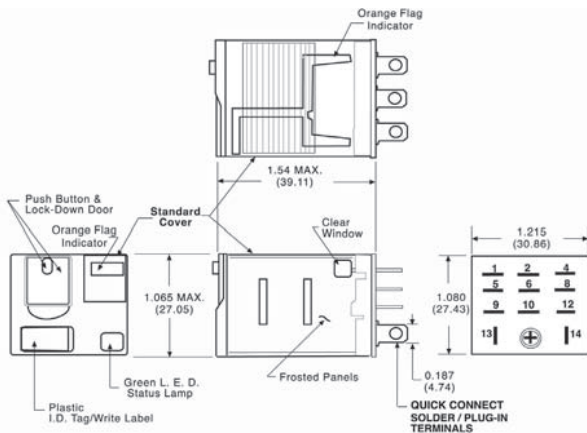

3TX7117 4PDT

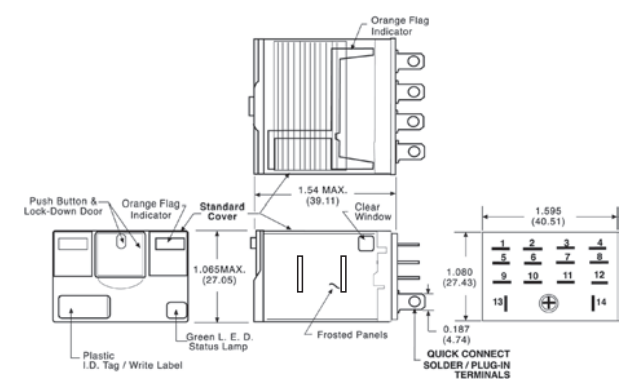

# Function Relays, Interfaces and Converters

## Coupling Relays and Interfaces

### 3TX71 plug-in relays

#### Dimension drawings

**3TX7127 (DPDT)**

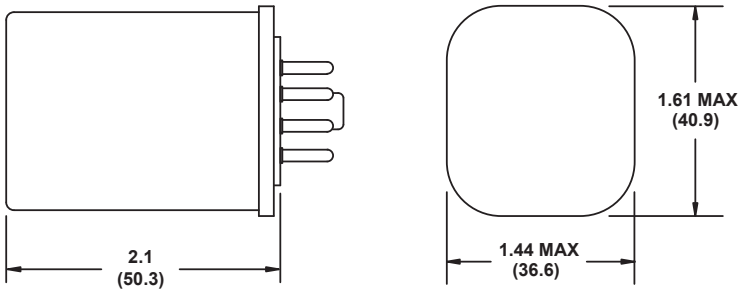

**3TX7127 3PDT**

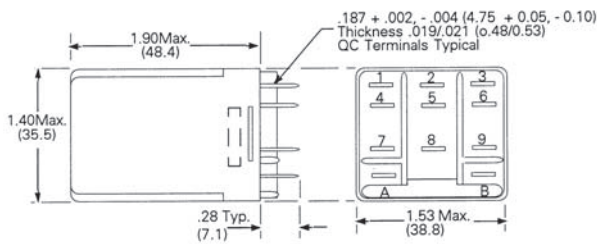

**3TX7127 4PDT**

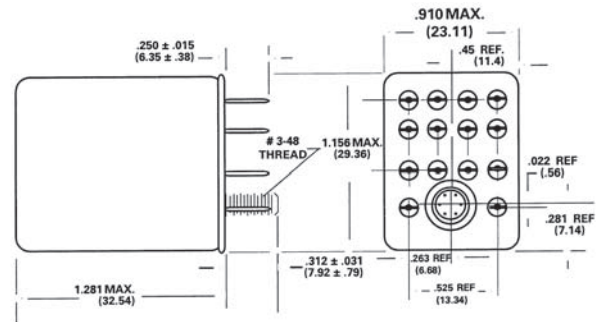

**3TX7130 SPST NC**

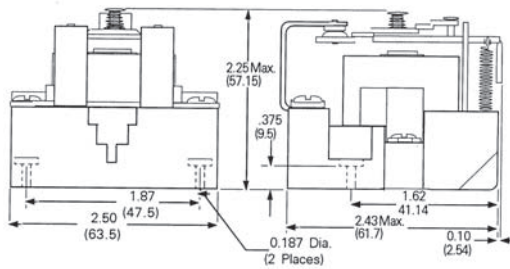

**3TX7130 SPST NO**

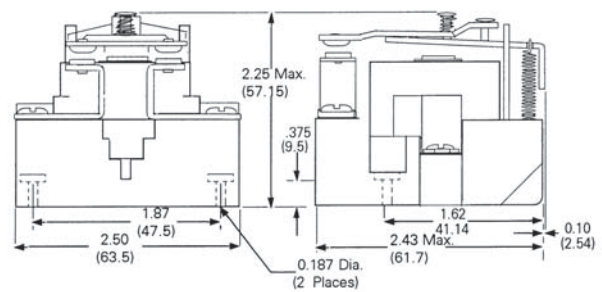

# Function Relays, Interfaces and Converters

## Coupling Relays and Interfaces

### 3TX71 plug-in relays

#### Dimension drawings

3TX7130 SPDT

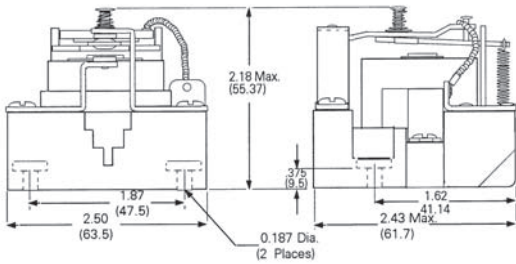

3TX7130 DPST NO

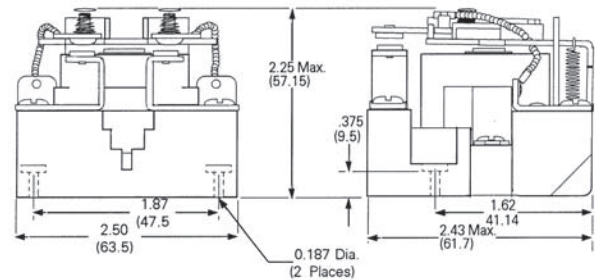

3TX7130 DPDT

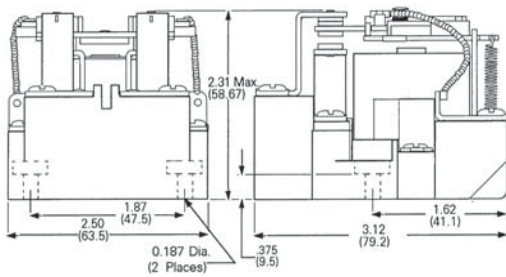

3TX7130 DPDT with magnetic blowout

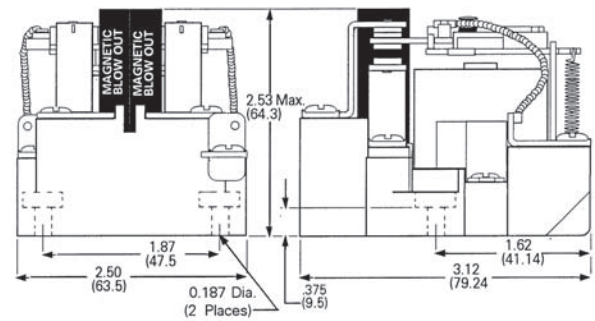

3TX7131 (DPST-NO)

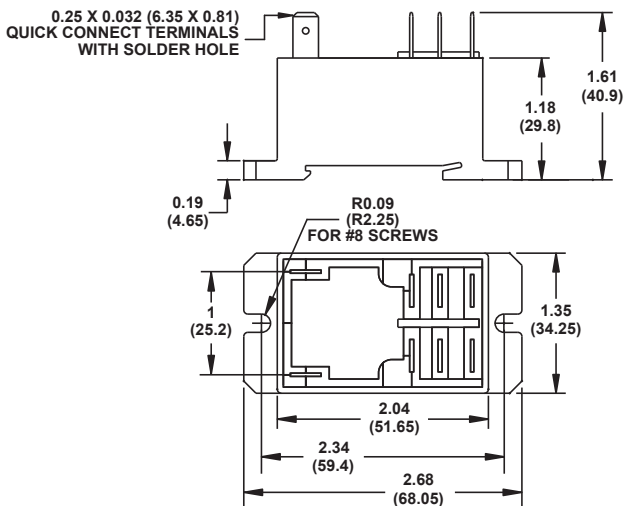

3TX7131 (DPDT)

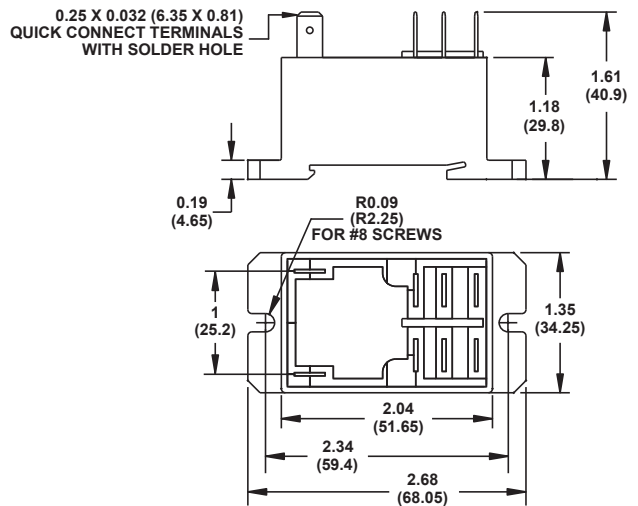

# Function Relays, Interfaces and Converters

## Coupling Relays and Interfaces

### 3TX71 plug-in relays

#### Dimension drawings

3TX7144-1E2

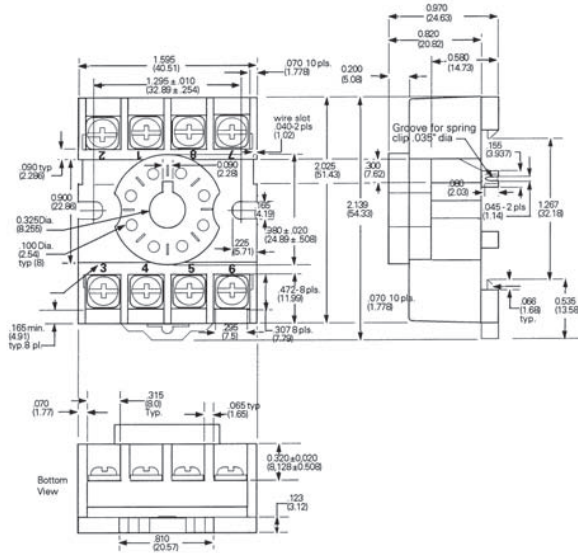

3TX7144-1E3

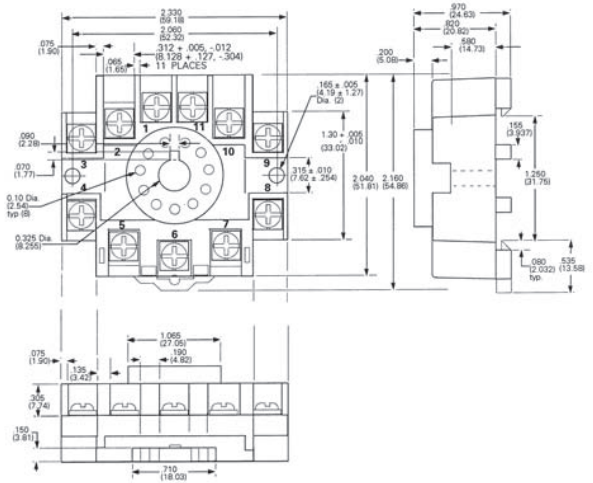

3TX7144-1E4

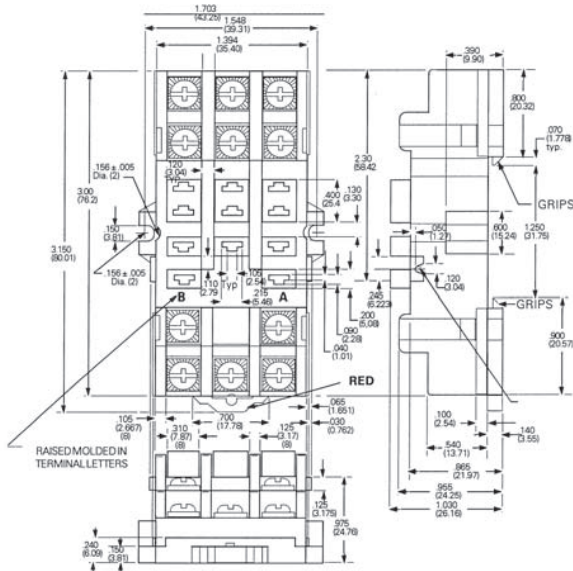

# Function Relays, Interfaces and Converters

## Coupling Relays and Interfaces

### 3TX71 plug-in relays

#### Dimension drawings

3TX7144-1E5

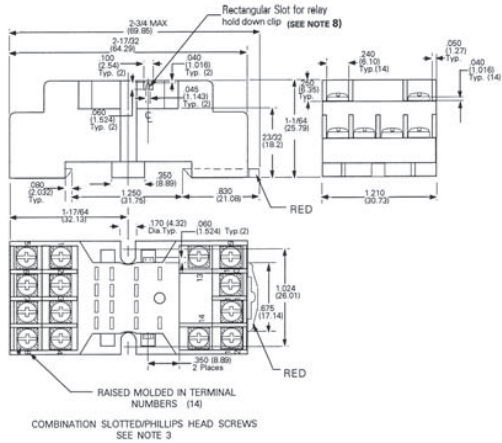

3TX7144-1E6

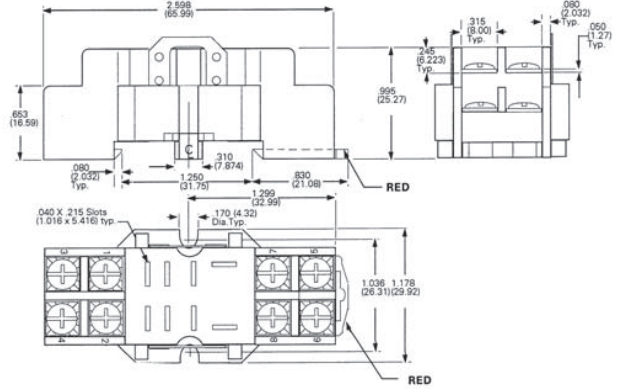

3TX7144-4E1

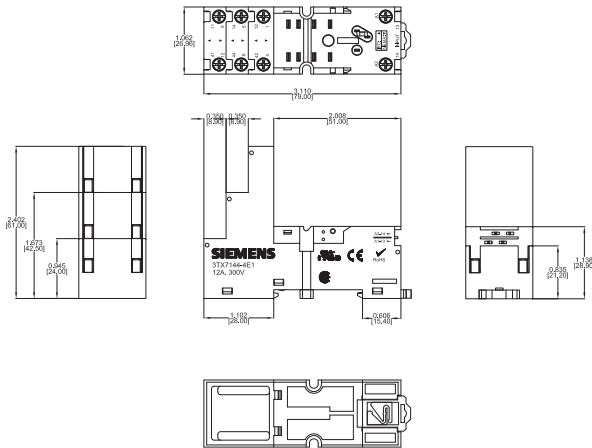

3TX7144-4E2

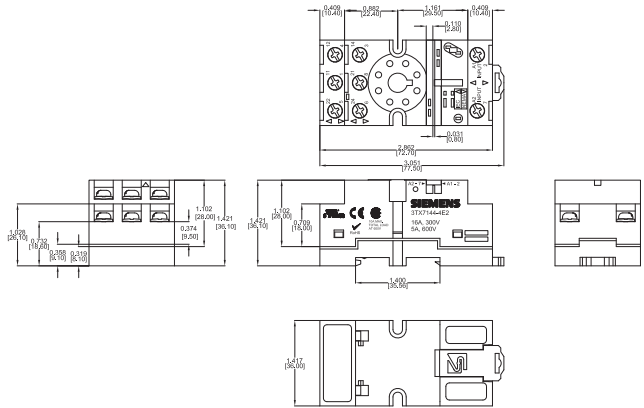

3TX7144-4E3

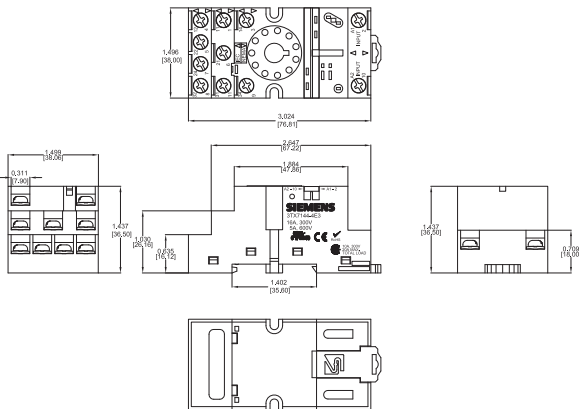

Dimension drawings

3TX7144-4E4

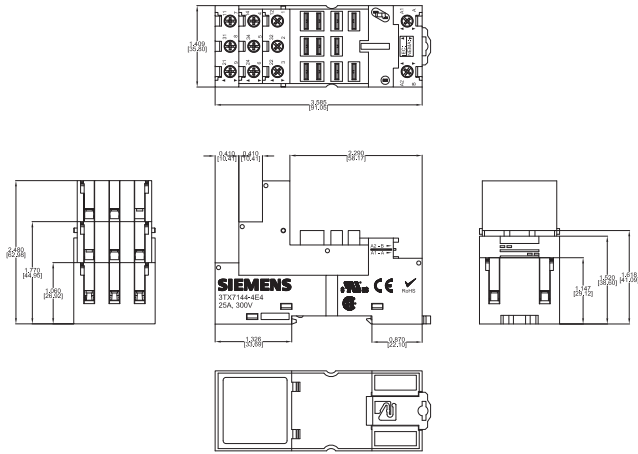

3TX7144-4E5

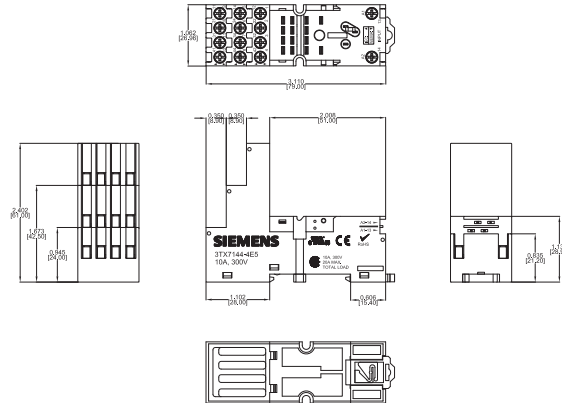

3TX7144-4E6

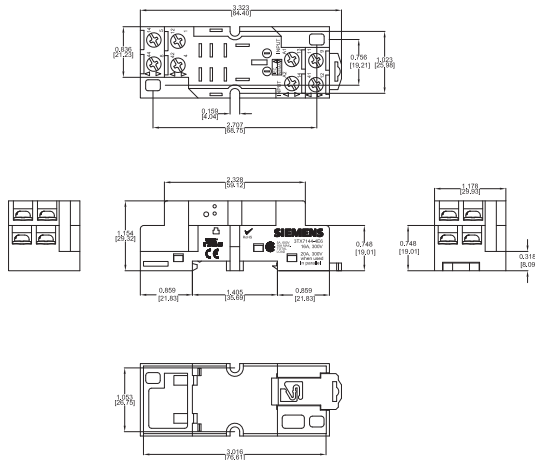

3TX7144-4E7

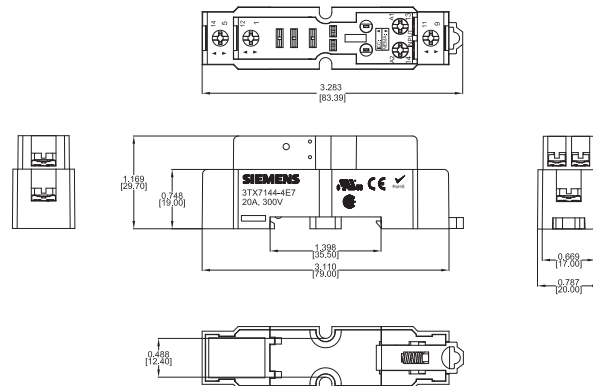



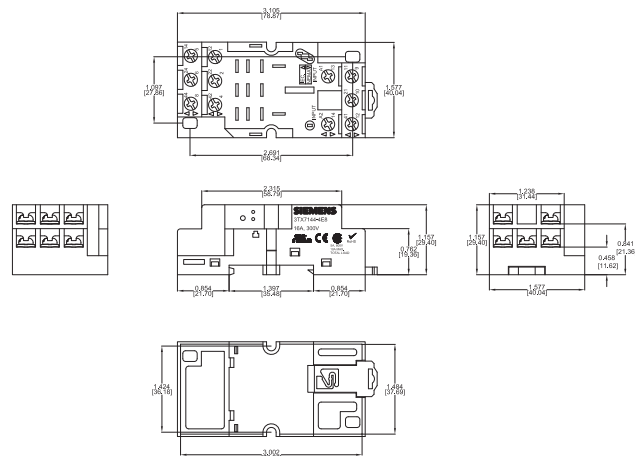

3TX7144-4E8

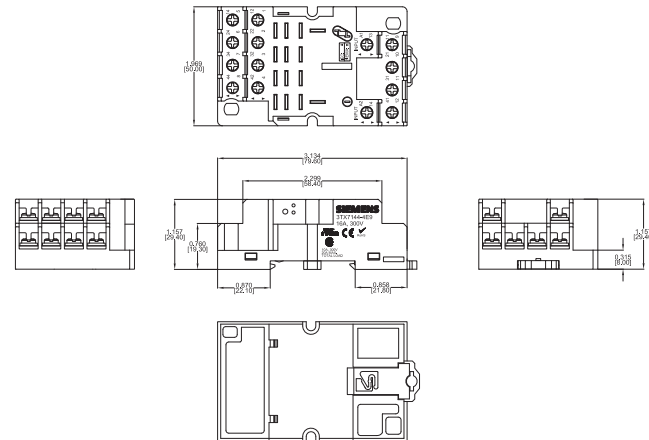

3TX7144-4E9



### Selection and ordering data

Version	Rated control supply voltage $U_s$ (at AC: 50/60 Hz)	Contacts, number of CO contacts	Width mm	SD d	Article No.	Price per PU	PU (UNIT, SET, M)	PS*	
<b>Complete units, 3CO and 4CO contacts, PT series</b>									
 <p>LZS:PT3A5L24</p>	<b>Complete units with plug-in base</b> For snap-on mounting onto DINrail Comprising:				<b>Screw terminals</b> 				
	<ul style="list-style-type: none"> <li>• Plug-in relays</li> <li>• Standard plug-in base with screw terminals</li> <li>• LED module (24 V DC version: LED module with freewheel diode)</li> <li>• Fixing/ejection brackets</li> <li>• Labels</li> </ul>								
	3 CO contacts	24 DC	3	28	2	<b>LZS:PT3A5L24</b>		1	5 units
		24 AC			2	<b>LZS:PT3A5R24</b>		1	5 units
		115 AC			2	<b>LZS:PT3A5S15</b>		1	5 units
		230 AC			2	<b>LZS:PT3A5T30</b>		1	5 units
	4 CO contacts	24 DC	4	28	2	<b>LZS:PT5A5L24</b>		1	5 units
		24 AC			2	<b>LZS:PT5A5R24</b>		1	5 units
		115 AC			2	<b>LZS:PT5A5S15</b>		1	5 units
		230 AC			2	<b>LZS:PT5A5T30</b>		1	5 units
<b>Complete units with plug-in base With logical separation</b> For snap-on mounting onto DIN rail Comprising:									
<ul style="list-style-type: none"> <li>• Plug-in relays</li> <li>• Plug-in base with logical separation and screw terminals</li> <li>• LED module (24 V DC version: LED module with freewheel diode)</li> <li>• Fixing/ejection brackets</li> <li>• Labels</li> </ul>									
4 CO contacts	24 DC	4	28	2	<b>LZS:PT5B5L24</b>		1	5 units	
	24 AC			2	<b>LZS:PT5B5R24</b>		1	5 units	
	115 AC			2	<b>LZS:PT5B5S15</b>		1	5 units	
	230 AC			2	<b>LZS:PT5B5T30</b>		1	5 units	
<b>Complete units, 2CO and 4CO contacts, PT series</b>									
 <p>LZS:PT5D5L24</p>	<b>Complete units with plug-in base With logical separation</b> For snap-on mounting onto DIN rail Comprising:				<b>Push-in terminals</b> 				
	<ul style="list-style-type: none"> <li>• Plug-in relays</li> <li>• Plug-in base with logical separation and push-in terminals</li> <li>• LED module (24 V DC version: LED module with freewheel diode)</li> <li>• Fixing/ejection brackets</li> <li>• Labels</li> </ul>								
	2 CO contacts	24 DC	2	28	2	<b>LZS:PT2D5L24</b>		1	5 units
		230 AC			2	<b>LZS:PT2D5T30</b>		1	5 units
	4 CO contacts	24 DC	4	28	2	<b>LZS:PT5D5L24</b>		1	5 units
		24 AC			2	<b>LZS:PT5D5R24</b>		1	5 units
		115 AC			2	<b>LZS:PT5D5S15</b>		1	5 units
		230 AC			2	<b>LZS:PT5D5T30</b>		1	5 units

**Note:**

Logical separation: The terminals for the contacts and the terminals for the coil are arranged on separate levels, e.g. above for contacts and below for the coil. Logical separation is not necessarily protective separation.

Protective separation: Protective separation prevents voltage of one circuit affecting another circuit with sufficient protection (IEC 61140).



Version	Rated control supply voltage $U_s$ at 50/60 Hz AC	Contacts, number of CO contacts	Width	SD	Article No.	Price per PU	PU (UNIT, SET, M)	PS*
	V		mm	d				

**Individual modules for customer assembly, PT series**



LZX:PT370024

**Mini industrial relays**

- With push-to-test and mechanical flag, without LED<sup>1)</sup>

24 DC	2	22.5	▶	LZX:PT270024	1	1 unit
	3		▶	LZX:PT370024		
	4		▶	LZX:PT570024		
24 AC	2	22.5	▶	LZX:PT270524	1	1 unit
	3		▶	LZX:PT370524		
	4		▶	LZX:PT570524		
115 AC	2	22.5	▶	LZX:PT270615	1	1 unit
	3		▶	LZX:PT370615		
	4		▶	LZX:PT570615		
230 AC	2	22.5	▶	LZX:PT270730	1	1 unit
	3		▶	LZX:PT370730		
	4		▶	LZX:PT570730		

- With hard gold-plating

24 DC 230 AC	4	22.5	▶	LZX:PT580024	1	1 unit
			▶	LZX:PT580730		

- Without push-to-test

24 DC 230 AC	4	22.5	▶	LZX:PT520024	1	1 unit
			▶	LZX:PT520730		

**Plug-in bases for PT relays**

**Standard plug-in bases**  
For mounting onto DIN rail

				Screw terminals 		
--	2	28	▶	LZS:PT78720	1	1 unit
	3		▶	LZS:PT78730		
	4		▶	LZS:PT78740		



LZS:PT78740

**Plug-in bases with logical separation**  
For mounting onto DIN rail

--	2	28	▶	LZS:PT78722	1	1 unit
	4		▶	LZS:PT78742		



LZS:PT78722

**Plug-in bases with logical separation**  
For mounting onto DIN rail

				Push-in terminals 		
--	2	28	▶	LZS:PT7872P	1	1 unit
	4		▶	LZS:PT7874P		



LZS:PT7874P

<sup>1)</sup> The push-to-test is designed to be non-latching. If the push-to-test is pressed further until 90° has been reached, two small lugs break off and the push-to-test can be latched in position.

**Note:**

Logical separation: The terminals for the contacts and the terminals for the coil are arranged on separate levels, e.g. above for contacts and below for the coil. Logical separation is not necessarily protective separation.

Protective separation: Protective separation prevents voltage of one circuit affecting another circuit with sufficient protection (IEC 61140).



Version	Rated control supply voltage $U_c$ at 50/60 Hz AC	Contacts, number of CO contacts	Width	SD	Article No.	Price per PU	PU (UNIT, SET, M)	PS*
	V		mm	d				

**Individual modules for customer assembly, PT series**

<b>More individual modules</b>								
<b>LED modules</b>								
• Red								
LZS:PTML0024	- With freewheel diode	24 DC	--	12.5	▶	LZS:PTML0024	1	1 unit
	- Without freewheel diode	24 AC/DC	--	12.5	▶	LZS:PTML0524	1	1 unit
		110 ... 230 AC/DC	--	12.5	▶	LZS:PTML0730	1	1 unit
• Green								
LZS:PTMG0024	- With freewheel diode	24 DC	--	12.5	▶	LZS:PTMG0024	1	1 unit
	- Without freewheel diode	24 AC/DC	--	12.5	▶	LZS:PTMG0524	1	1 unit
		110 ... 230 AC/DC	--	12.5	▶	LZS:PTMG0730	1	1 unit
<b>Fixing/ejection brackets for PT base with logical separation</b>								
LZS:PT17021	Screw terminals and plug-in terminals (push-in)	--	--	26	▶	LZS:PT17021	100	10 units
<b>Fixing/ejection brackets for standard plug-in base without logical separation</b>								
LZS:PT17024	Screw terminals	--	--	26	▶	LZS:PT17024	100	10 units
<b>Labels</b>								
LZS:PT17040		--	--	26	▶	LZS:PT17040	100	10 units
<b>RC elements</b>								
LZS:PTMU0524	6 ... 60 AC	--	--	26	▶	LZS:PTMU0524	1	1 unit
	110 ... 230 AC	--	--	26	▶	LZS:PTMU0730	1	1 unit
<b>Freewheel diodes with connection to A1</b>								
LZS:PTMT00A0	6 ... 230 DC	--	--	26	▶	LZS:PTMT00A0	1	1 unit
<b>Connecting cables, 24-pole</b>								
LZS:PTMU0730	Current carrying capacity 12 A, with supply cable, blue	--	--	--	2	3TX7004-8BA00	1	1 unit
<b>Connecting combs for PT screw base</b>								
3TX7004-8BA00	6-pole, 10 A current carrying capacity, natural-colored	--	--	--	5	LZS:PT170R6	1	10 units
		--	--	--	5	LZS:PT170P1	1	10 units
<b>Connecting brackets for PT push-in base</b>								
	2-pole, 10 A current carrying capacity, natural-colored	--	--	--	5	LZS:PT170P1	1	10 units





**Individual modules for customer assembly, MT series, octal base**

<b>Industrial relays, 3CO</b>								
<b>Industrial relays with push-to-test</b>								
LZX:MT326024	Without LED	24 DC	3	35.5	2	LZX:MT321024	1	1 unit
	With LED	24 DC	3	35.5	2	LZX:MT323024	1	1 unit
	Without LED	24 AC	3	35.5	2	LZX:MT326024	1	1 unit
	With LED	24 AC	3	35.5	15	LZX:MT328024	1	1 unit
	Without LED	115 AC	3	35.5	15	LZX:MT326115	1	1 unit
	With LED	115 AC	3	35.5	15	LZX:MT328115	1	1 unit
	Without LED	230 AC	3	35.5	2	LZX:MT326230	1	1 unit
	With LED	230 AC	3	35.5	2	LZX:MT328230	1	1 unit
<b>Plug-in bases</b>								
LZS:MT78750	For mounting onto DIN rail	--	--	38	▶	<b>Screw terminals</b> 		
		--	--	38	▶	LZS:MT78750	1	1 unit
<b>Fixing brackets</b>								
		--	--	38	▶	LZS:MT28800	1	1 unit

**Note:**

Logical separation: The terminals for the contacts and the terminals for the coil are arranged on separate levels, e.g. above for contacts and below for the coil. Logical separation is not necessarily protective separation.

Protective separation: Protective separation prevents voltage of one circuit affecting another circuit with sufficient protection (IEC 61140).

Version	Rated control supply voltage $U_s$ at 50/60 Hz AC	Contacts, number of CO contacts	Width mm	SD d	Article No.	Price per PU	PU (UNIT, SET, M)	PS*		
<b>Complete units, 1CO and 2CO, 5 mm pinning, RT series</b>										
<b>Complete units with standard plug-in base</b> For snap-on mounting onto DIN rail Comprising: • Plug-in relays • Standard plug-in base with screw terminals • LED module (24 V DC version: LED module with freewheel diode) • Fixing/ejection brackets • Labels					<b>Screw terminals</b> 					
 LZS:RT4A4T30	1 CO contact	24 DC	1	15.5	2	LZS:RT3A4L24	1	5 units		
		24 AC				LZS:RT3A4R24			1	5 units
		115 AC				LZS:RT3A4S15			1	5 units
		230 AC				LZS:RT3A4T30			1	5 units
	2 CO contacts	24 DC	2	15.5	2	LZS:RT4A4L24	1	5 units		
		24 AC				LZS:RT4A4R24			1	5 units
	115 AC				LZS:RT4A4S15	1	5 units			
	230 AC				LZS:RT4A4T30	1	5 units			
<b>Complete units with plug-in base With logical separation</b> For snap-on mounting onto DIN rail Comprising: • Plug-in relays • Plug-in base with logical separation and screw terminals • LED module (24 V DC version: LED module with freewheel diode) • Fixing/ejection brackets • Labels										
 LZS:RT4B4T30	1 CO contact	24 DC	1	15.5	2	LZS:RT3B4L24	1	5 units		
		24 AC				LZS:RT3B4R24			1	5 units
		115 AC				LZS:RT3B4S15			1	5 units
		230 AC				LZS:RT3B4T30			1	5 units
	2 CO contacts	24 DC	2	15.5	2	LZS:RT4B4L24	1	5 units		
		24 AC				LZS:RT4B4R24			1	5 units
	115 AC				LZS:RT4B4S15	1	5 units			
	230 AC				LZS:RT4B4T30	1	5 units			
<b>Complete units with plug-in base With logical separation</b> For snap-on mounting onto DIN rail Comprising: • Plug-in relays • Plug-in base with logical separation and push-in terminals • LED module (24 V DC version: LED module with freewheel diode) • Fixing/ejection brackets • Labels					<b>Push-in terminals</b> 					
 LZS:RT3D4L24	1 CO contact	24 DC	1	15.5	2	LZS:RT3D4L24	1	5 units		
		24 AC				LZS:RT3D4R24			1	5 units
		115 AC				LZS:RT3D4S15			1	5 units
		230 AC				LZS:RT3D4T30			1	5 units
	2 CO contacts	24 DC	2	15.5	2	LZS:RT4D4L24	1	5 units		
		24 AC				LZS:RT4D4R24			1	5 units
	115 AC				LZS:RT4D4S15	1	5 units			
	230 AC				LZS:RT4D4T30	1	5 units			

Note:

Logical separation: The terminals for the contacts and the terminals for the coil are arranged on separate levels, e.g. above for contacts and below for the coil. Logical separation is not necessarily protective separation.

Protective separation: Protective separation prevents voltage of one circuit affecting another circuit with sufficient protection (IEC 61140).

Version	Rated control supply voltage $U_c$ at 50/60 Hz AC	Contacts, number of CO contacts	Width	SD	Article No.	Price per PU	PU (UNIT, SET, M)	PS*
	V		mm	d				

**Individual modules for customer assembly, RT series**

<b>Print relays, 1CO and 2CO, 5 mm pinning</b>								
	LZX:RT314024	24 DC	1	12.7	▶	LZX:RT315024	1	1 unit
		230 AC			15	LZX:RT315730	1	1 unit
	LZX:RT78725	<b>Print relays</b>						
		Version with 1 CO contact						
		24 DC	1	12.7	▶	LZX:RT314024	1	1 unit
		24 AC			15	LZX:RT314524	1	1 unit
		115 AC			15	LZX:RT314615	1	1 unit
230 AC			▶	LZX:RT314730	1	1 unit		
Version with 2 CO contacts								
12 DC	2	12.7	5	LZX:RT424012	1	1 unit		
24 DC			▶	LZX:RT424024	1	1 unit		
24 AC			▶	LZX:RT424524	1	1 unit		
115 AC			▶	LZX:RT424615	1	1 unit		
230 AC			▶	LZX:RT424730	1	1 unit		
<b>Standard plug-in bases</b>						<b>Screw terminals</b> 		
For mounting onto DIN rail								
--	--	--	15.5	▶	LZS:RT78725		1	1 unit
<b>Plug-in bases with logical separation</b>								
For mounting onto DIN rail								
--	--	--	15.5	▶	LZS:RT78726		1	1 unit
<b>Plug-in bases with logical separation</b>						<b>Push-in terminals</b> 		
For mounting onto DIN rail								
--	--	--	15.5	▶	LZS:RT7872P		1	1 unit
<b>LED modules</b>								
• Red								
With freewheel diode	24 DC	--	15.5	▶	LZS:PTML0024		1	1 unit
Without freewheel diode	24 AC/DC	--		▶	LZS:PTML0524		1	1 unit
	110 ... 230 AC/DC	--		▶	LZS:PTML0730		1	1 unit
• Green								
With freewheel diode	24 DC	--	15.5	▶	LZS:PTMG0024		1	1 unit
Without freewheel diode	24 AC/DC	--		▶	LZS:PTMG0524		1	1 unit
	110 ... 230 AC/DC	--		▶	LZS:PTMG0730		1	1 unit
<b>Fixing/ejection brackets for RT base</b>								
--	--	--	15.5	▶	LZS:RT17016		100	10 units
<b>Labels</b>								
--	--	--	15.5	▶	LZS:RT17040		100	10 units
<b>RC elements</b>								
	6 ... 60 AC	--	15.5	▶	LZS:PTMU0524		1	1 unit
	110 ... 230 AC	--		▶	LZS:PTMU0730		1	1 unit
<b>Freewheel diodes with connection to A1</b>								
	6 ... 230 DC	--	15.5	▶	LZS:PTMT00A0		1	1 unit
<b>Connecting cables, 24-pole</b>								
Current carrying capacity	--	--	--	2	3TX7004-8BA00		1	1 unit
12 A, with supply cable, blue								
<b>Connecting combs for RT screw base</b>								
8-pole, 10 A current carrying capacity, natural-colored	--	--	--	▶	LZS:RT170R8		1	10 units
<b>Connecting brackets for push-in base</b>								
2-pole, 10 A current carrying capacity, natural-colored	--	--	--	5	LZS:RT170P1		100	10 units



LZX:RT314024



LZX:RT78725



LZS:RT78726



LZS:RT7872P



LZS:PTML0024



LZS:RT17016



LZS:RT17040





LZS:PTMU0730

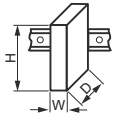

3TX7004-8BA00

## Technical specifications

More information									
Technical specifications, see <a href="https://support.industry.siemens.com/cs/ww/en/ps/16204/td">https://support.industry.siemens.com/cs/ww/en/ps/16204/td</a>					Manuals, see <a href="https://support.industry.siemens.com/cs/ww/en/ps/16204/man">https://support.industry.siemens.com/cs/ww/en/ps/16204/man</a>				
Relay type	<b>LZX:RT print relay, 8-pin, (12.7 mm) 1 CO / 2 CO</b>				<b>LZX:PT industrial relay, 8-, 11- and 14-pin, (22.5 mm) 2 CO / 3 CO / 4 CO</b>				
General data									
<b>Dimensions (W x H x D)</b>									
<ul style="list-style-type: none"> <li>LZX:RT.A4 / LZS:PT.A5</li> <li>LZX:RT.B4 / LZS:PT.B5</li> <li>LZX:RT.D4 / LZS:PT.D5</li> </ul>									
		mm	15.5 x 78 x 71					28 x 74 x 72	
		mm	15.5 x 77 x 71					28 x 77 x 79	
		mm	15.5 x 98 x 71					28 x 98 x 79	
<b>Rated control supply voltage <math>U_s</math><sup>1)</sup></b>	V	24 DC	24 AC	115 AC	230 AC	24 DC	24 AC	115 AC	230 AC
<b>Rated insulation voltage <math>U_i</math></b> (Pollution degree 3)	V	250							
<b>Overvoltage category</b> Acc. to IEC 60664-1	III								
<b>Protective separation</b> Between coil and contacts Acc. to IEC 60947-1, Appendix N	Up to 250 V (with plug-in base LZS:RT78726) No (for complete units with standard base)							No	
<b>Degree of protection</b>	<ul style="list-style-type: none"> <li>Relays</li> <li>Bases</li> </ul>								IP50
<b>Permissible ambient temperature</b>		°C	-40 ... +70						
		°C	-40 ... +80						
Conductor cross-sections									
Connection type									
 <b>Screw terminals</b>									
<ul style="list-style-type: none"> <li>Solid</li> <li>Finely stranded with end sleeve</li> <li>Corresponding opening tool</li> </ul>									
	mm <sup>2</sup>	2 x 2.5							
	mm <sup>2</sup>	2 x 1.5							
	Screwdriver, size 3.0 ... 3.5 mm x 0.5 mm (3RA2908-1A)								
Connection type									
 <b>Push-in terminals</b>									
<ul style="list-style-type: none"> <li>Solid</li> <li>Finely stranded without end sleeve</li> <li>Finely stranded with end sleeve</li> </ul>									
	mm <sup>2</sup>	1 x (0.75 ... 1.5), 2 x (0.75 ... 1.0), 2 x 1.5							
	mm <sup>2</sup>	1 x (0.75 ... 1.5), 2 x (0.75 ... 1.0), 2 x 1.5							
	mm <sup>2</sup>	1 x (0.75 ... 1.0), 2 x 0.75, 1 x 1.5							

<sup>1)</sup> AC voltages, 50 Hz; for 60 Hz operation, the lower response value must be increased by 10%; the power loss will decrease slightly.

# Coupling Relays

## LZX coupling relays with plug-in relays

Relay type		LZX:RT print relay, 8-pin, (12.7 mm) 1 CO / 2 CO				LZX:PT industrial relay, 8-, 11- and 14-pin, (22.5 mm) 2 CO / 3 CO / 4 CO			
Rated control supply voltage $U_s$ <sup>1)</sup>	V	24 DC	24 AC	115 AC	230 AC	24 DC	24 AC	115 AC	230 AC
<b>Control side</b>									
<b>Operating range factor</b>		0.9 ... 1.4		0.9 ... 1.1		0.9 ... 1.4		0.9 ... 1.1	
<b>Power consumption at <math>U_s</math></b>									
• AC	VA	--	0.75			--	1		
• DC	W	0.4	--			0.75	--		
<b>Release voltage</b>	V	2.4	7.2	34.5	69	3.6	7.2	34.5	69
<b>Protection circuit</b>		Freewheel diode for complete unit				Freewheel diode in LED module			
<b>Load side</b>									
<b>Switching voltage</b> AC/DC	V	24 ... 250							
<b>Rated currents<sup>2)</sup></b>									
• Conventional thermal current $I_{th}$									
- 1 CO contact	A	16				--			
- 2 CO contacts	A	6				12			
- 3 CO contacts	A	--				10			
- 4 CO contacts	A	--				6			
• Rated operational current $I_e$ /AC-15 acc. to utilization categories (IEC 60947-5-1)	A	RT3 (1 CO contact): 6 RT4 (2 CO contacts): 2.5				PT2 (2 CO contacts): 5 PT3 (3 CO contacts): 5 PT5 (4 CO contacts): 4 (DC coils), 2 (AC coils)			
• Rated operational current $I_e$ DC-13 with suppressor diode acc. to utilization categories (IEC 60947-5-1)	A	2 at 24 V, 0.27 at 230 V				PT2, PT3, PT5: 4 at 24 V, 0.5 at 230 V			
<b>Short-circuit protection</b>									
Short-circuit test with fuse links of operational class gG with short-circuit current $I_k = 1$ kA acc. to IEC 60947-5-1									
• DIAZED, type 5SB	A	10				6			
<b>Min. contact load</b> (reliability: 1 ppm)		Standard 17 V, 10 mA; hard gold-plated 17 V/0.1 mA				Standard 17 V, 10 mA; hard gold-plated 20 V/1 mA			
<b>Mechanical endurance</b>	Operating cycles	30 x 10 <sup>6</sup>		10 x 10 <sup>6</sup>					
<b>Electrical endurance</b> (resistive load at 250 V AC)	Operating cycles	1 x 10 <sup>5</sup>							

<sup>1)</sup> AC voltages, 50 Hz; for 60 Hz operation, the lower response value must be increased by 10%; the power loss will decrease slightly.

<sup>2)</sup> Capacitive loads can result in micro-welding on the contacts.

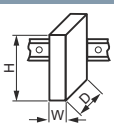
Relay type		LZS industrial relays: MT, 11-pin, octal base (35.5 mm) 3 CO contacts			
<b>General data</b>					
<b>Dimensions (W x H x D)</b>	mm	36 x 69 x 36			
					
<b>Rated control supply voltage <math>U_s</math><sup>1)</sup></b>	V	24 DC	24 AC	115 AC	230 AC
<b>Rated insulation voltage <math>U_i</math></b> (Pollution degree 3)	V	250			
<b>Overvoltage category</b> Acc. to IEC 60664-1	III				
<b>Protective separation</b> Between coil and contacts Acc. to IEC 60947-1, Appendix N	No				
<b>Degree of protection of relays/bases</b>					
• Relays	IP50				
• Bases	IP20				
<b>Permissible ambient temperature</b>					
• During operation	°C	-40 ... +60	-45 ... +50		
• During storage	°C	-45 ... +80			
<b>Conductor cross-sections</b>					
Connection type	⊕ Screw terminals				
• Solid	mm <sup>2</sup>	2 x 2.5			
• Finely stranded with or without end sleeve	mm <sup>2</sup>	2 x 1.5			
• Corresponding opening tool	Screwdriver, size 1 or Pozidriv 1				
<b>Control side</b>					
<b>Operating range</b>	V	18 ... 38	19.2 ... 38	92 ... 137	184 ... 264
<b>Power consumption</b>					
• AC	VA	--	2.3		
• DC	W	1.2	--		
<b>Release voltage</b>	V	2.4	9.6	46	92
<b>Protection circuit</b>	--				
<b>Load side</b>					
<b>Switching voltage</b>					
• AC/DC	V	24 ... 250			
<b>Rated currents<sup>2)</sup></b>					
• Conventional thermal current $I_{th}$	A	10			
• Rated operational current $I_e$ /DC-13 acc. to utilization categories (IEC 60947-5-1)	A	2 at 24 V, 0.27 at 230 V			
• Rated operational current $I_e$ /AC-15 acc. to utilization categories (IEC 60947-5-1)	A	5 at 24 V and 230 V			
<b>Short-circuit protection</b>					
Short-circuit test with fuse links of operational class gG with short-circuit current $I_k = 1$ kA acc. to IEC 60947-5-1					
• DIAZED, type 5SB	A	10			
<b>Min. contact load</b> (reliability: 1 ppm)	12 V DC/10 mA				
<b>Mechanical endurance</b>	Operat- ing cycles	20 x 10 <sup>6</sup>			
<b>Electrical endurance</b> (resistive load at 250 V AC)	Operat- ing cycles	4 x 10 <sup>5</sup>			

<sup>1)</sup> AC voltages, 50 Hz; for 60 Hz operation, the lower response value must be increased by 10%; the power loss will decrease slightly.

<sup>2)</sup> Capacitive loads can result in micro-welding on the contacts.