

SIEMENS

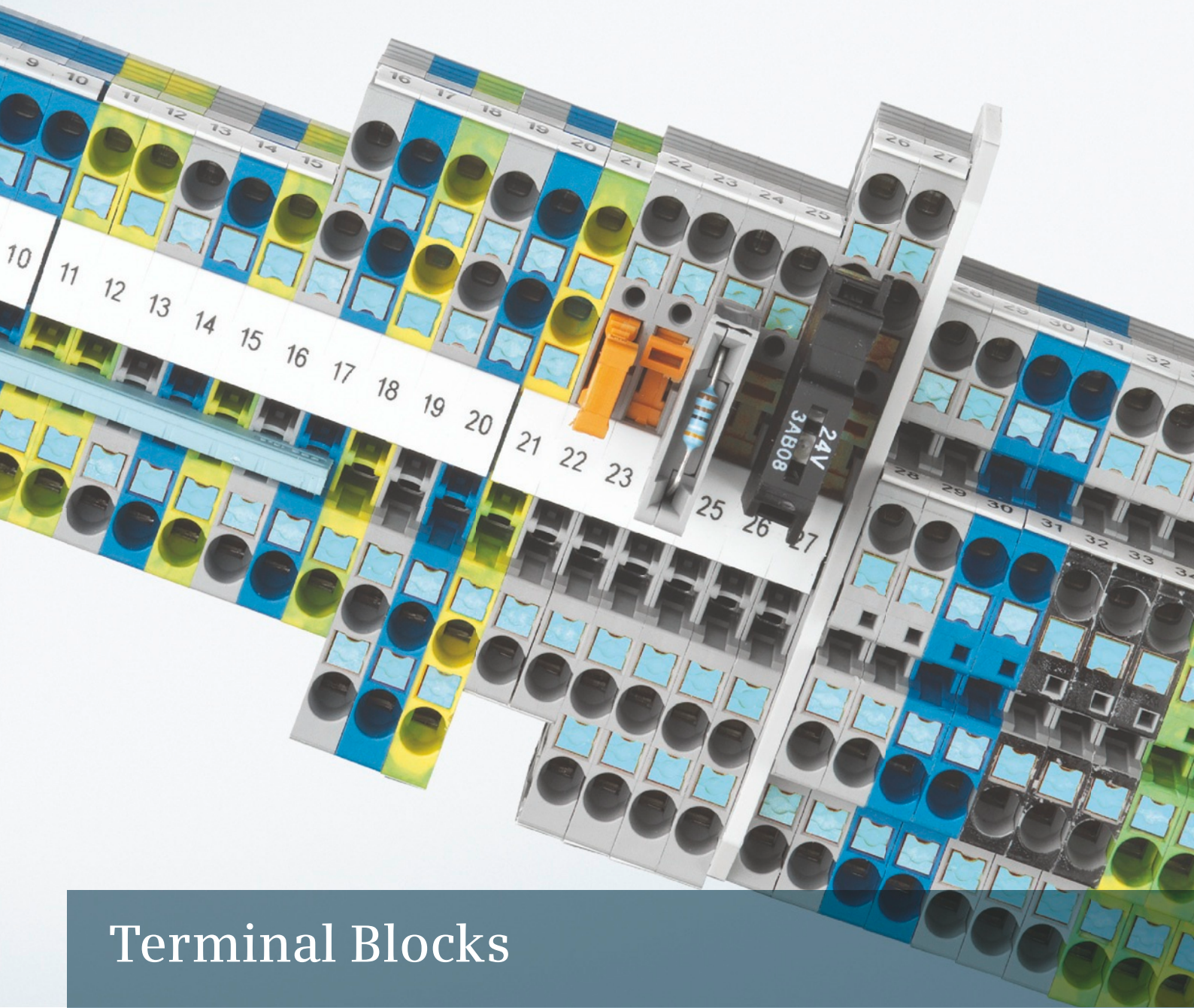

# Terminal Blocks

ALPHA FIX – Edition 2017

Catalog  
LV 52

Update  
commercial  
data 2017

[siemens.com/alpha](http://siemens.com/alpha)

## Related catalogs

**Low-Voltage Power Distribution and Electrical Installation Technology** LV 10  
 SENTRON • SIVACON • ALPHA  
 Protection, Switching, Measuring and Monitoring Devices, Switchboards and Distribution Systems print (E86060-K8280-A101-A2-7600)



**Standard-Compliant Components for Photovoltaic Systems** LV 11  
 SENTRON • SIVACON • ALPHA  
 print (E86060-K8270-A101-A2-7600)



**Electrical Components for the Railway Industry** LV 12  
 SENTRON • ALPHA • DELTA  
 print (E86060-K1812-A101-A1-7600)



**Components for Industrial Control Panels according to UL Standards** LV 16  
 SIRIUS • SENTRON • ALPHA  
 print (E86060-K1816-A101-A3-7600)



**SIVACON** LV 50  
 System Cubicles, System Lighting and System Air-Conditioning  
 PDF (E86060-K1920-A101-A7-7600)



## Industry Mall / CA 01

**Industry Mall**  
 Information and Ordering Platform in the Internet:

[www.siemens.com/industrymall](http://www.siemens.com/industrymall)



**Products for Automation and Drives** CA 01  
 Interactive Catalog, DVD  
 E86060-D4001-A510-D6-7600



## Trademarks

All product designations may be registered trademarks or product names of Siemens AG or other supplying companies. Third parties using these trademarks or product names for their own purposes may infringe upon the rights of the trademark owners. Further information about low-voltage power distribution and electrical installation is available on the Internet at:

[www.siemens.com/lowvoltage](http://www.siemens.com/lowvoltage)

## Contents

Air circuit breakers • Molded case circuit breakers • Miniature circuit breakers • Residual current protective devices / AFDDs • Fuse systems • Overvoltage protection devices • Switch disconnectors • Switching devices • Transformers, power supply units and socket outlets • Busbar systems • Measuring devices and power monitoring • Monitoring devices • Software • Switchboards • Busbar trunking systems • System cubicles, system lighting and system air-conditioning • Distribution boards • Molded-plastic distribution systems • 8WH2 spring-loaded terminals

Products for the DC side • Products for the AC side • Measuring and monitoring devices • Distribution systems and system cubicles • Terminal blocks

Miniature circuit breakers • Residual current protective devices • Fuse systems • Switch disconnectors • Switching devices • ALPHA FIX terminal blocks • DELTA profil • Medium-Voltage components

Circuit breakers • Air circuit breakers/Molded case switches • Molded case circuit breakers • Miniature circuit breakers • Fuse systems • Switch disconnectors • Switching devices • Socket outlets • Busbar systems • Measuring devices and power monitoring • Molded-plastic distribution systems • Terminal blocks

System overview • Frame • Enclosure • Expansion • Preconfigured cubicles • Special cubicles • SIVACON 8MF/8MR system lighting • SIVACON 8MR system air-conditioning

## Catalog PDF / Response E-mail

### Catalog PDF

Internet:  
[www.siemens.com/lowvoltage/infomaterial](http://www.siemens.com/lowvoltage/infomaterial)



### Response E-mail

Please send your comments and suggestions for improvement to

[catalogs.industry@siemens.com](mailto:catalogs.industry@siemens.com)  
 (include the catalog name in the subject field)



## Technical Support

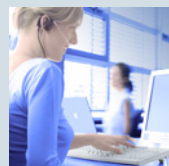

Expert advice on technical questions with a wide range of demand-optimized services for all our products and systems.

[www.siemens.com/lowvoltage/contact](http://www.siemens.com/lowvoltage/contact)

# Terminal Blocks

SENTRON

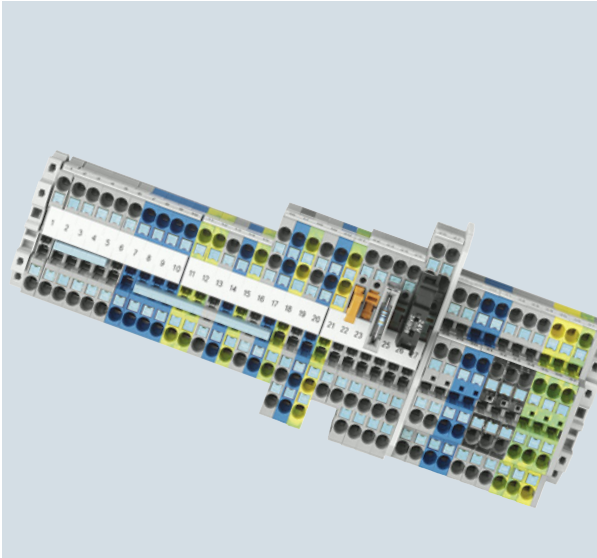

## Catalog LV 52 · 2017

Supersedes:  
Catalog LV 52 · 2016

Refer to the Industry Mall for current updates of this catalog:

[www.siemens.com/industrymall](http://www.siemens.com/industrymall)

The products contained in this catalog can also be found in the Interactive Catalog CA 01.

Article No.: E86060-D4001-A510-D7-7600

Please contact your local Siemens branch.

© Siemens AG 2017

	Introduction	1
8WH	8WH6 iPo Plug-In Terminals	2
	8WH6 iPo Installation Terminals	3
	8WH2 Spring-Loaded Terminals	4
	8WH5 Combination Plug-In Terminals	5
	8WH3 Insulation Displacement Terminals	6
	8WH1 Screw Terminals	7
	Accessories for 8WH Terminal Blocks	8
8WA	8WA1 Screw Terminals	9
	8WA2 Spring-Loaded Terminals	10
	Accessories for 8WA Terminal Blocks	11
	Appendix	12



## Totally Integrated Power We bring power to the point – safely and reliably.



Comprehensive solutions for electricity distribution in complex power systems from Siemens

A reliable, highly available and flexible power supply for industries and for buildings and facilities across all voltage levels is the basis for both industrial processes and infrastructure solutions. The solution from Siemens is Totally Integrated Power (TIP), which is linked closely to industrial and building automation systems and into which a company's IT systems can be integrated. This makes it possible to fully exploit the entire optimization potential of an integrated solution. TIP meets even the highest of requirements of systems that are critical in terms of power supply.

TIP is our comprehensive power supply portfolio that contains software and hardware products, systems and solutions for all voltage levels – from the high-voltage power infeed to the low-voltage power load. Comprehensive support throughout the lifecycle from planning to maintenance round off our offer.

More information: [www.siemens.com/tip](http://www.siemens.com/tip)

# Totally Integrated Power offers more:

- **Consistency:**  
For simplified system planning and commissioning and also easy integration in automation solutions for buildings or production processes
- **Everything from a single source:**  
One reliable partner with a complete portfolio for the entire process and lifecycle – from the first idea to after-sales service
- **Safety:**  
Comprehensive range of protective components for cable, personal and fire protection, safety thanks to design and type tests
- **Reliability:**  
A reliable partner that develops long-lasting solutions with the highest quality standards together with the customer
- **Cost-effectiveness:**  
Bringing power to the point means higher system availability and top energy efficiency in power distribution
- **Flexibility:**  
Consistency and modularity of Totally Integrated Power for any required expandability and adaptation to future requirements
- **Progressive technology:**  
Reliable power supply especially in the case of supply-critical applications, continuous enhancement of technology

## Challenges are our strength

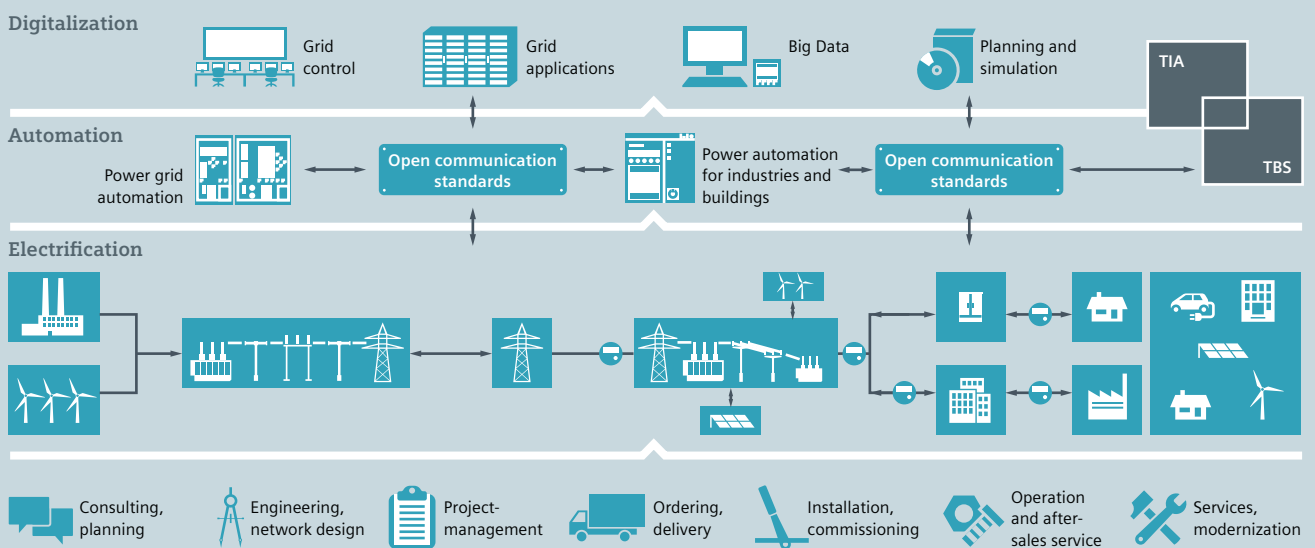



### The right one for everyone

Our portfolio includes switchboards, distribution boards, protection, switching, measuring and monitoring devices, switches and socket outlets. All over the world, the universality, modularity and efficiency of our components and systems give you innumerable benefits – all the time they are in use. With products developed according to the respective international standards, we offer forward-looking design with innovative functions while ensuring the highest quality standards worldwide.

### Sustainability in focus

As one of the worldwide leaders in the provision of high-quality, standard-compliant products and systems for low-voltage power distribution, we contribute to the sustainable and responsible handling of electrical energy. With our integrated portfolio which ranges from power supply and distribution, through short-circuit and overload protection through to power monitoring, we support the implementation of environmentally friendly energy concepts based on wind power, photovoltaics, intelligent buildings and electromobility.

# Universal, safe and efficient power distribution

Whether in industrial plants, in infrastructure or in buildings:

every technical plant depends on the reliable supply of electricity. Our products provide a safe, reliable and efficient electrical infrastructure at the medium and low-voltage levels. Our components reliably protect against accidents, faults and fires caused by electrical installations and allow consumers to utilize electrical power in a sustainable, responsible manner. We are happy to help you with comprehensive support from the initial information stage through to operation.

## Everything for power distribution

End-to-end solutions are required for electrical power distribution in buildings. Our answer is Totally Integrated Power (TIP). TIP stands for innovative products, systems and software tools which ensure the safe and reliable distribution of electric power. They are supplemented by circuit breakers and modules with communication capability which connect the power distribution system to the building automation or industrial automation solutions. These in turn can be linked to a comprehensive energy management system which contributes to optimizing the consumption of electricity, hence lowering the costs of operation.

## Excellent support

As a competent and reliable partner, we also offer you comprehensive support – from the initial information gathering stage, through planning, configuring and ordering up to commissioning, operation and technical support. We know the needs of your working environment and your daily business. This enables us to offer you flexible and high quality support, allowing you to concentrate on your customers and their needs.

# Planning Efficiency

## Overview

With Planning Efficiency, Siemens supplies answers to typical questions that often present themselves in electrical planning:

- What is the appropriate product for my application?
- Where can I find product data?
- How can I make processes more efficient and save more time?

The entire electronic support offered by Siemens is merged under Planning Efficiency. At each phase of the project, online functions make the everyday work of the planners easier and more efficient. Planning Efficiency focuses on optimizing the control cabinet configuration among other things.

Especially in this early phase, up to 80% of time and costs can be saved.

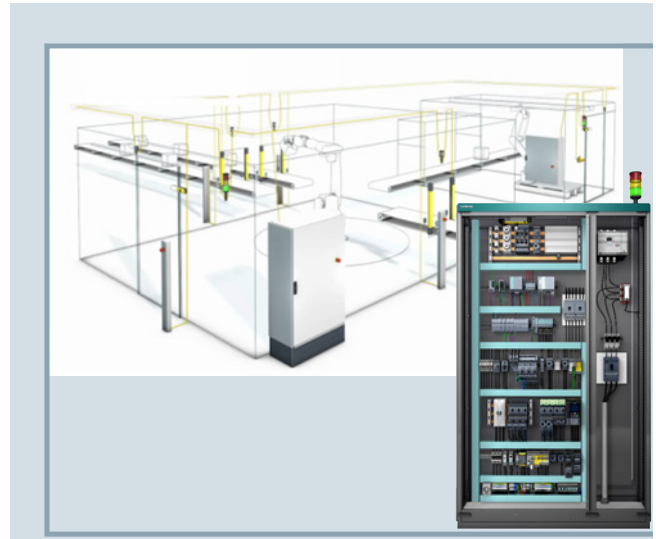

In order to supply the planners with all they need and to simplify the modern electrical planning of every aspect of the control cabinet configuration, the electrical support of Planning Efficiency focuses on four benefits:

- Finding the right product faster using intuitive product selection
- Time savings of up to 80 % with universal product data for your CAE and CAD systems
- User-friendly compilation of project-specific documentation
- Comprehensive support – at any time, whatever your location





## Process phases

At each phase of the process, Siemens provides comprehensive online functions free of charge.

This ensures that all the necessary information and product data are available around the clock at any location worldwide.



### Configurators for products and systems

With just a few mouse clicks, you will find yourself guided by the configurator to a suitable product or system. Simply enter the relevant parameters and select your individual solution.

### CAX Download Manager

The CAX Download Manager can supply you with all the necessary CAX file types for the products of your choice for use in all common CAE and CAD systems. The data contained in the files is continuously updated. The whole process involves only four selection steps and is free of charge. All the files you select will then be compiled into a zip file and made available for you to download for further use. This results in a time saving of up to 80 % because there is no need for manual data collection thanks to the universal manufacturer data for all commonly used CAE and CAD systems.

### My Documentation Manager

To provide support when creating the plant documentation, we have developed a manual configurator. My Documentation Manager enables you to assemble the standard-compliant plant documentation individually with just a few clicks of the mouse. Simply select the required sections from the existing manuals of the installed Siemens products.

### EPLAN Electric P8 Macro – a big plus for EPLAN users

Using the EPLAN Electric P8 Macro in .edz exchange format (EPLAN Data Archived Zipped) the overall time required for data integration can be further reduced. With just a few clicks, the data types for any number of article numbers can be imported and combined. In this way, it is possible for the installed Siemens products to be displayed across different pages of the circuit diagram quickly and easily.

### At a glance

Without Planning Efficiency a lot of time would often be lost due to manual data transmission. Now you are able to concentrate on the essentials. All necessary information and product data is provided by Siemens for easy retrieval.

This makes the control cabinet configuration process more efficient and simplifies your everyday work.

For more information, see [www.siemens.com/planning-efficiency](http://www.siemens.com/planning-efficiency).

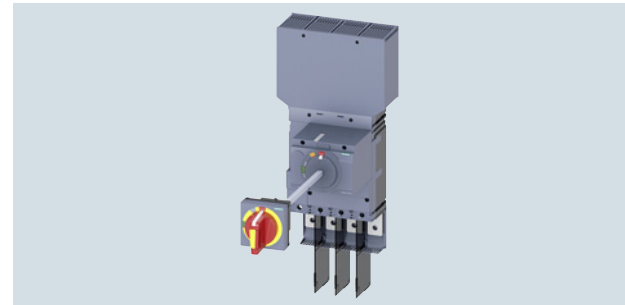

The configurator supplies the appropriate 3D models and dimension drawings for the control cabinet construction diagram.

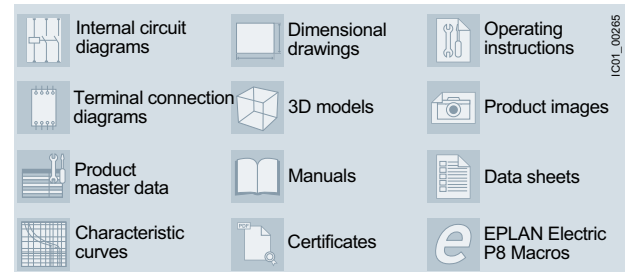

The CAX Download-Manager makes 11 universal data types available, as well as the EPLAN Electric P8 macro.

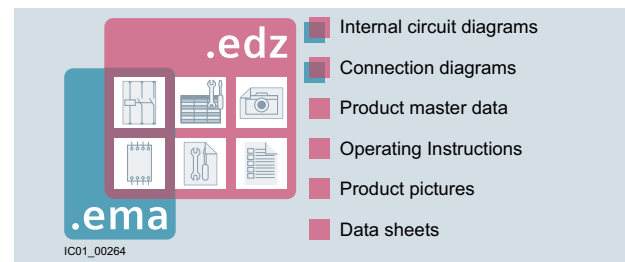

The EPLAN Electric P8 macro in .edz exchange format offers even more compared to the .ema exchange format.



Find out more about Planning Efficiency in our informative videos

# Technical Support

The Technical Support for low-voltage power distribution and electrical installation technology assists you with all your technical queries about our products and systems – both before and after delivery.

## Still have questions?

Our experts will help you with competent specialist support



Competent and fast specialist advice on:

- Product selection
- Commissioning
- Issues during operation
- Possible special versions
- Special requirements
- Product features
- Device communication

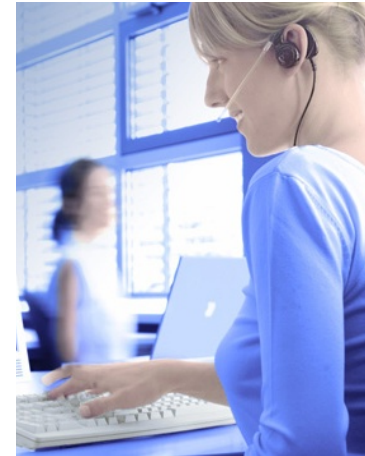

1201\_19185

## Get all the information you need – with just one click

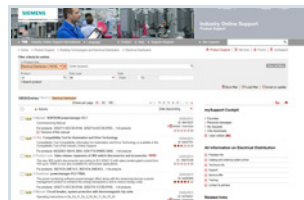

**Technical Support – fast online access to the latest information (Service and Support)**

[www.siemens.com/lowvoltage/product-support](http://www.siemens.com/lowvoltage/product-support)

In Product Support you will find FAQs, manuals, certificates, applications and tools, etc.



**Support Request – the quickest route to the experts**

[www.siemens.com/lowvoltage/technical-support](http://www.siemens.com/lowvoltage/technical-support)

You can put your question directly to our Technical Support team using the Support Request Form in Online Support.

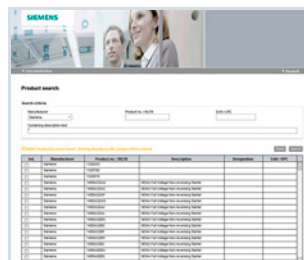

**Conversion tool – the easy and efficient way of finding successor products**

[www.siemens.com/lowvoltage/conversion-tool](http://www.siemens.com/lowvoltage/conversion-tool)

### The benefits for you

- Response within 4 hours in 93% of cases
- Direct support from an experienced team of engineers and technicians

# Get all the information you need – with just one click

**3VA Molded Case Circuit Breakers**

**SENTRON**  
Protection, Switching, Measuring and Monitoring Devices

**SIVACON**  
Switchboards and Busbar Trunking Systems

**ALPHA**  
Distribution Systems and Terminal Blocks

Catalog LV 10 • 2015: SENTRON • SIVACON • ALPHA (English)

Infrastructure

Industry

Photovoltaik

Windenergy

Support

Last viewed

[www.siemens.com/lowvoltage/lv-explorer](http://www.siemens.com/lowvoltage/lv-explorer)

**LV Explorer – Discover Low Voltage in 3D**  
Get comprehensive and specific information about our products using our 3D animations, trailers and technical information.

I201\_19157

Information	Planning/Orders	Operation/Service	Training
<ul style="list-style-type: none"> <li>– Website</li> <li>– Catalogs &amp; Brochures</li> <li>– Newsletter</li> <li>– Picture Database</li> </ul>	<ul style="list-style-type: none"> <li>– Industry Mall</li> <li>– Configuration</li> <li>– SIMARIS Planning Tools</li> <li>– CAx-Download-Manager</li> </ul>	<ul style="list-style-type: none"> <li>– Siemens Industry Online Support (SIOS)</li> <li>– My Documentation Manager</li> <li>– Technical Support</li> <li>– Support Request</li> </ul>	<ul style="list-style-type: none"> <li>– SITRAIN Portal</li> </ul>

[www.siemens.com/lowvoltage/support](http://www.siemens.com/lowvoltage/support)

**Always at your service – every step of the way**  
We offer comprehensive support, from planning and configuration to operation.

I201\_19079

# Notes

## Introduction

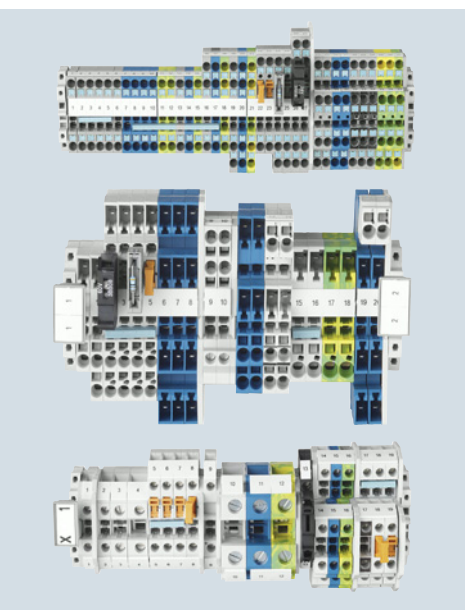

### 8WH and 8WA terminal blocks

- 1/2 General data
- 1/3 Support rails/protective conductor busbars

### 8WH terminal blocks

- 1/4 8WH order selection

### For further technical product information:

Siemens Industry Online Support:  
[www.siemens.com/lowvoltage/product-support](http://www.siemens.com/lowvoltage/product-support)

- Application example
- Certificate
- Characteristic
- Download
- FAQ
- Manual
- Product note
- Software archive
- Technical data













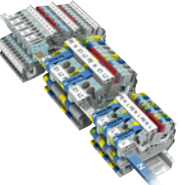

## Introduction

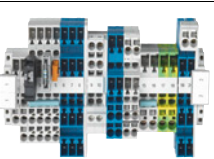
### 8WH and 8WA Terminal Blocks

#### General data

1

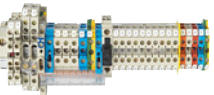
#### Overview

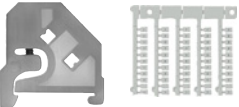
		Connection system	Section	Special features
<b>8WH Terminal Blocks</b>				
		8WH6 iPo plug-in terminals (iPo: in-Push-out)	2	The iPo connection method combines the advantages of spring-loaded and plug-in terminals – both rigid and flexible wires are easy to insert without the need for tools. Fast installation – with a minimum of effort and maximum contact stability.
		8WH6 iPo installation terminals	3	The iPo connection method combines the advantages of spring-loaded and plug-in terminals – both rigid and flexible wires are easy to insert without the need for tools. Fast installation – with a minimum of effort and maximum contact stability. Fast removal by simply pressing the unlatching button.
		8WH2 spring-loaded terminals	4	With the spring-loaded connection method, the tension spring exerts constant pressure on the conductor, which ensures excellent contact stability – even with applications subject to high levels of vibration. Fast removal by simply pressing the unlatching button.
		8WH5 combination plug-in terminals	5	Combination plug-in terminals are used where high availability is essential in the event of a fault. The contact system is able to withstand even extreme levels of vibration and both the terminal and the connector are fingerproof.
		8WH3 insulation displacement terminals	6	Thanks to the use of insulation displacement terminals, there is no need to strip the conductor. This ensures secure contact between the conductor and the connecting wire of the terminal.
		8WH1 screw terminals	7	The screw terminals have an impressively compact design and offer optimum handling. The elastic deformation capability of the terminal body prevents any creepage of the clamped conductor. Suitable for applications up to 1000 V DC.
		Accessories for 8WH	8	The 8WH accessories supplement the 8WH product range with the additional components required for installation.
<b>8WA terminal blocks</b>				
		8WA1 screw terminals	9	The tried and tested screw terminals are insulated on both sides and enclosed at both ends. These terminals are extremely robust and can withstand high mechanical and thermal loads.
		8WA2 spring-loaded terminals • 8WA2 initiator/actuator terminals	10	Fast and cost-effective connection of signal transmitters.
		Accessories for 8WA	11	The 8WA terminal block accessories supplement the 8WA product range with the additional components required for installation.

#### Rated short-time withstand current

Our terminals are able to withstand a rated short-time current corresponding to a current density of 120 A/mm<sup>2</sup> specific to the

rated cross-section for one second.

### Overview

Support rail type							Excerpt from IEC 60947-7-2/EN 60947-7-2/ VDE 0611 Part 3		
Width	Height	Thick- ness	Perforation type	Material	Surface	Rail profile	Short-circuit strength (Cu conductor)	Short-time withstand current, 1 s	Max. permissible thermal rated current with PEN function
mm	mm	mm					mm <sup>2</sup> <sup>1)</sup>	kA	A
35	7.5	1.5	Non-perforated	Steel	Chromated	Standard mounting rail, acc. to EN 60 715 – 35 × 7.5	16	1.92	<sup>1)</sup>
35	7.5	1.5	With holes	Steel	Chromated	Standard mounting rail, acc. to EN 60 715 – 35 × 7.5	16	1.92	<sup>2)</sup>
35	7.5	1.5	Non-perforated	Steel	Galvanized	Standard mounting rail, dimensions acc. to EN 60 715 – 35 × 7.5	16	1.92	<sup>2)</sup>
35	7.5	1.5	With holes	Steel	Galvanized	Standard mounting rail, dimensions acc. to EN 60 715 – 35 × 7.5	16	1.92	<sup>2)</sup>
35	7.5	1.5	Non-perforated	V2A high- grade steel	Chromated	Standard mounting rail, dimensions acc. to EN 60 715 – 35 × 7.5	16	1.92	<sup>2)</sup>
35	7.5	1.5	Non-perforated	Copper	Chromated	Standard mounting rail, dimensions acc. to EN 60 715 – 35 × 7.5	50	6.0	150
35	7.5	1.5	Non-perforated	Aluminum	Chromated	Standard mounting rail, dimensions acc. to EN 60 715 – 35 × 7.5	35	4.2	125
35	15	2.3	Non-perforated	Steel	Chromated	Standard mounting rail, acc. to EN 60 715 – 35 × 15	50	6.0	<sup>2)</sup>
35	15	1.5	Non-perforated	Steel	Chromated	Standard mounting rail, similar to EN 60 715 – 35 × 15	35	4.2	<sup>2)</sup>
35	15	1.5	With holes	Steel	Chromated	Standard mounting rail, similar to EN 60 715 – 35 × 15	35	4.2	<sup>2)</sup>
35	15	1.5	Non-perforated	Steel	Galvanized	Standard mounting rail, similar to EN 60 715 – 35 × 15	35	4.2	<sup>2)</sup>
35	15	1.5	With holes	Steel	Galvanized	Standard mounting rail, similar to EN 60 715 – 35 × 15	35	4.2	<sup>2)</sup>
35	15	1.5	Non-perforated	Copper	Chromated	Standard mounting rail, similar to EN 60 715 – 35 × 15	95	11.4	232
35	15	1.5	Non-perforated	Aluminum	Chromated	Standard mounting rail, similar to EN 60 715 – 35 × 15	70	8.4	192

<sup>1)</sup> Cross-sections calculated acc. to IEC 60439-1 / EN 60 439-1 / EN 60439-1 / VDE 0660 Part 500.

<sup>2)</sup> Steel protective conductor busbars are not permissible for PEN function.

## Introduction

### 8WH Terminal Blocks

#### 8WH order selection

Terminal type	Connection type	Design	Number of terminals	Version	MLFB digits 1 ...9 MLFB digits 8...12
Installation terminals	iPo	Standard	2	L	8WH6001-
			4	L/L	8WH6001-
			4	L/N	8WH6001-
			5	PE/L/L	8WH6001-
			5	PE/L/N	8WH6001-
			5	PE/L/NT	8WH6001-
			5	PE/L/N isolating blade	8WH6001-
			5	PE/L/L isolating blade	8WH6001-
			5	PE/L/L through-type term. for isolat. term.	8WH6001-
			5	PE/L/L isolation	8WH6001-
			Spring-loaded terminals	Two-tier	4
	4	N/PE			8WH2020-
	4	N/L			8WH2020-
	Three-tier	6		PE/L/N	8WH2030-
		6	PE/L/L	8WH2030-	

Article No., e.g.

8WH6001-

4FF00

**Insta terminal:** Plug-in design · 5 connection points  
2.5 mm<sup>2</sup> · Range of functions



	1.5 mm <sup>2</sup>			2.5 mm <sup>2</sup>				4 mm <sup>2</sup>		
	Through-type terminal, gray	Through-type terminal, blue	PE terminal, green/yellow	Through-type terminal, gray	Through-type terminal, blue	PE terminal	Terminals with range of functions	Through-type terminal, gray	Through-type terminal, blue	PE terminal, green/yellow
							4QF00			
							4DF00			
							4CF00			
							4HF00			
							4EF00			
							4FF00			
							4GF00			
							4NF00			
							4PF00			
							4MF00			
							4AF00			
							4BF00			
							4CF00			
							4EF00			
							4HF00			

I201\_18327a

## Introduction

## 8WH Terminal Blocks

## 8WH order selection

1

Connection type	Terminals	Design	Number of terminals MLFB digits 1...7	MLFB digits 8...12	1.5 mm <sup>2</sup>				2.5 mm <sup>2</sup>						
					Through-type terminal, gray	Through-type terminal, colored	Through-type terminal, blue	PE terminal, green/yellow	Through-type terminal, gray	Through-type terminal, colored	Through-type terminal, blue	Instrument isolating terminal, blue	Isolating terminal, gray	Instrument isolating terminal, gray	PE terminal green/yellow
Screw terminal	Standard		2	8WH1000-					0AF00		0AF01				0CF07
		Two-tier	4	8WH1020-					0AF00		0AF01				0CF07
		Two-tier	4	8WH1025-					0AF00						
Spring-loaded terminal	Standard		2	8WH2000-	0AE00	0AE0 <sup>1)</sup>	0AE01	0CE07	0AF00	0AF0 <sup>1)</sup>	0AF01		6AF00	6CF00	0CF07
			3	8WH2003-	0AE00		0AE01	0CE07	0AF00		0AF01		6AF00	6CF00	0CF07
			4	8WH2004-	0AE00		0AE01	0CE07	0AF00		0AF01	6CF01	6AF00	6CF00	0CF07
		Two-tier	4	8WH2020-	0AE00		0AE01	0CE07	0AF00		0AF01				0CF07
			6	8WH2023-					0AF00		0AF01				0CF07
		Two-tier 1-pole	6	8WH2022-					0AF00						
			4	8WH2025-	0AE00				0AF00		0AF01				
		Three-tier	6	8WH2030-					0AF00		0AF01				
		Three-tier	6	8WH2035-					0AF00						0CF07
		Four-tier	8	8WH2040-					4LF00						
	Molded-case			2	8WH2500-				0AF00		0AF01		6AF00	6CF00	0CF07
				3	8WH2503-				0AF00		0AF01				0CF07
				4	8WH2504-				0AF00		0AF01				0CF07
		Two-tier	4	8WH2520-					0AF00		0AF01				0CF07
iPo	Standard		2	8WH6000-				0AF00		0AF01				0CF07	
			3	8WH6003-				0AF00		0AF01				0CF07	
			4	8WH6004-				0AF00		0AF01				0CF07	
		Two-tier	4	8WH6020-				0AF00		0AF01				0CF07	
Combination plugs	Standard		2	8WH5000-				0AF00		0AF01				0CF07	
			4	8WH5004-				0AF00		0AF01				0CF07	
Insulation displacement terminal technology (IDC)	Standard		2	8WH3000-	0AE00		0AE01	0CE07	0AF00		0AF01			0CF07	
			3	8WH3003-	0AE00		0AE01	0CE07	0AF00		0AF01			0CF07	
			4	8WH3004-	0AE00		0AE01	0CE07							
		Two-tier	4	8WH3020-	0AE00		0AE01	0CE07							

Article No., e.g.

8WH2500-

0AF00

**Standard terminal:** Spring-loaded terminal · compact · 2 connection points · 2.5 mm<sup>2</sup> · Through-type terminal, gray

	4 mm <sup>2</sup>						6 mm <sup>2</sup>				10 mm <sup>2</sup>			16 mm <sup>2</sup>			35 mm <sup>2</sup>		
	Through-type terminal, gray	Through-type terminal, colored	Through-type terminal, blue	Isolating terminal, Gray	Instrument isolating terminal, gray	PE terminal, green/yellow	Through-type terminal, gray	Through-type terminal, blue	Isolating terminal, blue	PE terminal, green/yellow	Through-type terminal, gray	Through-type terminal, blue	PE terminal, green/yellow	Through-type terminal, gray	Through-type terminal, blue	PE terminal, green/yellow	Through-type terminal, gray	Through-type terminal, blue	PE terminal, green/yellow
	0AG00		0AG01	6AG00	6CG00	0CG07	0AH00	0AH01	6AH00	0CH07	0AJ00	0AJ01	0CJ07	0AK00	0AK01	0CK07	0AM00	0AM01	0CM07
	0AG00		0AG01	6AG00	6AC00	0CG07													
	0AG00																		
	0AG00	0AG0 <sup>1)</sup>	0AG01	6AG00	6CG00	0CG07	0AH00	0AH01		0CH07	0AJ00	0AJ01	0CJ07	0AK00	0AK01	0CK07	0AM00	0AM01	0CM07
	0AG00		0AG01			0CG07	0AH00	0AH01		0CH07									
	0AG00		0AG01			0CG07	0AH00	0AH01		0CH07									
	0AG00		0AG01			0CG07													
	0AG00																		
	0AG00																		
	4GL00																		
	0AG00		0AG01			0CG07	0AH00	0AH01		0CH07									
	0AG00		0AG01			0CG07	0AH00	0AH01		0CH07									
	0AG00		0AG01			0CG07													
	0AG00		0AG01			0CG07													
	0AG00		0AG01			0CG07	0AH00	0AH01		0CH07	0AJ00	0AJ01	0CJ07	0AK00	0AK01	0CK07	0AM00	0AM01	0CM07
	0AG00		0AG01			0CG07													
	0AG00		0AG01			0CG07													

I201\_18328a

1)	<b>Red</b>	<b>Green</b>	<b>Orange</b>	<b>White</b>	<b>Yellow</b>	<b>Black</b>
	OAE02	OAE03	OAE04	OAE05	OAE06	OAE08

## Introduction

### Notes

1

## 8WH6 iPo Plug-In Terminals

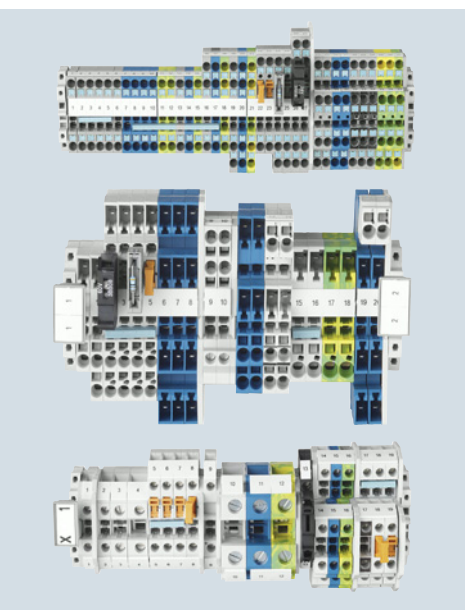

2/2	<b>Introduction</b>
2/3	<b>General data</b>
2/4	<b>8WH6 through-type terminals</b>
2/11	<b>8WH6 fuse terminals</b>
2/12	<b>8WH6 isolating blade terminals</b>
2/14	<b>8WH6 isolating terminals</b>
2/16	<b>8WH6 two-tier terminals</b>

**For further technical product information:**

Siemens Industry Online Support:  
[www.siemens.com/lowvoltage/product-support](http://www.siemens.com/lowvoltage/product-support)

- Application example
- Certificate
- Characteristic
- Download
- FAQ
- Manual
- Product note
- Software archive
- Technical data

## 8WH6 iPo Plug-In Terminals

### Introduction

#### Overview

2

	Devices	Page	Function
	Through-type terminals	2/4	Connection of incoming and outgoing conductors
	Fuse terminals	2/11	Terminals which can be used to protect control circuits, for example
	Isolating blade terminals	2/12	Isolation of the circuit, e.g. for test purposes
	Isolating terminals	2/14	Isolation of the circuit, e.g. for test purposes
	Two-tier terminals	2/16	Compact form of the terminal blocks in which two connection wires can be installed

## Overview

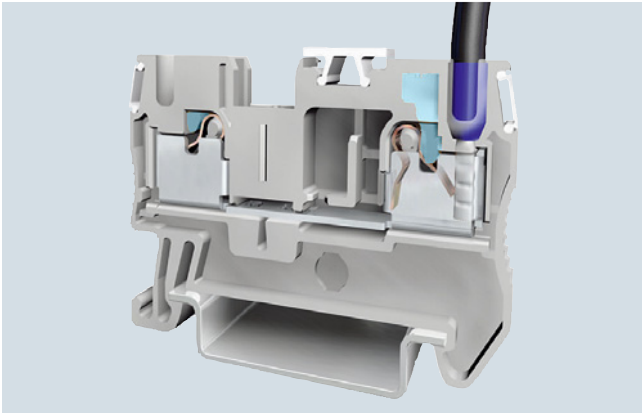

iPo connection method: Characterized by its simple and direct conductor connection, this series utilizes all the benefits of the 8WH system.

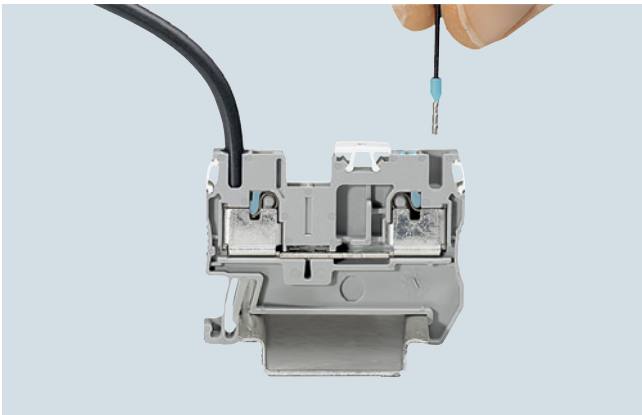

Super-light insertion: With an up to 50 % lower insertion force, the iPo connection method permits easy and direct insertion of rigid and flexible conductors with end sleeves with a cross-section of more than  $0.34 \text{ mm}^2$ .

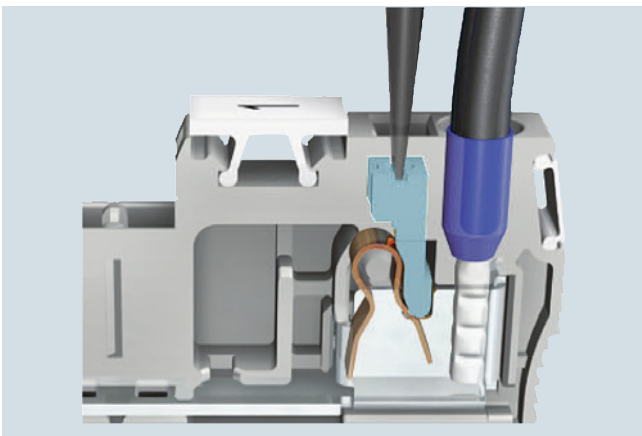

Pusher button function: The actuation button is used to open the spring to either release the conductor or to connect smaller cross-sections from  $0.14 \text{ mm}^2$ . It can be operated by any tool.

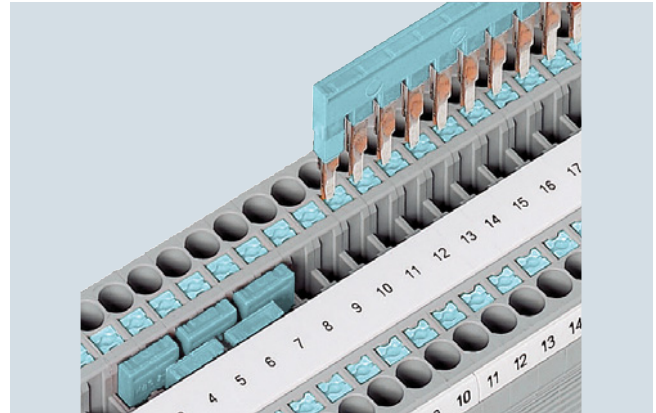

Easy bridging: The double bridge shaft supports the interconnection of any number of terminals using 2-pole jumpers. The 2-pole to 50-pole jumpers enable up to 50 terminals to be connected in a single step.

## 8WH6 iPo Plug-In Terminals

### 8WH6 through-type terminals

#### Overview

2



8WH6 through-type terminals are ideal for the direct tool-free wiring of conductors with end sleeve or rigid conductors. Easy insertion of flexible conductors with end sleeves upwards of  $0.34 \text{ mm}^2$ . The actuation button can be used to open the clamping point with any type of screwdriver in order to unwire or wire small conductors. The compact design and front connection permit wiring in the narrowest of spaces. The double bridge shaft enables fast creation of an individual potential distribution and infeed, e.g. using a screw terminal.

A label can be snapped on to the middle of each terminal at the front. Further labels can also be mounted flat on the side of the terminals.

#### Technical specifications

	8WH6000-0AF00 8WH6000-0AF01 2.5 mm <sup>2</sup>	8WH6003-0AF00 8WH6003-0AF01 2.5 mm <sup>2</sup>	8WH6004-0AF00 8WH6004-0AF01 2.5 mm <sup>2</sup>
Dimensions			
• Width / length / height (NS 35/7.5) in mm	5.2 / 48.5 / 36.5	5.2 / 60.5 / 36.5	5.2 / 72 / 36.5
Max. technical data			
• $I_{\text{max}}$ in A	30	30 <sup>1)</sup>	
• $U_{\text{max}}$ in V	800		
• Max. Ø in mm <sup>2</sup>	0.14 ... 4		
• AWG	26 ... 12		
Rating according to IEC 60947-7-1			
• Rated voltage in V (IEC / UL/CSA)	800 / 600		800 / --
• Rated current in A / cross-section in mm <sup>2</sup>			
- IEC	24 / 2.5	24 <sup>1)</sup> / 2.5	--
- UL/CSA	20 / --		--
• Nominal cross-section in mm <sup>2</sup>	2.5		--
• AWG cross-section range (IEC / UL/CSA)	26 ... 12 / 24 ... 12		26 ... 12 / --
Connection capacities			
• 1 conductor			
- Rigid in mm <sup>2</sup>	0.14 ... 4		
- Flexible in mm <sup>2</sup>	0.14 ... 2.5		
- Flexible end sleeve with/without plastic sleeve in mm <sup>2</sup>	0.14 ... 2.5		
• Conductor cross-section, direct plug-in			
- Rigid in mm <sup>2</sup>	0.34 ... 4		
- Flexible end sleeve with/without plastic sleeve in mm <sup>2</sup>	0.34 ... 2.5		
General data			
• Stripped length in mm	10		
• Molded plastic	PA		
• Flammability Class acc. to UL 94	V0		

<sup>1)</sup> The total current through all connected conductors must not exceed the max. load current.



	<b>8WH6000-OCF07</b> <b>2.5 mm<sup>2</sup></b>	<b>8WH6003-OCF07</b> <b>2.5 mm<sup>2</sup></b>	<b>8WH6004-OCF07</b> <b>2.5 mm<sup>2</sup></b>
Dimensions			
• Width / length / height (NS 35/7.5) in mm	5.2 / 48.5 / 36.5	5.2 / 60.5 / 36.5	5.2 / 72 / 36.5
Max. technical data			
• Max. Ø in mm <sup>2</sup>	0.14 ... 4		
• AWG	26 ... 12		
Rating according to IEC 60947-7-1			
• Nominal cross-section in mm <sup>2</sup>	2.5		
• AWG cross-section range (IEC / UL/CSA)	26 ... 12 / 24 ... 12		26 ... 12 / --
Connection capacities			
• 1 conductor			
- Rigid in mm <sup>2</sup>	0.14 ... 4		
- Flexible in mm <sup>2</sup>	0.14 ... 2.5		
- Flexible end sleeve with/without plastic sleeve in mm <sup>2</sup>	0.14 ... 2.5		
• Conductor cross-section, direct plug-in			
- Rigid in mm <sup>2</sup>	0.34 ... 4		
- Flexible end sleeve with/without plastic sleeve in mm <sup>2</sup>	0.34 ... 2.5		
General data			
• Stripped length in mm	10		
• Molded plastic	PA		
• Flammability Class acc. to UL 94	V0		

	<b>8WH6000-OAG00</b> <b>8WH6000-OAG01</b> <b>4mm<sup>2</sup></b>	<b>8WH6003-OAG00</b> <b>8WH6003-OAG01</b> <b>4mm<sup>2</sup></b>	<b>8WH6004-OAG00</b> <b>8WH6004-OAG01</b> <b>4mm<sup>2</sup></b>
Dimensions			
• Width / length / height in mm	6.2 / 56 / 36.5	6.2 / 66.5 / 36.5	6.2 / 77 / 36.5
Max. technical data			
• $I_{max}$ in A	38	38 <sup>1)</sup>	38 <sup>1)</sup>
• $U_{max}$ in V	800	800	800
• Max. Ø in mm <sup>2</sup>	0.2 ... 6	0.2 ... 6	0.2 ... 6
• AWG	24 ... 10	24 ... 10	24 ... 10
Rating according to IEC 60947-7-1			
• Rated voltage in V (IEC / UL/CSA)	800 / 600	800 / 600	800 / 600
• Rated current in A / cross-section in mm <sup>2</sup>			
- IEC	32 / 4	32 <sup>1)</sup> / 4	32 <sup>1)</sup> / 4
- UL/CSA	30 / --	30 / --	30 / --
• Nominal cross-section in mm <sup>2</sup>	4	4	4
• AWG cross-section range (IEC / UL/CSA)	24 ... 10 / 24 ... 10	24 ... 10 / 24 ... 10	24 ... 10 / 24 ... 10
Connection capacities			
• 1 conductor			
- Rigid in mm <sup>2</sup>	0.2 ... 6	0.2 ... 6	0.2 ... 6
- Flexible in mm <sup>2</sup>	0.2 ... 4	0.2 ... 4	0.2 ... 4
- Flexible end sleeve with/without plastic sleeve in mm <sup>2</sup>	0.25 ... 4	0.25 ... 4	0.25 ... 4
• Conductor cross-section, direct plug-in			
- Rigid in mm <sup>2</sup>	0.5 ... 6	0.2 ... 6	0.5 ... 6
- Flexible end sleeve with/without plastic sleeve in mm <sup>2</sup>	0.5 ... 4	0.5 ... 4	0.5 ... 4
General data			
• Stripped length in mm	12	12	12
• Molded plastic	PA	PA	PA
• Flammability Class acc. to UL 94	V0	V0	V0

<sup>1)</sup> The total current through all connected conductors must not exceed the max. load current.

	<b>8WH6000-OCG07</b> <b>4mm<sup>2</sup></b>	<b>8WH6003-OCG07</b> <b>4mm<sup>2</sup></b>	<b>8WH6004-OCG07</b> <b>4mm<sup>2</sup></b>
Dimensions			
• Width / length / height (NS 35/7.5) in mm	6.2 / 56 / 36.5	6.2 / 66.5 / 36.5	6.2 / 77 / 36.5
Max. technical data			
• Max. Ø in mm <sup>2</sup>	0.2 ... 6	0.2 ... 6	0.2 ... 6
• AWG	24 ... 10	24 ... 10	24 ... 10
Rating according to IEC 60947-7-1			
• Nominal cross-section in mm <sup>2</sup>	4	4	4
• AWG cross-section range (IEC / UL/CSA)	24 ... 10 / 24 ... 10	24 ... 10 / 24 ... 10	24 ... 10 / 24 ... 10
Connection capacities			
• 1 conductor			
- Rigid in mm <sup>2</sup>	0.2 ... 6	0.2 ... 6	0.2 ... 6
- Flexible in mm <sup>2</sup>	0.2 ... 4	0.2 ... 6	0.2 ... 6
- Flexible end sleeve with/without plastic sleeve in mm <sup>2</sup>	0.25 ... 4	0.2 ... 4	0.2 ... 4
• Conductor cross-section, direct plug-in			
- Rigid in mm <sup>2</sup>	0.5 ... 6		
- Flexible end sleeve with/without plastic sleeve in mm <sup>2</sup>	0.5 ... 4		
General data			
• Stripped length in mm	12	12	12
• Molded plastic	PA	PA	PA
• Flammability Class acc. to UL 94	V0	V0	V0

## 8WH6 iPo Plug-In Terminals

### 8WH6 through-type terminals

2

	8WH6000-0AH00 8WH6000-0AH01 6 mm <sup>2</sup>	8WH6000-0CH0 6 mm <sup>2</sup>	8WH6000-0AJ00 8WH6000-0AJ01 10 mm <sup>2</sup>	8WH6000-0CJ07 10 mm <sup>2</sup>
Dimensions				
• Width/length/cover width in mm	8.2 / 57.7 / 2.2	8.2 / 57.7 / 2.2	8.2 / 57.7 / 2.2	8.2 / 57.7 / 2.2
• Height (NS 35/7.5 / NS 35/15) in mm	43.5 / 51	43.5 / 51	43.5 / 51	43.5 / 51
Technical specifications acc. to IEC/DIN VDE				
• Max. load current in A / cross-section in mm <sup>2</sup>	51 / 10	--	65 / 16	--
• Rated voltage in V	1000	--	1000	--
• Rated impulse withstand voltage in kV / pollution degree	8 / 3	8 / 3	8 / 3	8 / 3
• Overvoltage category / molded plastic group	III / I	III / I	III / I	III / I
Connection capacities				
• Flexible with end sleeve, with plastic sleeve in mm <sup>2</sup>	0.5 ... 6	0.5 ... 6	0.5 ... 10	0.5 ... 10
• Flexible with end sleeve, without plastic sleeve in mm <sup>2</sup>	0.5 ... 6	0.5 ... 6	0.5 ... 10	0.5 ... 10
• Rigid in mm <sup>2</sup>	0.5 ... 10	0.5 ... 10	0.5 ... 16	0.5 ... 16
• Flexible in mm <sup>2</sup>	0.5 ... 6	0.5 ... 6	0.5 ... 10	0.5 ... 10
Stripped length in mm	12	12	18	18
Plug gauge (IEC 60947-1)	A5	A5	A6	A6
Molded plastic type	PA	PA	PA	PA
• Flammability Class acc. to UL 94	V0	V0	V0	V0
Approval data (UL/cUL and CSA)				
• Rated voltage / rated current / conductor sizes				
- UL/cUL: in V/A / AWG	600 / 40 / 20 ... 8	-- / -- / 20 ... 8	600 / 60 / 20 ... 6	-- / -- / 20 ... 6
- CSA: in V/A / AWG	--	--	--	--
	8WH6000-0AK00 8WH6000-0AK01 16 mm <sup>2</sup>	8WH6000-0CK07 16 mm <sup>2</sup>	8WH6000-0AM00 8WH6000-0AM01 35 mm <sup>2</sup>	8WH6000-0CM07 35 mm <sup>2</sup>
Dimensions				
• Width/length/cover width in mm	12.2 / 75.4 / 2.2	12.2 / 75.4 / 2.2	16 / 91.6 / 2.2	16 / 91.6 / 2.2
• Height (NS 35/7.5 / NS 35/15) in mm	52.6 / 60.1	52.6 / 60.1	-- / 62.3	-- / 62.3
Technical specifications acc. to IEC/DIN VDE				
• Max. load current in A / cross-section in mm <sup>2</sup>	90 / 25	--	125 / 35	--
• Rated voltage in V	1000	--	1000	--
• Rated impulse withstand voltage in kV / pollution degree	8 / 3	8 / 3	8 / 3	8 / 3
• Overvoltage category / molded plastic group	III	III	III	III
Connection capacities				
• Flexible with end sleeve, with plastic sleeve in mm <sup>2</sup>	0.5 ... 16	0.5 ... 16	6 ... 35	6 ... 35
• Flexible with end sleeve, without plastic sleeve in mm <sup>2</sup>	0.5 ... 16	0.5 ... 16	6 ... 35	6 ... 35
• Rigid in mm <sup>2</sup> / AWG	0.5 ... 25 / 20 ... 4	0.5 ... 25 / 20 ... 4	6 ... 35 / 10 ... 2	6 ... 35 / 10 ... 2
• Flexible in mm <sup>2</sup> / AWG	0.5 ... 16 / 20 ... 6	0.5 ... 16 / 20 ... 6	6 ... 35 / 10 ... 2	6 ... 35 / 10 ... 2
Stripped length in mm	18	18	25	25
Plug gauge (IEC 60947-1)	A7	A7	--	--
Molded plastic type	PA	PA	PA	PA
• Flammability Class acc. to UL 94	V0	V0	V0	V0
Approval data (UL/cUL and CSA)				
• Rated voltage / rated current / conductor sizes				
- UL/cUL: in V/A / AWG	--	--	--	--
- CSA: in V/A / AWG	--	--	--	--

### Selection and ordering data

Version	DT	Article No. <a href="http://www.siemens.com/product?Article No.">www.siemens.com/ product?Article No.</a>	Price per PU	PU (UNIT, SET, M)	PS*/ P. unit	PG
---------	----	--	-----------------	-------------------------	-----------------	----

#### Terminal size 2.5 mm<sup>2</sup>

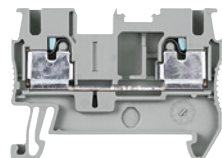

8WH6000-0AF00







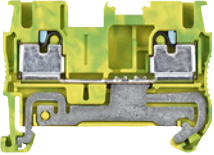
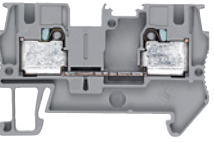

#### Through-type terminals, terminal size 2.5 mm<sup>2</sup>

- C<sub>UL</sub> / S
- Terminal width 5.2 mm
- I<sub>max</sub> = 30 A
- U<sub>max</sub> = 800 V
- AWG 26 ... 12
- Connection capacity, one conductor
  - Rigid 0.14 ... 4 mm<sup>2</sup>
  - Flexible 0.14 ... 2.5 mm<sup>2</sup>

#### Versions

- Two clamping points
  - Gray
  - Blue
- Three clamping points
  - Gray
  - Blue
- Four clamping points
  - Gray
  - Blue

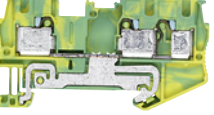
8WH6000-0AF00	1	50 units	1BT
8WH6000-0AF01	1	50 units	1BT
8WH6003-0AF00	1	50 units	1BT
8WH6003-0AF01	1	50 units	1BT
8WH6004-0AF00	1	50 units	1BT
8WH6004-0AF01	1	50 units	1BT

Version	DT	Article No. <a href="http://www.siemens.com/product?Article.No.">www.siemens.com/ product?Article No.</a>	Price per PU	PU (UNIT, SET, M)	PS*/ P. unit	PG
 <p><b>PE through-type terminals, terminal size 2.5 mm<sup>2</sup></b></p> <ul style="list-style-type: none"> <li>• <math>C_{us}</math></li> <li>• Terminal width 5.2 mm</li> <li>• AWG 26 ... 12</li> <li>• Connection capacity, one conductor <ul style="list-style-type: none"> <li>- Rigid 0.14 ... 4 mm<sup>2</sup></li> <li>- Flexible 0.14 ... 2.5 mm<sup>2</sup></li> </ul> </li> <li>• Green/yellow</li> </ul> <p>8WH6000-OCF07</p>						
<p><b>Versions</b></p> <ul style="list-style-type: none"> <li>• Two clamping points</li> <li>• Three clamping points</li> <li>• Four clamping points</li> </ul>		<p><b>8WH6000-OCF07</b></p> <p><b>8WH6003-OCF07</b></p> <p><b>8WH6004-OCF07</b></p>		<p>1 50 units</p> <p>1 50 units</p> <p>1 50 units</p>		<p>1BT</p> <p>1BT</p> <p>1BT</p>
<p><b>Terminal size 4 mm<sup>2</sup></b></p>  <p>8WH6000-0AG00</p>  <p>8WH6003-0AG00</p>  <p>8WH6003-0AG01</p>  <p>8WH6004-0AG00</p>  <p>8WH6004-0AG01</p>		<p><b>Through-type terminals, terminal size 4 mm<sup>2</sup></b></p> <ul style="list-style-type: none"> <li>• <math>C_{us}</math></li> <li>• Terminal width 6.2 mm</li> <li>• <math>I_{max} = 38</math> A</li> <li>• <math>U_{max} = 800</math> V</li> <li>• AWG 24 ... 10</li> <li>• Connection capacity, one conductor <ul style="list-style-type: none"> <li>- Rigid 0.2 ... 6 mm<sup>2</sup></li> <li>- Flexible 0.2 ... 4 mm<sup>2</sup></li> </ul> </li> </ul>				
<p><b>Versions</b></p> <ul style="list-style-type: none"> <li>• Two clamping points <ul style="list-style-type: none"> <li>- Gray</li> <li>- Blue</li> </ul> </li> <li>• Three clamping points <ul style="list-style-type: none"> <li>- Gray</li> <li>- Blue</li> </ul> </li> <li>• Four clamping points <ul style="list-style-type: none"> <li>- Gray</li> <li>- Blue</li> </ul> </li> </ul>		<p><b>8WH6000-0AG00</b></p> <p><b>8WH6000-0AG01</b></p> <p><b>8WH6003-0AG00</b></p> <p><b>8WH6003-0AG01</b></p> <p><b>8WH6004-0AG00</b></p> <p><b>8WH6004-0AG01</b></p>		<p>1 50 units</p> <p>1 50 units</p> <p>1 50 units</p> <p>1 50 units</p> <p>1 50 units</p> <p>1 50 units</p>		<p>1BT</p> <p>1BT</p> <p>1BT</p> <p>1BT</p> <p>1BT</p> <p>1BT</p>
 <p>8WH6000-0CG07</p>  <p>8WH6003-0CG07</p>  <p>8WH6004-0CG07</p>		<p><b>PE through-type terminals, terminal size 4 mm<sup>2</sup></b></p> <ul style="list-style-type: none"> <li>• <math>C_{us}</math></li> <li>• Terminal width 6.2 mm</li> <li>• AWG 24 ... 10</li> <li>• Connection capacity, one conductor <ul style="list-style-type: none"> <li>- Rigid 0.2 ... 6 mm<sup>2</sup></li> <li>- Flexible 0.2 ... 4 mm<sup>2</sup></li> </ul> </li> <li>• Green/yellow</li> </ul>				
<p><b>Versions</b></p> <ul style="list-style-type: none"> <li>• Two clamping points</li> <li>• Three clamping points</li> <li>• Four clamping points</li> </ul>		<p><b>8WH6000-0CG07</b></p> <p><b>8WH6003-0CG07</b></p> <p><b>8WH6004-0CG07</b></p>		<p>1 50 units</p> <p>1 50 units</p> <p>1 50 units</p>		<p>1BT</p> <p>1BT</p> <p>1BT</p>

## 8WH6 iPo Plug-In Terminals



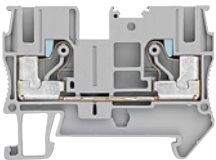
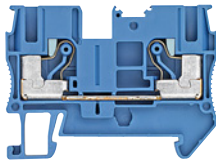
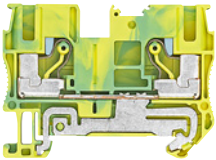
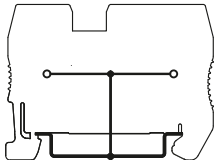
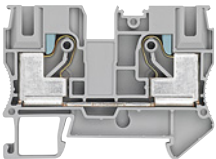
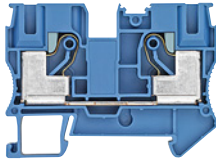
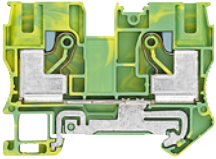
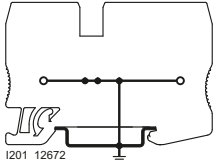

## 8WH6 through-type terminals

2

Version	DT	Article No. <a href="http://www.siemens.com/product?ArticleNo.">www.siemens.com/ product?Article No.</a>	Price per PU	PU (UNIT, SET, M)	PS*/ P. unit	PG
<b>Terminal size 6 mm<sup>2</sup></b>						
 8WH6000-0AH00  8WH6000-0AH01		<b>Through-type terminals, terminal size 6 mm<sup>2</sup>, two clamping points</b> <ul style="list-style-type: none"> <li>Terminal width 8.2 mm</li> <li>• <b>C<sub>UL</sub>us</b></li> <li>• IEC 60947-7-1               <ul style="list-style-type: none"> <li>- Rigid 0.5 ... 10 mm<sup>2</sup></li> <li>- Flexible 0.5 ... 6 mm<sup>2</sup></li> <li>- AWG 20 ... 8</li> <li>- I = 41 A</li> <li>- U = 1000 V</li> </ul> </li> </ul>				
<b>Versions</b> <ul style="list-style-type: none"> <li>• Gray</li> <li>• Blue</li> </ul>						
		<b>8WH6000-0AH00</b> <b>8WH6000-0AH01</b>		1 50 units 1 50 units		1BT 1BT
 8WH6000-0CH07  I201_12670 8WH6000-0CH07		<b>PE through-type terminals, terminal size 6 mm<sup>2</sup>, two clamping points</b> <ul style="list-style-type: none"> <li>Terminal width 8.2 mm</li> <li>• <b>C<sub>UL</sub>us</b></li> <li>• IEC 60947-7-2               <ul style="list-style-type: none"> <li>- Rigid 0.5 ... 10 mm<sup>2</sup></li> <li>- Flexible 0.5 ... 6 mm<sup>2</sup></li> <li>- AWG 20 ... 8</li> </ul> </li> <li>• Green/yellow</li> </ul>				
		<b>8WH6000-0CH07</b>		1 50 units		1BT
<b>Terminal size 10 mm<sup>2</sup></b>						
 8WH6000-0AJ00  8WH6000-0AJ01		<b>Through-type terminals, terminal size 10 mm<sup>2</sup></b> <ul style="list-style-type: none"> <li>Terminal width 10.2 mm</li> <li>• <b>C<sub>UL</sub>us</b></li> <li>• IEC 60947-7-1               <ul style="list-style-type: none"> <li>- Rigid 0.5 ... 16 mm<sup>2</sup></li> <li>- Flexible 0.5 ... 6 mm<sup>2</sup></li> <li>- AWG 20-6</li> <li>- I = 57 A</li> <li>- U = 1000 V</li> </ul> </li> </ul>				
<b>Versions</b> <ul style="list-style-type: none"> <li>• Gray</li> <li>• Blue</li> </ul>						
		<b>8WH6000-0AJ00</b> <b>8WH6000-0AJ01</b>		1 50 units 1 50 units		1BT 1BT
 8WH6000-0CJ07  I201_12672 8WH6000-0CJ07		<b>PE through-type terminals, terminal size 10 mm<sup>2</sup></b> <ul style="list-style-type: none"> <li>Terminal width 10.2 mm</li> <li>• <b>C<sub>UL</sub>us</b></li> <li>• IEC 60947-7-2               <ul style="list-style-type: none"> <li>- Rigid 0.5 ... 10 mm<sup>2</sup></li> <li>- Flexible 0.5 ... 10 mm<sup>2</sup></li> <li>- AWG 20-6</li> </ul> </li> <li>• Green/yellow</li> </ul>				
		<b>8WH6000-0CJ07</b>		1 50 units		1BT

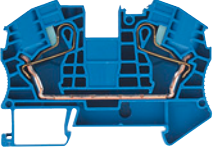
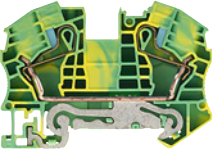
## 8WH6 through-type terminals







2

Version	DT	Article No. <a href="http://www.siemens.com/product?Article.No.">www.siemens.com/ product?Article No.</a>	Price per PU	PU (UNIT, SET, M)	PS*/ P. unit	PG
<b>Terminal size 16 mm<sup>2</sup> <span style="color: red;">NEW</span></b>						
 8WH6000-0AK00		<b>Through-type terminals, terminal size 16 mm<sup>2</sup></b> <ul style="list-style-type: none"> <li>Terminal width 12.2 mm</li> <li>IEC 60947-7-1               <ul style="list-style-type: none"> <li>Rigid 0.5 ... 25 mm<sup>2</sup></li> <li>Flexible 0.5 ... 16 mm<sup>2</sup></li> <li>AWG 20 ... 4</li> <li>I = 90 A</li> <li>U = 1000 V</li> </ul> </li> </ul>				
 8WH6000-0AK01	<b>Versions</b> <ul style="list-style-type: none"> <li>Gray</li> <li>Blue</li> </ul>			<b>8WH6000-0AK00</b> <b>8WH6000-0AK01</b>	1 50 units 1BT 1 50 units 1BT	
 8WH6000-0CK07		<b>PE through-type terminals, terminal size 16 mm<sup>2</sup></b> <ul style="list-style-type: none"> <li>Terminal width 12.2 mm</li> <li>IEC 60947-7-2               <ul style="list-style-type: none"> <li>Rigid 0.5 ... 25 mm<sup>2</sup></li> <li>Flexible 0.5 ... 16 mm<sup>2</sup></li> <li>AWG 20 ... 4</li> </ul> </li> <li>Green/yellow</li> </ul>				1 50 units 1BT
<b>Terminal size 35 mm<sup>2</sup> <span style="color: red;">NEW</span></b>						
 8WH6000-0AM00		<b>Through-type terminals, terminal size 35 mm<sup>2</sup></b> <ul style="list-style-type: none"> <li>Terminal width 16 mm</li> <li>Enclosed at both ends</li> <li>IEC 60947-7-1               <ul style="list-style-type: none"> <li>Rigid 6 ... 35 mm<sup>2</sup></li> <li>Flexible 6 ... 35 mm<sup>2</sup></li> <li>AWG 10 ... 2</li> <li>I = 125 A</li> <li>U = 1000 V</li> </ul> </li> </ul>				
 8WH6000-0AM01	<b>Versions</b> <ul style="list-style-type: none"> <li>Gray</li> <li>Blue</li> </ul>			<b>8WH6000-0AM00</b> <b>8WH6000-0AM01</b>	1 10 units 1BT 1 10 units 1BT	
 8WH6000-0CM07		<b>PE through-type terminals, terminal size 35 mm<sup>2</sup></b> <ul style="list-style-type: none"> <li>Terminal width 16 mm</li> <li>Enclosed at both ends</li> <li>IEC 60947-7-2               <ul style="list-style-type: none"> <li>Rigid 6 ... 35 mm<sup>2</sup></li> <li>Flexible 6 ... 35 mm<sup>2</sup></li> <li>AWG 10 ... 2</li> <li>I = 125 A</li> <li>U = 1000 V</li> </ul> </li> </ul>				1 10 units 1BT

## 8WH6 iPo Plug-In Terminals

## 8WH6 through-type terminals

2

Version	DT	Article No. <a href="http://www.siemens.com/product?ArticleNo.">www.siemens.com/ product?Article No.</a>	Price per PU	PU (UNIT, SET, M)	PS*/ P. unit	PG
<b>Accessories</b>						
		<b>Covers, for terminal size 1.5 ... 2.5 mm<sup>2</sup>, width 2.2 mm</b>				
		<ul style="list-style-type: none"> <li>• For two clamping points</li> <li>• For three clamping points</li> <li>• For four clamping points</li> </ul>				
		<b>Cover segments, for terminal size 1.5 ... 2.5 mm<sup>2</sup></b> For covering multi-wire terminals when mounting two-wire terminals side-by-side				
						
8WH9000-0GA00						
		<b>Compartment partitions, for terminal size 1.5 ... 4 mm<sup>2</sup></b> • For visual and electrical separation of terminal groups • 2 mm thick • Gray				
		<ul style="list-style-type: none"> <li>• For two clamping points</li> <li>• For three clamping points</li> <li>• For four clamping points</li> </ul>				
		Note For general accessories for 8WH terminal blocks, see chapter "Accessories for 8WH Terminal Blocks"				
8WH9070-0AA00						
		<b>Covers, for terminal size 4 mm<sup>2</sup></b> Width 2.2 mm				
		<ul style="list-style-type: none"> <li>• For two clamping points</li> <li>• For three clamping points</li> <li>• For four clamping points</li> </ul>				
8WH9003-1GA00						
		<b>Compartment partitions, for terminal size 1.5 ... 4 mm<sup>2</sup></b> • For visual and electrical separation of terminal groups • 2 mm thick • Gray				
		<ul style="list-style-type: none"> <li>• For two clamping points</li> </ul>				
8WH9070-0AA00						
		<b>Covers, for through-type terminals</b> • Width 2.2 mm				
		<ul style="list-style-type: none"> <li>• For two clamping points 6 mm<sup>2</sup></li> <li>• For two clamping points 10 mm<sup>2</sup></li> </ul>				
8WH9004-3SA00						
		<b>Covers, for terminal size 16 mm<sup>2</sup></b> <b>NEW</b> • For closing the open terminal side • Length 75.4 mm • Width 2.2 mm				
		<ul style="list-style-type: none"> <li>• Gray</li> </ul>				
8WH9006-1SA00						

For general accessories for 8WH terminal blocks, see chapter "Accessories for 8WH Terminal Blocks"

## Overview



The fuse terminal is characterized by its compact design and it has the same contour as through-type terminals and function terminals. Double bridging is possible. Versions with LED display for signaling a fuse are also available.

Fuse terminals can be inscribed at their clamping points with flat labels.

2

## Technical specifications

	8WH6000-1GG08	8WH6000-1KG38	8WH6000-1MG88
Dimensions			
• Width / length / height (NS 35/7.5) in mm	6.2 / 56 / 62.5		
Max. electrical data			
• $I_{max}$ in A	6.3 <sup>1)</sup>		
• $U_{max}$ in V	500		
• Max. Ø in mm <sup>2</sup>	0.2 ... 6		
• AWG	24 ... 10		
Rating according to IEC 60947-7-1			
• Rated voltage in V (IEC / UL/CSA)	500 / 300		
• Rated current in A / cross-section in mm <sup>2</sup>			
- IEC	6.3 / 1		
- UL/CSA	6.3 / --		
• Nominal cross-section in mm <sup>2</sup>	4		
• AWG cross-section range (IEC / UL/CSA)	24 ... 10 / 24 ... 10		
Connection capacities			
• 1 conductor			
- Rigid in mm <sup>2</sup>	0.2 ... 6		
- Flexible in mm <sup>2</sup>	0.2 ... 4		
- Flexible end sleeve with/without plastic sleeve in mm <sup>2</sup>	0.25 ... 4		
• Conductor cross-section, direct plug-in			
- Rigid in mm <sup>2</sup>	0.5 ... 6		
- Flexible end sleeve with/without plastic sleeve in mm <sup>2</sup>	0.5 ... 4		
General data			
• Stripped length in mm	12		
• Molded plastic	PA		
• Flammability Class acc. to UL 94	V0		

1) The total current through all connected conductors must not exceed the max. load current.

## Selection and ordering data

Version	DT	Article No. <a href="http://www.siemens.com/product?Article.No.">www.siemens.com/ product?Article.No.</a>	Price per PU	PU (UNIT, SET, M)	PS*/ P. unit	PG
---------	----	--	-----------------	-------------------------	-----------------	----

Terminal size 4 mm<sup>2</sup>

8WH6000-1GG08

Fuse terminals, terminal size 4 mm<sup>2</sup>, for 5 x 20 mm G fuse links

- US, CSA
- Terminal width 6.2 mm
- $I_{max} = 6.3$  A
- $U_{max} = 500$  V
- AWG 24 ... 10
- Connection capacity, one conductor
  - Rigid 0.2 ... 4 mm<sup>2</sup>
  - Flexible 0.2 ... 4 mm<sup>2</sup>
- Black

## Versions

- Without LED
- With LED 10 ... 30 V AC/DC
- With LED 110 ... 250 V AC/DC

8WH6000-1GG08	1	50 units	1BT
8WH6000-1KG38	1	50 units	1BT
8WH6000-1MG88	1	50 units	1BT

## Accessories

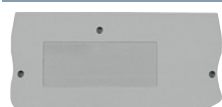

8WA9003-1GA00

Covers, for terminal size 4 mm<sup>2</sup>

- For two clamping points
- Width 2.2 mm

8WH9003-1GA00

100 50 units 1BT

For general accessories for 8WH terminal blocks, see chapter "Accessories for 8WH Terminal Blocks"

## 8WH6 iPo Plug-In Terminals

### 8WH6 isolating blade terminals

#### Overview

2

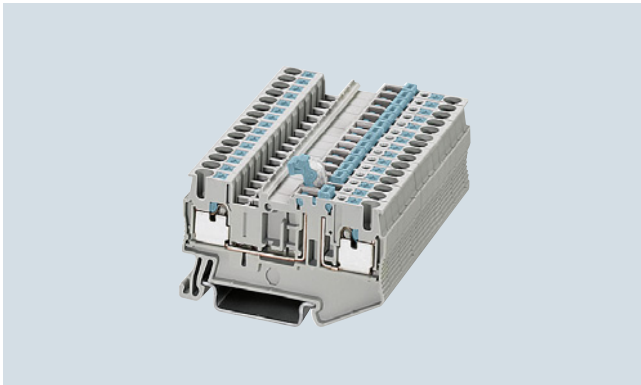

Through-type terminals with isolating blade capability are the most commonly used terminal types in measuring and control technology. Key features of the 8WH6 isolating blade terminals are the slim design of only 5.2 mm and their high current-carrying capacity. Convenient testing is made possible by the integral double function shaft located on one side of the isolating point and the integrated test contact located on the other. Standard connecting combs allow easy execution of all potential-distribution tasks. Three and four-wire terminals up to 2.5 mm<sup>2</sup> are available for the multi-conductor connection.

A label can be snapped on to the middle of each terminal at the front. Further labels can also be mounted flat on the side of the terminals.

#### Technical specifications





	8WH6000-6AF00	8WH6003-6AF00	8WH6004-6AF00
<b>Dimensions</b>			
• Width / length / height (NS 35/7.5) in mm	5.2 / 60.5 / 36.5	5.2 / 74 / 36.5	5.2 / 84 / 36.5
<b>Max. electrical data</b>			
• $I_{max}$ in A	20	20 <sup>1)</sup>	
• $U_{max}$ in V	400		
• Max. Ø in mm <sup>2</sup>	0.14 ... 4		
• AWG	26 ... 12		
<b>Rating according to IEC 60947-7-1</b>			
• Rated voltage in V (IEC)	400		
• Rated current in A / cross-section in mm <sup>2</sup> (IEC)	20 / 2.5	20 <sup>1)</sup> / 2.5	
• Nominal cross-section in mm <sup>2</sup>	2.5		
• AWG cross-section range (IEC)	26 ... 12		
<b>Connection capacities</b>			
• 1 conductor			
- Rigid in mm <sup>2</sup>	0.14 ... 4		
- Flexible in mm <sup>2</sup>	0.14 ... 2.5		
- Flexible end sleeve with/without plastic sleeve in mm <sup>2</sup>	0.14 ... 2.5		
• Conductor cross-section, direct plug-in			
- Rigid in mm <sup>2</sup>	0.34 ... 4		
- Flexible end sleeve with/without plastic sleeve in mm <sup>2</sup>	0.34 ... 2.5		
<b>General data</b>			
• Stripped length in mm	10		
• Molded plastic	PA		
• Flammability Class acc. to UL 94	V0		

<sup>1)</sup> The total current through all connected conductors must not exceed the max. load current.

	8WH6000-6CG00
<b>Dimensions</b>	
• Width / length / height (NS 35/7.5) in mm	6.2 / 54 / 36.5
<b>Max. electrical data</b>	
• $I_{max}$ in A	20
• $U_{max}$ in V	400
• Max. Ø in mm <sup>2</sup>	0.2 ... 6
• AWG	24 ... 10
<b>Rating according to IEC 60947-7-1</b>	
• Rated voltage in V (IEC / UL/CSA)	400 / 300
• Rated current in A / cross-section in mm <sup>2</sup>	
- IEC	20 / 2.5
- UL/CSA	20 / --
• Nominal cross-section in mm <sup>2</sup>	4
• AWG cross-section range (IEC / UL/CSA)	24 ... 10 / 24 ... 10
<b>Connection capacities</b>	
• 1 conductor	
- Rigid in mm <sup>2</sup>	0.2 ... 6
- Flexible in mm <sup>2</sup>	0.2 ... 4
- Flexible end sleeve with/without plastic sleeve in mm <sup>2</sup>	0.25 ... 4
• Conductor cross-section, direct plug-in	
- Rigid in mm <sup>2</sup>	0.5 ... 6
- Flexible end sleeve with/without plastic sleeve in mm <sup>2</sup>	0.5 ... 4
<b>General data</b>	
• Stripped length in mm	12
• Molded plastic	PA
• Flammability Class acc. to UL 94	V0

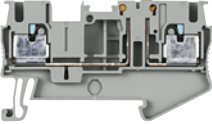
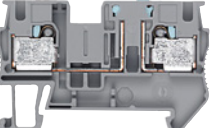

## Selection and ordering data

Version	DT	Article No. <a href="http://www.siemens.com/product?ArticleNo.">www.siemens.com/ product?Article No.</a>	Price per PU	PU (UNIT, SET, M)	PS*/ P. unit	PG
<b>Terminal size 2.5 mm<sup>2</sup></b>						
 <p>8WH6000-6AF00</p>	<b>Isolating blade terminals, terminal size 2.5 mm<sup>2</sup></b> <ul style="list-style-type: none"> <li>Terminal width 5.2 mm</li> <li><math>I_{\max} = 20 \text{ A}</math></li> <li><math>U_{\max} = 400 \text{ V}</math></li> <li>AWG 26 ... 12</li> <li>Connection capacity, one conductor               <ul style="list-style-type: none"> <li>Rigid 0.14 ... 4 mm<sup>2</sup></li> <li>Flexible 0.14 ... 2.5 mm<sup>2</sup></li> </ul> </li> </ul>					
	<b>Versions</b> <ul style="list-style-type: none"> <li>Two clamping points</li> <li>Three clamping points</li> <li>Four clamping points</li> </ul>					
<b>Terminal size 4 mm<sup>2</sup></b>						
 <p>8WH6000-6CG00</p>	<b>Isolating blade terminals, terminal size 4 mm<sup>2</sup></b> <ul style="list-style-type: none"> <li>With 2 clamping points</li> <li>Terminal width 6.2 mm</li> <li><math>I_{\max} = 20 \text{ A}</math></li> <li><math>U_{\max} = 400 \text{ V}</math></li> <li>AWG 24 ... 10</li> <li>Connection capacity, one conductor               <ul style="list-style-type: none"> <li>Rigid 0.2 ... 6 mm<sup>2</sup></li> <li>Flexible 0.2 ... 4 mm<sup>2</sup></li> </ul> </li> <li>Connection capacity, two conductors               <ul style="list-style-type: none"> <li>Rigid 0.5 ... 6 mm<sup>2</sup></li> </ul> </li> </ul>		<b>8WH6000-6CG00</b>			
			1 50 units 1BT			
<b>Accessories</b>						
 <p>8WH9000-3SC00</p>	<b>Covers, for terminal size 2.5 mm<sup>2</sup></b> Width 2.2 mm <ul style="list-style-type: none"> <li>For two clamping points</li> <li>For three clamping points</li> <li>For four clamping points</li> </ul>		<b>8WH9000-3SC00</b> <b>8WH9000-3SD00</b> <b>8WH9000-5GA00</b>			
			100 50 units 1BT 100 50 units 1BT 100 50 units 1BT			
 <p>8WA9003-1GA00</p>	<b>Covers, for terminal size 4 mm<sup>2</sup></b> <ul style="list-style-type: none"> <li>For two clamping points</li> <li>Width 2.2 mm</li> </ul>		<b>8WH9003-1GA00</b>			
			100 50 units 1BT			
 <p>8WH9070-0AA00</p>	<b>Compartment partitions, for terminal size 1.5 ... 4 mm<sup>2</sup></b> <ul style="list-style-type: none"> <li>For two clamping points</li> <li>For visual and electrical separation of terminal groups</li> <li>2 mm thick</li> <li>Gray</li> </ul>		<b>8WH9070-0AA00</b>			
			100 50 units 1BT			

For general accessories for 8WH terminal blocks, see chapter "Accessories for 8WH Terminal Blocks"

## 8WH6 iPo Plug-In Terminals

### 8WH6 isolating terminals

#### Overview

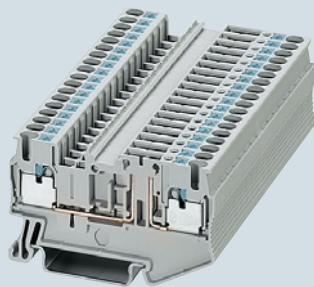

8WH6 isolating terminals in iPo connection technology are available for special wiring tasks. With the same contour as the isolating blade terminals, 8WH6 isolating terminals are fitted with a universal plug-in zone in the middle of the terminal. Numerous wiring tasks can be performed on a terminal width of 5.2 mm by integrating the isolated through-type connector, the isolating plug, the component connector or the fused plug.

A label can be snapped on to the middle of each terminal at the front. Further labels can also be mounted flat on the side of the terminals.

#### Technical specifications





	8WH6000-6CF00	8WH6003-6CF00	8WH6004-6CF00
<b>Dimensions</b>			
• Width / length / height (NS 35/7.5) in mm	5.2 / 60.5 / 36.5	5.2 / 74 / 36.5	5.2 / 84 / 36.5
<b>Max. electrical data</b>			
• $I_{max}$ in A	20	20 <sup>1)</sup>	
• $U_{max}$ in V	400 <sup>2)</sup>		
• Max. Ø in mm <sup>2</sup>	0.14 ... 4		
• AWG	26 ... 12		
<b>Rating according to IEC 60947-7-1</b>			
• Rated voltage in V (IEC)	400 <sup>2)</sup>		
• Rated current in A / cross-section in mm <sup>2</sup> (IEC)	20 / 2.5	20 <sup>1)</sup> / 2.5	
• Nominal cross-section in mm <sup>2</sup> (IEC)	2.5		
• AWG cross-section range (IEC)	26 ... 12		
<b>Connection capacities</b>			
• 1 conductor			
- Rigid in mm <sup>2</sup>	0.14 ... 4		
- Flexible in mm <sup>2</sup>	0.14 ... 2.5		
- Flexible end sleeve with/without plastic sleeve in mm <sup>2</sup>	0.14 ... 2.5		
• Conductor cross-section, direct plug-in			
- Rigid in mm <sup>2</sup>	0.34 ... 4		
- Flexible end sleeve with/without plastic sleeve in mm <sup>2</sup>	0.34 ... 2.5		
<b>General data</b>			
• Stripped length in mm	10		
• Molded plastic	PA		
• Flammability Class acc. to UL 94	V0		

1) The total current through all connected conductors must not exceed the max. load current.

2) Current and voltage are determined by the fitted plug.

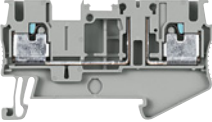
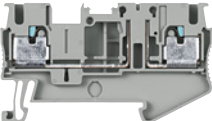
	8WH6000-6AG00
<b>Dimensions</b>	
• Width / length / height (NS 35/7.5) in mm	6.2 / 56 / 36.5
<b>Max. electrical data</b>	
• $I_{max}$ in A	20
• $U_{max}$ in V	400 <sup>2)</sup>
• Max. Ø in mm <sup>2</sup>	0.2 ... 6
• AWG	24 ... 10
<b>Rating according to IEC 60947-7-1</b>	
• Rated voltage in V (IEC / UL/CSA)	400 / 300
• Rated current in A / cross-section in mm <sup>2</sup>	
- IEC	20 / 2.5
- UL/CSA	20 / --
• Nominal cross-section in mm <sup>2</sup>	4
• AWG cross-section range (IEC / UL/CSA)	24 ... 10 / 24 ... 10
<b>Connection capacities</b>	
• 1 conductor	
- Rigid in mm <sup>2</sup>	0.2 ... 6
- Flexible in mm <sup>2</sup>	0.25 ... 4
- Flexible end sleeve with/without plastic sleeve in mm <sup>2</sup>	0.25 ... 4
• Conductor cross-section, direct plug-in	
- Rigid in mm <sup>2</sup>	0.5 ... 6
- Flexible end sleeve with/without plastic sleeve in mm <sup>2</sup>	0.5 ... 4
<b>General data</b>	
• Stripped length in mm	12
• Molded plastic	PA
• Flammability Class acc. to UL 94	V0

## Selection and ordering data

Version	DT	Article No. <a href="http://www.siemens.com/product?ArticleNo.">www.siemens.com/ product?Article No.</a>	Price per PU	PU (UNIT, SET, M)	PS*/ P. unit	PG
<b>Terminal size 2.5 mm<sup>2</sup></b>						
 8WH6000-6CF00		<b>Isolating terminals, terminal size 2.5 mm<sup>2</sup></b> <ul style="list-style-type: none"> <li>Terminal width 5.2 mm</li> <li><math>I_{\max} = 20</math> A</li> <li><math>U_{\max} = 400</math> V</li> <li>AWG 26 ... 12</li> <li>Connection capacity, one conductor               <ul style="list-style-type: none"> <li>Rigid 0.14 ... 4 mm<sup>2</sup></li> <li>Flexible 0.14 ... 2.5 mm<sup>2</sup></li> </ul> </li> </ul>				
<b>Versions</b>						
<ul style="list-style-type: none"> <li>Two clamping points</li> <li>Three clamping points</li> <li>Four clamping points</li> </ul>		<b>8WH6000-6CF00</b> <b>8WH6003-6CF00</b> <b>8WH6004-6CF00</b>		1	50 units	1BT
<b>Terminal size 4 mm<sup>2</sup></b>						
 8WH6000-6AG00		<b>Isolating terminals, terminal size 4 mm<sup>2</sup></b> <ul style="list-style-type: none"> <li>With two clamping points</li> <li>Terminal width 6.2 mm</li> <li><math>I_{\max} = 20</math> A</li> <li><math>U_{\max} = 400</math> V</li> <li>AWG 24 ... 10</li> <li>Connection capacity, one conductor               <ul style="list-style-type: none"> <li>Rigid 0.2 ... 6 mm<sup>2</sup></li> <li>Flexible 0.2 ... 4 mm<sup>2</sup></li> </ul> </li> </ul>				
		<b>8WH6000-6AG00</b>		1	50 units	1BT
<b>Accessories</b>						
 8WH9000-3SC00		<b>Covers, for terminal size 2.5 mm<sup>2</sup></b> Width 2.2 mm <ul style="list-style-type: none"> <li>For two clamping points</li> <li>For three clamping points</li> <li>For four clamping points</li> </ul>				
		<b>8WH9000-3SC00</b> <b>8WH9000-3SD00</b> <b>8WH9000-5GA00</b>		100	50 units	1BT
 8WA9003-1GA00		<b>Covers, for terminal size 4 mm<sup>2</sup></b> <ul style="list-style-type: none"> <li>For two clamping points</li> <li>Width 2.2 mm</li> </ul>				
		<b>8WH9003-1GA00</b>		100	50 units	1BT
 8WH9070-0AA00		<b>Compartment partitions, for terminal size 1.5 ... 4 mm<sup>2</sup></b> <ul style="list-style-type: none"> <li>For two clamping points</li> <li>For visual and electrical separation of terminal groups</li> <li>2 mm thick</li> <li>Gray</li> </ul>				
		<b>8WH9070-0AA00</b>		100	50 units	1BT
 8WH9070-0AA00		<b>Compartment partitions, for terminal size 1.5 ... 4 mm<sup>2</sup></b> <ul style="list-style-type: none"> <li>For three clamping points</li> <li>For visual and electrical separation of terminal groups</li> <li>2 mm thick</li> <li>Gray</li> </ul>				
		<b>8WH9070-0GA00</b>		100	50 units	1BT

For general accessories for 8WH terminal blocks, see chapter "Accessories for 8WH Terminal Blocks"

## 8WH6 iPo Plug-In Terminals

### 8WH6 two-tier terminals

#### Overview

2

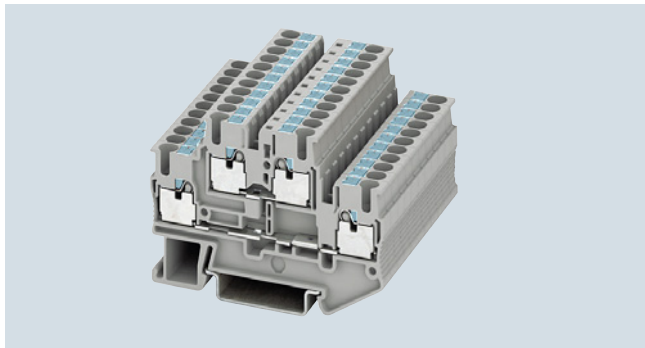

With the two voltage levels routed through two tiers, the 8WH6 two-tier terminals require 50 % less space than equivalent single-tier terminals. To implement a wide range of wiring tasks, connecting combs can be fitted to both tiers of the two-tier

terminal series. Facilities for inscription are provided at each clamping point.

Two-tier terminals with equipotential bonding for the upper and lower tiers are also available.

With the same contour as 8WH6 two-tier terminals, 8WH6 two-tier PE terminals round off the product range. Perfect mechanical and electrical contact with the support rail is provided by simply snapping the terminals onto the rail. 8WH6 two-tier PE terminals comply with all the requirements of IEC 60947-7-2. These include in particular:

- Low contact resistance
- Stainless clamping points
- Green-yellow enclosure
- Additional inscription options







An inscription label can be mounted flat at each clamping point by simply snapping it on.

#### Technical specifications

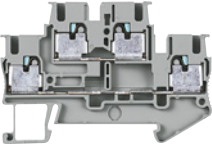
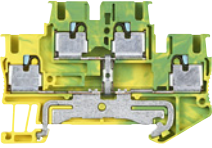
	8WH6020-0AF00 8WH6020-0AF01	8WH6025-0AF00	8WH6020-0CF07	8WH6020-0AG00 8WH6020-0AG01	8WH6025-0AG00	8WH6020-0CG07
Dimensions						
• Width / length / height (NS 35/7.5) in mm	5.2 / 68 / 47.5	5.2 / 78 / 55		6.2 / 83.5 / 47.5		
Max. electrical data						
• $I_{max}$ in A	26	26 <sup>1)</sup>	--	32		--
• $U_{max}$ in V	500		--	500		--
• Max. Ø in mm <sup>2</sup>	0.14 ... 4			0.2 ... 6		
• AWG	26 ... 12			24 ... 10		
Rating according to IEC 60947-7-1						
• Rated voltage in V (IEC)	500		--	500 / 600		--
• Rated current in A / cross-section in mm <sup>2</sup>						
- IEC	20 / 2.5	20 <sup>1)</sup> / 2.5	-- / --			-- / --
- UL/CSA				30 / --		-- / --
• Nominal cross-section in mm <sup>2</sup> (IEC)	2.5			4		
• AWG cross-section range (IEC)	26 ... 12			24 ... 10 / 24 ... 10		
Connection capacities						
• 1 conductor						
- Rigid in mm <sup>2</sup>	0.14 ... 4			0.2 ... 6		
- Flexible in mm <sup>2</sup>	0.14 ... 2.5			0.2 ... 4		
- Flexible end sleeve with/without plastic sleeve in mm <sup>2</sup>	0.14 ... 2.5			0.25 ... 4		
• Conductor cross-section, direct plug-in						
- Rigid in mm <sup>2</sup>	0.34 ... 4			0.5 ... 6		
- Flexible end sleeve with/without plastic sleeve in mm <sup>2</sup>	0.34 ... 2.5			0.5 ... 4		
General data						
• Stripped length in mm	10			12		
• Molded plastic	PA			PA		
• Flammability Class acc. to UL 94	V0			V0		

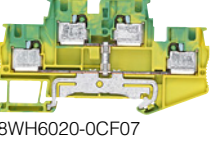
<sup>1)</sup> The total current through all connected conductors must not exceed the max. load current.

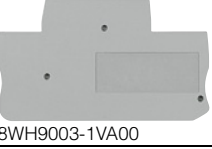
## Selection and ordering data

Version	DT	Article No. <a href="http://www.siemens.com/product?ArticleNo.">www.siemens.com/ product?Article No.</a>	Price per PU	PU (UNIT, SET, M)	PS*/ P. unit	PG
<b>Terminal size 2.5 mm<sup>2</sup></b>						
 <p>8WH6020-0AF00</p>	<b>Two-tier terminals, terminal size 2.5 mm<sup>2</sup></b> <ul style="list-style-type: none"> <li>Terminal width 5.2 mm</li> <li><math>I_{max} = 26</math> A</li> <li><math>U_{max} = 500</math> V</li> <li>AWG 26 ... 12</li> <li>Connection capacity, one conductor               <ul style="list-style-type: none"> <li>Rigid 0.14 ... 4 mm<sup>2</sup></li> <li>Flexible 0.14 ... 2.5 mm<sup>2</sup></li> </ul> </li> </ul>					
	<b>Versions</b> <ul style="list-style-type: none"> <li>Without equipotential bonding               <ul style="list-style-type: none"> <li>Gray</li> <li>Blue</li> </ul> </li> <li>With equipotential bonding</li> </ul>					
		<b>8WH6020-0AF00</b> <b>8WH6020-0AF01</b> <b>8WH6025-0AF00</b>		1	50 units	1BT
				1	50 units	1BT
				1	50 units	1BT
<b>Terminal size 2.5 mm<sup>2</sup></b>						
 <p>8WH6020-0CF07</p>	<b>PE two-tier terminals, terminal size 2.5 mm<sup>2</sup></b> <ul style="list-style-type: none"> <li>Terminal width 5.2 mm</li> <li>AWG 26 ... 12</li> <li>Connection capacity, one conductor               <ul style="list-style-type: none"> <li>Rigid 0.14 ... 4 mm<sup>2</sup></li> <li>Flexible 0.14 ... 2.5 mm<sup>2</sup></li> </ul> </li> <li>Green/yellow</li> </ul>					
	<b>Note</b> Bridging the terminal is only possible in the top tier (in the center).					
		<b>8WH6020-0CF07</b>		1	50 units	1BT
<b>Terminal size 4 mm<sup>2</sup></b>						
 <p>8WH6025-0AG00</p>	<b>Two-tier terminals, terminal size 4 mm<sup>2</sup></b> <ul style="list-style-type: none"> <li>Terminal width 6.2 mm</li> <li><math>I_{max} = 32</math> A</li> <li><math>U_{max} = 500</math> V</li> <li>AWG 24 ... 10</li> <li>Connection capacity, one conductor               <ul style="list-style-type: none"> <li>Rigid 0.2 ... 6 mm<sup>2</sup></li> <li>Flexible 0.2 ... 4 mm<sup>2</sup></li> </ul> </li> </ul>					
	<b>Versions</b> <ul style="list-style-type: none"> <li>Without equipotential bonding               <ul style="list-style-type: none"> <li>Gray</li> <li>Blue</li> </ul> </li> <li>With equipotential bonding</li> </ul>					
		<b>8WH6020-0AG00</b> <b>8WH6020-0AG01</b> <b>8WH6025-0AG00</b>		1	50 units	1BT
				1	50 units	1BT
				1	50 units	1BT
<b>Terminal size 4 mm<sup>2</sup></b>						
 <p>8WH6020-0CF07</p>	<b>PE two-tier terminals, terminal size 4 mm<sup>2</sup></b> <ul style="list-style-type: none"> <li>Terminal width 6.2 mm</li> <li>AWG 24 ... 10</li> <li>Connection capacity, one conductor               <ul style="list-style-type: none"> <li>Rigid 0.2 ... 6 mm<sup>2</sup></li> <li>Flexible 0.2 ... 4 mm<sup>2</sup></li> </ul> </li> <li>Green/yellow</li> </ul>					
	<b>Note</b> Bridging the terminal is only possible in the top tier (in the center).					
		<b>8WH6020-0CF07</b>		1	50 units	1BT
<b>Accessories</b>						
 <p>8WH9000-4SE00</p>	<b>Covers, for terminal size 1.5 ... 2.5 mm<sup>2</sup></b> <ul style="list-style-type: none"> <li>Width 2.2 mm</li> <li>Gray</li> </ul>					
		<b>8WH9000-4SE00</b>		100	50 units	1BT
 <p>8WH9003-1VA00</p>	<b>Covers, for terminal size 1.5 ... 4 mm<sup>2</sup></b> <ul style="list-style-type: none"> <li>For two clamping points</li> <li>Width 2.2 mm</li> </ul>					
		<b>8WH9003-1VA00</b>		100	50 units	1BT
 <p>8WH9070-0BA00</p>	<b>Compartment partitions, for terminal size 1.5 ... 4 mm<sup>2</sup></b> <ul style="list-style-type: none"> <li>For visual and electrical separation of terminal groups</li> <li>2 mm thick</li> <li>Gray</li> </ul>					
		<b>8WH9070-0BA00</b>		100	50 units	1BT

For general accessories for 8WH terminal blocks, see chapter "Accessories for 8WH Terminal Blocks"

## 8WH6 iPo Plug-In Terminals

Notes

2

## 8WH6 iPo Installation Terminals

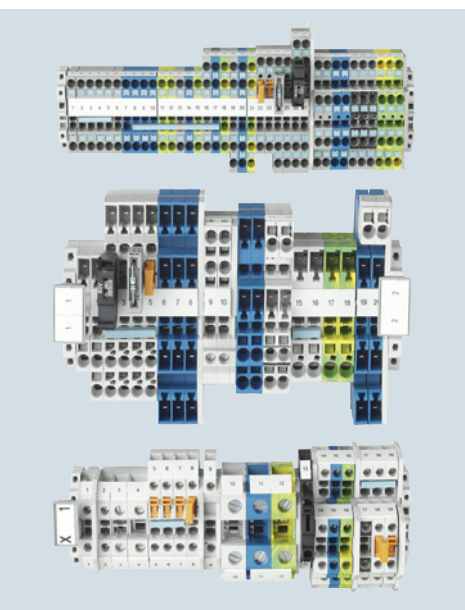

3/2	<b>Introduction</b>
3/4	<b>8WH through-type terminals</b>
3/6	<b>8WH through-type screw terminals</b>
3/8	<b>8WH N-conductor isolating terminals</b>
3/10	<b>8WH N-conductor isolating screw terminals</b>
3/12	<b>8WH installation terminals</b>

**For further technical product information:**

Siemens Industry Online Support:  
[www.siemens.com/lowvoltage/product-support](http://www.siemens.com/lowvoltage/product-support)

- Application example
- Certificate
- Characteristic
- Download
- FAQ
- Manual
- Product note
- Software archive
- Technical data

## 8WH6 iPo Installation Terminals

### Introduction

### Overview

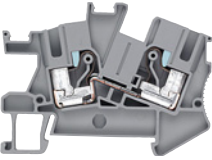
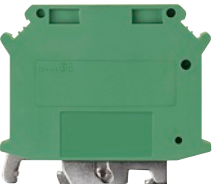
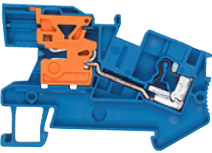
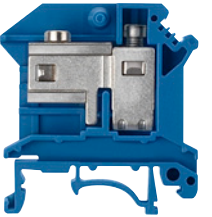
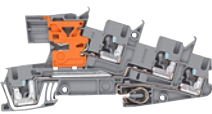
	Devices	Page	Function
	8WH through-type terminals	3/4	Connection of incoming and outgoing conductors up to 6 mm <sup>2</sup>
	8WH through-type screw terminals	3/6	Connection of incoming and outgoing conductors up to 35 mm <sup>2</sup> with screw terminals
	8WH N-conductor isolating terminals	3/8	Terminal blocks up to 6 mm <sup>2</sup> and connection of an N-bus-bar 10 × 3 mm
	8WH N-conductor isolating screw terminals	3/10	Terminal blocks with screw connection up to 35 mm <sup>2</sup> and connection of an N-busbar 10 × 3 mm
	8WH installation terminals	3/12	Terminal blocks for connection of an N-busbar 10 × 3 mm. These terminals offer up to three terminal functions in a single enclosure and are optimized for distribution board applications in installation technology.



Conductor cross-section	Terminal type <sup>1)</sup>	Terminal type →	Screw terminals	iPo technology	Article No. (digits 8 ... 12)	
		Design →	Standard	Insta		
		No. of clamping points →	2			
		Article No. (digits 1 ... 7) →	8WH1001	8WH6001		
		Color				
2.5 mm <sup>2</sup>	Through-type	Gray	--	✓	0AF00	
		Blue	--	✓	0AF01	
	N-conductor isolating	Blue	--	✓	0BF01	
	PE	Green/yellow	--	✓	0CF07	
	Insta	L	Gray	--	✓	4QF00
		L/L		--	✓	4DF00
		L/N		--	✓	4CF00
		PE/L/L		--	✓	4HF00
		PE/L/N		--	✓	4EF00
		PE/L/NT		--	✓	4FF00
PE/L/N isolating blade			--	✓	4GF00	
PE/L/L isolating blade			--	✓	4NF00	
4 mm <sup>2</sup>	Through-type	Gray	--	✓	0AG00	
		Blue	--	✓	0AG01	
	N-conductor isolating	Blue	--	✓	0BG01	
	PE	Green/yellow	--	✓	0CG07	
6 mm <sup>2</sup>	Through-type	Gray	--	✓	0AH00	
		Blue	--	✓	0AH01	
	N-conductor isolating	Blue	--	✓	0BH01	
	PE	Green/yellow	--	✓	0CH07	
10 mm <sup>2</sup>	N-conductor isolating	Blue	✓	--	0BJ01	
16 mm <sup>2</sup>	Through-type	Gray	✓	--	0AK00	
		Blue	✓	--	0AK01	
	N-conductor isolating	Blue	✓	--	0BK01	
	PE	Green/yellow	✓	--	0CK07	
35 mm <sup>2</sup>	Through-type	Gray	✓	--	0AM00	
		Blue	✓	--	0AM01	
	N-conductor isolating	Blue	✓	--	0BM01	
	PE	Green/yellow	✓	--	0CM07	

1) Only the main terminal types are listed here. You will find further versions on the following pages.

## 8WH6 iPo Installation Terminals

### 8WH through-type terminals

#### Overview

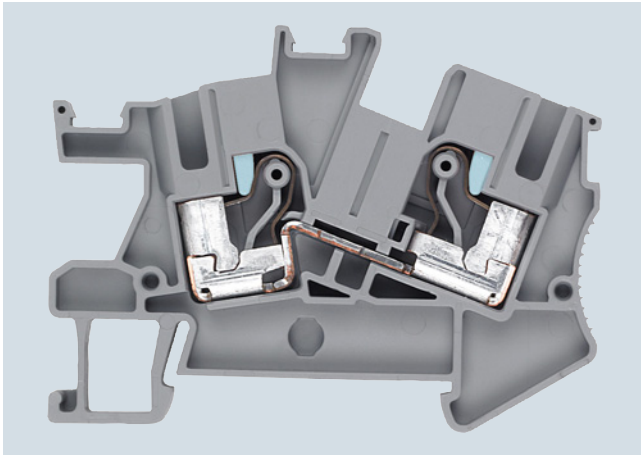

All types of conductors can be used with 8WH6 iPo technology. Rigid conductors and crimped flexible conductors are plugged directly into the terminal.

Flexible, untreated conductors can be connected using a screwdriver.

These terminals can be used interconnected with the N-busbar 10 × 3 mm.

An inscription label can be snapped on to the middle of each terminal at the front. Labels can also be mounted flat on the clamping points of the terminals.

#### Technical specifications

		8WH6001-0AF00 8WH6001-0AF01	8WH6001-0CF07	8WH6001-0AG00 8WH6001-0AG01	8WH6000-0CG07	8WH6001-0AH00 8WH6001-0AH01	8WH6001-0AH07
Cross-section	mm <sup>2</sup>	2.5	2.5 (PE)	4	4 (PE)	6	6 (PE)
Dimensions							
• Width / length / width of cover	mm	5.2 / 59.5 / 2.2		6.2 / 66 / 2.2		8.2 / 66 / 2.2	
• Height (TS 35/7.5 / TS 35/15)	mm	43 / 50.5		46.3 / 53.8		50 / 57.5	
Rated current $I_n$ cross-section	A/mm <sup>2</sup>	24 / 2.5	-- / 2.5	32 / 4	-- / 4	41 / 6	-- / 6
Max. load current $I_{max}$ / cross-section	A/mm <sup>2</sup>	24 / 4	-- / 4	32 / 6	-- / 6	50/10	-- / 10
Rated voltage $U_n$	V	800	--	800	--	800	--
Connection capacities							
• Rigid	mm <sup>2</sup>	0.14 ... 4		0.2 ... 6		0.5 ... 10	
• Flexible with end sleeve	mm <sup>2</sup>	0.25 ... 2.5		0.25 ... 4		0.5 ... 6	
Stripped length	mm	10		12	10	12	
Molded plastic type		PA					
Flammability class acc. to UL 94		V0					
Support rails/protective conductor busbars		--	See page 1/3, section "Support rails"	--	See page 1/3, section "Support rails"	--	See page 1/3, section "Support rails"

#### Selection and ordering data

Version	DT	Article No. <a href="http://www.siemens.com/product?Article No.">www.siemens.com/ product?Article No.</a>	Price per PU	PU (UNIT, SET, M)	PS*/ P. unit	PG
---------	----	--	-----------------	-------------------------	-----------------	----

#### Terminal size 2.5 mm<sup>2</sup>

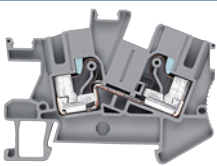

8WH6001-0AF00

#### Through-type terminals, terminal size 2.5 mm<sup>2</sup>, acc. to IEC 60 947-7-1

- Terminal width 5.2 mm, terminal length 59.5 mm
- Terminal height (NS 35/7.5) 43 mm
- Max. load current  $I_{max} = 24$  A
- Rated voltage  $U_n = 800$  V
- Rigid 0.14 ... 4 mm<sup>2</sup>
- Flexible with end sleeve 0.14 ... 2.5 mm<sup>2</sup>
- AWG 26 ... 12

#### Versions

- Gray
- Blue

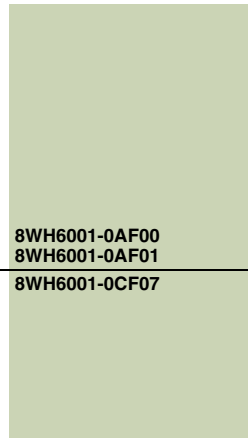

8WH6001-0AF00  
8WH6001-0AF01

1 50 units 1BT  
1 50 units 1BT



8WH6001-0CF07







#### Through-type PE terminals, terminal size 2.5 mm<sup>2</sup>, IEC 60 947-7-2

- Green/yellow
- Terminal width 5.2 mm, terminal length 59.5 mm
- Terminal height 43 mm
- Cross-section max. 4 mm<sup>2</sup>
- Rigid 0.2 ... 4 mm<sup>2</sup>
- Flexible with end sleeve 0.2 ... 2.5 mm<sup>2</sup>
- AWG 24 ... 12

8WH6001-0CF07

1 50 units 1BT

## 8WH through-type terminals

Version	DT	Article No. <a href="http://www.siemens.com/product?ArticleNo.">www.siemens.com/ product?Article No.</a>	Price per PU	PU (UNIT, SET, M)	PS*/ P. unit	PG
<b>Terminal size 4 mm<sup>2</sup></b>						
 8WH6001-0AG00		<b>Through-type terminals, terminal size 4 mm<sup>2</sup>, acc. to IEC 60947-7-1</b> <ul style="list-style-type: none"> <li>Terminal width 6.2 mm</li> <li>Terminal length 66 mm</li> <li>Terminal height 46.3 mm</li> <li>Max. load current <math>I_{max} = 32</math> A</li> <li>Rated voltage <math>U_n = 800</math> V</li> <li>Rigid 0.2 ... 6 mm<sup>2</sup></li> <li>Flexible with end sleeve 0.2 ... 4 mm<sup>2</sup></li> <li>AWG 24 ... 10</li> </ul>				
Versions						
<ul style="list-style-type: none"> <li>Gray</li> <li>Blue</li> </ul>		<b>8WH6001-0AG00</b> <b>8WH6001-0AG01</b>		1 50 units	1BT	1BT
 8WH6001-0AG07		<b>Through-type PE terminals, terminal size 4 mm<sup>2</sup>, acc. to IEC 60947-7-2</b> <ul style="list-style-type: none"> <li>Green/yellow</li> <li>Terminal width 6.2 mm</li> <li>Terminal length 66 mm</li> <li>Terminal height 46.3 mm</li> <li>Rigid 0.2 ... 6 mm<sup>2</sup></li> <li>Flexible with end sleeve 0.2 ... 4 mm<sup>2</sup></li> <li>AWG 24 ... 10</li> </ul>				
Versions						
		<b>8WH6001-0CG07</b>		1 50 units	1BT	1BT
<b>Terminal size 6 mm<sup>2</sup></b>						
 8WH6001-0AH00		<b>Through-type terminals, terminal size 6 mm<sup>2</sup>, acc. to IEC 60947-7-1</b> <ul style="list-style-type: none"> <li>Terminal width 8.2 mm</li> <li>Terminal length 66 mm</li> <li>Terminal height 50 mm</li> <li>Max. load current <math>I_{max} = 41</math> A</li> <li>Rated voltage <math>U_n = 800</math> V</li> <li>Rigid 0.5 ... 10 mm<sup>2</sup></li> <li>Flexible with end sleeve 0.5 ... 6 mm<sup>2</sup></li> <li>AWG 20 ... 8</li> </ul>				
Versions						
<ul style="list-style-type: none"> <li>Gray</li> <li>Blue</li> </ul>		<b>8WH6001-0AH00</b> <b>8WH6001-0AH01</b>		1 50 units	1BT	1BT
 8WH6001-0AH01		<b>Through-type PE terminals, terminal size 6 mm<sup>2</sup>, acc. to IEC 60947-7-2</b> <ul style="list-style-type: none"> <li>Green/yellow</li> <li>Terminal width 8.2 mm</li> <li>Terminal length 66 mm</li> <li>Terminal height 50 mm</li> <li>Rigid 0.5 ... 10 mm<sup>2</sup></li> <li>Flexible without end sleeve 0.5 ... 10 mm<sup>2</sup></li> <li>Flexible with end sleeve 0.5 ... 6 mm<sup>2</sup></li> <li>AWG 20 ... 8</li> </ul>				
Versions						
		<b>8WH6001-0CH07</b>		1 50 units	1BT	1BT
<b>Accessories</b>						
 8WH9143-0AF01		<b>Support brackets</b> <ul style="list-style-type: none"> <li>Made of blue molded plastic</li> <li>For holding the N-busbar</li> </ul>				
Versions						
<ul style="list-style-type: none"> <li>For terminal size 2.5 ... 4 mm<sup>2</sup></li> <li>For terminal size 6 mm<sup>2</sup></li> </ul>		<b>8WH9143-0AF01</b> <b>8WH9143-0AH01</b>		1 50 units	1BT	1BT
 8WH9000-1WA00		<b>Covers</b> Gray				
Versions						
<ul style="list-style-type: none"> <li>For terminal size 2.5 mm<sup>2</sup></li> <li>For terminal size 4 mm<sup>2</sup></li> <li>For terminal size 6 mm<sup>2</sup></li> </ul>		<b>8WH9000-1WA00</b> <b>8WH9003-7WA00</b> <b>8WH9004-1WA00</b>		100 50 units	1BT	1BT

For general accessories for 8WH terminal blocks, see chapter "Accessories for 8WH Terminal Blocks"

## 8WH6 iPo Installation Terminals

### 8WH through-type screw terminals

#### Overview

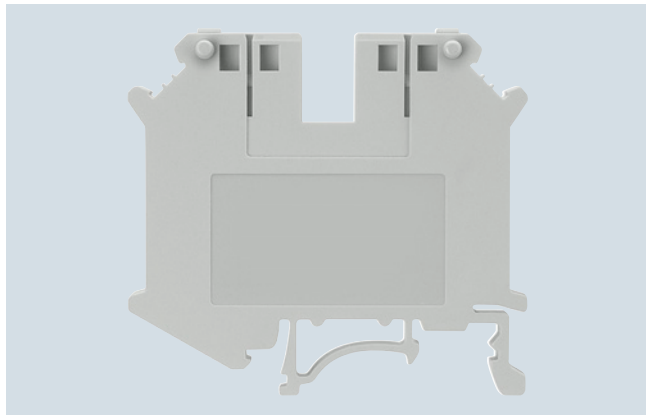

We offer a comprehensive range of installation terminals with iPo technology for use in building management systems. We also offer a range of compact, cost-effective terminal blocks with screw terminals for connecting larger cross-sections.

Terminal blocks mounted on N-busbars are most commonly used in building management systems. In order to enable the butt-mounting of different terminals, contact to the N-busbar is always on the same mounting level. This means that 8WH1-001 screw terminals and 8WH6-001 plug-in terminals can be combined as required and mounted on a single support rail.

Labels can be affixed at each clamping point by simply snapping them on at the front.

#### Technical specifications

		8WH1001-0AK00 8WH1001-0AK01	8WH1001-0CK07	8WH1001-0AM00 8WH1001-0AM01	8WH1001-0CM07
Cross-section	mm <sup>2</sup>	16	16 (PE)	35	35 (PE)
Max. cross-section with comb (rigid / flexible)	mm <sup>2</sup>	16 / 16	--	35 / 35	--
Dimensions					
• Width / length / width of cover	mm	12.2 / 42.5 / 1.8	12.2 / 42.5 / --	15.2 / 55 / --	15.2 / 55 / --
• Height (TS 35/7.5 / TS 35/15)	mm	47 / 54.5 / 52	47 / 54.5 / 52	51 / 58.5 / 56	51 / 58.5 / 56
Max. load current $I_{max}$ / cross-section	A/mm <sup>2</sup>	101 / 25	101 / 25	125 / 35	125 / 35
Rated impulse withstand voltage / pollution degree	kV	6 / 3	6 / 3	8 / 3	8 / 3
Overvoltage category / molded plastic group		III / I	III / I	III / I	III / I
Connection capacities					
• For one conductor					
- Rigid	mm <sup>2</sup>	1.5 ... 16	1.5 ... 16	0.75 ... 35	0.75 ... 35
- Flexible with end sleeve	mm <sup>2</sup>	1.5 ... 16	1.5 ... 16	0.75 ... 35	0.75 ... 35
• For two conductors of same cross-section					
- Rigid / flexible	mm <sup>2</sup>	1.5 ... 6 / 1.5 ... 6	1.5 ... 6 / 1.5 ... 4	0.75 ... 15 / 0.75 ... 10	0.75 ... 16 / 0.75 ... 10
- Flexible with end sleeve	mm <sup>2</sup>	1.5 ... 4	1.5 ... 6	0.75 ... 10	0.75 ... 10
Stripped length	mm	11	11	16	16
Plug gauge (IEC 60947-1)		B7	B7	B9	B9
Clamping point: Screw thread / tightening torque	Nm	M4 / 1.5 ... 1.8	M4 / 1.5 ... 1.8	M6 / 3.2 ... 3.7	M5 / 3.2 ... 3.7
Fixing: Screw thread / tightening torque	Nm	--	M4 / 1.5 ... 1.8	--	M5 / 2.5 ... 3
Molded plastic type		PA	PA	PA	PA
Flammability Class acc. to UL 94		V2	V2	V2	V2
Approval data (UL/cUL and CSA)					
• UL/cUL					
- Rated voltage / rated current / conductor sizes	V/A/AWG	600 / 85 / 22-4	-- / -- / 22-4	600 / 115 / 18-2	-- / -- / 18-2
• CSA					
- Rated voltage / rated current / conductor sizes	V/A/AWG	600 / 85 / 22-4	-- / -- / 22-4	600 / 130 / 18-2	-- / -- / --

#### Selection and ordering data

Version	DT	Article No. <a href="http://www.siemens.com/product?Article No.">www.siemens.com/ product?Article No.</a>	Price per PU	PU (UNIT, SET, M)	PS*/ P. unit	PG
---------	----	--	-----------------	-------------------------	-----------------	----

#### Terminal size 16 mm<sup>2</sup>

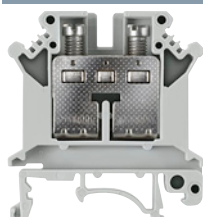

8WH1001-0AK00

#### Through-type screw terminals, terminal size 16 mm<sup>2</sup>

Width 12.2 mm









#### Versions

- Gray
- Blue

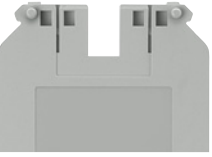
**8WH1001-0AK00**  
**8WH1001-0AK01**

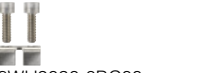
1 50 units 1BT  
1 50 units 1BT

## 8WH through-type screw terminals

Version	DT	Article No. <a href="http://www.siemens.com/product?Article.No.">www.siemens.com/ product?Article No.</a>	Price per PU	PU (UNIT, SET, M)	PS*/ P. unit	PG			
<b>Terminal size 16 mm<sup>2</sup> (continued)</b>									
 <p>8WH1001-0CK07</p>		<b>PE through-type screw terminals, terminal size 16 mm<sup>2</sup></b> <ul style="list-style-type: none"> <li>• Width 12.2 mm</li> <li>• Enclosed at both ends</li> <li>• Green/yellow</li> </ul>			1 50 units	1BT			
<b>Terminal size 35 mm<sup>2</sup></b>									
 <p>8WH1001-0AM00</p>		<b>Through-type screw terminals, terminal size 35 mm<sup>2</sup></b> <ul style="list-style-type: none"> <li>• Width 16 mm</li> <li>• Enclosed at both ends</li> </ul> <table border="1"> <thead> <tr> <th>Versions</th> </tr> </thead> <tbody> <tr> <td>• Gray</td> </tr> <tr> <td>• Blue</td> </tr> </tbody> </table>	Versions	• Gray	• Blue			1 50 units	1BT
Versions									
• Gray									
• Blue									
 <p>8WH1001-0CM07</p>		<b>PE through-type screw terminals, terminal size 35 mm<sup>2</sup></b> <ul style="list-style-type: none"> <li>• Width 16 mm</li> <li>• Enclosed at both ends</li> <li>• Green/yellow</li> </ul>			1 50 units	1BT			
<b>Accessories</b>									
 <p>8WH9005-3PA00</p>		<b>Covers, for screw terminals</b> <ul style="list-style-type: none"> <li>• 10/16 mm<sup>2</sup></li> <li>• Width 2 mm</li> <li>• Gray</li> </ul>			100 50 units	1BT			
 <p>8WH9030-6AL00</p>		<b>Bridge, 10-pole</b> For through-type terminals, 16 mm <sup>2</sup> , gray and blue			1 10 units	1BT			
 <p>8WH9030-6BC00</p>		<b>Bridge, 2-pole</b> For through-type terminals, 35 mm <sup>2</sup> , gray and blue			1 10 units	1BT			
 <p>8WH9030-6BD00</p>		<b>Bridge, 3-pole</b> For through-type terminals, 35 mm <sup>2</sup> , gray and blue			1 10 units	1BT			
 <p>8WH9070-6HA00</p>		<b>Compartment partitions</b> For through-type terminals, 16 mm <sup>2</sup> , gray and blue			100 50 units	1BT			
 <p>8WH9070-6GA00</p>		<b>Insulation plates</b> For through-type terminals, 16 and 35 mm <sup>2</sup> , gray and blue			100 50 units	1BT			

For general accessories for 8WH terminal blocks, [see chapter "Accessories for 8WH Terminal Blocks"](#)

## 8WH6 iPo Installation Terminals

### 8WH N-conductor isolating terminals

#### Overview

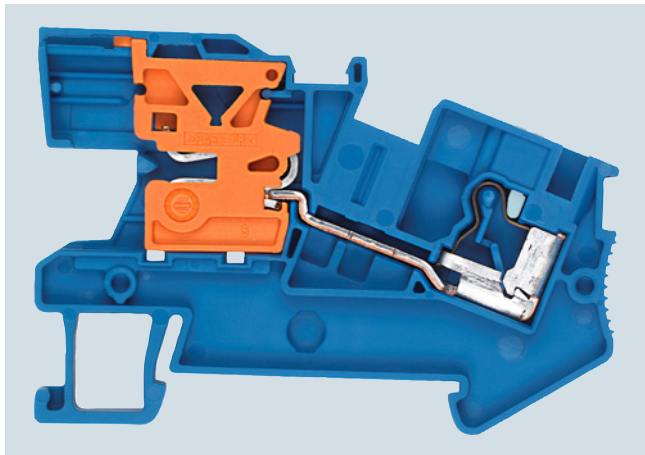

The N-conductor disconnect slides are in the same position on all 8WH6-001 terminals using iPo plug-in technology.

A 10 × 3 mm busbar is used.

**Notice:** Only use Cu busbars.





Installation instructions: To ensure that the N-busbars are securely mounted, the support brackets must be placed at the beginning and end of each terminal strip (in the case of longer terminal strips: every 20 cm).

A label can be snapped on to the middle of the terminal at the front. Labels can also be mounted flat on the clamping points of the terminals (not with N-busbar connection).

#### Technical specifications

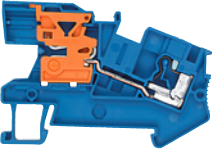
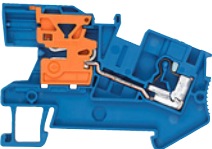
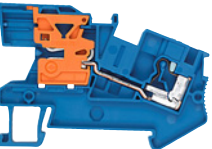
		8WH6001-0BF01	8WH6001-0BG01	8WH6001-0BH01
Cross-section	mm <sup>2</sup>	2.5	4	6
Dimensions				
• Width / length / width of cover	mm	5.2 / 59 / 2.2	6.2 / 66 / 2.2	8.2 / 66 / 2.2
• Height (NS 35/7.5 / NS 35/15)	mm	46.3/ 53.8	46.3/ 53.8	50 / 57.5
Rated current I <sub>n</sub> / cross-section	A/mm <sup>2</sup>	24 / 2.5	32 / 4	41 / 6
Rated voltage U <sub>n</sub>	V	250	250	400
Connection capacities				
• Rigid	mm <sup>2</sup>	0.14 ... 4	0.2 ... 6	0.5 ... 10
• Flexible with end sleeve	mm <sup>2</sup>	0.25 ... 2.5	0.25 ... 4	0.5 ... 6
Stripped length	mm	10	10	12
Molded plastic type		PA	PA	PA
• Flammability Class acc. to UL 94		V0	V0	V0

## Selection and ordering data

Version	DT	Article No. <a href="http://www.siemens.com/product?Article No.">www.siemens.com/ product?Article No.</a>	Price per PU	PU (UNIT, SET, M)	PS*/ P. unit	PG
<b>Terminal size 2.5 mm<sup>2</sup></b>						
 8WH6001-0BF01		<b>N-conductor isolating terminals, terminal size 2.5 mm<sup>2</sup>, acc. to IEC 60947-7-1</b> <ul style="list-style-type: none"> <li>• Two clamping points</li> <li>• Terminal width 5.2 mm</li> <li>• Terminal length 59 mm</li> <li>• Terminal height (NS 35/7.5) 46.3 mm</li> <li>• Rated current / cross-section <math>I_n = 24</math> A / 2.5 mm<sup>2</sup></li> <li>• Rated voltage <math>U_n = 250</math> V</li> <li>• Rigid 0.14 ... 4 mm<sup>2</sup></li> <li>• Flexible with end sleeve 0.14 ... 2.5 mm<sup>2</sup></li> <li>• AWG 26 ... 12</li> </ul>		1	50 units	1BT
<b>Terminal size 4 mm<sup>2</sup></b>						
 8WH6001-0BG01		<b>N-conductor isolating terminals, terminal size 4 mm<sup>2</sup>, acc. to IEC 60947-7-1</b> <ul style="list-style-type: none"> <li>• Two clamping points</li> <li>• Terminal width 6.2 mm</li> <li>• Terminal length 66 mm</li> <li>• Terminal height (NS 35/7.5) 46.3 mm</li> <li>• Rated current / cross-section <math>I_n = 32</math> A / 4 mm<sup>2</sup></li> <li>• Rated voltage <math>U_n = 250</math> V</li> <li>• Rigid 0.2 ... 6 mm<sup>2</sup></li> <li>• Flexible with end sleeve 0.25 ... 4 mm<sup>2</sup></li> <li>• AWG 24 ... 10</li> </ul>		1	50 units	1BT
<b>Terminal size 6 mm<sup>2</sup></b>						
 8WH6001-0BH01		<b>N-conductor isolating terminals, terminal size 6 mm<sup>2</sup>, acc. to IEC 60947-7-1</b> <ul style="list-style-type: none"> <li>• Two clamping points</li> <li>• Terminal width 8.2 mm</li> <li>• Terminal length 66.3 mm</li> <li>• Terminal height (NS 35/7.5) 50 mm</li> <li>• Max. load current <math>I_{max} = 41</math> A</li> <li>• Rated current / cross-section <math>I_n = 41</math> A / 6 mm<sup>2</sup></li> <li>• Rated voltage <math>U_n = 400</math> V</li> <li>• Rigid 0.5 ... 10 mm<sup>2</sup></li> <li>• Flexible with end sleeve 0.5 ... 6 mm<sup>2</sup></li> <li>• AWG 20 ... 8</li> </ul>		1	50 units	1BT
<b>Accessories</b>						
 8WH9143-0AF01		<b>Support brackets</b> <ul style="list-style-type: none"> <li>• Made of blue molded plastic</li> <li>• For holding the N-busbar</li> </ul> <b>Versions</b> <ul style="list-style-type: none"> <li>• For terminal size 2.5 ... 4 mm<sup>2</sup></li> <li>• For terminal size 6 mm<sup>2</sup></li> </ul>		1	50 units	1BT
 8WH9000-1SA00		<b>Covers</b> Gray <b>Versions</b> <ul style="list-style-type: none"> <li>• For terminal size 2.5 mm<sup>2</sup></li> <li>• For terminal size 4 mm<sup>2</sup></li> <li>• For terminal size 6 mm<sup>2</sup></li> </ul>		100	50 units	1BT
 8WA2867/8WA2868/ 8WA2870		<b>Feeder terminals, for N-busbars</b> <ul style="list-style-type: none"> <li>• 6 × 6 mm and 10 × 3 mm</li> <li>• Bare</li> </ul> <b>Versions</b> <ul style="list-style-type: none"> <li>• Rated uninterrupted current 32 A, for connection of up to 4 mm<sup>2</sup></li> <li>• Rated uninterrupted current 76 A, for connection of up to 25 mm<sup>2</sup></li> <li>• Rated uninterrupted current 125 A, for connection of up to 35 mm<sup>2</sup></li> </ul>		1	50/2400 units	1BT
 8WA2842		<b>N-busbars, 10 × 3 mm</b> <ul style="list-style-type: none"> <li>• Tin-plated</li> <li>• 1000 mm long</li> </ul>		1	1 unit	1BT

For general accessories for 8WH terminal blocks, see chapter "Accessories for 8WH Terminal Blocks"

## 8WH6 iPo Installation Terminals

### 8WH N-conductor isolating screw terminals

#### Overview

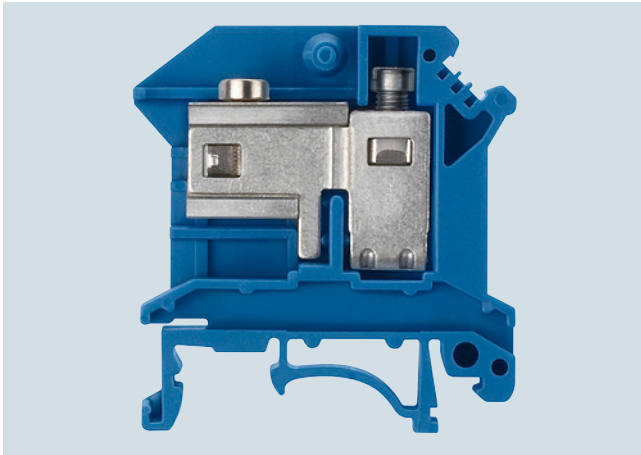

We offer a comprehensive range of installation terminals with iPo plug-in technology for use in building management systems. We also offer a range of compact, cost-effective terminal blocks with screw terminals for connecting larger cross-sections.

Terminal blocks mounted on N-busbars are most commonly used in building management systems. In order to enable the butt-mounting of different terminals, contact to the N-busbar is always on the same mounting level. This means that 8WH1-001 screw terminals and 8WH6-001 plug-in terminals can be combined as required and mounted on a single support rail.

The compact design of our N-conductor isolating terminals makes for a neat and clearly arranged terminal strip. The N-busbar can be connected over the terminal or over the disconnect side of the N-conductor isolating terminal. The N-conductor isolating terminal also makes it easy to perform insulation measurements.

Labels can be affixed on the clamping points (screw) by simply snapping them on at the front.





**Notice:** Only use Cu busbars.

#### Technical specifications

		8WH1001-0BJ01	8WH1001-0BK01	8WH1001-0BM01
Cross-section	mm <sup>2</sup>	10	16	35
Dimensions				
• Width / length / width of cover	mm	10.2 / 43.5 / 1.8	12.2 / 43.5 / 1.5	16 / 55 / --
• Height (TS 35/7.5 / TS 35/15)	mm	47 / 54.5 / 52	54 / 61.5 / 59	51 / 58.5 / 56
Max. load current $I_{max}$ / cross-section	A/mm <sup>2</sup>	63 / 16	90 / 25	110 / 35
Rated impulse withstand voltage / pollution degree	kV	6 / 3	6 / 3	6 / 3
Overvoltage category / molded plastic group		III / I	III / I	III / I
Connection capacities				
• For one conductor				
- Rigid	mm <sup>2</sup>	0.5 ... 10	1.5 ... 16	0.75 ... 35
- Flexible with end sleeve	mm <sup>2</sup>	0.5 ... 6	1.5 ... 16	0.75 ... 35
• For two conductors of same cross-section				
- Rigid / flexible	mm <sup>2</sup>	0.5 ... 4 / 0.5 ... 4	1.5 ... 6 / 1.5 ... 4	0.75 ... 16 / 0.75 ... 10
- Flexible with end sleeve	mm <sup>2</sup>	0.5 ... 2.5	1.5 ... 8	0.75 ... 10
Stripped length	mm	12	11	16
Plug gauge (IEC 60947-1)		B5	B6	B9
Clamping point: Screw thread / tightening torque	Nm	M4 / 1.5 ... 1.8	M4 / 1.5 ... 1.8	M6 / 3.2 ... 3.7
Fixing: Screw thread / tightening torque	Nm	M3 / 0.6 ... 0.8	M3 / 0.6 ... 0.8	M5 / 2.5 ... 3
Molded plastic type		PA	PA	PA
Flammability Class acc. to UL 94		V2	V2	V2

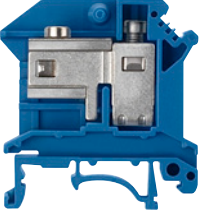
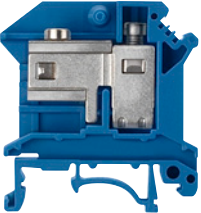
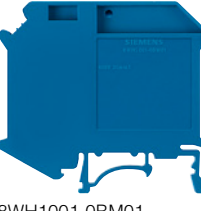
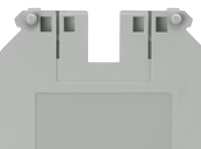

## Selection and ordering data

Version	DT	Article No. <a href="http://www.siemens.com/product?Article No.">www.siemens.com/ product?Article No.</a>	Price per PU	PU (UNIT, SET, M)	PS*/ P. unit	PG
<b>Terminal size 10 mm<sup>2</sup></b>						
		<b>N-conductor isolating screw terminals, terminal size 10 mm<sup>2</sup></b> <ul style="list-style-type: none"> <li>• Width 10 mm</li> <li>• Blue</li> <li>• For 10 x 3 mm N-busbar</li> </ul>		1	50 units	1BT
8WH1001-0BJ01						
<b>Terminal size 16 mm<sup>2</sup></b>						
		<b>N-conductor isolating screw terminals, terminal size 16 mm<sup>2</sup></b> <ul style="list-style-type: none"> <li>• Width 12 mm</li> <li>• Blue</li> <li>• For 10 x 3 mm N-busbar</li> </ul>		1	50 units	1BT
8WH1001-0BK01						
<b>Terminal size 35 mm<sup>2</sup></b>						
		<b>N-conductor isolating screw terminals, terminal size 35 mm<sup>2</sup></b> <ul style="list-style-type: none"> <li>• Width 16 mm</li> <li>• Enclosed at both ends</li> <li>• Blue</li> </ul>		1	50 units	1BT
8WH1001-0BM01						
<b>Accessories</b>						
		<b>Covers, for screw terminals</b> <ul style="list-style-type: none"> <li>• 10/16 mm<sup>2</sup></li> <li>• Width 2 mm</li> <li>• Gray</li> </ul>		100	50 units	1BT
8WH9005-3PA00						
		<b>Support brackets for N-conductor isolating screw terminals, terminal size 10 ... 35 mm<sup>2</sup></b> <ul style="list-style-type: none"> <li>• For holding the N-busbar</li> <li>• To be placed every 20 cm</li> <li>• 2 mm wide</li> </ul>		1	50 units	1BT
8WH9141-0BA01						
		<b>Terminals</b> Blue Versions <ul style="list-style-type: none"> <li>• To 16 mm<sup>2</sup>, width: 10.3 mm</li> </ul>		1	50 units	1BT
8WH9126-0BA01						
		<b>N-busbars, 10 x 3 mm</b> <ul style="list-style-type: none"> <li>• Made of copper, tin-plated</li> <li>• 1000 mm long</li> </ul>		1	1 unit	1BT
8WA2842						

For general accessories for 8WH terminal blocks, see chapter "Accessories for 8WH Terminal Blocks"

## 8WH6 iPo Installation Terminals

### 8WH installation terminals

#### Overview

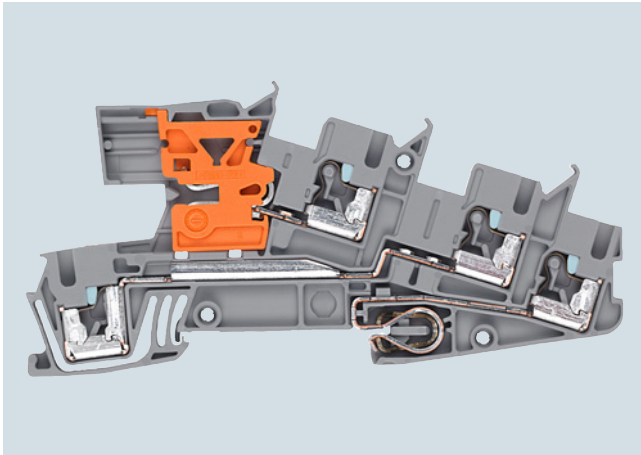

The three-tier plug-in terminals offer optimum operating characteristics for modern building installations. The plug-in connection allows tool-free wiring of the solid conductors.

These terminals can be used interconnected with the N-busbar 10 × 3 mm.

**Notice: Only use Cu busbars.**

Thanks to their compact design, the three-tier terminals can be installed in all types of building distribution boards. A load circuit can be quickly and easily wired, for example using a 5.2-mm-wide installation terminal with terminal size 2.5 mm<sup>2</sup> and PE/L/NT connections.

The double bridge shafts support a multitude of individual wiring tasks. This also means it is practical and convenient to make subsequent modifications to the installation.







Labels can be mounted flat on the clamping points of the terminals.

#### Technical specifications

Installation terminals, standard version		8WH6001-4QF00 8WH6001-4DF00 8WH6001-4CF00	8WH6001-0HF00 8WH6001-4EF00	8WH6001-4FF00
Installation terminals with isolating function			8WH6001-4GF00 8WH6001-4NF00 8WH6001-4PF00 8WH6001-4MF00	
Cross-section	mm <sup>2</sup>	2.5		
Dimensions				
• Width / length / width of cover	mm	5.5 / 101 / 2.2		
• Height (TS 35/7.5 / TS 35/15)	mm	50.5 / 58		
Rated current In cross-section	A/mm <sup>2</sup>	24 / 4		
Max. load current $I_{max}$ / cross-section	A/mm <sup>2</sup>	30 <sup>1)</sup> / 4		
Rated voltage $U_n$	V	400 (L-L) 250 (L-N or L-PE)		
Connection capacities				
• Rigid	mm <sup>2</sup>	0.14 ... 4		
• Flexible with end sleeve	mm <sup>2</sup>	0.14 ... 2.5		
Stripped length without insulation stop sleeve (no insulation stop sleeves should be used when using end sleeves)	mm	10		
Stripped length with insulation stop sleeve (no insulation stop sleeves should be used when using end sleeves)	mm	10		
Plug gauge (IEC 60947-1)		A3		
Molded plastic type		PA		
Flammability Class acc. to UL 94		V0		



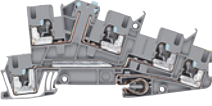

<sup>1)</sup> 3-pole terminal block

## Selection and ordering data

Version	DT	Article No. <a href="http://www.siemens.com/product?Article No.">www.siemens.com/ product?Article No.</a>	Price per PU	PU (UNIT, SET, M)	PS*/ P. unit	PG
<b>Terminal size 2.5 mm<sup>2</sup></b>						
 8WH6001-4QF00   8WH6001-4DF00   8WH6001-4HF00   8WH6001-4FF00		<b>Installation terminals, terminal size 2.5 mm<sup>2</sup>, standard version for N-busbar</b> <ul style="list-style-type: none"> <li>• Gray</li> <li>• Terminal width 5.2 mm</li> <li>• Rigid 0.14 ... 4 mm<sup>2</sup></li> <li>• Flexible with end sleeve 0.14 ... 2.5 mm<sup>2</sup></li> <li>• AWG 26 ... 12</li> <li>• Rated current / cross-section <math>I_n = 24 \text{ A} / 4 \text{ mm}^2</math></li> <li>• Rated voltage <math>U_n = 400 \text{ V}</math> (L-L) <math>U_n = 250 \text{ V}</math> (L-N or L-PE)</li> </ul> <b>Versions</b> <ul style="list-style-type: none"> <li>• L</li> <li>• L/L</li> <li>• L/N</li> <li>• PE/L/L</li> <li>• PE/L/N</li> <li>• PE/L/NT</li> </ul>				
		<b>8WH6001-4QF00</b> <b>8WH6001-4DF00</b> <b>8WH6001-4CF00</b> <b>8WH6001-4HF00</b> <b>8WH6001-4EF00</b> <b>8WH6001-4FF00</b>		1 1 1 1 1 1	50 units 50 units 50 units 50 units 50 units 50 units	1BT 1BT 1BT 1BT 1BT 1BT
 8WH6001-4NF00		<b>Installation terminals, terminal size 2.5 mm<sup>2</sup>, with isolating blade</b> <ul style="list-style-type: none"> <li>• Gray</li> <li>• Terminal width 5.2 mm</li> <li>• Rigid 0.25 ... 4 mm<sup>2</sup></li> <li>• Flexible with end sleeve 0.25 ... 2.5 mm<sup>2</sup></li> <li>• AWG 22-12</li> <li>• Rated current / cross-section <math>I_n = 24 \text{ A} / 4 \text{ mm}^2</math></li> <li>• Rated voltage <math>U_n = 400 \text{ V}</math> (L-L) <math>U_n = 250 \text{ V}</math> (L-N or L-PE)</li> </ul> <b>Versions</b> <ul style="list-style-type: none"> <li>• PE/L/L (standard version, suitable for isolating terminal)</li> <li>• PE/L/N isolating blade</li> <li>• PE/L/L isolating blade</li> </ul>				
		<b>8WH6001-4PF00</b> <b>8WH6001-4GF00</b> <b>8WH6001-4NF00</b>		1 1 1	50 units 50 units 50 units	1BT 1BT 1BT
 8WH6001-4PF00		<b>Installation terminals, terminal size 2.5 mm<sup>2</sup>, for isolating function</b> <ul style="list-style-type: none"> <li>• Gray</li> <li>• Terminal width 5.2 mm</li> <li>• Rigid 0.25 ... 4 mm<sup>2</sup></li> <li>• Flexible with end sleeve 0.25 ... 2.5 mm<sup>2</sup></li> <li>• AWG 22-12</li> <li>• Rated current / cross-section <math>I_n = 24 \text{ A} / 4 \text{ mm}^2</math></li> <li>• Rated voltage <math>U_n = 400 \text{ V}</math> (L-L) <math>U_n = 250 \text{ V}</math> (L-PE)</li> </ul> <b>Versions</b> <ul style="list-style-type: none"> <li>• PE/L/L (standard version, suitable for isolating terminal)</li> <li>• PE/L/L isolation</li> </ul>				
		<b>8WH6001-4PF00</b> <b>8WH6001-4MF00</b>		1 1	50 units 50 units	1BT 1BT

## 8WH6 iPo Installation Terminals

## 8WH installation terminals

Version	DT	Article No. <a href="http://www.siemens.com/product?Article No.">www.siemens.com/ product?Article No.</a>	Price per PU	PU (UNIT, SET, M)	PS*/ P. unit	PG				
<b>Accessories</b>										
 8WH9142-0AF01		<b>Support brackets, for terminal size 2.5 mm<sup>2</sup></b> <ul style="list-style-type: none"> <li>• For holding the N-busbar</li> <li>• To be placed every 20 cm</li> <li>• 2 mm wide</li> </ul>		1	50 units	1BT				
 8WH9000-3SA00		<b>Covers, for terminal size 2.5 mm<sup>2</sup></b> Gray		1	50 units	1BT				
 8WH9000-6SA00		<b>Covers, for terminal size 2.5 mm<sup>2</sup> and isolating terminal in contour</b> Gray		1	50 units	1BT				
 8WA2867/8WA2868/ 8WA2870		<b>Feeder terminals, for N-busbars</b> <ul style="list-style-type: none"> <li>• 6 × 6 mm and 10 × 3 mm</li> <li>• Bare</li> </ul> <table border="1"> <thead> <tr> <th>Versions</th> </tr> </thead> <tbody> <tr> <td> <ul style="list-style-type: none"> <li>• Rated uninterrupted current 32 A, for connection of up to 4 mm<sup>2</sup></li> </ul> </td> </tr> <tr> <td> <ul style="list-style-type: none"> <li>• Rated uninterrupted current 76 A, for connection of up to 25 mm<sup>2</sup></li> </ul> </td> </tr> <tr> <td> <ul style="list-style-type: none"> <li>• Rated uninterrupted current 125 A, for connection of up to 35 mm<sup>2</sup></li> </ul> </td> </tr> </tbody> </table>	Versions	<ul style="list-style-type: none"> <li>• Rated uninterrupted current 32 A, for connection of up to 4 mm<sup>2</sup></li> </ul>	<ul style="list-style-type: none"> <li>• Rated uninterrupted current 76 A, for connection of up to 25 mm<sup>2</sup></li> </ul>	<ul style="list-style-type: none"> <li>• Rated uninterrupted current 125 A, for connection of up to 35 mm<sup>2</sup></li> </ul>		1	50/2400 units	1BT
Versions										
<ul style="list-style-type: none"> <li>• Rated uninterrupted current 32 A, for connection of up to 4 mm<sup>2</sup></li> </ul>										
<ul style="list-style-type: none"> <li>• Rated uninterrupted current 76 A, for connection of up to 25 mm<sup>2</sup></li> </ul>										
<ul style="list-style-type: none"> <li>• Rated uninterrupted current 125 A, for connection of up to 35 mm<sup>2</sup></li> </ul>										
				1	50/750 units	1BT				
				1	50 units	1BT				
 8WA2842		<b>N-busbars, 10 x 3 mm</b> <ul style="list-style-type: none"> <li>• Made of copper, tin-plated</li> <li>• 1000 mm long</li> </ul>		1	1 unit	1BT				

For general accessories for 8WH terminal blocks, see chapter "Accessories for 8WH Terminal Blocks"

## 8WH2 Spring-Loaded Terminals

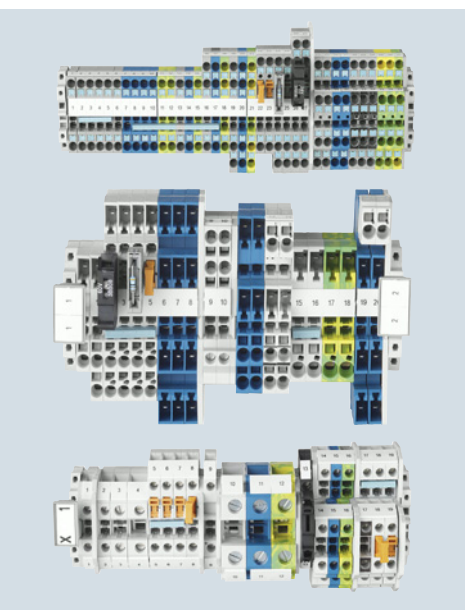

4/2	<b>Introduction</b>
4/3	<b>General data on 8WH</b>
4/7	<b>8WH through-type terminals<sup>1)</sup></b>
4/18	<b>8WH hybrid through-type terminals<sup>1)</sup></b>
4/21	<b>8WH fuse terminals</b>
4/23	<b>8WH isolating blade terminals</b>
4/25	<b>8WH isolating terminals</b>
4/27	<b>8WH two-tier terminals<sup>1)</sup></b>
4/33	<b>8WH three-tier terminals</b>
4/35	<b>8WH four-tier motor terminals</b>
4/37	<b>8WH diode terminals</b>
4/39	<b>8WH two-tier diode terminals</b>

<sup>1)</sup> Also available as a PE version

**For further technical product information:**

Siemens Industry Online Support:  
[www.siemens.com/lowvoltage/product-support](http://www.siemens.com/lowvoltage/product-support)

→ Application example  
 Certificate  
 Characteristic  
 Download  
 FAQ  
 Manual  
 Product note  
 Software archive  
 Technical data

## 8WH2 Spring-Loaded Terminals

### Introduction

#### Overview

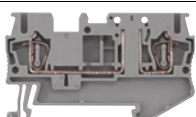
	Devices	Page	Application
<b>8WH terminals</b>			
	Through-type terminals	4/7	Connection of incoming and outgoing conductors up to 35 mm <sup>2</sup>
	Hybrid through-type terminals	4/18	Terminals with a range of connection methods
	Fuse terminals	4/21	Terminals which can be used to protect control circuits, for example
	Isolating blade terminals	4/23	Isolation of the circuit, e.g. for test purposes
	Isolating terminals	4/25	Isolation of the circuit, e.g. for test purposes
	Two-tier terminals	4/27	Compact form of the terminal blocks in which two connection wires can be installed
	Three-tier terminals	4/33	Compact terminal blocks up to 2.5 mm <sup>2</sup> , in which three connection wires can be installed
	Four-tier motor terminals	4/35	Compact terminal blocks up to 4 mm <sup>2</sup> , in which three connection wires plus PE can be installed
	Diode terminals	4/37	Terminal blocks with integrated diodes
	Two-tier diode terminals	4/39	Terminal blocks with integrated diodes

## Overview

Conductor cross-section	Terminal type <sup>1)</sup>	Terminal type → Design → No. of clamping points → Article No. (digits 1 ... 7) → Color	Standard spring-loaded connection					Article No. (digits 8 ... 12)
			Standard		Two-tier			
			2 8WH2000	3 8WH2003	4 8WH2004	4 8WH2020	6 8WH2023	
1.5 mm <sup>2</sup>	Through-type	Gray	✓	✓	✓	✓	--	0AE00
		Blue	✓	✓	✓	✓	--	0AE01
	PE	Green/yellow	✓	✓	✓	✓	--	0CE07
2.5 mm <sup>2</sup>	Through-type	Gray	✓	✓	✓	✓	✓	0AF00
		Blue	✓	✓	✓	✓	✓	0AF01
	Isolating	Gray	✓	✓	✓	--	--	6AF00
	Isolating blade	Gray	✓	✓	✓	--	--	0CF00
		PE	Green/yellow	✓	✓	✓	✓	✓
	4 mm <sup>2</sup>	Through-type	Gray	✓	✓	✓	✓	--
Blue			✓	✓	✓	✓	--	0AG01
Isolating		Gray	✓	--	--	--	--	6AG00
Isolating blade		Gray	✓	--	--	--	--	6CG00
		PE	Green/yellow	✓	✓	✓	✓	--
6 mm <sup>2</sup>	Through-type	Gray	✓	✓	--	--	--	0AH00
		Blue	✓	✓	--	--	--	0AH01
	PE	Green/yellow	✓	✓	--	--	--	0CH07
10 mm <sup>2</sup>	Through-type	Gray	✓	--	--	--	--	0AJ00
		Blue	✓	--	--	--	--	0AJ01
	PE	Green/yellow	✓	--	--	--	--	0CJ07
16 mm <sup>2</sup>	Through-type	Gray	✓	--	--	--	--	0AK00
		Blue	✓	--	--	--	--	0AK01
	PE	Green/yellow	✓	--	--	--	--	0CK07
35 mm <sup>2</sup>	Through-type	Gray	✓	--	--	--	--	0AM00
		Blue	✓	--	--	--	--	0AM01
	PE	Green/yellow	✓	--	--	--	--	0CM07

1) Only the main terminal types are listed here. You will find further versions on the following pages.

## 8WH2 Spring-Loaded Terminals

### General data on 8WH

4

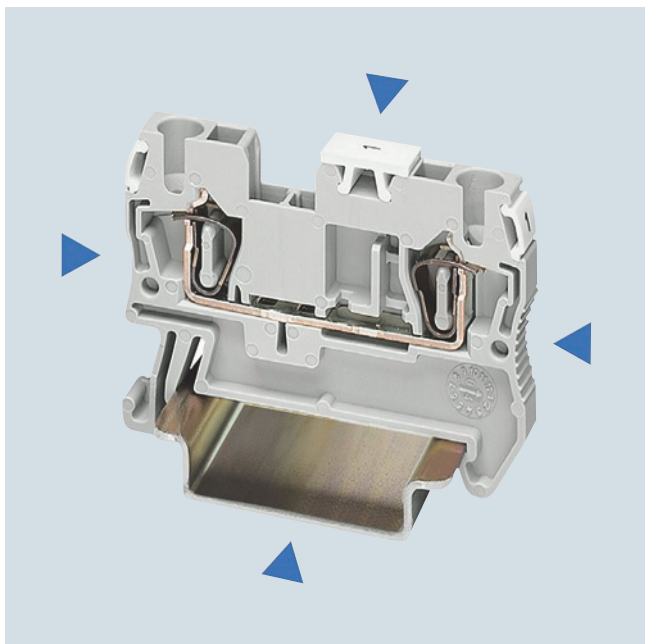

The space-saving design and conductor routing from above make spring-loaded terminals ideal for controlgear installations with minimum available space. The terminals are open at one end and can be closed using the appropriate covers.

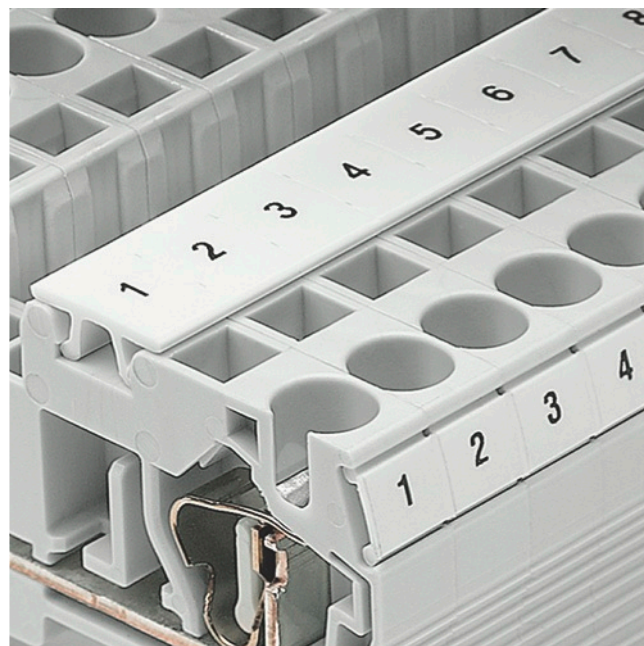

The large and unambiguous marking in the center of the terminal is essential for ensuring reliable installation in minimum time. Each clamping point can also be separately labeled.

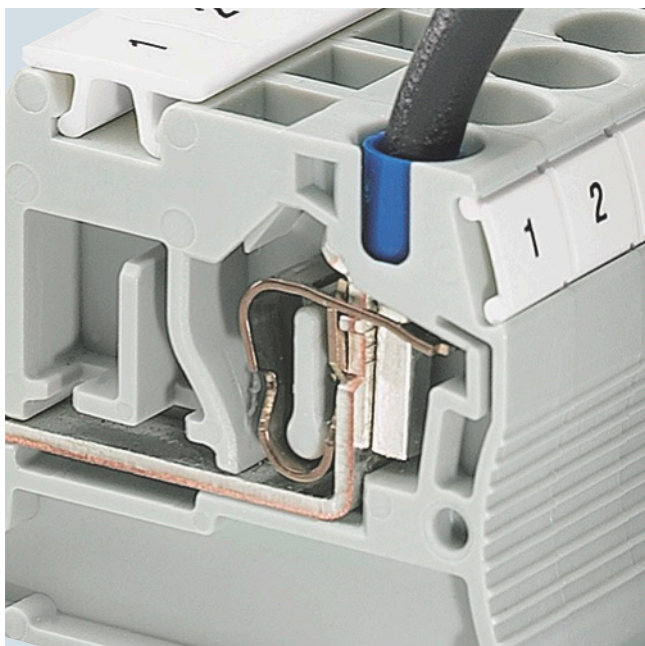

Spring-loaded terminals provide a large connection compartment for fast wiring of flexible and rigid conductors, including conductors with nominal cross-section and a fitted end sleeve.

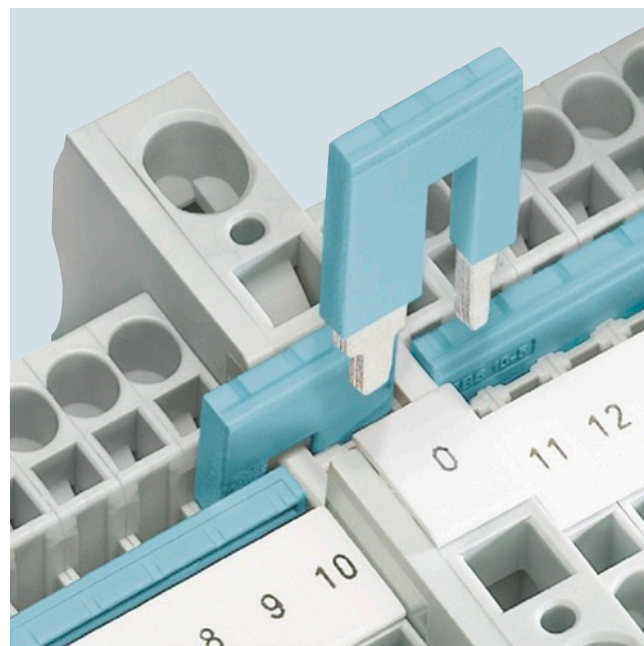

Reducing combs enable easy connection of terminals with various nominal cross-sections. For example, they can be used for the fast creation of infeed blocks, e.g. by connecting a 10 mm<sup>2</sup> spring-loaded terminal with a 2.5 or 4 mm<sup>2</sup> spring-loaded terminal.



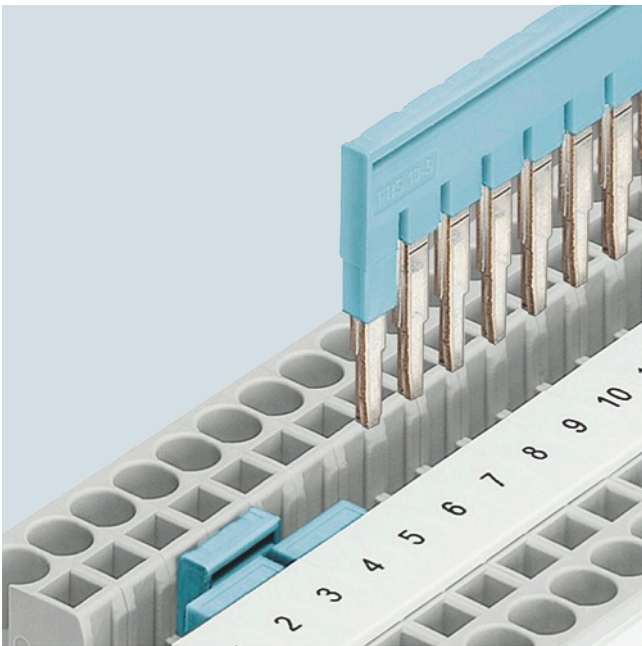

The 2- to 50-pole connecting combs also considerably reduce the time needed for assembly and wiring as they enable up to 50 terminals to be connected in a single step.

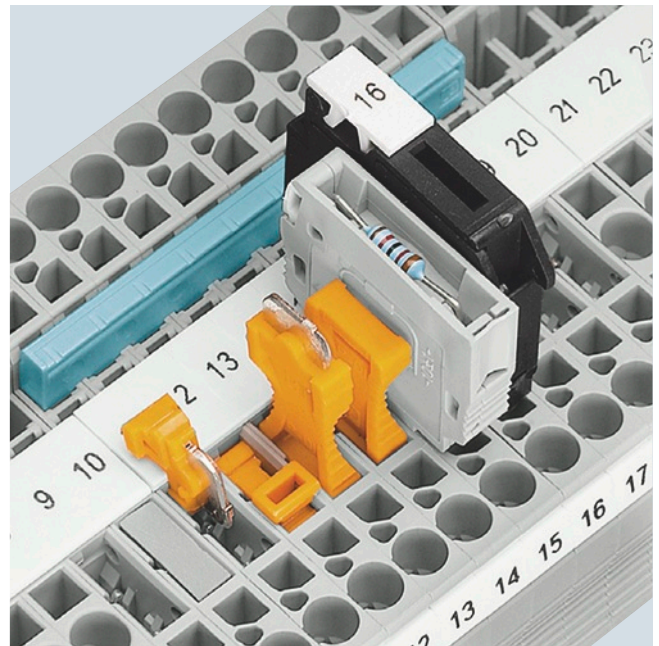

The universal plug-in zones of the isolating terminal can accommodate the isolated through-type connectors, isolating plugs, component connectors and fused connectors.

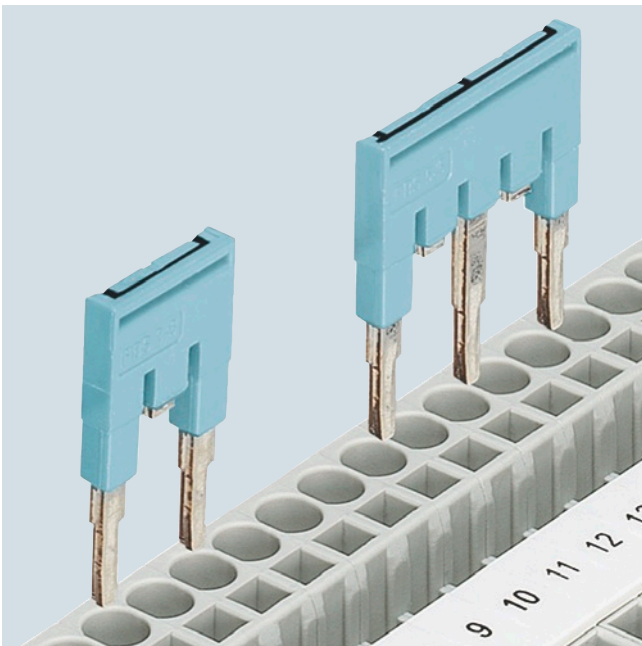

Contact tabs can be removed from the standard comb in order to skip individual terminals. This means that two potentials can run in parallel on a single terminal strip. The contact points can additionally be marked.

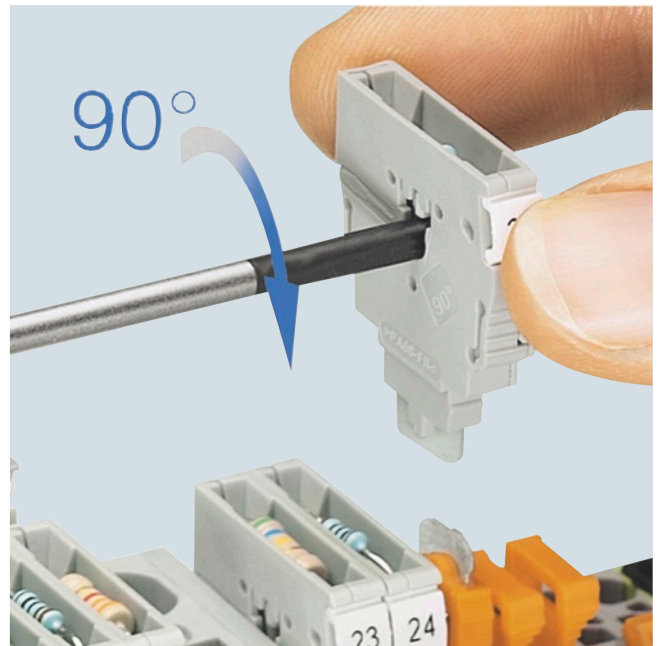

The component connector enables the convenient equipping with electronic components. One turn of the screwdriver opens the contact points and the component is easily inserted.

## 8WH2 Spring-Loaded Terminals

### General data on 8WH

4

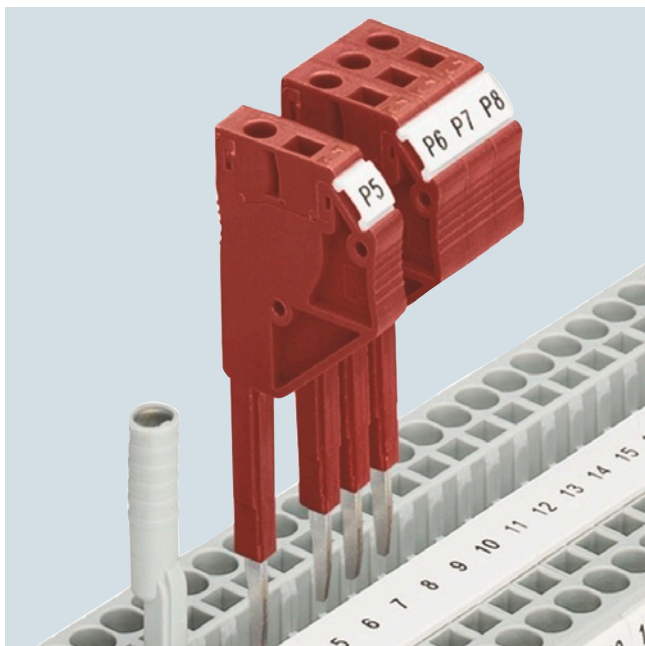

A comprehensive range of test accessories is also available for the spring-loaded terminal series. The test adapters for  $\varnothing$  4 mm test plugs and modular test plugs enable all measuring and testing jobs to be performed in minimum time.



Cover segments are used to cover the projecting terminal segments of three and four-wire terminals when mounting two-wire terminals side-by-side. This ensures touch protection.

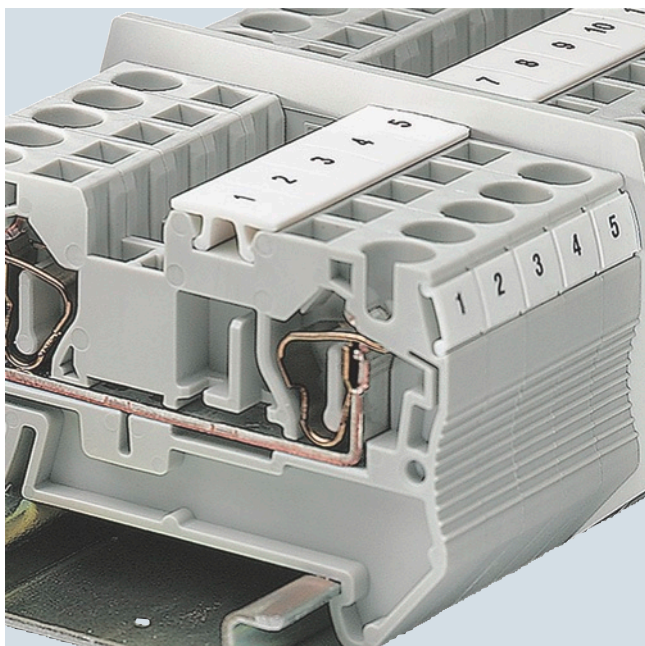

The compartment partitions project beyond the contours of the terminals and separate the groups both visually and electrically.

**Note:** The accessories for 8WH can only be used for 8WH terminals.

## Overview

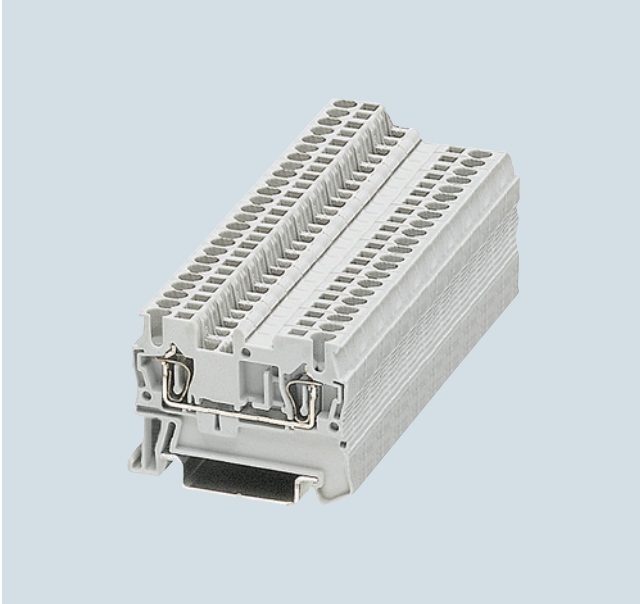
**With two clamping points**

The through-type terminals have an impressive space-saving design and offer optimized handling. With its front connection arrangement this series provides additional space between the cable ducts for wiring.

The double bridge shaft enables individual chain bridging with connecting combs. Accessories are available for testing and labeling.

**With three clamping points**

Terminals with three clamping points are a space-saving alternative to the standard through-type terminals for branching the potential.

It is often necessary for three conductors to be routed to a single terminal. This three clamping point version enables this without the need for additional terminals and jumpers.

**With four clamping points**

The double connection of the through-type terminals with four clamping points enables four conductors to be connected to a single potential. These versions with four clamping points are therefore suitable for use as compact potential distributors.

A label can be snapped on to the middle of each terminal at the front. Further labels can also be mounted flat on the side of the terminals.

**PE/ground conductor function**

The PE through-type terminals are available with the same contour as the through-type terminals. Simply snap the terminals onto the support rail to achieve full mechanical and electrical contact with the support rail.

The PE through-type terminals meet all the requirements of IEC 60947-7-2:

- Low contact resistance
- Stainless clamping points
- Green-yellow enclosure
- Additional inscription options

## Technical specifications

	8WH2000-0AE0.	8WH2000-0CE07	8WH2003-0AE00 8WH2003-0AE01	8WH2003-0CE07	8WH2004-0AE00 8WH2004-0AE01
Dimensions					
• Width/length/cover width in mm	4.2 / 48.5 / 2.2		4.2 / 60.5 / 2.2		4.2 / 72 / 2.2
• Height (NS 35/7.5 / NS 35/15) in mm	36.8 / 44		36.5 / 44		
Technical specifications acc. to IEC/DIN VDE					
• Max. load current in A / cross-section in mm <sup>2</sup>	17.5 / 1.5	--	17.5 / 1.5	--	17.5 / 1.5
• Rated impulse withstand voltage in kV / pollution degree	6 / 3				
• Overvoltage category / molded plastic group	III / I				
Connection capacities					
• Flexible with end sleeve, with plastic sleeve in mm <sup>2</sup>	0.25 ... 1.5				
• Flexible with end sleeve, without plastic sleeve in mm <sup>2</sup>	0.25 ... 1.5				
• Flexible with two-wire connection end sleeve, with plastic sleeve in mm <sup>2</sup>	0.5				
Stripped length in mm	10				
Plug gauge (IEC 60947-1)	A1				
Molded plastic type	PA				
• Flammability Class acc. to UL 94	V0				
Approval data (UL/cUL and CSA)					
• Rated voltage / rated current / conductor sizes					
- UL/cUL: in V/A / AWG	300 / 15 / 26 ... 14	-- / -- / 26 ... 14	300 / 15 / 26 ... 14	-- / -- / 26 ... 14	300 / 15 / 26 ... 14
- CSA: in V/A / AWG	300 / 15 / 26 ... 14	-- / -- / 26 ... 14	300 / 15 / 26 ... 14	--	300 / 15 / 26 ... 14
Support rails/protective conductor busbars	--	See page 1/3, section "Support rails"	--	See page 1/3, section "Support rails"	--

## 8WH2 Spring-Loaded Terminals

### 8WH through-type terminals

	8WH2004-0CE07	8WH2000-0AF0.	8WH2000-0CF07	8WH2003-0AF00 8WH2003-0AF01	8WH2003-0CF07
Dimensions					
• Width/length/cover width in mm	4.2 / 72 / 2.2	5.2 / 48.5 / 2.2		5.2 / 60.5 / 2.2	
• Height (NS 35/7.5 / NS 35/15) in mm	36.5 / 44	36.8 / 44		36.5 / 44	
Technical specifications acc. to IEC/DIN VDE					
• Max. load current in A / cross-section in mm <sup>2</sup>	--	31 / 4	--	28 / 4	--
• Rated impulse withstand voltage in kV / pollution degree	6 / 3	8 / 3			
• Overvoltage category / molded plastic group	III / I				
Connection capacities					
• Flexible with end sleeve, with plastic sleeve in mm <sup>2</sup>	0.25 ... 1.5	0.25 ... 2.5			
• Flexible with end sleeve, without plastic sleeve in mm <sup>2</sup>	0.25 ... 1.5	0.25 ... 2.5			
• Flexible with two-wire connection end sleeve, with plastic sleeve in mm <sup>2</sup>	0.5				
Stripped length in mm	10				
Plug gauge (IEC 60947-1)	A1	A3			
Molded plastic type	PA				
• Flammability Class acc. to UL 94	V0				
Approval data (UL/cUL and CSA)					
• Rated voltage / rated current / conductor sizes					
- UL/cUL: in V/A / AWG	-- / -- / 26 ... 14	300 / 20 / 26 ... 12	-- / -- / 26 ... 12	600 / 20 / 26 ... 12	-- / -- / 26 ... 12
- CSA: in V/A / AWG	-- / -- / 26 ... 14	--			
Support rails/protective conductor busbars	See page 1/3, section "Support rails"	--	See page 1/3, section "Support rails"	--	See page 1/3, section "Support rails"
	8WH2004-0AF00 8WH2004-0AF01	8WH2004-0CF07	8WH2000-0AG0.	8WH2003-0AG00 8WH2003-0AG01	8WH2004-0AG00 8WH2004-0AG01
Dimensions					
• Width/length/cover width in mm	5.2 / 72 / 2.2		6.2 / 56 / 2.2	6.2 / 71.5 / 2.2	6.2 / 87 / 2.2
• Height (NS 35/7.5 / NS 35/15) in mm	36.5 / 44		36.8 / 44	36.5 / 44	
Technical specifications acc. to IEC/DIN VDE					
• Max. load current in A / cross-section in mm <sup>2</sup>	28 / 4	--	40 / 6		
• Rated impulse withstand voltage in kV / pollution degree	8 / 3				
• Overvoltage category / molded plastic group	III / I				
Connection capacities					
• Flexible with end sleeve, with plastic sleeve in mm <sup>2</sup>	0.25 ... 2.5		0.25 ... 4		
• Flexible with end sleeve, without plastic sleeve in mm <sup>2</sup>	0.25 ... 2.5		0.25 ... 4		
• Flexible with two-wire connection end sleeve, with plastic sleeve in mm <sup>2</sup>	0.5		0.5 ... 1		
Stripped length in mm	10				
Plug gauge (IEC 60947-1)	A3		A4		
Molded plastic type	PA				
• Flammability Class acc. to UL 94	V0				
Approval data (UL/cUL and CSA)					
• Rated voltage / rated current / conductor sizes					
- UL/cUL: in V/A / AWG	600 / 20 / 26 ... 12	-- / -- / 26 ... 12	600 / 30 / 20 ... 10		
- CSA: in V/A / AWG	--				
Support rails/protective conductor busbars	--	See page 1/3, section "Support rails"	--	--	--

	8WH2000-0CG07	8WH2003-0CG07	8WH2004-0CG07	8WH2000-0AH00 8WH2000-0AH01	8WH2003-0AH00 8WH2003-0AH01
Dimensions					
• Width/length/cover width in mm	6.2 / 56 / 2.2	6.2 / 71.5 / 2.2	6.2 / 87 / 2.2	8.2 / 69.5 / 2.2	8.2 / 90.5 / 2.2
• Height (NS 35/7.5 / NS 35/15) in mm	36.8 / 44	36.5 / 44		43.5 / 51	
Technical specifications acc. to IEC/DIN VDE					
• Max. load current in A / cross-section in mm <sup>2</sup>	--			52 / 10	
• Rated impulse withstand voltage in kV / pollution degree	8 / 3				
• Overvoltage category / molded plastic group	III / I				
Connection capacities					
• Flexible with end sleeve, with plastic sleeve in mm <sup>2</sup>	0.25 ... 4			0.25 ... 6	
• Flexible with end sleeve, without plastic sleeve in mm <sup>2</sup>	0.25 ... 4			0.25 ... 6	
• Flexible with two-wire connection end sleeve, with plastic sleeve in mm <sup>2</sup>	0.5 ... 1			0.5 ... 1.5	
Stripped length in mm	10			12	
Plug gauge (IEC 60947-1)	A4			A5	
Molded plastic type	PA				
• Flammability Class acc. to UL 94	V0				
Approval data (UL/cUL and CSA)					
• Rated voltage / rated current / conductor sizes	-- / -- / 20 ... 10			600 / 50 / 20 ... 8	
- UL/cUL: in V/A / AWG	--				
- CSA: in V/A / AWG					
Support rails/protective conductor busbars	See page 1/3, section "Support rails"	See page 1/3, section "Support rails"	See page 1/3, section "Support rails"	--	--
	8WH2000-0CH07	8WH2003-0CH07	8WH2000-0AJ00 8WH2000-0AJ01	8WH2000-0CJ07	
Dimensions					
• Width/length/cover width in mm	8.2 / 69.5 / 2.2	8.2 / 90.5 / 2.2	10 / 71.5 / 2.2		
• Height (NS 35/7.5 / NS 35/15) in mm	43.5 / 51		50.5 / 58		
Technical specifications acc. to IEC/DIN VDE					
• Max. load current in A / cross-section in mm <sup>2</sup>	--		65 / 16		
• Rated impulse withstand voltage in kV / pollution degree	8 / 3				
• Overvoltage category / molded plastic group	III / I				
Connection capacities					
• Flexible with end sleeve, with plastic sleeve in mm <sup>2</sup>	0.25 ... 6		0.25 ... 10		
• Flexible with end sleeve, without plastic sleeve in mm <sup>2</sup>	0.25 ... 6		0.25 ... 10		
• Flexible with two-wire connection end sleeve, with plastic sleeve in mm <sup>2</sup>	0.5 ... 1.5		1.5 ... 2.5		
Stripped length in mm	12		18		
Plug gauge (IEC 60947-1)	A5		A6		
Molded plastic type	PA				
• Flammability Class acc. to UL 94	V0				
Approval data (UL/cUL and CSA)					
• Rated voltage / rated current / conductor sizes	-- / -- / 20 ... 8		600 / 65 / 16 ... 6	-- / -- / 16 ... 6	
- UL/cUL: in V/A / AWG	--				
- CSA: in V/A / AWG					
Support rails/protective conductor busbars	See page 1/3, section "Support rails"	See page 1/3, section "Support rails"	--	See page 1/3, section "Support rails"	
	8WH2000-0AK00 8WH2000-0AK01	8WH2000-0CK07	8WH2000-0AM00 8WH2000-0AM01	8WH2000-0CM07	
Dimensions					
• Width/length/cover width in mm	12 / 80 / 2.2		16 / 100 / --		
• Height (NS 35/7.5 / NS 35/15) in mm	51 / 58.5		59 / 66.5		
Technical specifications acc. to IEC/DIN VDE					
• Max. load current in A / cross-section in mm <sup>2</sup>	90 / 25		125 / 35		
• Rated impulse withstand voltage in kV / pollution degree	8 / 3				
• Overvoltage category / molded plastic group	III / I				
Connection capacities					
• Flexible with end sleeve, with plastic sleeve in mm <sup>2</sup>	0.25 ... 16		2.5 ... 35		
• Flexible with end sleeve, without plastic sleeve in mm <sup>2</sup>	0.25 ... 16		2.5 ... 35		
• Flexible with two-wire connection end sleeve, with plastic sleeve in mm <sup>2</sup>	1.5 ... 4		2.5 ... 10		
Stripped length in mm	18		25		
Plug gauge (IEC 60947-1)	A7		A8		
Molded plastic type	PA				
• Flammability Class acc. to UL 94	V0				
Approval data (UL/cUL and CSA)					
• Rated voltage / rated current / conductor sizes	600 / 85 / 16 ... 4	-- / -- / 16 ... 4	600 / 115 / 14 ... 2	-- / -- / 14 ... 2	
- UL/cUL: in V/A / AWG	--		600 / 115 / 14 ... 2	-- / -- / 14 ... 2	
- CSA: in V/A / AWG					
Support rails/protective conductor busbars	--	See page 1/3, section "Support rails"	--	See page 1/3, section "Support rails"	

# 8WH2 Spring-Loaded Terminals

## 8WH through-type terminals

### Selection and ordering data

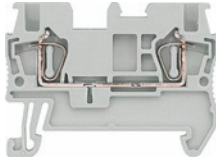
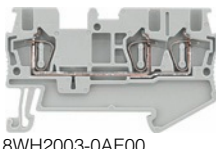
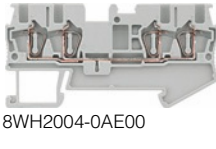
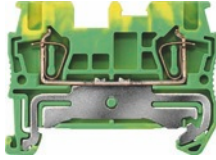
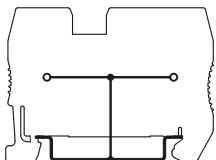
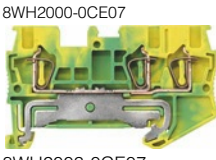
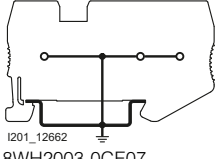
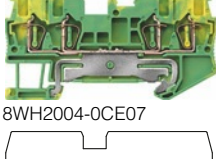
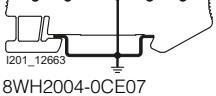
Version	DT	Article No. <a href="http://www.siemens.com/product?ArticleNo.">www.siemens.com/ product?Article No.</a>	Price per PU	PU (UNIT, SET, M)	PS*/ P. unit	PG
<b>Terminal size 1.5 mm<sup>2</sup></b>						
 <p>8WH2000-0AE00</p>		<b>Through-type terminals, terminal size 1.5 mm<sup>2</sup></b> <ul style="list-style-type: none"> <li>Terminal width 4.2 mm, C<sup>UL</sup><sub>US</sub></li> <li>IEC 60947-7-1                             <ul style="list-style-type: none"> <li>Rigid 0.08 ... 1.5 mm<sup>2</sup></li> <li>Flexible 0.08 ... 1.5 mm<sup>2</sup></li> <li>AWG 28-16</li> <li>I = 17.5 A</li> </ul> </li> <li>The total current through all connected conductors must not exceed the max. load current</li> <li>U = 500 V</li> </ul>				
 <p>8WH2003-0AE00</p>		<b>Versions</b> <ul style="list-style-type: none"> <li>Two clamping points                             <ul style="list-style-type: none"> <li>Gray</li> <li>Blue</li> <li>Orange</li> <li>Red</li> </ul> </li> <li>Black</li> <li>Green</li> <li>White</li> <li>Yellow</li> </ul>				
 <p>8WH2004-0AE00</p>		<ul style="list-style-type: none"> <li>Three clamping points                             <ul style="list-style-type: none"> <li>Gray, Ⓢ</li> <li>Blue</li> <li>Orange</li> </ul> </li> <li>Four clamping points                             <ul style="list-style-type: none"> <li>Gray, Ⓢ</li> <li>Blue</li> <li>Orange</li> </ul> </li> </ul>				
		<b>8WH2000-0AE00</b>		1	50 units	1BT
		<b>8WH2000-0AE01</b>		1	50 units	1BT
		<b>8WH2000-0AE04</b>		1	50 units	1BT
		<b>8WH2000-0AE02</b>		1	50 units	1BT
		<b>8WH2000-0AE08</b>		1	50 units	1BT
		<b>8WH2000-0AE03</b>		1	50 units	1BT
		<b>8WH2000-0AE05</b>		1	50 units	1BT
		<b>8WH2000-0AE06</b>		1	50 units	1BT
		<b>8WH2003-0AE00</b>		1	50 units	1BT
		<b>8WH2003-0AE01</b>		1	50 units	1BT
		<b>8WH2003-0AF04</b>		1	50 units	1BT
		<b>8WH2004-0AE00</b>		1	50 units	1BT
		<b>8WH2004-0AE01</b>		1	50 units	1BT
		<b>8WH2004-0AF04</b>		1	50 units	1BT
<b>PE through-type terminals, terminal size 1.5 mm<sup>2</sup></b>						
 <p>8WH2000-0CE07</p>		<ul style="list-style-type: none"> <li>Terminal width 4.2 mm, C<sup>UL</sup><sub>US</sub></li> <li>IEC 60947-7-1                             <ul style="list-style-type: none"> <li>Rigid 0.08 ... 1.5 mm<sup>2</sup></li> <li>Flexible 0.08 ... 1.5 mm<sup>2</sup></li> <li>AWG 28-16</li> </ul> </li> <li>Green/yellow</li> </ul>				
 <p>8WH2003-0CE07</p>		<b>Versions</b> <ul style="list-style-type: none"> <li>Two clamping points, Ⓢ</li> <li>Three clamping points</li> <li>Four clamping points, Ⓢ</li> </ul>				
 <p>8WH2004-0CE07</p>						
 <p>8WH2000-0CE07</p>						
 <p>8WH2003-0CE07</p>						
 <p>8WH2004-0CE07</p>						
		<b>8WH2000-0CE07</b>		1	50 units	1BT
		<b>8WH2003-0CE07</b>		1	50 units	1BT
		<b>8WH2004-0CE07</b>		1	50 units	1BT

## 8WH through-type terminals

Version	DT	Article No. <a href="http://www.siemens.com/product?Article.No.">www.siemens.com/ product?Article.No.</a>	Price per PU	PU (UNIT, SET, M)	PS*/ P. unit	PG
---------	----	--	-----------------	-------------------------	-----------------	----

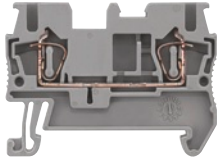
Terminal size 2.5 mm<sup>2</sup>

8WH2000-0AF00

**Through-type terminals, terminal size 2.5 mm<sup>2</sup>, two clamping points**

- Terminal width 5.2 mm, C<sup>RU</sup>US
- IEC 60947-7-1
  - Rigid 0.08 ... 4 mm<sup>2</sup>
  - Flexible 0.08 ... 2.5 mm<sup>2</sup>
  - AWG 28-12
  - I = 31 A
  - U = 800 V

## Versions

- Gray
- Blue
- Orange
- Red
- Black
- Green
- White
- Yellow

8WH2000-0AF00	1	50 units	1BT
8WH2000-0AF01	1	50 units	1BT
8WH2000-0AF04	1	50 units	1BT
8WH2000-0AF02	1	50 units	1BT
8WH2000-0AF08	1	50 units	1BT
8WH2000-0AF03	1	50 units	1BT
8WH2000-0AF05	1	50 units	1BT
8WH2000-0AF06	1	50 units	1BT

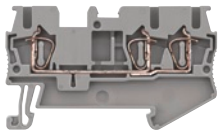

8WH2003-0AF00

**Through-type terminals, terminal size 2.5 mm<sup>2</sup>, three clamping points**

- Terminal width 5.2 mm, C<sup>RU</sup>US
- IEC 60947-7-1
  - Rigid 0.08 ... 4 mm<sup>2</sup>
  - Flexible 0.08 ... 2.5 mm<sup>2</sup>
  - AWG 28-12
  - I = 28 A
  - The total current through all connected conductors must not exceed the max. load current
  - U = 800 V

## Versions

- Gray
- Blue
- Orange

8WH2003-0AF00	1	50 units	1BT
8WH2003-0AF01	1	50 units	1BT
8WH2003-0AF04	1	50 units	1BT

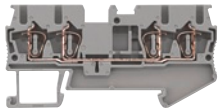

8WH2004-0AF00

**Through-type terminals, terminal size 2.5 mm<sup>2</sup>, four clamping points**

- Terminal width 5.2 mm, C<sup>RU</sup>US
- IEC 60947-7-1
  - Rigid 0.08 ... 4 mm<sup>2</sup>
  - Flexible 0.08 ... 2.5 mm<sup>2</sup>
  - AWG 28-12
  - I = 28 A
  - The total current through all connected conductors must not exceed the max. load current
  - U = 800 V

## Versions



- Gray
- Blue
- Orange

8WH2004-0AF00	1	50 units	1BT
8WH2004-0AF01	1	50 units	1BT
8WH2004-0AF04	1	50 units	1BT

# 8WH2 Spring-Loaded Terminals

## 8WH through-type terminals

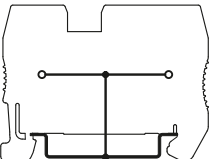
4

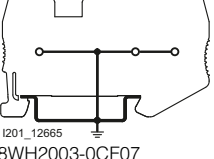
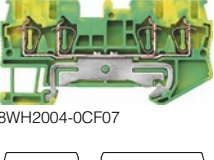
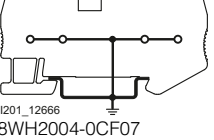
Version	DT	Article No. <a href="http://www.siemens.com/product?Article.No.">www.siemens.com/ product?Article.No.</a>	Price per PU	PU (UNIT, SET, M)	PS*/ P. unit	PG
 <p><b>PE through-type terminals, terminal size 2.5 mm<sup>2</sup></b></p> <ul style="list-style-type: none"> <li>Terminal width 5.2 mm</li> <li>CEC US</li> <li>IEC 60947-7-2                     <ul style="list-style-type: none"> <li>Rigid 0.08 ... 4 mm<sup>2</sup></li> <li>Flexible 0.08 ... 2.5 mm<sup>2</sup></li> <li>AWG 28-12</li> </ul> </li> <li>Green/yellow</li> </ul>						
<p>8WH2000-OCF07</p>  <p>I201_12664 8WH2000-OCF07</p>						
<p><b>Versions</b></p> <ul style="list-style-type: none"> <li>Two clamping points</li> <li>Three clamping points</li> <li>Four clamping points</li> </ul>		<p><b>8WH2000-OCF07</b> <b>8WH2003-OCF07</b> <b>8WH2004-OCF07</b></p>		<p>1 50 units 1BT 1 50 units 1BT 1 50 units 1BT</p>		
 <p>8WH2003-OCF07</p>  <p>I201_12665 8WH2003-OCF07</p>						
 <p>8WH2004-OCF07</p>  <p>I201_12666 8WH2004-OCF07</p>						

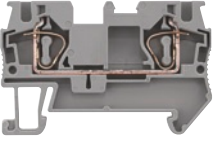
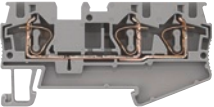
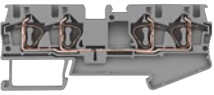

Version	DT	Article No. <a href="http://www.siemens.com/product?Article.No.">www.siemens.com/ product?Article.No.</a>	Price per PU	PU (UNIT, SET, M)	PS*/ P. unit	PG
<b>Terminal size 4 mm<sup>2</sup></b>						
 8WH2000-0AG00	<b>Through-type terminals, terminal size 4 mm<sup>2</sup>, two clamping points</b> <ul style="list-style-type: none"> <li>Terminal width 6.2 mm</li> <li>• <math>25\text{ A}</math> US</li> <li>• IEC 60947-7-1               <ul style="list-style-type: none"> <li>- Rigid 0.08 ... 6 mm<sup>2</sup>, flexible 0.08 ... 4 mm<sup>2</sup>, AWG 28-10</li> <li>- <math>I = 40\text{ A}</math>, <math>U = 800\text{ V}</math></li> </ul> </li> </ul>					
	<b>Versions</b> <ul style="list-style-type: none"> <li>• Gray</li> <li>• Blue</li> <li>• Orange</li> <li>• Red</li> <li>• Black</li> <li>• Green</li> <li>• White</li> <li>• Yellow</li> </ul>		<b>8WH2000-0AG00</b> <b>8WH2000-0AG01</b> <b>8WH2000-0AG04</b> <b>8WH2000-0AG02</b>  <b>8WH2000-0AG08</b> <b>8WH2000-0AG03</b> <b>8WH2000-0AG05</b> <b>8WH2000-0AG06</b>	1 50 units 1 50 units 1 50 units 1 50 units  1 50 units 1 50 units 1 50 units 1 50 units	1BT 1BT 1BT 1BT  1BT 1BT 1BT 1BT	
 8WH2003-0AG00	<b>Through-type terminals, terminal size 4 mm<sup>2</sup>, three clamping points</b> <ul style="list-style-type: none"> <li>Terminal width 6.2 mm</li> <li>• <math>25\text{ A}</math> US</li> <li>• IEC 60947-7-1               <ul style="list-style-type: none"> <li>- Rigid 0.08 ... 6 mm<sup>2</sup>, flexible 0.08 ... 4 mm<sup>2</sup>, AWG 28-10</li> <li>- <math>I = 40\text{ A}</math>, the total current through all connected conductors must not exceed the max. load current</li> <li>- <math>U = 800\text{ V}</math></li> </ul> </li> </ul>					
	<b>Versions</b> <ul style="list-style-type: none"> <li>• Gray</li> <li>• Blue</li> </ul>		<b>8WH2003-0AG00</b> <b>8WH2003-0AG01</b>	1 50 units 1 50 units	1BT 1BT	
 8WH2004-0AG00	<b>Through-type terminals, terminal size 4 mm<sup>2</sup>, four clamping points</b> <ul style="list-style-type: none"> <li>Terminal width 6.2 mm</li> <li>• <math>25\text{ A}</math> US</li> <li>• IEC 60947-7-1               <ul style="list-style-type: none"> <li>- Rigid 0.08 ... 6 mm<sup>2</sup>, flexible 0.08 ... 4 mm<sup>2</sup>, AWG 28-10</li> <li>- <math>I = 40\text{ A}</math>, the total current through all connected conductors must not exceed the max. load current</li> <li>- <math>U = 800\text{ V}</math></li> </ul> </li> </ul>					
	<b>Versions</b> <ul style="list-style-type: none"> <li>• Gray</li> <li>• Blue</li> </ul>		<b>8WH2004-0AG00</b> <b>8WH2004-0AG01</b>	1 50 units 1 50 units	1BT 1BT	

# 8WH2 Spring-Loaded Terminals

## 8WH through-type terminals

4

Version	DT	Article No. <a href="http://www.siemens.com/product?ArticleNo.">www.siemens.com/ product?Article No.</a>	Price per PU	PU (UNIT, SET, M)	PS*/ P. unit	PG
---------	----	---	-----------------	-------------------------	-----------------	----



8WH2000-0CG07

**PE through-type terminals, terminal size 4 mm²**

- Terminal width 6.2 mm
- **UL**
- IEC 60947-7-2
  - Rigid 0.08 ... 6 mm²
  - Flexible 0.08 ... 4 mm²
  - AWG 28-10
- Green/yellow

**Versions**

- Two clamping points
- Three clamping points
- Four clamping points

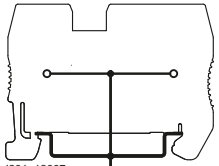

I201\_12667  
8WH2000-0CE07

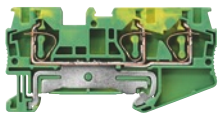

8WH2003-0CG07

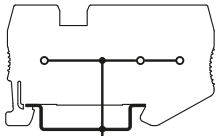

I201\_12668  
8WH2003-0CG07



8WH2004-0CG07

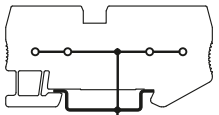

I201\_12669  
8WH2004-0CG07





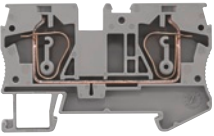
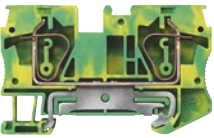
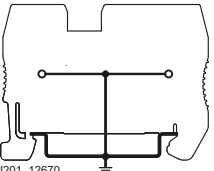
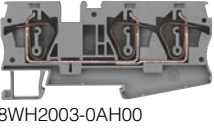
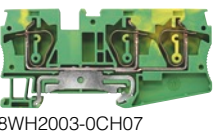
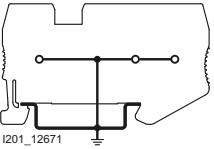
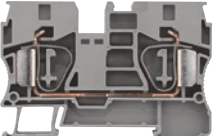

<b>8WH2000-0CG07</b>	1	50 units	1BT
<b>8WH2003-0CG07</b>	1	50 units	1BT
<b>8WH2004-0CG07</b>	1	50 units	1BT

## 8WH through-type terminals



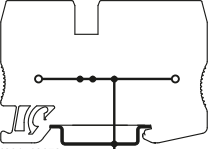

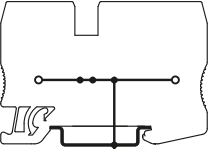

Version	DT	Article No. <a href="http://www.siemens.com/product?Article.No.">www.siemens.com/ product?Article.No.</a>	Price per PU	PU (UNIT, SET, M)	PS*/ P. unit	PG
<b>Terminal size 6 mm<sup>2</sup></b>						
 <p>8WH2000-0AH00</p>		<b>Through-type terminals, terminal size 6 mm<sup>2</sup>, two clamping points</b> <ul style="list-style-type: none"> <li>Terminal width 8.2 mm</li> <li>cULus</li> <li>IEC 60947-7-1           <ul style="list-style-type: none"> <li>Rigid 0.2 ... 10 mm<sup>2</sup></li> <li>Flexible 0.2 ... 6 mm<sup>2</sup></li> <li>AWG 24 ... 8</li> <li>I = 52 A</li> <li>U = 1000 V</li> </ul> </li> </ul>				
<b>Versions</b> <ul style="list-style-type: none"> <li>Gray</li> <li>Blue</li> </ul>		<b>8WH2000-0AH00</b> <b>8WH2000-0AH01</b>		1 1	50 units 50 units	1BT 1BT
 <p>8WH2000-0CH07</p>		<b>PE through-type terminals, terminal size 6 mm<sup>2</sup>, two clamping points</b> <ul style="list-style-type: none"> <li>Terminal width 8.2 mm</li> <li>cULus</li> <li>IEC 60947-7-2           <ul style="list-style-type: none"> <li>Rigid 0.2 ... 10 mm<sup>2</sup></li> <li>Flexible 0.2 ... 6 mm<sup>2</sup></li> <li>AWG 24 ... 8</li> </ul> </li> <li>Green/yellow</li> </ul>				
 <p>1201_12670 8WH2000-0CE07</p>						
 <p>8WH2003-0AH00</p>		<b>Through-type terminals, terminal size 6 mm<sup>2</sup>, three clamping points</b> <ul style="list-style-type: none"> <li>Terminal width 8.2 mm</li> <li>cULus</li> <li>IEC 60947-7-1           <ul style="list-style-type: none"> <li>Rigid 0.2 ... 10 mm<sup>2</sup></li> <li>Flexible 0.2 ... 6 mm<sup>2</sup></li> <li>AWG 24 ... 8</li> <li>I = 52 A</li> <li>The total current through all connected conductors must not exceed the max. load current</li> <li>U = 1000 V</li> </ul> </li> </ul>				
<b>Versions</b> <ul style="list-style-type: none"> <li>Gray</li> <li>Blue</li> </ul>		<b>8WH2003-0AH00</b> <b>8WH2003-0AH01</b>		1 1	50 units 50 units	1BT 1BT
 <p>8WH2003-0CH07</p>		<b>PE through-type terminals, terminal size 6 mm<sup>2</sup>, three clamping points</b> <ul style="list-style-type: none"> <li>Terminal width 8.2 mm</li> <li>cULus</li> <li>IEC 60947-7-2           <ul style="list-style-type: none"> <li>Rigid 0.2 ... 10 mm<sup>2</sup></li> <li>Flexible 0.2 ... 6 mm<sup>2</sup></li> <li>AWG 24 ... 8</li> </ul> </li> <li>Green/yellow</li> </ul>				
 <p>1201_12671 8WH2003-0CE07</p>						
<b>Terminal size 10 mm<sup>2</sup></b>						
 <p>8WH2000-0AJ00</p>		<b>Through-type terminals, terminal size 10 mm<sup>2</sup></b> <ul style="list-style-type: none"> <li>Terminal width 10.2 mm</li> <li>cULus</li> <li>IEC 60947-7-1           <ul style="list-style-type: none"> <li>Rigid 1.5 ... 16 mm<sup>2</sup></li> <li>Flexible 1.5 ... 10 mm<sup>2</sup></li> <li>AWG 24-6</li> <li>I = 65 A</li> <li>U = 1000 V</li> </ul> </li> </ul>				
<b>Versions</b> <ul style="list-style-type: none"> <li>Gray</li> <li>Blue</li> </ul>		<b>8WH2000-0AJ00</b> <b>8WH2000-0AJ01</b>		1 1	50 units 50 units	1BT 1BT

## 8WH2 Spring-Loaded Terminals

### 8WH through-type terminals

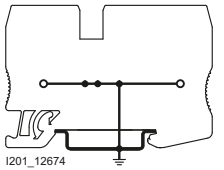
Version	DT	Article No. <a href="http://www.siemens.com/product?Article.No.">www.siemens.com/ product?Article.No.</a>	Price per PU	PU (UNIT, SET, M)	PS*/ P. unit	PG
 <p>8WH2000-0CJ07</p> <p><b>PE through-type terminals, terminal size 10 mm<sup>2</sup></b></p> <ul style="list-style-type: none"> <li>Terminal width 10.2 mm</li> <li>  </li> <li>IEC 60947-7-2           <ul style="list-style-type: none"> <li>Rigid 1.5 ... 16 mm<sup>2</sup></li> <li>Flexible 1.5 ... 10 mm<sup>2</sup></li> <li>AWG 24-6</li> <li>I = 65 A</li> </ul> </li> <li>Green/yellow</li> </ul>  <p>I201_12672 8WH2000-0CJ07</p>		<b>8WH2000-0CJ07</b>		1	50 units	1BT
<b>Terminal size 16 mm<sup>2</sup></b>						
 <p>8WH2000-0AK00</p> <p><b>Through-type terminals, terminal size 16 mm<sup>2</sup></b></p> <ul style="list-style-type: none"> <li>Terminal width 12 mm</li> <li>  </li> <li>IEC 60947-7-1           <ul style="list-style-type: none"> <li>Rigid 1.5 ... 25 mm<sup>2</sup></li> <li>Flexible 1.5 ... 16 mm<sup>2</sup></li> <li>AWG 24-4</li> <li>I = 90 A</li> <li>U = 1000 V</li> </ul> </li> </ul>						
<p>Versions</p> <ul style="list-style-type: none"> <li>Gray</li> <li>Blue</li> </ul>		<b>8WH2000-0AK00</b> <b>8WH2000-0AK01</b>		1	50 units	1BT
 <p>8WH2000-0CK07</p> <p><b>PE through-type terminals, terminal size 16 mm<sup>2</sup></b></p> <ul style="list-style-type: none"> <li>Terminal width 12 mm</li> <li>  </li> <li>IEC 60947-7-2           <ul style="list-style-type: none"> <li>Rigid 1.5 ... 25 mm<sup>2</sup></li> <li>Flexible 1.5 ... 16 mm<sup>2</sup></li> <li>AWG 24-4</li> <li>I = 90 A</li> </ul> </li> <li>Green/yellow</li> </ul>  <p>I201_12673 8WH2000-0CK07</p>		<b>8WH2000-0CK07</b>		1	25 units	1BT

## 8WH through-type terminals

Version	DT	Article No. <a href="http://www.siemens.com/product?Article.No.">www.siemens.com/ product?Article.No.</a>	Price per PU	PU (UNIT, SET, M)	PS*/ P. unit	PG
<b>Terminal size 35 mm<sup>2</sup></b>						
 8WH2000-0AM00		<b>Through-type terminals, terminal size 35 mm<sup>2</sup></b> <ul style="list-style-type: none"> <li>Terminal width 16 mm</li> <li>UL, US</li> <li>IEC 60947-7-1               <ul style="list-style-type: none"> <li>Rigid 2.5 ... 35 mm<sup>2</sup></li> <li>Flexible 2.5 ... 35 mm<sup>2</sup></li> <li>AWG 14 ... 2</li> <li>I = 125 A</li> <li>U = 1000 V</li> </ul> </li> <li>Enclosed at both ends</li> </ul>				
<b>Versions</b>						
<ul style="list-style-type: none"> <li>Gray, ☉</li> <li>Blue</li> </ul>		8WH2000-0AM00 8WH2000-0AM01		1	10 units	1BT 1BT
 8WH2000-0CM07		<b>PE through-type terminals, terminal size 35 mm<sup>2</sup></b> <ul style="list-style-type: none"> <li>Terminal width 16 mm</li> <li>UL, US, ☉</li> <li>IEC 60947-7-2               <ul style="list-style-type: none"> <li>Rigid 2.5 ... 35 mm<sup>2</sup></li> <li>Flexible 2.5 ... 35 mm<sup>2</sup></li> <li>AWG 14 ... 2</li> <li>I = 125 A</li> </ul> </li> <li>Enclosed at both ends</li> <li>Green/yellow</li> </ul>				
<b>Versions</b>						
 I201_12674 8WH2000-0CM07		8WH2000-0CM07		1	10 units	1BT
<b>Accessories</b>						
 8WH9070-0AA00		<b>Compartment partitions</b> <ul style="list-style-type: none"> <li>For visual and electrical separation of terminal groups</li> <li>2 mm thick</li> </ul>				
<b>Versions</b>						
		<ul style="list-style-type: none"> <li>For terminal size 1.5 up to 4 mm<sup>2</sup> and two clamping points</li> <li>For terminal size 1.5 up to 4 mm<sup>2</sup> and three clamping points</li> <li>For terminal size 1.5 up to 4 mm<sup>2</sup> and four clamping points</li> <li>For terminal size 6 mm<sup>2</sup></li> </ul>				
		8WH9070-0AA00		100	50 units	1BT 1BT 1BT 1BT
 8WH9000-1GA00		<b>Covers</b> Gray				
<b>Versions</b>						
		<ul style="list-style-type: none"> <li>For terminal size 1.5 up to 2.5 mm<sup>2</sup> and two clamping points</li> <li>For terminal size 1.5 up to 2.5 mm<sup>2</sup> and three clamping points</li> <li>For terminal size 1.5 up to 2.5 mm<sup>2</sup> and four clamping points</li> <li>For terminal size 4 mm<sup>2</sup> and two clamping points</li> <li>For terminal size 4 mm<sup>2</sup> and three clamping points</li> <li>For terminal size 4 mm<sup>2</sup> and four clamping points</li> <li>For terminal size 6 mm<sup>2</sup> and two clamping points</li> <li>For terminal size 6 mm<sup>2</sup> and three clamping points</li> <li>For terminal size 10 mm<sup>2</sup></li> <li>For terminal size 16 mm<sup>2</sup></li> </ul>				
		8WH9000-1GA00		100	50 units	1BT 1BT 1BT 1BT 1BT 1BT 1BT 1BT 1BT 1BT
 8WH9000-0GA00		<b>Cover segments</b> <ul style="list-style-type: none"> <li>Gray</li> <li>For covering multi-wire terminals when mounting two-wire terminals side-by-side</li> </ul>				
<b>Versions</b>						
		<ul style="list-style-type: none"> <li>For terminal size 1.5 up to 2.5 mm<sup>2</sup></li> <li>For terminal size 4 mm<sup>2</sup></li> </ul>				
		8WH9000-0GA00		100	10 units	1BT 1BT
 8WH9061-5AA06		<b>Warning covers</b> Note: For the operating shafts of 8WH2 through-type terminals				
<b>Versions</b>						
		<ul style="list-style-type: none"> <li>For terminal size 1.5 mm<sup>2</sup></li> <li>For terminal size 2.5 mm<sup>2</sup></li> <li>For terminal size 4 mm<sup>2</sup></li> <li>For terminal size 6 mm<sup>2</sup></li> <li>For terminal size 10 mm<sup>2</sup></li> <li>For terminal size 16 mm<sup>2</sup></li> <li>For terminal size 35 mm<sup>2</sup></li> </ul>				
		8WH9061-5AA06		100	50 units	1BT 1BT 1BT 1BT 1BT 1BT 1BT

For general accessories for 8WH terminal blocks, see chapter "Accessories for 8WH Terminal Blocks"

## 8WH2 Spring-Loaded Terminals

### 8WH hybrid through-type terminals

#### Overview

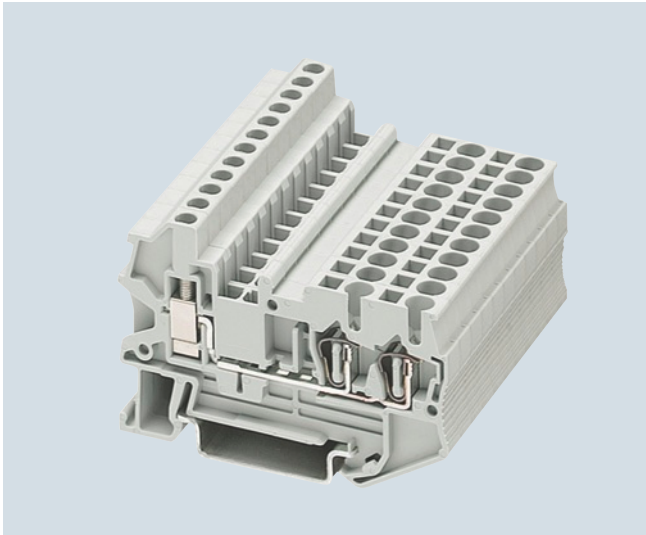

The terminal connection compartment, on the spring-loaded side as well as on the screw side, enables connection to a nominal cross-section of 2.5 mm<sup>2</sup> or 4 mm<sup>2</sup>, with or without end sleeves. The advantages of the different connection types are due to the fact that the spring-loaded terminal of the hybrid through-type terminal is used inside the control cabinet and the universal screw terminal is used at the end-user's side. A PE terminal with the same contour is available for the three-wire terminal. Contact is made by simply snapping the terminal onto the support rail.

This meets the following requirements of IEC 60947-7-2:

- Low contact resistance
- Stainless clamping points
- Green-yellow enclosure
- Additional inscription options

A label can be snapped on to the middle of each terminal at the front. Further labels can also be mounted flat on the side of the terminals.

#### Technical specifications



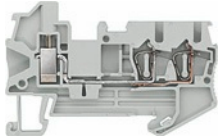
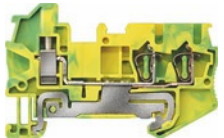
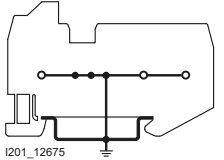

	8WH2103-2BF00 8WH2103-2BF01	8WH2103-3BF07	8WH2103-2BG00 8WH2103-2BG01	8WH2103-3BG07
Dimensions				
• Width/length/cover width in mm	5.2 / 65.3 / 2.2		6.2 / 74.4 / 2.2	
• Height (NS 35/7.5 / NS 35/15) in mm	42.8 / 50.3			
Technical specifications acc. to IEC/DIN VDE				
• Max. load current in A / cross-section in mm <sup>2</sup>	28 / 4	--	32 / 6	--
• Rated impulse withstand voltage in kV / pollution degree	8 / 3			
• Overvoltage category / molded plastic group	III / I			
Connection capacities				
• Flexible with end sleeve, with plastic sleeve in mm <sup>2</sup>	0.25 ... 2.5		0.25 ... 4	
• Flexible with end sleeve, without plastic sleeve in mm <sup>2</sup>	0.25 ... 2.5		0.25 ... 4	
• Flexible with two-wire connection end sleeve, with plastic sleeve in mm <sup>2</sup>	0.5 ... 1			
Stripped length in mm	10			
Plug gauge (IEC 60947-1)	A3		A4	
Connection capacity of screw terminal				
• Flexible with end sleeves with/without plastic sleeve in mm <sup>2</sup>	0.25 ... 2.5 / 0.25 ... 2.5		0.25 ... 4 / 0.25 ... 4	
Multi-conductor connection (two conductors of same cross-section)				
• Rigid / flexible in mm <sup>2</sup>	0.14 ... 1.5 / 0.14 ... 1.5			
• Flexible with end sleeve, without plastic sleeve in mm <sup>2</sup>	0.25 ... 1.5			
• Flexible with two-wire connection end sleeve, with plastic sleeve in mm <sup>2</sup>	0.5 ... 1.5		0.5 ... 2.5	
Stripped length in mm	9			
Plug gauge (IEC 60947-1)	A3		A4	
Tightening torque in Nm	0.6 ... 0.8		0.6 ... 0.8	
Molded plastic type	PA			
• Flammability Class acc. to UL 94	V0			
Approval data (UL/cUL and CSA)				
• Rated voltage / rated current / conductor sizes				
- UL/cUL: in V/A / AWG	Applied for			
- CSA: in V/A / AWG	Applied for			
Support rails/protective conductor busbars	--	See page 1/3, section "Support rails"	--	See page 1/3, section "Support rails"

## Selection and ordering data

Version	DT	Article No. <a href="http://www.siemens.com/product?ArticleNo.">www.siemens.com/ product?Article No.</a>	Price per PU	PU (UNIT, SET, M)	PS*/ P. unit	PG
<b>Terminal size 2.5 mm<sup>2</sup></b>						
 <p>8WH2103-2BF00</p>	<b>Hybrid through-type terminals, terminal size 2.5 mm<sup>2</sup></b> <ul style="list-style-type: none"> <li>Terminal width 5.2 mm</li> <li>IEC 60947-7-1</li> <li>Spring               <ul style="list-style-type: none"> <li>Rigid 0.08 ... 4 mm<sup>2</sup></li> <li>Flexible 0.08 ... 2.5 mm<sup>2</sup></li> <li>AWG 28-12</li> <li>I = 28 A</li> <li>The total current through all connected conductors must not exceed the max. load current</li> <li>U = 800 V</li> </ul> </li> <li>Screw               <ul style="list-style-type: none"> <li>Rigid 0.14 ... 4 mm<sup>2</sup></li> <li>Flexible 0.14 ... 2.5 mm<sup>2</sup></li> <li>AWG 26 ... 14</li> <li>I = 28 A</li> <li>U = 800 V</li> </ul> </li> </ul>					
	<b>Versions</b> <ul style="list-style-type: none"> <li>Gray</li> <li>Blue</li> </ul>					
 <p>8WH2103-3BF07</p>	<b>PE hybrid through-type terminals, terminal size 2.5 mm<sup>2</sup></b> <ul style="list-style-type: none"> <li>Terminal width 5.2 mm</li> <li>IEC 60947-7-2</li> <li>Spring               <ul style="list-style-type: none"> <li>Rigid 0.08 ... 4 mm<sup>2</sup></li> <li>Flexible 0.08 ... 2.5 mm<sup>2</sup></li> <li>AWG 28-12</li> </ul> </li> <li>Screw               <ul style="list-style-type: none"> <li>Rigid 0.14 ... 4 mm<sup>2</sup></li> <li>Flexible 0.14 ... 2.5 mm<sup>2</sup></li> <li>AWG 26 ... 14</li> </ul> </li> </ul>					
	 <p>I201_12675 8WH2103-3BF07</p>					
		8WH2103-2BF00		1	50 units	1BT
		8WH2103-2BF01		1	50 units	1BT
		8WH2103-3BF07		1	50 units	1BT

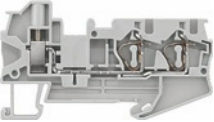
## 8WH2 Spring-Loaded Terminals

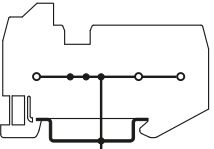
### 8WH hybrid through-type terminals

Version	DT	Article No. <a href="http://www.siemens.com/product?Article.No.">www.siemens.com/ product?Article No.</a>	Price per PU	PU (UNIT, SET, M)	PS*/ P. unit	PG
<b>Terminal size 4 mm<sup>2</sup></b>						
 <p>8WH2103-2BG00</p>		<p><b>Hybrid through-type terminals, terminal size 4 mm<sup>2</sup></b></p> <ul style="list-style-type: none"> <li>Terminal width 6.2 mm</li> <li>IEC 60947-7-1</li> <li>Spring           <ul style="list-style-type: none"> <li>Rigid 0.08 ... 6 mm<sup>2</sup></li> <li>Flexible 0.08 ... 4 mm<sup>2</sup></li> <li>AWG 28-10</li> <li>I = 32 A</li> <li>The total current through all connected conductors must not exceed the max. load current</li> <li>U = 800 V</li> </ul> </li> <li>Screw           <ul style="list-style-type: none"> <li>Rigid 0.14 ... 6 mm<sup>2</sup></li> <li>Flexible 0.14 ... 4 mm<sup>2</sup></li> <li>AWG 26 ... 10</li> <li>I = 32 A</li> <li>U = 800 V</li> </ul> </li> </ul>				
<b>Versions</b>						
<ul style="list-style-type: none"> <li>Gray</li> <li>Blue</li> </ul>		<p><b>8WH2103-2BG00</b></p> <p><b>8WH2103-2BG01</b></p>		<p>1 50 units</p> <p>1 50 units</p>	<p>1BT</p> <p>1BT</p>	
 <p>8WH2103-3BG07</p>		<p><b>PE hybrid through-type terminals, terminal size 4 mm<sup>2</sup></b></p> <ul style="list-style-type: none"> <li>Terminal width 6.2 mm</li> <li>IEC 60947-7-2</li> <li>Spring           <ul style="list-style-type: none"> <li>Rigid 0.08 ... 6 mm<sup>2</sup></li> <li>Flexible 0.08 ... 4 mm<sup>2</sup></li> <li>AWG 28-10</li> </ul> </li> <li>Screw           <ul style="list-style-type: none"> <li>Rigid 0.14 ... 6 mm<sup>2</sup></li> <li>Flexible 0.14 ... 4 mm<sup>2</sup></li> <li>AWG 26 ... 10</li> </ul> </li> </ul>				<p>1 50 units</p> <p>1BT</p>
 <p>I201_12676 8WH2103-3BG07</p>						
<b>Accessories</b>						
 <p>8WH9000-2HA00</p>		<p><b>Covers</b></p> <p>Gray</p>				
<b>Versions</b>						
		<ul style="list-style-type: none"> <li>For terminal size 2.5 mm<sup>2</sup> and three clamping points</li> <li>For terminal size 4 mm<sup>2</sup> and three clamping points</li> </ul>		<p><b>8WH9000-2HA00</b></p> <p><b>8WH9003-2HA00</b></p>	<p>100 50 units</p> <p>100 50 units</p>	<p>1BT</p> <p>1BT</p>

For general accessories for 8WH terminal blocks, [see chapter "Accessories for 8WH Terminal Blocks"](#)

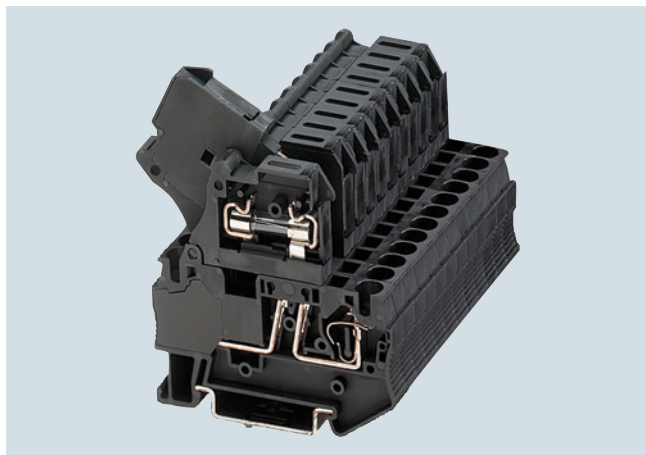

## Overview

**Fuse terminals for blade-type fuses**

The fuse terminals for blade-type fuses accommodate blade-type fuses according to ISO/DIS 8820 / DIN 72581-3. Terminals with LED display are available for fast fault diagnosis "at a glance".

**Fuse terminals for G fuse links**

Fuse terminals perform two important tasks in connected electrical systems. Firstly, they act as a fuse carrier and, secondly, as a potential distributor.

The full-length bridge shaft enables uninterrupted bridging between the through-type terminals and the fuse terminals.

Fuse terminals for G fuse links are available for standardized electrical fuse formats 5 × 20 mm and 6.3 × 32 mm (inch fuse) – and are optionally available with LED display to signal a blown fuse.

A label can be snapped on to the middle of the terminal at the front. Further labels can also be mounted flat on the side of the terminals.

4

## Technical specifications







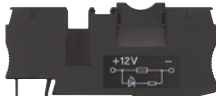
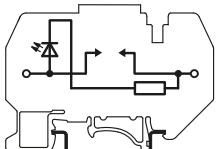

	8WH2000-1AG08 8WH2000-1BG28 8WH2000-1BG38	8WH2000-1GG08 8WH2000-1JG38 8WH2000-1JG68 8WH2000-1MG08	8WH2000-1HG08 8WH2000-1NG38 8WH2000-1NG68 8WH2000-1RG08
Dimensions			
• Width/length in mm	8.2 / 86.5	6.2 / 61.5	8.2 / 76.5
• Height (NS 35/7.5 / NS 35/15) in mm	43.5 / 51	62.5 / 70	69 / 76.5
Technical specifications acc. to IEC/DIN VDE			
• Fuse type ISO/DIS 8820 / DIN 72581-3 / dimensions / in mm	C	G / 5 × 20	G / 6.3 × 32
• Maximum current for single arrangement in A	30	3.3	10
Max. power loss at 23 °C acc. to IEC 60647-7-3 in W <sup>1)</sup>			
• U in V	--	250	400
• Overload protection			
- Individually in W	--	1.6	
- As group in W	--	1.6	
• Only short-circuit protection			
- Individually in W	--	4	
- As group in W	--	2.5	
• I <sub>max</sub> in A	--	6.3	10
• Rated impulse withstand voltage in kV / pollution degree	6 / 3	4 / 3	6 / 3
• Overvoltage category / molded plastic group	III / I		
Connection capacities			
• Flexible with end sleeve without/with plastic sleeve in mm <sup>2</sup>	0.25 ... 4 / 0.25 ... 4		
• Flexible with two-wire connection end sleeve, with plastic sleeve in mm <sup>2</sup>	0.5		
Stripped length in mm	10		
Plug gauge (IEC 60947-1)	A4	A3	A4
Molded plastic type	PA		
• Flammability Class acc. to UL 94	V0		
Approval data (UL/cUL and CSA)			
• Rated voltage / rated current / conductor sizes			
- UL/cUL: in V/A / AWG	600 / 30 / 24 ... 10	300 / 6.3 / 24 ... 10	300 / 10 / 24 ... 10
- CSA: in V/A / AWG	--		

<sup>1)</sup> Please note: The G fuse holders must be selected according to the maximum power loss (heat dissipation) of the G fuse links. Depending on the application and method of installation, the heat rise conditions in closed fuse holders must be tested. Higher ambient temperatures represent an additional load for the fuse links. A shift in rated current should therefore be taken into account in such applications. When selecting G fuse links, make sure that they do not exceed the specified maximum power loss. For specification details, contact the fuse manufacturer.

# 8WH2 Spring-Loaded Terminals

## 8WH fuse terminals

### Selection and ordering data

Version	DT	Article No. <a href="http://www.siemens.com/product?ArticleNo.">www.siemens.com/ product?Article No.</a>	Price per PU	PU (UNIT, SET, M)	PS*/ P. unit	PG
<b>Terminal size 4 mm<sup>2</sup></b>						
 <p>8WH2000-1AG08</p>  <p>8WH2000-1BG28</p>  <p>1201_12681 8WH2000-1BG28</p>		<p><b>Fuse terminals, terminal size 4 mm<sup>2</sup>, for blade-type fuses acc. to ISO/DIS8820/DIN72581-3</b></p> <ul style="list-style-type: none"> <li>Terminal width 8.2 mm</li> <li> US</li> <li>Connection data           <ul style="list-style-type: none"> <li>Rigid 0.08 ... 6 mm<sup>2</sup></li> <li>Flexible 0.08 ... 4 mm<sup>2</sup></li> <li>AWG 28-10</li> <li>I = 30 A</li> <li>U = 400 V</li> </ul> </li> <li>Enclosed at both ends</li> </ul> <p>Versions</p> <ul style="list-style-type: none"> <li>Without LED display</li> <li>LED display 12 V</li> <li>LED display 24 V</li> </ul>				
		<p><b>8WH2000-1AG08</b></p> <p><b>8WH2000-1BG28</b></p> <p><b>8WH2000-1BG38</b></p>		<p>1 50 units</p> <p>1 50 units</p> <p>1 50 units</p>		<p>1BT</p> <p>1BT</p> <p>1BT</p>
 <p>8WH2000-1GG08</p>  <p>8WH2000-1JG38</p>		<p><b>Fuse terminals, terminal size 4 mm<sup>2</sup>, for 5 x 20 mm G fuse links</b></p> <ul style="list-style-type: none"> <li>Terminal width 6.2 mm</li> <li> US</li> <li>IEC 60947-7-3</li> <li>With fuse           <ul style="list-style-type: none"> <li>Rigid 0.08 ... 6 mm<sup>2</sup>, flexible 0.08 ... 4 mm<sup>2</sup>, AWG 28-10</li> <li>I<sub>max</sub> = 6.3 A, only short-circuit protection, single 4 W, group 2.5 W</li> <li>U = 250 V, overload protection, single 4 W, group 1.6 W</li> </ul> </li> <li>As isolating terminal           <ul style="list-style-type: none"> <li>Rigid 0.08 ... 6 mm<sup>2</sup>, flexible 0.08 ... 4 mm<sup>2</sup>, AWG 28-10</li> <li>I = 6.3 A, U = 250 V</li> </ul> </li> <li>Enclosed at both ends</li> </ul> <p>Versions</p> <ul style="list-style-type: none"> <li>Without LED display</li> <li>LED display 15 ... 30 V</li> <li>LED display 30 ... 60 V</li> <li>LED display 110 ... 250 V</li> </ul>				
		<p><b>8WH2000-1GG08</b></p> <p><b>8WH2000-1JG38</b></p> <p><b>8WH2000-1JG68</b></p> <p><b>8WH2000-1MG08</b></p>		<p>1 50 units</p> <p>1 50 units</p> <p>1 50 units</p> <p>1 50 units</p>		<p>1BT</p> <p>1BT</p> <p>1BT</p> <p>1BT</p>
 <p>8WH2000-1HG08</p>		<p><b>Fuse terminals, terminal size 4 mm<sup>2</sup>, for G fuse links 6.3 x 32 mm (inch fuses)</b></p> <ul style="list-style-type: none"> <li>Terminal width 8.2 mm</li> <li> US</li> <li>IEC 60947-7-3</li> <li>With fuse           <ul style="list-style-type: none"> <li>Rigid 0.08 ... 6 mm<sup>2</sup>, flexible 0.08 ... 4 mm<sup>2</sup>, AWG 28-10</li> <li>I = 10 A</li> <li>U = 400 V</li> <li>Current and voltage are determined by the fitted fuse or the selected LED display</li> </ul> </li> <li>As isolating terminal           <ul style="list-style-type: none"> <li>Rigid 0.08 ... 6 mm<sup>2</sup>, flexible 0.08 ... 4 mm<sup>2</sup>, AWG 28-10</li> <li>I = 10 A, U = 400 V</li> </ul> </li> <li>Enclosed at both ends</li> </ul> <p>Versions</p> <ul style="list-style-type: none"> <li>Without LED display</li> <li>With LED display 100 ... 250 V</li> </ul>				
		<p><b>8WH2000-1HG08</b></p> <p><b>8WH2000-1RG08</b></p>		<p>1 50 units</p> <p>1 50 units</p>		<p>1BT</p> <p>1BT</p>
<b>Accessories</b>						
 <p>8WH9070-0AA00</p>		<p><b>Compartment partitions, for terminal sizes 1.5 and 4 mm<sup>2</sup></b></p> <p>Versions</p> <ul style="list-style-type: none"> <li>Two clamping points</li> <li>Three clamping points (inch fuse)</li> </ul>				
		<p><b>8WH9070-0AA00</b></p> <p><b>8WH9070-0KA00</b></p>		<p>100 50 units</p> <p>100 50 units</p>		<p>1BT</p> <p>1BT</p>

For general accessories for 8WH terminal blocks, see chapter "Accessories for 8WH Terminal Blocks"

## Overview



Through-type terminals with isolating blade capability are the most commonly used terminal types in measuring and control technology.

The isolating blade terminals with nominal cross-section of 2.5 mm<sup>2</sup> are characterized in particular by their slim design of 5.2 mm and their high current-carrying capacity of 16 A. In addition the terminals provide a test tap parallel to the isolation point for 2.3 mm  $\varnothing$  test plugs. Potential distributors can be conveniently assembled using connecting combs.

Terminals with three and four clamping points are available for multi-conductor connection. With their compact design these terminals can also be used in small terminal boxes and their front connection arrangement enables user-friendly wiring.

The isolating blade is secured to the terminal so that it cannot be lost.

A label can be snapped on to the middle of the terminal at the front. Further labels can also be mounted flat on the side of the terminals.

4







## Technical specifications

	8WH2000-6CF00	8WH2500-6CF00	8WH2003-6CF00	8WH2004-6CF00	8WH2000-6CG00
Dimensions					
• Width/length/cover width in mm	5.2 / 60.5 / 2.2	5.2 / 51 / 2.2	5.2 / 72 / 2.2	5.2 / 84 / 2.2	6.2 / 61.5 / --
• Height (NS 35/7.5 / NS 35/15) in mm	36.5 / 44	43 / 50.5	36.5 / 44		
Technical specifications acc. to IEC/DIN VDE					
• Max. load current in A / cross-section in mm <sup>2</sup>	16 / 4				16 / 6
• Maximum data / rated data in A / mm <sup>2</sup>	--				
• Rated impulse withstand voltage in kV / pollution degree	6 / 3				
• Overvoltage category / molded plastic group	III / I				
Connection capacities					
• Flexible with end sleeve, with plastic sleeve in mm <sup>2</sup>	0.25... 2.5				0.25 ... 4
• Flexible with end sleeve, without plastic sleeve in mm <sup>2</sup>	0.25 ... 2.5				0.25 ... 4
• Flexible with two-wire connection end sleeve, with plastic sleeve in mm <sup>2</sup>	0.5				
Stripped length in mm	10				
Plug gauge (IEC 60947-1)	A4	A3	A4	A3	
Molded plastic type	PA				
• Flammability Class acc. to UL 94	V0				
Approval data (UL/cUL and CSA)					
• Rated voltage / rated current / conductor sizes					
- UL/cUL: in V/A / AWG	600 / 16 / 26 ... 12	600 / 16 / 24 ... 12	600 / 16 / 26 ... 12		300 / 6.3 / 24 ... 10
- CSA: in V/A / AWG	--				

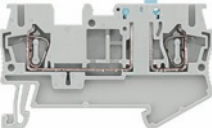
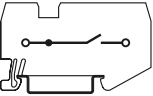
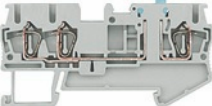
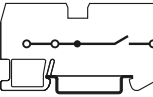
# 8WH2 Spring-Loaded Terminals

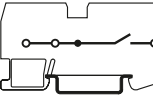
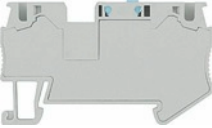
## 8WH isolating blade terminals

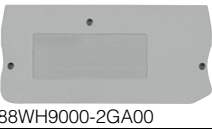
### Selection and ordering data

Version	DT	Article No. <a href="http://www.siemens.com/product?Article No.">www.siemens.com/ product?Article No.</a>	Price per PU	PU (UNIT, SET, M)	PS*/ P. unit	PG	
<b>Terminal size 2.5 mm<sup>2</sup></b>							
 <p>8WH2000-6CF00</p>  <p>I201_12684 8WH2000-6CF00</p>							
<b>Isolating blade terminals, terminal size 2.5 mm<sup>2</sup></b> <ul style="list-style-type: none"> <li>Terminal width 5.2 mm</li> <li> <ul style="list-style-type: none"> <li>IEC 60947-7-1               <ul style="list-style-type: none"> <li>Rigid 0.08 ... 4 mm<sup>2</sup></li> <li>Flexible 0.08 ... 2.5 mm<sup>2</sup></li> <li>AWG 28-12</li> <li>I = 16 A</li> <li>U = 400 V</li> </ul> </li> </ul> </li> <li>For 3 and 4 clamping points:           <ul style="list-style-type: none"> <li>Rigid 0.14 ... 4 mm<sup>2</sup></li> <li>Flexible 0.14 ... 2.5 mm<sup>2</sup></li> <li>AWG 26 ... 14</li> </ul> </li> </ul>							
<b>Versions</b> <ul style="list-style-type: none"> <li>Gray           <ul style="list-style-type: none"> <li>Two clamping points</li> <li>Three clamping points</li> <li>Four clamping points</li> </ul> </li> </ul>							
<b>Note</b> On terminals with three and four clamping points, the total current through all connected conductors must not exceed the max. load current.							
 <p>8WH2003-6CF00</p>  <p>I201_12685 8WH2003-6CF00</p>							
 <p>8WH2004-6CF00</p>  <p>I201_12686 8WH2004-6CF00</p>							
						<b>8WH2000-6CF00</b> <b>8WH2003-6CF00</b> <b>8WH2004-6CF00</b>	1 50 units 1BT 1 50 units 1BT 1 50 units 1BT
 <p>8WH2000-6CG00</p>							
<b>Isolating blade terminals, size 4 mm<sup>2</sup>, two clamping points</b> <ul style="list-style-type: none"> <li>Gray</li> <li>Terminal width 6.2 mm</li> <li> <ul style="list-style-type: none"> <li>IEC 60947-7-1               <ul style="list-style-type: none"> <li>Rigid 0.08 ... 6 mm<sup>2</sup>, flexible 0.08 ... 4 mm<sup>2</sup>, AWG 28-10</li> <li>I = 16 A, U = 400 V</li> </ul> </li> </ul> </li> <li>Enclosed at both ends</li> </ul>							
<b>Accessories</b>							
 <p>8WH9070-0AA00</p>							
<b>Compartment partitions, for terminal size 1.5 ... 4 mm<sup>2</sup></b>							
<b>Versions</b> <ul style="list-style-type: none"> <li>Two clamping points</li> <li>Three clamping points</li> <li>Four clamping points</li> </ul>							
						<b>8WH9070-0AA00</b> <b>8WH9070-0GA00</b> <b>8WH9070-0HA00</b>	100 50 units 1BT 100 50 units 1BT 100 50 units 1BT
 <p>8WH9000-2GA00</p>							
<b>Covers, for terminal size 1.5 ... 2.5 mm<sup>2</sup></b>							
<b>Versions</b> <ul style="list-style-type: none"> <li>For two clamping points</li> <li>For three clamping points</li> <li>For four clamping points</li> </ul>							
						<b>8WH9000-2GA00</b> <b>8WH9000-4GA00</b> <b>8WH9000-5GA00</b>	100 50 units 1BT 100 50 units 1BT 100 50 units 1BT
 <p>8WH9000-0GA00</p>							
<b>Cover segments, for terminal size 2.5 mm<sup>2</sup> and three or four clamping points</b>							
						<b>8WH9000-0GA00</b>	100 10 units 1BT

For general accessories for 8WH terminal blocks, see chapter "Accessories for 8WH Terminal Blocks"

## Overview

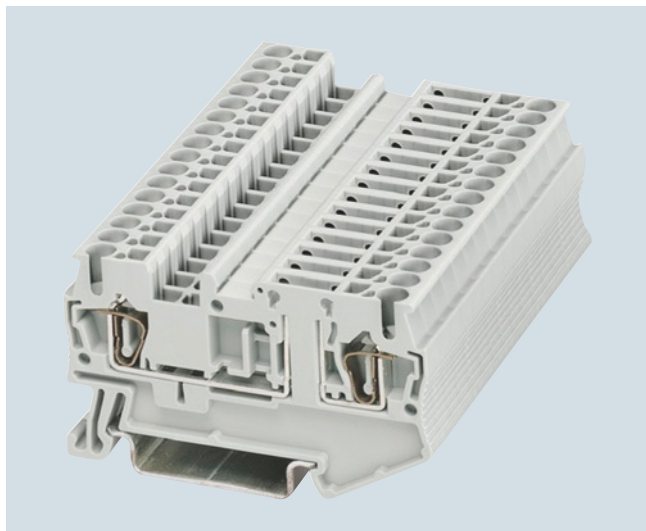

The isolating terminals are available with the same contour as the isolating blade terminals. The terminals excel with their narrow width of only 5.2 mm and their high current load rating of 16 A.

There is a test option for 2.3 mm  $\varnothing$  test plugs at both ends of the isolating point.

The 6.2 mm wide isolating terminal with terminal size 4 mm<sup>2</sup> is a base terminal for accommodating:

- Isolating plugs,
- Through-type connectors,
- Fused connectors and
- Component connectors.

A label can be snapped on to the middle of the terminal at the front. Further labels can also be mounted flat on the side of the terminals.

4







## Technical specifications

	8WH2000-6AF00	8WH2500-6AF00	8WH2003-6AF00	8WH2004-6AF00	8WH2000-6AG00
Dimensions					
• Width/length/cover width in mm	5.2 / 60.5 / 2.2	5.2 / 51 / 2.2	5.2 / 72 / 2.2	5.5 / 84 / 2.2	6.2 / 61.5 / --
• Height (NS 35/7.5 / NS 35/15) in mm	36.5 / 44	43 / 50.5	36.5 / 44		
Technical specifications acc. to IEC/DIN VDE					
• Max. load current in A / cross-section in mm <sup>2</sup>	16 / 4				16 / 6
• Rated impulse withstand voltage in kV / pollution degree	6 / 3				
• Overvoltage category / molded plastic group	III / I				
Connection capacities					
• Flexible with end sleeve, with plastic sleeve in mm <sup>2</sup>	0.25 ... 2.5				0.25 ... 4
• Flexible with end sleeve, without plastic sleeve in mm <sup>2</sup>	0.25 ... 2.5				0.25 ... 4
• Flexible with two-wire connection end sleeve, with plastic sleeve in mm <sup>2</sup>	0.5				
Stripped length in mm	10				
Plug gauge (IEC 60947-1)	A3				A4
Molded plastic type	PA				
• Flammability Class acc. to UL 94	V0				
Approval data (UL/cUL and CSA)					
• Rated voltage / rated current / conductor sizes					
- UL/cUL: in V/A / AWG	300 / 16 / 26 ... 12	300 / 16 / 24 ... 12	300 / 16 / 26 ... 12		300 / 6.3 / 24 ... 10
- CSA: in V/A / AWG	--				

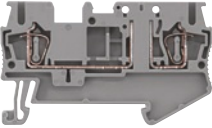
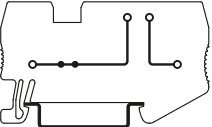
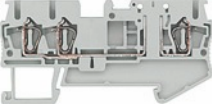
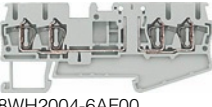
# 8WH2 Spring-Loaded Terminals

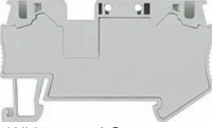
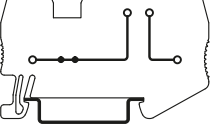
## 8WH isolating terminals

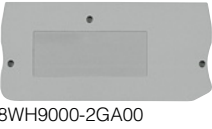
### Selection and ordering data

Version	DT	Article No. <a href="http://www.siemens.com/product?Article No.">www.siemens.com/ product?Article No.</a>	Price per PU	PU (UNIT, SET, M)	PS*/ P. unit	PG
<b>Terminal size 2.5 mm<sup>2</sup></b>						
 <p>8WH2000-6AF00</p>  <p>i201_12682 8WH2000-6AF00</p>  <p>8WH2003-6AF00</p>  <p>8WH2004-6AF00</p>		<b>Isolating terminals, terminal size 2.5 mm<sup>2</sup></b> <ul style="list-style-type: none"> <li>• Gray</li> <li>• Terminal width 5.2 mm</li> <li>•  US</li> <li>• IEC 60947-7-1 <ul style="list-style-type: none"> <li>- Rigid 0.08 ... 4 mm<sup>2</sup></li> <li>- Flexible 0.08 ... 2.5 mm<sup>2</sup></li> <li>- AWG 28-12</li> <li>- Current and voltage are determined by the fitted plug</li> <li>- <math>I = 16</math> A</li> <li>- <math>U = 400</math> V</li> </ul> </li> </ul> <b>Versions</b> <ul style="list-style-type: none"> <li>• Two clamping points</li> <li>• Three clamping points</li> <li>• Four clamping points</li> </ul>				
		<b>8WH2000-6AF00</b> <b>8WH2003-6AF00</b> <b>8WH2004-6AF00</b>		1 50 units 1 50 units 1 50 units	1BT 1BT 1BT	
<b>Terminal size 4 mm<sup>2</sup></b>						
 <p>8WH2000-6AG00</p>  <p>i201_12682 8WH2000-6AG00</p>		<b>Isolating terminals, terminal size 4 mm<sup>2</sup>, two clamping points</b> <ul style="list-style-type: none"> <li>• Gray</li> <li>• Terminal width 6.2 mm</li> <li>•  US</li> <li>• IEC 60947-7-1 <ul style="list-style-type: none"> <li>- Rigid 0.08 ... 6 mm<sup>2</sup></li> <li>- Flexible 0.08 ... 4 mm<sup>2</sup></li> <li>- AWG 28-10</li> <li>- Current and voltage are determined by the fitted plug</li> <li>- <math>I = 16</math> A</li> <li>- <math>U = 400</math> V</li> </ul> </li> <li>• Enclosed at both ends</li> </ul>				
		<b>8WH2000-6AG00</b>		1 50 units	1BT	
<b>Accessories</b>						
 <p>8WH9070-0GA00</p>		<b>Compartment partitions</b> <b>Versions</b> <ul style="list-style-type: none"> <li>• For terminal size 2.5 mm<sup>2</sup> <ul style="list-style-type: none"> <li>- For three clamping points</li> <li>- For four clamping points</li> </ul> </li> <li>• For terminal size 4 mm<sup>2</sup> <ul style="list-style-type: none"> <li>- For two clamping points</li> </ul> </li> </ul>				
		<b>8WH9070-0GA00</b> <b>8WH9070-0HA00</b>		100 50 units 100 50 units	1BT 1BT	
		<b>8WH9070-0AA00</b>		100 50 units	1BT	
 <p>8WH9000-2GA00</p>		<b>Covers</b> Gray <b>Versions</b> <ul style="list-style-type: none"> <li>• For terminal size 1.5 up to 2.5 mm<sup>2</sup> and two clamping points</li> <li>• For terminal size 2.5 mm<sup>2</sup> and three clamping points</li> <li>• For terminal size 2.5 mm<sup>2</sup> and four clamping points</li> </ul>				
		<b>8WH9000-2GA00</b> <b>8WH9000-4GA00</b> <b>8WH9000-5GA00</b>		100 50 units 100 50 units 100 50 units	1BT 1BT 1BT	
 <p>8WH9000-0GA00</p>		<b>Cover segments, for terminal sizes 1.5 mm<sup>2</sup> and 2.5 mm<sup>2</sup> and three or four clamping points</b> Gray		100 10 units	1BT	

For general accessories for 8WH terminal blocks, see chapter "Accessories for 8WH Terminal Blocks"

## Overview

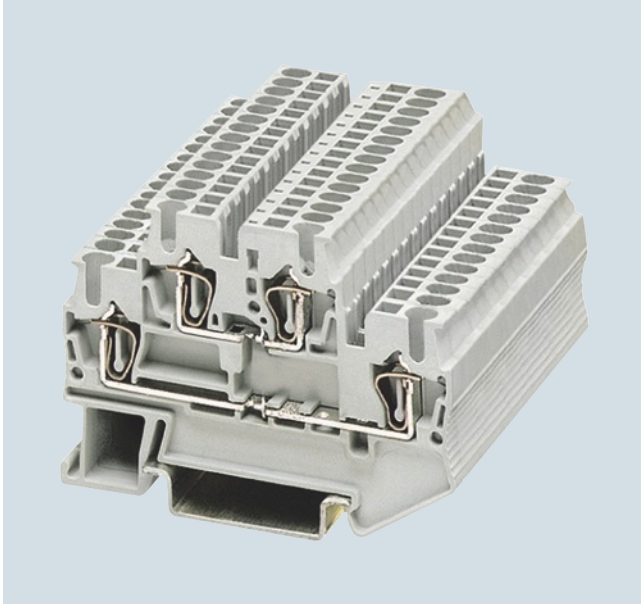
**Standard two-tier terminals**

With the two voltage levels routed through two separate tiers, the two-tier terminals require 50 % less space than equivalent single-tier terminals. To implement a wide range of wiring tasks, connecting combs can be fitted to both tiers of the spring-loaded terminal series. Facilities for inscription are provided at each clamping point.

**PE/ground conductor function**

Perfect mechanical and electrical contact with the support rail is provided by simply snapping the terminals onto the rail.

The PE two-tier terminals meet all the requirements of IEC 60947-7-2:

- Low contact resistance
- Stainless clamping points
- Green-yellow enclosure
- Additional inscription options

**PE/L and PE/N types**

The PE/L and PE/N types provide a PE/ground contact to the support rail in the lower tier. The upper tier is designed as a through-type tier. Color coding of the PE and neutral tiers enables clear and unambiguous distribution of the potential.

The clamping points of two-tier terminals can be inscribed with flat labels.

## Technical specifications

	8WH2020-0AE00 8WH2020-0AE01 8WH2025-0AE00	8WH0020-0CE07	8WH2020-0AF00 8WH2020-0AF01 8WH2025-0AF00	8WH2023-0AF00 8WH2023-0AF01 8WH2022-0AF00	8WH2020-0CF07
Dimensions					
• Width/length/cover width in mm	4.2 / 67.5 / 2.2		5.2 / 67.5 / 2.2	5.2 / 91.5 / 2.2	5.2 / 67.5 / 2.2
• Height (NS 35/7.5 / NS 35/15) in mm	47.5 / 55				
Technical specifications acc. to IEC/DIN VDE					
• Max. load current in A / cross-section in mm <sup>2</sup>	17.5 / 1.5	--	26 / 4	--	--
• Maximum data / rated data in A / mm <sup>2</sup>	--			26 / 4 // 22 / 2.5	--
• Rated impulse withstand voltage in kV / pollution degree	6 / 3				
• Overvoltage category / molded plastic group	III / I				
Connection capacities					
• Flexible with end sleeve, with plastic sleeve in mm <sup>2</sup>	0.25 ... 1.5		0.25 ... 2.5		
• Flexible with end sleeve, without plastic sleeve in mm <sup>2</sup>	0.25 ... 1.5		0.25 ... 2.5		
• Flexible with two-wire connection end sleeve, with plastic sleeve in mm <sup>2</sup>	0.5				
Stripped length in mm	10				
Plug gauge (IEC 60947-1)	A1		A3		
Molded plastic type	PA				
• Flammability Class acc. to UL 94	V0				
Approval data (UL/cUL and CSA)					
• Rated voltage / rated current / conductor sizes					
- UL/cUL: in V/A / AWG	300 / 15 / 26 ... 14	-- / -- / 26 ... 14	600 / 20 / 26 ... 12	300 / 20 / 26 ... 12	-- / -- / 26 ... 12
- CSA: in V/A / AWG	300 / 15 / 26 ... 14	-- / -- / 26 ... 14	--		-- / -- / 26 ... 12
Support rails/protective conductor busbars	--	See page 1/3, section "Support rails"	--		See page 1/3, section "Support rails"

## 8WH2 Spring-Loaded Terminals



### 8WH two-tier terminals

	8WH2023-0CF07	8WH2020-4AF00	8WH2020-4BF00
Dimensions			
• Width/length/cover width in mm	5.2 / 91.5 / 2.2	5.2 / 67.5 / 2.2	
• Height (NS 35/7.5 / NS 35/15) in mm	47.5 / 55		
Technical specifications acc. to IEC/DIN VDE			
• Max. load current in A / cross-section in mm <sup>2</sup>	--	32 / 4	
• Rated impulse withstand voltage in kV / pollution degree	6 / 3		
• Overvoltage category / molded plastic group	III / I		
Connection capacities			
• Flexible with end sleeve, with plastic sleeve in mm <sup>2</sup>	0.25 ... 2.5		
• Flexible with end sleeve, without plastic sleeve in mm <sup>2</sup>	0.25 ... 2.5		
• Flexible with two-wire connection end sleeve, with plastic sleeve in mm <sup>2</sup>	0.5		
Stripped length in mm	10		
Plug gauge (IEC 60947-1)	A3		
Molded plastic type	PA		
• Flammability Class acc. to UL 94	V0		
Approval data (UL/cUL and CSA)			
• Rated voltage / rated current / conductor sizes			
- UL/cUL: in V/A / AWG	-- / -- / 26 ... 12	300 / 20 / 26 ... 12	--
- CSA: in V/A / AWG	-- / -- / 26 ... 12	--	
Support rails/protective conductor busbars	See page 1/3, section "Support rails"	--	

	8WH2020-4CF00	8WH2020-0AG00 8WH2020-0AG01 8WH2025-0AG00	8WH2020-0CG07
Dimensions			
• Width/length/cover width in mm	5.2 / 67.5 / 2.2	6.2 / 83.5 / 2.2	6.2 / 83.5 / 2.2
• Height (NS 35/7.5 / NS 35/15) in mm	47.5 / 55		
Technical specifications acc. to IEC/DIN VDE			
• Max. load current in A / cross-section in mm <sup>2</sup>	26 / 4	32 / 6	--
• Rated impulse withstand voltage in kV / pollution degree	6 / 3		
• Overvoltage category / molded plastic group	III / I		
Connection capacities			
• Flexible with end sleeve, with plastic sleeve in mm <sup>2</sup>	0.25 ... 2.5	0.25 ... 4	0.25 ... 4
• Flexible with end sleeve, without plastic sleeve in mm <sup>2</sup>	0.25 ... 2.5	0.25 ... 4	0.25 ... 4
• Flexible with two-wire connection end sleeve, with plastic sleeve in mm <sup>2</sup>	0.5	0.5 ... 1	0.5 ... 1
Stripped length in mm	10		
Plug gauge (IEC 60947-1)	A3	A4	
Molded plastic type	PA		
• Flammability Class acc. to UL 94	V0		
Approval data (UL/cUL and CSA)			
• Rated voltage / rated current / conductor sizes			
- UL/cUL: in AWG	300 / 20 / 26 ... 12	300 / 30 / 20 ... 10	20 ... 10
- CSA: in AWG	-- / -- / 26 ... 12		20 ... 10
Support rails/protective conductor busbars	--		See page 1/3, section "Support rails"



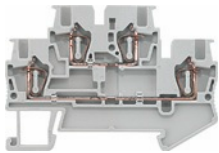
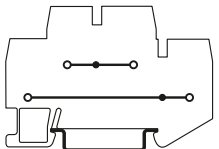
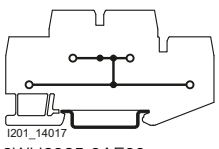

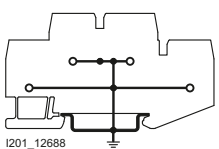





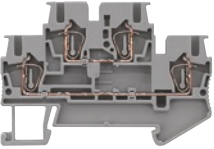
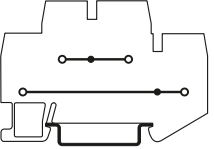
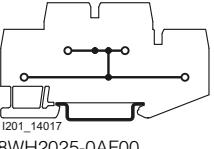

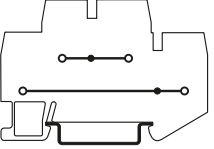
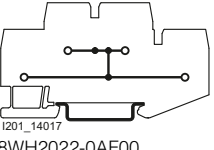
## Selection and ordering data

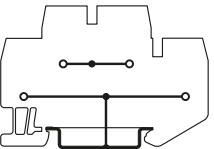
Version	DT	Article No. <a href="http://www.siemens.com/product?ArticleNo.">www.siemens.com/ product?Article No.</a>	Price per PU	PU (UNIT, SET, M)	PS*/ P. unit	PG
<b>Terminal size 1.5 mm<sup>2</sup></b>						
 <p>8WH2020-0AE00</p>  <p>I201_12691 8WH2020-0AE00</p>  <p>I201_14017 8WH2025-0AE00</p>		<p><b>Two-tier terminals, terminal size 1.5 mm<sup>2</sup></b></p> <ul style="list-style-type: none"> <li>Terminal width 4.2 mm</li> <li>UL US, CE</li> <li>IEC 60947-7-1 <ul style="list-style-type: none"> <li>Rigid 0.08 ... 1.5 mm<sup>2</sup></li> <li>Flexible 0.08 ... 1.5 mm<sup>2</sup></li> <li>AWG 28-16</li> <li>I = 17.5 A</li> <li>The total current through all connected conductors must not exceed the max. load current</li> <li>U = 500 V</li> </ul> </li> </ul> <p>Versions</p> <ul style="list-style-type: none"> <li>Gray <ul style="list-style-type: none"> <li>Without equipotential bonding, 2-pole Ⓞ</li> <li>With equipotential bonding, 1-pole</li> </ul> </li> <li>Blue, 2-pole</li> </ul>				
		<p><b>8WH2020-0AE00</b></p> <p><b>8WH2025-0AE00</b></p> <p><b>8WH2020-0AE01</b></p>			<p>1 50 units 1BT</p> <p>1 50 units 1BT</p> <p>1 50 units 1BT</p>	
 <p>8WH2020-0CE07</p>  <p>I201_12688 8WH2020-0CE07</p>		<p><b>PE two-tier terminals, terminal size 1.5 mm<sup>2</sup></b></p> <ul style="list-style-type: none"> <li>Terminal width 4.2 mm</li> <li>UL US, CE</li> <li>IEC 60947-7-1 <ul style="list-style-type: none"> <li>Rigid 0.08 ... 1.5 mm<sup>2</sup></li> <li>Flexible 0.08 ... 1.5 mm<sup>2</sup></li> <li>AWG 28-16</li> </ul> </li> <li>Green/yellow</li> </ul>				
		<b>8WH2020-0CE07</b>			1 50 units 1BT	

## 8WH2 Spring-Loaded Terminals

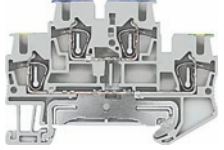
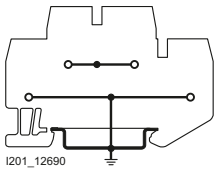
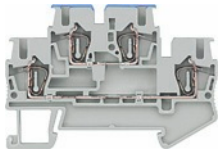
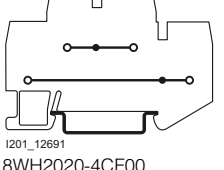

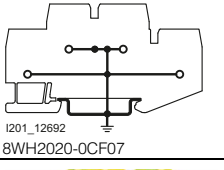

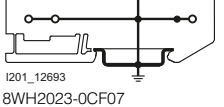

## 8WH two-tier terminals

Version	DT	Article No. <a href="http://www.siemens.com/product?Article.No.">www.siemens.com/ product?Article No.</a>	Price per PU	PU (UNIT, SET, M)	PS*/ P. unit	PG
<b>Terminal size 2.5 mm<sup>2</sup></b>						
 <p>8WH2020-0AF00</p>  <p>I201_12691 8WH2020-0AF00</p>  <p>I201_14017 8WH2025-0AF00</p>		<p><b>Two-tier terminals, terminal size 2.5 mm<sup>2</sup></b></p> <ul style="list-style-type: none"> <li>Terminal width 5.2 mm</li> <li>  </li> <li>IEC 60947-7-1           <ul style="list-style-type: none"> <li>Rigid 0.08 ... 4 mm<sup>2</sup></li> <li>Flexible 0.08 ... 2.5 mm<sup>2</sup></li> <li>AWG 28-12</li> <li>I = 26 A</li> </ul> </li> <li>The total current through all connected conductors must not exceed the max. load current           <ul style="list-style-type: none"> <li>U = 500 V</li> </ul> </li> </ul> <p>Versions</p> <ul style="list-style-type: none"> <li>Gray           <ul style="list-style-type: none"> <li>Without equipotential bonding, 2-pole</li> <li>With equipotential bonding, 1-pole</li> </ul> </li> <li>Blue           <ul style="list-style-type: none"> <li>Without equipotential bonding, 2-pole</li> <li>With equipotential bonding, 1-pole</li> </ul> </li> </ul>				
 <p>8WH2023-0AF00</p>  <p>I201_12691 8WH2023-0AF00</p>  <p>I201_14017 8WH2022-0AF00</p>		<p><b>Two-tier terminals, terminal size 2.5 mm<sup>2</sup>, three clamping points on one level</b></p> <ul style="list-style-type: none"> <li>Terminal width 5.2 mm</li> <li>  </li> <li>IEC 60947-7-1           <ul style="list-style-type: none"> <li>Rigid 0.08 ... 4 mm<sup>2</sup></li> <li>Flexible 0.08 ... 2.5 mm<sup>2</sup></li> <li>AWG 28-12</li> <li>I = 26 A</li> </ul> </li> <li>The total current through all connected conductors must not exceed the max. load current           <ul style="list-style-type: none"> <li>U = 500 V</li> </ul> </li> </ul> <p>Versions</p> <ul style="list-style-type: none"> <li>Gray           <ul style="list-style-type: none"> <li>Without equipotential bonding, 2-pole</li> <li>With equipotential bonding, 1-pole</li> </ul> </li> <li>Blue, 2-pole</li> </ul>				
 <p>8WH2020-4AF00</p>  <p>I201_12689 8WH2020-4AF00</p>		<p><b>Two-tier terminals, terminal size 2.5 mm<sup>2</sup>, L at top and PE at bottom</b></p> <ul style="list-style-type: none"> <li>Gray</li> <li>Terminal width 5.2 mm</li> <li>  </li> <li>DIN VDE 0611 and IEC 60947-7-2           <ul style="list-style-type: none"> <li>Rigid 0.08 ... 4 mm<sup>2</sup></li> <li>Flexible 0.08 ... 2.5 mm<sup>2</sup></li> <li>AWG 28-12</li> <li>I = 32 A</li> <li>U = 500 V</li> </ul> </li> </ul>				
		<p><b>8WH2020-0AF00</b></p> <p><b>8WH2025-0AF00</b></p> <p><b>8WH2020-0AF01</b></p> <p><b>8WH2025-0AF01</b></p>		<p>1 50 units 1BT</p> <p>1 50 units 1BT</p> <p>1 50 units 1BT</p> <p>1 50 units 1BT</p>		
		<p><b>8WH2023-0AF00</b></p> <p><b>8WH2022-0AF00</b></p> <p><b>8WH2023-0AF01</b></p>		<p>1 50 units 1BT</p> <p>1 50 units 1BT</p> <p>1 50 units 1BT</p>		
		<b>8WH2020-4AF00</b>		1 50 units 1BT		

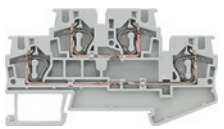
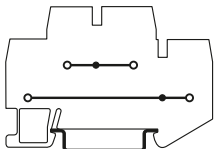
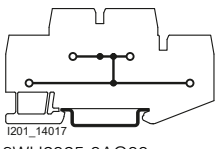
Version	DT	Article No. <a href="http://www.siemens.com/product?Article.No.">www.siemens.com/ product?Article No.</a>	Price per PU	PU (UNIT, SET, M)	PS*/ P. unit	PG
 <p>8WH2020-4BF00</p>  <p>I201_12690 8WH2020-4BF00</p>		<b>Two-tier terminals, terminal size 2.5 mm<sup>2</sup>, N at top and PE at bottom</b> <ul style="list-style-type: none"> <li>• Gray</li> <li>• Terminal width 5.2 mm</li> <li>• DIN VDE 0611 and IEC 60947-7-2 <ul style="list-style-type: none"> <li>- Rigid 0.08 ... 4 mm<sup>2</sup></li> <li>- Flexible 0.08 ... 2.5 mm<sup>2</sup></li> <li>- AWG 28-12</li> <li>- I = 32 A</li> <li>- U = 500 V</li> </ul> </li> </ul>			1 50 units	1BT
 <p>8WH2020-4CF00</p>  <p>I201_12691 8WH2020-4CF00</p>		<b>Two-tier terminals, terminal size 2.5 mm<sup>2</sup>, N at top and L at bottom</b> <ul style="list-style-type: none"> <li>• Gray</li> <li>• Terminal width 5.2 mm</li> <li>• <b>UL</b> cULus</li> <li>• IEC 60947-7-1 <ul style="list-style-type: none"> <li>- Rigid 0.08 ... 4 mm<sup>2</sup></li> <li>- Flexible 0.08 ... 2.5 mm<sup>2</sup></li> <li>- AWG 28-12</li> <li>- I = 26 A</li> <li>- U = 500 V</li> </ul> </li> </ul>			1 50 units	1BT
 <p>8WH2020-OCF07</p>  <p>I201_12692 8WH2020-OCF07</p>		<b>PE two-tier terminals, terminal size 2.5 mm<sup>2</sup>, two clamping points on one level</b> <ul style="list-style-type: none"> <li>• Terminal width 5.2 mm</li> <li>• <b>UL</b> cULus</li> <li>• IEC 60947-7-2 <ul style="list-style-type: none"> <li>- Rigid 0.08 ... 4 mm<sup>2</sup></li> <li>- Flexible 0.08 ... 2.5 mm<sup>2</sup></li> <li>- AWG 28-12</li> </ul> </li> <li>• Green/yellow</li> </ul>			1 50 units	1BT
 <p>8WH2023-OCF07</p>  <p>I201_12693 8WH2023-OCF07</p>		<b>PE two-tier terminals, terminal size 2.5 mm<sup>2</sup>, three clamping points on one level</b> <ul style="list-style-type: none"> <li>• Terminal width 5.2 mm</li> <li>• <b>UL</b> cULus</li> <li>• IEC 60947-7-2 <ul style="list-style-type: none"> <li>- Rigid 0.08 ... 4 mm<sup>2</sup></li> <li>- Flexible 0.08 ... 2.5 mm<sup>2</sup></li> <li>- AWG 28-12</li> </ul> </li> <li>• Green/yellow</li> </ul>			1 50 units	1BT

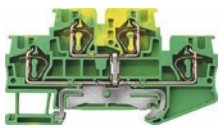
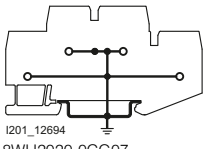
# 8WH2 Spring-Loaded Terminals

## 8WH two-tier terminals

Version	DT	Article No. <a href="http://www.siemens.com/product?ArticleNo.">www.siemens.com/ product?Article No.</a>	Price per PU	PU (UNIT, SET, M)	PS*/ P. unit	PG
<b>Terminal size 4 mm<sup>2</sup></b>						
 8WH2020-0AG00   I201_12691 8WH2020-0AG00   I201_14017 8WH2025-0AG00	<b>Two-tier terminals, terminal size 4 mm<sup>2</sup></b> <ul style="list-style-type: none"> <li>Terminal width 6.2 mm</li> <li>            US         </li> <li>IEC 60947-7-1           <ul style="list-style-type: none"> <li>Rigid 0.08 ... 6 mm<sup>2</sup></li> <li>Flexible 0.08 ... 4 mm<sup>2</sup></li> <li>AWG 28-10</li> <li>I = 32 A</li> <li>The total current through all connected conductors must not exceed the max. load current</li> <li>U = 500 V</li> </ul> </li> </ul>					
<b>Versions</b> <ul style="list-style-type: none"> <li>Gray           <ul style="list-style-type: none"> <li>Without equipotential bonding, 2-pole</li> <li>With equipotential bonding, 1-pole</li> </ul> </li> <li>Blue, 2-pole</li> </ul>		<b>8WH2020-0AG00</b> <b>8WH2025-0AG00</b> <b>8WH2020-0AG01</b>		1 50 units 1 50 units 1 50 units	1BT 1BT 1BT	
 8WH2020-0CG07   I201_12694 8WH2020-0CG07	<b>PE two-tier terminals, terminal size 4 mm<sup>2</sup></b> <ul style="list-style-type: none"> <li>Terminal width 6.2 mm</li> <li>            US         </li> <li>IEC 60947-7-2           <ul style="list-style-type: none"> <li>Rigid 0.08 ... 6 mm<sup>2</sup></li> <li>Flexible 0.08 ... 4 mm<sup>2</sup></li> <li>AWG 28-10</li> </ul> </li> <li>Green/yellow</li> </ul>	<b>8WH2020-0CG07</b>		1 50 units	1BT	
<b>Accessories</b>						
 8WH9070-0BA00	<b>Compartment partitions, for terminal size 1.5 ... 4 mm<sup>2</sup></b> <ul style="list-style-type: none"> <li>For visual and electrical separation of terminal groups</li> <li>2 mm thick</li> </ul>	<b>8WH9070-0BA00</b>		100 50 units	1BT	
 8WH9000-1VA00	<b>Covers</b> Gray  <b>Versions</b> <ul style="list-style-type: none"> <li>For terminal size 1.5 up to 2.5 mm<sup>2</sup></li> <li>For terminal size 2.5 mm<sup>2</sup> and three clamping points</li> <li>For terminal size 4 mm<sup>2</sup></li> </ul>	<b>8WH9000-1VA00</b> <b>8WH9000-2VA00</b> <b>8WH9003-1VA00</b>		100 50 units 100 50 units 100 50 units	1BT 1BT 1BT	

For general accessories for 8WH terminal blocks, see chapter "Accessories for 8WH Terminal Blocks"

## Overview

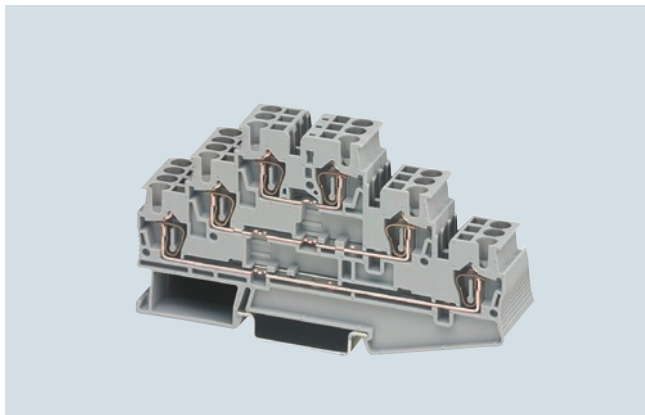

Our three-tier terminals offer three feed-through levels in a slim 5.2 mm terminal enclosure. They enable high wiring density – ideal for switchboards where space is at a premium.

With one bridge shaft per tier, these terminal blocks are ideal for use as compact potential distributors or initiator terminals. All six clamping points are interconnected on the equipotential bonding versions.

The three-tier terminal range is rounded off with a PE terminal with the same contour.

**Inscription**

Each tier of three-tier terminals can be inscribed with flat labels. If a label holder is used, the labels can be inserted at the front.

4

## Benefits

- Three feed-through levels with minimum footprint
- Comprehensive range of inscription options
- Matching accessories for 8WH terminal range
- One bridge shaft per tier
- Label holder is inserted

## Technical specifications

	8WH2030-0AF00 8WH2030-0AF01 8WH2035-0AF00	8WH2035-OCF07	8WH2030-4EF00 8WH2030-4HF00
Dimensions			
• Width/length in mm	5.2 / 99.5	5.2 / 99.5	5.2 / 99.5
• Height (TS 35/7.5 / TS 35/15 / TS 32) in mm	58 / 65.5	58 / 65.5	58 / 65.5
Technical specifications acc. to IEC/DIN VDE			
• Max. load current in A / cross-section in mm <sup>2</sup>	28 / 4	--	28 / 4
• Rated impulse withstand voltage in kV / pollution degree	6 / 3	6 / 3	6 / 3
• Overvoltage category / molded plastic group	III / I	III / I	III / I
Connection capacities			
• Flexible with end sleeve without / with plastic sleeve in mm <sup>2</sup>	0.25 ... 2.5	0.25 ... 2.5	0.25 ... 2.5
• Flexible with end sleeve, without plastic sleeve in mm <sup>2</sup>	0.25 ... 2.5	0.25 ... 2.5	0.25 ... 2.5
• Flexible with TWIN end sleeve with plastic sleeve in mm <sup>2</sup>	0.5	0.5	0.5
Stripped length in mm	10	10	10
Plug gauge (IEC 60947-1)	A3	A3	A3
Molded plastic type	PA	PA	PA
• Flammability Class acc. to UL 94	V0	V0	V0
Approval data (UL/CUR and CSA)			
• Rated voltage / rated current / conductor sizes			
- UL/CUR: V/A/AWG	600 / 20 / 26 ... 12	-- / -- / 24 ... 12	300 / 20 / 26 ... 12
- CSA: V/A/AWG	--	--	--

## Selection and ordering data

Version	DT	Article No. <a href="http://www.siemens.com/product?Article.No.">www.siemens.com/ product?Article.No.</a>	Price per PU	PU (UNIT, SET, M)	PS/ P. unit	PG
---------	----	--	-----------------	-------------------------	----------------	----

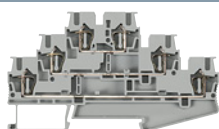
Terminal size 2.5 mm<sup>2</sup>

8WH2030-0AF00

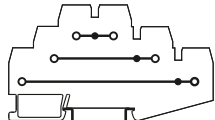

I201\_13974

8WH2030-0AF00

**Three-tier terminals, terminal size 2.5 mm<sup>2</sup>**

- Enclosed at both ends
- Terminal width 5.2 mm
- C<sub>us</sub>
- IEC 60947-7-1
  - Rigid 0.08 ... 4 mm<sup>2</sup>
  - Flexible 0.08 ... 2.5 mm<sup>2</sup>
  - AWG 28-12
  - I = 28 A
  - U = 500 V

## Versions

- Gray
- Blue





8WH2030-0AF00  
8WH2030-0AF01

1 50 units 1BT  
1 50 units 1BT

# 8WH2 Spring-Loaded Terminals

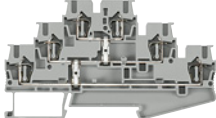
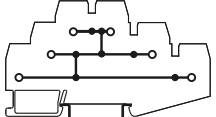
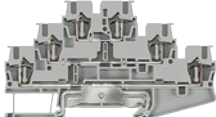
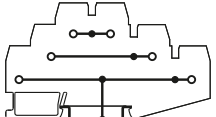
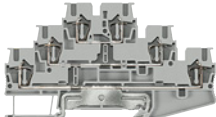
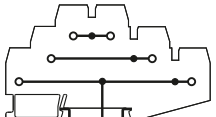
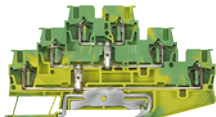
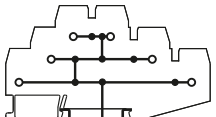
## 8WH three-tier terminals

Version	DT	Article No. <a href="http://www.siemens.com/product?Article.No.">www.siemens.com/ product?Article No.</a>	Price per PU	PU (UNIT, SET, M)	PS/ P. unit	PG
 <p>8WH2035-0AF00</p>  <p>I201_13975 8WH2035-0AF00</p> <p><b>Three-tier terminals, with equipotential bonding, terminal size 2.5 mm<sup>2</sup></b></p> <ul style="list-style-type: none"> <li>Enclosed at both ends</li> <li>Terminal width 5.2 mm</li> <li>C<sup>UL</sup><sub>US</sub></li> <li>IEC 60947-7-1 <ul style="list-style-type: none"> <li>Rigid 0.08 ... 4 mm<sup>2</sup></li> <li>Flexible 0.08 ... 2.5 mm<sup>2</sup></li> <li>AWG 28-12</li> <li>I = 28 A</li> <li>U = 500 V</li> </ul> </li> </ul> <p><b>Note</b></p> <p>The total current through all connected conductors must not exceed the max. load current.</p>		<b>8WH2035-0AF00</b>		1	50 units	1BT
 <p>8WH2030-4EF00</p>  <p>I201_13976 8WH2030-4EF00</p> <p><b>Three-tier terminals, "PE/L/N", terminal size 2.5 mm<sup>2</sup></b></p> <ul style="list-style-type: none"> <li>Enclosed at both ends</li> <li>Terminal width 5.2 mm</li> <li>C<sup>UL</sup><sub>US</sub></li> <li>IEC 60947-7-1 + IEC 60947-7-2 <ul style="list-style-type: none"> <li>Rigid 0.08 ... 4 mm<sup>2</sup></li> <li>Flexible 0.08 ... 2.5 mm<sup>2</sup></li> <li>AWG 28-12</li> </ul> </li> </ul>		<b>8WH2030-4EF00</b>		1	50 units	1BT
 <p>8WH2030-4HF00</p>  <p>I201_13976 8WH2030-4HF00</p> <p><b>Three-tier terminals, "PE/L/L", terminal size 2.5 mm<sup>2</sup></b></p> <ul style="list-style-type: none"> <li>Enclosed at both ends</li> <li>Terminal width 5.2 mm</li> <li>C<sup>UL</sup><sub>US</sub></li> <li>IEC 60947-7-1 + IEC 60947-7-2 <ul style="list-style-type: none"> <li>Rigid 0.08 ... 4 mm<sup>2</sup></li> <li>Flexible 0.08 ... 2.5 mm<sup>2</sup></li> <li>AWG 28-12</li> <li>I = 28 A</li> <li>U = 500 V</li> </ul> </li> </ul>		<b>8WH2030-4HF00</b>		1	50 units	1BT
 <p>8WH2035-0CF07</p>  <p>I201_13978 8WH2035-0CF07</p> <p><b>PE three-tier terminals, terminal size 2.5 mm<sup>2</sup></b></p> <ul style="list-style-type: none"> <li>Enclosed at both ends</li> <li>Terminal width 5.2 mm</li> <li>C<sup>UL</sup><sub>US</sub></li> <li>IEC 60947-7-2 <ul style="list-style-type: none"> <li>Rigid 0.08 ... 4 mm<sup>2</sup></li> <li>Flexible 0.08 ... 2.5 mm<sup>2</sup></li> <li>AWG 28-12</li> </ul> </li> </ul>		<b>8WH2035-0CF07</b>		1	50 units	1BT
<b>Accessories</b>						
 <p>8WH9000-1GD00</p> <p><b>Covers for three-tier terminals</b></p>		<b>8WH9000-1GD00</b>		100	50 units	1BT
 <p>8WH9060-4BA00</p> <p><b>Label holders, for three-tier terminals</b></p>		<b>8WH9060-4BA00</b>		100	100 units	1BT

For general accessories for 8WH terminal blocks, see chapter "Accessories for 8WH Terminal Blocks"

## Overview

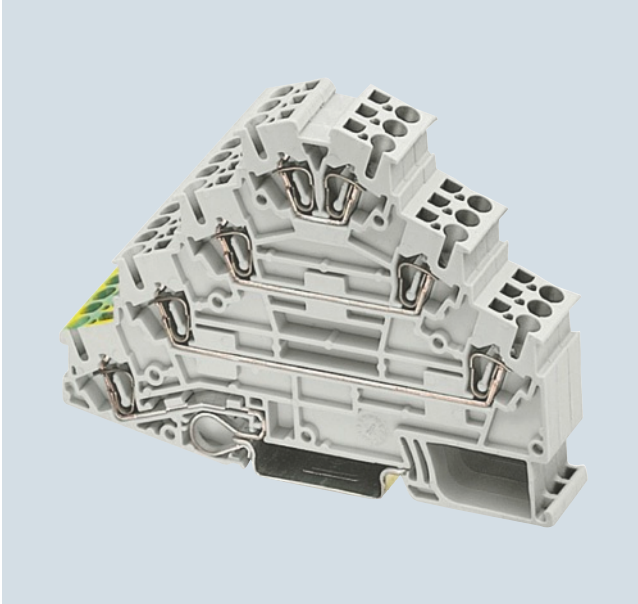
**Terminal size 2.5 mm<sup>2</sup>**

The four-tier motor terminals with terminal size 2.5 mm<sup>2</sup> are ideal for the compact wiring of AC loads. They have three through-levels and one PE connection which is contacted by simply snapping it onto the mounting rail.

No cross-bridging option.

**Terminal size 4 mm<sup>2</sup>**

Like the 2.5 mm<sup>2</sup> version, the four-tier motor terminal with 4 mm<sup>2</sup> also allows the wiring of three phases and the PE in a single terminal. This terminal is enclosed at both ends.

No cross-bridging option.

**Integrated PE/ground conductor function**

PE contact with the support rail is made by simply snapping the terminal onto the rail. This makes the four-tier motor terminals with terminal size 4 mm<sup>2</sup> ideal for the space-saving wiring of AC motors.

**Inscription**

Each clamping point has a facility for inscription and a test option for 2.3 mm  $\varnothing$  test plugs.

There is also sufficient space for labeling in the middle of the terminal on the front.

Labels can be mounted flat at the side of the terminals by simply snapping on.





## Technical specifications

	8WH2040-4LF00	8WH2040-4LG00
Dimensions		
• Width/length/cover width in mm	5.2 / 98.5 / 2.2	6.2 / 101 / --
• Height (NS 35/7.5 / NS 35/15) in mm	73.5 / 81	83.5 / 91
Technical specifications acc. to IEC/DIN VDE		
• Max. load current in A / cross-section in mm <sup>2</sup>	26 / 4	32 / 6
• Rated impulse withstand voltage in kV / pollution degree	8 / 3	
• Overvoltage category / molded plastic group	III / I	
Connection capacities		
• Flexible with end sleeve, with plastic sleeve in mm <sup>2</sup>	0.25 ... 2.5	0.25 ... 4
• Flexible with end sleeve, without plastic sleeve in mm <sup>2</sup>	0.25 ... 2.5	0.25 ... 4
• Flexible with two-wire connection end sleeve, with plastic sleeve in mm <sup>2</sup>	--	0.5 ... 1
Stripped length in mm	10	
Plug gauge (IEC 60947-1)	A3	A4
Molded plastic type	PA	
• Flammability Class acc. to UL 94	V0	
Approval data (UL/cUL and CSA)		
• Rated voltage / rated current / conductor sizes		
- UL/cUL: in V/A / AWG	-- / -- / 26 ... 12	--
- CSA: in V/A / AWG	--	600 / 30 / 28-10

## 8WH2 Spring-Loaded Terminals

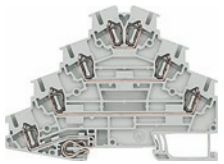
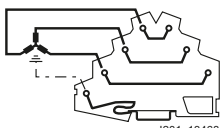
### 8WH four-tier motor terminals

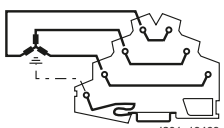
#### Selection and ordering data

Version	DT	Article No. <a href="http://www.siemens.com/product?Article No.">www.siemens.com/ product?Article No.</a>	Price per PU	PU (UNIT, SET, M)	PS*/ P. unit	PG
<b>Terminal size 2.5 mm<sup>2</sup></b>						
 <p>8WH2040-4LF00</p>  <p>8WH2040-4LF00 I201_13468</p>		<b>Four-tier motor terminals, terminal size 2.5 mm<sup>2</sup></b> <ul style="list-style-type: none"> <li>Terminal width 5.2 mm</li> <li>  </li> <li>IEC 60947-7-1 and IEC 60947-7-2           <ul style="list-style-type: none"> <li>Rigid 0.08 ... 4 mm<sup>2</sup></li> <li>Flexible 0.08 ... 2.5 mm<sup>2</sup></li> <li>AWG 28-12</li> <li>I = 26 A</li> <li>U = 800 V</li> </ul> </li> </ul>				
<b>Terminal size 4 mm<sup>2</sup></b>						
 <p>8WH2040-4LG00</p>  <p>8WH2040-4LG00 I201_13468</p>		<b>Four-tier motor terminals, terminal size 4 mm<sup>2</sup></b> <ul style="list-style-type: none"> <li>Terminal width 6.2 mm</li> <li>  </li> <li>IEC 60947-7-1 and IEC 60947-7-2           <ul style="list-style-type: none"> <li>Rigid 0.08 ... 6 mm<sup>2</sup></li> <li>Flexible 0.08 ... 4 mm<sup>2</sup></li> <li>AWG 28-10</li> <li>I = 32 A</li> <li>U = 800 V</li> </ul> </li> <li>Enclosed at both ends</li> </ul>				
<b>Accessories</b>						
 <p>8WH2040-4LG00</p>		<b>Covers</b> <b>For four-tier motor terminals, terminal size 2.5 mm<sup>2</sup></b>				
<b>8WH9000-1GE00</b>						
				100	50 units	1BT

For general accessories for 8WH terminal blocks, see chapter "Accessories for 8WH Terminal Blocks"



## Overview

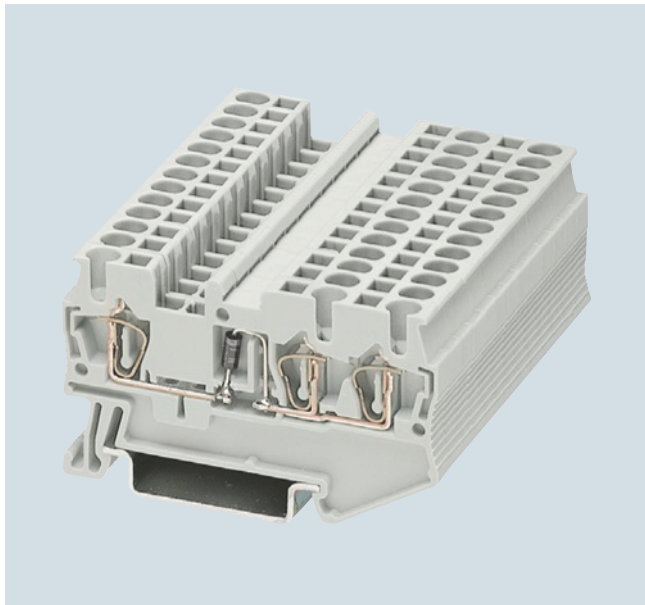

Diode terminals with a nominal cross-section of 2.5 mm<sup>2</sup> and a mounting width of just 5.2 mm can be used to implement many different wiring tasks. The diode is soldered in from left to right or vice versa as required.

A label can be snapped on to the middle of each terminal at the front. Further labels can also be mounted flat on the side of the terminals.





## Technical specifications

	8WH2003-5DF00 8WH2003-5CF00
Dimensions	
• Width/length/cover width in mm	5.5 / 60.5 / 2.2
• Height HV-M ... (NS 35/7.5 / NS 35/15) in mm	36.5 / 44
Technical specifications acc. to IEC/DIN VDE	
• Max. load current in A / cross-section in mm <sup>2</sup>	Determined by the diode / 4
• Rated impulse withstand voltage in kV / pollution degree	4 / 3
• Overvoltage category / molded plastic group	III / I
Connection capacities	
• Flexible with end sleeve, with plastic sleeve in mm <sup>2</sup>	0.25 ... 2.5
• Flexible with end sleeve, without plastic sleeve in mm <sup>2</sup>	0.25 ... 2.5
• Flexible with two-wire connection end sleeve, with plastic sleeve in mm <sup>2</sup>	0.5
Stripped length in mm	10
Plug gauge (IEC 60947-1)	A3
Molded plastic type	PA
• Flammability Class acc. to UL 94	V0
Approval data (UL/cUL and CSA)	
• Rated voltage / rated current / conductor sizes	
- UL/cUL: V/A/AWG	600 / 20 / 26 ... 12
- CSA: V/A/AWG	--

# 8WH2 Spring-Loaded Terminals

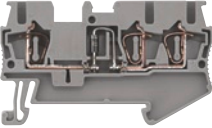
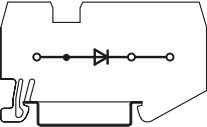
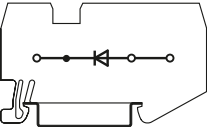
## 8WH diode terminals

### Selection and ordering data

Version	DT	Article No. <a href="http://www.siemens.com/product?ArticleNo.">www.siemens.com/ product?Article No.</a>	Price per PU	PU (UNIT, SET, M)	PS*/ P. unit	PG								
<b>Terminal size 2.5 mm<sup>2</sup></b>														
<b>Diode terminals, terminal size 2.5 mm<sup>2</sup>, with three clamping points</b>														
 8WH2003-5DF00														
 I201_12712 8WH2003-5DF00														
 I201_12713 8WH2003-5CF00														
<ul style="list-style-type: none"> <li>• Uninterrupted limiting current: 0.5 A</li> <li>• Blocking voltage: 1300 V</li> <li>• Terminal width 5.2 mm</li> <li>•  US</li> <li>• Connection data               <ul style="list-style-type: none"> <li>- Rigid 0.08 ... 4 mm<sup>2</sup></li> <li>- Flexible 0.08 ... 2.5 mm<sup>2</sup></li> <li>- AWG 28-12</li> <li>- <math>I</math> = the maximum current is determined by the diode</li> <li>- <math>U</math> = 500 V</li> </ul> </li> <li>• With integrated diode</li> <li>• Integrated: diode 1N 4007</li> </ul>														
<b>Versions</b> <ul style="list-style-type: none"> <li>• Let-through from left to right</li> <li>• Let-through from right to left</li> </ul>														
<table border="0"> <tr> <td><b>8WH2003-5DF00</b></td> <td>1</td> <td>50 units</td> <td>1BT</td> </tr> <tr> <td><b>8WH2003-5CF00</b></td> <td>1</td> <td>50 units</td> <td>1BT</td> </tr> </table>							<b>8WH2003-5DF00</b>	1	50 units	1BT	<b>8WH2003-5CF00</b>	1	50 units	1BT
<b>8WH2003-5DF00</b>	1	50 units	1BT											
<b>8WH2003-5CF00</b>	1	50 units	1BT											
<b>Accessories</b>														
<b>Compartment partitions, for terminal size 1.5 ... 4 mm<sup>2</sup> and three clamping points</b>														
 8WH9070-0GA00				100	50 units	1BT								
<b>Covers, for terminal size 1.5 ... 2.5 mm<sup>2</sup> and three clamping points</b>														
 8WH9000-4GA00				100	50 units	1BT								
<b>Cover segments, for terminal sizes 1.5 and 2.5 mm<sup>2</sup> and three clamping points</b>														
 8WH9000-0GA00				100	10 units	1BT								

For general accessories for 8WH terminal blocks, see chapter "Accessories for 8WH Terminal Blocks"

## Overview

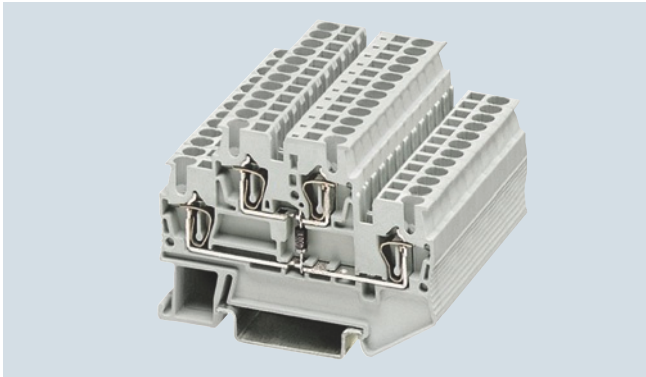

Two-tier diode terminals can be used together with different versions to implement many different wiring tasks.

The following circuits are possible in the tightest spaces:

- Freewheel diode circuits
- Lamp test circuits
- Signaling and fault signaling circuits

The clamping points of two-tier terminals can be inscribed with flat labels.

## Technical specifications

	8WH2020-	5AF00, 5DF00, 5BF00	5HF00, 5FF00, 5KF00 5EF00, 5GF00	5JF30, 5JF80
Dimensions				
• Width/length/cover width in mm		5.2 / 67.5 / 2.2		
• Height (NS 35/7.5 / NS 35/15) in mm		47.5 / 55		
Technical specifications acc. to IEC/DIN VDE				
• Max. load current in A (not via diodes) / cross-section in mm <sup>2</sup>		26 / 4		
• Rated impulse withstand voltage in kV / pollution degree		4 / 3		
• Overvoltage category / molded plastic group		III / I		
Connection capacities				
• Flexible with end sleeve, with plastic sleeve in mm <sup>2</sup>		0.25 ... 2.5		
• Flexible with end sleeve, without plastic sleeve in mm <sup>2</sup>		0.25 ... 2.5		
• Flexible with two-wire connection end sleeve, with plastic sleeve in mm <sup>2</sup>		0.5		
Stripped length in mm		10		
Plug gauge (IEC 60947-1)		A3		
Molded plastic type		PA		
• Flammability Class acc. to UL 94		V0		
Approval data (UL/cUL and CSA)				
• Rated voltage / rated current / conductor sizes				
- UL/cUL: in V/A / AWG			300 / 20 / 26 ... 12	
- CSA: in V/A / AWG			300 / 20 / 26 ... 12	

## Selection and ordering data

Version	DT	Article No. <a href="http://www.siemens.com/product?ArticleNo">www.siemens.com/ product?Article No.</a>	Price per PU	PU (UNIT, SET, M)	PS*/ P. unit	PG
<b>General data</b>						
<b>cULus</b>						

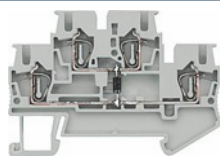
Terminal size 2.5 mm<sup>2</sup>

8WH2020-5AF00



**Two-tier diode terminals, size 2.5 mm<sup>2</sup>, with one diode**

- Terminal width 5.2 mm
- Connection data
  - Rigid 0.08 ... 4 mm<sup>2</sup>, flexible 0.08 ... 2.5 mm<sup>2</sup>, AWG 28-12
  - $I = 26 \text{ A}$ ,  $U = 500 \text{ V}$
- Maximum current determined by diode
- Integrated: diode 1N 4007
  - Blocking voltage: 1300 V, uninterrupted limiting current: 0.5 A

Circuit diagram	Versions	Article No.	Price per PU	PU (UNIT, SET, M)	PS*/P. unit	PG
	Let-through from top to bottom	<b>8WH2020-5AF00</b>		1 50/500 units	1BT	
	Let-through from bottom left to top right	<b>8WH2020-5DF00</b>		1 50 units	1BT	
	Let-through from bottom to top	<b>8WH2020-5BF00</b>		1 50 units	1BT	

## 8WH2 Spring-Loaded Terminals

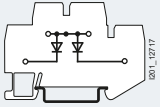
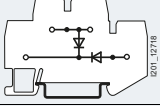
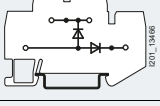
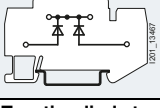
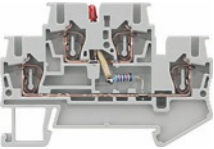
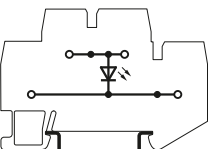
### 8WH two-tier diode terminals

Version	DT	Article No. <a href="http://www.siemens.com/product?Article.No.">www.siemens.com/ product?Article No.</a>	Price per PU	PU (UNIT, SET, M)	PS*/ P. unit	PG
 <p><b>Two-tier diode terminals, terminal size 2.5 mm<sup>2</sup>, with two diodes</b></p> <ul style="list-style-type: none"> <li>Terminal width 5.2 mm</li> <li>Connection data           <ul style="list-style-type: none"> <li>Rigid 0.08 ... 4 mm<sup>2</sup></li> <li>Flexible 0.08 ... 2.5 mm<sup>2</sup></li> <li>AWG 28-12</li> <li><math>I = 26 \text{ A}</math>, <math>U = 500 \text{ V}</math></li> </ul> </li> <li>Maximum current determined by diode</li> <li>Integrated: diode 1N 4007           <ul style="list-style-type: none"> <li>Blocking voltage: 1300 V</li> <li>Uninterrupted limiting current: 0.5 A</li> </ul> </li> </ul>						
<p><b>Circuit diagram</b></p> 	<p><b>Versions</b></p> <p>Let-through from top to bottom left and from top to bottom right</p>	<b>8WH2020-5HF00</b>		1	50/600 units	1BT
	<p>Let-through from top to bottom left and from bottom right to bottom left</p>	<b>8WH2020-5KF00</b>		1	50 units	1BT
	<p>Let-through from bottom left to top and from bottom left to bottom right</p>	<b>8WH2020-5EF00</b>		1	50 units	1BT
	<p>Let-through from bottom left to top and from bottom right to top</p>	<b>8WH2020-5GF00</b>		1	50/600 units	1BT
 <p><b>Two-tier diode terminals, terminal size 2.5 mm<sup>2</sup>, with LED</b></p> <ul style="list-style-type: none"> <li>Terminal width 5.2 mm</li> <li>Connection data           <ul style="list-style-type: none"> <li>Rigid 0.08 ... 4 mm<sup>2</sup></li> <li>Flexible 0.08 ... 2.5 mm<sup>2</sup></li> <li>AWG 28-12</li> <li><math>I = 26 \text{ A}</math></li> <li><math>U = 500 \text{ V}</math></li> </ul> </li> </ul>						
<p><b>Versions</b></p> <ul style="list-style-type: none"> <li>15 ... 30 V DC / 2.5 ... 7.5 A</li> <li>110 ... 230 V AC/DC / 0.5 ... 1.0 A (glow lamp)</li> </ul>		<b>8WH2020-5JF30</b>		1	50 units	1BT
		<b>8WH2020-5JF80</b>		1	50 units	1BT
 <p>8WH2020-5JF30</p>						
<b>Accessories</b>						
 <p>8WH9070-0BA00</p>		<b>Compartment partitions, for terminal size 1.5 ... 4 mm<sup>2</sup></b>		100	50 units	1BT
 <p>8WH9000-1VA00</p>		<b>Covers, for terminal sizes 1.5 and 2.5 mm<sup>2</sup></b>		100	50 units	1BT

For general accessories for 8WH terminal blocks, see chapter "Accessories for 8WH Terminal Blocks"

## 8WH5 Combination Plug-In Terminals

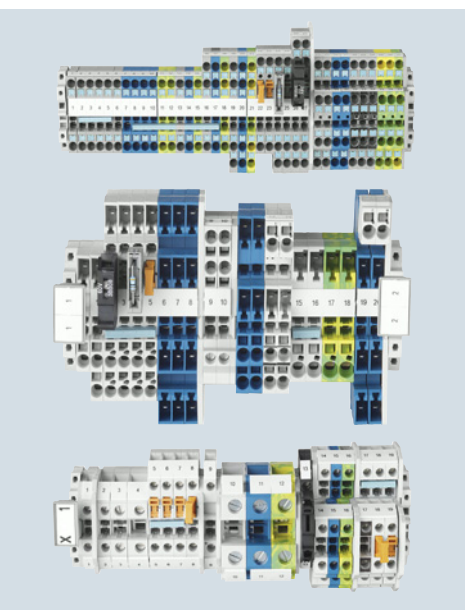

5/2	<b>Introduction</b>
5/5	<b>8WH5 through-type terminals<sup>1)</sup></b>
5/7	<b>8WH5 hybrid through-type terminals with iPo connection</b>
5/8	<b>8WH9 plugs<sup>1)</sup></b>

<sup>1)</sup> Also available as a PE version

**For further technical product information:**

Siemens Industry Online Support:  
[www.siemens.com/lowvoltage/product-support](http://www.siemens.com/lowvoltage/product-support)

- Application example
- Certificate
- Characteristic
- Download
- FAQ
- Manual
- Product note
- Software archive
- Technical data

## 8WH5 Combination Plug-In Terminals

### Introduction

### Overview

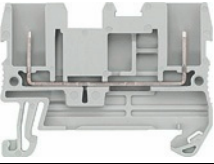
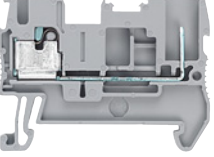
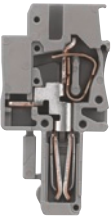
	Devices	Page	Function
	8WH5 through-type terminals	5/5	Terminals for the connection of combination plug-in terminals
	8WH5 hybrid through-type terminals with iPo connection	5/7	Terminals for the connection of combination plug-in terminals
	8WH9 plugs	5/8	For connection of combination plugs for fast wiring

### Features

Conductor cross-section	Terminal type	Terminal type → Design → No. of clamping points → Article No. (digits 1 ... 7) →	Combination plugs		Article No. (digits 8 ... 12)
			Standard	4	
2.5 mm <sup>2</sup>	Color				
	Through-type	Gray	✓	✓	0AF00
		Blue	✓	✓	0AF01
PE	Green/yellow	✓	✓	0CF07	

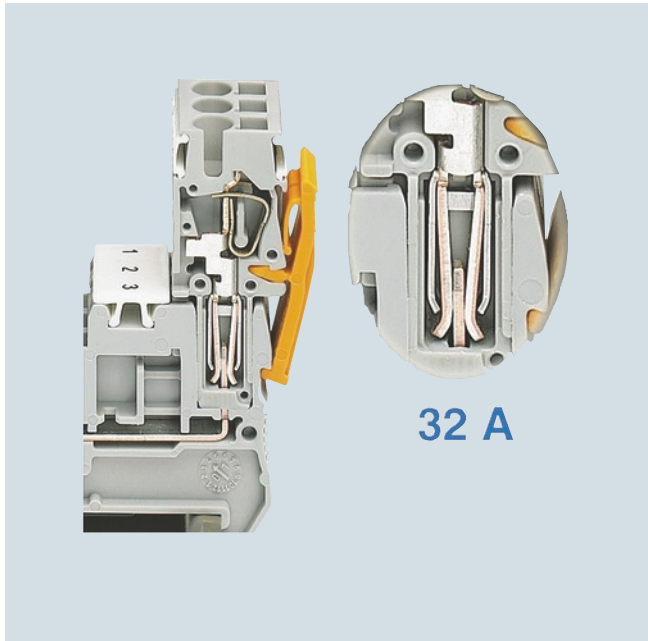
**Benefits****High-performance contact**

The advanced plug-in system of the combination plug-in terminals enables plug-in wiring up to a rated current of 32 A and a rated voltage of 800 V. The contact system withstands extreme vibration thanks to the integral overspring.

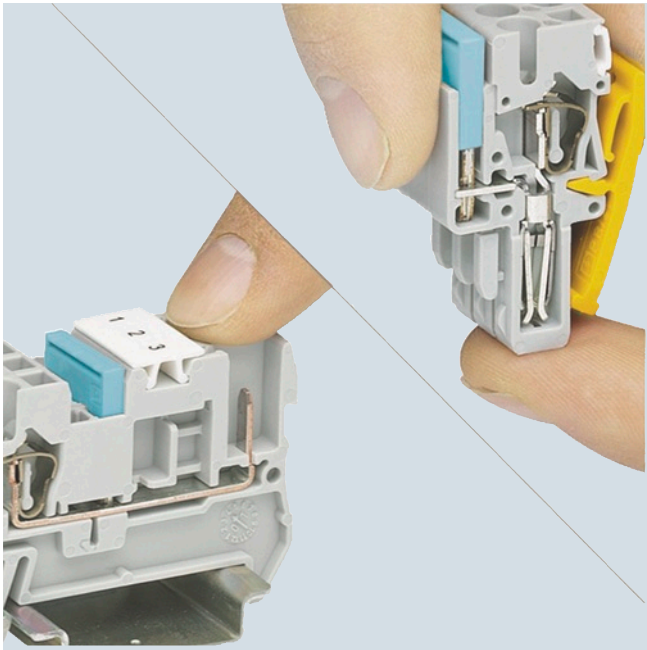
**Fingerproof design**

With its fingerproof base terminals and plugs, the combination plug-in terminal system provides maximum user protection. As well as enhancing safety, this provides exceptional flexibility during configuration: the power can be supplied either through the terminals or the plugs.

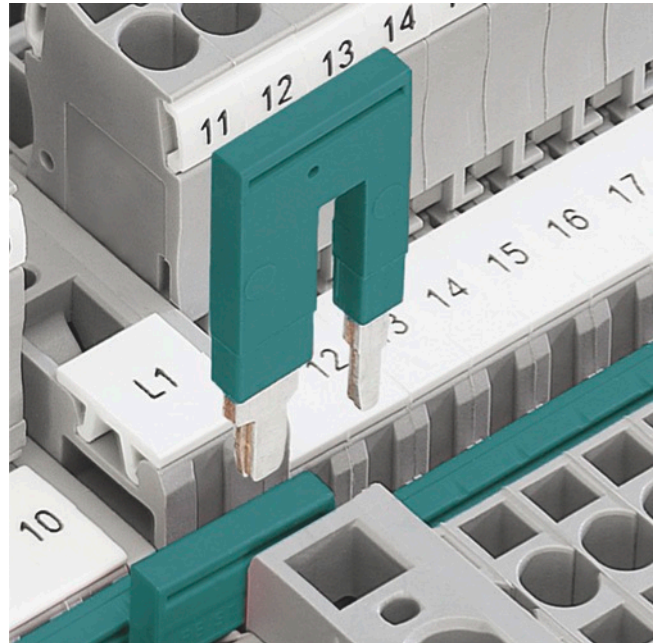
**Time and cost-saving potential distribution**

When feeding in large cross-sections, the reducing comb enables time and cost-saving distribution of the potential. For example, it can link a 10 mm<sup>2</sup> through-type terminal to a 2.5 mm<sup>2</sup> through-type terminal and two clamping points.

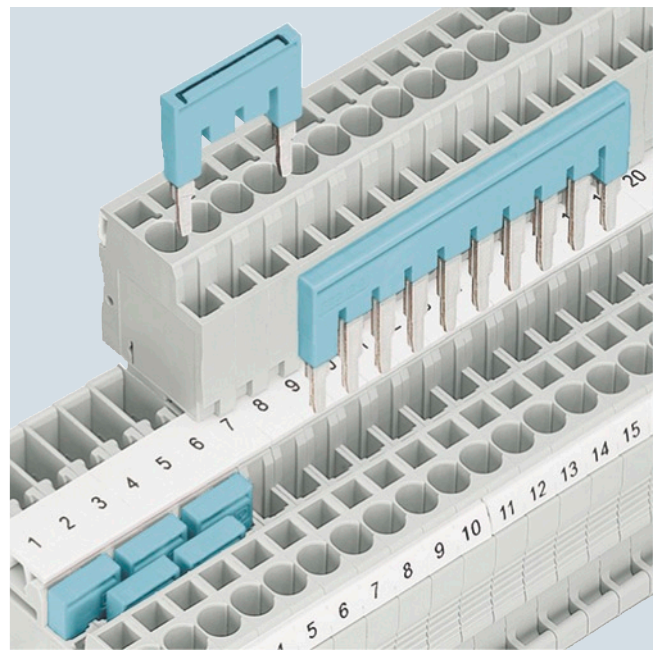
**Standardized connecting comb system**

The standardized connecting comb system allows up to 50 terminals to be connected efficiently and quickly with a single jumper. Teeth can be removed to skip individual terminals.

## 8WH5 Combination Plug-In Terminals

### Introduction

#### Universal plug-in zone

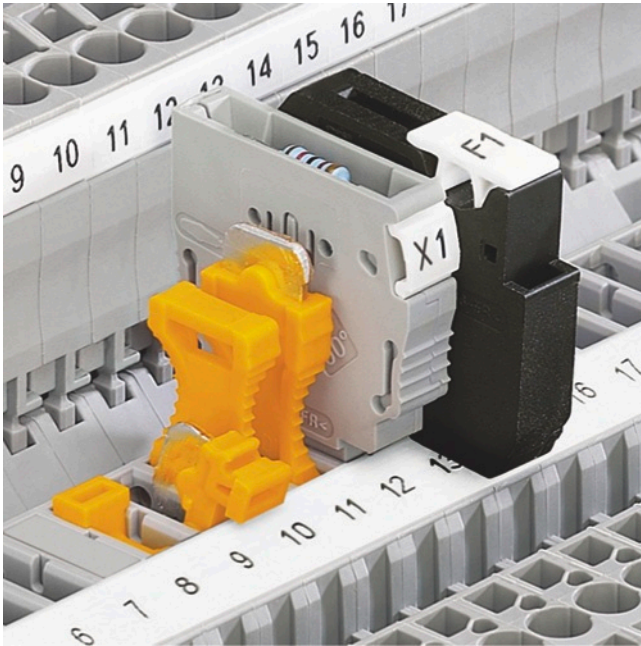

The universal plug-in zone of the isolating terminal can accommodate isolated through-type connectors, isolating plugs, component connectors and fused connectors.

#### Coding the combination plug-in terminals

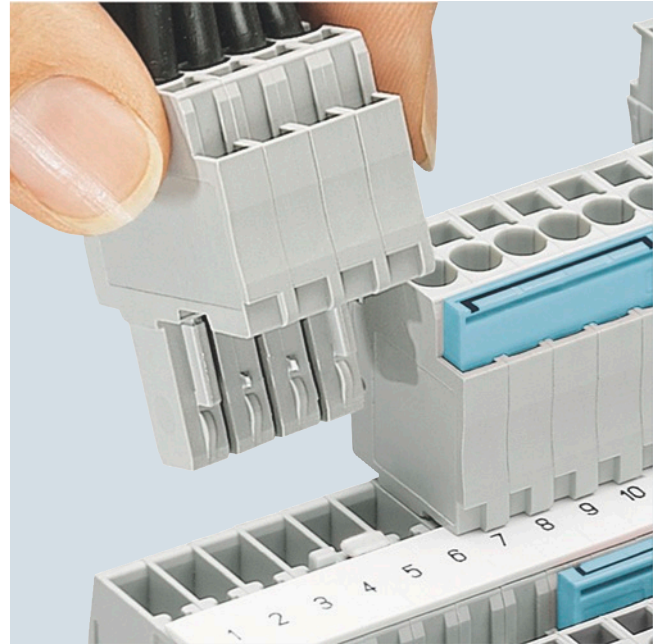

The combination plug-in terminals can be coded with the pin on the plug. The pin is simply removed from the plug, rotated and fitted in the coding position of the base terminal.

#### Assembling test adapters

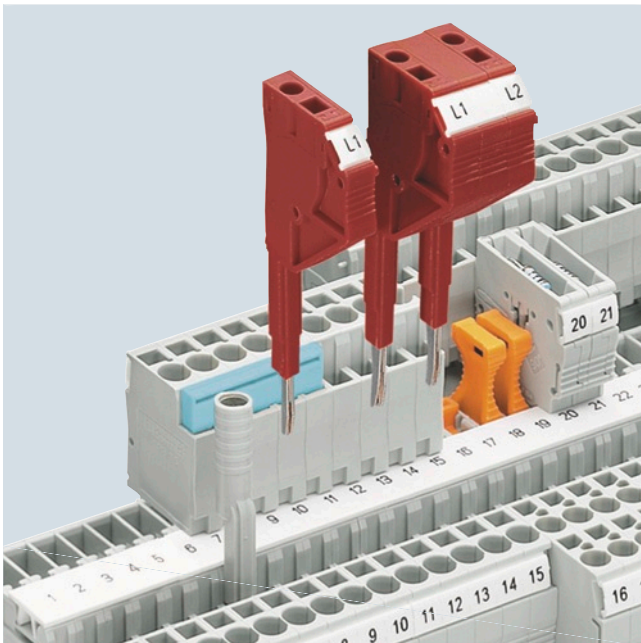

Test adapters are available for  $\varnothing 4$  mm test and safety test plugs. Test plugs can be individually assembled, thanks to the modular design of the test plugs. Measuring leads can be connected over a  $1.5 \text{ mm}^2$  spring-loaded terminal.

#### Snap-on strain relief

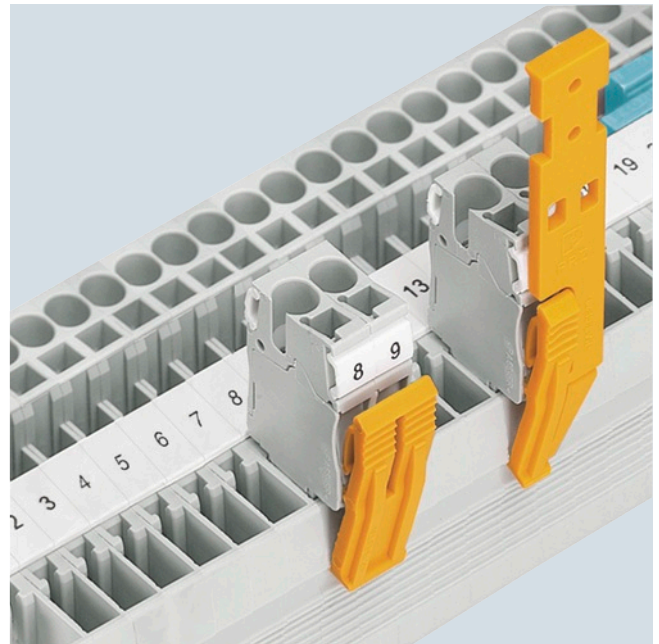

Snap-on clamps are available to relieve cable strain at the plugs. Latches are also available to secure the plugs firmly to the base terminals.



## Overview

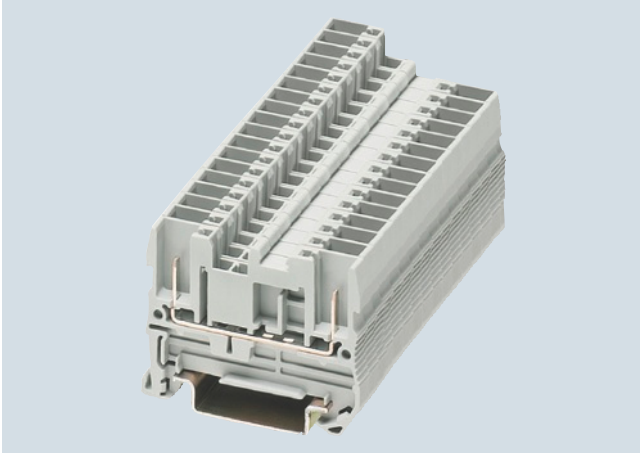

Plugs can be connected at both ends of the terminal using the through-type terminals of the combination plug-in terminals. This makes the combination plug-in terminal system even more flexible and allows the terminals to be used as connecting elements between modules.

The plugs used have a terminal size of 2.5 mm<sup>2</sup>, thus enabling continued use of familiar accessories, such as latches, strain relief and shield connectors.

PE terminals with the same contour are available for the base terminals. These are simply snapped onto the support rail to establish a connection to ground potential.

A label can be snapped on to the middle of each terminal at the front. Further labels can also be mounted flat on the side of the terminals.

## Technical specifications

	8WH5000-0AF00, 8WH5000-0AF01	8WH5000-0CF07
Dimensions		
• Width/length/cover width in mm	5.2 / 48.5 / 2.2	5.2 / 48.5 / 2.2
• Height (TS 35/7.5 / TS 35/15) in mm	36.5 / 44	36.5 / 44
Technical specifications acc. to IEC/DIN VDE		
• Max. load current in A <sup>1)</sup> / cross-section in mm <sup>2</sup>	24 / 4	--
• Rated impulse withstand voltage in kV / pollution degree	6 / 3	
• Overvoltage category / molded plastic group	III / I	
Connection capacities		
• Flexible with end sleeve, with plastic sleeve in mm <sup>2</sup>	0.25 ... 2.5	
• Flexible with end sleeve, without plastic sleeve in mm <sup>2</sup>	0.25 ... 2.5	
• Flexible with two-wire connection end sleeve, with plastic sleeve in mm <sup>2</sup>	0.5	
Molded plastic type	PA	
• Flammability Class acc. to UL 94	V0	
Approval data (UL/cUL and CSA)		
• Rated voltage / rated current / conductor sizes		
- UL/cUL: in V/A / AWG	300 / 20 / --	-- / -- / --
- CSA: in V/A / AWG	--	<a href="#">See page 5/8, section 8WH9 plugs</a>
Support rails/protective conductor busbars	--	<a href="#">See page 1/3, section "Support rails"</a>

1) Derating of the load current is necessary for higher temperatures and/or multi-pole combination plug versions.

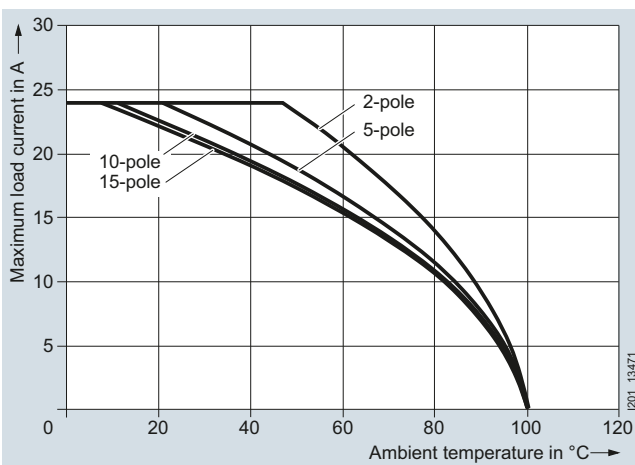



Derating curve for 8WH5000-0AF00

# 8WH5 Combination Plug-In Terminals

## 8WH5 through-type terminals

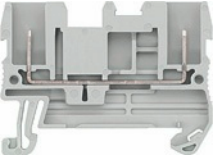
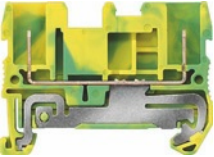
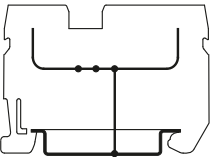
### Selection and ordering data

Version	DT	Article No. <a href="http://www.siemens.com/product?Article No.">www.siemens.com/ product?Article No.</a>	Price per PU	PU (UNIT, SET, M)	PS*/ P. unit	PG
<b>Terminal size 2.5 mm<sup>2</sup></b>						
 <p>8WH5000-0AF00</p>	<b>Through-type terminals, terminal size 2.5 mm<sup>2</sup></b> <ul style="list-style-type: none"> <li>Terminal width 5.2 mm</li> <li>cTUS</li> <li>IEC 61 984               <ul style="list-style-type: none"> <li>- I = 24 A</li> <li>- U = 500 V</li> </ul> </li> </ul>					
	<b>Versions</b> <ul style="list-style-type: none"> <li>Gray               <ul style="list-style-type: none"> <li>- Two clamping points</li> </ul> </li> <li>Blue               <ul style="list-style-type: none"> <li>- Two clamping points</li> </ul> </li> </ul>					
<b>Note</b> On the terminal with four clamping points, the total current through all connected conductors must not exceed the max. load current.		<b>8WH5000-0AF00</b>		1	50 units	1BT
<b>8WH5000-0AF01</b>				1	50 units	1BT
 <p>8WH5000-0CF07</p>	<b>PE through-type terminals, terminal size 2.5 mm<sup>2</sup></b> <ul style="list-style-type: none"> <li>Green/yellow</li> <li>Terminal width 5.2 mm</li> <li>cTUS</li> <li>IEC 61 984</li> </ul>					
	<b>Versions</b> <ul style="list-style-type: none"> <li>Two clamping points</li> </ul>					
 <p>1201_12625 8WH5000-0CF07</p>		<b>8WH5000-0CF07</b>		1	50 units	1BT
<b>Accessories</b>						
 <p>8WH9070-0AA00</p>	<b>Compartment partitions, for terminal size 1.5 ... 4 mm<sup>2</sup></b> <ul style="list-style-type: none"> <li>For visual and electrical separation of terminal groups</li> <li>2 mm thick</li> </ul>					
	<b>Versions</b> <ul style="list-style-type: none"> <li>For two clamping points</li> </ul>					
<b>8WH9070-0AA00</b>				100	50 units	1BT
 <p>8WH9000-1GA00</p>	<b>Covers, for terminal size 2.5 mm<sup>2</sup></b> Gray					
	<b>Versions</b> <ul style="list-style-type: none"> <li>Two clamping points</li> </ul>					
<b>8WH9000-1GA00</b>				100	50 units	1BT

For general accessories for 8WH terminal blocks, see chapter "Accessories for 8WH Terminal Blocks"

## Overview

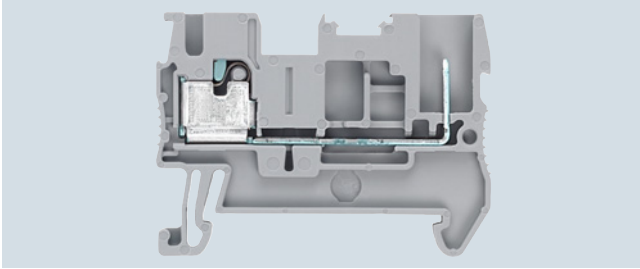

The 8WH5 hybrid through-type terminals with iPo connection provide a modular solution for fast, flexible wiring of plants and machines. They combine the advantages of the combination terminal system with those of the iPo terminals.





A label can be snapped on to the middle of each terminal at the front. Further labels can also be mounted flat on the side of the terminals.

## Technical specifications

	8WH5100-2PF00	8WH5100-3PF07
Dimensions		
• Width/length/cover width in mm	5.2 / 48.5 / 2.2	
• Height (TS 35/7.5 / TS 35/15) in mm	36.5	
Technical specifications acc. to IEC/DIN VDE		
• Max. load current in A <sup>1)</sup> / cross-section in mm <sup>2</sup>	24	--
• Rated impulse withstand voltage in kV / pollution degree	500	--
Connection capacity, 1 conductor		
• Rigid	0.14 ... 2.5	
• Flexible with end sleeve without / with plastic sleeve in mm <sup>2</sup>	0.14 ... 2.5	
Molded plastic type		
• Flammability Class acc. to UL 94	V0	
Approval data (UL/cUL and CSA)		
• Rated voltage / rated current / conductor sizes		
- UL/cUL: in V/A / AWG	500 / 300 / 26 ... 12	
- CSA: in V/A / AWG	-- / --	
Support rails/protective conductor busbars	--	See page 1/3, section "Support rails"

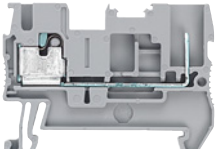
<sup>1)</sup> Derating of the load current is necessary for higher temperatures and/or multi-pole combination plug versions.

## Selection and ordering data

Version	DT	Article No. <a href="http://www.siemens.com/product?Article.No.">www.siemens.com/ product?Article.No.</a>	Price per PU	PU (UNIT, SET, M)	PS*/ P: unit	PG
<b>Hybrid through-type terminals with iPo connection, terminal size 2.5 mm<sup>2</sup></b>						
 <b>Hybrid through-type terminals, terminal size 2.5 mm<sup>2</sup></b> <ul style="list-style-type: none"> <li>• Gray</li> <li>• Terminal width 5.2 mm</li> <li>• Rated current / cross-section <math>I_n = 24</math> A / 2.5 mm<sup>2</sup></li> <li>• Rated voltage <math>U_n = 500</math> V</li> <li>• Rigid 0.14 ... 4 mm<sup>2</sup></li> <li>• Flexible with end sleeve 0.14 ... 2.5 mm<sup>2</sup></li> <li>• Stripped length 10 mm</li> </ul>		<b>8WH5100-2PF00</b>		1	50 units	1BT
 <b>PE hybrid through-type terminals, terminal size 2.5 mm<sup>2</sup></b> <ul style="list-style-type: none"> <li>• Green/yellow</li> <li>• Terminal width 5.2 mm</li> <li>• Rigid 0.14 ... 4 mm<sup>2</sup></li> <li>• Flexible with end sleeve 0.14 ... 2.5 mm<sup>2</sup></li> <li>• Connection type: plug-in spring-loaded connection</li> <li>• Stripped length 10 mm</li> </ul>		<b>8WH5100-3PF07</b>		1	50 units	1BT
<b>Accessories</b>						
 <b>Compartment partitions</b> For terminal size 1.5 ... 4 mm <sup>2</sup> and four clamping points		<b>8WH9070-0HA00</b>		100	50 units	1BT
 <b>Covers</b> For terminal size 2.5 mm <sup>2</sup> and two clamping points		<b>8WH9000-1GA00</b>		100	50 units	1BT

For general accessories for 8WH terminal blocks, see chapter "Accessories for 8WH Terminal Blocks"

\* You can order this quantity or a multiple thereof.

## 8WH5 Combination Plug-In Terminals

### 8WH9 plugs

#### Overview

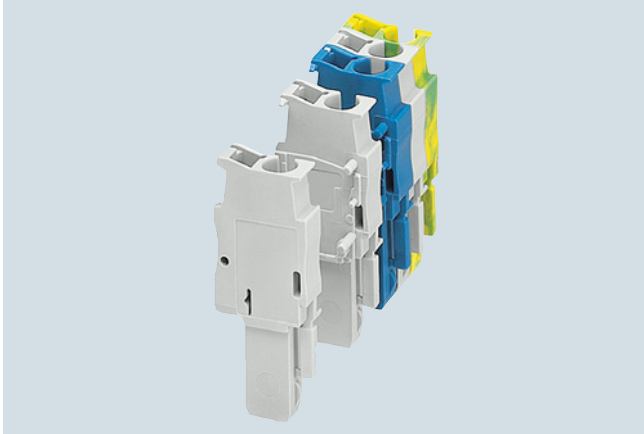

Assembled by the user in-situ from single-pole plug elements, the combination plug-in terminals in kit form provide a customized solution for every task.

For the existing plugs with terminal sizes 2.5 mm<sup>2</sup> and 4 mm<sup>2</sup>, and the plug with comb connection and terminal size 2.5 mm<sup>2</sup>, single-pole basic versions in the colors gray, blue and green-yellow are available.

A left element at the beginning of the plug and a right element at the end are needed for each multi-pole plug. The number of middle elements depends on the plug's required number of poles. The individual elements are simply pushed together and latched with securing pins. Pliers may be needed to push them together. The right-hand component has an integrated cover, which covers the plug block. Labels enable flat inscription of the plugs.

#### Design

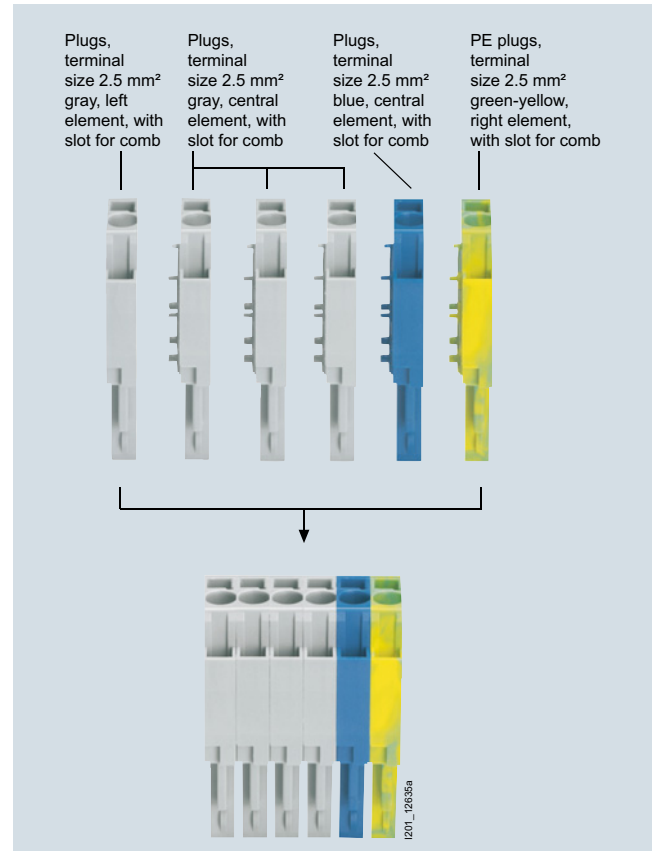

Example of a 6-pole plug

#### Technical specifications



	8WH9040-1AB00 8WH9040-1AB01 8WH9040-1BB00 8WH9040-1BB01 8WH9040-1CB00 8WH9040-1CB01 8WH9040-1DB00 8WH9040-1DB01 8WH9040-1EB00 8WH9040-1EB01 8WH9040-1FB00 8WH9040-1FB01	8WH9040-1AB07 8WH9040-1CB07 8WH9040-1DB07 8WH9040-1EB07 8WH9040-1FB07	8WH9050-1KB00 8WH9050-1KB01 8WH9050-1LB00 8WH9050-1LB01 8WH9050-1MB00 8WH9050-1MB01	8WH9050-1KB07 8WH9050-1LB07 8WH9050-1MB07
Dimensions	--			
• Width/length/cover width in mm	--			
• Height (TS 35/7.5 / TS 35/15) in mm	--			
Technical specifications acc. to IEC/DIN VDE				
• Max. load current in A <sup>1)</sup> / cross-section in A / mm <sup>2</sup>	24 / 4		32 / 6	
• Rated impulse withstand voltage in kV / pollution degree	6 / 3		8 / 3	
• Overvoltage category / molded plastic group	III / I			
Connection capacities				
• Flexible with end sleeve, with plastic sleeve in mm <sup>2</sup>	0.25 ... 2.5		0.25 ... 4	
• Flexible with end sleeve, without plastic sleeve in mm <sup>2</sup>	0.25 ... 2.5		0.25 ... 4	
• Flexible with two-wire connection end sleeve, with plastic sleeve in mm <sup>2</sup>	0.5		0.5 ... 1	
Stripped length	10			
Plug gauge (IEC 60947-1)	A3		A4	
Molded plastic type	PA			
• Flammability Class acc. to UL 94	V0			
Approval data (UL/cUL and CSA)				
• Rated voltage / rated current / conductor sizes				
- UL/cUL: in V/A / AWG	600 / 20 / 26 ... 12		Applied for	
- CSA: in V/A / AWG	--		Applied for	
Support rails/protective conductor busbars	--		--	
			See page 1/3, section 'Support rails'	
			See page 1/3, section 'Support rails'	

<sup>1)</sup> Derating of the load current is necessary for higher temperatures and/or multi-pole combination plug versions.



## 8WH5 Combination Plug-In Terminals

### 8WH9 plugs

Version	DT	Article No. <a href="http://www.siemens.com/product?Article No.">www.siemens.com/ product?Article No.</a>	Price per PU	PU (UNIT, SET, M)	PS*/ P. unit	PG
<b>Accessories</b>						
	<b>Latches</b> Number of poles: 2 Versions		<b>8WH9050-2BA04</b> <b>8WH9050-2AA04</b>	100	50 units	1BT
	<ul style="list-style-type: none"> <li>• With strain relief</li> <li>• Without strain relief</li> </ul>			100	50 units	1BT
	<b>Shielding</b> <ul style="list-style-type: none"> <li>• For connection of shielded cables</li> <li>• For cables with 5 ... 10 mm diameter</li> <li>• Black</li> </ul>		<b>8WH9120-0DB08</b>	1	50 units	1BT

8WH9050-2BA04

8WH9120-DB08

For general accessories for 8WH terminal blocks, see chapter "Accessories for 8WH Terminal Blocks"

## 8WH3 Insulation Displacement Terminals

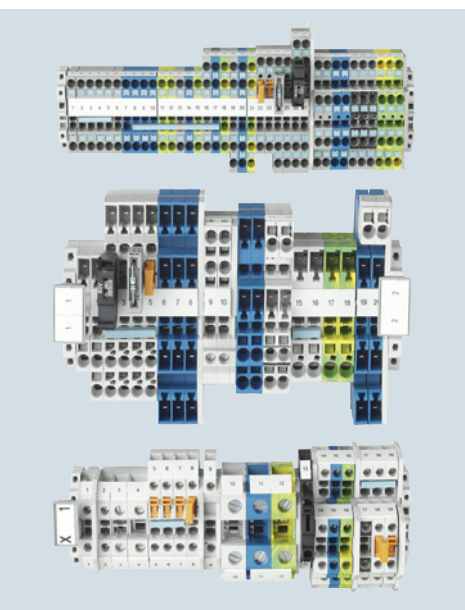

6/2	<b>Introduction</b>
6/5	<b>8WH through-type terminals</b>
6/9	<b>8WH two-tier terminals</b>
6/11	<b>8WH isolating terminals</b>

**For further technical product information:**

Siemens Industry Online Support:  
[www.siemens.com/lowvoltage/product-support](http://www.siemens.com/lowvoltage/product-support)

- Application example
- Certificate
- Characteristic
- Download
- FAQ
- Manual
- Product note
- Software archive
- Technical data

## 8WH3 Insulation Displacement Terminals

### Introduction

#### Overview

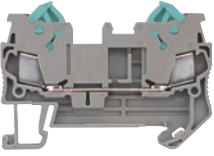
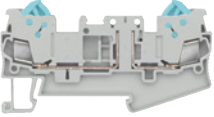
	Devices	Page	Function
	8WH through-type terminals	6/5	Connection up to 2.5 mm <sup>2</sup> of incoming and outgoing conductors
	8WH isolating terminals	6/11	Isolation of the circuit, e.g. for test purposes

1) Only the main terminal types are listed here. You will find further versions on the following pages.

#### Features

Conductor cross-section	Terminal type →		Insulation displacement terminal				Article No. (digits 8 ... 12)
	Design →		Standard		Two-tier		
	No. of clamping points →	Article No. (digits 1 ... 7) →	2	3	4	4	
	Terminal type <sup>1)</sup>	Color	8WH3000	8WH3003	8WH3004	8WH3020	
1.5 mm <sup>2</sup>	Through-type	Gray	✓	✓	✓	✓	0AE00
		Blue	✓	✓	✓	✓	0AE01
	Isolating	Gray	✓	--	--	--	6AE00
		PE	Green/yellow	✓	✓	✓	✓
2.5 mm <sup>2</sup>	Through-type	Gray	✓	✓	--	--	0AF00
		Blue	✓	✓	--	--	0AF01
	Isolating	Gray	✓	--	--	--	6AF00
		PE	Green/yellow	✓	--	--	--

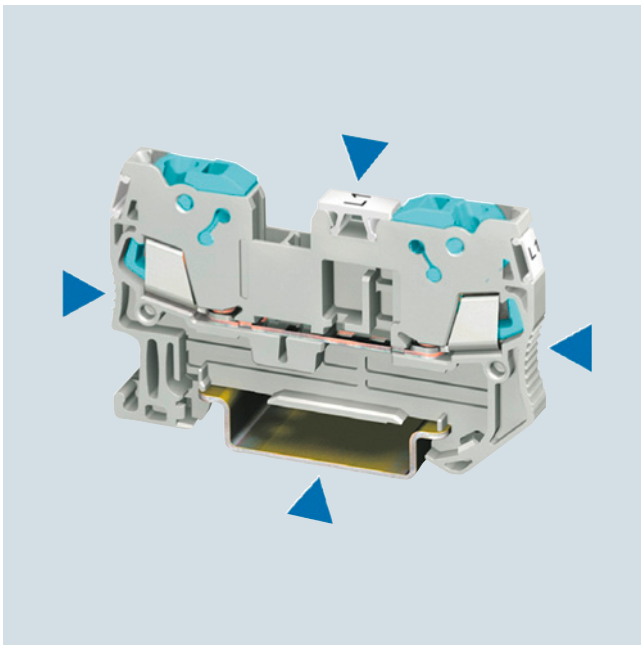

A key feature of the insulation displacement series is its IDC rotary connection. This concept saves considerable space in the control cabinet without impairing other quality features, such as

- Large surface marking
- Maximum connection compartment
- Flexible connecting combs

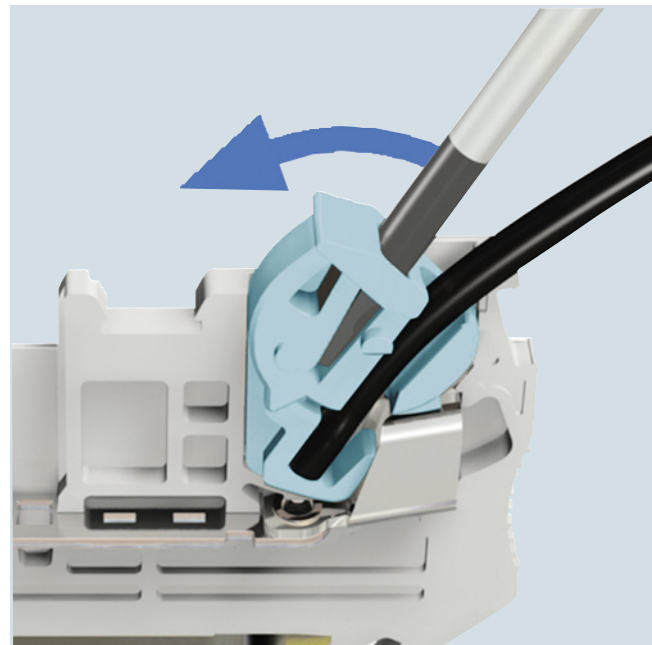

Time savings of 60 % and more compared to other connection systems.

With the quick-connect insulation displacement terminal system, there is no need to strip the insulation or protect the splice. The cables only need to be cut to length for contacting within seconds.



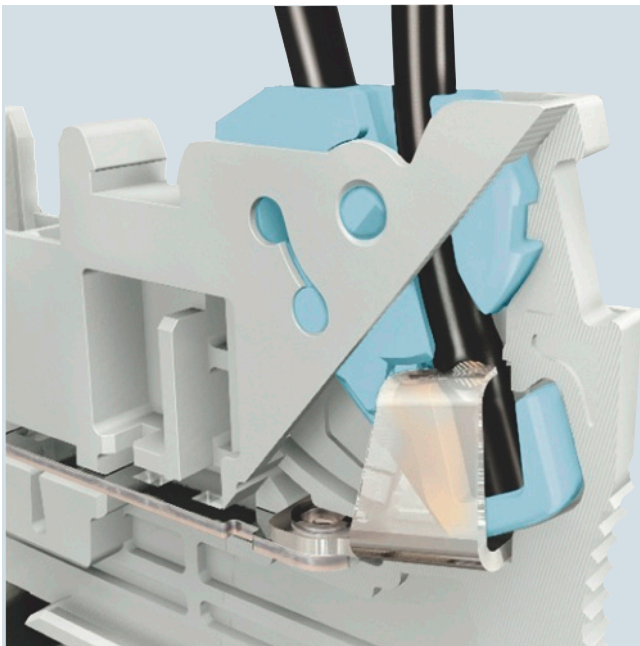

Conductor connections from 0.25 to 2.5 mm<sup>2</sup> are produced by the cutting contact. High-grade special alloys and latching of the switch states ensure reliable electrical connections at all times. Large, spring-loaded contact points ensure 24 A current load rating.

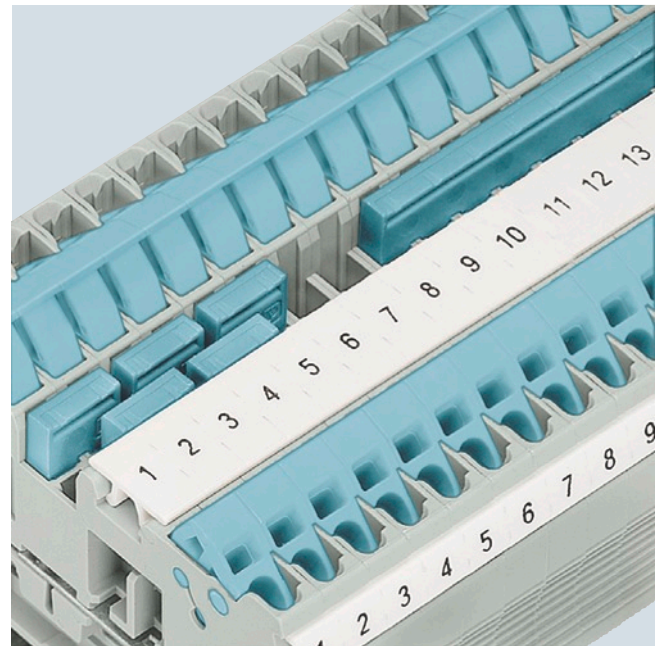

The standardized connecting comb system allows several terminals to be linked efficiently and quickly with a single jumper. The range covers 2- to 50-pole jumpers, which can help considerably to reduce the amount of wiring outlay.

6

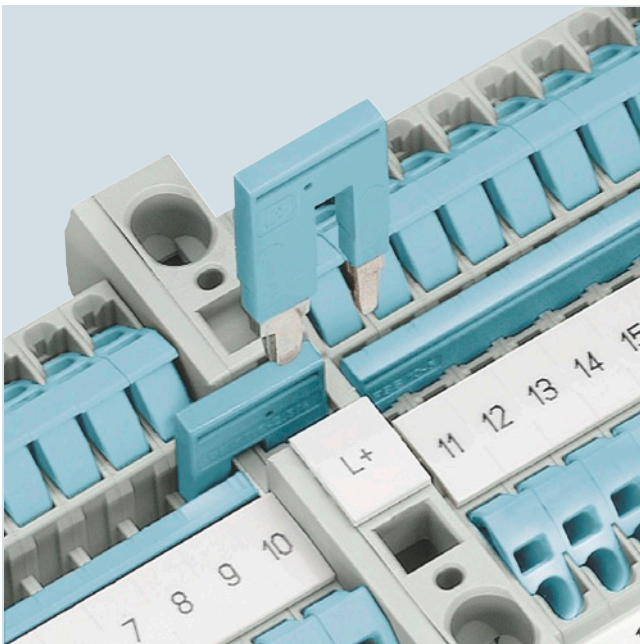

When feeding in large cross-sections, the reducing comb enables time and cost-saving distribution of the potential. For example, it can link a 10 mm<sup>2</sup> spring-loaded through-type terminal to a 1.5 mm<sup>2</sup> insulation displacement through-type terminal and two clamping points – or to a 2.5 mm<sup>2</sup> insulation displacement through-type terminal and two clamping points.

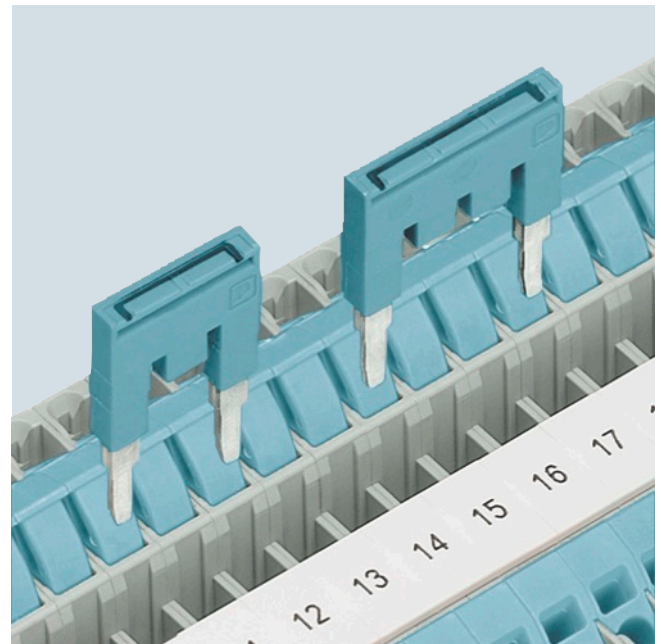

Teeth can be removed from the standard comb in order to skip individual terminals, so that two potentials can run in parallel. A marking option is provided on the top of the connecting comb.

## 8WH3 Insulation Displacement Terminals

### Introduction

6

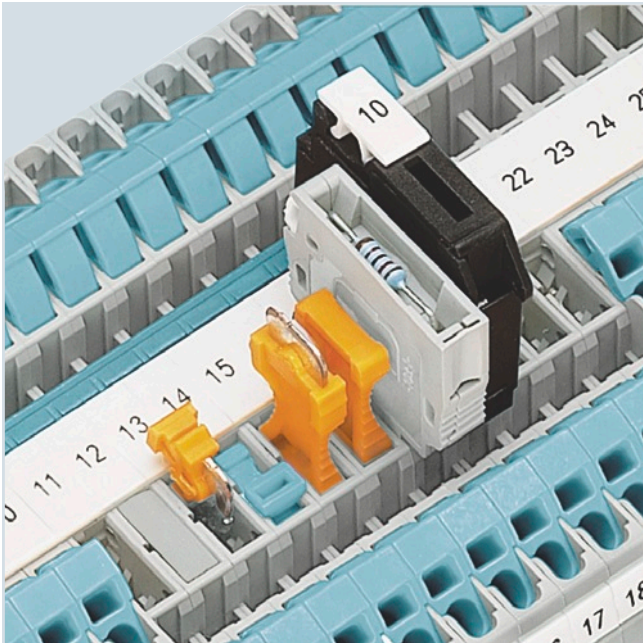

The universal plug-in zone of the isolating terminal can accommodate isolated through-type connectors, isolating plugs, component connectors and fused connectors.

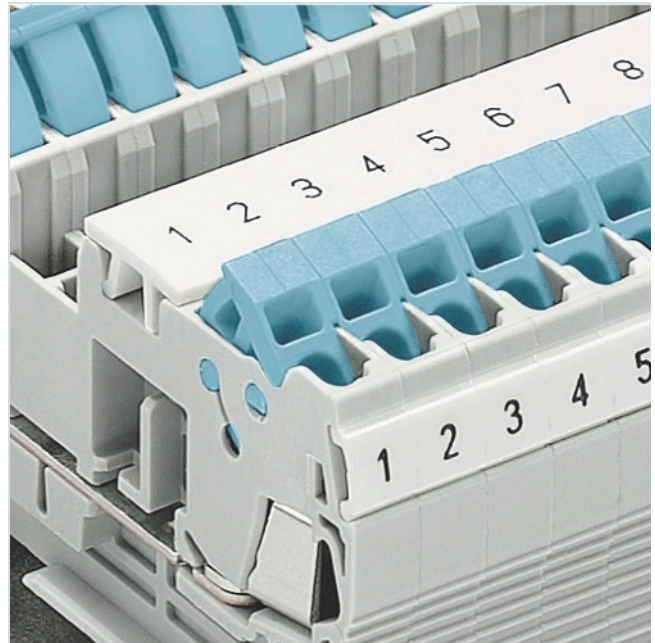

The unambiguous and easy-to-read marking in the center of the terminal is essential for time-saving installation. In addition to the large inscription in the center, each clamping point can also be labeled separately.

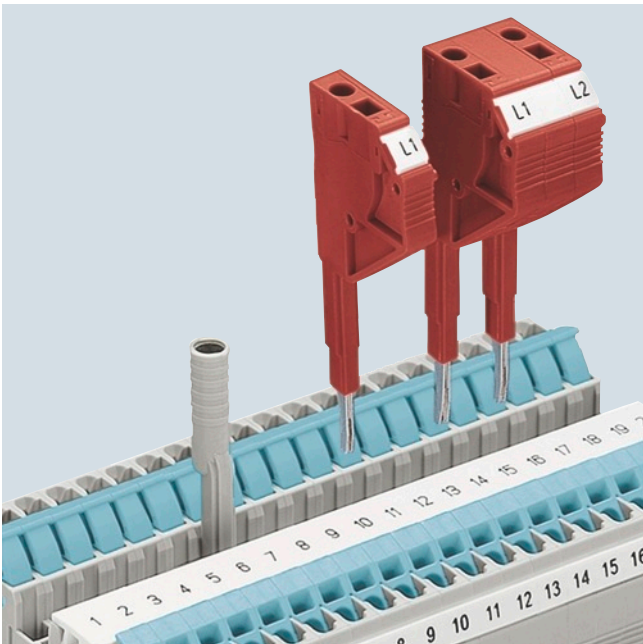

Test adapters are available for Ø 4 mm test and safety test plugs. Test plugs can be individually assembled, thanks to the modular design of the test plugs. Measuring leads can be connected over a 1.5 mm<sup>2</sup> spring-loaded/insulation displacement terminal.

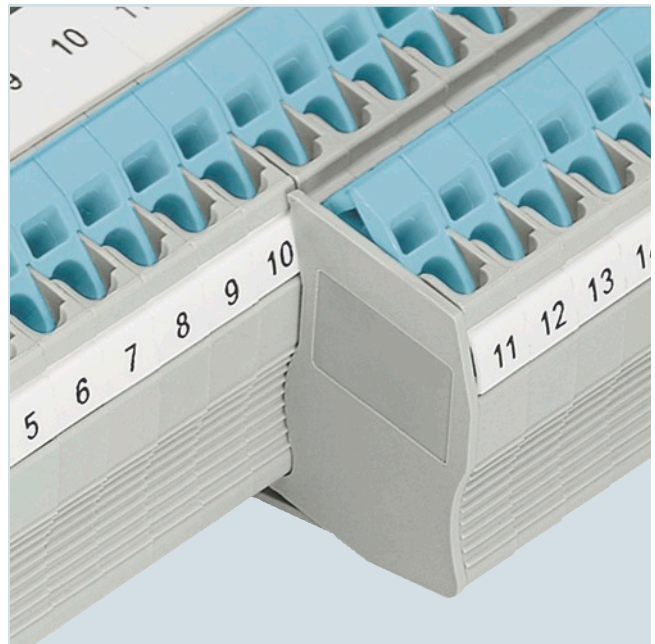

The cover segment is used to cover multi-wire terminals when mounting two-wire terminals side by side. These devices meet all fingerproof requirements.

## Overview

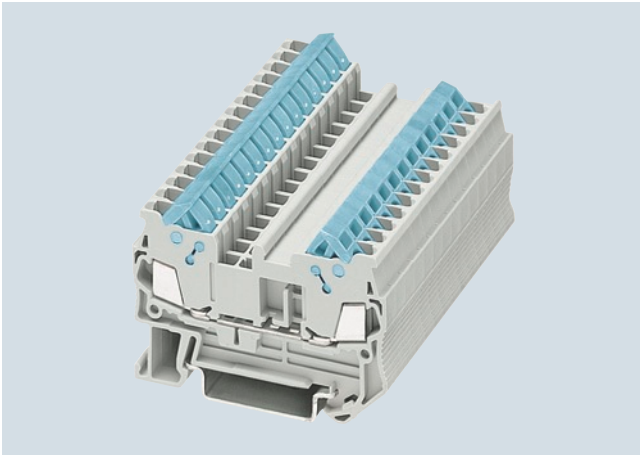

A key feature of the insulation displacement through-type terminal is its compact design. With its clear and space-saving front connection arrangement, this insulation displacement series provides additional space between the cable ducts for wiring. Using the double bridge shaft, it is also possible to use individual chain bridging, as well as a reducing comb, e.g. from a 2.5 mm<sup>2</sup> tension spring through-type terminal to a 35 mm<sup>2</sup> tension spring through-type terminal. Used in this way, reducing combs enable the quick and easy assembly of potential incoming feeders and distributors.

A label can be snapped on to the middle of the terminal at the front. Further labels can also be mounted flat on the side of the terminals.



## Technical specifications

	8WH3000-0AE00 8WH3000-0AE01	8WH3003-0AE00 8WH3003-0AE01	8WH3004-0AE00 8WH3004-0AE01	8WH3000-0CE07	8WH3003-0CE07
Dimensions					
• Width/length/cover width in mm	5.2 / 58.8 / 2.2	5.2 / 76.4 / 2.2	5.2 / 94 / 2.2	5.2 / 58.8 / 2.2	5.2 / 76.4 / 2.2
• Height (TS 35/7.5 / TS 35/15) in mm	39.3 / 46.8				
Technical specifications acc. to IEC/DIN VDE					
• Max. load current in A / cross-section in mm <sup>2</sup>	17.5 / 1.5			--	
• Rated impulse withstand voltage in kV / pollution degree	8 / 3				
• Overvoltage category / molded plastic group	III / I				
Conductor cross-section acc. to DIN VDE 0295					
• Core insulation	PVC / PE (other insulation types on request)				
• Solid/finely stranded H05V-U/R/K / H07V-U/R/K in mm <sup>2</sup>	0.5 ... 1.0 / 1.5				
• Halogen-free H05Z-U/R/K / H07Z-U/R/K in mm <sup>2</sup>	0.5 ... 1.0 / 1.5				
• Finely stranded / very finely stranded					
- (Strand Ø ≥ 0.1 mm) in mm <sup>2</sup>	0.25 ... 0.34				
- (Strand Ø ≥ 0.19 mm) AWG	24-16				
Number of circuits					
• At least 100x the same cross-section in mm <sup>2</sup>	0.25 ... 1.5				
Molded plastic type	PA				
• Flammability Class acc. to UL 94	V0				
Approval data (UL/cUL and CSA)					
• Rated voltage / rated current / conductor sizes					
- UL/cUL: in V/A / AWG	600 / 10 / 24-16			-- / -- / 24-16	
- CSA: in V/A / AWG	--				
Support rails/protective conductor busbars	--				See page 1/3, section "Support rails"
	8WH3004-0CE07	8WH3000-0AF00 8WH3000-0AF01	8WH3003-0AF00 8WH3003-0AF01	8WH3000-0CF07	8WH3003-0CF07
Dimensions					
• Width/length/cover width in mm	5.2 / 94 / 2.2	6.2 / 62.6 / 2.2	6.2 / 82.5 / 2.2	6.2 / 62.6 / 2.2	6.2 / 82.5 / 2.2
• Height (TS 35/7.5 / TS 35/15) in mm	39.3 / 46.8		42.8 / 50.3	39.3 / 46.8	42.8 / 50.3
Technical specifications acc. to IEC/DIN VDE					
• Max. load current in A / cross-section in mm <sup>2</sup>	--	24 / 2.5		--	
• Rated impulse withstand voltage in kV / pollution degree	8 / 3				
• Overvoltage category / molded plastic group	III / I				
Conductor cross-section acc. to DIN VDE 0295					
• Core insulation	PVC / PE (other insulation types on request)				
• Solid/finely stranded H05V-U/R/K / H07V-U/R/K in mm <sup>2</sup>	0.5 ... 1.0 / 1.5	0.5 ... 1.5 / 1.5 ... 2.5			
• Halogen-free H05Z-U/R/K / H07Z-U/R/K in mm <sup>2</sup>	0.5 ... 1.0 / 1.5	0.5 ... 1.5 / 1.5 ... 2.5			
• Finely stranded / very finely stranded					
- (Strand Ø ≥ 0.1 mm) in mm <sup>2</sup>	0.25 ... 0.34	--			
- (Strand Ø ≥ 0.19 mm) AWG	24-16	20-14			
Number of circuits					
• At least 100x the same cross-section in mm <sup>2</sup>	0.25 ... 1.5	0.5 ... 2.5			
Molded plastic type	PA				
• Flammability Class acc. to UL 94	V0				
Approval data (UL/cUL and CSA)					
• Rated voltage / rated current / conductor sizes					
- UL/cUL: in V/A / AWG	-- / -- / 24-16		Applied for		
- CSA: in V/A / AWG	--		Applied for		
Support rails/protective conductor busbars	See page 1/3, section "Support rails"	--			See page 1/3, section "Support rails"





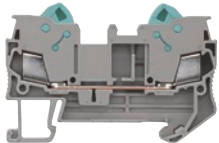

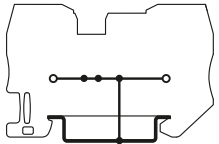
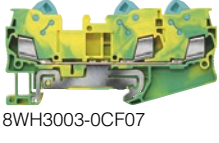
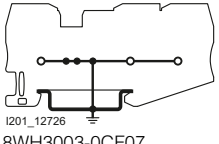

## 8WH3 Insulation Displacement Terminals

## 8WH through-type terminals

Version	DT	Article No. <a href="http://www.siemens.com/product?Article.No.">www.siemens.com/ product?Article No.</a>	Price per PU	PU (UNIT, SET, M)	PS*/ P. unit	PG
<b>Terminal size 2.5 mm<sup>2</sup></b>						
 8WH3000-0AF00						
<b>Through-type terminals, terminal size 2.5 mm<sup>2</sup></b>						
<ul style="list-style-type: none"> <li>Terminal width 6.2 mm</li> <li>Connection data               <ul style="list-style-type: none"> <li>Rigid 0.5 ... 2.5 mm<sup>2</sup></li> <li>Flexible 0.5 ... 2.5 mm<sup>2</sup></li> <li>AWG 20-14</li> <li>I = 24 A</li> <li>U = 800 V</li> </ul> </li> </ul>						
<b>Versions</b>						
<ul style="list-style-type: none"> <li>Gray               <ul style="list-style-type: none"> <li>Two clamping points</li> <li>Three clamping points</li> </ul> </li> <li>Blue               <ul style="list-style-type: none"> <li>Two clamping points</li> <li>Three clamping points</li> </ul> </li> </ul>						
<b>Note</b>						
On terminals with three clamping points, the total current through all connected conductors must not exceed the max. load current.						
		<b>8WH3000-0AF00</b>		1 50 units	1BT	
		<b>8WH3003-0AF00</b>		1 50 units	1BT	
		<b>8WH3000-0AF01</b>		1 50 units	1BT	
		<b>8WH3003-0AF01</b>		1 50 units	1BT	
<b>PE through-type terminals, terminal size 2.5 mm<sup>2</sup></b>						
 8WH3000-0CF07						
 I201_12725 8WH3000-0CF07						
 8WH3003-0CF07						
 I201_12726 8WH3003-0CF07						
<b>Versions</b>						
<ul style="list-style-type: none"> <li>Two clamping points</li> <li>Three clamping points</li> </ul>						
		<b>8WH3000-0CF07</b>		1 50 units	1BT	
		<b>8WH3003-0CF07</b>		1 50 units	1BT	

## 8WH3 Insulation Displacement Terminals

### 8WH through-type terminals

Version	DT	Article No. <a href="http://www.siemens.com/product?Article No.">www.siemens.com/ product?Article No.</a>	Price per PU	PU (UNIT, SET, M)	PS*/ P. unit	PG
<b>Accessories</b>						
 8WH9070-0JA00	<b>Compartment partitions, for terminal size 1.5 ... 2.5 mm<sup>2</sup></b> <ul style="list-style-type: none"> <li>For visual and electrical separation of terminal groups</li> <li>2 mm thick</li> </ul>					
	<b>Versions</b> <ul style="list-style-type: none"> <li>Two clamping points</li> <li>Three clamping points</li> </ul>					
 8WH9070-0KA00	<b>Compartment partitions, for terminal size 1.5 mm<sup>2</sup> and four connection points</b>					
	<b>Versions</b> <ul style="list-style-type: none"> <li>Two clamping points</li> <li>Three clamping points</li> </ul>					
 8WH9070-0LA00	<b>Compartment partitions, for terminal size 1.5 mm<sup>2</sup> and four connection points</b>					
	<b>Versions</b> <ul style="list-style-type: none"> <li>Two clamping points</li> <li>Three clamping points</li> <li>Four clamping points</li> </ul>					
 8WH9001-1AA00	<b>Covers, for terminal size 1.5 mm<sup>2</sup></b> Gray					
	<b>Versions</b> <ul style="list-style-type: none"> <li>Two clamping points</li> <li>Three clamping points</li> <li>Four clamping points</li> </ul>					
 8WH9000-1AA00	<b>Covers, for terminal size 2.5 mm<sup>2</sup></b> Gray					
	<b>Versions</b> <ul style="list-style-type: none"> <li>Two clamping points</li> <li>Three clamping points</li> </ul>					
 8WH9001-0AA00	<b>Cover segments, for three or four clamping points</b> <ul style="list-style-type: none"> <li>Gray</li> <li>For covering multi-wire terminals when mounting two-wire terminals side-by-side</li> </ul>					
	<b>Versions</b> <ul style="list-style-type: none"> <li>For terminal size 2.5 mm<sup>2</sup></li> </ul>					

For general accessories for 8WH terminal blocks, see chapter "Accessories for 8WH Terminal Blocks"

## Overview

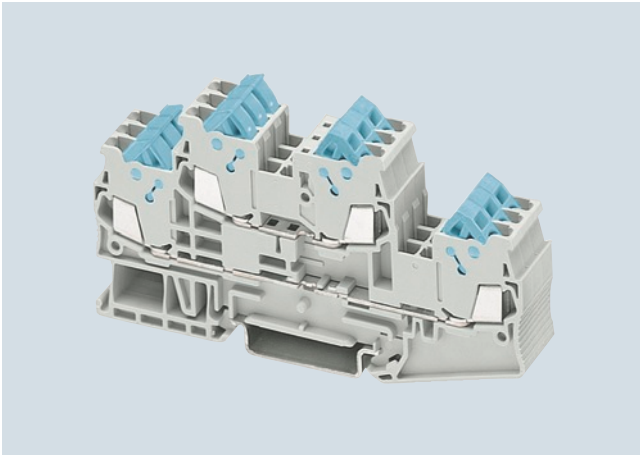

Key features of the IDC two-tier terminals for terminal size 1.5 mm<sup>2</sup> are their ultra compact design and the double bridge shaft for each tier. This enables simultaneous bridging and testing.

With its clear and space-saving front connection arrangement, this two-tier terminal series provides additional space between the cable ducts for wiring.

The PE/ground conductor terminal of this range meets all the requirements of IEC 60 947-7-2.

These include:

- Low contact resistance
- Stainless clamping points and PE mounting foot
- Green-yellow enclosure and
- Additional inscription options

The clamping points of two-tier terminals can be inscribed with flat labels.







## Technical specifications

	8WH3020-0AE00 8WH3020-0AE01	8WH3020-0CE07
Dimensions		
• Width/length/cover width in mm	5.2 / 99.6 / 2.2	
• Height (TS 35/7.5 / TS 35/15) in mm	49.9 / 57.4	
Technical specifications acc. to IEC/DIN VDE		
• Max. load current in A / cross-section in mm <sup>2</sup>	17.5 / 1.5	--
• Rated impulse withstand voltage in kV / pollution degree	6 / 3	
• Overvoltage category / molded plastic group	III / I	
Conductor cross-section acc. to DIN VDE 0295		
• Core insulation	PVC / PE (other insulation types on request)	
• Solid/finely stranded H05V-U/R/K / H07V-U/R/K in mm <sup>2</sup>	0.4 ... 1.0 / 1.5	
• Halogen-free H05Z-U/R/K / H07Z-U/R/K in mm <sup>2</sup>	0.5 ... 1.0 / 1.5	
• Finely stranded / very finely stranded		
- (Strand Ø ≥ 0.1 mm) in mm <sup>2</sup>	0.25 ... 0.34	
- (Strand Ø ≥ 0.19 mm) AWG	24-16	
Number of circuits		
• At least 100x the same cross-section in mm <sup>2</sup>	0.25 ... 1.5	
Molded plastic type	PA	
• Flammability Class acc. to UL 94	V0	
Approval data (UL/cUL and CSA)		
• Rated voltage / rated current / conductor sizes		
- UL/cUL: in V/A / AWG	600 / 10 / 24-16	-- / -- / 24-16
- CSA: in V/A / AWG	--	
Support rails/protective conductor busbars	--	See page 1/3, section "Support rails"

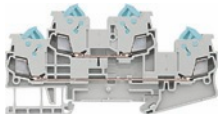
## 8WH3 Insulation Displacement Terminals

### 8WH two-tier terminals

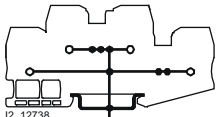
#### Selection and ordering data

Version	DT	Article No. <a href="http://www.siemens.com/product?ArticleNo.">www.siemens.com/ product?Article No.</a>	Price per PU	PU (UNIT, SET, M)	PS*/ P. unit	PG
<b>Terminal size 1.5 mm<sup>2</sup></b>						
 8WH3020-0AE00		<b>Two-tier terminals, terminal size 1.5 mm<sup>2</sup></b> <ul style="list-style-type: none"> <li>Terminal width 5.2 mm</li> <li>            US         </li> <li>           Connection data           <ul style="list-style-type: none"> <li>Rigid 0.25 ... 1.5 mm<sup>2</sup></li> <li>Flexible 0.25 ... 1.5</li> <li>AWG 24-16</li> <li>I = 17.5 A</li> <li>U = 500 V</li> </ul> </li> <li>More information under <i>Technical specifications</i></li> </ul>				
<b>Versions</b>						
<ul style="list-style-type: none"> <li>Gray</li> <li>Blue</li> </ul>		<b>8WH3020-0AE00</b> <b>8WH3020-0AE01</b>		1	50 units	1BT
 8WH3020-0CE07		<b>PE two-tier terminals, terminal size 1.5 mm<sup>2</sup></b> <ul style="list-style-type: none"> <li>Green/yellow</li> <li>Terminal width 5.2 mm</li> <li>            US         </li> <li>           Connection data           <ul style="list-style-type: none"> <li>Rigid 0.25 ... 1.5 mm<sup>2</sup></li> <li>Flexible 0.25 ... 1.5</li> <li>AWG 24-16</li> </ul> </li> <li>More information under <i>Technical specifications</i></li> </ul>		1	50 units	1BT
 8WH3020-0CE07						
<b>Accessories</b>						
 8WH9070-0MA00		<b>Compartment partitions, for terminal size 1.5 mm<sup>2</sup></b>		100	50 units	1BT
 8WH9001-1BA00		<b>Covers, for terminal size 1.5 mm<sup>2</sup></b>		100	50 units	1BT

For general accessories for 8WH terminal blocks, see chapter "Accessories for 8WH Terminal Blocks"



## Overview

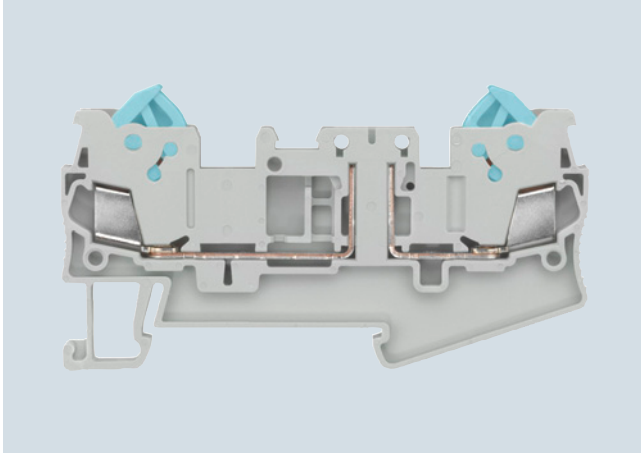

8WH3 isolating terminals using insulation displacement technology are available for special wiring tasks. Numerous wiring tasks can be performed on a terminal width of 5.2 mm by integrating the isolated through-type connector, the isolating plug, the component connector or the fused plug.

A label can be snapped on to the middle of each terminal at the front. Further labels can also be mounted flat on the side of the terminals.

## Technical specifications

	8WH3000-6AE00	8WH3000-6AF00
Dimensions		
• Width/length/cover width in mm	5.2 / 76.4 / 2.2	6.2 / 82.5 / 2.2
• Height (TS 35/7.5 / TS 35/15) in mm	39.3 / 46.8	42.8 / 50.3
Technical specifications acc. to IEC/DIN VDE		
• Max. load current in A / cross-section in mm <sup>2</sup>	16 / 1.5	16 / 2.5
• Rated impulse withstand voltage in kV / pollution degree	6 / 3	
• Overvoltage category / molded plastic group	III / I	
Conductor cross-section acc. to DIN VDE 0295		
• Core insulation	PVC / PE (other insulation types on request)	
• Solid/finely stranded H05V-U/R/K / H07V-U/R/K in mm <sup>2</sup>	0.5 ... 1.0 / 1.5	0.5 ... 1.0 / 1.5 ... 2.5
• Halogen-free H05Z-U/R/K / H07Z-U/R/K in mm <sup>2</sup>	0.5 ... 1.0 / 1.5	0.5 ... 1.0 / 1.5 ... 2.5
• Finely stranded / very finely stranded		
- (Strand Ø ≥ 0.1 mm) in mm <sup>2</sup>	0.25 ... 0.34	--
- (Strand Ø ≥ 0.19 mm) AWG	24-16	20-14
Number of circuits		
• At least 100x the same cross-section in mm <sup>2</sup>	0.25 ... 1.5	0.5 ... 2.5
Molded plastic type	PA	
• Flammability Class acc. to UL 94	V0	
Approval data (UL/cUL and CSA)		
• Rated voltage / rated current / conductor sizes		
- UL/cUL: in V/A / AWG	600 / 10 / 24-16	Applied for
- CSA: in V/A / AWG	600 / 10 / 24-16	Applied for

## Selection and ordering data

Version	DT	Article No. <a href="http://www.siemens.com/product?Article No.">www.siemens.com/ product?Article No.</a>	Price per PU	PU (UNIT, SET, M)	PS* P. unit	PG
---------	----	--	-----------------	-------------------------	----------------	----

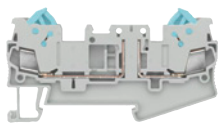
Terminal size 1.5 mm<sup>2</sup>

8WH3000-6AE00

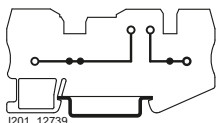
1201\_12739  
8WH3000-6AE00Isolating terminals, terminal size 1.5 mm<sup>2</sup>





- Gray
- Terminal width 5.2 mm
- US
- Connection data
  - Rigid 0.25 ... 1.5 mm<sup>2</sup>
  - Flexible 0.25 ... 1.5 mm<sup>2</sup>
  - AWG 24-16
  - I = 16 A
  - U = 400 V
  - Current and voltage are determined by the fitted plug
- For further information see [Technical specifications](#)

8WH3000-6AE00

1 50 units 1BT

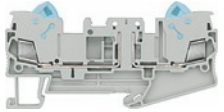
## 8WH3 Insulation Displacement Terminals

### 8WH isolating terminals

Version	DT	Article No. <a href="http://www.siemens.com/product?Article No.">www.siemens.com/ product?Article No.</a>	Price per PU	PU (UNIT, SET, M)	PS*/ P. unit	PG
<b>Terminal size 2.5 mm<sup>2</sup></b>						
 <p>8WH3000-6AF00</p>		<b>Isolating terminals, terminal size 2.5 mm<sup>2</sup></b> <ul style="list-style-type: none"> <li>• Gray</li> <li>• Terminal width 6.2 mm</li> <li>• Connection data               <ul style="list-style-type: none"> <li>- Rigid 0.5 ... 2.5 mm<sup>2</sup></li> <li>- Flexible 0.5 ... 2.5 mm<sup>2</sup></li> <li>- AWG 20-14</li> <li>- <math>I = 16</math> A</li> <li>- <math>U = 400</math> V</li> </ul> </li> <li>• Current and voltage are determined by the fitted plug</li> <li>• More information under <i>Technical specifications</i></li> </ul>				<b>8WH3000-6AF00</b>  1 50 units 1BT
<b>Accessories</b>						
 <p>8WH9070-0KA00</p>		<b>Compartment partitions, for terminal size 1.5 ... 2.5 mm<sup>2</sup> and three clamping points</b>				<b>8WH9070-0KA00</b>  100 50 units 1BT
 <p>8WH9001-2AA00</p>		<b>Covers</b> Versions <ul style="list-style-type: none"> <li>• For terminal size 1.5 mm<sup>2</sup> and three clamping points</li> <li>• For terminal size 2.5 mm<sup>2</sup> and three clamping points</li> </ul>				<b>8WH9001-2AA00</b> <b>8WH9000-2AA00</b>  100 50 units 1BT 100 50 units 1BT
 <p>8WH9001-0AA00</p>		<b>Cover segments</b> Versions <ul style="list-style-type: none"> <li>• For terminal size 1.5 mm<sup>2</sup> and three or four clamping points</li> <li>• For terminal size 2.5 mm<sup>2</sup> and three or four clamping points</li> </ul>				<b>8WH9001-0AA00</b> <b>8WH9000-0AA00</b>  100 50 units 1BT 100 50 units 1BT

For general accessories for 8WH terminal blocks, see chapter "Accessories for 8WH Terminal Blocks"

## 8WH1 Screw Terminals

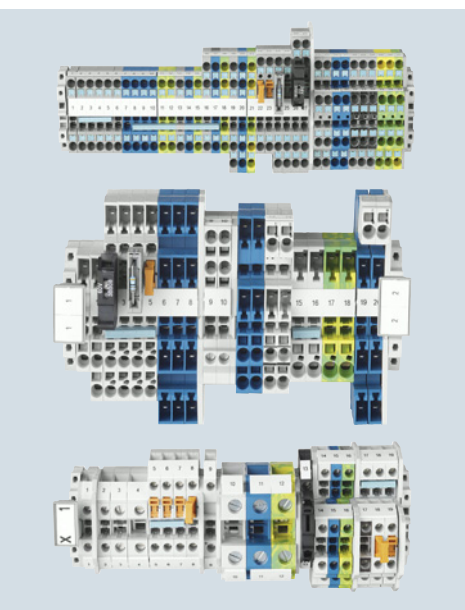

7/2	<b>Introduction</b>
7/3	<b>General data on 8WH</b>
7/4	<b>8WH through-type terminals<sup>1)</sup></b>
7/8	<b>8WH fuse terminals</b>
7/10	<b>8WH isolating blade terminals</b>
7/11	<b>8WH isolating terminals</b>
7/12	<b>8WH two-tier terminals<sup>1)</sup></b>
7/15	<b>8WH two-tier terminals with isolating function/isolating blade</b>
7/17	<b>8WH measuring transformer terminals</b>
7/20	<b>8WH diode terminals</b>
7/21	<b>8WH two-tier diode terminals</b>
7/24	<b>8WH high-current terminals<sup>1)</sup></b>
7/28	<b>8WH shield terminals</b>

<sup>1)</sup> Also available as a PE version

### For further technical product information:





Siemens Industry Online Support:  
[www.siemens.com/lowvoltage/product-support](http://www.siemens.com/lowvoltage/product-support)

→ Application example  
 Certificate  
 Characteristic  
 Download  
 FAQ  
 Manual  
 Product note  
 Software archive  
 Technical data

## 8WH1 Screw Terminals

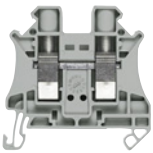
### Introduction

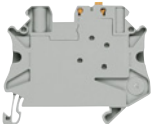
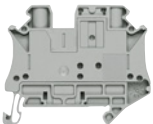
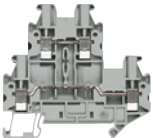
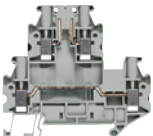
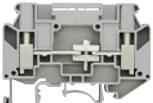
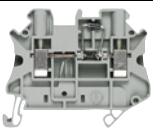
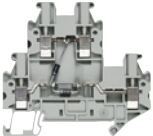
#### Overview

	Devices	Page	Function
	Through-type terminals	7/4	Connection of incoming and outgoing conductors up to 35 mm <sup>2</sup>
	Fuse terminals	7/8	Terminals which can be used to protect control circuits, for example
	Isolating blade terminals	7/10	Isolation of the circuit, e.g. for test purposes
	Isolating terminals	7/11	Isolation of the circuit, e.g. for test purposes
	Two-tier terminals	7/12	Compact form of the terminal block in which two connection wires can be installed
	Two-tier terminals with isolating function	7/15	Compact form of the terminal block in which two connection wires can be installed
	Measuring transformer terminals <b>NEW</b>	7/17	Measuring transformer terminals permit clear and simple tests
	Diode terminals	7/20	Terminal blocks with integrated diodes
	Two-tier diode terminals	7/21	Terminal blocks with integrated diodes
	8WH high-current terminals	7/24	Connection of incoming and outgoing cables from 50 to 240 mm <sup>2</sup>
	8WH shield terminals	7/28	Terminals for connection of shielded cables

## Overview

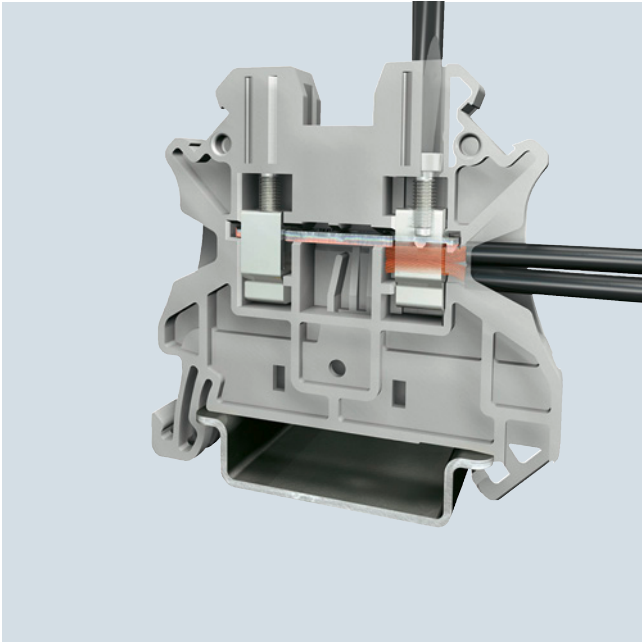

The screw terminal is characterized by its global standard, multi-conductor connection and maintenance-free design.

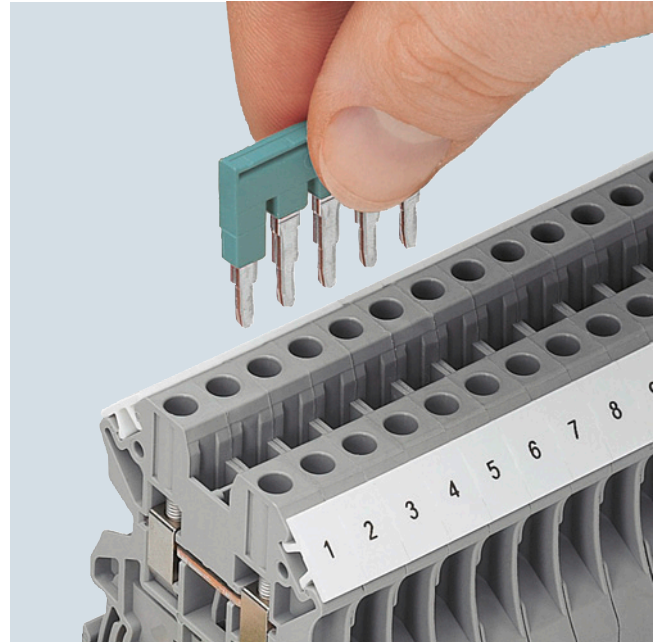

The potential distribution can be quickly implemented with the standardized connecting combs. Flexible chain bridging, level bridging, or skipping of several terminals are possible through two or more bridge shafts in all the terminals.

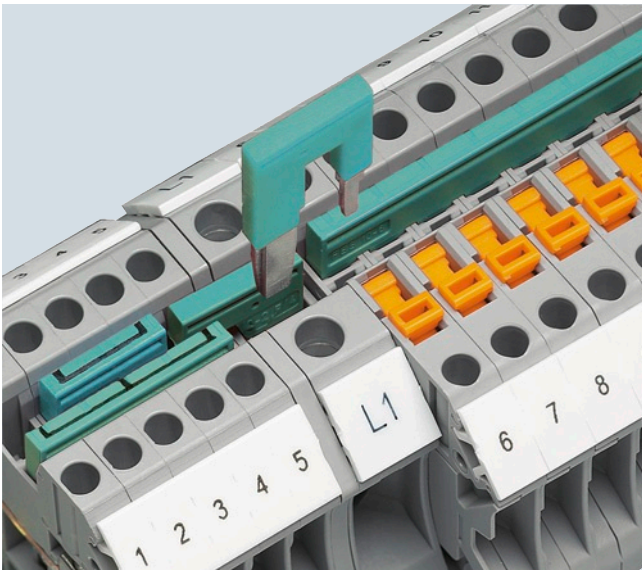

Reducing combs enable easy connection of terminals with various nominal cross-sections and terminal designs. Reducing combs can be used for the quick assembly of infeed blocks.

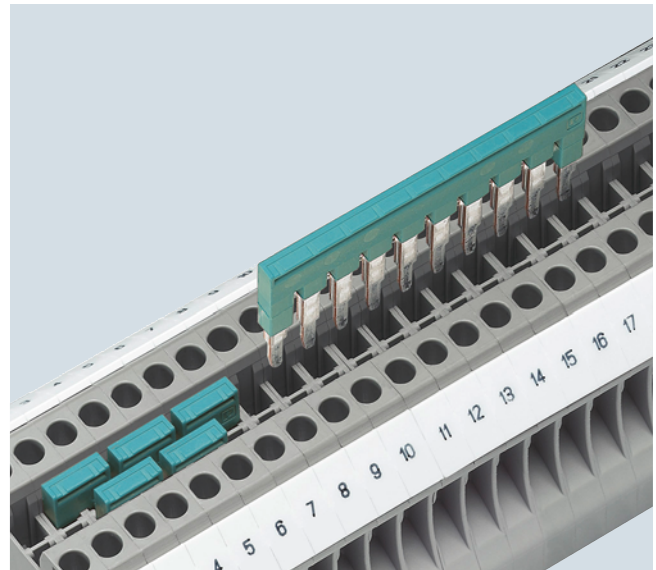

The double bridge shaft enables an assembly of any number of terminals with two-pole jumpers. The 2-pole to 50-pole jumpers enable up to 50 terminals to be connected in a single step.

## 8WH1 Screw Terminals

### 8WH through-type terminals

#### Overview

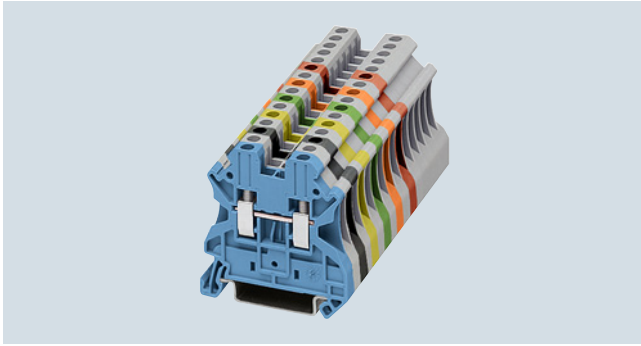









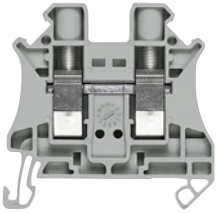

8WH through-type terminals are characterized by their compact design and optimum handling. They are available in conductor cross-section areas from 2.5 to 35 mm<sup>2</sup> and can be inscribed with labels. The double bridge shaft enables individual chain bridging by means of standard connecting combs. Corresponding accessories are available for testing and labeling. Secure electrical and mechanical contact with the support rail is established by simply snapping the terminals onto the rail.

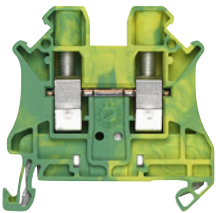
The individual clamping points can be inscribed at the front using the labels.

#### Technical specifications



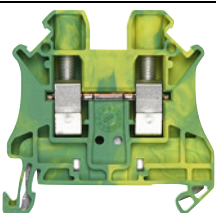







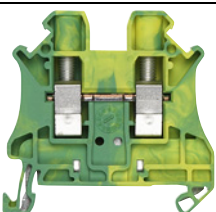

	8WH1000-0AF0.	8WH1000-0AG0.	8WH1000-0AH0.	8WH1000-0AJ0.	8WH1000-0AK0.	8WH1000-0AM0.
<b>Dimensions</b>						
• Width/length/cover width in mm	5.2 / 47.7 / 2.2	6.2 / 47.7 / 2.2	8.2 / 47.7 / 2.2	10.2 / 47.7 / 2.2	12 / 55.3 / 2.2	16 / 60.2 / --
• Height (NS 35/7.5 / NS 35/15) in mm	47.5 / 55				55 / 62.5	65.7 / 73.2
<b>Technical specifications acc. to IEC/DIN VDE</b>						
• Max. load current in A / cross-section in mm <sup>2</sup>	32 / 4	41 / 6	57 / 10	76 / 16	101 / 25	150 / 50
• Rated impulse withstand voltage in kV / pollution degree	8 kV / 3					
• Rated insulation voltage (working voltage) U <sub>i</sub> in V acc. to IEC 60497-7-1	1000					
• Overvoltage category / molded plastic group	III / I					
<b>Connection capacities</b>						
• Flexible with end sleeve, with plastic sleeve in mm <sup>2</sup>	0.25 ... 2.5	0.25 ... 4	0.25 ... 6	0.5 ... 10	1.0 ... 16	1.5 ... 35
• Flexible with end sleeve, without plastic sleeve in mm <sup>2</sup>	0.25 ... 2.5	0.25 ... 4	0.25 ... 6	0.5 ... 10	1.0 ... 16	1.5 ... 35
• Flexible with two-wire connection end sleeve, with plastic sleeve in mm <sup>2</sup>	0.5 ... 1.5	0.5 ... 2.5	0.5 ... 4	0.5 ... 6	0.75 ... 10	1.5 ... 10
• Rigid in mm <sup>2</sup>	0.14 ... 4	0.14 ... 6	0.2 ... 10	0.5 ... 16	1.5 ... 25	1.5 ... 50
Stripped length in mm	9		10		14	
Tightening torque in Nm	0.6 ... 0.8		1.5 ... 1.8		2.5 ... 3.0	
Molded plastic type	PA					
• Flammability Class acc. to UL 94	V0					
<b>Approval data (UL/cUL and CSA)</b>						
• Rated voltage / rated current / conductor sizes						
- UL/cUL: in V/A / AWG	600 / 20 / 26 ... 12	600 / 30 / 26 ... 10	600 / 50 / 24 ... 8	600 / 65 / 20 ... 6	600 / 85 / 16 ... 4	600 / 150 / 14-1/0
- CSA: in V/A / AWG	600 / 20 / 26 ... 12	600 / 30 / 26 ... 10	600 / 50 / 24 ... 8	600 / 65 / 20 ... 6	600 / 85 / 16 ... 4	600 / 150 / 14-1/0
<b>8WH1000-0CF07 8WH1000-0CG07 8WH1000-0CH07 8WH1000-0CJ07 8WH1000-0CK07 8WH1000-0CM07</b>						
<b>Dimensions</b>						
• Width/length/cover width in mm	5.2 / 47.7 / 2.2	6.2 / 47.7 / 2.2	8.2 / 47.7 / 2.2	10.2 / 47.7 / 2.2	12 / 55.3 / 2.2	16 / 60.2 / --
• Height (NS 35/7.5 / NS 35/15) in mm	47.5 / 55				55 / 62.5	65.7 / 73.2
<b>Technical specifications acc. to IEC/DIN VDE</b>						
• Max. load current in A / cross-section in mm <sup>2</sup>	-- / 4	-- / 6	-- / 10	-- / 16	101 / 25	125 / 35
• Rated impulse withstand voltage in kV / pollution degree	8 kV / 3					
• Overvoltage category / molded plastic group	III / I					
<b>Connection capacities</b>						
• Flexible with end sleeve, with plastic sleeve in mm <sup>2</sup>	0.25 ... 2.5	0.25 ... 2.4	0.25 ... 6	0.5 ... 10	1.0 ... 16	1.5 ... 35
• Flexible with end sleeve, without plastic sleeve in mm <sup>2</sup>	0.25 ... 2.5	0.25 ... 2.4	0.25 ... 6	0.5 ... 10	1.0 ... 16	1.5 ... 35
• Flexible with two-wire connection end sleeve, with plastic sleeve in mm <sup>2</sup>	0.5 ... 1.5	0.5 ... 2.5	0.5 ... 4	0.5 ... 6	0.75 ... 10	1.5 ... 10
• Rigid in mm <sup>2</sup>	0.14 ... 4	0.14 ... 6	0.2 ... 10	0.5 ... 16	1.5 ... 25	1.5 ... 35
Stripped length in mm	9		10		14	
Tightening torque in Nm	0.6 ... 0.8		1.6 ... 1.8		2.5 ... 3.0	
Molded plastic type	PA					
• Flammability Class acc. to UL 94	V0					
<b>Approval data (UL/cUL and CSA)</b>						
• Rated voltage / rated current / conductor sizes						
- UL/cUL: in V/A / AWG	-- / -- / 26 ... 12	-- / -- / 26 ... 10	-- / -- / 24 ... 8	-- / -- / 20 ... 6	-- / -- / 16 ... 4	-- / -- / 14-1/0
- CSA: in V/A / AWG	-- / -- / 26 ... 12	-- / -- / 26 ... 10	-- / -- / 24 ... 8	-- / -- / 20 ... 6	-- / -- / 16 ... 4	-- / -- / 14-1/0

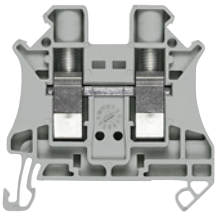
## Selection and ordering data

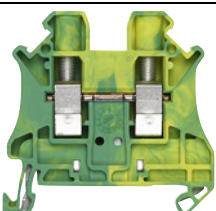
Version	DT	Article No. <a href="http://www.siemens.com/product?ArticleNo.">www.siemens.com/ product?Article No.</a>	Price per PU	PU (UNIT, SET, M)	PS*/ P. unit	PG
<b>Terminal size 2.5 mm<sup>2</sup></b>						
 8WH1000-0AF00	<b>Through-type terminals, terminal size 2.5 mm<sup>2</sup></b> <ul style="list-style-type: none"> <li>•  US, </li> <li>• Terminal width 5.2 mm</li> <li>• <math>I_{max} = 32</math> A</li> <li>• <math>U_{max} = 1000</math> V</li> <li>• AWG 26 ... 12</li> <li>• Connection capacity, one conductor               <ul style="list-style-type: none"> <li>- Rigid 0.14 ... 4 mm<sup>2</sup></li> <li>- Flexible 0.14 ... 4 mm<sup>2</sup></li> </ul> </li> <li>• Connection capacity, two conductors               <ul style="list-style-type: none"> <li>- Rigid 0.14 ... 1.5 mm<sup>2</sup></li> <li>- Flexible 0.14 ... 1.5 mm<sup>2</sup></li> </ul> </li> </ul>					
	<b>Versions</b> <ul style="list-style-type: none"> <li>• Gray</li> <li>• Blue</li> <li>• Red</li> <li>• Black</li> <li>• Yellow</li> <li>• Green</li> <li>• Orange</li> </ul>					
		<b>8WH1000-0AF00</b> <b>8WH1000-0AF01</b> <b>8WH1000-0AF02</b> <b>8WH1000-0AF08</b> <b>8WH1000-0AF06</b> <b>8WH1000-0AF03</b> <b>8WH1000-0AF04</b>		1 50 units	1BT	
 8WH1000-0CF07	<b>PE through-type terminals, terminal size 2.5 mm<sup>2</sup></b> <ul style="list-style-type: none"> <li>•  US, </li> <li>• Terminal width 5.2 mm</li> <li>• AWG 26 ... 12</li> <li>• Connection capacity, one conductor               <ul style="list-style-type: none"> <li>- Rigid 0.14 ... 4 mm<sup>2</sup></li> <li>- Flexible 0.14 ... 4 mm<sup>2</sup></li> </ul> </li> <li>• Connection capacity, two conductors               <ul style="list-style-type: none"> <li>- Rigid 0.14 ... 1.5 mm<sup>2</sup></li> <li>- Flexible 0.14 ... 1.5 mm<sup>2</sup></li> </ul> </li> <li>• Green/yellow</li> </ul>					
	<b>Versions</b> <ul style="list-style-type: none"> <li>• Green/yellow</li> </ul>					
		<b>8WH1000-0CF07</b>		1 50 units	1BT	
<b>Terminal size 4 mm<sup>2</sup></b>						
 8WH1000-0AG00	<b>Through-type terminals, terminal size 4 mm<sup>2</sup></b> <ul style="list-style-type: none"> <li>•  US, </li> <li>• Terminal width 6.2 mm</li> <li>• <math>I_{max} = 41</math> A</li> <li>• <math>U_{max} = 1000</math> V</li> <li>• AWG 26 ... 10</li> <li>• Connection capacity, one conductor               <ul style="list-style-type: none"> <li>- Rigid 0.14 ... 6 mm<sup>2</sup></li> <li>- Flexible 0.14 ... 6 mm<sup>2</sup></li> </ul> </li> <li>• Connection capacity, two conductors               <ul style="list-style-type: none"> <li>- Rigid 0.14 ... 1.5 mm<sup>2</sup></li> <li>- Flexible 0.14 ... 1.5 mm<sup>2</sup></li> </ul> </li> </ul>					
	<b>Versions</b> <ul style="list-style-type: none"> <li>• Gray</li> <li>• Blue</li> <li>• Red</li> <li>• Black</li> <li>• Orange</li> </ul>					
		<b>8WH1000-0AG00</b> <b>8WH1000-0AG01</b> <b>8WH1000-0AG02</b> <b>8WH1000-0AG08</b> <b>8WH1000-0AG04</b>		1 50 units	1BT	
 8WH1000-0CG07	<b>PE through-type terminals, terminal size 4 mm<sup>2</sup></b> <ul style="list-style-type: none"> <li>•  US, </li> <li>• Terminal width 6.2 mm</li> <li>• AWG 26 ... 10</li> <li>• Connection capacity, one conductor               <ul style="list-style-type: none"> <li>- Rigid 0.14 ... 6 mm<sup>2</sup></li> <li>- Flexible 0.14 ... 6 mm<sup>2</sup></li> </ul> </li> <li>• Connection capacity, two conductors               <ul style="list-style-type: none"> <li>- Rigid 0.14 ... 1.5 mm<sup>2</sup></li> <li>- Flexible 0.14 ... 1.5 mm<sup>2</sup></li> </ul> </li> <li>• Green/yellow</li> </ul>					
	<b>Versions</b> <ul style="list-style-type: none"> <li>• Green/yellow</li> </ul>					
		<b>8WH1000-0CG07</b>		1 50 units	1BT	











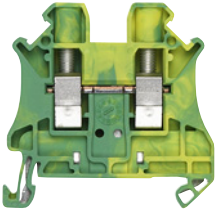

## 8WH1 Screw Terminals

## 8WH through-type terminals

Version	DT	Article No. <a href="http://www.siemens.com/product?Article No.">www.siemens.com/ product?Article No.</a>	Price per PU	PU (UNIT, SET, M)	PS*/ P. unit	PG
<b>Terminal size 6 mm<sup>2</sup></b>						
 <p>8WH1000-0AH00</p>	<b>Through-type terminals, terminal size 6 mm<sup>2</sup></b> <ul style="list-style-type: none"> <li>•  US, </li> <li>• Terminal width 8.2 mm</li> <li>• <math>I_{max} = 57</math> A</li> <li>• <math>U_{max} = 1000</math> V</li> <li>• AWG 24 ... 8</li> <li>• Connection capacity, one conductor <ul style="list-style-type: none"> <li>- Rigid 0.2 ... 10 mm<sup>2</sup></li> <li>- Flexible 0.2 ... 10 mm<sup>2</sup></li> </ul> </li> <li>• Connection capacity, two conductors <ul style="list-style-type: none"> <li>- Rigid 0.2 ... 2.5 mm<sup>2</sup></li> <li>- Flexible 0.2 ... 2.5 mm<sup>2</sup></li> </ul> </li> </ul>					
	<b>Versions</b> <ul style="list-style-type: none"> <li>• Gray</li> <li>• Blue</li> <li>• Red</li> <li>• Black</li> </ul>					
 <p>8WH1000-0CH07</p>	<b>PE through-type terminals, terminal size 6 mm<sup>2</sup></b> <ul style="list-style-type: none"> <li>•  US, </li> <li>• Terminal width 8.2 mm</li> <li>• AWG 24 ... 8</li> <li>• Connection capacity, one conductor <ul style="list-style-type: none"> <li>- Rigid 0.2 ... 10 mm<sup>2</sup></li> <li>- Flexible 0.2 ... 10 mm<sup>2</sup></li> </ul> </li> <li>• Connection capacity, two conductors <ul style="list-style-type: none"> <li>- Rigid 0.2 ... 2.5 mm<sup>2</sup></li> <li>- Flexible 0.2 ... 2.5 mm<sup>2</sup></li> </ul> </li> <li>• Green/yellow</li> </ul>		<b>8WH1000-0CH07</b>			
	<b>Versions</b> <ul style="list-style-type: none"> <li>• Green/yellow</li> </ul>		1 50 units	1BT		
<b>Terminal size 10 mm<sup>2</sup></b>						
 <p>8WH1000-0AJ00</p>	<b>Through-type terminals, terminal size 10 mm<sup>2</sup></b> <ul style="list-style-type: none"> <li>•  US, </li> <li>• Terminal width 10.2 mm</li> <li>• <math>I_{max} = 76</math> A</li> <li>• <math>U_{max} = 1000</math> V</li> <li>• AWG 20-6</li> <li>• Connection capacity, one conductor <ul style="list-style-type: none"> <li>- Rigid 0.5 ... 16 mm<sup>2</sup></li> <li>- Flexible 0.5 ... 16 mm<sup>2</sup></li> </ul> </li> <li>• Connection capacity, two conductors <ul style="list-style-type: none"> <li>- Rigid 0.5 ... 4 mm<sup>2</sup></li> <li>- Flexible 0.5 ... 4 mm<sup>2</sup></li> </ul> </li> </ul>					
	<b>Versions</b> <ul style="list-style-type: none"> <li>• Gray</li> <li>• Blue</li> </ul>					
 <p>8WH1000-0CJ07</p>	<b>PE through-type terminals, terminal size 10 mm<sup>2</sup></b> <ul style="list-style-type: none"> <li>•  US, </li> <li>• Terminal width 10.2 mm</li> <li>• AWG 20-6</li> <li>• Connection capacity, one conductor <ul style="list-style-type: none"> <li>- Rigid 0.5 ... 16 mm<sup>2</sup></li> <li>- Flexible 0.5 ... 16 mm<sup>2</sup></li> </ul> </li> <li>• Connection capacity, two conductors <ul style="list-style-type: none"> <li>- Rigid 0.5 ... 4 mm<sup>2</sup></li> <li>- Flexible 0.5 ... 4 mm<sup>2</sup></li> </ul> </li> <li>• Green/yellow</li> </ul>		<b>8WH1000-0CJ07</b>			
	<b>Versions</b> <ul style="list-style-type: none"> <li>• Green/yellow</li> </ul>		1 50 units	1BT		
<b>Terminal size 16 mm<sup>2</sup></b>						
 <p>8WH1000-0AK00</p>	<b>Through-type terminals, terminal size 16 mm<sup>2</sup></b> <ul style="list-style-type: none"> <li>•  US, </li> <li>• Terminal width 12.2 mm</li> <li>• <math>I_{max} = 101</math> A</li> <li>• <math>U_{max} = 1000</math> V</li> <li>• AWG 16-4</li> <li>• Connection capacity, one conductor <ul style="list-style-type: none"> <li>- Rigid 1.5 ... 25 mm<sup>2</sup></li> <li>- Flexible 1.5 ... 25 mm<sup>2</sup></li> </ul> </li> <li>• Connection capacity, two conductors <ul style="list-style-type: none"> <li>- Rigid 1 ... 6 mm<sup>2</sup></li> <li>- Flexible 1 ... 6 mm<sup>2</sup></li> </ul> </li> </ul>					
	<b>Versions</b> <ul style="list-style-type: none"> <li>• Gray</li> <li>• Blue</li> </ul>					



## 8WH through-type terminals

Version	DT	Article No. <a href="http://www.siemens.com/product?ArticleNo.">www.siemens.com/ product?ArticleNo.</a>	Price per PU	PU (UNIT, SET, M)	PS*/ P. unit	PG
 <p><b>PE through-type terminals, terminal size 16 mm<sup>2</sup></b></p> <ul style="list-style-type: none"> <li>•  US, </li> <li>• Terminal width 12.2 mm</li> <li>• AWG 16-4</li> <li>• Connection capacity, one conductor <ul style="list-style-type: none"> <li>- Rigid 1.5 ... 25 mm<sup>2</sup></li> <li>- Flexible 1.5 ... 25 mm<sup>2</sup></li> </ul> </li> <li>• Connection capacity, two conductors <ul style="list-style-type: none"> <li>- Rigid 1 ... 6 mm<sup>2</sup></li> <li>- Flexible 1 ... 6 mm<sup>2</sup></li> </ul> </li> <li>• Green/yellow</li> </ul> <p>8WH1000-0CK07</p>		<b>8WH1000-0CK07</b>		1 50 units		1BT
 <p><b>Through-type terminals, terminal size 35 mm<sup>2</sup></b></p> <ul style="list-style-type: none"> <li>•  US, </li> <li>• Terminal width 16 mm</li> <li>• <math>I_{max} = 150</math> A</li> <li>• <math>U_{max} = 1000</math> V</li> <li>• AWG 16-1/0</li> <li>• Connection capacity, one conductor <ul style="list-style-type: none"> <li>- Rigid 1.5 ... 50 mm<sup>2</sup></li> <li>- Flexible 1.5 ... 50 mm<sup>2</sup></li> </ul> </li> <li>• Connection capacity, two conductors <ul style="list-style-type: none"> <li>- Rigid 1.5 ... 16 mm<sup>2</sup></li> <li>- Flexible 1.5 ... 10 mm<sup>2</sup></li> </ul> </li> <li>• Enclosed at both ends</li> </ul> <p>8WH1000-0AM00</p>						
<p>Versions</p> <ul style="list-style-type: none"> <li>• Gray</li> <li>• Blue</li> </ul>		<b>8WH1000-0AM00</b> <b>8WH1000-0AM01</b>		1 50 units 1 50 units		1BT 1BT
 <p><b>PE through-type terminals, terminal size 35 mm<sup>2</sup></b></p> <ul style="list-style-type: none"> <li>•  US, </li> <li>• Terminal width 16 mm</li> <li>• AWG 16-2</li> <li>• Connection capacity, one conductor <ul style="list-style-type: none"> <li>- Rigid 1.5 ... 35 mm<sup>2</sup></li> <li>- Flexible 1.5 ... 35 mm<sup>2</sup></li> </ul> </li> <li>• Connection capacity, two conductors <ul style="list-style-type: none"> <li>- Rigid 1.5 ... 16 mm<sup>2</sup></li> <li>- Flexible 1.5 ... 10 mm<sup>2</sup></li> </ul> </li> <li>• Enclosed at both ends</li> <li>• Green/yellow</li> </ul> <p>8WH1000-0CM07</p>		<b>8WH1000-0CM07</b>		1 50 units		1BT
<p><b>Accessories</b></p>  <p><b>Covers, for through-type terminals</b></p> <ul style="list-style-type: none"> <li>• 2.2 mm wide</li> <li>• Gray</li> </ul> <p>8WH9000-1PA00</p>						
<p>Versions</p> <ul style="list-style-type: none"> <li>• For terminal size 2.5 ... 10 mm<sup>2</sup></li> <li>• For terminal size 16 mm<sup>2</sup></li> </ul>		<b>8WH9000-1PA00</b> <b>8WH9076-1PA00</b>		100 50 units 100 50 units		1BT 1BT
 <p><b>Reducing combs, for connecting terminals, for 8WH1</b></p> <p>8WH9002-8AC10</p>						
<p>Versions</p> <ul style="list-style-type: none"> <li>• From terminal size 6 mm<sup>2</sup> to 2.5 or 4 mm<sup>2</sup> <ul style="list-style-type: none"> <li>- From screw to screw</li> <li>- From screw to spring</li> </ul> </li> <li>• From terminal size 10 mm<sup>2</sup> to 2.5 or 4 mm<sup>2</sup> <ul style="list-style-type: none"> <li>- From screw to screw</li> <li>- From screw to spring</li> </ul> </li> <li>• From terminal size 16 mm<sup>2</sup> to 2.5 or 4 mm<sup>2</sup> <ul style="list-style-type: none"> <li>- From screw to screw</li> <li>- From screw to spring</li> </ul> </li> <li>• From terminal size 35 mm<sup>2</sup> to 2.5 or 4 mm<sup>2</sup> <ul style="list-style-type: none"> <li>- From screw to screw</li> <li>- From screw to spring</li> </ul> </li> </ul>		<b>8WH9002-8AC10</b> <b>8WH9002-8BC10</b> <b>8WH9002-8CC10</b> <b>8WH9002-8DC10</b> <b>8WH9002-8EC10</b> <b>8WH9002-8FC10</b> <b>8WH9002-8GC10</b> <b>8WH9002-8HC10</b>		1 10 units 1 10 units 1 10 units 1 10 units 1 10 units 1 10 units 1 10 units 1 10 units		1BT 1BT 1BT 1BT 1BT 1BT 1BT 1BT
<p><b>Compartment partitions, for through-type terminals, for terminal size 2.5 ... 10 mm<sup>2</sup>, for 8WH1</b></p> <ul style="list-style-type: none"> <li>• For visual and electrical separation of terminal groups</li> <li>• 2 mm thick</li> </ul>		<b>8WH9070-6BA00</b>		100 50 units		1BT
 <p><b>Warning covers, for 8WH1</b></p> <ul style="list-style-type: none"> <li>• Lightning symbol, yellow</li> </ul> <p>8WH9066-5BA06</p>						
<p>Versions</p> <ul style="list-style-type: none"> <li>• For terminal size 2.5 mm<sup>2</sup>, width 5.2 mm</li> <li>• For terminal size 4 mm<sup>2</sup>, width 6.2 mm</li> <li>• For terminal size 6 mm<sup>2</sup>, width 8.2 mm</li> <li>• For terminal size 10 mm<sup>2</sup>, width 10.2 mm</li> <li>• For terminal size 16 mm<sup>2</sup>, width 12.2 mm</li> <li>• For terminal size 35 mm<sup>2</sup>, width 16 mm</li> </ul>		<b>8WH9060-5BA06</b> <b>8WH9063-5BA06</b> <b>8WH9064-5BA06</b> <b>8WH9065-5BA06</b> <b>8WH9066-5BA06</b> <b>8WH9067-5BA06</b>		100 50 units 100 50 units 100 50 units 100 50 units 100 50 units 100 50 units		1BT 1BT 1BT 1BT 1BT 1BT

\* You can order this quantity or a multiple thereof.

## 8WH1 Screw Terminals

### 8WH fuse terminals

#### Overview

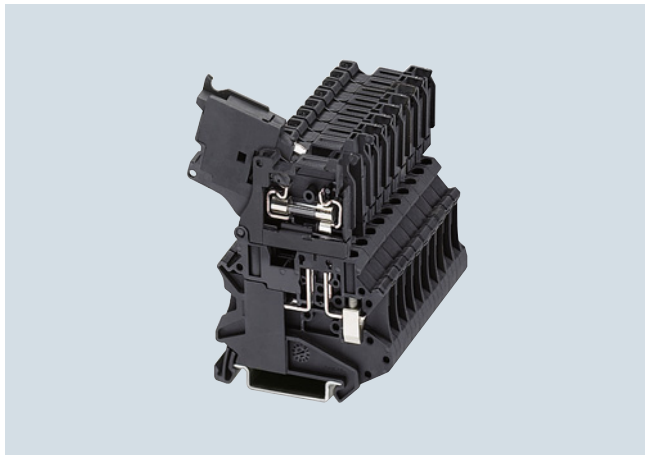

The 8WH fuse terminals adopt the function of the fuse holders for 5 × 20 mm and 6.3 × 32 mm G fuse links and all potential distribution tasks with the double bridge shaft.

The individual clamping points can be inscribed at the front using labels.





7

#### Technical specifications

	8WH1000-1GG08	8WH1000-1KG38	8WH1000-1MG88	8WH1000-1HH08	8WH1000-1PH38
Dimensions					
• Width/length/cover width in mm	6.2 / 57.8 / --			8.2 / 57.8 / --	
• Height (NS 35/7.5 / NS 35/15) in mm	73 / 80.5				
Technical specifications acc. to IEC/DIN VDE					
• Max. load current in A <sup>1)</sup> / cross-section in mm <sup>2</sup>	6.3 / 6			10 / 10	
• Rated impulse withstand voltage in kV / pollution degree	6 kV / 3			8 kV / 3	
• Rated insulation voltage (working voltage) $U_i$ in V	500			630	
acc. to IEC 60497-7-1					
• Overvoltage category / molded plastic group	III / I			6 kV / 3	
Connection capacities					
• Flexible with end sleeve, with plastic sleeve in mm <sup>2</sup>	0.25 ... 4			0.25 ... 6	
• Flexible with end sleeve, without plastic sleeve in mm <sup>2</sup>	0.25 ... 4			0.25 ... 6	
• Flexible with two-wire connection end sleeve, with plastic sleeve in mm <sup>2</sup>	0.5 ... 2.5			0.5 ... 4	
• Rigid in mm <sup>2</sup>	0.14 ... 6			0.2 ... 10	
Stripped length in mm	9			10	
Tightening torque in Nm	0.6 ... 0.8			1.5 ... 1.8	
Molded plastic type	PA				
• Flammability Class acc. to UL 94	V0				
Approval data (UL/cUL and CSA)					
• Rated voltage / rated current / conductor sizes					
- UL/cUL: in V/A / AWG	600 / 6.3 / 26 ... 10			600 / 16 / 24 ... 8	
- CSA: in V/A / AWG	600 / 6.3 / 26 ... 10			-- / -- / --	

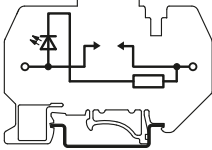
<sup>1)</sup> Please observe the maximum power loss.

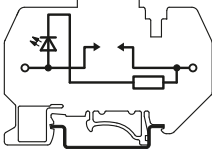
## Selection and ordering data

Version	DT	Article No. <a href="http://www.siemens.com/product?Article No.">www.siemens.com/ product?Article No.</a>	Price per PU	PU (UNIT, SET, M)	PS*/ P. unit	PG
<b>Terminal size 4 mm<sup>2</sup></b>						
 8WH1000-1GG08  I201_12681 8WH1000-1MG88	<b>Fuse terminals, terminal size 4 mm<sup>2</sup>, for 5 x 20 mm G fuse links</b> <ul style="list-style-type: none"> <li>•  US</li> <li>• Terminal width 6.2 mm</li> <li>• <math>I_{max} = 6.3</math> A</li> <li>• <math>U_{max} = 500</math> V</li> <li>• AWG 26 ... 10</li> <li>• Connection capacity, one conductor               <ul style="list-style-type: none"> <li>- Rigid 0.14 ... 6 mm<sup>2</sup></li> <li>- Flexible 0.14 ... 6 mm<sup>2</sup></li> </ul> </li> <li>• Connection capacity, two conductors               <ul style="list-style-type: none"> <li>- Rigid 0.14 ... 1.5 mm<sup>2</sup></li> <li>- Flexible 0.14 ... 1.5 mm<sup>2</sup></li> </ul> </li> <li>• Enclosed at both ends</li> <li>• Black</li> </ul>					
	<b>Versions</b> <ul style="list-style-type: none"> <li>• Without LED</li> <li>• With LED 10 ... 30 V AC/DC</li> <li>• With LED 110 ... 250 V AC/DC</li> </ul>					
		<b>8WH1000-1GG08</b> <b>8WH1000-1KG38</b> <b>8WH1000-1MG88</b>		1 50 units 1 50 units 1 50 units	1BT 1BT 1BT	
<b>Terminal size 6 mm<sup>2</sup></b>						
 8WH1000-1HH08  I201_12681 8WH1000-1PH38	<b>Fuse terminals, terminal size 6 mm<sup>2</sup>, for G fuse links 6.3 x 32 mm (inch fuses)</b> <ul style="list-style-type: none"> <li>•  US</li> <li>• Terminal width 8.2 mm</li> <li>• <math>I_{max} = 10</math> A</li> <li>• <math>U_{max} = 630</math> V</li> <li>• AWG 24 ... 8</li> <li>• Connection capacity, one conductor               <ul style="list-style-type: none"> <li>- Rigid 0.2 ... 10 mm<sup>2</sup></li> <li>- Flexible 0.2 ... 10 mm<sup>2</sup></li> </ul> </li> <li>• Connection capacity, two conductors               <ul style="list-style-type: none"> <li>- Rigid 0.2 ... 2.5 mm<sup>2</sup></li> <li>- Flexible 0.2 ... 2.5 mm<sup>2</sup></li> </ul> </li> <li>• Enclosed at both ends</li> <li>• Black</li> </ul>					
	<b>Versions</b> <ul style="list-style-type: none"> <li>• Without LED</li> <li>• With LED 12 ... 30 V AC/DC</li> </ul>					
		<b>8WH1000-1HH08</b> <b>8WH1000-1PH38</b>		1 50 units 1 50 units	1BT 1BT	
<b>Accessories</b>						
 8WH9002-8AC10	<b>Reducing combs, for connecting terminals, from terminal size 6 mm<sup>2</sup> to 2.5 or 4 mm<sup>2</sup>, from screw to screw</b>		<b>8WH9002-8AC10</b>	1 10 units	1BT	

For general accessories for 8WH terminal blocks, see chapter "Accessories for 8WH Terminal Blocks"

## 8WH1 Screw Terminals

### 8WH isolating blade terminals

#### Overview





Key features of the 8WH isolating blade terminals are their slim design and high current carrying capacity of 20 A. They can be bridged with standard terminal jumpers over the double bridge shaft.

The individual clamping points can be inscribed at the front using labels.

#### Technical specifications

	8WH1000-6CG00
Dimensions	
• Width/length/cover width in mm	6.2 / 57.8 / --
• Height (NS 35/7.5 / NS 35/15) in mm	49.1 / 56.6
Technical specifications acc. to IEC/DIN VDE	
• Max. load current in A / cross-section in mm <sup>2</sup>	20 / 6
• Rated impulse withstand voltage in kV / pollution degree	6 kV / 3
• Rated insulation voltage (working voltage) $U_i$ in V acc. to IEC 60497-7-1	500
• Overvoltage category / molded plastic group	III / I
Connection capacities	
• Flexible with end sleeve, with plastic sleeve in mm <sup>2</sup>	0.25 ... 4
• Flexible with end sleeve, without plastic sleeve in mm <sup>2</sup>	0.25 ... 4
• Flexible with two-wire connection end sleeve, with plastic sleeve in mm <sup>2</sup>	0.5 ... 2.5
• Rigid in mm <sup>2</sup>	0.14 ... 6
Stripped length in mm	9
Tightening torque in Nm	0.6 ... 0.8
Molded plastic type	PA
• Flammability Class acc. to UL 94	V0
Approval data (UL/cUL and CSA)	
• Rated voltage / rated current / conductor sizes	
- UL/cUL: in V/A / AWG	600 / 16 / 26 ... 10
- CSA: in V/A / AWG	600 / 16 / 26 ... 10

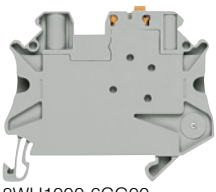
#### Selection and ordering data

Version	DT	Article No. <a href="http://www.siemens.com/product?Article No.">www.siemens.com/ product?Article No.</a>	Price per PU	PU (UNIT, SET, M)	PS*/ P. unit	PG
 <p><b>Terminal size 4 mm<sup>2</sup></b></p> <p><b>Isolating blade terminals, terminal size 4 mm<sup>2</sup></b></p> <ul style="list-style-type: none"> <li>•  US</li> <li>• Terminal width 6.2 mm</li> <li>• <math>I_{max} = 20</math> A</li> <li>• <math>U_{max} = 500</math> V</li> <li>• AWG 26 ... 12</li> <li>• Connection capacity, one conductor <ul style="list-style-type: none"> <li>- Rigid 0.14 ... 4 mm<sup>2</sup></li> <li>- Flexible 0.14 ... 4 mm<sup>2</sup></li> </ul> </li> <li>• Connection capacity, two conductors <ul style="list-style-type: none"> <li>- Rigid 0.14 ... 1.5 mm<sup>2</sup></li> <li>- Flexible 0.14 ... 1.5 mm<sup>2</sup></li> </ul> </li> <li>• Enclosed at both ends</li> <li>• Gray</li> </ul>		<b>8WH1000-6CG00</b>		1 50 units		1BT
<p><b>Accessories</b></p> <p><b>Warning covers, for terminal size 4 mm<sup>2</sup></b></p> <ul style="list-style-type: none"> <li>• Lightning symbol</li> <li>• Width 6.2 mm</li> <li>• Yellow</li> </ul>		<b>8WH9063-5BA06</b>		100 50 units		1BT

For general accessories for 8WH terminal blocks, see chapter "Accessories for 8WH Terminal Blocks"

## Overview

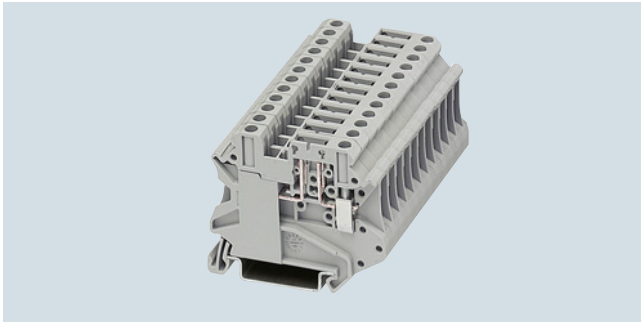

8WH isolating terminals serve for mounting various function plugs.

The individual clamping points can be inscribed at the front using labels.

## Technical specifications

	8WH1000-6AG00	8WH1000-6AH00
Dimensions		
• Width/length/cover width in mm	6.2 / 57.8 / --	
• Height (NS 35/7.5 / NS 35/15) in mm	49.1 / 56.6	73 / 80.5
Technical specifications acc. to IEC/DIN VDE		
• Max. load current in A / cross-section in mm <sup>2</sup>	20 / 6	20 / 10
• Rated impulse withstand voltage in kV / pollution degree	6 kV / 3	
• Rated insulation voltage (working voltage) $U_i$ in V acc. to IEC 60497-7-1	500	
• Overvoltage category / molded plastic group	III / I	
Connection capacities		
• Flexible with end sleeve, with plastic sleeve in mm <sup>2</sup>	0.25 ... 4	0.26 ... 6
• Flexible with end sleeve, without plastic sleeve in mm <sup>2</sup>	0.25 ... 4	0.26 ... 6
• Flexible with two-wire connection end sleeve, with plastic sleeve in mm <sup>2</sup>	0.5 ... 2.5	0.5 ... 4
• Rigid in mm <sup>2</sup>	0.14 ... 6	0.2 ... 10
Stripped length in mm	9	10
Tightening torque in Nm	0.6 ... 0.8	1.5 ... 1.8
Molded plastic type	PA	
• Flammability Class acc. to UL 94	V0	
Approval data (UL/cUL and CSA)		
• Rated voltage / rated current / conductor sizes		
- UL/cUL: in V/A / AWG	600 / 16 / 26 ... 10	-- / -- / --
- CSA: in V/A / AWG	600 / 16 / 26 ... 10	-- / -- / --

## Selection and ordering data

Version	DT	Article No. <a href="http://www.siemens.com/product?Article No.">www.siemens.com/ product?Article No.</a>	Price per PU	PU (UNIT, SET, M)	PS*/ P. unit	PG
---------	----	--	-----------------	-------------------------	-----------------	----

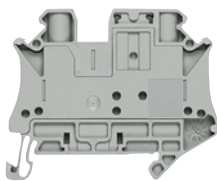
Terminal size 4 mm<sup>2</sup>

8WH1000-6AG00

Isolating terminals, terminal size 4 mm<sup>2</sup>

- 
- Terminal width 6.2 mm
- $I_{max} = 20$  A
- $U_{max} = 400$  V
- AWG 26 ... 10
- Connection capacity, one conductor
  - Rigid 0.14 ... 6 mm<sup>2</sup>
  - Flexible 0.14 ... 6 mm<sup>2</sup>
- Connection capacity, two conductors
  - Rigid 0.14 ... 1.5 mm<sup>2</sup>
  - Flexible 0.14 ... 1.5 mm<sup>2</sup>
- Enclosed at both ends
- Gray

8WH1000-6AG00

1 50 units 1BT

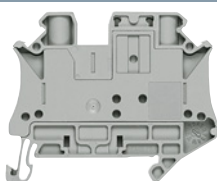
Terminal size 6 mm<sup>2</sup>

8WH1000-6AH00

Isolating terminals, terminal size 6 mm<sup>2</sup>





- 
- Terminal width 8.2 mm
- $I_{max} = 20$  A
- $U_{max} = 500$  V
- AWG 24 ... 8
- Connection capacity, one conductor
  - Rigid 0.2 ... 10 mm<sup>2</sup>
  - Flexible 0.2 ... 10 mm<sup>2</sup>
- Connection capacity, two conductors
  - Rigid 0.2 ... 2.5 mm<sup>2</sup>
  - Flexible 0.2 ... 2.5 mm<sup>2</sup>
- Enclosed at both ends
- Gray

8WH1000-6AH00

1 50 units 1BT

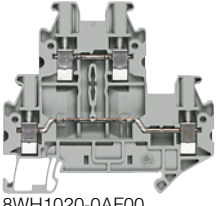
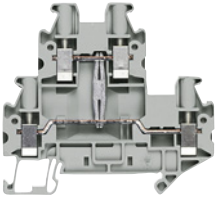

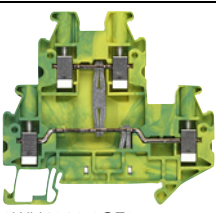



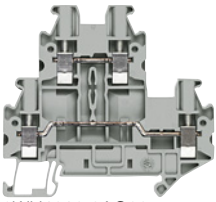

## Selection and ordering data

Version	DT	Article No. <a href="http://www.siemens.com/product?Article No.">www.siemens.com/ product?Article No.</a>	Price per PU	PU (UNIT, SET, M)	PS*/ P. unit	PG
<b>Terminal size 2.5 mm<sup>2</sup></b>						
 <p>8WH1020-0AF00</p>  <p>8WH1025-0AF00</p>	<b>Two-tier terminals, terminal size 2.5 mm<sup>2</sup></b> <ul style="list-style-type: none"> <li>•  US</li> <li>• Terminal width 5.2 mm</li> <li>• <math>I_{max} = 28</math> A</li> <li>• <math>U_{max} = 500</math> V</li> <li>• AWG 26 ... 12</li> <li>• Connection capacity, one conductor <ul style="list-style-type: none"> <li>- Rigid 0.14 ... 4 mm<sup>2</sup></li> <li>- Flexible 0.14 ... 4 mm<sup>2</sup></li> </ul> </li> <li>• Connection capacity, two conductors <ul style="list-style-type: none"> <li>- Rigid 0.14 ... 1.5 mm<sup>2</sup></li> <li>- Flexible 0.14 ... 1.5 mm<sup>2</sup></li> </ul> </li> </ul>					
	<b>Versions</b> <ul style="list-style-type: none"> <li>• Gray <ul style="list-style-type: none"> <li>- Without equipotential bonding</li> <li>- With equipotential bonding</li> </ul> </li> <li>• Blue <ul style="list-style-type: none"> <li>- Without equipotential bonding</li> </ul> </li> </ul>					
		<b>8WH1020-0AF00</b>		1 50 units	1BT	
		<b>8WH1025-0AF00</b>		1 50 units	1BT	
		<b>8WH1020-0AF01</b>		1 50 units	1BT	
 <p>8WH1020-0CF07</p>	<b>PE two-tier terminals, terminal size 2.5 mm<sup>2</sup></b> <ul style="list-style-type: none"> <li>•  US</li> <li>• Terminal width 5.2 mm</li> <li>• AWG 26 ... 12</li> <li>• Connection capacity, one conductor <ul style="list-style-type: none"> <li>- Rigid 0.14 ... 4 mm<sup>2</sup></li> <li>- Flexible 0.14 ... 4 mm<sup>2</sup></li> </ul> </li> <li>• Connection capacity, two conductors <ul style="list-style-type: none"> <li>- Rigid 0.14 ... 1.5 mm<sup>2</sup></li> <li>- Flexible 0.14 ... 1.5 mm<sup>2</sup></li> </ul> </li> <li>• Green/yellow</li> </ul>		<b>8WH1020-0CF07</b>			
				1 50 units	1BT	

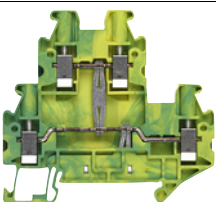
## 8WH1 Screw Terminals

## 8WH two-tier terminals

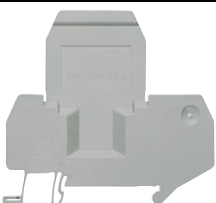
Version	DT	Article No. <a href="http://www.siemens.com/product?Article No.">www.siemens.com/ product?Article No.</a>	Price per PU	PU (UNIT, SET, M)	PS*/ P. unit	PG
<b>Terminal size 4 mm<sup>2</sup></b>						
 <p>8WH1020-0AG00</p>		<p><b>Two-tier terminals, terminal size 4 mm<sup>2</sup></b></p> <ul style="list-style-type: none"> <li>•  US</li> <li>• Terminal width 6.2 mm</li> <li>• <math>I_{max} = 36</math> A</li> <li>• <math>U_{max} = 800</math> V</li> <li>• AWG 26 ... 10</li> <li>• Connection capacity, one conductor <ul style="list-style-type: none"> <li>- Rigid 0.14 ... 6 mm<sup>2</sup></li> <li>- Flexible 0.14 ... 6 mm<sup>2</sup></li> </ul> </li> <li>• Connection capacity, two conductors <ul style="list-style-type: none"> <li>- Rigid 0.14 ... 1.5 mm<sup>2</sup></li> <li>- Flexible 0.14 ... 1.5 mm<sup>2</sup></li> </ul> </li> </ul> <p>Versions</p> <ul style="list-style-type: none"> <li>• Gray <ul style="list-style-type: none"> <li>- Without equipotential bonding</li> <li>- With equipotential bonding</li> </ul> </li> <li>• Blue <ul style="list-style-type: none"> <li>- Without equipotential bonding</li> </ul> </li> </ul>				
		<b>8WH1020-0AG00</b>		1	50 units	1BT
		<b>8WH1025-0AG00</b>		1	50 units	1BT
		<b>8WH1020-0AG01</b>		1	50 units	1BT
		<b>8WH1020-0CG07</b>		1	50 units	1BT
 <p>8WH1020-0CG07</p>		<p><b>PE two-tier terminals, terminal size 4 mm<sup>2</sup></b></p> <ul style="list-style-type: none"> <li>•  US</li> <li>• Terminal width 6.2 mm</li> <li>• AWG 26 ... 10</li> <li>• Connection capacity, one conductor <ul style="list-style-type: none"> <li>- Rigid 0.14 ... 6 mm<sup>2</sup></li> <li>- Flexible 0.14 ... 6 mm<sup>2</sup></li> </ul> </li> <li>• Connection capacity, two conductors <ul style="list-style-type: none"> <li>- Rigid 0.14 ... 1.5 mm<sup>2</sup></li> <li>- Flexible 0.14 ... 1.5 mm<sup>2</sup></li> </ul> </li> <li>• Green/yellow</li> </ul>				
<b>Accessories</b>						
 <p>8WH9000-1QA00</p>		<p><b>Covers, for two-tier terminals, for terminal size 2.5 ... 4 mm<sup>2</sup></b></p> <ul style="list-style-type: none"> <li>• Width 2.2 mm</li> <li>• Gray</li> </ul>		100	100 units	1BT
		<b>8WH9000-1QA00</b>		100	100 units	1BT
 <p>8WH9160-0AA00</p>		<p><b>Spacer plates, for two-tier terminals, for terminal size 2.5 ... 4 mm<sup>2</sup></b></p> <ul style="list-style-type: none"> <li>• Compensates for tier offset if other terminals are mounted side by side</li> <li>• 2.5 mm thick</li> <li>• Gray</li> </ul>		100	50 units	1BT
		<b>8WH9160-0AA00</b>		100	50 units	1BT
 <p>8WH9070-6FA00</p>		<p><b>Compartment partitions, for two-tier terminals, for terminal size 2.5 ... 4 mm<sup>2</sup></b></p> <ul style="list-style-type: none"> <li>• For visual and electrical separation of terminal groups</li> <li>• 2 mm thick</li> <li>• Gray</li> </ul>		100	50 units	1BT
		<b>8WH9070-6FA00</b>		100	50 units	1BT

For general accessories for 8WH terminal blocks, see chapter "Accessories for 8WH Terminal Blocks"



## 8WH two-tier terminals with isolating function/isolating blade

## Overview



Two-tier terminals with isolating function/isolating blades are also available with the same contour as 8WH1 two-tier terminals.

An increasing number of contact points need to be wired in the same space in the signal wiring. The two voltage levels routed through two separate tiers require 50 % less space than equivalent single-tier terminals.

To implement a wide range of wiring tasks, particularly in measuring and control technology, an isolating blade or an isolating plug, a component plug or a fused plug for 5 × 20 mm glass tube fuses can be used in the standardized separation zone in the upper tier.

The looping of measuring devices is possible over the terminal screws with integrated test socket so that voltage and current measurements can be performed on both tiers without interruption. The tier offset makes access to the lower tier much easier.

The clamping points of two-tier terminals can be inscribed at the front using the labels.

## Technical specifications







	8WH1020-6AC00	8WH1020-6AG00
Dimensions		
• Width/length/cover width in mm	6.2 / 69.9 / 2.2	
• Height (NS 35/7.5 / NS 35/15) in mm	65 / 72.5	
Technical specifications acc. to IEC/DIN VDE		
• Max. load current in A / cross-section in mm <sup>2</sup>	38 <sup>1)</sup> / 6	
• Rated impulse withstand voltage in kV / pollution degree	6 kV / 3	
• Rated insulation voltage (working voltage) $U_i$ in V acc. to IEC 60497-7-1	500	
• Overvoltage category / molded plastic group	III / I	
Connection capacities		
• Flexible with end sleeve, with plastic sleeve in mm <sup>2</sup>	0.25 ... 4	
• Flexible with end sleeve, without plastic sleeve in mm <sup>2</sup>	0.25 ... 4	
• Flexible with two-wire connection end sleeve, with plastic sleeve in mm <sup>2</sup>	0.5 ... 2.5	
• Rigid in mm <sup>2</sup>	0.14 ... 6	
Stripped length in mm	9	
Tightening torque in Nm	0.6 ... 0.8	
Molded plastic type	PA	
• Flammability Class acc. to UL 94	V0	
Approval data (UL/cUL and CSA)		
• Rated voltage / rated current / conductor sizes		
- UL/cUL: in V/A / AWG	600 / 5 / 26 ... 10	
- CSA: in V/A / AWG	-- / -- / --	

<sup>1)</sup> Bottom level

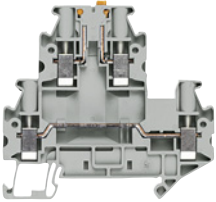
## 8WH1 Screw Terminals

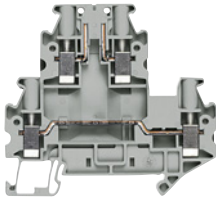
### 8WH two-tier terminal with isolating function

#### Selection and ordering data

Version	DT	Article No. <a href="http://www.siemens.com/product?Article No.">www.siemens.com/ product?Article No.</a>	Price per PU	PU (UNIT, SET, M)	PS*/ P. unit	PG
<b>Terminal size 4 mm<sup>2</sup></b>						
 <p>8WH1020-6AC00</p>		<p><b>Two-tier terminal, with isolating function/isolating blade, terminal size 4 mm<sup>2</sup></b></p> <ul style="list-style-type: none"> <li>•  US</li> <li>• Terminal width 6.2 mm</li> <li>• <math>I_{max} = 38</math> A</li> <li>• <math>U_{max} = 500</math> V</li> <li>• AWG 26 ... 10</li> <li>• Connection capacity, one conductor <ul style="list-style-type: none"> <li>- Rigid 0.14 ... 6 mm<sup>2</sup></li> <li>- Flexible 0.14 ... 6 mm<sup>2</sup></li> </ul> </li> <li>• Connection capacity, two conductors <ul style="list-style-type: none"> <li>- Rigid 0.14 ... 1.5 mm<sup>2</sup></li> <li>- Flexible 0.14 ... 1.5 mm<sup>2</sup></li> </ul> </li> </ul>				
 <p>8WH1020-6AG00</p>		<p><b>Versions</b></p> <ul style="list-style-type: none"> <li>• Isolating links in the upper tier</li> <li>• Isolating terminal in the upper tier</li> </ul>				
<b>Accessories</b>						
 <p>8WH9000-1QA00</p>		<p><b>Covers, for two-tier terminals, for terminal size 2.5 ... 4 mm<sup>2</sup></b></p> <ul style="list-style-type: none"> <li>• Width 2.2 mm</li> <li>• Gray</li> </ul>			100	100 units 1BT
 <p>8WH9160-0AA00</p>		<p><b>Spacer plates, for two-tier terminals, for terminal size 2.5 ... 4 mm<sup>2</sup></b></p> <ul style="list-style-type: none"> <li>• Compensates for tier offset if other terminals are mounted side by side</li> <li>• 2.5 mm thick</li> <li>• Gray</li> </ul>			100	50 units 1BT
 <p>8WH9070-6FA00</p>		<p><b>Compartment partitions, for two-tier terminals, for terminal size 2.5 ... 4 mm<sup>2</sup></b></p> <ul style="list-style-type: none"> <li>• For visual and electrical separation of terminal groups</li> <li>• 2 mm thick</li> <li>• Gray</li> </ul>			100	50 units 1BT

For general accessories for 8WH terminal blocks, see chapter "Accessories for 8WH Terminal Blocks"

## Overview

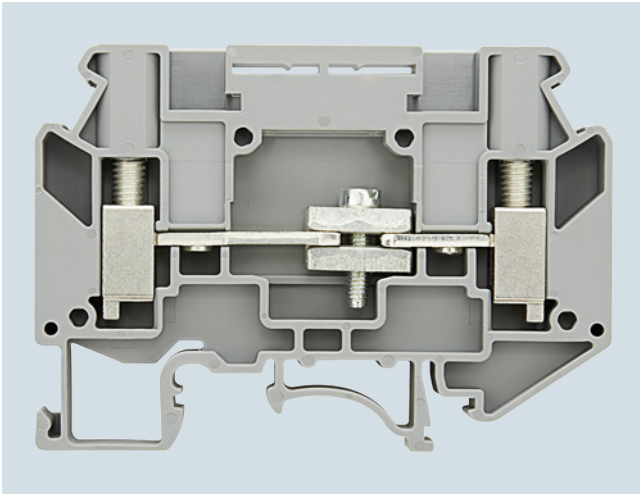

Measuring transformer terminals can be used for testing and isolating circuits without interrupting operation. In this way, they permit easy and transparent maintenance and commissioning.

The isolating and instrument isolating terminals contain an isolating device in the through-type connection. The isolating device permits electrical separation between the input and output of a terminal. Test sockets can be screwed into the front side of the through-type and isolating terminals.

Two adjacent terminals can be connected in parallel with the disconnecting link. The disconnecting link can be operated in any position of the isolating device. Two labels can be snapped on to the side of each terminal at the front.

**Instrument set for one transformer**

The instrument set for one transformer makes the basic circuit of the transformer terminal blocks clear. This basic circuit is also included in much larger instrument sets, which is extended by adding on equivalent circuits. Links between the basic circuits provide many kinds of testing facilities, parallel outgoing lines to other measuring devices, connection of test equipment, etc.

**Instrument set for three transformers**

The simplest version of an instrument set for a three-phase circuit consists of three basic circuits strung together without any continuing links.

**Instrument set for three transformers with neutral point**

The instrument set with a neutral point is an extension of the previous circuit. Four instead of six lines are sufficient for connecting it with the measuring devices. The neutral point is produced on the measuring instruments on the one hand, and using a shortened 8WH9021-0AL00 connection bar on the other.

**Note**

The 8WH1000-7BH00 through-type terminals and their associated disconnecting links enable terminal sets for current transformers to be configured much more easily. Instead of the 12 isolating or instrument isolating terminals used previously, only 3 instrument isolating terminals and 3 through-type terminals now have to be used.

**Instrument set with test facility**

This instrument set represents a significant enhancement over previous types. In normal operation, terminals 2, 5 and 8 are closed. For testing a measuring instrument (e.g. a plotter), these terminals are opened and terminals 3, 6 and 9 are closed in order to feed in a test signal. The transformers first have to be short-circuited with the disconnecting links between terminals 1-2, 4-5 and 7-8. Wire jumpers connect terminals 1, 4 and 7 with the neutral point that is formed in terminals 10, 11, 12 and 13 with a shortened jumper 8WH9021-0AL00.

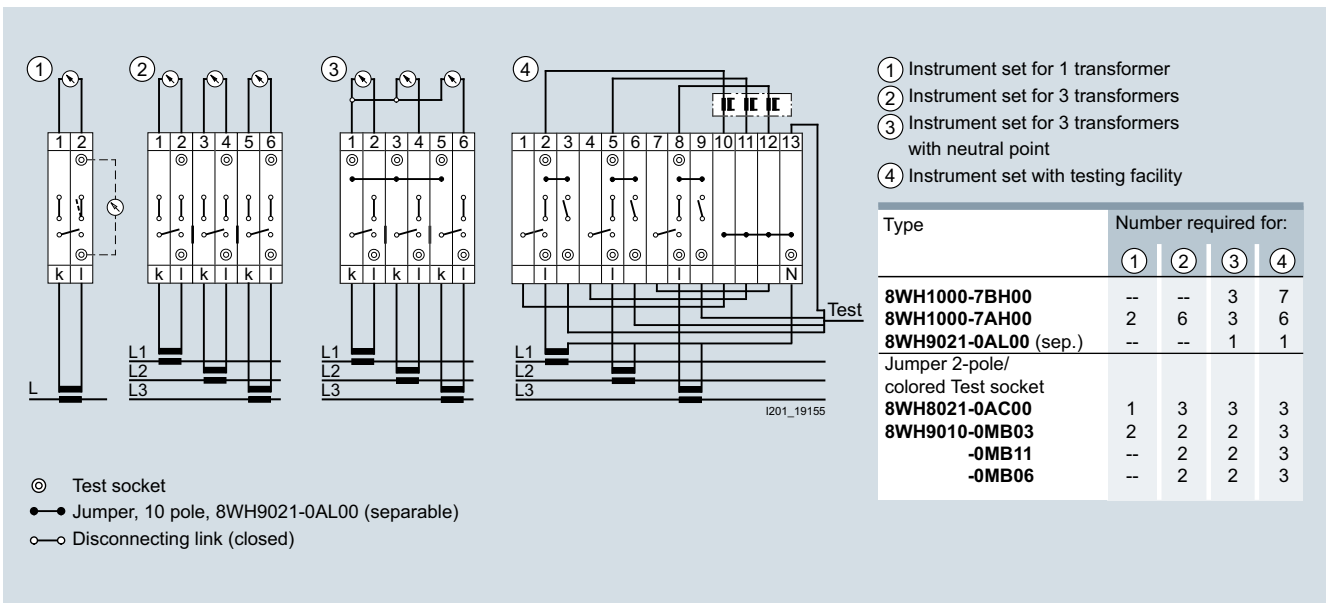

Connection option for measuring transformer terminals (instrument sets)

## 8WH1 Screw Terminals

### 8WH measuring transformer terminals







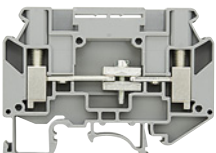
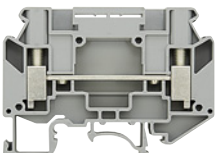

#### Technical specifications

	8WH1000-7AH00	8WH1000-7BH00
Dimensions		
• Width/length/cover width in mm	8.2 / 66.5 / 2.2	
• Height (NS 35/7.5 / NS 35/15) in mm	48	
Technical specifications acc. to IEC/DIN VDE		
• Max. load current in A / cross-section in mm <sup>2</sup>	57/10 mm <sup>2</sup>	57/10 mm <sup>2</sup>
• Rated uninterrupted current in A	41	41
• Rated insulation voltage (working voltage) $U_i$ in V acc. to IEC 60497-7-1	500	800
Connection capacities		
• Flexible with end sleeve, with plastic sleeve in mm <sup>2</sup>	0.5 ... 6	0.5 ... 6
• Flexible with end sleeve, without plastic sleeve in mm <sup>2</sup>	0.5 ... 6	0.5 ... 6
• Flexible with two-wire connection end sleeve, with plastic sleeve in mm <sup>2</sup>	0.5 ... 6	0.5 ... 6
• Rigid in mm <sup>2</sup>	0.5 ... 10	0.5 ... 10
Stripped length in mm	10	10
Tightening torque in Nm	1.5 ... 1.6	1.5 ... 1.6
Flammability Class acc. to UL 94	V0	

#### Selection and ordering data

Version	DT	Article No. <a href="http://www.siemens.com/product?Article No.">www.siemens.com/ product?Article No.</a>	Price per PU	PU (UNIT, SET, M)	PS*/ P. unit	PG						
<b>General details</b> <ul style="list-style-type: none"> <li>• With thermoplastic insulating body</li> <li>• Screw terminals at both ends and 2 recesses for screwing in the test adapters</li> </ul> <table border="1"> <thead> <tr> <th>Note</th> <th>Section</th> <th>Page</th> </tr> </thead> <tbody> <tr> <td>For labeling accessories, see ...</td> <td>Accessories</td> <td>8/2</td> </tr> </tbody> </table>							Note	Section	Page	For labeling accessories, see ...	Accessories	8/2
Note	Section	Page										
For labeling accessories, see ...	Accessories	8/2										
<b>Terminal size 6 mm<sup>2</sup></b>												
 <p>8WH1000-7AH00</p>		<b>Measuring transformer isolating terminals, terminal size 6 mm<sup>2</sup></b> <ul style="list-style-type: none"> <li>• Rated uninterrupted current 41 A</li> <li>• Rated insulation voltage 500 V</li> <li>• Mounting width 8.2 mm</li> <li>• Disconnect slide tightening torque: 0.6 ... 0.8 Nm</li> </ul>										
 <p>8WH1000-7BH00</p>		<b>Measuring transformer through-type terminal, terminal size 6 mm<sup>2</sup></b> <ul style="list-style-type: none"> <li>• Rated uninterrupted current 41 A</li> <li>• Rated insulation voltage 800 V</li> <li>• Mounting width 8.2 mm</li> </ul>										
		<b>8WH1000-7AH00</b>		1 50 units		1BT						
		<b>8WH1000-7BH00</b>		1 50 units		1BT						

## 8WH measuring transformer terminals

Version	DT	Article No. <a href="http://www.siemens.com/product?Article No.">www.siemens.com/ product?Article No.</a>	Price per PU	PU (UNIT, SET, M)	PS*/ P. unit	PG
<b>Accessories</b>						
		<b>Covers, for measuring transformer terminals, size 6 mm<sup>2</sup></b>				
8WH9000-3UA00		<ul style="list-style-type: none"> <li>• Width 2.2 mm</li> <li>• Gray</li> </ul>		100	50 units	1BT
		<b>Disconnecting links, 2-pole</b>				
8WH9021-0AC00		<ul style="list-style-type: none"> <li>• For bridging two adjacent terminals</li> <li>• Cannot be used with the bare 8WH9010-0MB12 test socket</li> <li>• Tightening torque: 0.6...0.8 Nm</li> </ul>		1	10 units	1BT
		<b>Bridges, 10-pole (separable)</b>				
8WH90210AL00		<ul style="list-style-type: none"> <li>• Consisting of connecting wire, spacer sleeves and screws</li> <li>• For bridging terminals, the connecting wire is adjustable</li> <li>• Tightening torque: 0.6 ... 0.8 Nm</li> <li>• Cannot be used with the bare 8WH9010-0MB12 test socket</li> </ul>		1	10 units	1BT
		<b>Test sockets, green</b>				
8WH9010-0MB03		<ul style="list-style-type: none"> <li>• For screwing into the measuring transformer terminals</li> <li>• Tightening torque: 0.6 ... 0.8 Nm</li> <li>• The 8WH9021-0AC00 disconnecting link shall be used for short-circuiting adjacent terminals.</li> </ul>		1	10 units	1BT
		<b>Test sockets, violet</b>				
8WH9010-0MB11		<ul style="list-style-type: none"> <li>• For screwing into the measuring transformer terminals.</li> <li>• Tightening torque: 0.6 ... 0.8 Nm</li> <li>• The 8WH9021-0AC00 disconnecting link shall be used for short-circuiting adjacent terminals.</li> </ul>		1	10 units	1BT
		<b>Test sockets, yellow</b>				
8WH9010-0MB06		<ul style="list-style-type: none"> <li>• For screwing into the measuring transformer terminals.</li> <li>• Tightening torque: 0.6 ... 0.8 Nm</li> <li>• The 8WH9021-0AC00 disconnecting link shall be used for short-circuiting adjacent terminals.</li> </ul>		1	10 units	1BT
		<b>Test sockets, bare</b>				
8WH9010-0MB12		<ul style="list-style-type: none"> <li>• For screwing into the measuring transformer terminals</li> <li>• For simple transformer measurements</li> <li>• Tightening torque: 0.6 ... 0.8 Nm</li> <li>• For tapping with test plug</li> <li>• The 8WH9010-0BC08 short-circuiting plug shall be used for short-circuiting adjacent terminals.</li> </ul>		1	10 units	1BT
		<b>Short-circuiting plugs, 2-pin</b>				
8WH9010-0BC08		<ul style="list-style-type: none"> <li>• For short-circuiting adjacent terminals</li> <li>• For simple transformer measurements</li> <li>• Tightening torque: 0.6 ... 0.8 Nm</li> <li>• Required when the bare 8WH9010-0MB12 test adapter is used in the measuring transformer terminal</li> <li>• Totally insulated</li> <li>• <math>I_{max} = 20</math> A</li> </ul>		1	10 units	1BT

## 8WH1 Screw Terminals

### 8WH diode terminals

#### Overview

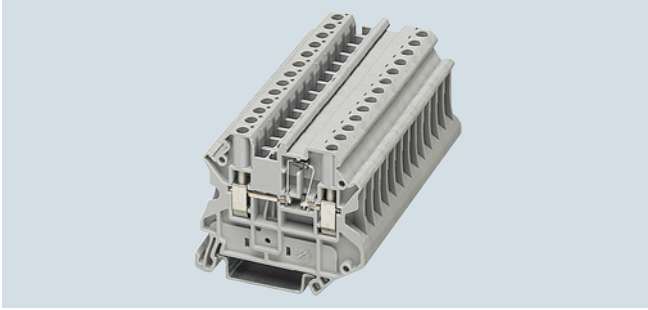

8WH diode terminals can be used to implement many different wiring tasks. The 1N 4007 diode is soldered in from left to right or vice versa as required. The double bridge shaft allows for combination with all standard and function terminals.

The 8WH diode terminals have the same contour as the 8WH isolating, isolating blade and fuse terminals. This has the advantage of enabling consistent inscriptions on all clamping points. Secure electrical and mechanical contact with the support rail is assured by simply snapping the terminals onto the rail.



The clamping points of diode terminals can be inscribed at the front using the labels.

#### Technical specifications

	8WH1000-6KG00	8WH1000-6LG00
Dimensions		
• Width/length/cover width in mm	6.2 / 57.8 / 2.2	
• Height (NS 35/7.5 / NS 35/15) in mm	47.5 / 55	
Technical specifications acc. to IEC/DIN VDE		
• Max. load current in A <sup>1)</sup> / cross-section in mm <sup>2</sup>	-- / 6	
• Rated impulse withstand voltage in kV / pollution degree	8 kV / 3	
• Rated insulation voltage (working voltage) $U_i$ in V acc. to IEC 60497-7-1	800	
• Overvoltage category / molded plastic group	III / I	
Connection capacities		
• Flexible with end sleeve, with plastic sleeve in mm <sup>2</sup>	0.25 ... 4	
• Flexible with end sleeve, without plastic sleeve in mm <sup>2</sup>	0.25 ... 4	
• Flexible with two-wire connection end sleeve, with plastic sleeve in mm <sup>2</sup>	0.5 ... 2.5	
• Rigid in mm <sup>2</sup>	0.14 ... 6	
Stripped length in mm	9	
Tightening torque in Nm	0.6 ... 0.8	
Molded plastic type	PA	
• Flammability Class acc. to UL 94	V0	
Approval data (UL/cUL and CSA)		
• Rated voltage / rated current / conductor sizes		
- UL/cUL: in V/A / AWG	600 / 1 / 26 ... 10	600 / 1 / 26 ... 10
- CSA: in V/A / AWG	600 / 1 / 26 ... 10	600 / 1 / 26 ... 10

<sup>1)</sup> Maximum current determined by diode. A 1N 4007 diode is integrated, blocking voltage: 1300 V, max. average on-state current: 0.5 A

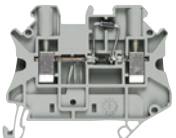
#### Selection and ordering data

Version	DT	Article No. <a href="http://www.siemens.com/product?ArticleNo">www.siemens.com/ product?Article No.</a>	Price per PU	PU (UNIT, SET, M)	PS*/ P. unit	PG
<b>Terminal size 4 mm<sup>2</sup></b>						
 8WH1000-6KG00		<b>Diode terminals, terminal size 4 mm<sup>2</sup>, gray, cULus, ®</b> <ul style="list-style-type: none"> <li>Terminal width 6.2 mm</li> <li><math>I_{max} = 0.5 \text{ A}</math>, <math>U_{max} = 800 \text{ V}</math></li> <li>AWG 26 ... 10</li> <li>Connection capacity, one conductor               <ul style="list-style-type: none"> <li>- Rigid 0.14 ... 6 mm<sup>2</sup>, flexible 0.14 ... 6 mm<sup>2</sup></li> </ul> </li> <li>Connection capacity, two conductors               <ul style="list-style-type: none"> <li>- Rigid 0.14 ... 1.5 mm<sup>2</sup>, flexible 0.14 ... 1.5 mm<sup>2</sup></li> </ul> </li> <li>With integrated diode: 1N 4007</li> </ul>				
	<b>Versions</b> <ul style="list-style-type: none"> <li>Let-through from left to right</li> <li>Let-through from right to left</li> </ul>		<b>8WH1000-6LG00</b> <b>8WH1000-6KG00</b>		1 50 units 1 50 units	1BT 1BT
<b>Accessories</b>						
 8WH9000-2PA00		<b>Covers, for diode terminals, for terminal size 2.5 ... 4 mm<sup>2</sup></b> <ul style="list-style-type: none"> <li>Width 2.2 mm</li> <li>Gray</li> </ul>			100 50 units	1BT
		<b>Warning covers, for terminal size 4 mm<sup>2</sup></b> <ul style="list-style-type: none"> <li>Lightning symbol, yellow</li> </ul>				<b>8WH9063-5BA06</b> 100 50 units 1BT

For general accessories for 8WH terminal blocks, see chapter "Accessories for 8WH Terminal Blocks"

## Overview

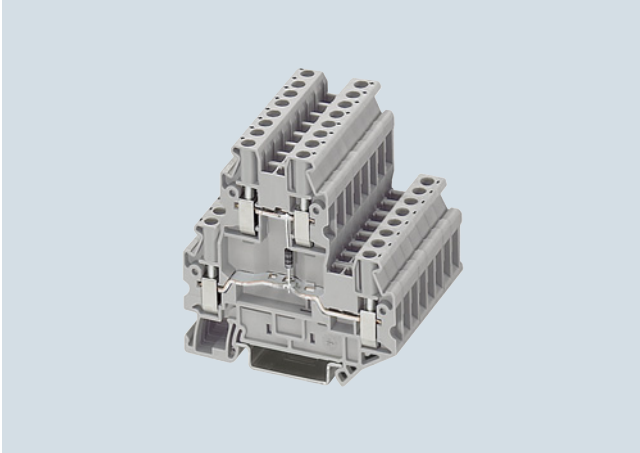

8WH two-tier diode terminals with a width of only 5.2 mm can be used to implement many different wiring tasks. This makes them possible in the narrowest of spaces:

- Freewheel diode circuits
- Lamp test circuits
- Signaling and fault signaling circuits

The clamping points of the 8WH1 two-tier diode terminals can be inscribed at the front using the labels.

## Technical specifications







	8WH1020-5AF00, 8WH1020-5BF00, 8WH1020-5DF00, 8WH1020-5FF00, 8WH1020-5HF00, 8WH1020-5JF30, 8WH1020-5LF00
Dimensions	
• Width/length/cover width in mm	5.2 / 69.9 / 2.2
• Height (NS 35/7.5 / NS 35/15) in mm	65 / 72.5
Technical specifications acc. to IEC/DIN VDE	
• Max. load current in A <sup>1)</sup> / cross-section in mm <sup>2</sup>	28 / 4
• Rated impulse withstand voltage in kV / pollution degree	6 kV / 3
• Rated insulation voltage (working voltage) $U_i$ in V acc. to IEC 60497-7-1	500
• Overvoltage category / molded plastic group	III / I
Connection capacities	
• Flexible with end sleeve, with plastic sleeve in mm <sup>2</sup>	0.25 ... 2.5
• Flexible with end sleeve, without plastic sleeve in mm <sup>2</sup>	0.25 ... 2.5
• Flexible with two-wire connection end sleeve, with plastic sleeve in mm <sup>2</sup>	0.5 ... 1.5
• Rigid in mm <sup>2</sup>	0.14 ... 4
Stripped length in mm	9
Tightening torque in Nm	0.5 ... 0.6
Molded plastic type	PA
• Flammability Class acc. to UL 94	V0
Approval data (UL/cUL and CSA)	
• Rated voltage / rated current / conductor sizes	
- UL/cUL: in V/A / AWG	-- / -- / --
- CSA: in V/A / AWG	-- / -- / --

<sup>1)</sup> Maximum current determined by diode.  
 Integrated: diode 1N 4007, blocking voltage: 1300 V  
 Max. average on-state current: 0.5 A

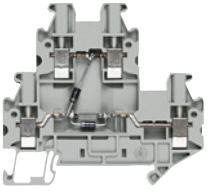
## 8WH1 Screw Terminals

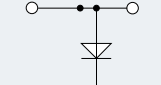
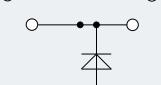

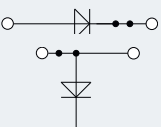
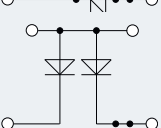
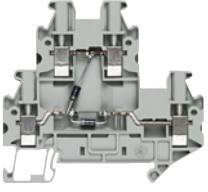

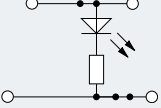

## 8WH two-tier diode terminals

## Selection and ordering data

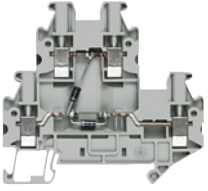
Version	DT	Article No. <a href="http://www.siemens.com/product?ArticleNo.">www.siemens.com/ product?Article No.</a>	Price per PU	PU (UNIT, SET, M)	PS*/ P. unit	PG
<b>Terminal size 2.5 mm<sup>2</sup></b>						
 <p><b>Two-tier diode terminals, terminal size 2.5mm<sup>2</sup></b></p> <ul style="list-style-type: none"> <li>•  US</li> <li>• Terminal width 5.2 mm</li> <li>• <math>I_{max} = 28</math> A, through the diode 0.5 A</li> <li>• <math>U_{max} = 500</math> V</li> <li>• AWG 26 ... 12</li> <li>• Connection capacity, one conductor <ul style="list-style-type: none"> <li>- Rigid 0.14 ... 4 mm<sup>2</sup></li> <li>- Flexible 0.14 ... 4 mm<sup>2</sup></li> </ul> </li> <li>• Connection capacity, two conductors <ul style="list-style-type: none"> <li>- Rigid 0.14 ... 1.5 mm<sup>2</sup></li> <li>- Flexible 0.14 ... 1.5 mm<sup>2</sup></li> </ul> </li> <li>• With integrated diode: 1N 4007</li> <li>• Gray</li> </ul>						
<b>Circuit diagram</b>						
<b>Versions</b>						
		• With an integrated 1N 4007 diode • Let-through from top to bottom	<b>8WH1020-5AF0</b>	1	50 units	1BT
		• With an integrated 1N 4007 diode • Let-through from bottom to top	<b>8WH1020-5BF0</b>	1	50 units	1BT
		• With an integrated 1N 4007 diode • Let-through from bottom left to top right	<b>8WH1020-5DF0</b>	1	50 units	1BT
		• With two 1N 4007 diodes integrated • Let-through from top to bottom left and from bottom right to bottom left	<b>8WH1020-5FF0</b>	1	50 units	1BT
		• With two 1N 4007 diodes integrated • Let-through from top to bottom left and from top to bottom right	<b>8WH1020-5HF0</b>	1	50 units	1BT
<b>Two-tier terminals with LED 24 V DC, terminal size 2.5 mm<sup>2</sup> <span style="color: red;">NEW</span></b>						
For checking whether voltage is present						
 <p><b>Two-tier terminals with LED 24 V DC, terminal size 2.5 mm<sup>2</sup> <span style="color: red;">NEW</span></b></p> <ul style="list-style-type: none"> <li>•  US</li> <li>• Terminal width 5.2 mm</li> <li>• <math>I_{max} = 28</math> A, through the diode 0.5 A</li> <li>• <math>U_{max} = 500</math> V</li> <li>• AWG 26 ... 12</li> <li>• Connection capacity, one conductor <ul style="list-style-type: none"> <li>- Rigid 0.14 ... 4 mm<sup>2</sup></li> <li>- Flexible 0.14 ... 4 mm<sup>2</sup></li> </ul> </li> <li>• Connection capacity, two conductors <ul style="list-style-type: none"> <li>- Rigid 0.14 ... 1.5 mm<sup>2</sup></li> <li>- Flexible 0.14 ... 1.5 mm<sup>2</sup></li> </ul> </li> <li>• With integrated diode: 1N 4007</li> <li>• Gray</li> </ul>						
<b>Circuit diagram</b>						
			<b>8WH1020-5JF0</b>	1	50 units	1BT

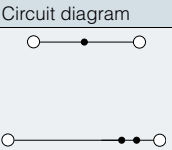

## 8WH two-tier diode terminals

Version	DT	Article No. <a href="http://www.siemens.com/product?ArticleNo.">www.siemens.com/ product?Article No.</a>	Price per PU	PU (UNIT, SET, M)	PS*/ P. unit	PG
 <p><b>Two-tier terminals for soldering of components, terminal size 2.5 mm<sup>2</sup></b> Supplied without components; the appropriate components (resistors, diodes, capacitors, ...) shall be soldered in by user</p> <ul style="list-style-type: none"> <li>•  US</li> <li>• Terminal width 5.2 mm</li> <li>• <math>I_{max} = 28</math> A, through the diode 0.5 A</li> <li>• <math>U_{max} = 500</math> V</li> <li>• AWG 26 ... 12</li> <li>• Connection capacity, one conductor <ul style="list-style-type: none"> <li>- Rigid 0.14 ... 4 mm<sup>2</sup></li> <li>- Flexible 0.14 ... 4 mm<sup>2</sup></li> </ul> </li> <li>• Connection capacity, two conductors <ul style="list-style-type: none"> <li>- Rigid 0.14 ... 1.5 mm<sup>2</sup></li> <li>- Flexible 0.14 ... 1.5 mm<sup>2</sup></li> </ul> </li> <li>• With integrated diode: 1N 4007</li> <li>• Gray</li> </ul> <p>Circuit diagram</p> 						
8WH1020-5FF00						
		<b>8WH1020-5LF00</b>		1 50 units		1BT
<b>Accessories</b>						
 <p><b>Covers, for two-tier terminals, for terminal size 2.5 ... 4 mm<sup>2</sup></b></p> <ul style="list-style-type: none"> <li>• Width 2.2 mm</li> <li>• Gray</li> </ul>		<b>8WH9000-1QA00</b>		100	100 units	1BT
8WH9000-1QA00						
 <p><b>Spacer plates, for two-tier terminals, for terminal size 2.5 ... 4 mm<sup>2</sup></b></p> <ul style="list-style-type: none"> <li>• Compensates for tier offset if other terminals are mounted side by side</li> <li>• 2.5 mm thick</li> <li>• Gray</li> </ul>		<b>8WH9160-0AA00</b>		100	50 units	1BT
8WH9160-0AA00						
 <p><b>Compartment partitions, for two-tier terminals, for terminal size 2.5 ... 4 mm<sup>2</sup></b></p> <ul style="list-style-type: none"> <li>• For visual and electrical separation of terminal groups</li> <li>• 2 mm thick</li> <li>• Gray</li> </ul>		<b>8WH9070-6FA00</b>		100	50 units	1BT
8WH9070-6FA00						

For general accessories for 8WH terminal blocks, see chapter "Accessories for 8WH Terminal Blocks"

## 8WH1 Screw Terminals

### 8WH high-current terminals

#### Overview

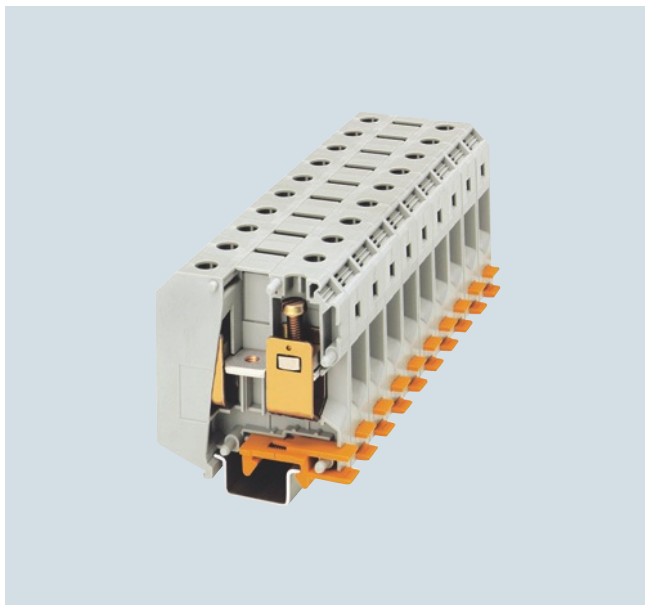

The high-current terminals cover cross-sectional areas from 16 to 240 mm<sup>2</sup>. A reliable cable connection is ensured through effective design measures, such as:

- Three-point centering of the conductor in the prismatic sleeve base
- Low contact resistance of the contact area through grooved surface
- Screw locking through spring-loaded elements
- Terminals enclosed at both ends

The terminals have an enclosed insulating body made of polyamide 6.6.

The terminals are available in gray and blue.

8WH labels must be used at the front for inscription purposes.

For terminals with terminal sizes up to 95 mm<sup>2</sup>, green-yellow PE/ground conductor terminals are available.

Mounting on support rails acc. to IEC 60 715.

7

#### Benefits

- Larger connection up to 240 mm<sup>2</sup>
- The right terminal is always available – whatever the connection functions
- Simple inscription using 8WH standard
- Comprehensive range of accessories available
- Enclosed insulating body made of polyamide 6.6

#### Design

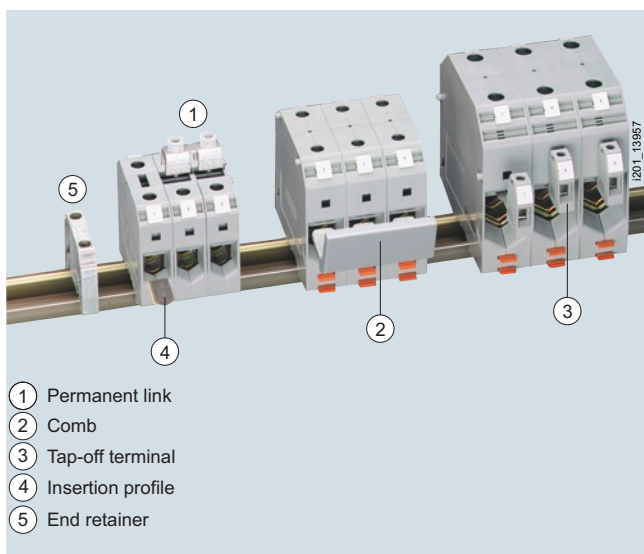

Using the 50 mm<sup>2</sup> terminals, permanent links can be mounted in 2- and 3-pole versions. Combs are required with 95 ... 240 mm<sup>2</sup> terminals.

Assembled terminal blocks



## Technical specifications

	8WH1000-0AN00 8WH1000-0AN01	8WH1000-0CN07	8WH1000-0AQ00 8WH1000-0AQ01
Dimensions			
• Width/length in mm	20 / 70.5		25 / 83
• Height (TS 35/7.5 / TS 35/15 / TS 32) in mm	-- / 83.5 / 81.5		-- / 97.5 / 95.5
Technical specifications acc. to IEC/DIN VDE			
• Max. load current in A / cross-section in mm <sup>2</sup>	150 / 50		232 / 95
• Maximum cross-section with comb (rigid / flexible) in mm <sup>2</sup>	--		95 / 70
• Rated impulse withstand voltage in kV / pollution degree	8 / 3		
• Overvoltage category / molded plastic group	III / I		
Connection capacities			
• Flexible with end sleeve without/with plastic sleeve in mm <sup>2</sup>	25 ... 50 / 25 ... 50		35 ... 95 / 35 ... 95
Multi-conductor connection (two conductors of same cross-section)			
• Rigid / flexible in mm <sup>2</sup>	10 ... 16 / 10 ... 16		25 ... 35 / 25 ... 35
• Flexible with end sleeve, without plastic sleeve in mm <sup>2</sup>	10 ... 16		16 ... 35
Stripped length in mm	24		33
Plug gauge (IEC 60947-1)	B10		B12
Screw thread	M6	--	M8
Tightening torque in Nm	6 ... 8	--	15 ... 20
Clamping point: screw thread / tightening torque in Nm	--	M6 / 6 ... 8	--
Fixing: screw thread / tightening torque in Nm	--	M6 / 6 ... 8	--
Molded plastic type	PA		
• Flammability Class acc. to UL 94	V0		
Approval data (UL/cUL and CSA)			
• Rated voltage / rated current / conductor sizes			
- UL/cUL: V/A/AWG	600 / 150 / 6 ... 0	6 ... 1 / 0	600 / 230 / 2 - 000
- CSA: V/A/AWG	600 / 125 / 6 ... 0	--	600 / 230 / 1 - 000
Support rails / protective conductor busbars	--	See page 1/3, section "Support rails"	--
	8WH1000-0CQ07	8WH1000-0AS00 8WH1000-0AS01	8WH1000-0AU00 8WH1000-0AU01
Dimensions			
• Width/length in mm	25 / 83	31 / 100	36 / 100
• Height (TS 35/7.5 / TS 35/15 / TS 32) in mm	-- / 99 / 96.5	-- / 118.5 / 116	-- / 131.5 / 129.5
Technical specifications acc. to IEC/DIN VDE			
• Max. load current in A / cross-section in mm <sup>2</sup>	232 / 95	309 / 150	415 / 240
• Maximum cross-section with comb (rigid / flexible) in mm <sup>2</sup>	--	150 / 120	240 / 185
• Rated impulse withstand voltage in kV / pollution degree	8 / 3		
• Overvoltage category / molded plastic group	III / I		
Connection capacities			
• Flexible with end sleeve without/with plastic sleeve in mm <sup>2</sup>		50 ... 150 / 50 ... 150	70 ... 185 / 70 ... 185
Multi-conductor connection (two conductors of same cross-section)			
• Rigid / flexible in mm <sup>2</sup>	25 ... 35 / 25 ... 35	25 ... 50 / 35 ... 50	35 ... 95 / 50...95
• Flexible with end sleeve, without plastic sleeve in mm <sup>2</sup>	16 ... 35	25 ... 50	35 ... 50
Stripped length in mm	30	40	
Plug gauge (IEC 60947-1)	B12	B14	B15
Screw thread	--	M10	
Tightening torque in Nm	--	25 ... 30	
Clamping point: screw thread / tightening torque in Nm	M8 / 15 ... 20 (hexagon socket-head screw)	--	--
Fixing: screw thread / tightening torque in Nm	M8 / 15 ... 20 (hexagon socket-head screw)	--	--
Molded plastic type	PA		
• Flammability Class acc. to UL 94	V0		
Approval data (UL/cUL and CSA)			
• Rated voltage / rated current / conductor sizes			
- UL/cUL: V/A/AWG	2 ... 4 / 0	600 / 285 / 2 AWG ... 300 kcmil	600 / 380 / 00 ... 500 kcmil
- CSA: V/A/AWG	2 ... 4 / 0	600 / 275 / 2 AWG ... 300 kcmil	600 / 400 / 0 ... 500 kcmil
Support rails / protective conductor busbars	See page 1/3, section "Support rails"	--	





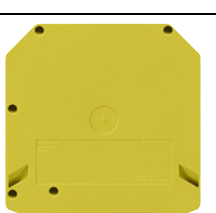
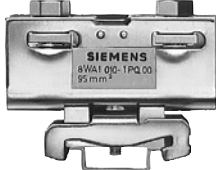

## 8WH1 Screw Terminals

## 8WH high-current terminals

## Selection and ordering data

Version	DT	Article No. <a href="http://www.siemens.com/product?ArticleNo.">www.siemens.com/ product?Article No.</a>	Price per PU	PU (UNIT, SET, M)	PS*/ P. unit	PG
<b>Terminal size 50 mm<sup>2</sup></b>						
 8WH1000-0AN00		<b>High-current terminals, terminal size 50 mm<sup>2</sup></b> <ul style="list-style-type: none"> <li>Enclosed at both ends</li> <li>Terminal width 20 mm</li> <li>• <b>CU</b></li> <li>• IEC 60947-7-1 <ul style="list-style-type: none"> <li>Rigid 16 ... 50 mm<sup>2</sup></li> <li>Flexible 25 ... 50 mm<sup>2</sup></li> <li>AWG 6-0</li> <li>I = 150 A</li> <li>U = 1000 V</li> </ul> </li> </ul>				
<b>Versions</b>						
<ul style="list-style-type: none"> <li>Gray</li> <li>Blue</li> </ul>		<b>8WH1000-0AN00</b>		1 10 units	1BT	
		<b>8WH1000-0AN01</b>		1 10 units	1BT	
 8WH1000-0CN07		<b>PE high-current terminals, terminal size 50 mm<sup>2</sup></b> <ul style="list-style-type: none"> <li>Green/yellow</li> <li>Enclosed at both ends</li> <li>Terminal width 20 mm</li> <li>• <b>CU</b></li> <li>• IEC 60947-7-1 <ul style="list-style-type: none"> <li>Rigid 16 ... 50 mm<sup>2</sup></li> <li>Flexible 25 ... 50 mm<sup>2</sup></li> <li>AWG 6-0</li> <li>I = 150 A</li> <li>U = 1000 V</li> </ul> </li> </ul>				
		<b>8WH1000-0CN07</b>		1 10 units	1BT	
<b>Terminal size 95 mm<sup>2</sup></b>						
 8WH1000-0AQ00		<b>High-current terminals, terminal size 95 mm<sup>2</sup></b> <ul style="list-style-type: none"> <li>Enclosed at both ends</li> <li>Terminal width 25 mm</li> <li>• <b>CU</b></li> <li>• IEC 60947-7-1 <ul style="list-style-type: none"> <li>Rigid 25 ... 95 mm<sup>2</sup></li> <li>Flexible 35 ... 95 mm<sup>2</sup></li> <li>AWG 4-000</li> <li>I = 232 A</li> <li>U = 1000 V</li> </ul> </li> </ul>				
<b>Versions</b>						
<ul style="list-style-type: none"> <li>Gray</li> <li>Blue</li> </ul>		<b>8WH1000-0AQ00</b>		1 10 units	1BT	
		<b>8WH1000-0AQ01</b>		1 10 units	1BT	
 8WH1000-0CQ07		<b>PE high-current terminals, terminal size 95 mm<sup>2</sup></b> <ul style="list-style-type: none"> <li>Green/yellow</li> <li>Enclosed at both ends</li> <li>Terminal width 25 mm</li> <li>• <b>CU</b></li> <li>• IEC 60947-7-1 <ul style="list-style-type: none"> <li>Rigid 25 ... 95 mm<sup>2</sup></li> <li>Flexible 35 ... 95 mm<sup>2</sup></li> <li>AWG 4-000</li> <li>I = 232 A</li> <li>U = 1000 V</li> </ul> </li> </ul>				
		<b>8WH1000-0CQ07</b>		1 10 units	1BT	
 8WA1010-1PQ00		<b>PE high-current terminals and PEN high-current terminals, terminal size 95mm<sup>2</sup>, two screw terminals</b> <ul style="list-style-type: none"> <li>Bare</li> <li>For I = 232 A</li> <li>Mounting width 16 mm</li> <li>Terminal height 63 mm</li> <li>Terminal length 75 mm</li> <li>• For 35 mm x 15 mm standard mounting rail only</li> </ul>				
<b>Note</b>						
8WH accessories do not match this terminal.						
		<b>8WA1010-1PQ00</b>		1 5 units	1BT	

## 8WH high-current terminals

Version	DT	Article No. <a href="http://www.siemens.com/product?Article.No.">www.siemens.com/ product?Article.No.</a>	Price per PU	PU (UNIT, SET, M)	PS*/ P. unit	PG
<b>Terminal size 150 mm<sup>2</sup></b>						
		<b>High-current terminals, terminal size 150 mm<sup>2</sup></b>				
8WH1000-0AS00		<ul style="list-style-type: none"> <li>Enclosed at both ends</li> <li>Terminal width 31 mm</li> <li>CSUS</li> <li>IEC 60947-7-1               <ul style="list-style-type: none"> <li>Rigid 35 ... 150 mm<sup>2</sup></li> <li>Flexible 50 ... 150 mm<sup>2</sup></li> <li>AWG 2-300</li> <li>I = 309 A</li> <li>U = 1000 V</li> </ul> </li> </ul>				
<b>Versions</b>						
<ul style="list-style-type: none"> <li>Gray</li> <li>Blue</li> </ul>		<b>8WH1000-0AS00</b> <b>8WH1000-0AS01</b>		1 10 units		1BT 1BT
<b>Terminal size 240 mm<sup>2</sup></b>						
		<b>High-current terminals, terminal size 240 mm<sup>2</sup></b>				
8WH1000-0AU00		<ul style="list-style-type: none"> <li>Enclosed at both ends</li> <li>Terminal width 36 mm</li> <li>CSUS</li> <li>IEC 60947-7-1               <ul style="list-style-type: none"> <li>Rigid 70 ... 240 mm<sup>2</sup></li> <li>Flexible 70 ... 240 mm<sup>2</sup></li> <li>AWG 00-500</li> <li>I = 415 A</li> <li>U = 1000 V</li> </ul> </li> </ul>				
<b>Versions</b>						
<ul style="list-style-type: none"> <li>Gray</li> <li>Blue</li> </ul>		<b>8WH1000-0AU00</b> <b>8WH1000-0AU01</b>		1 10 units		1BT 1BT
<b>Accessories</b>						
		<b>Tap-off terminals</b>				
8WH9120-0AA00		<ul style="list-style-type: none"> <li>When wiring a pick-off with a smaller cross-section, observe the overload and short-circuit strength specified in VDE 0100 Part 430</li> <li>I<sub>max</sub>: 57 A</li> <li>Cross-section: 10 mm<sup>2</sup></li> </ul>				
<b>Versions</b>						
<ul style="list-style-type: none"> <li>For terminal size 50 mm<sup>2</sup></li> <li>For terminal size 95 mm<sup>2</sup></li> <li>For terminal size 150 ... 240 mm<sup>2</sup></li> </ul>		<b>8WH9120-0AA00</b> <b>8WH9120-0BA00</b> <b>8WH9120-0CA00</b>		1 10 units		1BT 1BT 1BT
		<b>Combs</b>				
8WH9020-3AA00		<ul style="list-style-type: none"> <li>Totally insulated</li> <li>Fitted in the clamping sleeve and latched with the terminal enclosure</li> </ul>				
<b>Versions</b>						
<ul style="list-style-type: none"> <li>For terminal size 95 mm<sup>2</sup>, I<sub>max</sub>: 232 A               <ul style="list-style-type: none"> <li>2-pole</li> <li>3-pole</li> </ul> </li> <li>For terminal size 150 mm<sup>2</sup>, I<sub>max</sub>: 232 A               <ul style="list-style-type: none"> <li>2-pole</li> <li>3-pole</li> </ul> </li> <li>For terminal size 240 mm<sup>2</sup>, I<sub>max</sub>: 320 A               <ul style="list-style-type: none"> <li>2-pole</li> <li>3-pole</li> </ul> </li> </ul>		<b>8WH9020-3AA00</b> <b>8WH9020-3BA00</b> <b>8WH9020-3CA00</b> <b>8WH9020-3DA00</b> <b>8WH9020-3EA00</b> <b>8WH9020-3FA00</b>		1 10 units		1BT 1BT 1BT 1BT 1BT 1BT
		<b>Insertion profiles</b>				
8WH9020-3MA00		<ul style="list-style-type: none"> <li>Evens out the prismatic sleeve base when using flat conductors</li> </ul>				
<b>Versions</b>						
<ul style="list-style-type: none"> <li>For terminal size 50 mm<sup>2</sup></li> <li>For terminal size 95 mm<sup>2</sup></li> <li>For terminal size 150 and 240 mm<sup>2</sup></li> </ul>		<b>8WH9020-3MA00</b> <b>8WH9020-3NA00</b> <b>8WH9020-3PA00</b>		1 10 units		1BT 1BT 1BT
		<b>Permanent links, for terminal size 50 mm<sup>2</sup></b>				
8WH9020-6HC00		<ul style="list-style-type: none"> <li>For cross links</li> <li>Screw heads with insulating collar</li> <li>Remove partition first</li> <li>I<sub>max</sub> = 150 A</li> </ul>				
<b>Versions</b>						
<ul style="list-style-type: none"> <li>2-pole</li> <li>3-pole</li> </ul>		<b>8WH9020-6HC00</b> <b>8WH9020-6HD00</b>		1 10 units		1BT 1BT

For general accessories for 8WH terminal blocks, see chapter "Accessories for 8WH Terminal Blocks"

## 8WH1 Screw Terminals

### 8WH shield terminals

#### Overview

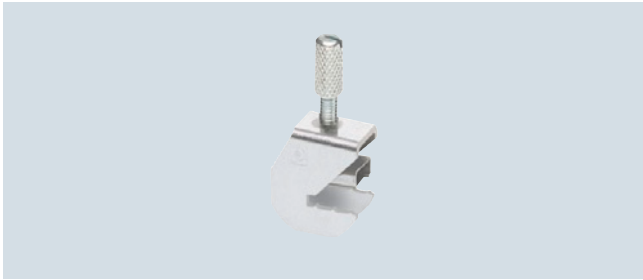

In industrial process engineering, a high interference immunity is required for electrical measuring and control equipment. It is a decisive factor in the availability of industrial equipment. When designing low-interference systems, great importance is placed on cable shielding and the respective shield ground. The critical point is where the cable shield is connected to the enclosure ground. The connection should have a low resistance and a low inductive reactance, while being quick and easy to establish. The shield terminals are ideally suited for this purpose and can be used with all common cable shields.

The effectiveness of cable shields depends to a large extent on the contact quality of the shield connection. The shield terminals have a large, low-impedance contact area with the shield, which reduces the voltage drop across it. Connected at one end only, shields can help reduce only low-frequency, capacitive interference, such as that caused by high-voltage installations. To pro-

tect from the much more common inductive interference signals, the cable shield must be connected at both ends.

However, differences in the ground potential can cause a compensating current to flow through the cable shield.

To reduce this interference current, it is advisable to connect the shield at several points along its length. The shorter the spaces between the clamping points, the smaller the compensating currents in the cable shield. In systems where safety is especially important, triaxial shields are used. These consist of two braids that are insulated from each other, with the outer shield connected at both ends and the inner one at only one end. With this arrangement, the equipotential bonding currents and the inductive interference are conducted through the outer shield, and the capacitive interference dissipated through the inner shield.

Depending on the length of the terminal strip, two or more support brackets are fitted, which provide both an electrical and a mechanical connection from the busbar to the support rail and therefore to the enclosure ground. The shield terminal is simply fitted to the busbar after all wires have been connected.

A spring-loaded pressure plate regulates the force applied to the cable to ensure an optimum contact with the busbar at all times.

If the cable shield is to be connected at another point of the control cabinet instead of directly in front of the terminal strip, we recommend using support brackets made of molded plastic.

#### Technical specifications

	8WH9130-0KA00	8WH9130-0LA00	8WH9130-0MA00	8WH9130-0NA00	8WH9130-0PA00
Dimensions	See dimensional drawing	See dimensional drawing	See dimensional drawing	See dimensional drawing	See dimensional drawing
Contact resistance in mΩ	< 1				
Connection data					
• Diameter	2 ... 5	3 ... 8	3 ... 14	3 ... 20	20 ... 35
• Tightening torque in Nm	0.4	0.6	0.8	0.8	1.5 ... 1.8





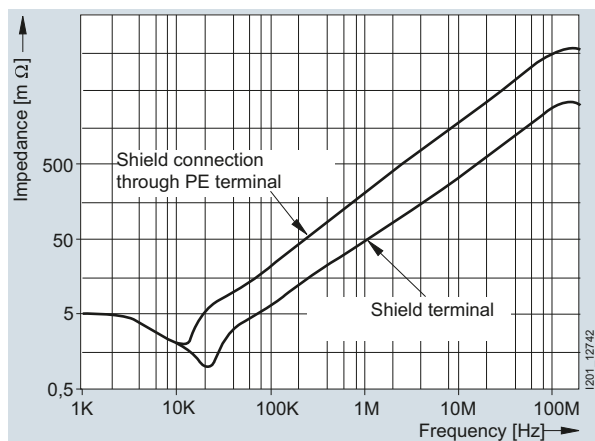

	8WH9130-0AA00	8WH9130-0BA00	8WH9130-0CA00	8WH9130-0DA00
Dimensions	See dimensional drawing	See dimensional drawing	See dimensional drawing	See dimensional drawing
Contact resistance in mΩ	The contact resistance is determined by the mounting area			
Connection data				
• Diameter	3 ... 8	3 ... 14	3 ... 20	20 ... 35
• Tightening torque in Nm	0.6	0.8	0.8	1.5 ... 1.8







Comparison of shield connection through PE terminal and through shield terminal

## Selection and ordering data

Version	DT	Article No. <a href="http://www.siemens.com/product?Article No.">www.siemens.com/ product?Article No.</a>	Price per PU	PU (UNIT, SET, M)	PS*/ P. unit	PG
<b>General details</b>						
Note						
<ul style="list-style-type: none"> <li>The shield terminals must not be used for strain relief</li> <li>Support brackets have galvanic connections from the busbar to the support rail or to the mounting block</li> <li>Busbar 10 x 3 mm</li> </ul>						
<b>Terminal diameter 3 ... 8 mm</b>						
<b>Shield terminal, terminal diameter 3 ... 8 mm</b>						
Versions						
<ul style="list-style-type: none"> <li>For direct shield attachment on conductive mounting plate               <ul style="list-style-type: none"> <li>Sheet thickness 1 ... 2 mm</li> </ul> </li> <li>For busbars</li> </ul>						
		<b>8WH9130-0AA0</b>		1 10 units	1BT	
		<b>8WH9130-0LA00</b>		1 10 units	1BT	
8WH9130-0AA0						
8WH9130-0LA00						
<b>Terminal diameter 3 ... 14 mm</b>						
<b>Shield terminal, terminal diameter 3 ... 14 mm</b>						
Versions						
<ul style="list-style-type: none"> <li>For direct shield attachment on conductive mounting plate               <ul style="list-style-type: none"> <li>Sheet thickness 1 ... 2 mm</li> </ul> </li> <li>For busbars</li> </ul>						
		<b>8WH9130-0BA00</b>		1 10 units	1BT	
		<b>8WH9130-0MA00</b>		1 10 units	1BT	
8WH9130-0BA00						
8WH9130-0MA00						





# 8WH1 Screw Terminals

## 8WH shield terminals

Version	DT	Article No. <a href="http://www.siemens.com/product?Article No.">www.siemens.com/ product?Article No.</a>	Price per PU	PU (UNIT, SET, M)	PS*/ P. unit	PG
<b>Terminal diameter 3 ... 20 mm</b>						
 <p>8WH9130-0CA00</p>	<b>Shield terminal, terminal diameter 3 ... 20 mm</b> Versions <ul style="list-style-type: none"> <li>• For direct shield attachment on conductive mounting plate - Sheet thickness 1 ... 2 mm</li> <li>• For busbars</li> </ul>		<b>8WH9130-0CA00</b>  <b>8WH9130-0NA00</b>	1	10 units	1BT
	 <p>8WH9130-0NA00</p>			1	10 units	1BT
<b>Terminal diameter 20 ... 35 mm</b>						
 <p>8WH9130-0DA00</p>	<b>Shield terminal, terminal diameter 20 ... 35 mm</b> Versions <ul style="list-style-type: none"> <li>• For direct shield attachment on conductive mounting plate - Sheet thickness 1 ... 2 mm</li> <li>• For busbars</li> </ul>		<b>8WH9130-0DA00</b>  <b>8WH9130-0PA00</b>	1	10 units	1BT
	 <p>8WH9130-0PA00</p>			1	10 units	1BT

7



Version	DT	Article No. <a href="http://www.siemens.com/product?Article No.">www.siemens.com/ product?Article No.</a>	Price per PU	PU (UNIT, SET, M)	PS*/ P. unit	PG
<b>Accessories</b>						
 8WH9140-0DA00						
<b>Support brackets</b>						
Versions						
		<ul style="list-style-type: none"> <li>For terminal diameter 8 ... 35 mm, made of molded plastic and conductive connection               <ul style="list-style-type: none"> <li>- With retaining screw</li> <li>- For 10 x 3 mm busbars</li> </ul> </li> </ul>				
 8WH9140-0BA00		<ul style="list-style-type: none"> <li>For terminal diameter 8 ... 20 mm, for mounting rail with clearance of approx. 30 mm to the busbar               <ul style="list-style-type: none"> <li>- For 10 x 3 mm busbars</li> </ul> </li> </ul>				
 8WH9140-0CA00		<ul style="list-style-type: none"> <li>For terminal diameter 8 ... 20 mm, for mounting rail with clearance of approx. 65 mm to the busbar               <ul style="list-style-type: none"> <li>- For 10 x 3 mm busbars</li> </ul> </li> </ul>				
<b>N-busbars, 10 x 3 mm</b>						
		<ul style="list-style-type: none"> <li>Copper, aluminum</li> <li>1000 mm long</li> </ul>				
 8WA2842						
		<b>8WH9140-0DA00</b>		1	10 units	1BT
		<b>8WH9140-0BA00</b>		1	10 units	1BT
		<b>8WH9140-0CA00</b>		1	10 units	1BT
		<b>8WA2842</b>		1	1 unit	1BT

For general accessories for 8WH terminal blocks, see chapter "Accessories for 8WH Terminal Blocks"

# 8WH1 Screw Terminals

## 8WH shield terminals

### Dimensional drawings

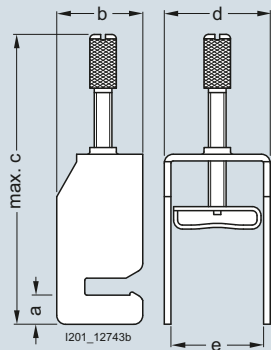

	a	b	c	d	e
8WH9130-0LA00	6,5	19,5	48,7	12,0	9,0
8WH9130-0MA00	6,5	19,5	59,3	17,0	14,0
8WH9130-0NA00	6,5	19,5	75,0	24,0	21,0
8WH9130-0PA00	6,5	20,0	106,5	40,0	36,0
8WH9130-0AA00	6,5	19,5	47,2	12,0	9,0
8WH9130-0BA00	6,5	19,5	57,8	17,0	14,0
8WH9130-0CA00	6,5	19,5	73,5	24,0	21,0
8WH9130-0DA00	6,5	20,0	105,0	40,0	36,0

Shield terminals

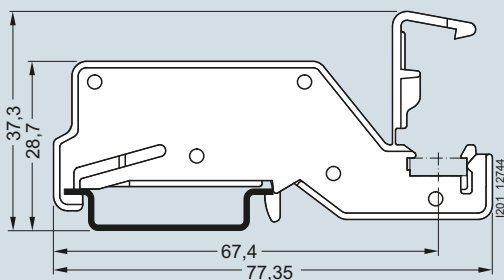

8WH9140-0BA00

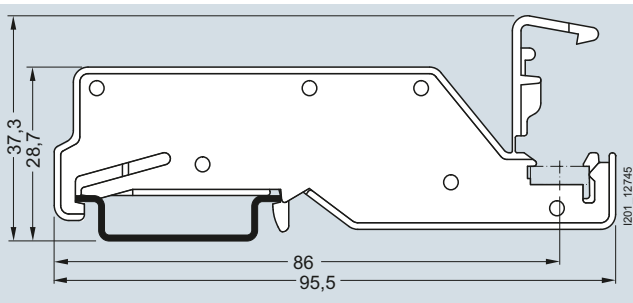

8WH9140-0CA00

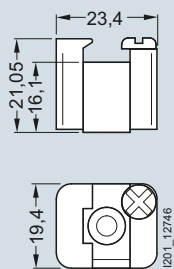

8WH9140-0DA00

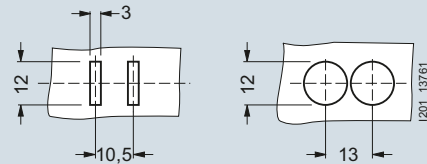

Punching template and drill plan for 8WH9130-0AA00

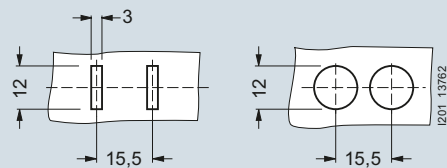

Punching template and drill plan for 8WH9130-0BA00

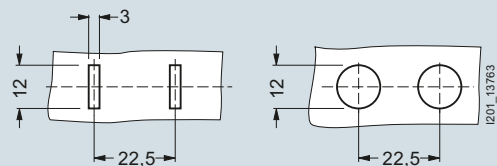

Punching template and drill plan for 8WH9130-0CA00

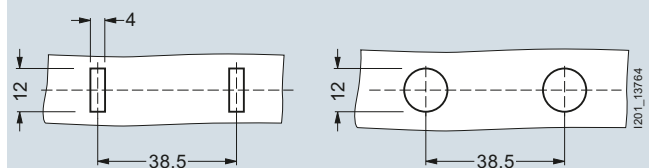

Punching template and drill plan for 8WH9130-0DA00

## Accessories for 8WH Terminal Blocks

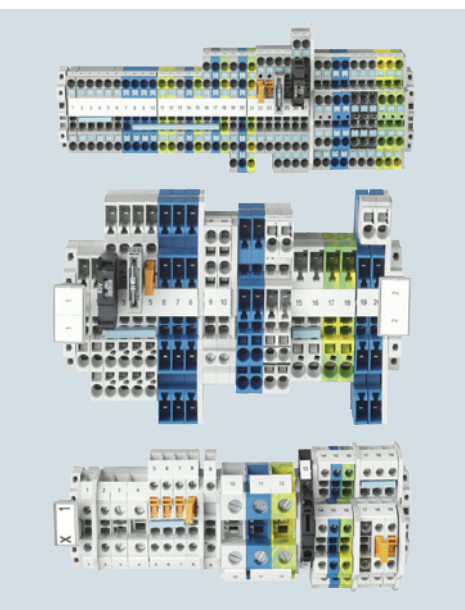

8/2 **Accessories for the labeling system**

8/3 **Standard labeling system**

8/8 **Mounting accessories**

### For further technical product information:

Siemens Industry Online Support:  
[www.siemens.com/lowvoltage/product-support](http://www.siemens.com/lowvoltage/product-support)

- Application example
- Certificate
- Characteristic
- Download
- FAQ
- Manual
- Product note
- Software archive
- Technical data

## Accessories for 8WH Terminal Blocks

### Accessories for the labeling system

#### Selection and ordering data

##### Labeling system for individual inscription

Labeling systems for

- Terminal blocks
- Modular installation devices
- Circuit breakers
- Switch disconnectors

Available from:

Murrplastik Systemtechnik GmbH  
Postfach 1143  
D-71570 Oppenweiler  
Telephone: +49 (0)7191-482-0  
e-mail: info@murrplastik.de

##### Accessories for the labeling system

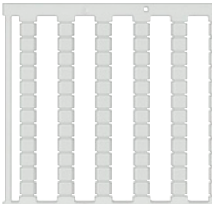
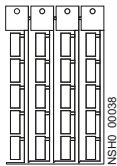
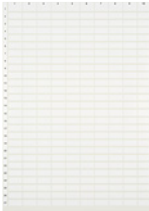

Version	DT	Article No. <a href="http://www.siemens.com/product?Article No.">www.siemens.com/ product?Article No.</a>	Price per PU	PU (UNIT, SET, M)	PS*/ P. unit	PG
 <p>8WH8113-1AA05</p>	<b>Blank labels for 8WH8 terminal blocks</b>					
	<b>Versions</b>					
	<ul style="list-style-type: none"> <li>• Front               <ul style="list-style-type: none"> <li>- For terminal width 4.2 mm (WIN 97)</li> <li>- For terminal width 5.2 and 6.2 mm (WIN 88)</li> <li>- For terminal width 8.2, 10, 12 and 16 mm (WIN 40)</li> </ul> </li> <li>• Flat               <ul style="list-style-type: none"> <li>- For terminal width 4.2 mm (WIN 180), 5.2 mm (WIN 182), 6.2 mm (WIN 184), 8.2 mm (WIN 186) and 10 mm (WIN 188)</li> <li>- For 12 and 16 mm terminal width (WIN 46Z)</li> </ul> </li> </ul>		<b>8WH8112-1AA05</b> <b>8WH8112-2AA05</b> <b>8WH8112-4AA05</b>	100 1024 units 100 1400 units 100 1000 units	1BT 1BT 1BT	
			<b>8WH8113-1AA05</b> <b>8WH8113-6AA05</b>	100 2000 units 100 1080 units	1BT 1BT	
 <p>NSHDO_00038</p>	<b>Snap-on device labels</b>					
	For identification of e.g. <ul style="list-style-type: none"> <li>• Circuit breakers</li> <li>• Contactors</li> <li>• Controllers</li> </ul>					
	<b>Versions</b> <ul style="list-style-type: none"> <li>• 20 x 7, white, snap-on hooks at side (WIN 95)</li> <li>• 20 x 7, turquoise, snap-on hooks at side (WIN 95)</li> </ul>		<b>8WH8210-0AA55</b> <b>8WH8210-0AA56</b>	100 340 units 100 340 units	1BT 1BT	
	<b>Adhesive device labels</b>					
	For identification of e.g. <ul style="list-style-type: none"> <li>• Modular installation devices</li> <li>• Switch disconnectors</li> </ul>					
	<b>Versions</b> <ul style="list-style-type: none"> <li>• 15 x 6 mm, white (WIN 098)</li> <li>• 15 x 6 mm, yellow (WIN 099)</li> <li>• 19 x 8 mm, white (WIN 088)</li> <li>• 19 x 8 mm, yellow (WIN 082)</li> </ul>		<b>8WH8210-0AA35</b> <b>8WH8210-0AA36</b> <b>8WH8210-0AA45</b> <b>8WH8210-0AA46</b>	100 3740 units 100 3740 units 100 2700 units 100 2700 units	1BT 1BT 1BT 1BT	

#### Note:

The labels can be written by hand or using Murrplastik labeling systems.

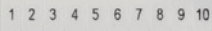
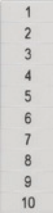

The WIN designation simplifies the assignment in the labeling software.

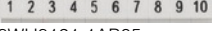
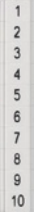
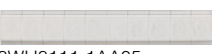
## Selection and ordering data





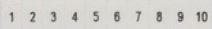
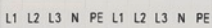

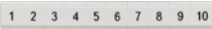
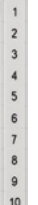
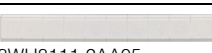
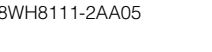
Version	DT	Article No. <a href="http://www.siemens.com/product?ArticleNo.">www.siemens.com/ product?Article No.</a>	Price per PU	PU (UNIT, SET, M)	PS*/ P. unit	PG
 <p><b>Labels, front, for terminal width 4.2 mm and terminal size 1.5 mm<sup>2</sup> (excluding 8WH3), horizontal labeling</b></p> <p>Versions</p> <ul style="list-style-type: none"> <li>Incremental numbering           <ul style="list-style-type: none"> <li>- 1 ... 10 (10x)</li> <li>- 11 ... 20 (10x)</li> <li>- 21 ... 30 (10x)</li> <li>- 31 ... 40 (10x)</li> <li>- 41 ... 50 (10x)</li> <li>- 51 ... 60 (10x)</li> <li>- 61 ... 70 (10x)</li> <li>- 71 ... 80 (10x)</li> <li>- 81 ... 90 (10x)</li> <li>- 91 ... 100 (10x)</li> </ul> </li> <li>Custom inscription</li> </ul>		<b>8WH8120-1A□□□</b> ▲▲▲ <b>B05</b> <b>B15</b> <b>B25</b> <b>B35</b> <b>B45</b> <b>B55</b> <b>B65</b> <b>B75</b> <b>B85</b> <b>C05</b>		100	100 units	1BT
8WH8120-1AB05		<b>8WH8120-1XA05</b>		100	100 units	1BT
 <p><b>Labels, front, for terminal width 4.2 mm and terminal size 1.5 mm<sup>2</sup> (excluding 8WH3), vertical labeling</b></p> <p>Versions</p> <ul style="list-style-type: none"> <li>Incremental numbering           <ul style="list-style-type: none"> <li>- 1 ... 10 (10x)</li> <li>- 11 ... 20 (10x)</li> <li>- 21 ... 30 (10x)</li> <li>- 31 ... 40 (10x)</li> </ul> </li> <li>Custom inscription</li> </ul>		<b>8WH8140-1A□□□</b> ▲▲▲ <b>B05</b> <b>B15</b> <b>B25</b> <b>B35</b>		100	100 units	1BT
8WH8140-1AB05		<b>8WH8140-1XA05</b>		100	100 units	1BT
 <p><b>Labels, front, for terminal width 4.2 mm and terminal size 1.5 mm<sup>2</sup> (excluding 8WH3), blank</b></p>		<b>8WH8110-1AA05</b>		100	100 units	1BT
8WH8110-1AA05						
 <p><b>Labels, flat, for terminal width 4.2 mm and terminal size 1.5 mm<sup>2</sup> (excluding 8WH3), horizontal labeling</b></p> <p>Versions</p> <ul style="list-style-type: none"> <li>Incremental numbering           <ul style="list-style-type: none"> <li>- 1 ... 10 (10x)</li> <li>- 11 ... 20 (10x)</li> <li>- 21 ... 30 (10x)</li> <li>- 31 ... 40 (10x)</li> <li>- 41 ... 50 (10x)</li> <li>- 51 ... 60 (10x)</li> <li>- 61 ... 70 (10x)</li> <li>- 71 ... 80 (10x)</li> <li>- 81 ... 90 (10x)</li> <li>- 91 ... 100 (10x)</li> </ul> </li> <li>Custom inscription</li> </ul>		<b>8WH8121-1A□□□</b> ▲▲▲ <b>B05</b> <b>B15</b> <b>B25</b> <b>B35</b> <b>B45</b> <b>B55</b> <b>B65</b> <b>B75</b> <b>B85</b> <b>C05</b>		100	100 units	1BT
8WH8121-1AB05		<b>8WH8121-1XA05</b>		100	100 units	1BT
 <p><b>Labels, flat, for terminal width 4.2 mm and terminal size 1.5 mm<sup>2</sup> (excluding 8WH3), vertical labeling</b></p> <p>Versions</p> <ul style="list-style-type: none"> <li>Incremental numbering           <ul style="list-style-type: none"> <li>- 1 ... 10 (10x)</li> <li>- 11 ... 20 (10x)</li> <li>- 21 ... 30 (10x)</li> <li>- 31 ... 40 (10x)</li> <li>- 41 ... 50 (10x)</li> </ul> </li> <li>Custom inscription</li> </ul>		<b>8WH8141-1A□□□</b> ▲▲▲ <b>B05</b> <b>B15</b> <b>B25</b> <b>B35</b> <b>B45</b>		100	100 units	1BT
8WH8141-1AB05		<b>8WH8141-1XA05</b>		100	100 units	1BT
 <p><b>Labels, flat, for terminal width 4.2 mm and terminal size 1.5 mm<sup>2</sup> (excluding 8WH3), blank</b></p>		<b>8WH8111-1AA05</b>		100	100 units	1BT
8WH8111-1AA05						

## Accessories for 8WH Terminal Blocks

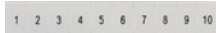
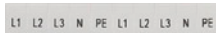
## Standard labeling system

Version	DT	Article No. <a href="http://www.siemens.com/product?Article.No.">www.siemens.com/ product?Article.No.</a>	Price per PU	PU (UNIT, SET, M)	PS*/ P. unit	PG
 <p><b>Labels, front, for terminal width 5.2 mm and terminal size 2.5 mm<sup>2</sup> (8WH3: 1.5 mm<sup>2</sup>), horizontal labeling</b></p> <p>8WH8120-2AB05</p> <p>Versions</p> <ul style="list-style-type: none"> <li>Incremental numbering           <ul style="list-style-type: none"> <li>- 1 ... 10 (10x)</li> <li>- 11 ... 20 (10x)</li> <li>- 21 ... 30 (10x)</li> <li>- 31 ... 40 (10x)</li> <li>- 41 ... 50 (10x)</li> <li>- 51 ... 60 (10x)</li> <li>- 61 ... 70 (10x)</li> <li>- 71 ... 80 (10x)</li> <li>- 81 ... 90 (10x)</li> <li>- 91 ... 100 (10x)</li> </ul> </li> <li>L1/L2/L3/N/PE</li> <li>Custom inscription</li> </ul>		<b>8WH8120-2A□□□</b> ▲▲▲ <b>B05</b> <b>B15</b> <b>B25</b> <b>B35</b> <b>B45</b> <b>B55</b> <b>B65</b> <b>B75</b> <b>B85</b> <b>C05</b> <b>A15</b>		100	100 units	1BT
 <p>8WH8120-2AA15</p> <p>Versions</p> <ul style="list-style-type: none"> <li>Incremental numbering           <ul style="list-style-type: none"> <li>- 1 ... 10 (10x)</li> <li>- 11 ... 20 (10x)</li> <li>- 21 ... 30 (10x)</li> <li>- 31 ... 40 (10x)</li> <li>- 41 ... 50 (10x)</li> <li>- 51 ... 60 (10x)</li> <li>- 61 ... 70 (10x)</li> <li>- 71 ... 80 (10x)</li> <li>- 81 ... 90 (10x)</li> <li>- 91 ... 100 (10x)</li> </ul> </li> <li>L1/L2/L3/N/PE</li> <li>Custom inscription</li> </ul>		<b>8WH8120-2XA05</b>		100	100 units	1BT
 <p>8WH8140-2AB05</p> <p>Versions</p> <ul style="list-style-type: none"> <li>Incremental numbering           <ul style="list-style-type: none"> <li>- 1 ... 10 (10x)</li> <li>- 11 ... 20 (10x)</li> <li>- 21 ... 30 (10x)</li> <li>- 31 ... 40 (10x)</li> <li>- 41 ... 50 (10x)</li> <li>- 51 ... 60 (10x)</li> <li>- 61 ... 70 (10x)</li> <li>- 71 ... 80 (10x)</li> <li>- 81 ... 90 (10x)</li> <li>- 91 ... 100 (10x)</li> </ul> </li> <li>Custom inscription</li> </ul>		<b>8WH8140-2A□□□</b> ▲▲▲ <b>B05</b> <b>B15</b> <b>B25</b> <b>B35</b> <b>B45</b> <b>B55</b> <b>B65</b> <b>B75</b> <b>B85</b> <b>C05</b>		100	100 units	1BT
 <p>8WH8110-2AA05</p> <p>Versions</p> <ul style="list-style-type: none"> <li>Custom inscription</li> </ul>		<b>8WH8110-2XA05</b>		100	100 units	1BT
 <p>8WH8121-2AB15</p> <p>Versions</p> <ul style="list-style-type: none"> <li>Incremental numbering           <ul style="list-style-type: none"> <li>- 1 ... 10 (10x)</li> <li>- 11 ... 20 (10x)</li> <li>- 21 ... 30 (10x)</li> <li>- 31 ... 40 (10x)</li> <li>- 41 ... 50 (10x)</li> <li>- 51 ... 60 (10x)</li> <li>- 61 ... 70 (10x)</li> <li>- 71 ... 80 (10x)</li> <li>- 81 ... 90 (10x)</li> <li>- 91 ... 100 (10x)</li> </ul> </li> <li>Custom inscription</li> </ul>		<b>8WH8121-2A□□□</b> ▲▲▲ <b>B05</b> <b>B15</b> <b>B25</b> <b>B35</b> <b>B45</b> <b>B55</b> <b>B65</b> <b>B75</b> <b>B85</b> <b>C05</b>		100	100 units	1BT
 <p>8WH8141-2AB15</p> <p>Versions</p> <ul style="list-style-type: none"> <li>Incremental numbering           <ul style="list-style-type: none"> <li>- 1 ... 10 (10x)</li> <li>- 11 ... 20 (10x)</li> <li>- 21 ... 30 (10x)</li> <li>- 31 ... 40 (10x)</li> <li>- 41 ... 50 (10x)</li> <li>- 51 ... 60 (10x)</li> <li>- 61 ... 70 (10x)</li> <li>- 71 ... 80 (10x)</li> <li>- 81 ... 90 (10x)</li> <li>- 91 ... 100 (10x)</li> </ul> </li> <li>Custom inscription</li> </ul>		<b>8WH8141-2A□□□</b> ▲▲▲ <b>B05</b> <b>B15</b> <b>B25</b> <b>B35</b> <b>B45</b> <b>B55</b> <b>B65</b> <b>B75</b> <b>B85</b> <b>C05</b>		100	100 units	1BT
 <p>8WH8111-2AA05</p> <p>Versions</p> <ul style="list-style-type: none"> <li>Custom inscription</li> </ul>		<b>8WH8111-2XA05</b>		100	100 units	1BT
 <p>8WH8111-2AA05</p> <p>Versions</p> <ul style="list-style-type: none"> <li>Custom inscription</li> </ul>		<b>8WH8111-2AA05</b>		100	100 units	1BT

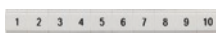
## Standard labeling system

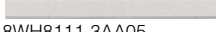
Version	DT	Article No. <a href="http://www.siemens.com/product?ArticleNo">www.siemens.com/ product?Article No.</a>	Price per PU	PU (UNIT, SET, M)	PS*/ P. unit	PG
 <p>8WH8120-3AB05</p>  <p>8WH8120-3AA15</p>  <p>8WH8120-3AA25</p> <p><b>Labels, front, for terminal width 6.2 mm and terminal size 4 mm<sup>2</sup> (8WH3: 2.5 mm<sup>2</sup>), horizontal labeling</b></p> <p>Versions</p> <ul style="list-style-type: none"> <li>• Incremental numbering <ul style="list-style-type: none"> <li>- 1 ... 10 (10×)</li> <li>- 11 ... 20 (10×)</li> <li>- 21 ... 30 (10×)</li> <li>- 31 ... 40 (10×)</li> <li>- 41 ... 50 (10×)</li> <li>- 51 ... 60 (10×)</li> <li>- 61 ... 70 (10×)</li> <li>- 71 ... 80 (10×)</li> <li>- 81 ... 90 (10×)</li> <li>- 91 ... 100 (10×)</li> </ul> </li> <li>• L1/L2/L3/N/PE</li> <li>• U/V/W/N/grounding</li> <li>• Custom inscription</li> </ul>		<p><b>8WH8120-3A□□□</b></p> <p>▲▲▲</p> <p><b>B05</b></p> <p><b>B15</b></p> <p><b>B25</b></p> <p><b>B35</b></p> <p><b>B45</b></p> <p><b>B55</b></p> <p><b>B65</b></p> <p><b>B75</b></p> <p><b>B85</b></p> <p><b>C05</b></p> <p><b>A15</b></p> <p><b>A25</b></p> <p><b>8WH8120-3XA05</b></p>		100	100 units	1BT
 <p>8WH8140-3AB05</p> <p><b>Labels, front, for terminal width 6.2 mm and terminal size 4 mm<sup>2</sup> (8WH3: 2.5 mm<sup>2</sup>), vertical labeling</b></p> <p>Versions</p> <ul style="list-style-type: none"> <li>• Incremental numbering <ul style="list-style-type: none"> <li>- 1 ... 10 (10×)</li> <li>- 11 ... 20 (10×)</li> <li>- 21 ... 30 (10×)</li> <li>- 31 ... 40 (10×)</li> <li>- 41 ... 50 (10×)</li> <li>- 51 ... 60 (10×)</li> <li>- 61 ... 70 (10×)</li> <li>- 71 ... 80 (10×)</li> <li>- 81 ... 90 (10×)</li> <li>- 91 ... 100 (10×)</li> </ul> </li> <li>• Custom inscription</li> </ul>		<p><b>8WH8140-3A□□□</b></p> <p>▲▲▲</p> <p><b>B05</b></p> <p><b>B15</b></p> <p><b>B25</b></p> <p><b>B35</b></p> <p><b>B45</b></p> <p><b>B55</b></p> <p><b>B65</b></p> <p><b>B75</b></p> <p><b>B85</b></p> <p><b>C05</b></p> <p><b>8WH8140-3XA05</b></p>		100	100 units	1BT
 <p>8WH8110-3AA05</p> <p><b>Labels, front, for terminal width 6.2 mm and terminal size 4 mm<sup>2</sup> (8WH3: 2.5 mm<sup>2</sup>), blank</b></p>		<b>8WH8110-3AA05</b>		100	100 units	1BT
 <p>8WH8121-3AB05</p> <p><b>Labels, flat, for terminal width 6.2 mm and terminal size 4 mm<sup>2</sup> (8WH3: 2.5 mm<sup>2</sup>), horizontal labeling</b></p> <p>Versions</p> <ul style="list-style-type: none"> <li>• Incremental numbering <ul style="list-style-type: none"> <li>- 1 ... 10 (10×)</li> <li>- 11 ... 20 (10×)</li> <li>- 21 ... 30 (10×)</li> <li>- 31 ... 40 (10×)</li> <li>- 41 ... 50 (10×)</li> <li>- 51 ... 60 (10×)</li> <li>- 61 ... 70 (10×)</li> <li>- 71 ... 80 (10×)</li> <li>- 81 ... 90 (10×)</li> <li>- 91 ... 100 (10×)</li> </ul> </li> <li>• Custom inscription</li> </ul>		<p><b>8WH8121-3A□□□</b></p> <p>▲▲▲</p> <p><b>B05</b></p> <p><b>B15</b></p> <p><b>B25</b></p> <p><b>B35</b></p> <p><b>B45</b></p> <p><b>B55</b></p> <p><b>B65</b></p> <p><b>B75</b></p> <p><b>B85</b></p> <p><b>C05</b></p> <p><b>8WH8121-3XA05</b></p>		100	100 units	1BT
 <p>8WH8141-3AB05</p> <p><b>Labels, flat, for terminal width 6.2 mm and terminal size 4 mm<sup>2</sup> (8WH3: 2.5 mm<sup>2</sup>), vertical labeling</b></p> <p>Versions</p> <ul style="list-style-type: none"> <li>• Incremental numbering <ul style="list-style-type: none"> <li>- 1 ... 10 (10×)</li> </ul> </li> <li>• Custom inscription</li> </ul>		<p><b>8WH8141-3AB05</b></p> <p><b>8WH8141-3XA05</b></p>		100	100 units	1BT
 <p>8WH8111-3AA05</p> <p><b>Labels, flat, for terminal width 6.2 mm and terminal size 4 mm<sup>2</sup> (8WH3: 2.5 mm<sup>2</sup>), blank</b></p>		<b>8WH8111-3AA05</b>		100	100 units	1BT

## Accessories for 8WH Terminal Blocks











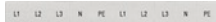

## Standard labeling system

	Version	DT	Article No. <a href="http://www.siemens.com/product?Article.No.">www.siemens.com/ product?Article.No.</a>	Price per PU	PU (UNIT, SET, M)	PS*/ P. unit	PG
1 2 3 4 5 6 7 8 9 10	<b>Labels, front, for terminal width 8.2 mm and terminal size 6 mm<sup>2</sup>, horizontal labeling</b>						
8WH8120-4AB05	<b>Versions</b> <ul style="list-style-type: none"> <li>Incremental numbering           <ul style="list-style-type: none"> <li>- 1 ... 10 (10x)</li> <li>- 11 ... 20 (10x)</li> <li>- 21 ... 30 (10x)</li> <li>- 31 ... 40 (10x)</li> <li>- 41 ... 50 (10x)</li> <li>- 51 ... 60 (10x)</li> <li>- 61 ... 70 (10x)</li> <li>- 71 ... 80 (10x)</li> <li>- 81 ... 90 (10x)</li> <li>- 91 ... 100 (10x)</li> </ul> </li> <li>L1/L2/L3/N/PE</li> <li>Custom inscription</li> </ul>		<b>8WH8120-4A□□□</b> ▲▲▲ <b>B05</b> <b>B15</b> <b>B25</b> <b>B35</b> <b>B45</b> <b>B55</b> <b>B65</b> <b>B75</b> <b>B85</b> <b>C05</b> <b>A15</b>		100	100 units	1BT
L1 L2 L3 N PE L1 L2 L3 N PE	8WH8120-4AA15						
1	<b>Labels, front, for terminal width 8.2 mm and terminal size 6 mm<sup>2</sup>, vertical labeling</b>						
2	<b>Versions</b>						
3	<ul style="list-style-type: none"> <li>Incremental numbering           <ul style="list-style-type: none"> <li>- 1 ... 10 (10x)</li> <li>- 11 ... 20 (10x)</li> <li>- 21 ... 30 (10x)</li> </ul> </li> <li>Custom inscription</li> </ul>		<b>8WH8140-4A□□□</b> ▲▲▲ <b>B05</b> <b>B15</b> <b>B25</b>		100	100 units	1BT
4	8WH8140-4AB05						
5							
6							
7							
8							
9							
10							
	<b>Labels, front, for terminal width 8.2 mm and terminal size 6 mm<sup>2</sup>, blank</b>						
	8WH8110-4AA05				100	100 units	1BT
1 2 3 4 5 6 7 8 9 10	<b>Labels, flat, for terminal width 8.2 mm and terminal size 6 mm<sup>2</sup>, horizontal labeling</b>						
8WH8121-4AB05	<b>Versions</b> <ul style="list-style-type: none"> <li>Incremental numbering           <ul style="list-style-type: none"> <li>- 1 ... 10 (10x)</li> <li>- 11 ... 20 (10x)</li> <li>- 21 ... 30 (10x)</li> </ul> </li> <li>Custom inscription</li> </ul>		<b>8WH8121-4A□□□</b> ▲▲▲ <b>B05</b> <b>B15</b> <b>B25</b>		100	100 units	1BT
	<b>Labels, flat, for terminal width 8.2 mm and terminal size 6 mm<sup>2</sup>, vertical labeling</b>						
	<b>Versions</b>						
	<ul style="list-style-type: none"> <li>Incremental numbering           <ul style="list-style-type: none"> <li>- 1 ... 10 (10x)</li> <li>- 11 ... 20 (10x)</li> <li>- 21 ... 30 (10x)</li> </ul> </li> <li>Custom inscription</li> </ul>		<b>8WH8141-4A□□□</b> ▲▲▲ <b>B05</b> <b>B15</b> <b>B25</b>		100	100 units	1BT
	<b>Labels, flat, for terminal width 8.2 mm and terminal size 6 mm<sup>2</sup>, blank</b>						
	8WH8111-4AA05				100	100 units	1BT

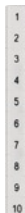
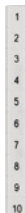

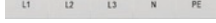
## Accessories for 8WH Terminal Blocks





## Standard labeling system

Version	DT	Article No. <a href="http://www.siemens.com/product?Article.No.">www.siemens.com/ product?Article.No.</a>	Price per PU	PU (UNIT, SET, M)	PS*/ P. unit	PG
 <b>Labels, front, for terminal width 10 and 12 mm and terminal sizes 10 and 16 mm<sup>2</sup>, horizontal labeling</b> 8WH8120-5AB05 <b>Versions</b> <ul style="list-style-type: none"> <li>• Incremental numbering               <ul style="list-style-type: none"> <li>- 1 ... 10 (10×)</li> <li>- 11 ... 20 (10×)</li> <li>- 21 ... 30 (10×)</li> <li>- 31 ... 40 (10×)</li> </ul> </li> <li>• L1/L2/L3/N/PE</li> <li>• U/V/W/N/grounding</li> <li>• Custom inscription</li> </ul>		<b>8WH8120-5A□□□</b> ▲▲▲▲ <b>B05</b> <b>B15</b> <b>B25</b> <b>B35</b> <b>A15</b> <b>A25</b>		100	100 units	1BT
 8WH8120-5AA15  8WH8120-5AA25		<b>8WH8120-5XA05</b>		100	100 units	1BT
 <b>Labels, front, for terminal width 10 and 12 mm and terminal sizes 10 and 16 mm<sup>2</sup>, vertical labeling</b> 8WH8140-5AB05 <b>Versions</b> <ul style="list-style-type: none"> <li>• Incremental numbering               <ul style="list-style-type: none"> <li>- 1 ... 10 (10×)</li> <li>- 11 ... 20 (10×)</li> <li>- 21 ... 30 (10×)</li> <li>- 31 ... 40 (10×)</li> </ul> </li> <li>• Custom inscription</li> </ul>		<b>8WH8140-5A□□□</b> ▲▲▲▲ <b>B05</b> <b>B15</b> <b>B25</b> <b>B35</b>		100	100 units	1BT
 8WH8140-5AA05		<b>8WH8140-5XA05</b>		100	100 units	1BT
 <b>Labels, front, for terminal width 10 and 12 mm and terminal sizes 10 and 16 mm<sup>2</sup>, blank</b> 8WH8110-5AA05		<b>8WH8110-5AA05</b>		100	100 units	1BT
 <b>Labels, flat, for terminal width 10 and 12 mm and terminal sizes 10 and 16 mm<sup>2</sup>, horizontal labeling</b> 8WH8121-5AB05 <b>Versions</b> <ul style="list-style-type: none"> <li>• Incremental numbering               <ul style="list-style-type: none"> <li>- 1 ... 10 (10×)</li> <li>- 11 ... 20 (10×)</li> <li>- 21 ... 30 (10×)</li> </ul> </li> <li>• Custom inscription</li> </ul>		<b>8WH8121-5A□□□</b> ▲▲▲▲ <b>B05</b> <b>B15</b> <b>B25</b>		100	100 units	1BT
 8WH8121-5AA05		<b>8WH8121-5XA05</b>		100	100 units	1BT
 <b>Labels, flat, for terminal width 10 and 12 mm and terminal sizes 10 and 16 mm<sup>2</sup>, vertical labeling</b> 8WH8141-5AB05 <b>Versions</b> <ul style="list-style-type: none"> <li>• Incremental numbering               <ul style="list-style-type: none"> <li>- 1 ... 10 (10×)</li> </ul> </li> <li>• Custom inscription</li> </ul>		<b>8WH8141-5AB05</b> <b>8WH8141-5XA05</b>		100	100 units	1BT
 8WH8141-5AA05		<b>8WH8141-5XA05</b>		100	100 units	1BT
 <b>Labels, flat, for terminal width 10 and 12 mm and terminal sizes 10 and 16 mm<sup>2</sup>, blank</b> 8WH8111-5AA05		<b>8WH8111-5AA05</b>		100	100 units	1BT
 <b>Labels, front, for terminal width 16 mm and terminal size 35 mm<sup>2</sup>, horizontal labeling</b> 8WH8120-7AA15 <b>Versions</b> <ul style="list-style-type: none"> <li>• L1/L2/L3/N/PE</li> <li>• Custom inscription</li> </ul>		<b>8WH8120-7AA15</b> <b>8WH8120-7XA05</b>		100	50 units	1BT
 8WH8120-7AA05		<b>8WH8120-7XA05</b>		100	100 units	1BT
 <b>Labels, front, for terminal width 16 mm and terminal size 35 mm<sup>2</sup>, vertical labeling, custom labeling</b>		<b>8WH8140-7XA05</b>		100	100 units	1BT
 <b>Labels, front, for terminal width 16 mm and terminal size 35 mm<sup>2</sup>, blank</b> 8WH8110-7AA05		<b>8WH8110-7AA05</b>		100	100 units	1BT
 <b>Labels, flat, for terminal width 16 mm and terminal size 35 mm<sup>2</sup>, blank</b>		<b>8WH8111-7AA05</b>		100	100 units	1BT

## Accessories for 8WH Terminal Blocks

### Mounting accessories

#### Selection and ordering data

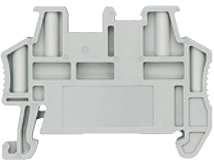
Version	DT	Article No. <a href="http://www.siemens.com/product?Article No.">www.siemens.com/ product?Article No.</a>	Price per PU	PU (UNIT, SET, M)	PS*/ P. unit	PG
 <b>Modular test plugs</b> For individual assembly of test plug connectors Versions <ul style="list-style-type: none"> <li>• For terminal width 5.2 mm and terminal size 2.5 mm<sup>2</sup> 1)</li> <li>• For terminal width 6.2 mm and terminal size 6 mm<sup>2</sup> 1)</li> </ul>		<b>8WH9010-0EB02</b>		1	10 units	1BT
		<b>8WH9010-0FB02</b>		1	10 units	1BT
8WH9010-0DB02						
 <b>Spacer plates</b> For leaving out single terminals for individual test plug assembly Versions <ul style="list-style-type: none"> <li>• For terminal width 5.2 mm and terminal size 2.5 mm<sup>2</sup> 1)</li> <li>• For terminal width 6.2 mm and terminal size 6 mm<sup>2</sup> 1)</li> </ul>		<b>8WH9010-2BA02</b>		1	10 units	1BT
		<b>8WH9010-2CA02</b>		1	10 units	1BT
8WH9010-2AA02						
 <b>Terminal strip markers, for end retainers</b> <ul style="list-style-type: none"> <li>• Height-adjustable</li> <li>• For quick-fit end retainers</li> <li>• Facility for labeling with terminal strip marker or two labels, front, for terminal width 10.2 mm</li> <li>• Labeling field size: 20 x 8 mm</li> </ul>		<b>8WH9150-1CA00</b>		1	100 units	1BT
8WH9150-1CA00						
 <b>Test adapters</b> <ul style="list-style-type: none"> <li>• For 4 mm Ø PS test plugs and 4 mm Ø safety test plugs</li> <li>• Makes contact in the bridge shaft</li> </ul>		<b>8WH9010-0JB00</b>		1	10 units	1BT
8WH9010-0JB00						
 <b>Reducing combs</b> Versions <ul style="list-style-type: none"> <li>• For bridging of a through-type terminal, terminal size 2.5 or 4 mm<sup>2</sup> <ul style="list-style-type: none"> <li>- For a through-type terminal, terminal size 1.5 mm<sup>2</sup></li> <li>- For a through-type terminal, terminal size 6 mm<sup>2</sup></li> <li>- For a through-type terminal, terminal size 10 mm<sup>2</sup></li> <li>- For a through-type terminal, terminal size 16 mm<sup>2</sup></li> <li>- For a through-type terminal, terminal size 35 mm<sup>2</sup></li> </ul> </li> <li>• For bridging of a through-type terminal, terminal size 16 mm<sup>2</sup> <ul style="list-style-type: none"> <li>- For a through-type terminal, terminal size 35 mm<sup>2</sup></li> </ul> </li> </ul> Note Not for 8WH1 through-type terminals and 8WH3 insulation displacement terminals.		<b>8WH9020-0CC10</b>		1	10 units	1BT
		<b>8WH9020-0FC10</b>		1	10 units	1BT
		<b>8WH9020-0AC10</b>		1	10 units	1BT
		<b>8WH9020-0BC10</b>		1	10 units	1BT
		<b>8WH9020-0EC10</b>		1	10 units	1BT
		<b>8WH9020-0DC10</b>		1	10 units	1BT
	8WH9020-0FC10					
 <b>Quick-fit end retainers</b> Facility for labeling with labels, front, for terminal width 5.2 mm and terminal strip marker		<b>8WH9150-0CA00</b>		1	50 units	1BT
8WH9150-0CA00						

1) Excluding 8WH3

## Accessories for 8WH Terminal Blocks

## Mounting accessories

Version	DT	Article No. <a href="http://www.siemens.com/product?Article No.">www.siemens.com/ product?Article No.</a>	Price per PU	PU (UNIT, SET, M)	PS*/ P. unit	PG
<b>Screwdrivers</b>						
For opening spring-loaded terminals						
<b>Versions</b>						
<ul style="list-style-type: none"> <li>• 0.4 × 2.5 mm</li> <li>• 0.6 × 3.5 mm</li> <li>• 0.8 × 4.0 mm</li> <li>• 1.0 × 5.5 mm</li> </ul>		<b>8WH9200-0AA00</b> <b>8WH9200-0AB00</b> <b>8WH9200-0AC00</b> <b>8WH9200-0AD00</b>	1 1 1 1	10 units 10 units 10 units 10 units	1BT 1BT 1BT 1BT	
<b>Connecting combs</b>						
<b>Versions</b>						
<ul style="list-style-type: none"> <li>• For terminal width 4.2 mm and terminal size 1.5 mm<sup>2</sup> (excluding 8WH3) <ul style="list-style-type: none"> <li>- 2-pole</li> <li>- 3-pole</li> <li>- 4-pole</li> <li>- 5-pole</li> <li>- 10-pole</li> <li>- 20-pole</li> </ul> </li> </ul>	17.5 A	<b>8WH9020-6AC10</b> <b>8WH9020-6AD10</b> <b>8WH9020-6AE10</b> <b>8WH9020-6AF10</b> <b>8WH9020-6AL10</b> <b>8WH9020-6AS10</b>	1 1 1 1 1 1	50/5000 units 50/4000 units 50/4200 units 50/4200 units 10 units 10 units	1BT 1BT 1BT 1BT 1BT 1BT	
<ul style="list-style-type: none"> <li>• For terminal width 5.2 mm and terminal size 2.5 mm<sup>2</sup> (for 8WH3: 1.5 mm<sup>2</sup>) <ul style="list-style-type: none"> <li>- 2-pole</li> <li>- 3-pole</li> <li>- 4-pole</li> <li>- 5-pole</li> <li>- 10-pole</li> <li>- 20-pole</li> <li>- 50-pole</li> </ul> </li> </ul>	24 A	<b>8WH9020-6BC10</b> <b>8WH9020-6BD10</b> <b>8WH9020-6BE10</b> <b>8WH9020-6BF10</b> <b>8WH9020-6BL10</b> <b>8WH9020-6BS10</b> <b>8WH9020-6BT10</b>	1 1 1 1 1 1 1	50 units 50 units 50 units 50 units 10 units 10 units 10 units	1BT 1BT 1BT 1BT 1BT 1BT 1BT	
<ul style="list-style-type: none"> <li>• For terminal width 6.2 mm and terminal size 4 mm<sup>2</sup> (for 8WH3: 2.5 mm<sup>2</sup>) <ul style="list-style-type: none"> <li>- 2-pole</li> <li>- 3-pole</li> <li>- 4-pole</li> <li>- 5-pole</li> <li>- 10-pole</li> <li>- 20-pole</li> <li>- 50-pole</li> </ul> </li> </ul>	32 A	<b>8WH9020-6CC10</b> <b>8WH9020-6CD10</b> <b>8WH9020-6CE10</b> <b>8WH9020-6CF10</b> <b>8WH9020-6CL10</b> <b>8WH9020-6CS10</b> <b>8WH9020-6CT10</b>	1 1 1 1 1 1 1	50 units 50 units 50 units 50 units 10 units 10 units 10 units	1BT 1BT 1BT 1BT 1BT 1BT 1BT	
<ul style="list-style-type: none"> <li>• For terminal width 8.2 mm and terminal size 6 mm<sup>2</sup> <ul style="list-style-type: none"> <li>- 2-pole</li> <li>- 3-pole</li> <li>- 4-pole</li> <li>- 5-pole</li> <li>- 10-pole</li> </ul> </li> </ul>	41 A	<b>8WH9020-6DC10</b> <b>8WH9020-6DD10</b> <b>8WH9020-6DE10</b> <b>8WH9020-6DF10</b> <b>8WH9020-6DL10</b>	1 1 1 1 1	10 units 10 units 10 units 10 units 10 units	1BT 1BT 1BT 1BT 1BT	
<ul style="list-style-type: none"> <li>• For terminal width 10 mm and terminal size 10 mm<sup>2</sup>, 2-pole,</li> </ul>	57 A	<b>8WH9020-6EC10</b>	1	10 units	1BT	
<ul style="list-style-type: none"> <li>• For terminal width 12 mm and terminal size 16 mm<sup>2</sup>, 2-pole</li> </ul>	76 A	<b>8WH9020-6FC10</b>	1	10 units	1BT	
<ul style="list-style-type: none"> <li>• For terminal width 16 mm and terminal size 35 mm<sup>2</sup>, 2-pole</li> </ul>	101 A	<b>8WH9020-6GC10</b>	1	10 units	1BT	







8WH9200-0AA00



8WH9020-6AC10

## Accessories for 8WH Terminal Blocks

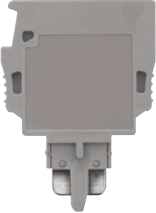
### Mounting accessories

	Version	DT	Article No. <a href="http://www.siemens.com/product?Article No.">www.siemens.com/ product?Article No.</a>	Price per PU	PU (UNIT, SET, M)	PS*/ P. unit	PG
<b>Plug-in zone connectors, for isolating terminals</b>							
	<ul style="list-style-type: none"> <li>Isolating plugs</li> <li>- Orange</li> </ul>		<b>8WH9040-0DB04</b>		1	50 units	1BT
8WH9040-0DB04							
	<ul style="list-style-type: none"> <li>Through-type connectors</li> <li>- Gray</li> <li>- <math>I_{max}</math>: 16 A</li> </ul>		<b>8WH9020-8AB00</b>		1	50 units	1BT
8WH9020-8AB00							
	<ul style="list-style-type: none"> <li>Fused connectors</li> <li>- Black</li> <li>- <math>I_{max}</math>: 6.3 A</li> <li>- Facility for labeling with labels, flat, for terminal width 6.2 mm</li> <li>- G fuses 5 x 20 mm</li> </ul>		<b>8WH9040-3AB08</b> <b>8WH9040-3CB08</b> <b>8WH9040-3DB08</b>		1 1 1	10 units	1BT 1BT 1BT
8WH9040-3AB08	<p>Versions</p> <ul style="list-style-type: none"> <li>- With LED display for 12 ... 30 V, 1 ... 2.5 mA</li> <li>- With LED display for 110 ... 250 V, 0.5 ... 2.5 mA</li> <li>- Without LED display</li> </ul> <p>Note</p> <ul style="list-style-type: none"> <li>The G fuse holders must be selected according to the maximum power loss (heat dissipation) of the G fuse links. Depending on the application and method of installation, the heat rise conditions in closed fuse holders must be tested.</li> <li>Higher ambient temperatures represent an additional load for the fuse links. A shift in rated current should therefore be taken into account in such applications.</li> </ul>						
	<ul style="list-style-type: none"> <li>Component connectors</li> <li>- <math>I_{max}</math>: 6 A, depending on the power loss of the components, max. 1 W for single arrangement</li> <li>- Facility for labeling with labels, flat, for terminal width 5.2 mm</li> </ul>		<b>8WH9040-0BB00</b>		1	10 units	1BT
8WH9040-0BB00							
<b>Feeder terminals, for N-busbars</b>							
	<ul style="list-style-type: none"> <li>6 x 6 mm and 10 x 3 mm</li> <li>Bare</li> </ul>		<b>8WA2867</b>		1	50/2400 units	1BT
8WA2867/8WA2868/ 8WA2870	<p>Versions</p> <ul style="list-style-type: none"> <li>Rated uninterrupted current 32 A, for connection of up to 4 mm<sup>2</sup></li> <li>Rated uninterrupted current 76 A, for connection of up to 25 mm<sup>2</sup></li> <li>Rated uninterrupted current 125 A, for connection of up to 35 mm<sup>2</sup></li> </ul>		<b>8WA2868</b> <b>8WA2870</b>		1 1	50/750 units	1BT 1BT
	<p><b>N-busbars, 10 x 3 mm</b></p> <ul style="list-style-type: none"> <li>Made of copper, tin-plated</li> <li>1000 mm long</li> </ul>		<b>8WA2842</b>		1	1 unit	1BT
8WA2842							

## 8WA1 Screw Terminals

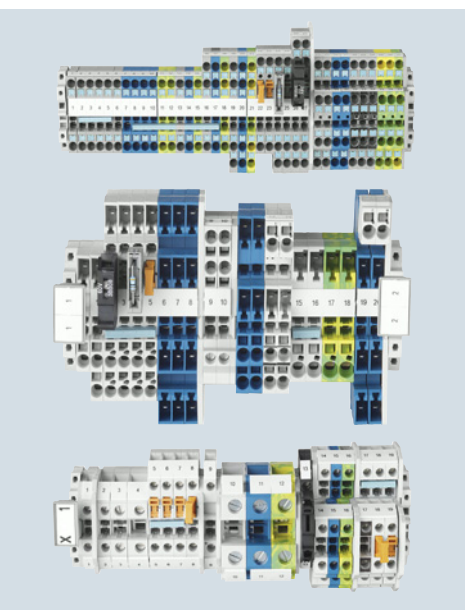

9/2	<b>Introduction</b>
9/3	<b>General data on 8WA</b>
9/9	<b>8WA through-type terminals<sup>1)</sup></b>
9/15	<b>8WA N-conductor isolating and branch terminals</b>
9/17	<b>8WA Insta or three-tier terminals</b>
9/19	<b>8WA two-tier terminals</b>
9/21	<b>8WA two-tier terminals with electronic components</b>
9/23	<b>8WA diode and isolating terminals</b>
9/24	<b>8WA terminals for components</b>
9/25	<b>8WA fuse terminals</b>
9/26	<b>8WA through-type terminals with soldered and plug-in connection</b>
9/27	<b>8WA measuring transformer terminals</b>

<sup>1)</sup> Also available as a PE version

**For further technical product information:**







Siemens Industry Online Support:  
[www.siemens.com/lowvoltage/product-support](http://www.siemens.com/lowvoltage/product-support)

→ Application example  
 Certificate  
 Characteristic  
 Download  
 FAQ  
 Manual  
 Product note  
 Software archive  
 Technical data

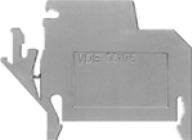
# 8WA1 Screw Terminals

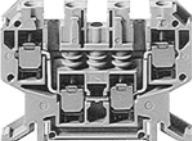
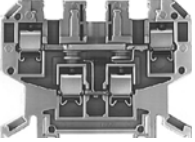
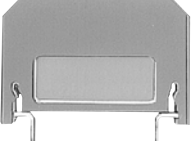
## Introduction

### Overview

	Devices	Page	Function
	8WA through-type terminals	9/9	Connection of incoming and outgoing cables up to 70 mm <sup>2</sup>
	8WA N-conductor isolating and branch terminals	9/15	N-conductor isolating terminals connected to N-busbar 6 x 6 mm
	8WA Insta or three-tier terminals	9/17	These terminals have up to three terminal functions in a single enclosure and may also have an N-isolating terminal connection to an N-busbar 6 x 6 mm. They are optimized for distribution board applications in installation technology
	8WA two-tier terminals	9/19	Compact design of the terminal blocks, in which two connecting wires can be installed
	8WA two-tier terminals with electronic components	9/21	Terminal blocks with integrated diodes
	8WA diode and isolating terminals	9/23	Terminal blocks with integrated diodes or isolation for testing purposes
	8WA terminals for components	9/24	Terminals that enable installation of components in the circuit
	8WA fuse terminals	9/25	Terminals which can be used to protect control circuits, for example
	8WA through-type terminals with soldered and plug-in connection	9/26	Terminals with connection for soldered or plug-in connection
	8WA measuring transformer terminals	9/27	Measuring transformer terminals can be used for testing and isolating circuits in switchboards, control rooms, etc. without interrupting operation

## Overview

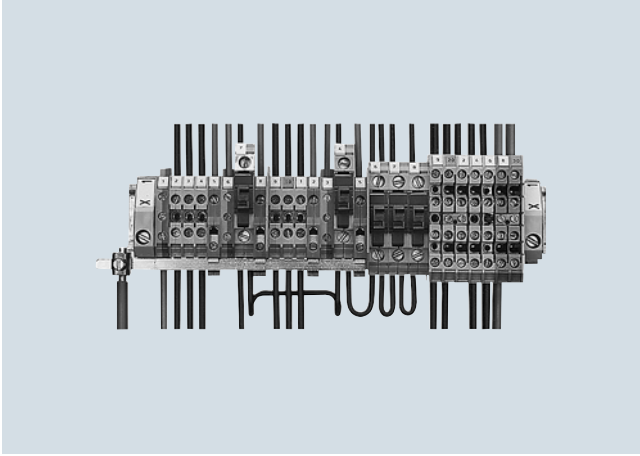

Terminal strips with different terminal blocks: 8WA1011-1DG11 terminal blocks, 8WA1011-1NG31 N-conductor isolating terminals with feeder terminal for N-busbar 6 × 6 mm, 8WA1011-1PG00 PE terminals, 8WA1011-1SF12 fuse terminals, and various two-tier terminals. The EN 50022-35-compliant standard mounting rail serves as the PE bar.

Terminal blocks are used for the space-saving connection of incoming and outgoing cables in switchboards and distribution boards.

### Standards

EN 60664-1,  
EN 60999 and  
IEC 60 947-7-1 or  
IEC 60 947-7-2

The terminals are finger-safe acc. to IEC 60529 and DIN EN 50274 (except for bare terminals and solder connections). Through-type terminals are resistant to earthquakes according to IEC 60068-2-6.

### Rated short-time withstand current

Our screw terminals are able to withstand a rated short-time current corresponding to a current density of 120 A/mm<sup>2</sup> specific to the rated cross-section for one second.

### Colored terminal blocks

With colored wiring according to EN 60204-1, the connecting level can also be included in the colored markings:

- Red for control circuits with AC current
- Blue for control circuits with DC current or neutral conductor
- Orange for interlock circuits with AC or DC current which are fed from outside and are live when the main switch is turned off
- Green-yellow through-type terminals for protective conductors (without connection to the support rail)

### Design

The terminal blocks are insulated at both ends, with the exception of two-tier, flat and bolt-type terminals, which are insulated on one side only.

The insulating material for terminal sizes up to 70 mm<sup>2</sup> is made of thermoplast, polyamide 6.6.

The materials used are environment-friendly: For example, they are cadmium-free and contain no halogens or silicone.

The plastics used are flame-retardant and self-extinguishing according to EN 60695-2-2, VDE 0471, Part 2-2 and UL 94 V-2.

### Clamping methods

The terminals are designed so that when the terminal screws are tightened, any tensile stress which occurs causes elastic deformation of the terminal bodies. This compensates for any creepage of the clamping conductor. Deformation of the thread part prevents loosening of the clamping screw, even in the event of heavy mechanical and thermal strain (e.g. vibration stress of 10 g or thermal cycles).

The following clamping methods are used:

- Terminal body with pressure plate for terminal sizes 16, 35 and 70 mm<sup>2</sup>
- Strain-relief clamps for terminal sizes 2.5, 4 and 6 mm<sup>2</sup>
- Screw with connection disk for fuse terminals and component terminals.

### Terminal size

The terminal size corresponds to the nominal cross-section. According to EN 60947-7-1, a finely stranded copper conductor of nominal cross-section can be connected to any clamping point with or without end sleeve.

### Mounting

The terminals are snapped onto 35 mm support rails according to IEC 60715 TH35 and secured against movement using end retainers.

A lateral mounting tolerance of 0.2 mm must be maintained between the terminals.

### Conductor connection

Except for flat and bolt-type versions, all terminal bodies are designed so that solid, stranded and finely stranded conductors with or without end sleeves (according to DIN 46228) can be securely clamped (please observe cross-section).

Damage to the clamped conductors is prevented by pressure plates or strain-relief clamps. For the conductor cross-sections when 1 or 2 conductors are connected, see [Technical Specifications](#).

## 8WA1 Screw Terminals

### General data on 8WA

#### Connection of aluminum conductors

Siemens screw terminals are suitable for connecting aluminum conductors provided there is compliance with the normal processing guidelines, i.e. the brushing and greasing of the conductors before connection.

After a few days, the connection should be tightened again for safety reasons.

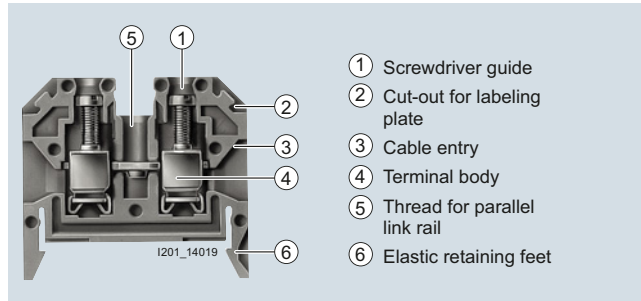

8WA1 through-type terminal with screw terminal at both ends, sectional view

#### PE and PEN terminals

In switchgear and controlgear systems the support rails for the terminal blocks are frequently used as protective ground busbars. The PE terminals establish the connection to the support rail.

The fact that there is no separate PE busbar means the PE terminals, the insulated main conductor terminals and N-conductor isolating terminals can be arranged according to user requirements. This makes the individual circuits clearly manageable.

The bare 8WA1010-1PH01 PE terminals are primarily used for connecting the shields of shielded cables. They are normally mounted on a standard mounting rail, which is supported by an 8WA1857 insulation carrier and which is equipped with only one PE terminal for connection to the PE conductor.

#### Accessories

##### Parallel connection bars

The connection bars are screwed into the terminals from above and allow parallel connection of up to 10 terminals up to terminal size 35 mm<sup>2</sup>. The 10-pole connection bars can be shortened as required. On 70 mm<sup>2</sup> terminals the connection bars are two-pole.

##### Barriers

Barriers are yellow in color and project beyond the contours of the terminals. They serve the visual separation of groups of terminals, the electrical isolation of adjacent connection bars and the improvement of the rated insulation voltage for soldered and plug-in connections.

##### Insulation plates

8WA1825 and 8WA1822-7TK00 insulation plates can be used with different terminals for providing electrical insulation between connection bars.

##### Disconnecting links

The 8WA1865 disconnecting links provide a detachable connection between two adjacent terminals sizes 2.5 to 6 mm<sup>2</sup>.

##### Covers with lightning symbol

The purpose of these covers is to identify the power input terminals. At the same time, they provide additional touch protection.

##### End retainers and end labeling plates

End retainers are available in thermoplastic or galvanized and chromated steel. The end labeling plate can be fitted in an 8WA1808 end retainer or, in any of three positions, in an 8WA1805 end retainer.



## Technical specifications

### Continuous load at increased ambient temperatures

The 8WA1 terminal blocks can withstand an uninterrupted current at ambient temperatures of up to +55 °C. At higher ambient temperatures, a current reduction according to the following formula is required:

$$I_{th2'} = I_{th2} \cdot k$$

$I_{th2}$  = Uninterrupted current according to selection tables, relative to the nominal cross-section

$I_{th2'}$  = Uninterrupted current at increased ambient temperature

$k$  = Derating factor according to table

Ambient temperature	Derating factor $k$
60 °C	0.94
65 °C	0.88
70 °C	0.82
75 °C	0.75
80 °C	0.67
85 °C	0.58
90 °C	0.47
95 °C	0.33

The highest permissible clamping point overtemperature of 45 K specified in IEC 60947-7-1 is not exceeded at an ambient temperature of up to 100 °C.

### Clamping points

Terminal size	Type <sup>1)</sup>	Thread diameter of terminal screws	Screwdriver blades acc. to DIN 5264 Form B	Tightening torque = test torque acc. to DIN VDE 0609 and DIN VDE 0611 Nm	Tensile forces acc. to IEC 60947-1 at max. conductor connection N	Stripped length mm
1.5	8WA1011-.SF. . . 8WA1011-1EE00	M3.5	0.8 × 4	0.8	40	10
2.5	8WA1. . .1, 8WA1011-1BF11, 8WA1011-1EF. . . 8WA1011-. . .F. . .	M2.5 and M3	0.5 × 3	0.5	50	11
		M2.5	0.8 × 4	0.5	50	11
4	8WA1011-. . .G. . . 8WA2867	M3	0.8 × 4	0.5	60	11
		M3.5	0.8 × 4	0.8 ... 1	60	11
6	8WA1. . .2, 8WA1011-. . .H. . .	M3.5	0.8 × 4	0.8	80	11
16	8WA1. . .4, 8WA1011-. . .K. . .	M4	0.8 × 4	1.2	100	13
25	8WA2868	M5	1.2 × 6.5	2	135	
35	8WA1. . .5, 8WA1011-. . .M. . . 8WA2870	M6	1.2 × 6.5	2.5	190	17
				2.5 ... 3		
50	8WH1000-0AN00, 8WH1000-0AN01, 8WH1000-0CN07 8WH1070-0AN00	M6	1.2 × 8	6 ... 8	--	24
		M6	--	3 ... 7	--	6 ... 25
70	8WA1. . .6	M8	4 hexagon socket-head	6	285	25
95	8WA1010-1PQ00 8WH1000-0AQ00, 8WH1000-0AQ01 8WH1000-0CQ07 8WH1070-0AQ00 8WH1060-0AQ00	M8	6 hexagon socket-head	15 ... 20	--	30
		M8	6 hexagon socket-head	15 ... 20	--	33
		M8	6 hexagon socket-head	15 ... 20	--	30
		M8	--	6 ... 15	--	16 ... 25
		M8	--	25 ... 30	--	29
150	8WH1000-0AS0. 8WH1070-0AS00 8WH1060-0AS00	M10	8 hexagon socket-head	25 ... 30	--	40
		M10	--	10 ... 18	--	10 ... 18
		M10	--	25 ... 30	--	34
240	8WH1000-0AU0. 8WH1060-0AU00	M10	10 hexagon socket-head	30 ... 35	--	40
		M10	--	30 ... 35	--	34

<sup>1)</sup> Tightening torque also applicable for accessories (socket, connection bars, etc.).

### Standard mounting rails as PEN rails

Only use Cu busbars.

They must have the same current carrying capacity as protective conductor busbars.

PEN busbars must carry only terminals and no devices.

### Standard mounting rails as protective conductor busbars

Protective conductors with a larger cross-section than the protective conductor busbar, and with the same conductivity, can be connected to standard mounting rails that are also protective conductor busbars and carry current only under fault conditions.

Standard mounting rail acc. to EN 50022-35 and IEC 60715 TH35	Material	Type	Max. permissible cross-section of connected protective conductor mm <sup>2</sup>
35 × 7.5	Steel	5ST1141	16
	Steel, perforated	5ST1145	16
Similar to 35 × 15	Steel	5ST1142	35
	Steel	--	50
	Copper	8WA7551	150 <sup>1)</sup>

<sup>1)</sup> With 8WA1010-1PQ00 terminal connection of up to 95 mm<sup>2</sup> finely stranded or 120 mm<sup>2</sup> stranded.

## 8WA1 Screw Terminals

### General data on 8WA

#### Rated impulse withstand voltage of terminal blocks

Values dependent on the mains rated voltage  $\leq$  rated insulation voltage of terminal block; excerpt from EN 60947-1, table H.1.

Terminal blocks are tested acc. to overvoltage category III.

Rated mains voltage ( $\leq$ rated insulating voltage of the device) RMS value V AC	Maximum rated operating voltage to ground RMS value V AC or V DC	Preferred values for rated impulse withstand voltage as 1.2/50 $\mu$ s pulse Overvoltage category			
		I kV	II kV	III kV	IV kV
--	50	330	500	800	1500
66/115	100	500	800	1500	2500
120/208 127/220	150	800	1500	2500	4000
230/400 277/480	300	1500	2500	4000	6000
400/690	600	2500	4000	6000	8000
1000	1000	4000	6000	8000	12000

#### Connection

Terminal size mm <sup>2</sup>	Type	Smallest conductor cross-section					Largest conductor cross-section				
		Solid mm <sup>2</sup>	Stranded mm <sup>2</sup>	Finely stranded mm <sup>2</sup>	Finely stranded with end sleeve <sup>1)</sup> mm <sup>2</sup>	Size	Solid mm <sup>2</sup>	Stranded mm <sup>2</sup>	Finely stranded mm <sup>2</sup>	Finely stranded with end sleeve <sup>1)</sup> mm <sup>2</sup>	Size
<b>Single-conductor connection</b>											
1.5	8WA1011-SF... 8WA1011-1EE00	1	--	--	0.75	0.75 ... 10	2.5	--	--	1.5	1.5 ... 10
2.5	8WA1211, 8WA1011-. F. .	0.25 <sup>2)</sup>	0.5	0.5	0.5	0.5 ... 10	4	2.5	2.5	2.5	2.5 ... 12 <sup>4)</sup>
	8WA1011-3JF . .	0.25 <sup>2)</sup>	0.5	0.5	0.5	0.5 ... 10	4	2.5	2.5	2.5	2.5 ... 7
	8WA1501, 8WA1511, 8WA1011-1EF . .	0.25 <sup>2)</sup>	0.5	0.5	0.5	0.5 ... 10	4	2.5	2.5	2.5	1.5 ... 10
4	8WA9200	0.5	1.5	1.5	0.75	0.75 ... 10	6	4	4	4	4
	8WA286. Feeder terminals	1	1.5	1.5	0.75	0.75 ... 10	6	4	4	4	4 ... 12 <sup>4)</sup>
	8WA1011-. G..	0.5	1.5	0.5	0.75	0.75 ... 10	6	4	4	4	4 ... 12 <sup>4)</sup>
6	8WA1011-1.H..	0.75	1.5	1.5	0.5	0.5 ... 10	10	6	6	6	6 ... 12
	8WA1010-1PH01	0.5	1.5	1.5	0.5	0.5 ... 10	10	6	6	6	6 ... 15
16	8WA1204, 8WA1304, 8WA1011-1BK11	1.5	2.5	2.5	1	1 ... 10 <sup>3)</sup>	16	25	16	16	16 ... 12
	8WA1604	1.5	2.5	4	1.5	1 ... 10 <sup>3)</sup>	16	25	16	16	16 ... 12
	8WA1011-1PK00	1.5	2.5	4	1.5	1.5 ... 7 <sup>6)</sup>	16	25	16	16	16 ... 15
	8WA286. Feeder terminals	1.5	2.5	4	2.5	2.5 ... 12	16	16	10	10	10 ... 12
25	8WH1060-0AL00	--	--	4	4	--	--	--	25	25	--
35	8WA1205, 8WA1305, 8WA1011-1BM11	4	10	6	6	6 ... 15	16 <sup>5)</sup>	50	35	35	35 ... 18 <sup>7)</sup>
	8WA1011-1PM00	4	10	10	6	6 ... 15	16 <sup>5)</sup>	50	35	25	25 ... 15
	8JH4114 Feeder terminals	6	10	16	6	6 ... 15	16	35	25	25	25 ... 15
	8WA2870	6	10	16	6	6 ... 15	16	35	25	25	25 ... 15
50	8WH1000-0AN00	--	--	10	10	--	--	--	50	50	--
	8WH1000-0AN01	--	--	10	10	--	--	--	50	50	--
	8WH1000-0CN07	--	--	25	25	--	--	--	50	50	--
	8WH1070-0AN00	--	--	6 <sup>1)</sup>	--	--	--	--	--	35 <sup>1)</sup>	--
	8WH1060-0AN00	--	--	25	25	--	--	--	50	50	--
70	8WA1206	10	16	16	16	16 ... 12 <sup>6)</sup>	95	95	95	--	--
95	8WA1010-1PQ00	--	50	50	--	--	--	95	95	--	--
	8WH1000-0AQ00	--	--	35	35	--	--	--	95	95	--
	8WH1000-0AQ01	--	--	35	35	--	--	--	95	95	--
	8WH1000-0CQ07	--	--	35	35	--	--	--	35	95	--
	8WH1070-0AQ00	--	--	--	16 <sup>1)</sup>	--	--	--	--	35 <sup>1)</sup>	--
	8WH1060-0AQ00	--	--	35	35	--	--	--	95	95	--
150	8WH1000-0AS00, 8WH1000-0AS01	--	--	50	50	--	--	--	150	150	--
	8WH1060-0AS00	--	--	50	50	--	--	--	150	150	--
	8WA1011-1DU..	--	--	--	--	--	--	240	240	--	--
240	8WH1000-0AU00, 8WH1000-0AU01	--	--	70	70	--	--	--	185	185	--
	8WH1060-0AU00	--	--	--	--	--	--	--	--	--	--

<sup>1)</sup> End sleeves acc. to DIN 46228 Sheet 1 without insulation.  
Size corresponds to sleeve nominal size.

<sup>2)</sup> 0.12/0.25 mm<sup>2</sup> corresponds to  $\varnothing$  0.4/0.6 mm.

<sup>3)</sup> For 0.75 mm<sup>2</sup> conductors, use end sleeves 1 to 10 and press on with insert E1 or PZ 1.5.

<sup>4)</sup> At voltages > 500 V, shorten end sleeves with inserted conductor to 10 mm before pressing on.

<sup>5)</sup> Tested up to 16 mm<sup>2</sup>.

<sup>6)</sup> Fit and press on two end sleeves one after the other (up to stop).

<sup>7)</sup> Voltage reduction to 630 V required.

Terminal size mm <sup>2</sup>	Type	Smallest conductor cross-section					Largest conductor cross-section				
		Solid mm <sup>2</sup>	Stranded mm <sup>2</sup>	Finely stranded mm <sup>2</sup>	Finely stranded with end sleeve <sup>1)</sup>		Solid mm <sup>2</sup>	Stranded mm <sup>2</sup>	Finely stranded mm <sup>2</sup>	Finely stranded with end sleeve <sup>1)</sup>	
					mm <sup>2</sup>	Size				mm <sup>2</sup>	Size
<b>Two-wire connection</b> , 2 conductors each of same cross-section; with end sleeves the two rectangular sleeves must be inserted in the same position. 											
1.5	8WA1011-. SF . . . , -1EE00	2 × 1	--	--	2 × 0.75	1 ... 10 <sup>2)</sup>	2 × 2.5	--	--	2 × 1.5	1.5 ... 10
2.5	8WA1211, 8WA1011-. F. . 8WA1501, 8WA1511, 8WA1011-1EF . .	2 × 0.12 <sup>3)</sup> 2 × 0.12 <sup>3)</sup>	2 × 0.5 2 × 0.5	2 × 0.5 2 × 0.25	2 × 0.5 <sup>4)</sup>	0.75 ... 6 --	2 × 0.75 2 × 0.75	2 × 0.5 2 × 0.5	2 × 0.5 2 × 0.75	2 × 1.5 <sup>4)</sup> --	1.5 ... 10 --
4	8WA1011-. G. . . , -1DG11 8WA1011-2DG11 8WA1011-6DG11, top 8WA1011-6DG11, bottom 8WA1011-1PG00 8WA1011-1PG11, -1NG01	2 × 0.5 2 × 0.5 2 × 0.5 2 × 0.5 2 × 0.5 2 × 0.5	2 × 1 2 × 1 2 × 1 2 × 1 2 × 1 2 × 1	2 × 1 2 × 1 2 × 1 2 × 0.5 2 × 0.5 2 × 1	2 × 0.5 2 × 0.5 2 × 0.5 2 × 0.5 2 × 0.5 2 × 0.5	0.5 × 10 0.5 × 10 0.5 × 10 0.5 × 10 0.5 × 10 0.5 × 10	2 × 1.5 2 × 1 2 × 1.5 2 × 1 2 × 1 2 × 1.5	2 × 1.5 2 × 1.5 2 × 1.5 2 × 1.5 2 × 1.5 2 × 1.5	2 × 1.5 2 × 1.5 2 × 1.5 2 × 1.5 2 × 1.5 2 × 1.5	2 × 1.5 2 × 1 2 × 1 2 × 1 2 × 1 2 × 1	1.5 ... 10 1 ... 10 1 ... 10 1 ... 10 1 ... 10 1 ... 10
6	8WA1011-1. H. . . , -3DH21 8WA1010-1PH01	2 × 0.5 2 × 0.5	2 × 0.75 2 × 0.75	2 × 0.75 2 × 0.75	2 × 0.5 2 × 0.5	0.5 × 10 0.5 × 10	2 × 1.5 2 × 1.5	2 × 1.5 2 × 1.5	2 × 1.5 2 × 1.5	2 × 1.5 2 × 0.75	1.5 ... 10 1 ... 10
16	8WA1204, 8WA1304, 8WA1604, 8WA1011-1BK11 8WA1734	2 × 1 2 × 2.5	2 × 2.5 --	2 × 2.5 --	2 × 1 2 × 1.5	1 ... 10 1.5 ... 7 <sup>5)</sup>	2 × 4 2 × 4	2 × 4 2 × 4	2 × 4 2 × 4	2 × 4 2 × 4	4 ... 12 4 ... 12
35	8WA1205, 8WA1305, 8WA1011-1BM11, 8WA1735	2 × 4	2 × 10	2 × 6	2 × 6	6 ... 15	2 × 10	2 × 10	2 × 10	2 × 10	10 ... 15
50	8WH1000-0AN00, 8WH1000-0AN01, 8WH1000-0CN07	2 × 10	2 × 10	2 × 10	2 × 10	--	2 × 35	2 × 35	2 × 35	2 × 35	--
70	8WA1206	2 × 10	2 × 10	2 × 10	2 × 10	10 ... 12 <sup>5)</sup>	2 × 16	2 × 16	2 × 16	2 × 16	16 ... 12 <sup>6)</sup>
95	8WH1000-0AQ00, 8WH1000-0AQ01, 8WH1000-0CQ07	2 × 25	2 × 25	2 × 25	2 × 25	--	2 × 35	2 × 35	2 × 35	2 × 35	--
150	8WH1000-0AS00, 8WH1000-0AS01	2 × 25	2 × 25	2 × 25	2 × 25	--	2 × 50	2 × 50	2 × 50	2 × 50	--
240	8WH1000-0AU00, 8WH1000-0AU01	2 × 35	2 × 35	2 × 35	2 × 35	--	2 × 95	2 × 95	2 × 95	2 × 95	--

<sup>1)</sup> End sleeves acc. to DIN 46228 Sheet 1 without insulation. Size corresponds to sleeve nominal size.

<sup>2)</sup> For 0.75 mm<sup>2</sup> conductors, use end sleeves 1 to 10 and press on with insert E1 or PZ 1.5 (crimping tool size 1.5).

<sup>3)</sup> 0.12/0.25 mm<sup>2</sup> corresponds to Ø 0.4/0.6 mm.

<sup>4)</sup> With PZ 1.5 (crimping tool size 1.5) on top of each other 

<sup>5)</sup> Fit and press on two end sleeves one after the other (up to stop). Voltage reduction to 630 V required

### Conductor cross-sections to AWG "American Wire Gauge"

AWG No.	Wire diameter mm	Cross-section mm <sup>2</sup>	AWG No.	Wire diameter mm	Cross-section mm <sup>2</sup>	AWG No.	Wire diameter mm	Cross-section mm <sup>2</sup>
30	0.254	0.051	18	1.024	0.82	6	4.115	13.30
29	0.287	0.065	17	1.151	1.04	5	4.620	16.77
28	0.320	0.081	16	1.290	1.31	4	5.189	21.15
27	0.363	0.102	15	1.450	1.65	3	5.827	26.66
26	0.404	0.128	14	1.628	2.08	2	6.543	33.62
25	0.455	0.163	13	1.829	2.63	1	7.348	42.41
24	0.511	0.205	12	2.052	3.31	1/0	8.252	53.52
23	0.574	0.259	11	2.304	4.17	2/0	9.266	67.43
22	0.643	0.33	10	2.588	5.26	3/0	10.404	85.01
21	0.724	0.41	9	2.906	6.63	4/0	11.684	107.21
20	0.813	0.52	8	3.268	8.37	5/0	--	135.35
19	0.912	0.65	7	3.665	10.55	6/0	--	170.50

## 8WA1 Screw Terminals





### General data on 8WA

#### ® and ⚡ rating

Terminal size mm <sup>2</sup>	Type	CSA rating			UR rating		
		AWG	Rated current $I_n$ A	Rated voltage $U_e$ V	AWG	Rated current $I_n$ A	Rated voltage $U_e$ V
1.5	8WA1011-1SF12	18 ... 14	6.3	600	18 ... 14	6.3	600
	8WA1011-1SF24, -2SF24, -4SF24	14	1	--	14 ... 12	1	AC 240/DC 60
	8WA1011-1SF25, -2SF25, -4SF25	14	2	--	14 ... 12	2	AC 240/DC 60
	8WA1011-1SF26, -2SF26, -4SF26	14	4	--	14 ... 12	4	AC 240/DC 60
	8WA1011-1SF27, -2SF27, -4SF27	14	6	--	14 ... 12	6	AC 240/DC 60
8WA1011-1SF28, -2SF28, -4SF28	14	10	--	14 ... 12	10	AC 240/DC 60	
2.5	8WA1011-1BF21, -1BF22, -1BF23, -1PF11	18 ... 12	25	600	22 ... 12	26	600
	8WA1011-1DF11, -3DF21, -0DF21, -0DF22	18 ... 12	25	600	22 ... 12	26	600
	8WA1011-1NF01, -1NF02	22 ... 12	26	600	22 ... 12	26	600
	8WA1011-3JF..	--	--	--	22 ... 12	26	300
	8WA1011-1PF00, 8WA1011-1PF01	22 ... 12	--	--	22 ... 12	--	--
	8WA1501	22 ... 12	10	300 D	22 ... 12	10	300
4	8WA1011-1PG00, 8WA1011-1PG01	18 ... 10	--	--	18 ... 10	--	--
	8WA1011-1BG11, -1BG21, -1BG22	18 ... 10	40	600	18 ... 10	35	600
	8WA1011-1DG11, -3DG21, -0DG21, -0DG22	18 ... 10	40	600	18 ... 10	35	600
	8WA1011-1NG31, -1NG32	18 ... 10	40	600	18 ... 10	35	600
	8WA1011-1PG11	18 ... 10	40	600	--	--	--
	8WA1011-2BG11, -2DG11	18 ... 10	40	300	18 ... 10	35	600
	8WA1011-6BG11, -6DG11	18 ... 10	40	300	18 ... 10	35	600
	8WA1011-6EG..	--	--	--	18 ... 10	34	300
	8WA9200	18 ... 10	25	300	18 ... 10	26	600
6	8WA1011-1PH00	--	--	--	14 ... 8	--	--
	8WA1011-1BH23, -1PH11	16 ... 10	35	600	14 ... 8	44	600
	8WA1011-1DH11, -3DH21	16 ... 8	35	600	14 ... 8	44	600
	8WA1011-1NH01, -1NH02	14 ... 8	44	600	14 ... 8	44	600
	8WA1011-1MH10, -1MH11, -1MH15	16 ... 10	35/40	600/300 C/D	14 ... 8	44	600/300
	8WA1232	--	--	--	..1)	24	600
16	8WA1011-1BK11	14 ... 6	70	600	12 ... 4	79	600
	8WA1011-1PK00	12 ... 4	--	--	12 ... 4	--	--
	8WA1012-1DK10	--	--	--	--	79	600
	8WA1204, 8WA1304	14 ... 6	70	600	12 ... 4	79	600
	8WA1604	--	--	--	12 ... 4	73	300
25	8WH1060-0AL00	6 ... 4	100	600	6 ... 4	85	600
35	8WA1011-1BM11	12 ... 2	100	600	10 ... 1	120	600
	8WA1011-1PM00	10 ... 1	--	--	10 ... 1	--	--
	8WA1205, 8WA1305	12 ... 2	100	600	10 ... 1	120	600
50	8WH1000-0AN00, 8WH1000-0AN01	6 ... 0	125	600	6 ... 0	150	600
	8WH1000-0CN07	--	--	--	6 ... 1	--	--
	8WH1060-0AN00	6 ... 0	125	600	6 ... 0	150	600
70	8WA1012-1DP14	2/0 ... 1	170	600	6 ... 3/0	--	600
	8WA1206	8 ... 1/0	150	600	8 ... 3/0	220	600
95	8WH1000-0AQ00, 8WH1000-0AQ01	1 ... 000	220	600	2 ... 000	230	600
	8WH1000-0CQ07	2 ... 4	--	--	2 ... 4	--	--
	8WH1060-0AQ00	2 ... 000	200	600	2 ... 000	230	600
150	8WH1000-0AS0, 8WH1000-0AS01	2 ... 300 kcmil	275	600	2 ... 300 kcmil	285	600
	8WH1060-0AS00	2 ... 300 kcmil	275	600	2 ... 300 kcmil	285	600
240	8WH1000-0AU00, 8WH1000-0AU01	0 ... 500 kcmil	400	600	0 ... 500 kcmil	380	600
	8WH1000-0AU00	0 ... 500 kcmil	400	600	0 ... 500 kcmil	380	600



1) Plug-in connection

## Selection and ordering data

Version	DT	Article No. <a href="http://www.siemens.com/product?Article No.">www.siemens.com/ product?Article No.</a>	Price per PU	PU (UNIT, SET, M)	PS*/ P. unit	PG																																																																																																				
<b>General details</b> <ul style="list-style-type: none"> <li>Thermoplastic insulating body</li> <li>Screw terminal at both ends</li> <li>Enclosed at both ends</li> </ul>																																																																																																										
Note	Section	Page																																																																																																								
For labeling accessories, see ...	Accessories	8/2																																																																																																								
<b>Terminal size 2.5 mm<sup>2</sup></b>																																																																																																										
<b>Through-type terminals, terminal size 2.5 mm<sup>2</sup></b> <ul style="list-style-type: none"> <li>Rated uninterrupted current 24 A</li> <li>Rated insulation voltage 800 V</li> <li>Mounting width 6 mm</li> <li>Terminal height 26 mm</li> <li>Terminal length 41 mm</li> <li>AWG 22-12</li> <li>AWG 18-12</li> </ul>																																																																																																										
<b>Versions</b> <ul style="list-style-type: none"> <li>Single terminals <ul style="list-style-type: none"> <li>Beige</li> <li>Blue</li> <li>Red</li> <li>Orange</li> <li>Yellow</li> <li>Black</li> <li>Green</li> </ul> </li> <li>Terminal blocks <ul style="list-style-type: none"> <li>Beige, 3-pole, width 18 mm</li> <li>Beige, 10-pole, width 61 mm, with designation 1 ... 10</li> <li>Beige, 10-pole, width 61 mm, without inscription</li> </ul> </li> </ul>																																																																																																										
<b>Accessories</b> <table border="1"> <thead> <tr> <th>Section</th> <th>Page</th> </tr> </thead> <tbody> <tr> <td colspan="2"><b>Covers</b></td> </tr> <tr> <td>• With lightning symbol, for terminal size 1.5 ... 2.5 mm<sup>2</sup></td> <td>Accessories 9/13</td> </tr> <tr> <td>• White, facility for labeling, for terminal size 1.5 ... 2.5 mm<sup>2</sup></td> <td>Accessories 9/13</td> </tr> <tr> <td>• For connection bars:</td> <td></td> </tr> <tr> <td>- Transparent, for terminal size 2.5 ... 6 mm<sup>2</sup></td> <td>Accessories 9/13</td> </tr> <tr> <td>- White, facility for labeling, for terminal size 2.5 to 6 mm<sup>2</sup></td> <td>Accessories 9/13</td> </tr> <tr> <td>Jumpers, for terminal size 2.5 mm<sup>2</sup></td> <td>Accessories 9/13</td> </tr> <tr> <td>Disconnecting links</td> <td>Accessories 9/14</td> </tr> <tr> <td colspan="2"><b>Note</b></td> </tr> <tr> <td colspan="2">Between terminals with terminal sizes 2.5 and 6 mm<sup>2</sup>, two 8WH1820 barriers are required.</td> </tr> <tr> <td>• Insulation plates, for terminal size 2.5 to 6 mm<sup>2</sup></td> <td>Accessories 9/14</td> </tr> <tr> <td>• Connection bars, for terminal size 2.5 mm<sup>2</sup></td> <td></td> </tr> <tr> <td>- For two terminals</td> <td>Accessories 9/14</td> </tr> <tr> <td>- For three terminals</td> <td>Accessories 9/14</td> </tr> <tr> <td>- For four terminals</td> <td>Accessories 9/14</td> </tr> <tr> <td>- For ten terminals</td> <td>Accessories 9/14</td> </tr> <tr> <td>• Barriers, for terminal size 1.5 ... 4 mm<sup>2</sup></td> <td>Accessories 9/14</td> </tr> </tbody> </table>							Section	Page	<b>Covers</b>		• With lightning symbol, for terminal size 1.5 ... 2.5 mm <sup>2</sup>	Accessories 9/13	• White, facility for labeling, for terminal size 1.5 ... 2.5 mm <sup>2</sup>	Accessories 9/13	• For connection bars:		- Transparent, for terminal size 2.5 ... 6 mm <sup>2</sup>	Accessories 9/13	- White, facility for labeling, for terminal size 2.5 to 6 mm <sup>2</sup>	Accessories 9/13	Jumpers, for terminal size 2.5 mm <sup>2</sup>	Accessories 9/13	Disconnecting links	Accessories 9/14	<b>Note</b>		Between terminals with terminal sizes 2.5 and 6 mm <sup>2</sup> , two 8WH1820 barriers are required.		• Insulation plates, for terminal size 2.5 to 6 mm <sup>2</sup>	Accessories 9/14	• Connection bars, for terminal size 2.5 mm <sup>2</sup>		- For two terminals	Accessories 9/14	- For three terminals	Accessories 9/14	- For four terminals	Accessories 9/14	- For ten terminals	Accessories 9/14	• Barriers, for terminal size 1.5 ... 4 mm <sup>2</sup>	Accessories 9/14																																																																
Section	Page																																																																																																									
<b>Covers</b>																																																																																																										
• With lightning symbol, for terminal size 1.5 ... 2.5 mm <sup>2</sup>	Accessories 9/13																																																																																																									
• White, facility for labeling, for terminal size 1.5 ... 2.5 mm <sup>2</sup>	Accessories 9/13																																																																																																									
• For connection bars:																																																																																																										
- Transparent, for terminal size 2.5 ... 6 mm <sup>2</sup>	Accessories 9/13																																																																																																									
- White, facility for labeling, for terminal size 2.5 to 6 mm <sup>2</sup>	Accessories 9/13																																																																																																									
Jumpers, for terminal size 2.5 mm <sup>2</sup>	Accessories 9/13																																																																																																									
Disconnecting links	Accessories 9/14																																																																																																									
<b>Note</b>																																																																																																										
Between terminals with terminal sizes 2.5 and 6 mm <sup>2</sup> , two 8WH1820 barriers are required.																																																																																																										
• Insulation plates, for terminal size 2.5 to 6 mm <sup>2</sup>	Accessories 9/14																																																																																																									
• Connection bars, for terminal size 2.5 mm <sup>2</sup>																																																																																																										
- For two terminals	Accessories 9/14																																																																																																									
- For three terminals	Accessories 9/14																																																																																																									
- For four terminals	Accessories 9/14																																																																																																									
- For ten terminals	Accessories 9/14																																																																																																									
• Barriers, for terminal size 1.5 ... 4 mm <sup>2</sup>	Accessories 9/14																																																																																																									
<b>PE through-type terminals, terminal size 2.5 mm<sup>2</sup></b> <ul style="list-style-type: none"> <li>Green/yellow</li> <li>Mounting width 6 mm</li> <li>Terminal height 26 mm</li> <li>Terminal length 51 mm</li> </ul>																																																																																																										
<b>Versions</b> <ul style="list-style-type: none"> <li>One screw terminal</li> <li>Two screw terminals</li> </ul>																																																																																																										
<b>Accessories</b> <table border="1"> <thead> <tr> <th>Section</th> <th>Page</th> </tr> </thead> <tbody> <tr> <td>Barriers, for terminal size 1.5 ... 4 mm<sup>2</sup></td> <td>Accessories 9/14</td> </tr> </tbody> </table>							Section	Page	Barriers, for terminal size 1.5 ... 4 mm <sup>2</sup>	Accessories 9/14																																																																																																
Section	Page																																																																																																									
Barriers, for terminal size 1.5 ... 4 mm <sup>2</sup>	Accessories 9/14																																																																																																									
 8WA1011-1DF11																																																																																																										
 8WA1011-3DF21																																																																																																										
 8WA1011-0DF21																																																																																																										
<table border="1"> <tbody> <tr> <td><b>8WA1011-1DF11</b></td> <td>1</td> <td>100/1200 units</td> <td>1BT</td> </tr> <tr> <td><b>8WA1011-1BF23</b></td> <td>1</td> <td>50/1300 units</td> <td>1BT</td> </tr> <tr> <td><b>8WA1011-1BF21</b></td> <td>1</td> <td>50/1300 units</td> <td>1BT</td> </tr> <tr> <td><b>8WA1011-1BF22</b></td> <td>1</td> <td>50/1300 units</td> <td>1BT</td> </tr> <tr> <td><b>8WA1011-1BF26</b></td> <td>1</td> <td>50 units</td> <td>1BT</td> </tr> <tr> <td><b>8WA1011-1BF24</b></td> <td>1</td> <td>50/1300 units</td> <td>1BT</td> </tr> <tr> <td><b>8WA1011-1BF25</b></td> <td>1</td> <td>50/1300 units</td> <td>1BT</td> </tr> <tr> <td><b>8WA1011-3DF21</b></td> <td>1</td> <td>10 units</td> <td>1BT</td> </tr> <tr> <td><b>8WA1011-0DF22</b></td> <td>1</td> <td>20/100 units</td> <td>1BT</td> </tr> <tr> <td><b>8WA1011-0DF21</b></td> <td>1</td> <td>20/100 units</td> <td>1BT</td> </tr> <tr> <td><b>8WA1810</b></td> <td>1</td> <td>50 units</td> <td>1BT</td> </tr> <tr> <td><b>8WA1860</b></td> <td>1</td> <td>50 units</td> <td>1BT</td> </tr> <tr> <td><b>8WA1822-7AX01</b></td> <td>1</td> <td>10 units</td> <td>1BT</td> </tr> <tr> <td><b>8WA1822-7AX03</b></td> <td>1</td> <td>10 units</td> <td>1BT</td> </tr> <tr> <td><b>8WA1822-7VF01</b></td> <td>1</td> <td>50 units</td> <td>1BT</td> </tr> <tr> <td><b>8WA1865</b></td> <td>1</td> <td>50 units</td> <td>1BT</td> </tr> <tr> <td><b>8WA1825</b></td> <td>1</td> <td>50 units</td> <td>1BT</td> </tr> <tr> <td><b>8WA1895</b></td> <td>1</td> <td>50/600 units</td> <td>1BT</td> </tr> <tr> <td><b>8WA1896</b></td> <td>1</td> <td>50/600 units</td> <td>1BT</td> </tr> <tr> <td><b>8WA1897</b></td> <td>1</td> <td>20 units</td> <td>1BT</td> </tr> <tr> <td><b>8WA1898</b></td> <td>1</td> <td>10/600 units</td> <td>1BT</td> </tr> <tr> <td><b>8WA1820</b></td> <td>1</td> <td>50/1400 units</td> <td>1BT</td> </tr> <tr> <td><b>8WA1011-1PF01</b></td> <td>1</td> <td>50/1250 units</td> <td>1BT</td> </tr> <tr> <td><b>8WA1011-1PF00</b></td> <td>1</td> <td>50/1250 units</td> <td>1BT</td> </tr> <tr> <td><b>8WA1820</b></td> <td>1</td> <td>50/1400 units</td> <td>1BT</td> </tr> </tbody> </table>							<b>8WA1011-1DF11</b>	1	100/1200 units	1BT	<b>8WA1011-1BF23</b>	1	50/1300 units	1BT	<b>8WA1011-1BF21</b>	1	50/1300 units	1BT	<b>8WA1011-1BF22</b>	1	50/1300 units	1BT	<b>8WA1011-1BF26</b>	1	50 units	1BT	<b>8WA1011-1BF24</b>	1	50/1300 units	1BT	<b>8WA1011-1BF25</b>	1	50/1300 units	1BT	<b>8WA1011-3DF21</b>	1	10 units	1BT	<b>8WA1011-0DF22</b>	1	20/100 units	1BT	<b>8WA1011-0DF21</b>	1	20/100 units	1BT	<b>8WA1810</b>	1	50 units	1BT	<b>8WA1860</b>	1	50 units	1BT	<b>8WA1822-7AX01</b>	1	10 units	1BT	<b>8WA1822-7AX03</b>	1	10 units	1BT	<b>8WA1822-7VF01</b>	1	50 units	1BT	<b>8WA1865</b>	1	50 units	1BT	<b>8WA1825</b>	1	50 units	1BT	<b>8WA1895</b>	1	50/600 units	1BT	<b>8WA1896</b>	1	50/600 units	1BT	<b>8WA1897</b>	1	20 units	1BT	<b>8WA1898</b>	1	10/600 units	1BT	<b>8WA1820</b>	1	50/1400 units	1BT	<b>8WA1011-1PF01</b>	1	50/1250 units	1BT	<b>8WA1011-1PF00</b>	1	50/1250 units	1BT	<b>8WA1820</b>	1	50/1400 units	1BT
<b>8WA1011-1DF11</b>	1	100/1200 units	1BT																																																																																																							
<b>8WA1011-1BF23</b>	1	50/1300 units	1BT																																																																																																							
<b>8WA1011-1BF21</b>	1	50/1300 units	1BT																																																																																																							
<b>8WA1011-1BF22</b>	1	50/1300 units	1BT																																																																																																							
<b>8WA1011-1BF26</b>	1	50 units	1BT																																																																																																							
<b>8WA1011-1BF24</b>	1	50/1300 units	1BT																																																																																																							
<b>8WA1011-1BF25</b>	1	50/1300 units	1BT																																																																																																							
<b>8WA1011-3DF21</b>	1	10 units	1BT																																																																																																							
<b>8WA1011-0DF22</b>	1	20/100 units	1BT																																																																																																							
<b>8WA1011-0DF21</b>	1	20/100 units	1BT																																																																																																							
<b>8WA1810</b>	1	50 units	1BT																																																																																																							
<b>8WA1860</b>	1	50 units	1BT																																																																																																							
<b>8WA1822-7AX01</b>	1	10 units	1BT																																																																																																							
<b>8WA1822-7AX03</b>	1	10 units	1BT																																																																																																							
<b>8WA1822-7VF01</b>	1	50 units	1BT																																																																																																							
<b>8WA1865</b>	1	50 units	1BT																																																																																																							
<b>8WA1825</b>	1	50 units	1BT																																																																																																							
<b>8WA1895</b>	1	50/600 units	1BT																																																																																																							
<b>8WA1896</b>	1	50/600 units	1BT																																																																																																							
<b>8WA1897</b>	1	20 units	1BT																																																																																																							
<b>8WA1898</b>	1	10/600 units	1BT																																																																																																							
<b>8WA1820</b>	1	50/1400 units	1BT																																																																																																							
<b>8WA1011-1PF01</b>	1	50/1250 units	1BT																																																																																																							
<b>8WA1011-1PF00</b>	1	50/1250 units	1BT																																																																																																							
<b>8WA1820</b>	1	50/1400 units	1BT																																																																																																							
 8WA1011-1PF01																																																																																																										

## 8WA1 Screw Terminals

## 8WA through-type terminals

Version	DT	Article No. <a href="http://www.siemens.com/product?Article No.">www.siemens.com/ product?Article No.</a>	Price per PU	PU (UNIT, SET, M)	PS*/ P. unit	PG																																																						
<b>Terminal size 4 mm<sup>2</sup></b>																																																												
 8WA1011-1DG11	<b>Through-type terminals, terminal size 4 mm<sup>2</sup></b> <ul style="list-style-type: none"> <li>Rated uninterrupted current 32 A</li> <li>Rated insulation voltage 800 V</li> <li>Mounting width 6.5 mm</li> <li>Terminal height 30 mm</li> <li>Terminal length 41 mm</li> <li>AWG 18-10</li> <li>AWG 18-10</li> </ul>																																																											
	<b>Versions</b> <ul style="list-style-type: none"> <li>Single terminals               <ul style="list-style-type: none"> <li>Beige</li> <li>Blue</li> <li>Red</li> <li>Orange</li> <li>Black</li> </ul> </li> <li>Terminal blocks               <ul style="list-style-type: none"> <li>Beige, 3-pole, width 19.5 mm</li> <li>Beige, 10-pole, width 65.5 mm, labeled 1 ... 10</li> <li>Beige, 10-pole, width 65.5 mm, without labeling</li> </ul> </li> </ul>																																																											
 8WA1011-0DG21	<b>Accessories</b> <table border="1"> <thead> <tr> <th>Accessories</th> <th>Section</th> <th>Page</th> </tr> </thead> <tbody> <tr> <td colspan="3"><b>Covers</b></td> </tr> <tr> <td>• With lightning symbol, for terminal size 4 and 6 mm<sup>2</sup></td> <td>Accessories</td> <td>9/13</td> </tr> <tr> <td>• White, facility for labeling, for terminal sizes 4 and 6 mm<sup>2</sup></td> <td>Accessories</td> <td>9/13</td> </tr> <tr> <td>• For connection bars:</td> <td></td> <td></td> </tr> <tr> <td>- Transparent, for terminal size 2.5 to 6 mm<sup>2</sup></td> <td>Accessories</td> <td>9/13</td> </tr> <tr> <td>- White, facility for labeling, for terminal size 2.5 to 6 mm<sup>2</sup></td> <td>Accessories</td> <td>9/13</td> </tr> <tr> <td>Jumpers, for terminal size 4 mm<sup>2</sup></td> <td>Accessories</td> <td>9/13</td> </tr> <tr> <td>Disconnecting links</td> <td>Accessories</td> <td>9/14</td> </tr> <tr> <td colspan="3"><b>Note</b></td> </tr> <tr> <td colspan="3">Between terminals with terminal sizes 2.5 and 6 mm<sup>2</sup>, two 8WH1820 barriers are required.</td> </tr> <tr> <td>• Insulation plates, for terminal size 2.5 to 6 mm<sup>2</sup></td> <td>Accessories</td> <td>9/14</td> </tr> <tr> <td>• Connection bars, for terminal size 4 mm<sup>2</sup></td> <td></td> <td></td> </tr> <tr> <td>- For two terminals</td> <td>Accessories</td> <td>9/14</td> </tr> <tr> <td>- For three terminals</td> <td>Accessories</td> <td>9/14</td> </tr> <tr> <td>- For four terminals</td> <td>Accessories</td> <td>9/14</td> </tr> <tr> <td>- For ten terminals</td> <td>Accessories</td> <td>9/14</td> </tr> <tr> <td>• Barriers, for terminal size 1.5 ... 4 mm<sup>2</sup></td> <td>Accessories</td> <td>9/14</td> </tr> </tbody> </table>						Accessories	Section	Page	<b>Covers</b>			• With lightning symbol, for terminal size 4 and 6 mm <sup>2</sup>	Accessories	9/13	• White, facility for labeling, for terminal sizes 4 and 6 mm <sup>2</sup>	Accessories	9/13	• For connection bars:			- Transparent, for terminal size 2.5 to 6 mm <sup>2</sup>	Accessories	9/13	- White, facility for labeling, for terminal size 2.5 to 6 mm <sup>2</sup>	Accessories	9/13	Jumpers, for terminal size 4 mm <sup>2</sup>	Accessories	9/13	Disconnecting links	Accessories	9/14	<b>Note</b>			Between terminals with terminal sizes 2.5 and 6 mm <sup>2</sup> , two 8WH1820 barriers are required.			• Insulation plates, for terminal size 2.5 to 6 mm <sup>2</sup>	Accessories	9/14	• Connection bars, for terminal size 4 mm <sup>2</sup>			- For two terminals	Accessories	9/14	- For three terminals	Accessories	9/14	- For four terminals	Accessories	9/14	- For ten terminals	Accessories	9/14	• Barriers, for terminal size 1.5 ... 4 mm <sup>2</sup>	Accessories	9/14
	Accessories	Section	Page																																																									
<b>Covers</b>																																																												
• With lightning symbol, for terminal size 4 and 6 mm <sup>2</sup>	Accessories	9/13																																																										
• White, facility for labeling, for terminal sizes 4 and 6 mm <sup>2</sup>	Accessories	9/13																																																										
• For connection bars:																																																												
- Transparent, for terminal size 2.5 to 6 mm <sup>2</sup>	Accessories	9/13																																																										
- White, facility for labeling, for terminal size 2.5 to 6 mm <sup>2</sup>	Accessories	9/13																																																										
Jumpers, for terminal size 4 mm <sup>2</sup>	Accessories	9/13																																																										
Disconnecting links	Accessories	9/14																																																										
<b>Note</b>																																																												
Between terminals with terminal sizes 2.5 and 6 mm <sup>2</sup> , two 8WH1820 barriers are required.																																																												
• Insulation plates, for terminal size 2.5 to 6 mm <sup>2</sup>	Accessories	9/14																																																										
• Connection bars, for terminal size 4 mm <sup>2</sup>																																																												
- For two terminals	Accessories	9/14																																																										
- For three terminals	Accessories	9/14																																																										
- For four terminals	Accessories	9/14																																																										
- For ten terminals	Accessories	9/14																																																										
• Barriers, for terminal size 1.5 ... 4 mm <sup>2</sup>	Accessories	9/14																																																										
<table border="1"> <tbody> <tr> <td><b>8WA1011-1DG11</b></td> <td>1</td> <td>100/1200 units</td> <td>1BT</td> </tr> <tr> <td><b>8WA1011-1BG11</b></td> <td>1</td> <td>50/1200 units</td> <td>1BT</td> </tr> <tr> <td><b>8WA1011-1BG21</b></td> <td>1</td> <td>50/1200 units</td> <td>1BT</td> </tr> <tr> <td><b>8WA1011-1BG22</b></td> <td>1</td> <td>50 units</td> <td>1BT</td> </tr> <tr> <td><b>8WA1011-1BG24</b></td> <td>1</td> <td>50 units</td> <td>1BT</td> </tr> <tr> <td><b>8WA1011-3DG21</b></td> <td>1</td> <td>10 units</td> <td>1BT</td> </tr> <tr> <td><b>8WA1011-0DG22</b></td> <td>1</td> <td>20 units</td> <td>1BT</td> </tr> <tr> <td><b>8WA1011-0DG21</b></td> <td>1</td> <td>20 units</td> <td>1BT</td> </tr> </tbody> </table>						<b>8WA1011-1DG11</b>	1	100/1200 units	1BT	<b>8WA1011-1BG11</b>	1	50/1200 units	1BT	<b>8WA1011-1BG21</b>	1	50/1200 units	1BT	<b>8WA1011-1BG22</b>	1	50 units	1BT	<b>8WA1011-1BG24</b>	1	50 units	1BT	<b>8WA1011-3DG21</b>	1	10 units	1BT	<b>8WA1011-0DG22</b>	1	20 units	1BT	<b>8WA1011-0DG21</b>	1	20 units	1BT																							
<b>8WA1011-1DG11</b>	1	100/1200 units	1BT																																																									
<b>8WA1011-1BG11</b>	1	50/1200 units	1BT																																																									
<b>8WA1011-1BG21</b>	1	50/1200 units	1BT																																																									
<b>8WA1011-1BG22</b>	1	50 units	1BT																																																									
<b>8WA1011-1BG24</b>	1	50 units	1BT																																																									
<b>8WA1011-3DG21</b>	1	10 units	1BT																																																									
<b>8WA1011-0DG22</b>	1	20 units	1BT																																																									
<b>8WA1011-0DG21</b>	1	20 units	1BT																																																									
<table border="1"> <tbody> <tr> <td><b>8WA1811</b></td> <td>1</td> <td>50 units</td> <td>1BT</td> </tr> <tr> <td><b>8WA1862</b></td> <td>1</td> <td>50 units</td> <td>1BT</td> </tr> <tr> <td><b>8WA1822-7AX01</b></td> <td>1</td> <td>10 units</td> <td>1BT</td> </tr> <tr> <td><b>8WA1822-7AX03</b></td> <td>1</td> <td>10 units</td> <td>1BT</td> </tr> <tr> <td><b>8WA1822-7VG00</b></td> <td>1</td> <td>50 units</td> <td>1BT</td> </tr> <tr> <td><b>8WA1865</b></td> <td>1</td> <td>50 units</td> <td>1BT</td> </tr> </tbody> </table>						<b>8WA1811</b>	1	50 units	1BT	<b>8WA1862</b>	1	50 units	1BT	<b>8WA1822-7AX01</b>	1	10 units	1BT	<b>8WA1822-7AX03</b>	1	10 units	1BT	<b>8WA1822-7VG00</b>	1	50 units	1BT	<b>8WA1865</b>	1	50 units	1BT																															
<b>8WA1811</b>	1	50 units	1BT																																																									
<b>8WA1862</b>	1	50 units	1BT																																																									
<b>8WA1822-7AX01</b>	1	10 units	1BT																																																									
<b>8WA1822-7AX03</b>	1	10 units	1BT																																																									
<b>8WA1822-7VG00</b>	1	50 units	1BT																																																									
<b>8WA1865</b>	1	50 units	1BT																																																									
<table border="1"> <tbody> <tr> <td><b>8WA1825</b></td> <td>1</td> <td>50 units</td> <td>1BT</td> </tr> <tr> <td><b>8WA1850</b></td> <td>1</td> <td>50 units</td> <td>1BT</td> </tr> <tr> <td><b>8WA1851</b></td> <td>1</td> <td>50 units</td> <td>1BT</td> </tr> <tr> <td><b>8WA1852</b></td> <td>1</td> <td>20 units</td> <td>1BT</td> </tr> <tr> <td><b>8WA1853</b></td> <td>1</td> <td>10/600 units</td> <td>1BT</td> </tr> <tr> <td><b>8WA1820</b></td> <td>1</td> <td>50/1400 units</td> <td>1BT</td> </tr> </tbody> </table>						<b>8WA1825</b>	1	50 units	1BT	<b>8WA1850</b>	1	50 units	1BT	<b>8WA1851</b>	1	50 units	1BT	<b>8WA1852</b>	1	20 units	1BT	<b>8WA1853</b>	1	10/600 units	1BT	<b>8WA1820</b>	1	50/1400 units	1BT																															
<b>8WA1825</b>	1	50 units	1BT																																																									
<b>8WA1850</b>	1	50 units	1BT																																																									
<b>8WA1851</b>	1	50 units	1BT																																																									
<b>8WA1852</b>	1	20 units	1BT																																																									
<b>8WA1853</b>	1	10/600 units	1BT																																																									
<b>8WA1820</b>	1	50/1400 units	1BT																																																									
 8WA1011-1PG01	<b>PE through-type terminals, terminal size 4 mm<sup>2</sup></b> <ul style="list-style-type: none"> <li>Green/yellow</li> <li>Mounting width 7.2 mm</li> <li>Terminal height 30 mm</li> <li>Terminal length 51 mm</li> <li>AWG 18-10</li> </ul>																																																											
	<b>Versions</b> <ul style="list-style-type: none"> <li>One screw terminal</li> <li>Two screw terminals</li> </ul>																																																											
<b>Accessories</b> <table border="1"> <thead> <tr> <th>Accessories</th> <th>Section</th> <th>Page</th> </tr> </thead> <tbody> <tr> <td>Barriers, for terminal size 1.5 ... 4 mm<sup>2</sup></td> <td>Accessories</td> <td>9/14</td> </tr> </tbody> </table>						Accessories	Section	Page	Barriers, for terminal size 1.5 ... 4 mm <sup>2</sup>	Accessories	9/14																																																	
Accessories	Section	Page																																																										
Barriers, for terminal size 1.5 ... 4 mm <sup>2</sup>	Accessories	9/14																																																										
<table border="1"> <tbody> <tr> <td><b>8WA1011-1PG01</b></td> <td>1</td> <td>50/900 units</td> <td>1BT</td> </tr> <tr> <td><b>8WA1011-1PG00</b></td> <td>1</td> <td>50/900 units</td> <td>1BT</td> </tr> <tr> <td><b>8WA1820</b></td> <td>1</td> <td>50/1400 units</td> <td>1BT</td> </tr> </tbody> </table>						<b>8WA1011-1PG01</b>	1	50/900 units	1BT	<b>8WA1011-1PG00</b>	1	50/900 units	1BT	<b>8WA1820</b>	1	50/1400 units	1BT																																											
<b>8WA1011-1PG01</b>	1	50/900 units	1BT																																																									
<b>8WA1011-1PG00</b>	1	50/900 units	1BT																																																									
<b>8WA1820</b>	1	50/1400 units	1BT																																																									

Version	DT	Article No. <a href="http://www.siemens.com/product?ArticleNo.">www.siemens.com/ product?Article No.</a>	Price per PU	PU (UNIT, SET, M)	PS*/ P. unit	PG
---------	----	---	--------------------	-------------------------	-----------------	----

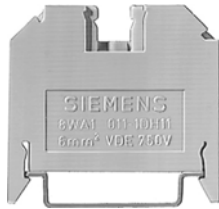
Terminal size 6 mm<sup>2</sup>

8WA1011-1DH11



8WA1011-3DH21

**Through-type terminals, terminal size 6 mm<sup>2</sup>**

- Rated uninterrupted current 41 A
- Rated insulation voltage 800 V
- Mounting width 8 mm
- Terminal height 33 mm
- Terminal length 41 mm
- AWG 14-8
- AWG 16-8

## Versions

- Single terminals
  - Beige
  - Blue
  - Black
- Terminal blocks
  - Beige, 3-pole, width 24.5 mm

## Accessories

	Section	Page
• <b>Covers</b>		
- With lightning symbol, for terminal size 4 to 6 mm <sup>2</sup>	Accessories	9/13
- White, facility for labeling, for terminal sizes 4 and 6 mm <sup>2</sup>	Accessories	9/13
- For connection bars, transparent, for terminal size 2.5 ... 6 mm <sup>2</sup>	Accessories	9/13
• Jumpers, for terminal size 6 mm <sup>2</sup>	Accessories	9/13
• Disconnecting links	Accessories	9/14

## Note

Between terminals with terminal sizes 2.5 and 6 mm<sup>2</sup>, two 8WH1820 barriers are required.

• Insulation plates, for terminal size 2.5 to 6 mm <sup>2</sup>	Accessories	9/14
• Connection bars, for terminal size 6 mm <sup>2</sup>		
- For two terminals	Accessories	9/14
- For three terminals	Accessories	9/14
- For four terminals	Accessories	9/14
- For ten terminals	Accessories	9/14
• Barriers, for terminal size 6 and 16 mm <sup>2</sup>	Accessories	9/14

**PE through-type terminals, terminal size 6 mm<sup>2</sup>, one screw terminal**

- Bare
- Mounting width 6 mm
- Terminal height 25 mm
- Terminal length 44 mm
- Also for use as shield terminal

## Accessories

	Section	Page
Barriers, for terminal size 6 and 16 mm <sup>2</sup>	Accessories	9/14

8WA1010-1PH01

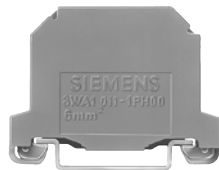

8WA1011-1PH00

**PE through-type terminals, terminal size 6 mm<sup>2</sup>, two screw terminals**

- Green/yellow
- Mounting width 8 mm
- Terminal height 33 mm
- Terminal length 51 mm
- 

## Accessories











	Section	Page
Barriers, for terminal size 6 and 16 mm <sup>2</sup>	Accessories	9/14

<b>8WA1011-1DH11</b>	1	50/700 units	1BT
<b>8WA1011-1BH23</b>	1	50/700 units	1BT
<b>8WA1011-1BH24</b>	1	50/700 units	1BT
<b>8WA1011-3DH21</b>	1	20 units	1BT
<b>8WA1811</b>	1	50 units	1BT
<b>8WA1862</b>	1	50 units	1BT
<b>8WA1822-7AX01</b>	1	10 units	1BT
<b>8WA1822-7VH00</b>	1	50 units	1BT
<b>8WA1865</b>	1	50 units	1BT
<b>8WA1825</b>	1	50 units	1BT
<b>8WA1885</b>	1	50 units	1BT
<b>8WA1886</b>	1	50 units	1BT
<b>8WA1887</b>	1	20 units	1BT
<b>8WA1888</b>	1	10/780 units	1BT
<b>8WA1821</b>	1	50/1050 units	1BT
<b>8WA1010-1PH01</b>	1	50 units	1BT
<b>8WA1821</b>	1	50/1050 units	1BT
<b>8WA1011-1PH00</b>	1	50/600 units	1BT
<b>8WA1821</b>	1	50/1050 units	1BT









## 8WA through-type terminals

Version	DT	Article No. <a href="http://www.siemens.com/product?ArticleNo.">www.siemens.com/ product?Article No.</a>	Price per PU	PU (UNIT, SET, M)	PS*/ P. unit	PG												
 <p><b>PE through-type terminals and PEN through-type terminals, terminal size 35 mm<sup>2</sup></b></p> <ul style="list-style-type: none"> <li>• Green/yellow</li> <li>• For I = 125 A</li> <li>• Mounting width 16 mm</li> <li>• Terminal height 50 mm</li> <li>• Terminal length 53 mm</li> <li>• Two screw terminals</li> <li>•  </li> </ul>		<b>8WA1011-1PM00</b>		1	25 units	1BT												
	<table border="1"> <thead> <tr> <th>Accessories</th> <th>Section</th> <th>Page</th> </tr> </thead> <tbody> <tr> <td>Barriers, for terminal size 35 mm<sup>2</sup></td> <td>Accessories</td> <td>9/13</td> </tr> </tbody> </table>	Accessories	Section	Page	Barriers, for terminal size 35 mm <sup>2</sup>	Accessories	9/13											
Accessories	Section	Page																
Barriers, for terminal size 35 mm <sup>2</sup>	Accessories	9/13																
8WA1011-1PM00		<b>8WA1823</b>		1	25/600 units	1BT												
<b>Terminal size 70 mm<sup>2</sup></b>																		
 <p><b>Through-type terminals, terminal size 70 mm<sup>2</sup></b></p> <ul style="list-style-type: none"> <li>• Rated uninterrupted current 192 A</li> <li>• Rated insulation voltage 800 V</li> <li>• Mounting width 25 mm</li> <li>• Terminal height 64.5 mm</li> <li>• Terminal length 73.5 mm</li> <li>•  AWG 8-3/0</li> <li>•  AWG 8-1/0</li> </ul>																		
	<table border="1"> <thead> <tr> <th>Versions</th> </tr> </thead> <tbody> <tr> <td> <ul style="list-style-type: none"> <li>• Beige</li> <li>• Blue</li> </ul> </td> </tr> </tbody> </table> <table border="1"> <thead> <tr> <th>Accessories</th> <th>Section</th> <th>Page</th> </tr> </thead> <tbody> <tr> <td>Covers, with lightning symbol, for terminal size 70 mm<sup>2</sup></td> <td>Accessories</td> <td>9/13</td> </tr> <tr> <td>Connection bars, for terminal size 70 mm<sup>2</sup>, for 2 terminals</td> <td>Accessories</td> <td>9/13</td> </tr> <tr> <td>Barriers, for terminal size 70 mm<sup>2</sup></td> <td>Accessories</td> <td>9/13</td> </tr> </tbody> </table>	Versions	<ul style="list-style-type: none"> <li>• Beige</li> <li>• Blue</li> </ul>	Accessories	Section	Page	Covers, with lightning symbol, for terminal size 70 mm <sup>2</sup>	Accessories	9/13	Connection bars, for terminal size 70 mm <sup>2</sup> , for 2 terminals	Accessories	9/13	Barriers, for terminal size 70 mm <sup>2</sup>	Accessories	9/13			
Versions																		
<ul style="list-style-type: none"> <li>• Beige</li> <li>• Blue</li> </ul>																		
Accessories	Section	Page																
Covers, with lightning symbol, for terminal size 70 mm <sup>2</sup>	Accessories	9/13																
Connection bars, for terminal size 70 mm <sup>2</sup> , for 2 terminals	Accessories	9/13																
Barriers, for terminal size 70 mm <sup>2</sup>	Accessories	9/13																
8WA1206		<b>8WA1206</b>		1	10/60 units	1BT												
		<b>8WA1011-1BP11</b>		1	10/60 units	1BT												
		<b>8WA1814</b>		1	50 units	1BT												
		<b>8WA1216</b>		1	20 units	1BT												
		<b>8WA1824</b>		1	25/600 units	1BT												
<b>Accessories</b>																		
<b>Covers</b>																		
 <p><b>8WA1810</b></p>	<table border="1"> <thead> <tr> <th>Versions</th> </tr> </thead> <tbody> <tr> <td> <ul style="list-style-type: none"> <li>• With lightning symbol <ul style="list-style-type: none"> <li>- For terminal size 1.5 up to 2.5 mm<sup>2</sup></li> <li>- For terminal sizes 4 and 6 mm<sup>2</sup></li> <li>- For terminal size 16 mm<sup>2</sup></li> <li>- For terminal size 35 mm<sup>2</sup></li> <li>- For terminal size 70 mm<sup>2</sup></li> </ul> </li> </ul> </td> </tr> </tbody> </table>	Versions	<ul style="list-style-type: none"> <li>• With lightning symbol <ul style="list-style-type: none"> <li>- For terminal size 1.5 up to 2.5 mm<sup>2</sup></li> <li>- For terminal sizes 4 and 6 mm<sup>2</sup></li> <li>- For terminal size 16 mm<sup>2</sup></li> <li>- For terminal size 35 mm<sup>2</sup></li> <li>- For terminal size 70 mm<sup>2</sup></li> </ul> </li> </ul>															
Versions																		
<ul style="list-style-type: none"> <li>• With lightning symbol <ul style="list-style-type: none"> <li>- For terminal size 1.5 up to 2.5 mm<sup>2</sup></li> <li>- For terminal sizes 4 and 6 mm<sup>2</sup></li> <li>- For terminal size 16 mm<sup>2</sup></li> <li>- For terminal size 35 mm<sup>2</sup></li> <li>- For terminal size 70 mm<sup>2</sup></li> </ul> </li> </ul>																		
		<b>8WA1810</b>		1	50 units	1BT												
		<b>8WA1811</b>		1	50 units	1BT												
		<b>8WA1812</b>		1	50 units	1BT												
		<b>8WA1813</b>		1	50 units	1BT												
		<b>8WA1814</b>		1	50 units	1BT												
 <p><b>8WA1860</b></p>	<table border="1"> <tbody> <tr> <td> <ul style="list-style-type: none"> <li>• White, facility for labeling <ul style="list-style-type: none"> <li>- For terminal size 1.5 up to 2.5 mm<sup>2</sup></li> <li>- For terminal sizes 4 and 6 mm<sup>2</sup></li> <li>- For terminal size 16 mm<sup>2</sup></li> <li>- For terminal size 35 mm<sup>2</sup></li> </ul> </li> </ul> </td> </tr> </tbody> </table>	<ul style="list-style-type: none"> <li>• White, facility for labeling <ul style="list-style-type: none"> <li>- For terminal size 1.5 up to 2.5 mm<sup>2</sup></li> <li>- For terminal sizes 4 and 6 mm<sup>2</sup></li> <li>- For terminal size 16 mm<sup>2</sup></li> <li>- For terminal size 35 mm<sup>2</sup></li> </ul> </li> </ul>																
<ul style="list-style-type: none"> <li>• White, facility for labeling <ul style="list-style-type: none"> <li>- For terminal size 1.5 up to 2.5 mm<sup>2</sup></li> <li>- For terminal sizes 4 and 6 mm<sup>2</sup></li> <li>- For terminal size 16 mm<sup>2</sup></li> <li>- For terminal size 35 mm<sup>2</sup></li> </ul> </li> </ul>																		
		<b>8WA1860</b>		1	50 units	1BT												
		<b>8WA1862</b>		1	50 units	1BT												
		<b>8WA1892</b>		1	50 units	1BT												
		<b>8WA1893</b>		1	50 units	1BT												
 <p><b>8WA1822-7AX01</b></p>	<table border="1"> <tbody> <tr> <td> <ul style="list-style-type: none"> <li>• For connection bars, transparent <ul style="list-style-type: none"> <li>- For terminal size 2.5 to 6 mm<sup>2</sup></li> <li>- For terminal sizes 16 and 35 mm<sup>2</sup></li> </ul> </li> </ul> </td> </tr> </tbody> </table>	<ul style="list-style-type: none"> <li>• For connection bars, transparent <ul style="list-style-type: none"> <li>- For terminal size 2.5 to 6 mm<sup>2</sup></li> <li>- For terminal sizes 16 and 35 mm<sup>2</sup></li> </ul> </li> </ul>																
<ul style="list-style-type: none"> <li>• For connection bars, transparent <ul style="list-style-type: none"> <li>- For terminal size 2.5 to 6 mm<sup>2</sup></li> <li>- For terminal sizes 16 and 35 mm<sup>2</sup></li> </ul> </li> </ul>																		
		<b>8WA1822-7AX01</b>		1	10 units	1BT												
		<b>8WA1822-7AX02</b>		1	10 units	1BT												
		<b>8WA1822-7AX03</b>		1	10 units	1BT												
 <p><b>8WA1822-7VF01</b></p>	<table border="1"> <thead> <tr> <th>Jumpers</th> </tr> </thead> <tbody> <tr> <td>For connection bars</td> </tr> <tr> <th>Versions</th> </tr> <tr> <td> <ul style="list-style-type: none"> <li>• For terminal size 2.5 mm<sup>2</sup></li> <li>• For terminal size 4 mm<sup>2</sup></li> <li>• For terminal size 6 mm<sup>2</sup></li> </ul> </td> </tr> </tbody> </table>	Jumpers	For connection bars	Versions	<ul style="list-style-type: none"> <li>• For terminal size 2.5 mm<sup>2</sup></li> <li>• For terminal size 4 mm<sup>2</sup></li> <li>• For terminal size 6 mm<sup>2</sup></li> </ul>													
Jumpers																		
For connection bars																		
Versions																		
<ul style="list-style-type: none"> <li>• For terminal size 2.5 mm<sup>2</sup></li> <li>• For terminal size 4 mm<sup>2</sup></li> <li>• For terminal size 6 mm<sup>2</sup></li> </ul>																		
		<b>8WA1822-7VF01</b>		1	50 units	1BT												
		<b>8WA1822-7VG00</b>		1	50 units	1BT												
		<b>8WA1822-7VH00</b>		1	50 units	1BT												
 <p><b>8WA1808</b></p>	<table border="1"> <tbody> <tr> <td> <ul style="list-style-type: none"> <li>• <b>End retainers, thermoplastic</b></li> <li>• Width 10 mm</li> </ul> </td> </tr> </tbody> </table>	<ul style="list-style-type: none"> <li>• <b>End retainers, thermoplastic</b></li> <li>• Width 10 mm</li> </ul>																
<ul style="list-style-type: none"> <li>• <b>End retainers, thermoplastic</b></li> <li>• Width 10 mm</li> </ul>																		
		<b>8WA1808</b>		1	50/500 units	1BT												

## 8WA1 Screw Terminals

## 8WA through-type terminals

	Version	DT	Article No. <a href="http://www.siemens.com/product?Article.No.">www.siemens.com/ product?Article No.</a>	Price per PU	PU (UNIT, SET, M)	PS*/ P. unit	PG
	<b>Disconnecting links</b> Up to 32 A  <b>Note</b> Between terminals with terminal sizes 2.5 and 6 mm <sup>2</sup> , two 8WH1820 barriers are required.		<b>8WA1865</b>		1	50 units	1BT
8WA1865							
	<b>Insulation plates</b> <b>Versions</b> <ul style="list-style-type: none"> <li>For terminal size 2.5 to 6 mm<sup>2</sup></li> <li>For terminal sizes 16 and 35 mm<sup>2</sup></li> </ul>		<b>8WA1825</b> <b>8WA1822-7TK00</b>		1 1	50 units 50 units	1BT 1BT
8WA1825							
	<b>Connection bars</b> <b>Versions</b> <ul style="list-style-type: none"> <li>For terminal size 2.5 mm<sup>2</sup> <ul style="list-style-type: none"> <li>For two terminals</li> <li>For three terminals</li> <li>For four terminals</li> <li>For ten terminals</li> </ul> </li> <li>For terminal size 4 mm<sup>2</sup> <ul style="list-style-type: none"> <li>For two terminals</li> <li>For three terminals</li> <li>For four terminals</li> <li>For ten terminals</li> </ul> </li> <li>For terminal size 6 mm<sup>2</sup> <ul style="list-style-type: none"> <li>For two terminals</li> <li>For three terminals</li> <li>For four terminals</li> <li>For ten terminals</li> </ul> </li> <li>For terminal size 16 mm<sup>2</sup> <ul style="list-style-type: none"> <li>For two terminals</li> <li>For three terminals</li> <li>For four terminals</li> <li>For ten terminals</li> </ul> </li> <li>For terminal size 35 mm<sup>2</sup> <ul style="list-style-type: none"> <li>For two terminals</li> <li>For three terminals</li> <li>For ten terminals</li> </ul> </li> <li>For terminal size 70 mm<sup>2</sup> <ul style="list-style-type: none"> <li>For two terminals</li> </ul> </li> </ul>		<b>8WA1895</b> <b>8WA1896</b> <b>8WA1897</b> <b>8WA1898</b>  <b>8WA1850</b> <b>8WA1851</b> <b>8WA1852</b> <b>8WA1853</b>  <b>8WA1885</b> <b>8WA1886</b> <b>8WA1887</b> <b>8WA1888</b>  <b>8WA1842</b> <b>8WA1845</b> <b>8WA1848</b> <b>8WA1802</b>  <b>8WA1828</b> <b>8WA1803</b> <b>8WA1804</b>  <b>8WA1216</b>		1 1 1 1  1 1 1 1  1 1 1 1  1 1 1 1  1 1 1 1  1	50/600 units 50/600 units 20 units 10/600 units  50 units 50 units 20 units 10/600 units  50 units 50 units 20 units 10/780 units  20 units 20 units 10 units 10/280 units  20 units 20 units 10/140 units  20 units	1BT 1BT 1BT 1BT  1BT 1BT 1BT 1BT  1BT 1BT 1BT 1BT  1BT 1BT 1BT 1BT  1BT
8WA1895							
	<b>Barriers</b> <b>Versions</b> <ul style="list-style-type: none"> <li>For terminal size 1.5 ... 4 mm<sup>2</sup></li> <li>For terminal sizes 6 and 16 mm<sup>2</sup></li> <li>For terminal size 35 mm<sup>2</sup></li> <li>For terminal size 70 mm<sup>2</sup></li> </ul>		<b>8WA1820</b> <b>8WA1821</b> <b>8WA1823</b> <b>8WA1824</b>		1 1 1 1	50/1400 units 50/1050 units 25/600 units 25/600 units	1BT 1BT 1BT 1BT
8WA1820							

## Overview





N-conductor isolating terminals permit an insulation test to be performed without disconnecting the neutral conductor according to DIN VDE 0108 and DIN VDE 0100 (Standards for the erection of power installations).

The branch terminals are used for the connection of lines (L), for example for power supplies, to the 6 x 6 mm busbar.

The rated voltage between two branch terminals (1 slide open) is 289 V.

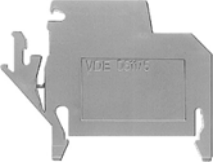

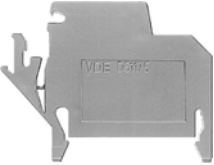



When they are used as shield terminals according to DIN VDE 0160, they provide isolation between the central reference point (shield connection conductor) and the PE conductor.

## Selection and ordering data

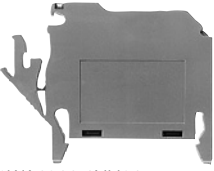
Version	DT	Article No. <a href="http://www.siemens.com/product?Article No.">www.siemens.com/ product?Article No.</a>	Price per PU	PU (UNIT, SET, M)	PS*/ P. unit	PG	
<b>General details</b> <ul style="list-style-type: none"> <li>• 1 screw terminal and connection to the neutral conductor bar or 6 x 6 mm busbar acc. to DIN 1761</li> <li>• Insulating body made of blue or beige thermoplastic</li> <li>• Enclosed at both ends</li> </ul>							
Note		Section	Page				
For labeling accessories, see ...		Accessories	11/2				
<b>Terminal size 2.5 mm<sup>2</sup></b>							
 8WA1011-1NF01	<b>N-conductor isolating terminals, terminal size 2.5 mm<sup>2</sup></b> <ul style="list-style-type: none"> <li>• Blue</li> <li>• Rated uninterrupted current 24 A</li> <li>• Rated insulation voltage 500 V</li> <li>• Mounting width 6 mm</li> <li>• Terminal height 35 mm</li> <li>• Terminal length 55 mm</li> <li>• With built-in test socket in the fixed part of the terminal</li> <li>•  AWG 22-12</li> <li>•  AWG 22-12</li> </ul>		8WA1011-1NF01		1	50 units	1BT
	Accessories		Section	Page			
• Covers, for connection bars		Accessories	9/16				
• N-busbars, 6 x 6 mm		Accessories	9/16				
• Label holders		Accessories	9/16				
<b>Terminal size 4 mm<sup>2</sup></b>							
 8WA1011-1NG31	<b>N-conductor isolating terminals, terminal size 4 mm<sup>2</sup></b> <ul style="list-style-type: none"> <li>• Blue</li> <li>• Rated uninterrupted current 32 A</li> <li>• Rated insulation voltage 500 V</li> <li>• Mounting width 6.5 mm</li> <li>• Terminal height 35 mm</li> <li>• Terminal length 55 mm</li> <li>• With built-in test socket in the fixed part of the terminal</li> <li>•  AWG 18-10</li> <li>•  AWG 18-10</li> </ul>		8WA1011-1NG31		1	50 units	1BT
	Accessories		Section	Page			
• Covers, for connection bars		Accessories	9/16				
• Feeder terminals, for N-busbars		Accessories	9/16				
• N-busbars, 6 x 6 mm		Accessories	9/16				
• Label holders		Accessories	9/16				
			8WA1822-7AX00		1	10 units	1BT
			8GF9324-2		1	10 units	1BP
			3TX4210-0J		100	100 units	41B
			8WA1011-1NG31		1	50 units	1BT
			8WA1822-7AX00		1	10 units	1BT
			8WA2867		1	50/2400 units	1BT
			8GF9324-2		1	10 units	1BP
			3TX4210-0J		100	100 units	41B

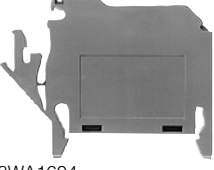
## 8WA1 Screw Terminals

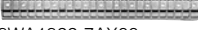
## 8WA N-conductor isolating and branch terminals

Version	DT	Article No. <a href="http://www.siemens.com/product?Article No.">www.siemens.com/ product?Article No.</a>	Price per PU	PU (UNIT, SET, M)	PS*/ P. unit	PG
<b>Terminal size 6 mm<sup>2</sup></b>						
 <p>8WA1011-1NH01</p>	<b>N-conductor isolating terminals, terminal size 6 mm<sup>2</sup></b> <ul style="list-style-type: none"> <li>• Blue</li> <li>• Rated uninterrupted current 41 A</li> <li>• Rated insulation voltage 500 V</li> <li>• Mounting width 8 mm</li> <li>• Terminal height 35 mm</li> <li>• Terminal length 55 mm</li> <li>• With built-in test socket in the fixed part of the terminal</li> <li>•  AWG 14-8</li> <li>•  AWG 14-8</li> </ul>		8WA1011-1NH01		1	50 units 1BT
	Accessories	Section	Page			
<ul style="list-style-type: none"> <li>• Covers, for connection bars</li> <li>• N-busbars, 6 × 6 mm</li> <li>• Label holders</li> </ul>		Accessories	9/16			
		Accessories	9/16			
		Accessories	9/16			
<b>Terminal size 16 mm<sup>2</sup></b>						
 <p>8WA1604</p>	<b>N-conductor isolating terminals, terminal size 16 mm<sup>2</sup></b> <ul style="list-style-type: none"> <li>• Blue</li> <li>• Rated uninterrupted current 76 A</li> <li>• Rated insulation voltage 500 V</li> <li>• Mounting width 10 mm</li> <li>• Terminal height 35 mm</li> <li>• Terminal length 55 mm</li> <li>•  AWG 12-4</li> </ul>		8WA1604		1	50 units 1BT
	Accessories	Section	Page			
<ul style="list-style-type: none"> <li>• Covers, for connection bars</li> <li>• Feeder terminals, for N-busbars</li> <li>• N-busbars, 6 × 6 mm</li> <li>• Label holders</li> </ul>		Accessories	9/16			
		Accessories	9/16			
		Accessories	9/16			
		Accessories	9/16			
<b>Accessories</b>						
 <p>8WA1822-7AX00</p>	<b>Covers, for connection bars</b> <ul style="list-style-type: none"> <li>• Not for 8WA1604</li> <li>• Length 155 mm</li> </ul>		8WA1822-7AX00		1	10 units 1BT
	<b>Feeder terminals, for N-busbars</b> <ul style="list-style-type: none"> <li>• 6 × 6 mm and 10 × 3 mm</li> <li>• Bare</li> </ul>					
<b>Versions</b> <ul style="list-style-type: none"> <li>• Rated uninterrupted current 32 A, for connection of up to 4 mm<sup>2</sup></li> <li>• Rated uninterrupted current 76 A, for connection of up to 25 mm<sup>2</sup></li> <li>• Rated uninterrupted current 125 A, for connection of up to 35 mm<sup>2</sup></li> </ul>						
 <p>8WA2870 / 868 / 867</p>			8WA2867		1	50/2400 units 1BT
			8WA2868		1	50/750 units 1BT
			8WA2870		1	50 units 1BT
 <p>8GF9324-2</p>	<b>N-busbars, 6 × 6 mm</b> <ul style="list-style-type: none"> <li>• Rated uninterrupted current 125 A</li> <li>• 1109 mm long</li> <li>• For four-field</li> </ul>		8GF9324-2		1	10 units 1BP
	<b>Note</b> Prices apply for orders from € 25.00. For orders below € 25.00, a processing charge of € 2.50 net will be added.					
<b>Label holders</b>		3TX4210-OJ		100	100 units	41B

## Overview

The Insta or three-tier terminals incorporate up to 3 different terminal functions in one insulating body of 6 mm width. The width of 3 Insta terminals corresponds to the modular width of 18 mm standardized in distribution board assembly. **Tools are required to remove the terminals from the support rail.**

All clamping points for incoming and outgoing cables have a cutout for an 8WA8 8.. inscription label. The protective conductor connections are already marked green-yellow and the neutral conductor connections blue.

The N-busbar has the same position for Insta terminals and N-conductor isolating terminals. This allows, for example, the use of a 16 mm<sup>2</sup> N-conductor isolating terminal as an infeed for the N-busbar.

8WA1011-3JF16, -3JF17 and -3JF18 allow the N-busbar to be routed with a mounting depth of 42.5 mm.

### PE, L, NT Insta terminal

The 8WA1011-3JF20 terminal is the basic version for AC circuits. It comprises:

- Protective conductor connection
- Through-type connection for one phase conductor
- Neutral conductor connection that can be isolated from the 6 × 6 mm N-busbar.

### PE, L, N Insta terminals

If no neutral conductor isolation is required, the 8WA1011-3JF17 terminal is used:

- Protective conductor connection
- Through-type connection for one phase conductor
- Through-type connection for the neutral conductor

### PE, L, L Insta terminal

Design of 8WA1011-3JF16 terminal as previous version. Instead of the through-type connection for the neutral conductor, a through-type connection for a second phase conductor is fitted.

### L, L Insta terminal

The 8WA1011-3JF18 terminal contains two through-type connections for two phase conductors. These are generally used for three-phase outgoing lines.

## Selection and ordering data

Version	DT	Article No. <a href="http://www.siemens.com/product?Article No.">www.siemens.com/ product?Article No.</a>	Price per PU	PU (UNIT, SET, M)	PS*/ P. unit	PG						
<b>General details</b> <ul style="list-style-type: none"> <li>• Thermoplastic insulating body</li> <li>• Screw terminal at both ends</li> <li>• Enclosed at both ends</li> <li>• Neutral terminal, 6 × 6 mm neutral conductor connection</li> </ul> <table border="1"> <thead> <tr> <th>Note</th> <th>Section</th> <th>Page</th> </tr> </thead> <tbody> <tr> <td>For labeling accessories, see ...</td> <td>Accessories</td> <td>11/2</td> </tr> </tbody> </table>	Note	Section	Page	For labeling accessories, see ...	Accessories	11/2						
Note	Section	Page										
For labeling accessories, see ...	Accessories	11/2										

### Terminal size 2.5 mm<sup>2</sup>

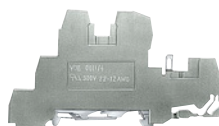

8WA1011-3JF16

#### Insta terminals, terminal size 2.5 mm<sup>2</sup>







- Rated uninterrupted current 24 A
- Rated insulation voltage
  - 400 V between phase conductors
  - 250 V between phase and protective conductors and for neutral isolating distance
- Mounting width 6 mm
- Terminal height 42.5 mm
- Terminal length 87 mm
- Screw terminals at both ends
- AWG 22-12

Circuit diagram	Type	Article No.	Price per PU	PU (UNIT, SET, M)	PS*/P. unit	PG
	PE, L, L	8WA1011-3JF16		1 50/450 units	1BT	
	PE, L, N	8WA1011-3JF17		1 50/450 units	1BT	
	L, L	8WA1011-3JF18		1 50/450 units	1BT	
	PE, L, NT	8WA1011-3JF20		1 50/450 units	1BT	
<b>Accessories</b> Barriers, for Insta terminals, terminal size 2.5 mm <sup>2</sup> and measuring transformer terminals, terminal size 6 mm <sup>2</sup>		8WA1822-7TH00		1 50 units	1BT	

\* You can order this quantity or a multiple thereof.

## 8WA1 Screw Terminals

### 8WA Insta or three-tier terminals

Version	DT	Article No. <a href="http://www.siemens.com/product?Article No.">www.siemens.com/ product?Article No.</a>	Price per PU	PU (UNIT, SET, M)	PS*/ P. unit	PG
<b>Accessories</b>						
<b>Covers</b> Up to three terminals side-by-side						
Versions						
<ul style="list-style-type: none"> <li>• With lightning symbol, for terminal size 4 and 6 mm<sup>2</sup></li> <li>• White, facility for labeling, for terminal sizes 4 and 6 mm<sup>2</sup></li> <li>• For connection bars, for terminal size 2.5 up to 6 mm<sup>2</sup> <ul style="list-style-type: none"> <li>- Transparent</li> <li>- White</li> </ul> </li> </ul>		<b>8WA1811</b> <b>8WA1862</b>  <b>8WA1822-7AX01</b> <b>8WA1822-7AX03</b>	1 1  1 1	50 units 50 units  10 units 10 units	1BT 1BT  1BT 1BT	
<b>Feeder terminals, for N-busbars</b> • 6 × 6 mm and 10 × 3 mm • Bare						
Versions						
<ul style="list-style-type: none"> <li>• Connection up to 4 mm<sup>2</sup></li> <li>• Connection up to 25 mm<sup>2</sup></li> <li>• Connection up to 35 mm<sup>2</sup></li> </ul>		<b>8WA2867</b> <b>8WA2868</b> <b>8WA2870</b>	1 1 1	50/2400 units 50/750 units 50 units	1BT 1BT 1BT	
 8WA2870 / 868 / 867						
<b>End retainers, thermoplastic</b> Width 10 mm						
 8WA1808						
<b>Terminal strip labels</b> • Suitable for 8WA1808 end retainer • Blank (WIN 67)						
 8WA1857						
<b>Insulation carriers, for mounting insulated support rails</b>						
 8WA1857						
<b>Labels, blank</b> • Suitable for plotting • Label size 5 × 7 mm (WIN 68)						
 8WA8348-2AY						
<b>N-busbars, 6 × 6 mm</b> • Rated uninterrupted current 125 A • 1109 mm long • For four-field						
Note Prices apply for orders from € 25.00. For orders below € 25.00, a processing charge of € 2.50 net will be added.						
 8GF9324-2						
<b>Connection bars, for Insta terminals</b>						
Versions						
<ul style="list-style-type: none"> <li>• For two terminals</li> <li>• For three terminals</li> <li>• For ten terminals</li> </ul>		<b>8WA1822-7VF02</b> <b>8WA1822-7VF03</b> <b>8WA1822-7VF10</b>	1 1 1	50 units 50 units 10 units	1BT 1BT 1BT	
<b>Barriers, for Insta terminals, terminal size 2.5 mm<sup>2</sup> and measuring transformer terminals, terminal size 6 mm<sup>2</sup></b>						
 8WA1822-7TH00						

## Overview

Two-tier terminals are a compact form of the terminal blocks. They are therefore open on one side. They can contain two connecting cables with two connections each or they can be laid out as terminal blocks with four connections on the same potential.

An advantage is the standardized front for mounting, bridging and labeling.

## Technical specifications

	Rated voltage	
	AC	DC
Between connection bars		
• With insulation plate	400 V	450 V
• With end plate or barrier	800 V	900 V
• With disconnecting link opened	500 V	600 V
For alternately bent soldering tags	400 V	450 V
For adjacent terminals with soldering tags and insulated plugs	250 V	300 V

## Selection and ordering data

Version	DT	Article No. <a href="http://www.siemens.com/product?Article No.">www.siemens.com/ product?Article No.</a>	Price per PU	PU (UNIT, SET, M)	PS*/ P. unit	PG
<b>General details</b>						
<ul style="list-style-type: none"> <li>Thermoplastic insulating body</li> <li>Screw terminal at both ends</li> </ul>						
Note	Section	Page				
For labeling accessories, see ...	Accessories	11/2				

### Terminal size 4 mm<sup>2</sup>

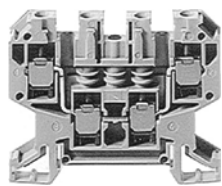

8WA1011-6DG11

#### Two-tier terminals, terminal size 4 mm<sup>2</sup>

- Rated uninterrupted current 32 A
- Rated insulation voltage 690 V (with end plate 800 V)
- Mounting width 6.5 mm
- Terminal height 45 mm
- Terminal length 64 mm
- AWG 18-10
- AWG 18-10

#### Versions

- Beige
  - 1-pole
  - 2-pole, with two isolated connections
- Blue
  - 1-pole
  - 2-pole, with two isolated connections

#### Accessories

Accessories	Section	Page
<b>Covers</b>		
• With lightning symbol, for terminal size 4 and 6 mm <sup>2</sup>	Accessories	9/20
• White, facility for labeling, for terminal sizes 4 and mm <sup>2</sup>	Accessories	9/20
• For connection bars, for terminal size 2.5 to 6 mm <sup>2</sup> , transparent	Accessories	9/20
<b>Jumpers</b>		
• For upper tier of 2-pole terminals	Accessories	9/20
• For lower tier of 1 and 2-pole terminals	Accessories	9/20
<b>End plates</b>	Accessories	9/20
<b>Disconnecting links</b>	Accessories	9/20
<b>Insulation plates</b>		
• For upper tier of 2-pole terminals	Accessories	9/20
• For lower tier of 1 and 2-pole terminals	Accessories	9/20
<b>Connection bars</b>		
• For upper tier of 2-pole terminals:		
- For two terminals	Accessories	9/20
- For three terminals	Accessories	9/20
- For four terminals	Accessories	9/20
- For ten terminals	Accessories	9/20
• For lower tier of 1 and 2-pole terminals:		
- For two terminals	Accessories	9/20
- For ten terminals	Accessories	9/20
<b>Barriers</b>	Accessories	9/20

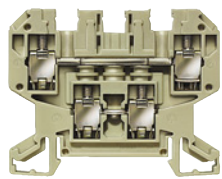







8WA1011-2DG11

<b>8WA1011-6DG11</b>	1	50/500 units	1BT
<b>8WA1011-2DG11</b>	1	50/500 units	1BT
<b>8WA1011-6BG11</b>	1	50 units	1BT
<b>8WA1011-2BG11</b>	1	50/500 units	1BT
<b>8WA1811</b>	1	50 units	1BT
<b>8WA1862</b>	1	50 units	1BT
<b>8WA1822-7AX01</b>	1	10 units	1BT
<b>8WA1822-7VG00</b>	1	50 units	1BT
<b>8WA1822-7VG01</b>	1	50 units	1BT
<b>8WA1817</b>	1	50 units	1BT
<b>8WA1865</b>	1	50 units	1BT
<b>8WA1825</b>	1	50 units	1BT
<b>8WA1825</b>	1	50 units	1BT
<b>8WA1850</b>	1	50 units	1BT
<b>8WA1851</b>	1	50 units	1BT
<b>8WA1852</b>	1	20 units	1BT
<b>8WA1853</b>	1	10/600 units	1BT
<b>8WA1835</b>	1	50 units	1BT
<b>8WA1838</b>	1	10 units	1BT
<b>8WA1823</b>	1	25/600 units	1BT

## 8WA1 Screw Terminals

## 8WA two-tier terminals

Version	DT	Article No. <a href="http://www.siemens.com/product?Article.No.">www.siemens.com/ product?Article.No.</a>	Price per PU	PU (UNIT, SET, M)	PS*/ P. unit	PG
<b>Accessories</b>						
<b>Covers</b>						
<b>Versions</b>						
 8WA1811		• With lightning symbol, for terminal size 4 and 6 mm <sup>2</sup>	<b>8WA1811</b>	1	50 units	1BT
 8WA1862		• White, facility for labeling, for terminal sizes 4 and 6 mm <sup>2</sup>	<b>8WA1862</b>	1	50 units	1BT
 8WA1822-7AX01		• For connection bars, for terminal size 2.5 to 6 mm <sup>2</sup> , transparent	<b>8WA1822-7AX01</b>	1	10 units	1BT
<b>Jumpers</b>						
• For connection bars • For terminal size 4 mm <sup>2</sup>						
<b>Versions</b>						
		• For upper tier of 2-pole terminals	<b>8WA1822-7VG00</b>	1	50 units	1BT
		• For lower tier of 1 and 2-pole terminals	<b>8WA1822-7VG01</b>	1	50 units	1BT
<b>End plates, for two-tier terminals</b>						
			<b>8WA1817</b>	1	50 units	1BT
<b>Disconnecting links</b>						
 8WA1865		For upper tier of 2-pole terminals	<b>8WA1865</b>	1	50 units	1BT
<b>Note</b>						
The terminals must be fitted with end plates and must be fitted with the end plates facing each other.						
<b>Insulation plates, for terminal size 2.5 to 6 mm<sup>2</sup></b>						
 8WA1825			<b>8WA1825</b>	1	50 units	1BT
<b>Connection bars</b>						
<b>Versions</b>						
		• For upper tier of 2-pole terminals	<b>8WA1850</b>	1	50 units	1BT
		- For two terminals	<b>8WA1851</b>	1	50 units	1BT
		- For three terminals	<b>8WA1852</b>	1	20 units	1BT
		- For four terminals	<b>8WA1853</b>	1	10/600 units	1BT
		- For ten terminals				
		• For lower tier of 1 and 2-pole terminals	<b>8WA1835</b>	1	50 units	1BT
		- For two terminals	<b>8WA1836</b>	1	10 units	1BT
		- For ten terminals				
<b>Barriers</b>						
 8WA1823			<b>8WA1823</b>	1	25/600 units	1BT



Design

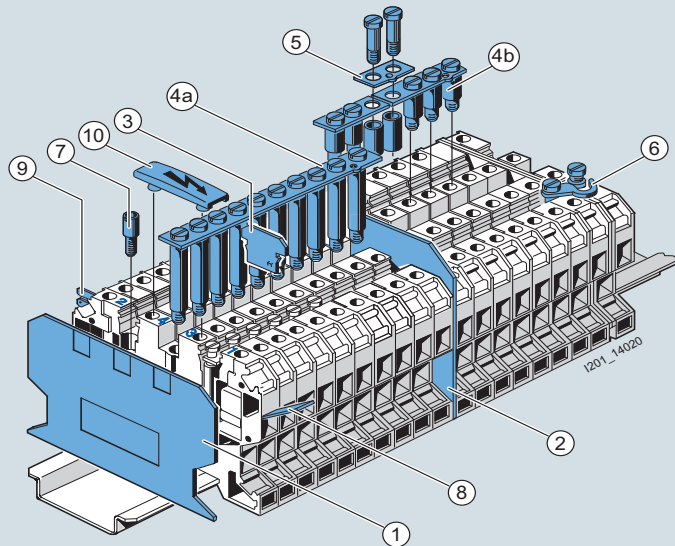

- ① End plate
- ② Barrier
- ③ Insulation plate
- ④a Link rail for lower tier
- ④b Link rail for upper tier
- ⑤ Link for link rail
- ⑥ Jumper
- ⑦ Test socket
- ⑧ Soldering tag
- ⑨ Flat connector, slotted
- ⑩ Cover with lightning symbol

Selection and ordering data

Version	DT	Article No. <a href="http://www.siemens.com/product?ArticleNo">www.siemens.com/ product?Article No.</a>	Price per PU	PU (UNIT, SET, M)	PS*/ P. unit	PG
---------	----	--	-----------------	-------------------------	-----------------	----

General details

- Thermoplastic insulating body
- Screw terminal at both ends
- Open on one side
- Beige

Note	Section	Page
For labeling accessories, see ...	Accessories	11/2

Terminal size 4 mm<sup>2</sup>

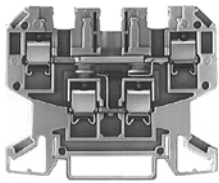

8WA1011-6EG20

Diode terminals, terminal size 4 mm<sup>2</sup>

- Rated insulation voltage 250 V
- Mounting width 6.5 mm
- Terminal height 45 mm
- Terminal length 64 mm
- **AWG 18-10**
- **Jumpers not supported**

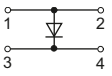
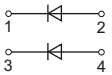
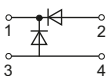
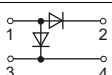

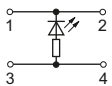
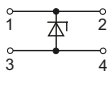

Type	Article No.	PU	PS*/ P. unit	PG						
 <ul style="list-style-type: none"> <li>• Rated uninterrupted current 32/1 A</li> </ul>	<b>8WA1011-6EG20</b>	1 10 units	1BT							
 <ul style="list-style-type: none"> <li>• Rated uninterrupted current 1 A</li> </ul>	<b>8WA1011-6EG22</b>	1 10 units	1BT							
 <ul style="list-style-type: none"> <li>• Rated uninterrupted current 32/1 A</li> </ul>	<b>8WA1011-6EG23</b>	1 10 units	1BT							
 <ul style="list-style-type: none"> <li>• Rated uninterrupted current 32/1 A</li> </ul>	<b>8WA1011-6EG24</b>	1 10 units	1BT							
<table border="1"> <thead> <tr> <th>Accessories</th> <th>Section</th> <th>Page</th> </tr> </thead> <tbody> <tr> <td>End plates, for two-tier terminals</td> <td>Accessories</td> <td>9/22</td> </tr> </tbody> </table>	Accessories	Section	Page	End plates, for two-tier terminals	Accessories	9/22	<b>8WA1817</b>	1 50 units	1BT	
Accessories	Section	Page								
End plates, for two-tier terminals	Accessories	9/22								

## 8WA1 Screw Terminals

### 8WA two-tier terminals with electronic components

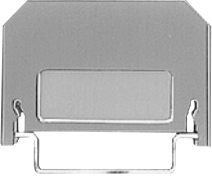
Version	DT	Article No. <a href="http://www.siemens.com/product?Article No.">www.siemens.com/ product?Article No.</a>	Price per PU	PU (UNIT, SET, M)	PS*/ P. unit	PG						
<b>Terminals with red LED, terminal size 4 mm<sup>2</sup></b> <ul style="list-style-type: none"> <li>Rated uninterrupted current 32 A</li> <li>Rated insulation voltage 24 V DC</li> <li>Mounting width 6.5 mm</li> <li>Terminal height 45 mm</li> <li>Terminal length 64 mm</li> <li>AWG 18-10</li> </ul>												
												
<b>Terminals with red LED, terminal size 4 mm<sup>2</sup></b> <ul style="list-style-type: none"> <li>Without diode for current limitation</li> </ul>		<b>8WA1011-6EG25</b>		1	10 units	1BT						
												
<b>Zener diode terminals, terminal size 4 mm<sup>2</sup></b> <ul style="list-style-type: none"> <li>Mounting width 6.5 mm</li> <li>Terminal height 45 mm</li> <li>Terminal length 64 mm</li> <li>AWG 18-10</li> <li>Let-through current 0.25 A</li> <li>Avalanche voltage <math>U_Z = 2.4 \text{ V}, \pm 5 \%</math></li> </ul>		<b>8WA1011-6EG44</b>		1	10 units	1BT						
<table border="1"> <thead> <tr> <th>Accessories</th> <th>Section</th> <th>Page</th> </tr> </thead> <tbody> <tr> <td><i>End plates, for two-tier terminals</i></td> <td><i>Accessories</i></td> <td><i>9/22</i></td> </tr> </tbody> </table>	Accessories	Section	Page	<i>End plates, for two-tier terminals</i>	<i>Accessories</i>	<i>9/22</i>						
Accessories	Section	Page										
<i>End plates, for two-tier terminals</i>	<i>Accessories</i>	<i>9/22</i>										
		<b>8WA1817</b>		1	50 units	1BT						
<b>Accessories</b>												
<b>End plates, for two-tier terminals</b>		<b>8WA1817</b>		1	50 units	1BT						



## Selection and ordering data

Version	DT	Article No. <a href="http://www.siemens.com/product?Article No.">www.siemens.com/ product?Article No.</a>	Price per PU	PU (UNIT, SET, M)	PS*/ P. unit	PG		
<b>General details</b> <ul style="list-style-type: none"> <li>Thermoplastic insulating body</li> <li>Enclosed at both ends</li> </ul>								
Note	Section	Page						
For labeling accessories, see ...	Accessories	11/2						
<b>Terminal size 2.5 mm<sup>2</sup></b>								
 <p>8WA1011-1EF20</p>  <p>8WA1011-1EF20</p>	<b>Diode terminals, terminal size 2.5 mm<sup>2</sup></b> <ul style="list-style-type: none"> <li>Rated insulation voltage 250 V U<sub>RRM</sub></li> <li>Mounting width 6 mm</li> <li>Terminal height 26 mm</li> <li>Terminal length 41 mm</li> <li>Screw terminals at both ends with test options for Ø 2.3 mm test plug</li> <li>Rated uninterrupted current 1 A</li> <li>Peak blocking voltage 1000 V</li> </ul>		<b>8WA1011-1EF20</b>		1	5 units	1BT	
Accessories	Section	Page						
Barriers, for terminal size 1.5 ... 4 mm <sup>2</sup>	Accessories	9/23						
 <p>8WA1501</p>  <p>8WA1501</p>		<b>Through-type terminals, terminal size 2.5 mm<sup>2</sup>, with sectionalizing feature</b> <ul style="list-style-type: none"> <li>Rated uninterrupted current 10 A</li> <li>Rated insulation voltage 380 V AC, 450 V DC (with alternate outgoing soldering tags) <ul style="list-style-type: none"> <li>Open isolating distance 380 V AC, 450 V DC</li> <li>For use of barriers up to 750 V AC, 900 V DC</li> </ul> </li> <li>Mounting width 6 mm</li> <li>Terminal height 29 mm</li> <li>Terminal length 41 mm</li> <li>With 2 holes for Ø 2.3 mm test plug</li> <li>With screw terminals at both ends</li> </ul>		<b>8WA1501</b>		1	10 units	1BT
Note	Through-type terminals with sectionalizing feature allow easy isolation of the current path without disconnection of conductors. The sockets of the terminal screws allow actions, such as the measuring of the loop resistance or connection of an ammeter to the circuit. The use of connection combs reduces the conductor cross-section by one level.							
Accessories	Section	Page						
Barriers, for terminal size 1.5 ... 4 mm <sup>2</sup>	Accessories	9/23						
<b>Accessories</b>								
 <p>8WA1820</p>	<b>Barriers, for terminal size 1.5 ... 4 mm<sup>2</sup></b>		<b>8WA1820</b>		1	50/1400 units	1BT	

## 8WA1 Screw Terminals

### 8WA terminals for components

#### Selection and ordering data

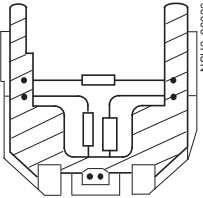
Version	DT	Article No. <a href="http://www.siemens.com/product?ArticleNo.">www.siemens.com/ product?Article No.</a>	Price per PU	PU (UNIT, SET, M)	PS*/ P. unit	PG
<b>General details</b> <ul style="list-style-type: none"> <li>• Terminals for components</li> <li>• Screw terminal at both ends for 2 conductors each</li> <li>• Plugs with PCB for components</li> <li>• Enclosed at both ends</li> </ul>						
Note		Section	Page			
For labeling accessories, see ...		Accessories	11/2			
<b>Terminal size 1.5 mm<sup>2</sup></b>						
 <p>8WA1011-1EE00</p>		<b>Terminals for components, terminal size 1.5 mm<sup>2</sup></b> (enclosure only) <ul style="list-style-type: none"> <li>• Rated uninterrupted current 6.3 A</li> <li>• Rated insulation voltage 500 V</li> <li>• Mounting width 10 mm</li> <li>• Terminal height 40 mm</li> <li>• Terminal length 57 mm</li> <li>• For self-fitting with components</li> <li>• To next terminal, determined internally through customer's components</li> </ul>		<b>8WA1011-1EE00</b>		1 5/50 units 1BT
 <p>8WA1822-7EE00</p>		<b>Plugs for components, terminal size 1.5 mm<sup>2</sup></b> <ul style="list-style-type: none"> <li>• Rated uninterrupted current 6.3 A</li> <li>• Rated insulation voltage 500 V</li> <li>• Mounting width 10 mm</li> <li>• Plug height 29 mm</li> <li>• Plug length 41 mm</li> <li>• With PCB and inscription label (20 × 9 mm)</li> </ul>		<b>8WA1822-7EE00</b>		1 1 unit 1BT
 <p>Plugs, fully equipped, example</p>						

#### Dimensional drawings

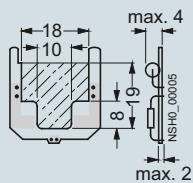

Space for components

## Overview

8WA1011-1SF12 fuse terminals are used to protect control circuits against short-circuits.

The fuse terminals are intended for 5 × 20 mm and 5 × 25 mm G fuse links up to 6.3 A and 250 V and for bridging links up to 16 A and 800 V and have a mounting for a replacement fuse link.

The fuse terminals are suitable for fuse links, sizes ¼" × 1", ¼" × 1¼" (6.3 × 32 mm) to 6.3 A and 250 V.

Fuse terminals are positive opening fuse-disconnectors.





The fuse links must be replaced at zero voltage. Finger safety is ensured in both closed and open positions.

The LED indicates the status of the disconnected fuse (residual current from 2 mA to 5 mA), but not if the plug is removed (floating).

The double connection is designed so that two conductors with different cross-sections can also be securely connected.

The fixing base of the G fuse terminal allows both centered and recessed mounting, allowing the unhindered routing of a 6 × 6 mm N-busbar. The G fuse terminal can therefore be joined into a single group with the other terminals of a branch.





## Selection and ordering data

Version	DT	Article No. <a href="http://www.siemens.com/product?Article No.">www.siemens.com/ product?Article No.</a>	Price per PU	PU (UNIT, SET, M)	PS*/ P. unit	PG																																																							
<b>General details</b> <ul style="list-style-type: none"> <li>• With thermoplastic insulating body</li> <li>• Screw terminal at both ends for 2 conductors each</li> <li>• Enclosed at both ends</li> </ul> <table border="1"> <thead> <tr> <th>Note</th> <th>Section</th> <th>Page</th> </tr> </thead> <tbody> <tr> <td>For labeling accessories, see ...</td> <td>Accessories</td> <td>11/2</td> </tr> </tbody> </table>							Note	Section	Page	For labeling accessories, see ...	Accessories	11/2																																																	
Note	Section	Page																																																											
For labeling accessories, see ...	Accessories	11/2																																																											
<b>Terminal size 1.5 mm<sup>2</sup></b> <div style="display: flex; align-items: flex-start;"> <div style="flex: 1;">  <p>8WA1011-1SF12</p>  <p>8WA1011-1SF13</p> </div> <div style="flex: 2;"> <p><b>Fuse terminals, terminal size 1.5 mm<sup>2</sup></b></p> <ul style="list-style-type: none"> <li>• Rated uninterrupted current 6.3 A when using fuses</li> <li>• Rated uninterrupted current 16 A when using the bridging link</li> <li>• Rated uninterrupted voltage 250 V when using fuses</li> <li>• Rated insulation voltage 800 V when using the bridging link</li> <li>• Mounting width 10 mm</li> <li>• Terminal height 42 mm</li> <li>• Terminal length 57 mm</li> <li>• Open isolating distance 500 V</li> <li>• AWG 18-14</li> <li>• @ AWG 18-14</li> </ul> <table border="1"> <thead> <tr> <th>Versions</th> <th>Price per PU</th> <th>PU</th> <th>PS*/P. unit</th> <th>PG</th> </tr> </thead> <tbody> <tr> <td>8WA1011-1SF12</td> <td></td> <td>1</td> <td>10/280 units</td> <td>1BT</td> </tr> <tr> <td>8WA1011-1SF13</td> <td></td> <td>1</td> <td>10/280 units</td> <td>1BT</td> </tr> <tr> <td>8WA1011-1SF15</td> <td></td> <td>1</td> <td>10/280 units</td> <td>1BT</td> </tr> <tr> <td>8WA1011-1SF30</td> <td></td> <td>1</td> <td>10/240 units</td> <td>1BT</td> </tr> <tr> <td>8WA1011-1SF31</td> <td></td> <td>1</td> <td>10/240 units</td> <td>1BT</td> </tr> <tr> <td>8WA1011-1SF32</td> <td></td> <td>1</td> <td>10 units</td> <td>1BT</td> </tr> </tbody> </table> </div> </div>							Versions	Price per PU	PU	PS*/P. unit	PG	8WA1011-1SF12		1	10/280 units	1BT	8WA1011-1SF13		1	10/280 units	1BT	8WA1011-1SF15		1	10/280 units	1BT	8WA1011-1SF30		1	10/240 units	1BT	8WA1011-1SF31		1	10/240 units	1BT	8WA1011-1SF32		1	10 units	1BT																				
Versions	Price per PU	PU	PS*/P. unit	PG																																																									
8WA1011-1SF12		1	10/280 units	1BT																																																									
8WA1011-1SF13		1	10/280 units	1BT																																																									
8WA1011-1SF15		1	10/280 units	1BT																																																									
8WA1011-1SF30		1	10/240 units	1BT																																																									
8WA1011-1SF31		1	10/240 units	1BT																																																									
8WA1011-1SF32		1	10 units	1BT																																																									
<b>Accessories</b> <div style="display: flex; align-items: flex-start;"> <div style="flex: 1;">  <p>8WA1822-7EF16</p> </div> <div style="flex: 2;"> <p><b>G fuse links</b> DIN 41660</p> <table border="1"> <thead> <tr> <th>Versions</th> <th>Price per PU</th> <th>PU</th> <th>PS*/P. unit</th> <th>PG</th> </tr> </thead> <tbody> <tr> <td>8WA1822-7EF16</td> <td></td> <td>1</td> <td>10/200 units</td> <td>1BT</td> </tr> <tr> <td>8WA1822-7EF18</td> <td></td> <td>1</td> <td>10 units</td> <td>1BT</td> </tr> <tr> <td>8WA1822-7EF21</td> <td></td> <td>1</td> <td>10 units</td> <td>1BT</td> </tr> <tr> <td>8WA1822-7EF23</td> <td></td> <td>1</td> <td>10 units</td> <td>1BT</td> </tr> <tr> <td>8WA1822-7EF25</td> <td></td> <td>1</td> <td>10 units</td> <td>1BT</td> </tr> <tr> <td>8WA1822-7EF76</td> <td></td> <td>1</td> <td>10 units</td> <td>1BT</td> </tr> <tr> <td>8WA1822-7EF78</td> <td></td> <td>1</td> <td>10 units</td> <td>1BT</td> </tr> <tr> <td>8WA1822-7EF81</td> <td></td> <td>1</td> <td>10 units</td> <td>1BT</td> </tr> <tr> <td>8WA1822-7EF83</td> <td></td> <td>1</td> <td>10 units</td> <td>1BT</td> </tr> <tr> <td>8WA1822-7EF85</td> <td></td> <td>1</td> <td>10 units</td> <td>1BT</td> </tr> </tbody> </table> </div> </div>							Versions	Price per PU	PU	PS*/P. unit	PG	8WA1822-7EF16		1	10/200 units	1BT	8WA1822-7EF18		1	10 units	1BT	8WA1822-7EF21		1	10 units	1BT	8WA1822-7EF23		1	10 units	1BT	8WA1822-7EF25		1	10 units	1BT	8WA1822-7EF76		1	10 units	1BT	8WA1822-7EF78		1	10 units	1BT	8WA1822-7EF81		1	10 units	1BT	8WA1822-7EF83		1	10 units	1BT	8WA1822-7EF85		1	10 units	1BT
Versions	Price per PU	PU	PS*/P. unit	PG																																																									
8WA1822-7EF16		1	10/200 units	1BT																																																									
8WA1822-7EF18		1	10 units	1BT																																																									
8WA1822-7EF21		1	10 units	1BT																																																									
8WA1822-7EF23		1	10 units	1BT																																																									
8WA1822-7EF25		1	10 units	1BT																																																									
8WA1822-7EF76		1	10 units	1BT																																																									
8WA1822-7EF78		1	10 units	1BT																																																									
8WA1822-7EF81		1	10 units	1BT																																																									
8WA1822-7EF83		1	10 units	1BT																																																									
8WA1822-7EF85		1	10 units	1BT																																																									
<div style="display: flex; align-items: flex-start;"> <div style="flex: 1;">  <p>8WA1891</p> </div> <div style="flex: 2;"> <p><b>Bridging links</b> 5 × 25 mm</p> <table border="1"> <tbody> <tr> <td>8WA1891</td> <td></td> <td>1</td> <td>10 units</td> <td>1BT</td> </tr> </tbody> </table> </div> </div>							8WA1891		1	10 units	1BT																																																		
8WA1891		1	10 units	1BT																																																									

## 8WA1 Screw Terminals

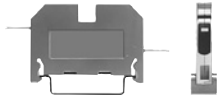
### 8WA through-type terminals with soldered and plug-in connection

#### Selection and ordering data

Version	DT	Article No. <a href="http://www.siemens.com/product?Article No.">www.siemens.com/ product?Article No.</a>	Price per PU	PU (UNIT, SET, M)	PS*/ P. unit	PG												
<b>General details</b> <ul style="list-style-type: none"> <li>With thermoplastic insulating body</li> <li>Enclosed at both ends</li> </ul> <table border="1"> <thead> <tr> <th>Note</th> <th>Section</th> <th>Page</th> </tr> </thead> <tbody> <tr> <td>For labeling accessories, see ...</td> <td>Accessories</td> <td>11/2</td> </tr> </tbody> </table>							Note	Section	Page	For labeling accessories, see ...	Accessories	11/2						
Note	Section	Page																
For labeling accessories, see ...	Accessories	11/2																
<b>Terminal size 1.5 mm<sup>2</sup></b>																		
 8WA1221		<b>Through-type terminals, terminal size 1.5 mm<sup>2</sup></b> <ul style="list-style-type: none"> <li>Beige</li> <li>Rated uninterrupted current 18 A</li> <li>Rated insulation voltage 380 V AC, 450 V DC with alternately arranged terminals; when using barriers up to 800 V</li> <li>Mounting width 5.5 mm</li> <li>Terminal height 26 mm</li> <li>Terminal length 41 mm</li> <li>Soldered connection at both ends</li> </ul> <table border="1"> <thead> <tr> <th>Accessories</th> <th>Section</th> <th>Page</th> </tr> </thead> <tbody> <tr> <td> <ul style="list-style-type: none"> <li>Covers</li> <li>- With lightning symbol</li> <li>- White, facility for labeling</li> <li>- Barriers, for terminal size 1.5 ... 4 mm<sup>2</sup></li> </ul> </td> <td>Accessories</td> <td>9/26</td> </tr> <tr> <td></td> <td>Accessories</td> <td>9/26</td> </tr> <tr> <td></td> <td>Accessories</td> <td>9/26</td> </tr> </tbody> </table>	Accessories	Section	Page	<ul style="list-style-type: none"> <li>Covers</li> <li>- With lightning symbol</li> <li>- White, facility for labeling</li> <li>- Barriers, for terminal size 1.5 ... 4 mm<sup>2</sup></li> </ul>	Accessories	9/26		Accessories	9/26		Accessories	9/26		1	50 units	1BT
Accessories	Section	Page																
<ul style="list-style-type: none"> <li>Covers</li> <li>- With lightning symbol</li> <li>- White, facility for labeling</li> <li>- Barriers, for terminal size 1.5 ... 4 mm<sup>2</sup></li> </ul>	Accessories	9/26																
	Accessories	9/26																
	Accessories	9/26																
<b>Accessories</b>																		
 8WA1811		<b>Covers</b> <table border="1"> <thead> <tr> <th>Versions</th> </tr> </thead> <tbody> <tr> <td> <ul style="list-style-type: none"> <li>With lightning symbol</li> <li>- For terminal size 1 ... 2.5 mm<sup>2</sup></li> <li>- For terminal size 6 mm<sup>2</sup></li> <li>White, facility for labeling</li> <li>- For terminal size 1 ... 2.5 mm<sup>2</sup></li> <li>- For terminal size 6 mm<sup>2</sup></li> </ul> </td> </tr> </tbody> </table>	Versions	<ul style="list-style-type: none"> <li>With lightning symbol</li> <li>- For terminal size 1 ... 2.5 mm<sup>2</sup></li> <li>- For terminal size 6 mm<sup>2</sup></li> <li>White, facility for labeling</li> <li>- For terminal size 1 ... 2.5 mm<sup>2</sup></li> <li>- For terminal size 6 mm<sup>2</sup></li> </ul>		1	50 units	1BT										
Versions																		
<ul style="list-style-type: none"> <li>With lightning symbol</li> <li>- For terminal size 1 ... 2.5 mm<sup>2</sup></li> <li>- For terminal size 6 mm<sup>2</sup></li> <li>White, facility for labeling</li> <li>- For terminal size 1 ... 2.5 mm<sup>2</sup></li> <li>- For terminal size 6 mm<sup>2</sup></li> </ul>																		
		<b>8WA1810</b> <b>8WA1811</b>		1	50 units	1BT												
		<b>8WA1860</b> <b>8WA1862</b>		1	50 units	1BT												
				1	50/1400 units	1BT												
 8WA1822-7VH12		<b>Connection bars, for through-type terminal, terminal size 6 mm<sup>2</sup>, with plug-in connection</b> <table border="1"> <thead> <tr> <th>Versions</th> </tr> </thead> <tbody> <tr> <td> <ul style="list-style-type: none"> <li>For two terminals</li> <li>For ten terminals</li> </ul> </td> </tr> </tbody> </table>	Versions	<ul style="list-style-type: none"> <li>For two terminals</li> <li>For ten terminals</li> </ul>		1	50 units	1BT										
Versions																		
<ul style="list-style-type: none"> <li>For two terminals</li> <li>For ten terminals</li> </ul>																		
		<b>8WA1822-7VH12</b> <b>8WA1822-7VH20</b>		1	10 units	1BT												
 8WA1821		<b>Barriers</b> <table border="1"> <thead> <tr> <th>Versions</th> </tr> </thead> <tbody> <tr> <td> <ul style="list-style-type: none"> <li>For terminal size 1.5 ... 4 mm<sup>2</sup></li> <li>For terminal size 6 ... 16 mm<sup>2</sup></li> </ul> </td> </tr> </tbody> </table>	Versions	<ul style="list-style-type: none"> <li>For terminal size 1.5 ... 4 mm<sup>2</sup></li> <li>For terminal size 6 ... 16 mm<sup>2</sup></li> </ul>		1	50/1400 units	1BT										
Versions																		
<ul style="list-style-type: none"> <li>For terminal size 1.5 ... 4 mm<sup>2</sup></li> <li>For terminal size 6 ... 16 mm<sup>2</sup></li> </ul>																		
		<b>8WA1820</b> <b>8WA1821</b>		1	50/1050 units	1BT												

## Overview

Measuring transformer terminals can be used for testing and isolating circuits in switchboards, control rooms, etc. without interrupting operation.

The isolating and instrument isolating terminals contain an isolating device in the through-type connection. The isolating device permits electrical separation between the input and output of a terminal.

Test sockets for plugs with a diameter of 4 mm can be screwed into the front side of the through-type and isolating terminals. The rated insulation voltage between colored test sockets is 125 V. The rated insulation voltage between test sockets and connection bars not connected to the terminal is 16 V (circuit 3, terminals 3 and 5).

Two adjacent terminals can be connected in parallel with the disconnecting link. The disconnecting link can be operated in any position of the isolating device.

### Instrument set for one transformer

The instrument set for one transformer makes the basic circuit of the transformer terminal blocks clear. This basic circuit is also included in much larger instrument sets, which is extended by adding on equivalent circuits. Links between the basic circuits provide many kinds of testing facilities, parallel outgoing lines to other measuring devices, connection of test equipment, etc.

### Instrument set for three transformers

The simplest version of an instrument set for a three-phase circuit consists of three basic circuits strung together without any continuing links or extensions. Instead of isolating terminals 1, 3 and 5, less expensive through-type terminals can also be used.

On the other hand, it is also possible to use instrument isolating terminals for this purpose so that the terminal versions are all the same.

### Instrument set for three transformers with neutral point

The instrument set with a neutral point is an extension of the previous circuit. Four instead of six lines are sufficient for connecting it with the measuring devices. The neutral point is produced on the measuring instruments on the one hand, and using a shortened 8WA1822-7VH10 connection bar on the other. The instrument isolating terminal 1 is connected to the neutral point using a connecting comb.

### Note

The introduction of the 8WA1011-1MH10 through-type terminals and their associated disconnecting links has made it considerably easier to configure terminal sets for current transformers. Instead of the 12 isolating or instrument isolating terminals used previously, now only 4 instrument isolating terminals and 3 through-type terminals are required.

### Instrument set with test facility

This instrument set represents a significant enhancement over previous types. In normal operation, terminals 2, 5 and 8 are closed. For testing a measuring instrument (e.g. a plotter), these terminals are opened and terminals 3, 6 and 9 are closed in order to feed in a test signal. The transformers first have to be short-circuited with the disconnecting links between terminals 1-2, 4-5 and 7-8. Wire jumpers connect terminals 1, 4 and 7 with the neutral point. It is formed in terminals 10, 11, 12 and 13 with an 8WA1887 connection bar.

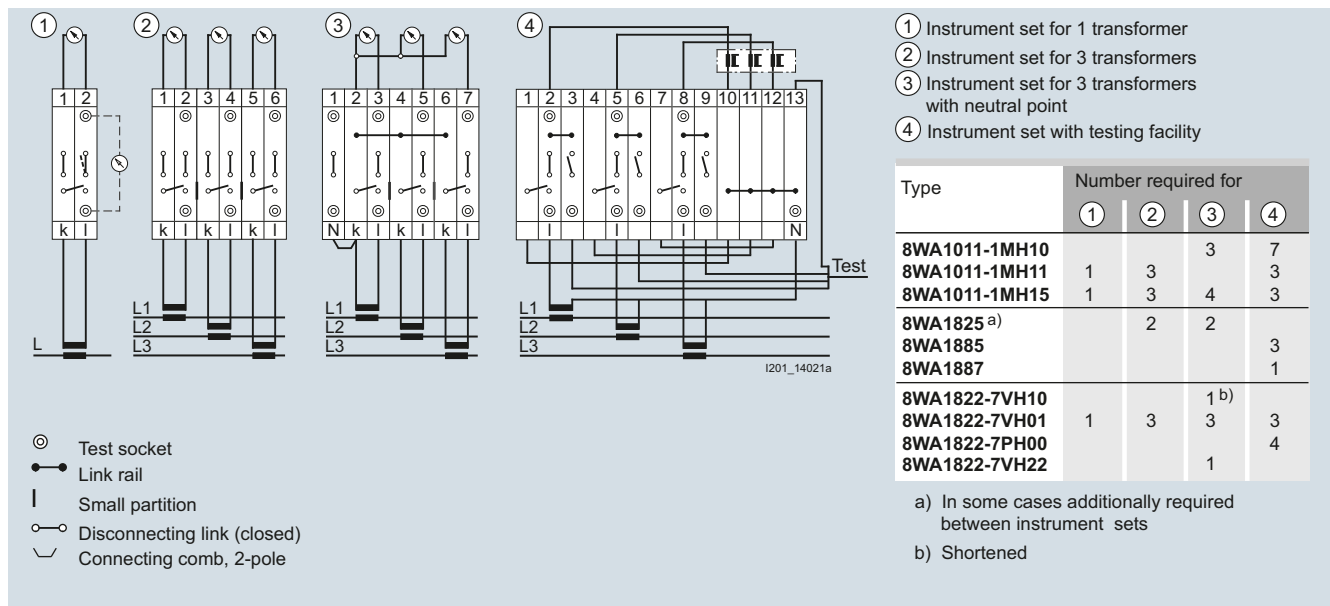



Connection option for measuring transformer terminals (instrument sets)

# 8WA1 Screw Terminals

## 8WA measuring transformer terminals

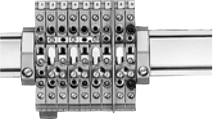
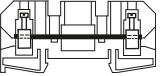
### Selection and ordering data

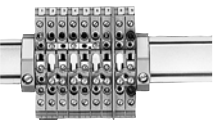
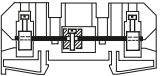
Version	DT	Article No. <a href="http://www.siemens.com/product?Article No.">www.siemens.com/ product?Article No.</a>	Price per PU	PU (UNIT, SET, M)	PS*/ P. unit	PG	
<b>General details</b> <ul style="list-style-type: none"> <li>With thermoplastic insulating body</li> <li>Screw terminals at both ends and two holes for test sockets for Ø 4 mm test plug, insulated at both ends</li> <li>Enclosed at both ends</li> </ul>							
Note		Section	Page				
For labeling accessories, see ...		Accessories	11/2				
<b>Terminal size 6 mm<sup>2</sup></b>							
 <p>8WA1011-1MH10</p>		<b>Through-type terminals, terminal size 6 mm<sup>2</sup></b> <ul style="list-style-type: none"> <li>Rated uninterrupted current 41 A</li> <li>Rated insulation voltage 500 V</li> <li>Mounting width 8 mm</li> <li>Terminal height 33 mm</li> <li>Terminal length 83 mm</li> <li>Without test sockets</li> <li>AWG 14-8</li> <li>AWG 16-10</li> </ul>		8WA1011-1MH10	1	20 units	1BT
 <p>Typical circuit diagram</p>		<b>Accessories</b>					
		Covers, for connection bars					
		• Transparent	Accessories	9/29	8WA1822-7AX01	1	10 units 1BT
		Test sockets					
		• Rated voltage between test socket and bypassed connection bar: 16 V, recessed	Accessories	9/29	8WA1822-7PH00	1	50 units 1BT
 <p>NSH0_00026</p>		Insulation plates, for terminal size 2.5 to 6 mm <sup>2</sup>	Accessories	9/29	8WA1825	1	50 units 1BT
		Connection combs					
		• 10-pole for measuring transformer terminals, can be shortened as required	Accessories	9/29	8WA7163	1	10 units 1BT
		• 2-pole	Accessories	9/29	8WA1822-7VH22	1	10 units 1BT
		Connection bars, for terminal size 6 mm <sup>2</sup>					
		• Two terminals	Accessories	9/29	8WA1885	1	50 units 1BT
		• Three terminals	Accessories	9/29	8WA1886	1	50 units 1BT
		• Four terminals	Accessories	9/29	8WA1887	1	20 units 1BT
		• Ten terminals	Accessories	9/29	8WA1888	1	10/780 units 1BT
		• Unmounted for ten terminals	Accessories	9/29	8WA1822-7VH10	1	50 units 1BT
		Barriers, for Insta terminals, terminal size 2.5 mm <sup>2</sup> and measuring transformer terminals, terminal size 6 mm <sup>2</sup>	Accessories	9/29	8WA1822-7TH00	1	50 units 1BT
 <p>8WA1011-1MH11</p>		<b>Isolating terminals, terminal size 6 mm<sup>2</sup></b> <ul style="list-style-type: none"> <li>Rated uninterrupted current 41 A</li> <li>Rated insulation voltage 500 V</li> <li>Mounting width 8 mm</li> <li>Terminal height 33 mm</li> <li>Terminal length 83 mm</li> <li>Without test sockets</li> <li>AWG 14-8</li> <li>AWG 16-10</li> </ul>		8WA1011-1MH11	1	20 units	1BT
 <p>Typical circuit diagram</p>		<b>Accessories</b>					
		Covers, for connection bars					
		• Transparent	Accessories	9/29	8WA1822-7AX01	1	10 units 1BT
		• White, facility for labeling	Accessories	9/29	8WA1822-7AX03	1	10 units 1BT
		Test sockets					
		• Rated voltage between test socket and bypassed connection bar: 16 V, recessed	Accessories	9/29	8WA1822-7PH00	1	50 units 1BT
 <p>NSH0_00027</p>		Insulation plates, for terminal size 2.5 to 6 mm <sup>2</sup>	Accessories	9/29	8WA1825	1	50 units 1BT
		Connection combs					
		• 10-pole for measuring transformer terminals, can be shortened as required	Accessories	9/29	8WA7163	1	10 units 1BT
		• 2-pole	Accessories	9/29	8WA1822-7VH22	1	10 units 1BT
		Connection bars, for terminal size 6 mm <sup>2</sup>					
		• Two terminals	Accessories	9/29	8WA1885	1	50 units 1BT
		• Three terminals	Accessories	9/29	8WA1886	1	50 units 1BT
		• Four terminals	Accessories	9/29	8WA1887	1	20 units 1BT
		• Ten terminals	Accessories	9/29	8WA1888	1	10/780 units 1BT
		• Unmounted for ten terminals	Accessories	9/29	8WA1822-7VH10	1	50 units 1BT
		Barriers, for Insta terminals, terminal size 2.5 mm <sup>2</sup> and measuring transformer terminals, terminal size 6 mm <sup>2</sup>	Accessories	9/29	8WA1822-7TH00	1	50 units 1BT





## 8WA1 Screw Terminals

### Notes

## 8WA2 Spring-Loaded Terminals

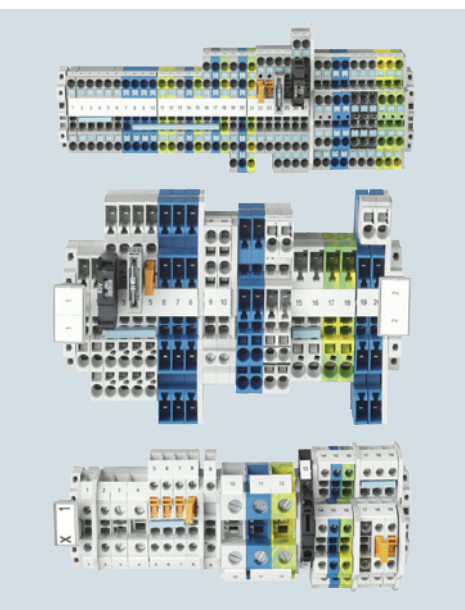

10/2

8WA initiator/actuator terminals

10

### For further technical product information:

Siemens Industry Online Support:  
[www.siemens.com/lowvoltage/product-support](http://www.siemens.com/lowvoltage/product-support)

- Application example
- Certificate
- Characteristic
- Download
- FAQ
- Manual
- Product note
- Software archive
- Technical data



## Technical specifications

### Continuous load at increased ambient temperatures

8WA2 terminal blocks can be loaded with their full uninterrupted current at ambient temperatures of up to +55 °C. At higher ambient temperatures, a current reduction according to the following formula is required:

$$I_{th2} = I_{th} \times k$$

$I_{th}$  = Uninterrupted current according to selection tables, relative to the nominal cross-section

$I_{th2}$  = Uninterrupted current at increased ambient temperature

$k$  = Derating factor according to table

Ambient temperature	Derating factor $k$
60 °C	0.94
65 °C	0.88
70 °C	0.82
75 °C	0.75
80 °C	0.67
85 °C	0.58
90 °C	0.47
95 °C	0.33

The maximum permissible clamping point overtemperature of 45 K according to IEC 60947-7-1 and EN 60947-7-1, Part 1, is not exceeded at ambient temperatures up to 100 °C.

### Clamping points

Terminal size	Type	Thread diameter of terminal screws	Screwdriver blades acc. to DIN 5264 8WA2803 or 8WA2804	Tightening torque = test torque	Tensile forces acc. to IEC 60947-1 at max. conductor connection	Stripped length
mm <sup>2</sup>				Nm	N	mm
1.5	8WA2011-3KE	--	0.5 × 3.5	--	40	8 ... 9

### Single-conductor connection

Terminal size	Type	Smallest conductor cross-section					Largest conductor cross-section				
		Solid	Stranded	Finely stranded	Finely stranded with end sleeve		Solid	Stranded	Finely stranded	Finely stranded with end sleeve	
mm <sup>2</sup>		mm <sup>2</sup>	mm <sup>2</sup>	mm <sup>2</sup>	mm <sup>2</sup>	Size	mm <sup>2</sup>	mm <sup>2</sup>	mm <sup>2</sup>	mm <sup>2</sup>	Size
1.5	8WA2011-3KE . .	0.08	0.5	0.2	--	--	1.5	1.5	1.5	--	--



### UL and IEC rating

Terminal size	Type	CSA rating			UR rating		
		AWG	Rated current $I_n$	Rated voltage $U_e$	AWG	Rated current $I_n$	Rated voltage $U_e$
mm <sup>2</sup>			A	V		A	V
1.5	8WA2011-3KE	28 ... 16	10	65	22 ... 16	10	65

# 8WA2 Spring-Loaded Terminals

## 8WA initiator/actuator terminals

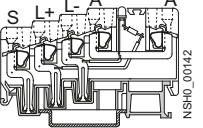
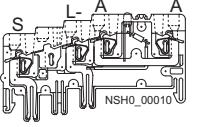
### Selection and ordering data

Version	DT	Article No. <a href="http://www.siemens.com/product?Article No.">www.siemens.com/ product?Article No.</a>	Price per PU	PU (UNIT, SET, M)	PS*/ P. unit	PG
<b>General details</b> <ul style="list-style-type: none"> <li>Thermoplastic insulating body</li> <li>Front connection with spring-loaded terminal</li> <li>L+ = brown S (shield) = green</li> <li>L- = blue A (output), connection not colored</li> <li>Enclosed at both ends</li> </ul>						
Note		Section	Page			
For labeling accessories, see ...		8WA accessories	11/2			
<b>Terminal size 1.5 mm<sup>2</sup></b>						
						
<b>8WA2011-3KE00</b> <b>Feeder terminals, terminal size 1.5 mm<sup>2</sup></b> <ul style="list-style-type: none"> <li>Orange</li> <li>Rated uninterrupted current 10 A</li> <li>Rated insulation voltage 65 V</li> <li>Mounting width 5 mm</li> <li>For 250 V, pollution degree 2</li> </ul>						
<b>Versions</b>						
<ul style="list-style-type: none"> <li>PNP <ul style="list-style-type: none"> <li>L+, L-, S, without LED</li> <li>L+, L-, without LED</li> <li>L+, L-, S, with green LED, 15 ... 30 V</li> </ul> </li> <li>NPN <ul style="list-style-type: none"> <li>L+, L-, S, without LED</li> <li>L+, L-, without LED, without ground connection</li> </ul> </li> </ul>		<b>8WA2011-3KE00</b> <b>8WA2011-3KE01</b> <b>8WA2011-3KE02</b>		1 20 units 1BT 1 20 units 1BT 1 20 units 1BT		
<b>8WA2011-3KE00</b> <b>8WA2011-3KE01</b>				1 20 units 1BT 1 20 units 1BT		
						
<b>8WA2011-3KE13</b> <b>initiator terminals</b> with connection module						
<b>Initiator terminals, terminal size 1.5 mm<sup>2</sup></b> <ul style="list-style-type: none"> <li>Light gray</li> <li>Rated uninterrupted current 10 A</li> <li>Rated insulation voltage 65 V</li> <li>Mounting width 5 mm</li> <li>For 250 V, pollution degree 2</li> <li>Current consumption with LED 4.8 mA</li> <li>PNP</li> </ul>						
<b>Versions</b>						
<ul style="list-style-type: none"> <li>L+, L-, A, without LED</li> <li>L+, L-, S, A, without LED</li> <li>L+, L-, A, with yellow LED, 15 ... 30 V</li> <li>L+, L-, S, A, with yellow LED, 15 ... 30 V</li> </ul>		<b>8WA2011-3KE10</b> <b>8WA2011-3KE11</b> <b>8WA2011-3KE12</b> <b>8WA2011-3KE13</b>		1 20/400 1BT 1 20/400 1BT 1 20/400 1BT 1 20/400 1BT		
<b>8WA2011-3KE10</b> <b>8WA2011-3KE11</b> <b>8WA2011-3KE12</b> <b>8WA2011-3KE13</b>				1 20/400 1BT 1 20/400 1BT 1 20/400 1BT 1 20/400 1BT		
						
<b>8WA2011-3KE33</b> <b>actuator terminals</b> with LED						
<b>Actuator terminals, terminal size 1.5 mm<sup>2</sup></b> <ul style="list-style-type: none"> <li>Light gray</li> <li>Rated uninterrupted current 10 A</li> <li>Rated insulation voltage 65 V</li> <li>Mounting width 5 mm</li> <li>For 250 V, pollution degree 2</li> <li>Current consumption with LED 4.8 mA</li> </ul>						
<b>Versions</b>						
<ul style="list-style-type: none"> <li>PNP <ul style="list-style-type: none"> <li>L-, S, A, without LED</li> <li>L-, S, A, with yellow LED, 15 ... 30 V</li> </ul> </li> <li>NPN <ul style="list-style-type: none"> <li>L+, S, A, without LED</li> </ul> </li> </ul>		<b>8WA2011-3KE31</b> <b>8WA2011-3KE33</b> <b>8WA2011-3KE30</b>		1 20 units 1BT 1 20 units 1BT 1 20 units 1BT		
<b>8WA2011-3KE31</b> <b>8WA2011-3KE33</b> <b>8WA2011-3KE30</b>				1 20 units 1BT 1 20 units 1BT 1 20 units 1BT		
						
<b>8WA2011-3KE50</b> <b>Connection modules, terminal size 1.5 mm<sup>2</sup>, for all PNP and NPN terminals</b> <ul style="list-style-type: none"> <li>Black</li> <li>Rated uninterrupted current 10 A</li> <li>Rated insulation voltage 65 V</li> <li>Mounting width 5 mm</li> <li>For 250 V, pollution degree 2</li> <li>L+, L-, S integrated</li> </ul>						
<b>Versions</b>						
<ul style="list-style-type: none"> <li>For 8 initiator/actuator terminals and one feeder terminal <ul style="list-style-type: none"> <li>Width 47 mm</li> <li>Height 65 mm</li> </ul> </li> <li>For 16 initiator/actuator terminals, one feeder terminal and space for one terminal for further bridging for subsequent module <ul style="list-style-type: none"> <li>Width 93 mm</li> <li>Height 65 mm</li> </ul> </li> </ul>		<b>8WA2011-3KE50</b> <b>8WA2011-3KE51</b>		1 10 units 1BT 1 5 units 1BT		
<b>8WA2011-3KE50</b> <b>8WA2011-3KE51</b>				1 10 units 1BT 1 5 units 1BT		

## Accessories for 8WA Terminal Blocks

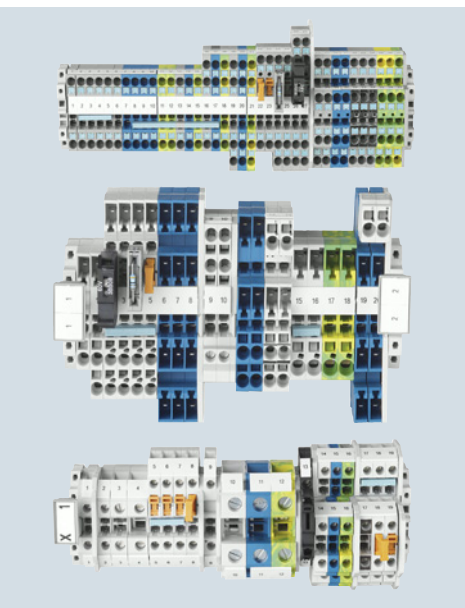

11/2 **Accessories for the labeling system**

11/3 **Standard labeling system**

11/5 **Mounting accessories**

### **For further technical product information:**

Siemens Industry Online Support:  
[www.siemens.com/lowvoltage/product-support](http://www.siemens.com/lowvoltage/product-support)

- Application example
- Certificate
- Characteristic
- Download
- FAQ
- Manual
- Product note
- Software archive
- Technical data

## Accessories for 8WA Terminal Blocks

### Accessories for the labeling system

#### Selection and ordering data

##### Labeling system for individual inscription

Labeling systems for

- Terminal blocks
- Modular installation devices
- Circuit breakers
- Switch disconnectors

Available from:

Murrplastik Systemtechnik GmbH  
Postfach 1143  
D-71570 Oppenweiler  
Telephone: +49 (0)7191-482-0  
e-mail: info@murrplastik.de

##### Accessories for the labeling system

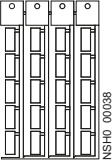
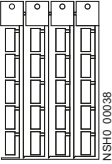
Version	DT	Article No. <a href="http://www.siemens.com/product?Article No.">www.siemens.com/ product?Article No.</a>	Price per PU	PU (UNIT, SET, M)	PS*/ P. unit	PG
<b>Terminal block labels, for labeling system</b> Versions <ul style="list-style-type: none"> <li>• For 8WA1 and 8WA2, individually removable</li> <li>- 5 x 7, white (WIN 68)</li> <li>- 5 x 10, white (WIN 68)</li> </ul> Not for two-tier terminals (bottom tier); flat terminals: 8WA1010-1PQ00, 8WA1808		<b>8WA8850-2AY</b> <b>8WA8851-2AY</b>		100	1020 units	1BT
 <b>Snap-on device labels</b> <i>NEW</i> For identification of e.g. <ul style="list-style-type: none"> <li>• Circuit breakers</li> <li>• Contactors</li> <li>• Controllers</li> </ul> Versions <ul style="list-style-type: none"> <li>• 20 x 7, white, snap-on hooks at side (WIN 95)</li> <li>• 20 x 7, turquoise, snap-on hooks at side (WIN 95)</li> </ul>		<b>8WH8210-0AA55</b> <b>8WH8210-0AA56</b>		100	340 units	1BT
 <b>Adhesive device labels</b> <i>NEW</i> For identification of e.g. <ul style="list-style-type: none"> <li>• Modular installation devices</li> <li>• Switch disconnectors</li> </ul> Versions <ul style="list-style-type: none"> <li>• 15 x 6 mm, white (WIN 098)</li> <li>• 15 x 6 mm, yellow (WIN 099)</li> <li>• 19 x 8 mm, white (WIN 088)</li> <li>• 19 x 8 mm, yellow (WIN 082)</li> </ul>		<b>8WH8210-0AA35</b> <b>8WH8210-0AA36</b> <b>8WH8210-0AA45</b> <b>8WH8210-0AA46</b>		100	3740 units	1BT

#### Note:

The labels can be written by hand or using Murrplastik labeling systems.

The WIN designation simplifies the assignment in the labeling software.





## Selection and ordering data

Version	DT	Article No. <a href="http://www.siemens.com/product?Article No.">www.siemens.com/ product?Article No.</a>	Price per PU	PU (UNIT, SET, M)	PS*/ P. unit	PG
<b>Labels, blank</b>						
• Suitable for plotting						
Versions						
• Label size 5 × 7 mm (WIN 68)						
• Label size 5 × 10 mm (WIN 68)						
<b>8WA8348-2AY</b>						
<b>8WA8310-2AY</b>						
100 136 units 1BT						
100 136 units 1BT						
<b>Labels, with inscription</b>						
• Label size 5 × 7 mm						
• Font height 2 mm						
Versions						
• Horizontal inscription						
• Vertical inscription						
Inscription						
• 1...5 (40x)						
• 6...10 (40x)						
• 11...15 (40x)						
• 16...20 (40x)						
• 21...25 (40x)						
• 26...30 (40x)						
• 31...35 (40x)						
• 36...40 (40x)						
• 41...45 (40x)						
• 46...50 (40x)						
• 51...55 (40x - only available as 8WA8361-0BL)						
• 56...60 (40x)						
• 61...65 (40x)						
• 66...70 (40x - only available as 8WA8361-0BP)						
• 71...75 (40x)						
• 76...80 (40x)						
• 81...85 (40x)						
• 86...90 (40x - only available as 8WA8361-0BT)						
• 91...95 (40x)						
• 96...100 (40x)						
• 1...20 (10x)						
• 1...40 (5x)						
• 41...100 (3x)						
• 101...200 (2x)						
• 201...300 (2x)						
• 1...100 (2x)						
• A, B...T (10x)						
• U, V, W, X, Y, Z (30x) +, - (10x)						
• L1, L2, L3, N, PE (40x)						
• U1, V1, W1, U2, V2, W2, (30x); blank (20x)						
<b>8WA8360-□□□</b>						
<b>8WA8361-□□□</b>						
100 204 units 1BT						
100 204 units 1BT						
▲▲▲						
<b>0BA</b>						
<b>0BB</b>						
<b>0BC</b>						
<b>0BD</b>						
<b>0BE</b>						
<b>0BF</b>						
<b>0BG</b>						
<b>0BH</b>						
<b>0BJ</b>						
<b>0BK</b>						
<b>0BL</b>						
<b>0BM</b>						
<b>0BN</b>						
<b>0BP</b>						
<b>0BQ</b>						
<b>0BR</b>						
<b>0BS</b>						
<b>0BT</b>						
<b>0BU</b>						
<b>0BV</b>						
<b>0AB</b>						
<b>0AC</b>						
<b>0AD</b>						
<b>0AF</b>						
<b>0AG</b>						
<b>0AE</b>						
<b>1AA</b>						
<b>1AB</b>						
<b>1AC</b>						
<b>1AD</b>						
<b>Labels, type 347/348, with inscription</b>						
• Label size 5 × 7 mm						
• Font height 2 mm						
Versions						
• Horizontal inscription						
• Vertical inscription						
Inscription						
• L1 (100x)						
• L2 (100x)						
• L3 (100x)						
• N (100x)						
• MP (100x - only available as 8WA8348-2AB)						
• PE (100x - only available as 8WA8348-2AH)						
• L+ (100x)						
• L- (100x)						
• N (100x)						
• X (100x - only available as 8WA8348-1AG)						
• Y (100x - only available as 8WA8348-1AH)						
<b>8WA8347-□□□</b>						
<b>8WA8348-□□□</b>						
100 136 units 1BT						
100 136 units 1BT						
▲▲▲						
<b>2AC</b>						
<b>2AD</b>						
<b>2AE</b>						
<b>1AR</b>						
<b>2AB</b>						
<b>2AH</b>						
<b>2AF</b>						
<b>2AG</b>						
<b>1AR</b>						
<b>1AG</b>						
<b>1AH</b>						





Horizontal inscription  
(8WA8360-0BA)Vertical inscription  
(8WA8361-0BA)Horizontal inscription  
(8WA8347-2AC)Vertical inscription  
(8WA8348-2AC)

## Accessories for 8WA Terminal Blocks

### Standard labeling system

Version	DT	Article No. <a href="http://www.siemens.com/product?Article No.">www.siemens.com/ product?Article No.</a>	Price per PU	PU (UNIT, SET, M)	PS*/ P. unit	PG
<b>Labels, custom inscriptions</b> <ul style="list-style-type: none"> <li>Label size 5 × 7 mm</li> <li>Font height 2 mm</li> <li>Specify required inscription in plain text</li> </ul>						
<b>Labels, custom inscriptions</b> <ul style="list-style-type: none"> <li>Label size 5 × 7 mm</li> <li>Font height 2 mm</li> <li>Specify required inscription in plain text</li> </ul>						
<b>End labeling plates</b> <ul style="list-style-type: none"> <li>21 × 42 mm</li> <li>Paper label, inscription possible, with transparent cover</li> <li>Suitable for 8WA1805, 8WA1808 and 8WA2808 end retainers</li> </ul>						
 8WA1806		<b>8WA8347-0XA</b> <b>8WA8348-0XA</b>		100	136 units	1BT
<b>Terminal strip labels</b> Suitable for 8WA1808 end retainer						
 8WA8826-0AA		<b>8WA8826-0AA</b> <b>8WA8826-0AB</b> <b>8WA8826-0AC</b> <b>8WA8212-0AA65</b>		100	380 units	1BT
				100	100 units	1BT
				100	100 units	1BT
				100	380 units	1BT

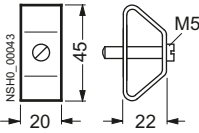
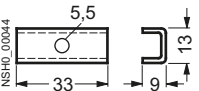
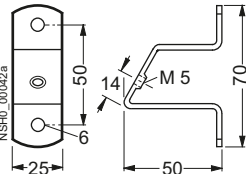
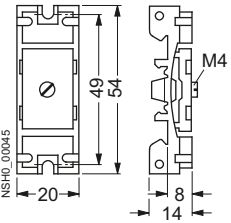
## Selection and ordering data

Version	DT	Article No. <a href="http://www.siemens.com/product?ArticleNo.">www.siemens.com/ product?Article No.</a>	Price per PU	PU (UNIT, SET, M)	PS*/ P. unit	PG
 <p><b>End retainers, with screw fixing</b></p> <ul style="list-style-type: none"> <li>• Mounting width 10 mm</li> <li>• Suitable for 8WA1806 end labeling plate or 8WA8826-0A. terminal strip identification label or 3TX4210-0H device label or four 8WA88. labels.</li> </ul>		<b>8WA1808</b> <b>8WA1805</b> <b>5ST1145</b> <b>5ST1141</b>		1	50/500 units	1BT
 <p><b>End retainers, steel</b></p> <ul style="list-style-type: none"> <li>• Mounting width 10,3 mm</li> <li>• Suitable for 8WA1806 end labeling plate</li> </ul> <p>Note</p> <p>An 8WA1820 barrier must be inserted if using end retainers against an 8WA189. connection bar (size 2.5).</p>				1	50 units	1BT
 <p><b>Standard mounting rails</b></p> <p>Versions</p> <ul style="list-style-type: none"> <li>• With holes <ul style="list-style-type: none"> <li>- EN 50022-35 × 7,5</li> <li>- 2 m long, 1 mm thick</li> <li>- Steel, sendzimir-galvanized</li> </ul> </li> <li>• Non-perforated</li> <li>• Non-perforated, copper <ul style="list-style-type: none"> <li>- EN 50022-35 × 15</li> <li>- 2 m long, 2,3 mm thick</li> </ul> </li> <li>• Non-perforated, steel, galvanized, chromated <ul style="list-style-type: none"> <li>- Similar to EN 50022-35 × 15</li> <li>- 2 m long, 1,5 mm thick</li> </ul> </li> </ul>				1	20 units	1AD
 <p><b>Spacer brackets</b></p> <p>For raised mounting of terminal strips</p>		<b>8WA753</b>		1	50 units	1BT
 <p><b>Spacers</b></p> <ul style="list-style-type: none"> <li>• With 5.5 mm hole</li> <li>• For raised mounting of terminal strips</li> </ul>		<b>8WA752</b>		1	100 units	1BT
 <p><b>Mounting brackets</b></p> <p>For support rails</p>		<b>8WA746</b>		1	10 units	1BT
 <p><b>Insulation carriers</b></p> <p>For insulated mounting of support rails onto plates, frame profiles and standard mounting rails EN 50022-35</p>		<b>8WA1857</b>		1	20 units	1BT
 <p><b>Screwdrivers, for 8WA2</b></p> <ul style="list-style-type: none"> <li>• 3.5 × 0.5 mm, partially insulated</li> <li>• Green</li> <li>• Approx. 175 mm long</li> </ul>		<b>8WA2880</b>		1	1 unit	1BT

## Accessories for 8WA Terminal Blocks

### Notes

## Appendix

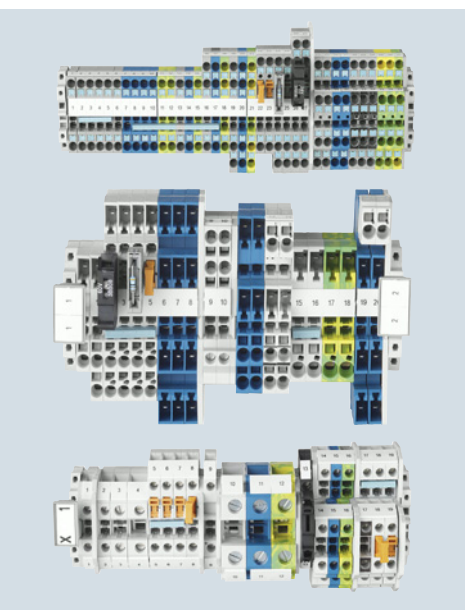

12/2	<b>Catalog notes</b>
12/3	<b>Ordering notes</b>
12/5	<b>Support on UL topics</b>
12/6	<b>ATEX explosion protection</b>
12/7	<b>Further documentation</b>
12/11	<b>Quality management</b>
12/12	<b>Standards and approvals</b>
12/14	<b>Siemens contacts</b>
12/15	<b>Service &amp; Support</b>
12/16	<b>Comprehensive support from A to Z</b>
12/17	<b>Software licenses</b>
12/19	<b>Subject index</b>
12/21	<b>Article No. index incl. export markings</b>
12/28	<b>Conditions of sale and delivery</b>

**For further technical product information:**

Siemens Industry Online Support:  
[www.siemens.com/lowvoltage/product-support](http://www.siemens.com/lowvoltage/product-support)

- Application example
- Certificate
- Characteristic
- Download
- FAQ
- Manual
- Product note
- Software archive
- Technical data

## Appendix

### Catalog notes

#### Overview

##### Trademarks

All product designations may be registered trademarks or product names of Siemens AG or supplier companies whose use by third parties for their own purposes may violate the rights of the owner.

##### Amendments

Unless stated otherwise on the individual pages of this catalog, we reserve the right to make changes, in particular to the specified values, measurements and weights.

##### Dimensions

All dimensions are given in mm.

##### Illustrations

The illustrations are not binding.

##### Technical specifications

The technical specifications are for general information purposes only. Always heed the operating instructions and notices on individual products during assembly, operation and maintenance.

Further technical information is available at [www.siemens.com/lowvoltage/product-support](http://www.siemens.com/lowvoltage/product-support)

- under "Entry type":
  - Application example
  - Certificate
  - Characteristic
  - Download
  - FAQ
  - Manual
  - Product note
  - Software archive
  - Technical data



Configurators can be found under [www.siemens.com/lowvoltage/configurators](http://www.siemens.com/lowvoltage/configurators)

##### Assembly, operation and maintenance

Always heed the operating instructions and notices on individual products during assembly, operation and maintenance.

##### Symbols

In the table below, you will find all symbols concerning connections that can occur in this catalog. In combination with orange highlighting, these identify special selection criteria.

Connections	
	Screw connection
	Ring cable lug connection
	Spring-loaded terminals

## Appendix Logistics

### General

With regard to delivery service, communications and environmental protection, our logistics service ensures "quality from the moment of ordering right through to delivery". By designing our infrastructure according to customer requirements and implementing electronic order processing, we have successfully optimized our logistics processes.

We are proud of our personal consulting service, on-time deliveries and 1-day transport within Germany.

**To this end, we supply preferred types marked with ► ex works.**

We regard the DIN ISO 9001 certification and consistent quality checks as an integral part of our services.

Electronic order processing is fast, cost-efficient and error-free. Please contact us if you want to benefit from these advantages.

### Packaging, packing units

The packaging in which our equipment is dispatched provides protection against dust and mechanical damage during transport, thus ensuring that all our products arrive in perfect condition.

We select our packaging for maximum environmental compatibility and reusability (e.g. crumpled paper for protection during transport in packages up to 32 kg) and, in particular, with a view to reducing waste.

With our multi-unit and reusable packaging, we offer you specific types of packaging that are both kind to the environment and tailored to your requirements:

Your advantages at a glance:

- Lower ordering costs.
- Cost savings through same-material type packaging: Low/no disposal costs.
- Reduced time and cost thanks to short unpacking times.
- "Just-in-time" delivery directly to the production line helps reduce stock: Cost savings through reduction of storage areas.
- Fast assembly thanks to supply in sets.
- Standard Euro boxes - corresponding to the Euro pallet modular system - suitable for most conveyor systems.
- Active contribution to environmental protection.

Unless stated otherwise in the "Selection and ordering data" of this catalog, our products are supplied individually packed.

For small parts/accessories, we offer you cost-effective packaging units as standard packs containing more than one item, e.g. 5, 10, 50 or 100 units. It is essential that whole number multiples of these quantities be ordered to ensure satisfactory quality of the products and problem-free order processing.

The products are delivered in a neutral carton. The label includes warning notices, the CE marking, and device descriptions in English and German.

In addition to the Article No. (MLFB) and the number of items in the packaging, the operating instructions order number (Instr.-Order-No.) is also specified. They can be obtained from your local Siemens representative (you will find a list at [www.siemens.com/automation/partner](http://www.siemens.com/automation/partner)).

Most device Article No.'s can be obtained by means of the EAN barcode to simplify ordering and storage logistics.

The associated master data, too, is available from your local Siemens representative.

## Appendix

### Ordering notes

#### Overview

##### Ordering special versions

When ordering products that differ from the standard versions listed in the catalog, "-Z" must be added to the Article No. indicated and the required features must be specified using alphanumeric order codes or plain text.

##### Ordering very small quantities

When very small orders are placed, the costs associated with order processing are greater than the order value. We therefore recommend that you combine several small orders. Where this is not possible, we regret that we are obliged to make a small processing charge: for orders with a net goods value of less than € 250 we charge an € 20 supplement to cover our order processing and invoicing costs.

#### Explanations of Selection and Ordering Data

##### Delivery time class (DT)

DT	Meaning	
▶	Preferred type	Preferred types are device types that can be delivered immediately ex works, i.e. they are dispatched within 24 hours.
A	Two working days	If ordered in normal quantities, the products are usually delivered within the specified delivery times, calculated from the date we receive your order.
B	One week	In exceptional cases, delivery times may vary from those specified.
C	Three weeks	The delivery times are valid ex works from Siemens AG (products ready for dispatch).
D	Six weeks	Shipping times depend on the destination and the method of shipping. The standard shipping time for Germany is one day.
X	On request	The specified delivery times are correct at the time of going to print and are subject to constant optimization. Up-to-date information can be found at <a href="http://www.siemens.com/industryall">www.siemens.com/industryall</a> .

##### Price units (PU)

The price unit defines the number of units, sets or meters to which the specified price and weight apply.

##### PS/P. unit (packaging size/packaging unit)

The packaging size/packaging unit defines the number, e.g. of units, sets or meters, contained within outer packaging:

- The **first digit** in the PS/P. unit column (packaging size/packaging unit) indicates the minimum order quantity. You can only order this specified quantity or a multiple thereof.
- The **second digit** in the PS/P. unit column (packaging size/packaging unit) specifies the number of units contained within the outer packaging (e.g. in a carton). You must order this quantity or a multiple thereof if you want the items to be delivered in discrete packaging quantities.

Examples:

PS/P. unit	Meaning
1 unit	You can order one item or a multiple thereof.
5 units	Five units are packed in a bag, for example. Because the bags cannot be opened, you can only order a multiple of the quantity contained in the bag: 5, 10, 15, 20 etc.
5/100 units	One carton contains (for example) 20 bags, each containing 5 units, i.e. a total of 100 units. If only cartons are available for delivery, you need to order a multiple of the carton quantity: 100, 200, 300, etc. Ordering a quantity of 220 units would result in the following delivery: two cartons, each containing 100 units (= 200 units) and 4 bags, each containing 5 units (= 20 units).
1 set	A set comprises a defined number of different parts.

##### Price group (PG)

Each product is allocated to a price group.

##### Weight

The defined weight is the net weight in kg and refers to the price unit (PU).

##### Examples

DT	Article No.	Price per PU	PU (UNIT, SET, M)	PS/P. unit	PG	Weight per PU approx.	DT	Article No.	Price per PU	PU (UNIT, SET, M)	PS/P. unit	PG
▶	<b>3NW7013</b>		1	1/12 units	1BM	0.076		<b>3VA1196-3ED26-0AA0</b>		1	1 unit	1CB
DT:	Preferred type						DT:					
PU:	One unit (on which price is based)						PU:	One unit (on which price is based)				
PS/P. unit:	1 = minimum order quantity / 12 = quantity per carton						PS/P. unit:	1 = minimum order quantity				
PG:	1BM						PG:	1CB				
Weight per PU	76 g, always given in kg											

Note:

The article numbers shown here are examples only. They are not necessarily included in this catalog, nor is it essential that their specifications regarding selection and ordering data be up to date. When ordering, always use the selection and ordering data.



## Low-voltage power distribution and electrical installation technology. The secrets of UL. You have our support.

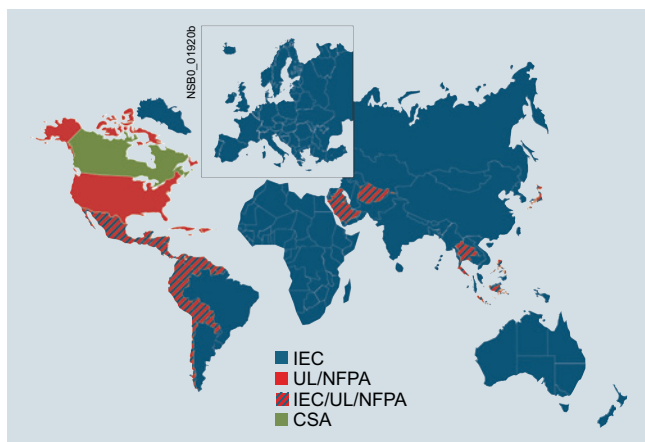

Application range

### We support you where UL is concerned

Product liability laws in the USA are significantly stricter than in Europe. Anybody wishing to export their products to North America is strongly advised to have them certified to UL standards, particularly where electrical equipment is concerned. We can help you with our comprehensive know-how and broad portfolio of UL-certified low-voltage controls.

### Who or what is UL?

UL (Underwriters Laboratories Inc.®) is one of the world's leading organizations involved in product safety testing and certification. This independent, non-profit making US-based organization was founded in 1894 by American fire insurance groups, with the intention of investigating the fire hazards presented by electrical devices.

Today, UL checks and certifies the operational safety of all kinds of materials, components and end products, particularly with regard to the possibility of personal injury and the development of fires. There are branches in numerous European countries. You can obtain more detailed information about this US organization, as well as options for contacting the numerous branches throughout Europe, on the Internet at [www.ul.com](http://www.ul.com).

### Differences between UL and IEC

The IEC standards for the IEC market merely define the minimum safety requirements for a device or system. The technical details relating to how safety requirements are to be implemented in practice remain a matter for the manufacturer.

By contrast, the guidelines for the US market are much more specific. Depending on the standard, the entire process may require monitoring – from product design and manufacture, to application and installation, right through to operation.

NFPA79 is the electrical standard for industrial machinery outside the control cabinet. As such it differs from and is the counterpart to the control cabinet standard UL 508A.

### A UL partner since 1969

Enlisting the expertise of a competent partner such as Siemens is a wise option for anyone who wishes to avoid unnecessary aggravation and save both time and money.

At our electronics plant in Amberg, Germany, which develops and manufactures the entire range of low-voltage controls, we have been collaborating closely with Underwriters Laboratories Inc. since 1969.

Right from the product development stage, we take not only IEC guidelines, but also UL standards, into account. This has resulted in a wide-ranging portfolio of UL-certified low-voltage switchgear, controlgear and protection circuit technology.

We therefore offer comprehensive know-how on the subject of UL certification, ranging from production down to control panel wiring according to UL standards, which we will be pleased to explain to you within the scope of our application consulting service.

Our range of low-voltage controls enables you to play safe where UL is concerned, and allows you to assemble UL-compliant control cabinets quickly and easily.

### Cost-effectiveness in the building and operation of switchgear and control cabinets for North America

- Stay flexible for the widest range of solutions and expansions with our comprehensive, coordinated product portfolio, from the infeed of the machine control system to the smallest actuator in the machine.
- Reap the benefits of efficient stock keeping thanks to the universal usability of the products (IEC-UL/CSA).
- Implement a uniform operating and maintenance concept thanks to our standard system.
- Save space and costs with coordinated product interfaces and compact designs.
- Experience easy, efficient local operation thanks to user-friendliness.

### UL-certified products

UL-certified products to be found in this catalog include, for example:

- SENTRON protection, switching, measuring and monitoring devices
- SIVACON 8MR system air-conditioning
- ALPHA FIX terminal blocks

In catalog LV 16, you will also find a comprehensive selection of controls and components for applications according to UL.

On the Internet, you will find information on topics including UL standards, UL classifications and a number of technical particularities of UL.

Under "Information Material" → "Standards and Approvals" we have summarized the available products and product groups. A table lists the UL standards to which the products conform and refers to the corresponding UL reports.

For more information see [www.siemens.com/applicationconsulting/ul](http://www.siemens.com/applicationconsulting/ul)

## Appendix

### ATEX explosion protection

#### Overview

In many industries the production, processing, transport and storage of combustible substances are prone to the escape of gases, vapors or spray which then find their way into the environment. Other processes produce combustible dust. Together with the oxygen in the air, the result can be a potentially explosive atmosphere which will explode if ignited.

Serious injury to persons and damage to property can result, particularly in the chemical and petrochemical industries, mineral oil and natural gas production, mining, mills (e.g. grain, bulk solids) and many other industrial sectors.

To ensure the maximum possible safety in these areas, legislators in most countries have drawn up requirements in the form of laws, regulations and standards. In the course of globalization, great progress has been made with regard to uniform directives for explosion protection.

With Directive 94/9/EC, the European Union laid the foundations for complete harmonization by requiring that all new devices as from July 1st, 2003 have to be approved in accordance with this directive.

In this catalog, special attention is drawn to devices which comply with the ATEX Directive. However, it does not replace the need for intensive study of the relevant fundamentals and directives when planning and installing electrical systems.



## Low-voltage power distribution and electrical installation technology on the WWW

We regard product support to be just as important as the products and systems themselves.

Visit our website for a comprehensive offering of support for low-voltage power distribution and electrical installation products, such as:

- Overview of the entire product portfolio
- Keeping up to date via newsletters, podcasts, blogs and Twitter
- Access to interesting videos on YouTube
- Contact with partners around the world
- Operating instructions and manuals for direct download and much more - all conveniently and easily accessible.

[www.siemens.com/lowvoltage](http://www.siemens.com/lowvoltage)

## Information and Download Center

You will find regularly updated information material such as catalogs, customer magazines, brochures and trial versions of software for low-voltage power distribution and electrical installations on the Internet at

[www.siemens.com/lowvoltage/infomaterial](http://www.siemens.com/lowvoltage/infomaterial)

Here you can order your copy of the available documentation or download it in common file formats (PDF, ZIP).

## Appendix

### Further documentation

#### Product selection using the interactive catalog CA 01

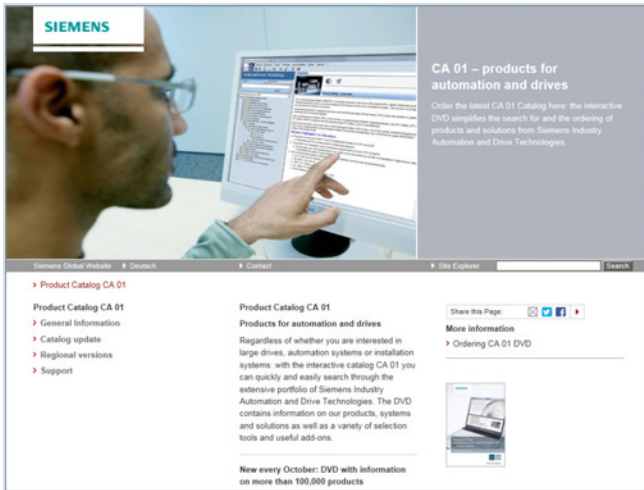

#### **Detailed information together with user-friendly interactive functions:**

The interactive catalog CA 01 with more than 80,000 products provides a comprehensive overview of the product range from Siemens Industry.

You can find everything you need here for solving automation, switching, installation and drive technology tasks. All information is provided over a user interface that is both user-friendly and intuitive.

After selecting the product of your choice you can order at the press of a button, by fax or by online link.

Information about the interactive catalog CA 01 can be found on the Internet at:

[www.siemens.com/automation/ca01](http://www.siemens.com/automation/ca01)

or on DVD.

#### Industry Mall

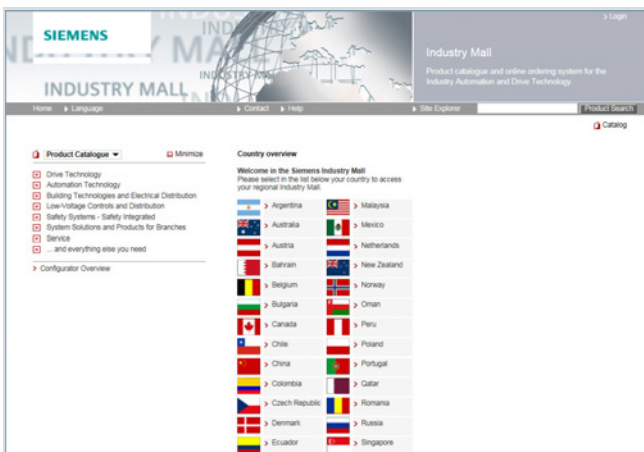

#### **The Industry Mall – for online information, product selection and ordering:**

- Detailed information including product data, illustrations, certificates and CAx data
- Simple configuring of systems
- Possible to request individualized quotations
- Availability check
- Online ordering facility
- Order tracking/order overview
- Fast access to relevant training offers and services

You can find the Industry Mall on the Internet at

[www.siemens.com/industrymall](http://www.siemens.com/industrymall)

#### Industry Online Support

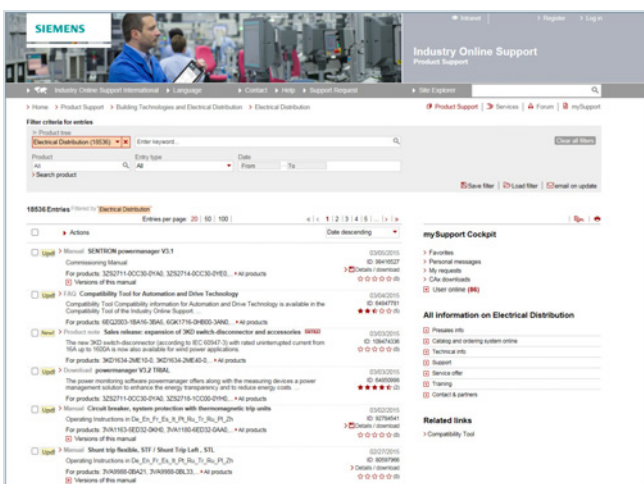

#### **Comprehensive support – at any time, whatever your location**

- FAQs, sample applications, information about successor products and product news
- Prompt assistance with technical queries
- Discussions and best practice sharing with other users in the forum
- Provision of high-quality product data for your planning programs
- Faster access to information – with helpful filter and folder functions in mySupport
- Automatic notification service to keep you up to date with the latest information about topics of interest to you

To find the link to Siemens Industry Online Support, go to

[www.siemens.com/lowvoltage/product-support](http://www.siemens.com/lowvoltage/product-support)

## Industry Online Support App



### Main functions at a glance

- Scanning of product codes (EAN/QR and data matrix codes) with direct display of all technical information on the product, including graphic data (CAx data).
- Delivery of product information or entries by e-mail, so that the information can immediately be processed at the workplace.
- Submission of queries to Technical Support (Support Requests). With photo function for transmitting detailed information.
- Contents and interfaces available in six languages (German, English, French, Italian, Spanish and Chinese) – including option of temporary switchover to English.
- Offline cache function for all favorites stored in "mySupport". These entries can also be retrieved without network reception.
- Import of PDF documents into a library (e.g. iBooks or similar).
- An overview of the main functions can be found at

[www.siemens.com/lowvoltage/support-app](http://www.siemens.com/lowvoltage/support-app)

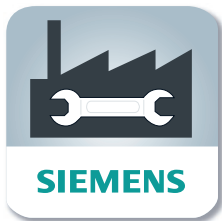

### Android:

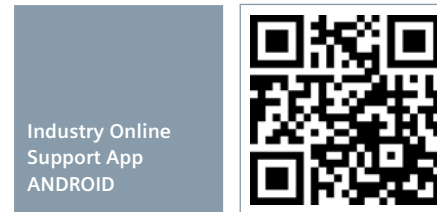

### Apple iOS:



### Windows:

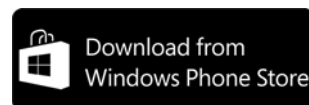

## Appendix

### Further documentation

#### Product configurator



#### Finding the right product faster

- Complete selection of products and systems based on technical characteristics or application requirements
- Simple, intuitive operation
- Option to save the configuration and order lists in a file format of your choice (txt, pdf, xls, csv)
- Direct transfer of the order list into the shopping cart of the Siemens Industry Mall
- Fast access to product data, diagrams, certificates and CAX data for the selected product and system configuration
- Available in multiple languages for use by customers anywhere in the world

The configurators are available online in the Siemens Industry Mall and offline in Catalog CA 01.

You can find our configurators at the following website:

[www.siemens.com/lowvoltage/configurators](http://www.siemens.com/lowvoltage/configurators)

#### CAX Download Manager

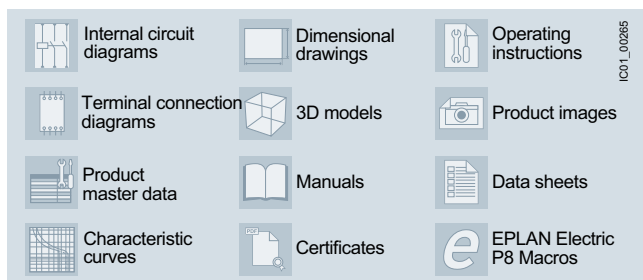

You can find the CAX Download Manager on the Internet at

#### Time savings of up to 80 % with universal product data for your CAE and CAD systems

The CAX Download Manager can supply you with all the necessary CAX file types for the products of your choice for use in all common CAE and CAD systems. The data contained in the files is continuously updated. The whole process involves only four selection steps and is free of charge. All your selected files are packed into a zip file which you can download for further use.

Siemens makes available up to 12 file types to support your mechanical (CAD) and electrical (CAE) planning processes for you to download at any time of the day.

- No manual data collection necessary
- Universal manufacturer data for all common CAE and CAD systems
- Standardized documentation is simple to generate
- Choice of different languages for system commissioning anywhere in the world

#### My Documentation Manager

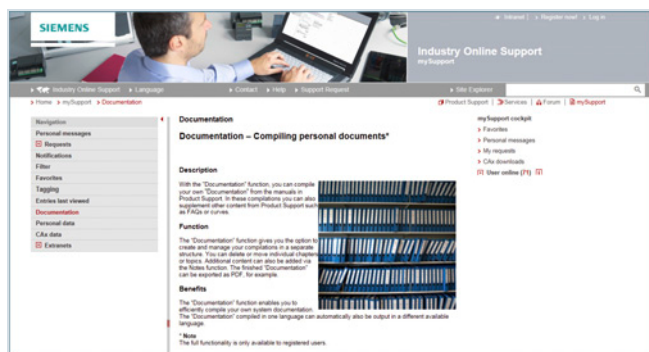

In "mySupport" you can compile individual documentation for your project by dragging and dropping

\* e.g. Low Voltage Directive 2006/95/EC and EC Machinery Directive 2006/42/EC

You can find My Documentation Manager on the Internet at

[www.siemens.com/lowvoltage/mdm](http://www.siemens.com/lowvoltage/mdm)

#### User-friendly compilation of project-specific documentation

In accordance with directives\*, the documentation is part of the plant and requires certification, thus giving the purchaser the right to full plant documentation.

To support you in this, a manual configurator has been developed with which you can put together individual and standard-compliant documentation – fully in accordance with the relevant project-specific requirements.

You can thus select the chapters relevant to the respective project from the available manuals of the installed Siemens components. FAQs, certificates, data sheets and your own content can also be incorporated.

- Compile and structure manuals, data sheets, FAQs and certificates simply by dragging and dropping
- Insert personalized content via the Notes function
- Further processing possible thanks to selectable export formats (pdf, xml, rtf)
- After generating the documentation, automatic translation into the desired language is possible
- Always up-to-the minute thanks to the Update function

**Overview**

The quality management system of our "Low Voltage & Products" Business Unit in the "Energy Management" Division complies with the international EN ISO 9001 standard.

The products and systems listed in this catalog are developed and manufactured using a certified quality management system in accordance with EN ISO 9001:2008.

## Appendix

### Standards and approvals

#### Overview

##### Certificates

An overview, updated on a daily basis, of our products certified in accordance with CE, UL, CSA, FM, shipping authorizations etc. for low-voltage power distribution and electrical installation products can be found on the Internet at

[www.siemens.com/lowvoltage/certificates](http://www.siemens.com/lowvoltage/certificates)

The screenshot shows the Siemens Industry Online Support interface. The main content area is titled 'Filter criteria for entries' and shows a search for 'Electrical Distribution (2295)' and 'Certificate (2295)'. Below the filters, there are 2295 entries. The first three entries are:

Actions	Product	Entry type	Date
<input type="checkbox"/>	Certificate Shipping Approval, RMRS / Russian Maritime Register, RMRS (Russian Maritime Register)	Certificate	06/29/2015
<input type="checkbox"/>	Certificate General Product Approval, CCC, CQC	Certificate	06/29/2015
<input type="checkbox"/>	Certificate General Product Approval, CCC, CQC	Certificate	06/29/2015

On the right side, there is a 'mySupport Cockpit' with links for Favorites, Personal messages, My requests, CAX downloads, and User online ((0)) (55). Below that is 'All information on Electrical Distribution' with links for Presales info, Catalog and ordering system online, Technical info, and Support.

In the **Entry list** you can **filter the view** in order to quickly find comprehensive information on the following subjects:

- Product or search term
- Date
- Type of certificate (general product approval, test certificates, shipping approval, ...)
- Certificate (confirmations, UL, VDE, ...)
- Approval office (TÜV, VDE, UL, ...)
- Country

The screenshot shows the 'Entry list' for 'Electrical Distribution' and 'Certificate'. The list is filtered by 'VDE' and shows 295 entries. A dropdown menu is open, showing a list of approval offices and their counts:

Approval office	Country
ABS (American Bureau of Shipping) (8)	All
BV (Bureau Veritas) (12)	All
CB-Members (7)	All
CEBEC (15)	All
COC (184)	All
CSA (47)	All
DNV (Det Norske Veritas) (13)	All
Manufacturer (1213)	All
EZU (1)	All
GL (Germanischer Lloyd) (29)	All
IMQ (55)	All
KEMA (44)	All
LR (Lloyd's Register) (19)	All
OVVE (14)	All
Profibus Nutzerorganisation e.V. (PNO) (17)	All
PRS (Polski Rejestr Statków) (11)	All
RINA (Registro Italiano Navale) (6)	All
RMRS (Russian Maritime Register) (10)	All
ROSTEST (5)	All
SUVA (2)	All
TÜV (technischer Überwachungsverein) (1)	All
UL (132)	All
VDE (295)	All
other (85)	All
TSE (2)	All
KETI (2)	All
KTL (80)	All
EIB/OKX (8)	All
IVANOVO-CERTIFICATE (3)	All



### Approval requirements valid in different countries

Siemens low-voltage switchgear and controlgear are designed, manufactured and tested according to the relevant German standards (DIN and VDE), IEC publications and European standards (EN) as well as CSA and UL standards. You will find the standards assigned to the single devices in the relevant certificates at

[www.siemens.com/lowvoltage/certificates](http://www.siemens.com/lowvoltage/certificates)

In addition to the pertinent VDE, EN and IEC standards, the requirements of the various regulations valid in other countries have also been taken into account in the design of the equipment in some cases, in order that the devices can be deployed globally as far as possible.

In some countries an approval is required for certain low-voltage switchgear and controlgear components. Depending on the market requirements, these devices have been submitted for approval to the authorized testing institutes.

In some cases, CSA for Canada and UL for the USA only approve special versions. Such special versions are listed separately from the standard versions in the relevant parts of this catalog.

For this equipment, there are sometimes limits with regard to the maximum permissible voltages, currents and rated outputs or special approvals and, in some cases, special identification may be required.

For use on board ship, the specifications of the marine classification societies must be observed. In some cases, they require type tests of the components to be approved.

If you have any questions concerning UL/CSA approvals, please contact Technical Support:

[www.siemens.com/lowvoltage/contact](http://www.siemens.com/lowvoltage/contact)

## Appendix

### Siemens contacts

#### Contacts for low-voltage power distribution and electrical installation technology

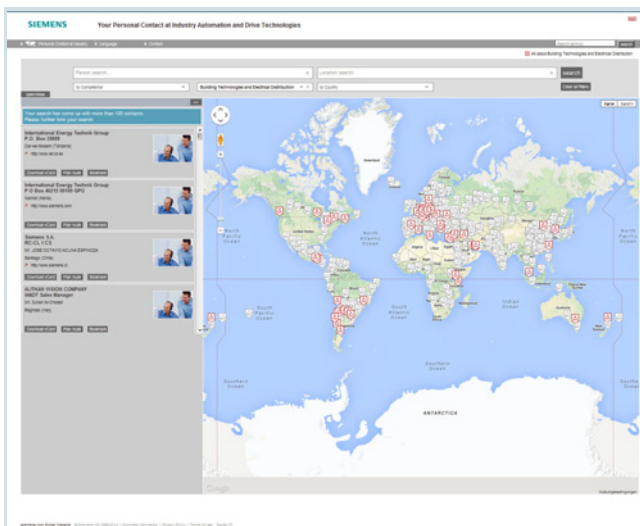

With low-voltage power distribution and electrical installation technology we consistently pursue one goal:

long-term improvement of your competitive ability.

We are committed to this goal. Thanks to our dedication, we are continually setting new standards. In all industries – worldwide.

At your service, locally, around the globe: Partners for consulting, sales, training, service, support, spare parts ... on the entire range of low-voltage power distribution and electrical installation technology.

Your personal contact can be found in our Contact Database at

[www.siemens.com/lowvoltage/contact](http://www.siemens.com/lowvoltage/contact)

You start by selecting a

- Competence
- Product or branch
- Country
- City.

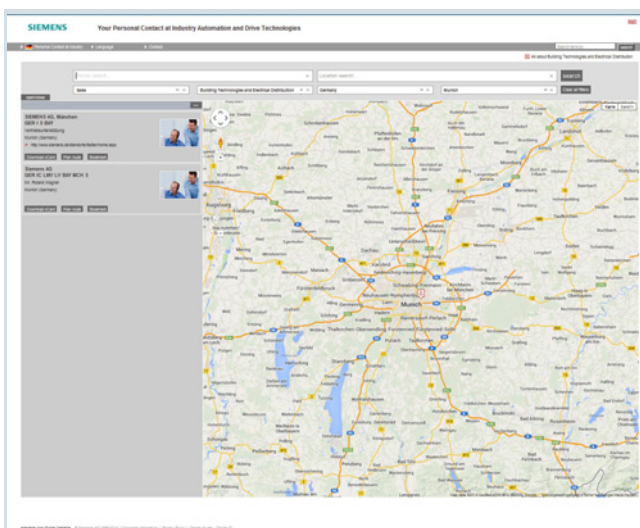

### Unrivalled complete range of services over the entire life cycle

#### Online Support

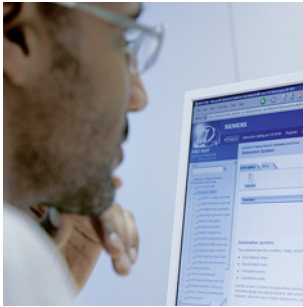

Our comprehensive online information platform covers every aspect of our Service & Support and is available whenever, wherever.

More detailed information is available at [www.siemens.com/lowvoltage/product-support](http://www.siemens.com/lowvoltage/product-support)

#### Field Service



Siemens Field Service offers support with all aspects of maintenance – so that the availability of your machines and plants is assured whatever the case.

More detailed information is available at [www.siemens.com/lowvoltage/contact](http://www.siemens.com/lowvoltage/contact)

#### Technical Support



The competent consulting service for technical issues with a broad range of customer-oriented services for all our products and systems.

More detailed information is available at [www.siemens.com/lowvoltage/contact](http://www.siemens.com/lowvoltage/contact)

#### Spare Parts



Plants and systems in all industries worldwide are expected to meet ever higher levels of availability.

We can help you rule out unexpected stoppages: with a global network and optimum logistics chains.

You will find further information at [www.siemens.com/lowvoltage/contact](http://www.siemens.com/lowvoltage/contact)

#### Training



Extend your lead – with practice-related know-how straight from the manufacturer.

More detailed information is available at [www.siemens.com/lowvoltage/training](http://www.siemens.com/lowvoltage/training)

#### Specification texts

You can obtain qualified, free support to help you produce specifications for technically equipping non-residential and industrial buildings at

[www.siemens.com/specifications](http://www.siemens.com/specifications)

## Appendix

### Comprehensive support from A to Z

#### Overview

Product information	
<b>Website</b>	Fast and targeted information on low-voltage power distribution and electrical installation technology: <a href="http://www.siemens.com/lowvoltage">www.siemens.com/lowvoltage</a>
<b>Newsletter</b>	Always up to date about our trend-setting products and systems: <a href="http://www.siemens.com/lowvoltage/newsletter">www.siemens.com/lowvoltage/newsletter</a>
Product information/product & system selection	
<b>Information and Download Center</b>	Current catalogs, customer magazines, brochures, demo software and promotion packages: <a href="http://www.siemens.com/lowvoltage/infomaterial">www.siemens.com/lowvoltage/infomaterial</a>
<b>Industry Mall</b>	Comprehensive information and order platform for the Siemens Industry Basket: <a href="http://www.siemens.com/lowvoltage/mall">www.siemens.com/lowvoltage/mall</a>
<b>CA 01</b>	The interactive catalog on DVD for automation and drive technology and low-voltage power distribution and electrical installation products
Product and system engineering	
<b>SIMARIS software tools</b>	Support in planning and configuring the electrical power distribution: <a href="http://www.siemens.com/simaris">www.siemens.com/simaris</a>
<b>SIMARIS ConFIGuration Basic planning and configuration tool</b>	Assists in generating offers and configuring products ranging from ALPHA distribution boards to the SIKUS 1600 power distribution boards <a href="http://www.siemens.com/scfb">www.siemens.com/scfb</a>
Product documentation	
<b>Siemens Industry Online Support</b>	Comprehensive technical information - from planning to configuration and operation: <a href="http://www.siemens.com/lowvoltage/product-support">www.siemens.com/lowvoltage/product-support</a>
<b>Product configurator</b>	Complete selection of products and systems based on technical characteristics or application requirements: <a href="http://www.siemens.com/lowvoltage/configurators">www.siemens.com/lowvoltage/configurators</a>
<b>CAX Download Manager</b>	Collation of CAX data types for standard CAE and CAD systems: <a href="http://www.siemens.com/lowvoltage/cax">www.siemens.com/lowvoltage/cax</a>
<b>My Documentation Manager</b>	Compilation of project-specific documentation: <a href="http://www.siemens.com/lowvoltage/mdm">www.siemens.com/lowvoltage/mdm</a>
<b>Image database</b>	Collection of product photographs and graphics, such as dimensional drawings and internal circuit diagrams: <a href="http://www.siemens.com/lowvoltage/picturedb">www.siemens.com/lowvoltage/picturedb</a>
Product training	
<b>SITRAIN Portal</b>	Comprehensive training program for our products, systems and engineering tools: <a href="http://www.siemens.com/lowvoltage/training">www.siemens.com/lowvoltage/training</a>
Product hotline	
<b>Technical Support</b>	Support in all technical queries about our products: <a href="http://www.siemens.com/lowvoltage/contact">www.siemens.com/lowvoltage/contact</a> <a href="http://www.siemens.com/lowvoltage/technical-support">www.siemens.com/lowvoltage/technical-support</a>

## Overview

### Software types

Software requiring a license is categorized into types. The following software types have been defined:

- Engineering software
- Runtime software

### Engineering software

This includes all software products for creating (engineering) user software, e.g. for configuring, programming, parameterizing, testing, commissioning or servicing.

Data generated with engineering software and executable programs can be duplicated for your own use or for use by third-parties free-of-charge.

### Runtime software

This includes all software products required for plant/machine operation, e.g. operating system, basic system, system expansions, drivers, etc.

The duplication of the runtime software and executable programs created with the runtime software for your own use or for use by third-parties is subject to a charge.

You can find information about license fees according to use in the ordering data (e.g. in the catalog). Examples of categories of use include per CPU, per installation, per channel, per instance, per axis, per control loop, per variable, etc.

Information about extended rights of use for parameterization/configuration tools supplied as integral components of the scope of delivery can be found in the readme file supplied with the relevant product(s).

### License types

Siemens Industry Automation & Drive Technologies offers various types of software license:

- Floating license
- Single license
- Rental license
- Rental floating license
- Trial license
- Demo license
- Demo floating license

### Floating license

The software may be installed for internal use on any number of devices by the licensee. Only the concurrent user is licensed. The concurrent user is the person using the program. Use begins when the software is started. A license is required for each concurrent user.

### Single license

Unlike the floating license, a single license permits only one installation of the software per license.

The type of use licensed is specified in the ordering data and in the Certificate of License (CoL). Types of use include for example per instance, per axis, per channel, etc.

One single license is required for each type of use defined.

### Rental license

A rental license supports the "sporadic use" of engineering software. Once the license key has been installed, the software can be used for a specific period of time (the operating hours do not have to be consecutive).

One license is required for each installation of the software.

### Rental floating license

The rental floating license corresponds to the rental license, except that a license is not required for each installation of the software. Rather, one license is required per object (for example, user or device).

### Trial license

A trial license supports "short-term use" of the software in a non-productive context, e.g. for testing and evaluation purposes. It can be transferred to another license.

### Demo license

The demo license support the "sporadic use" of engineering software in a non-productive context, for example, use for testing and evaluation purposes. It can be transferred to another license. After the installation of the license key, the software can be operated for a specific period of time, whereby usage can be interrupted as often as required.

One license is required per installation of the software.

### Demo floating license

The demo floating license corresponds to the demo license, except that a license is not required for each installation of the software. Rather, one license is required per object (for example, user or device).

### Certificate of license (CoL)

The CoL is the licensee's proof that the use of the software has been licensed by Siemens. A CoL is required for every type of use and must be kept in a safe place.

### Downgrading

The licensee is permitted to use the software or an earlier version/release of the software, provided that the licensee owns such a version/release and its use is technically feasible.

### Delivery versions

Software is constantly being updated. The following delivery versions

- PowerPack
- Upgrade

can be used to access updates.

Existing bug fixes are supplied with the ServicePack version.

### PowerPack

PowerPacks can be used to upgrade to more powerful software. The licensee receives a new license agreement and CoL (Certificate of License) with the PowerPack. This CoL, together with the CoL for the original product, proves that the new software is licensed.

A separate PowerPack must be purchased for each original license of the software to be replaced.

### Upgrade

An upgrade permits the use of a new version of the software on the condition that a license for a previous version of the product is already held.

The licensee receives a new license agreement and CoL with the upgrade. This CoL, together with the CoL for the previous product, proves that the new version is licensed.

A separate upgrade must be purchased for each original license of the software to be upgraded.

## Appendix

### Software Licenses

#### Overview

##### **ServicePack**

ServicePacks are used to debug existing products. ServicePacks may be duplicated for use as prescribed according to the number of existing original licenses.

##### **License key**

Siemens Industry Automation & Drive Technologies supplies software products with and without license keys.

The license key serves as an electronic license stamp and is also the "switch" for activating the software (floating license, rental license, etc.).

The complete installation of software products requiring license keys includes the program to be licensed (the software) and the license key (which represents the license).

##### **Software Update Service (SUS)**

As part of the SUS contract, all software updates for the respective product are made available to you free of charge for a period of one year from the invoice date. The contract will automatically be extended for one year if it is not canceled three months before it expires.

The possession of the current version of the respective software is a basic condition for entering into an SUS contract.

You can download explanations concerning license conditions from [www.siemens.com/automation/salesmaterial-as/catalog/en/terms\\_of\\_trade\\_en.pdf](http://www.siemens.com/automation/salesmaterial-as/catalog/en/terms_of_trade_en.pdf)

- A**
- Accessories
    - 8WA ..... 11/2
    - 8WH ..... 8/2
  - Actuator terminals ..... 10/4
  - ALPHA FIX PRINT
    - Printer labeling system ..... 8/2, 11/2
  - ALPHA FIX terminal blocks ..... 1/2
    - 8WA accessories ..... 11/2
    - 8WA screw terminals ..... 9/2
    - 8WA1 screw terminals ..... 9/2
    - 8WH accessories ..... 8/2
    - 8WH combination plug-in terminals ..... 5/2
    - 8WH iPo installation terminals ..... 3/2
    - 8WH iPo plug-in terminals ..... 2/2
    - 8WH spring-loaded terminals ..... 4/2, 4/3
    - 8WH1 screw terminals ..... 7/2
    - 8WH2 spring-loaded terminals ..... 4/2
    - 8WH3 insulation displacement terminals ..... 6/2
    - 8WH5 combination plug-in terminals ..... 5/2
    - 8WH6 iPo installation terminals ..... 3/2
    - 8WH6 iPo plug-in terminals ..... 2/2
    - Spring-loaded terminals ..... 1/2
- B**
- Barriers ..... 9/14, 9/18, 9/20, 9/23, 9/26, 9/29
  - Branch terminals 8WA ..... 9/15
  - Bridging links ..... 9/25
- C**
- Combination plug-in terminals 8WH ..... 5/2
  - Combs ..... 7/27
  - Compartment partitions ..... 2/10, 2/13, 2/15, 2/17, 4/17, 4/22, 4/24, 4/26, 4/32, 4/38, 4/40, 5/6, 5/7, 6/8, 6/10, 6/12
  - Connecting combs ..... 8/9
  - Connection bars ..... 9/14, 9/18, 9/20, 9/26, 9/29
  - Connection combs ..... 9/29
  - Connection modules ..... 10/4
  - Cover segments ..... 2/10, 4/17, 4/24, 4/26, 4/38, 6/8, 6/12
  - Covers ..... 2/10, 2/17, 3/5, 3/9, 3/14, 4/17, 4/20, 4/24, 4/26, 4/32, 4/36, 4/38, 4/40, 5/6, 5/7, 6/8, 6/10, 6/12, 9/13, 9/18, 9/20, 9/26
    - For connection bars ..... 9/16, 9/29
    - For screw terminals ..... 3/7, 3/11
    - For terminal size 2.5 mm<sup>2</sup> ..... 2/13, 2/15
    - For terminal size 4 mm<sup>2</sup> ..... 2/11, 2/13, 2/15, 2/17
    - For three-tier terminals ..... 4/34
- D**
- Device labels ..... 8/2, 11/2
  - Diode terminals ..... 4/37, 9/21, 9/23
  - Diode terminals 8WH ..... 7/20
  - Disconnecting links ..... 9/14, 9/20, 9/29
- E**
- End labeling plates ..... 11/4
  - End plates ..... 9/20, 9/22
  - End retainers
    - Steel ..... 11/5
    - Thermoplast ..... 9/13, 9/18
    - With screw fixing ..... 11/5
- F**
- Feeder terminals ..... 10/4
    - For N-busbars ..... 3/9, 3/14, 8/10, 9/16, 9/18
  - Four-tier motor terminals 8WH ..... 4/35
  - Fuse terminals 8WA ..... 9/25
  - Fuse terminals 8WH ..... 4/21, 7/8
- G**
- G fuse links ..... 9/25
- H**
- High-current terminals 8WH ..... 7/24
  - Hybrid through-type terminals 8WH ..... 4/18
  - Hybrid through-type terminals with iPo connection 8WH5 ..... 5/7
- I**
- Initiator terminals ..... 10/4
  - Initiator/actuator terminals 8WA ..... 10/2
  - Insertion profiles ..... 7/27
  - Insta terminal ..... 9/17
  - Installation terminals 8WH ..... 3/12
  - Instrument isolating terminals 8WA ..... 9/29
  - Insulation carriers ..... 11/5
    - For mounting insulated support rails ..... 9/18
  - Insulation displacement terminals 8WH3 ..... 6/2
  - Insulation plates ..... 9/14, 9/20, 9/29
  - iPo plug-in terminals 8WH ..... 2/2
  - Isolating blade terminal ..... 2/12
  - Isolating blade terminals 8WH ..... 4/23, 7/10
  - Isolating terminal ..... 9/28
  - Isolating terminal 8WH ..... 4/25, 6/11, 7/11
  - Isolating terminals 8WH6 ..... 2/14
- J**
- Jumpers ..... 9/13, 9/20
- L**
- Label holders ..... 9/16
    - For three-tier terminals ..... 4/34
  - Labeling system
    - Printer ~ ..... 8/2, 11/2
    - Standard ~ ..... 8/3, 11/3
  - Labels
    - Custom inscriptions ..... 11/4
    - Flat ..... 8/3, 8/4, 8/5, 8/6, 8/7
    - For manual labeling ..... 9/18, 11/3
    - Front ..... 8/3, 8/4, 8/5, 8/6, 8/7
    - Type 847/848 ..... 11/3
    - Type 860/861 ..... 11/3
  - Latches ..... 5/10
- M**
- Measuring transformer terminals 8WA ..... 7/17, 9/27
  - Modular test plugs ..... 8/8
  - Mounting accessories 8WA ..... 11/5
  - Mounting accessories 8WH ..... 8/8
  - Mounting brackets ..... 11/5
- N**
- N-busbars ..... 3/9, 3/11, 3/14, 7/31, 8/10
    - 6 × 6 mm ..... 9/16, 9/18
  - N-conductor isolating 8WH ..... 3/8, 3/10
  - N-conductor isolating terminals ..... 9/15

# Appendix

## Subject index

<b>P</b>		<b>T</b>	
PE high-current terminals 8WH	7/24	Tap-off terminals	7/27
PE hybrid through-type terminals 8WH	4/18	Terminal	
PE plugs 8WH9	5/8	• For components	9/24
PE through-type terminals	4/7–4/17	• With red LED	9/22
• With screw terminals	3/6	Terminal strip labels	9/18, 11/4
PE through-type terminals 8WA	9/9–9/13	Terminal strip markers	
PE through-type terminals 8WH	5/7, 6/5	• For end retainers	8/8
PE through-type terminals 8WH5	5/5	Terminals	3/11
PE two-tier terminals 8WH	4/27–4/32, 6/9	Test adapters	8/8
Permanent links	7/27	Test sockets	9/29
Plug-in zone connectors		Three-tier terminal 8WA	9/17
• For isolating terminals	8/10	Through-type terminals	3/4, 9/28
Plugs		• With sectionalizing feature	9/23
• For components	9/24	Through-type terminals 8WA	9/9
Plugs 8WH9	5/8	• With soldered and plug-in connection	9/26
Printer labeling system		Through-type terminals 8WH	3/4, 4/7, 5/7, 6/5, 7/4
• ALPHA FIX PRINT	8/2, 11/2	• With screw terminals	3/6
<b>Q</b>		Through-type terminals 8WH5	5/5
Quick-fit end retainers	8/8	Through-type terminals 8WH6	2/4
<b>R</b>		Two-tier diode terminals 8WH	4/39, 7/21
Reducing combs	8/8	Two-tier terminals 8WA	9/19
<b>S</b>		• With electronic components	9/21
Screw terminals 8WA1	9/2	Two-tier terminals 8WH	4/27, ??–4/32, 6/9, 7/12
Screw terminals 8WH1	7/2	• With isolating blade	7/15
Screwdrivers	8/9	• With isolating function	7/15
• For 8WA2	11/5	Two-tier terminals 8WH6	2/16
Shield terminals 8WH	7/28	<b>W</b>	
Spacer brackets	11/5	Warning covers	4/17
Spacer plates	8/8	<b>Z</b>	
Spacers	11/5	Zener diode terminals	9/22
Spring-loaded terminals	1/2		
Spring-loaded terminals 8WH	4/2		
Standard labeling system	8/3, 11/3		
Standard mounting rails	11/5		
Support brackets	3/5, 3/9, 3/14, 7/31		



## Overview

Article No.	Page	Export markings	
		ECCN	AL
<b>3T</b>			
3TX4210-0J	9/15, 9/16	N	N
<b>5T</b>			
5ST1141	11/5	N	N
5ST1142	11/5	N	N
5ST1145	11/5	N	N
<b>8GF</b>			
8GF9324-2	9/15, 9/16, 9/18	N	N
<b>8WA1</b>			
8WA1010-1PH01	9/11	N	N
8WA1010-1PQ00	7/26	N	N
8WA1011-0DF21	9/9	N	N
8WA1011-0DF22	9/9	N	N
8WA1011-0DG21	9/10	N	N
8WA1011-0DG22	9/10	N	N
8WA1011-1BF21	9/9	N	N
8WA1011-1BF22	9/9	N	N
8WA1011-1BF23	9/9	N	N
8WA1011-1BF24	9/9	N	N
8WA1011-1BF25	9/9	N	N
8WA1011-1BF26	9/9	N	N
8WA1011-1BG11	9/10	N	N
8WA1011-1BG21	9/10	N	N
8WA1011-1BG22	9/10	N	N
8WA1011-1BG24	9/10	N	N
8WA1011-1BH23	9/11	N	N
8WA1011-1BH24	9/11	N	N
8WA1011-1BK11	9/12	N	N
8WA1011-1BM11	9/12	N	N
8WA1011-1BP11	9/13	N	N
8WA1011-1DF11	9/9	N	N
8WA1011-1DG11	9/10	N	N
8WA1011-1DH11	9/11	N	N
8WA1011-1EE00	9/24	N	N
8WA1011-1EF20	9/23	N	N
8WA1011-1MH10	9/28	N	N
8WA1011-1MH11	9/28	N	N
8WA1011-1MH15	9/29	N	N
8WA1011-1NF01	9/15	N	N
8WA1011-1NG31	9/15	N	N
8WA1011-1NH01	9/16	N	N
8WA1011-1PF00	9/9	N	N
8WA1011-1PF01	9/9	N	N
8WA1011-1PG00	9/10	N	N
8WA1011-1PG01	9/10	N	N
8WA1011-1PH00	9/11	N	N
8WA1011-1PK00	9/12	N	N
8WA1011-1PM00	9/13	N	N
8WA1011-1SF12	9/25	N	N
8WA1011-1SF13	9/25	N	N
8WA1011-1SF15	9/25	N	N
8WA1011-1SF30	9/25	N	N
8WA1011-1SF31	9/25	N	N
8WA1011-1SF32	9/25	N	N
8WA1011-2BG11	9/19	N	N

Article No.	Page	Export markings	
		ECCN	AL
8WA1011-2DG11	9/19	N	N
8WA1011-3DF21	9/9	N	N
8WA1011-3DG21	9/10	N	N
8WA1011-3DH21	9/11	N	N
8WA1011-3JF16	9/17	N	N
8WA1011-3JF17	9/17	N	N
8WA1011-3JF18	9/17	N	N
8WA1011-3JF20	9/17	N	N
8WA1011-6BG11	9/19	N	N
8WA1011-6DG11	9/19	N	N
8WA1011-6EG20	9/21	N	N
8WA1011-6EG22	9/21	N	N
8WA1011-6EG23	9/21	N	N
8WA1011-6EG24	9/21	N	N
8WA1011-6EG25	9/22	N	N
8WA1011-6EG44	9/22	N	N
8WA1204	9/12	N	N
8WA1205	9/12	N	N
8WA1206	9/13	N	N
8WA1216	9/13, 9/14	N	N
8WA1221	9/26	N	N
8WA1304	9/12	N	N
8WA1305	9/12	N	N
8WA1501	9/23	N	N
8WA1604	9/16	N	N
8WA1802	9/12, 9/14	N	N
8WA1803	9/12, 9/14	N	N
8WA1804	9/12, 9/14	N	N
8WA1805	11/5	N	N
8WA1806	11/4	N	N
8WA1808	9/13, 9/18, 11/5	N	N
8WA1810	9/9, 9/13, 9/26	N	N
8WA1811	9/10, 9/11, 9/13, 9/18, 9/19, 9/20, 9/26	N	N
8WA1812	9/12, 9/13	N	N
8WA1813	9/12, 9/13	N	N
8WA1814	9/13	N	N
8WA1817	9/19, 9/20, 9/21, 9/22	N	N
8WA1820	9/9, 9/10, 9/14, 9/23, 9/26	N	N
8WA1821	9/11, 9/12, 9/14, 9/26	N	N
8WA1822-7AX00	9/15, 9/16	N	N
8WA1822-7AX01	9/9, 9/10, 9/11, 9/13, 9/18, 9/19, 9/20, 9/28, 9/29	N	N
8WA1822-7AX02	9/12, 9/13	N	N
8WA1822-7AX03	9/9, 9/10, 9/13, 9/28, 9/29	N	N
8WA1822-7AX03	9/18	N	N
8WA1822-7EE00	9/24	N	N
8WA1822-7EF16	9/25	N	N
8WA1822-7EF18	9/25	N	N
8WA1822-7EF21	9/25	N	N
8WA1822-7EF23	9/25	N	N
8WA1822-7EF25	9/25	N	N
8WA1822-7EF76	9/25	N	N
8WA1822-7EF78	9/25	N	N
8WA1822-7EF81	9/25	N	N
8WA1822-7EF83	9/25	N	N

## Appendix

## Article No. index incl. export markings

Article No.	Page	Export markings	
		ECCN	AL
8WA1822-7EF85	9/25	N	N
8WA1822-7PH00	9/28, 9/29	N	N
8WA1822-7TH00	9/17, 9/18, 9/28, 9/29	N	N
8WA1822-7TK00	9/12, 9/14	N	N
8WA1822-7VF01	9/9, 9/13	N	N
8WA1822-7VF02	9/18	N	N
8WA1822-7VF03	9/18	N	N
8WA1822-7VF10	9/18	N	N
8WA1822-7VG00	9/10, 9/13, 9/19, 9/20	N	N
8WA1822-7VG01	9/19, 9/20	N	N
8WA1822-7VH00	9/11, 9/13	N	N
8WA1822-7VH01	9/29	N	N
8WA1822-7VH10	9/28, 9/29	N	N
8WA1822-7VH12	9/26	N	N
8WA1822-7VH20	9/26	N	N
8WA1822-7VH22	9/28, 9/29	N	N
8WA1823	9/12, 9/13, 9/14, 9/19, 9/20	N	N
8WA1824	9/13, 9/14	N	N
8WA1825	9/9, 9/10, 9/11, 9/14, 9/19, 9/20, 9/28, 9/29	N	N
8WA1828	9/12, 9/14	N	N
8WA1835	9/19, 9/20	N	N
8WA1838	9/19, 9/20	N	N
8WA1842	9/12, 9/14	N	N
8WA1845	9/12, 9/14	N	N
8WA1848	9/12, 9/14	N	N
8WA1850	9/10, 9/14, 9/19, 9/20	N	N
8WA1851	9/10, 9/14, 9/19, 9/20	N	N
8WA1852	9/10, 9/14, 9/19, 9/20	N	N
8WA1853	9/10, 9/14, 9/19, 9/20	N	N
8WA1857	9/18, 11/5	N	N
8WA1860	9/9, 9/13, 9/26	N	N
8WA1862	9/10, 9/11, 9/13, 9/18, 9/19, 9/20, 9/26	N	N
8WA1865	9/9, 9/10, 9/11, 9/14, 9/19, 9/20	N	N
8WA1885	9/11, 9/14, 9/28, 9/29	N	N
8WA1886	9/11, 9/14, 9/28, 9/29	N	N
8WA1887	9/11, 9/14, 9/28, 9/29	N	N
8WA1888	9/11, 9/14, 9/28, 9/29	N	N
8WA1891	9/25	N	N
8WA1892	9/12, 9/13	N	N
8WA1893	9/12, 9/13	N	N
8WA1895	9/9, 9/14	N	N
8WA1896	9/9, 9/14	N	N
8WA1897	9/9, 9/14	N	N
8WA1898	9/9, 9/14	N	N
<b>8WA2</b>			
8WA2011-3KE00	10/4	N	N
8WA2011-3KE01	10/4	N	N
8WA2011-3KE02	10/4	N	N
8WA2011-3KE10	10/4	N	N
8WA2011-3KE11	10/4	N	N
8WA2011-3KE12	10/4	N	N
8WA2011-3KE13	10/4	N	N
8WA2011-3KE30	10/4	N	N
8WA2011-3KE31	10/4	N	N

Article No.	Page	Export markings	
		ECCN	AL
8WA2011-3KE33	10/4	N	N
8WA2011-3KE50	10/4	N	N
8WA2011-3KE51	10/4	N	N
8WA2842	3/9, 3/11, 3/14, 7/31, 8/10	N	N
8WA2867	3/9, 3/14, 8/10, 9/15, 9/16, 9/18	N	N
8WA2868	3/9, 3/14, 8/10, 9/16, 9/18	N	N
8WA2870	3/9, 3/14, 8/10, 9/16, 9/18	N	N
8WA2880	11/5	N	N
<b>8WA7</b>			
8WA7163	9/28, 9/29	N	N
8WA746	11/5	N	N
8WA752	11/5	N	N
8WA753	11/5	N	N
8WA7551	11/5	N	N
<b>8WA8</b>			
8WA8212-0AA65	9/18, 11/4	EAR99	N
8WA8310-2AY	11/3	N	N
8WA8347-□□□	11/3		
8WA8347-0XA	11/4	N	N
8WA8348-□□□	11/3		
8WA8348-0XA	11/4	N	N
8WA8348-2AY	9/18, 11/3	EAR99	N
8WA8360-□□□	11/3		
8WA8361-□□□	11/3		
8WA8826-0AA	11/4	N	N
8WA8826-0AB	11/4	N	N
8WA8826-0AC	11/4	N	N
8WA8850-2AY	11/2	N	N
8WA8851-2AY	11/2	N	N
<b>8WH1</b>			
8WH1000-0AF00	7/5	N	N
8WH1000-0AF01	7/5	N	N
8WH1000-0AF02	7/5	N	N
8WH1000-0AF03	7/5	N	N
8WH1000-0AF04	7/5	N	N
8WH1000-0AF06	7/5	N	N
8WH1000-0AF08	7/5	N	N
8WH1000-0AG00	7/5	N	N
8WH1000-0AG01	7/5	N	N
8WH1000-0AG02	7/5	N	N
8WH1000-0AG04	7/5	N	N
8WH1000-0AG08	7/5	N	N
8WH1000-0AH00	7/6	N	N
8WH1000-0AH01	7/6	N	N
8WH1000-0AH02	7/6	N	N
8WH1000-0AH08	7/6	N	N
8WH1000-0AJ00	7/6	N	N
8WH1000-0AJ01	7/6	N	N
8WH1000-0AK00	7/6	N	N
8WH1000-0AK01	7/6	N	N
8WH1000-0AM00	7/7	N	N
8WH1000-0AM01	7/7	N	N
8WH1000-0AN00	7/26	N	N
8WH1000-0AN01	7/26	N	N
8WH1000-0AQ00	7/26	N	N
8WH1000-0AQ01	7/26	N	N

## Article No. index incl. export markings

Article No.	Page	Export markings	
		ECCN	AL
8WH1000-0AS00	7/27	N	N
8WH1000-0AS01	7/27	N	N
8WH1000-0AU00	7/27	N	N
8WH1000-0AU01	7/27	N	N
8WH1000-0CF07	7/5	N	N
8WH1000-0CG07	7/5	N	N
8WH1000-0CH07	7/6	N	N
8WH1000-0CJ07	7/6	N	N
8WH1000-0CK07	7/7	N	N
8WH1000-0CM07	7/7	N	N
8WH1000-0CN07	7/26	N	N
8WH1000-0CQ07	7/26	N	N
8WH1000-1GG08	7/9	N	N
8WH1000-1HH08	7/9	N	N
8WH1000-1KG38	7/9	N	N
8WH1000-1MG88	7/9	N	N
8WH1000-1PH38	7/9	N	N
8WH1000-6AG00	7/11	N	N
8WH1000-6AH00	7/11	N	N
8WH1000-6CG00	7/10	N	N
8WH1000-6KG00	7/20	N	N
8WH1000-6LG00	7/20	N	N
8WH1000-7AH00	7/18	N	N
8WH1000-7BH00	7/18	N	N
8WH1001-0AK00	3/6	N	N
8WH1001-0AK01	3/6	N	N
8WH1001-0AM00	3/7	N	N
8WH1001-0AM01	3/7	N	N
8WH1001-0BJ01	3/11	N	N
8WH1001-0BK01	3/11	N	N
8WH1001-0BM01	3/11	N	N
8WH1001-0CK07	3/7	N	N
8WH1001-0CM07	3/7	N	N
8WH1020-0AF00	7/13	N	N
8WH1020-0AF01	7/13	N	N
8WH1020-0AG00	7/14	N	N
8WH1020-0AG01	7/14	N	N
8WH1020-0CF07	7/13	N	N
8WH1020-0CG07	7/14	N	N
8WH1020-5AF00	7/22	N	N
8WH1020-5BF00	7/22	N	N
8WH1020-5DF00	7/22	N	N
8WH1020-5FF00	7/22	N	N
8WH1020-5HF00	7/22	N	N
8WH1020-5JF30	7/22	N	N
8WH1020-5LF00	7/23	N	N
8WH1020-6AC00	7/16	N	N
8WH1020-6AG00	7/16	N	N
8WH1025-0AF00	7/13	N	N
8WH1025-0AG00	7/14	N	N
<b>8WH2</b>			
8WH2000-0AE00	4/10	N	N
8WH2000-0AE01	4/10	N	N
8WH2000-0AE02	4/10	N	N
8WH2000-0AE03	4/10	N	N
8WH2000-0AE04	4/10	N	N

Article No.	Page	Export markings	
		ECCN	AL
8WH2000-0AE05	4/10	N	N
8WH2000-0AE06	4/10	N	N
8WH2000-0AE08	4/10	N	N
8WH2000-0AF00	4/11	N	N
8WH2000-0AF01	4/11	N	N
8WH2000-0AF02	4/11	N	N
8WH2000-0AF03	4/11	N	N
8WH2000-0AF04	4/11	N	N
8WH2000-0AF05	4/11	N	N
8WH2000-0AF06	4/11	N	N
8WH2000-0AF08	4/11	N	N
8WH2000-0AG00	4/13	N	N
8WH2000-0AG01	4/13	N	N
8WH2000-0AG02	4/13	N	N
8WH2000-0AG03	4/13	N	N
8WH2000-0AG04	4/13	N	N
8WH2000-0AG05	4/13	N	N
8WH2000-0AG06	4/13	N	N
8WH2000-0AG08	4/13	N	N
8WH2000-0AH00	4/15	N	N
8WH2000-0AH01	4/15	N	N
8WH2000-0AJ00	4/15	N	N
8WH2000-0AJ01	4/15	N	N
8WH2000-0AK00	4/16	N	N
8WH2000-0AK01	4/16	N	N
8WH2000-0AM00	4/17	N	N
8WH2000-0AM01	4/17	N	N
8WH2000-0CE07	4/10	N	N
8WH2000-0CF07	4/12	N	N
8WH2000-0CG07	4/14	N	N
8WH2000-0CH07	4/15	N	N
8WH2000-0CJ07	4/16	N	N
8WH2000-0CK07	4/16	N	N
8WH2000-0CM07	4/17	N	N
8WH2000-1AG08	4/22	N	N
8WH2000-1BG28	4/22	N	N
8WH2000-1BG38	4/22	N	N
8WH2000-1GG08	4/22	N	N
8WH2000-1HG08	4/22	N	N
8WH2000-1JG38	4/22	N	N
8WH2000-1JG68	4/22	N	N
8WH2000-1MG08	4/22	N	N
8WH2000-1RG08	4/22	N	N
8WH2000-6AF00	4/26	N	N
8WH2000-6AG00	4/26	N	N
8WH2000-6CF00	4/24	N	N
8WH2000-6CG00	4/24	N	N
8WH2003-0AE00	4/10	N	N
8WH2003-0AE01	4/10	N	N
8WH2003-0AF00	4/11	N	N
8WH2003-0AF01	4/11	N	N
8WH2003-0AF04	4/10, 4/11	N	N
8WH2003-0AG00	4/13	N	N
8WH2003-0AG01	4/13	N	N
8WH2003-0AH00	4/15	N	N
8WH2003-0AH01	4/15	N	N

## Appendix

## Article No. index incl. export markings

Article No.	Page	Export markings	
		ECCN	AL
8WH2003-0CE07	4/10	N	N
8WH2003-0CF07	4/12	N	N
8WH2003-0CG07	4/14	N	N
8WH2003-0CH07	4/15	N	N
8WH2003-5CF00	4/38	N	N
8WH2003-5DF00	4/38	N	N
8WH2003-6AF00	4/26	N	N
8WH2003-6CF00	4/24	N	N
8WH2004-0AE00	4/10	N	N
8WH2004-0AE01	4/10	N	N
8WH2004-0AF00	4/11	N	N
8WH2004-0AF01	4/11	N	N
8WH2004-0AF04	4/10, 4/11	N	N
8WH2004-0AG00	4/13	N	N
8WH2004-0AG01	4/13	N	N
8WH2004-0CE07	4/10	N	N
8WH2004-0CF07	4/12	N	N
8WH2004-0CG07	4/14	N	N
8WH2004-6AF00	4/26	N	N
8WH2004-6CF00	4/24	N	N
8WH2020-0AE00	4/29	N	N
8WH2020-0AE01	4/29	N	N
8WH2020-0AF00	4/30	N	N
8WH2020-0AF01	4/30	N	N
8WH2020-0AG00	4/32	N	N
8WH2020-0AG01	4/32	N	N
8WH2020-0CE07	4/29	N	N
8WH2020-0CF07	4/31	N	N
8WH2020-0CG07	4/32	N	N
8WH2020-4AF00	4/30	N	N
8WH2020-4BF00	4/31	N	N
8WH2020-4CF00	4/31	N	N
8WH2020-5AF00	4/39	N	N
8WH2020-5BF00	4/39	N	N
8WH2020-5DF00	4/39	N	N
8WH2020-5EF00	4/40	N	N
8WH2020-5GF00	4/40	N	N
8WH2020-5HF00	4/40	N	N
8WH2020-5JF30	4/40	N	N
8WH2020-5JF80	4/40	N	N
8WH2020-5KF00	4/40	N	N
8WH2022-0AF00	4/30	N	N
8WH2023-0AF00	4/30	N	N
8WH2023-0AF01	4/30	N	N
8WH2023-0CF07	4/31	N	N
8WH2025-0AE00	4/29	N	N
8WH2025-0AF00	4/30	N	N
8WH2025-0AF01	4/30	N	N
8WH2025-0AG00	4/32	N	N
8WH2030-0AF00	4/33	N	N
8WH2030-0AF01	4/33	N	N
8WH2030-4EF00	4/34	N	N
8WH2030-4HF00	4/34	N	N
8WH2035-0AF00	4/34	N	N
8WH2035-0CF07	4/34	N	N
8WH2040-4LF00	4/36	N	N

Article No.	Page	Export markings	
		ECCN	AL
8WH2040-4LG00	4/36	N	N
8WH2103-2BF00	4/19	N	N
8WH2103-2BF01	4/19	N	N
8WH2103-2BG00	4/20	N	N
8WH2103-2BG01	4/20	N	N
8WH2103-3BF07	4/19	N	N
8WH2103-3BG07	4/20	N	N
<b>8WH3</b>			
8WH3000-0AE00	6/6	N	N
8WH3000-0AE01	6/6	N	N
8WH3000-0AF00	6/7	N	N
8WH3000-0AF01	6/7	N	N
8WH3000-0CE07	6/6	N	N
8WH3000-0CF07	6/7	N	N
8WH3000-6AE00	6/11	N	N
8WH3000-6AF00	6/12	N	N
8WH3003-0AE00	6/6	N	N
8WH3003-0AE01	6/6	N	N
8WH3003-0AF00	6/7	N	N
8WH3003-0AF01	6/7	N	N
8WH3003-0CE07	6/6	N	N
8WH3003-0CF07	6/7	N	N
8WH3004-0AE00	6/6	N	N
8WH3004-0AE01	6/6	N	N
8WH3004-0CE07	6/6	N	N
8WH3020-0AE00	6/10	N	N
8WH3020-0AE01	6/10	N	N
8WH3020-0CE07	6/10	N	N
<b>8WH5</b>			
8WH5000-0AF00	5/6	N	N
8WH5000-0AF01	5/6	N	N
8WH5000-0CF07	5/6	N	N
8WH5100-2PF00	5/7	N	N
8WH5100-3PF07	5/7	N	N
<b>8WH6</b>			
8WH6000-0AF00	2/6	N	N
8WH6000-0AF01	2/6	N	N
8WH6000-0AG00	2/7	N	N
8WH6000-0AG01	2/7	N	N
8WH6000-0AH00	2/8	N	N
8WH6000-0AH01	2/8	N	N
8WH6000-0AJ00	2/8	N	N
8WH6000-0AJ01	2/8	N	N
8WH6000-0AK00	2/9	N	N
8WH6000-0AK01	2/9	N	N
8WH6000-0AM00	2/9	N	N
8WH6000-0AM01	2/9	N	N
8WH6000-0CF07	2/7	N	N
8WH6000-0CG07	2/7	N	N
8WH6000-0CH07	2/8	N	N
8WH6000-0CJ07	2/8	N	N
8WH6000-0CK07	2/9	N	N
8WH6000-0CM07	2/9	N	N
8WH6000-1GG08	2/11	N	N
8WH6000-1KG38	2/11	N	N
8WH6000-1MG88	2/11	N	N

## Article No. index incl. export markings

Article No.	Page	Export markings	
		ECCN	AL
8WH6000-6AF00	2/13	N	N
8WH6000-6AG00	2/15	N	N
8WH6000-6CF00	2/15	N	N
8WH6000-6CG00	2/13	N	N
8WH6001-0AF00	3/4	N	N
8WH6001-0AF01	3/4	N	N
8WH6001-0AG00	3/5	N	N
8WH6001-0AG01	3/5	N	N
8WH6001-0AH00	3/5	N	N
8WH6001-0AH01	3/5	N	N
8WH6001-0BF01	3/9	N	N
8WH6001-0BG01	3/9	N	N
8WH6001-0BH01	3/9	N	N
8WH6001-0CF07	3/4	N	N
8WH6001-0CG07	3/5	N	N
8WH6001-0CH07	3/5	N	N
8WH6001-4CF00	3/13	N	N
8WH6001-4DF00	3/13	N	N
8WH6001-4EF00	3/13	N	N
8WH6001-4FF00	3/13	N	N
8WH6001-4GF00	3/13	N	N
8WH6001-4HF00	3/13	N	N
8WH6001-4MF00	3/13	N	N
8WH6001-4NF00	3/13	N	N
8WH6001-4PF00	3/13	N	N
8WH6001-4QF00	3/13	N	N
8WH6003-0AF00	2/6	N	N
8WH6003-0AF01	2/6	N	N
8WH6003-0AG00	2/7	N	N
8WH6003-0AG01	2/7	N	N
8WH6003-0CF07	2/7	N	N
8WH6003-0CG07	2/7	N	N
8WH6003-6AF00	2/13	N	N
8WH6003-6CF00	2/15	N	N
8WH6004-0AF00	2/6	N	N
8WH6004-0AF01	2/6	N	N
8WH6004-0AG00	2/7	N	N
8WH6004-0AG01	2/7	N	N
8WH6004-0CF07	2/7	N	N
8WH6004-0CG07	2/7	N	N
8WH6004-6AF00	2/13	N	N
8WH6004-6CF00	2/15	N	N
8WH6020-0AF00	2/17	N	N
8WH6020-0AF01	2/17	N	N
8WH6020-0AG00	2/17	N	N
8WH6020-0AG01	2/17	N	N
8WH6020-0CF07	2/17	N	N
8WH6020-0CG07	2/17	N	N
8WH6025-0AF00	2/17	N	N
8WH6025-0AG00	2/17	N	N
<b>8WH8</b>			
8WH8110-1AA05	8/3	N	N
8WH8110-2AA05	8/4	N	N
8WH8110-3AA05	8/5	N	N
8WH8110-4AA05	8/6	N	N
8WH8110-5AA05	8/7	N	N

Article No.	Page	Export markings	
		ECCN	AL
8WH8110-7AA05	8/7	N	N
8WH8111-1AA05	8/3	N	N
8WH8111-2AA05	8/4	N	N
8WH8111-3AA05	8/5	N	N
8WH8111-4AA05	8/6	N	N
8WH8111-5AA05	8/7	N	N
8WH8111-7AA05	8/7	N	N
8WH8112-1AA05	8/2	N	N
8WH8112-2AA05	8/2	N	N
8WH8112-4AA05	8/2	N	N
8WH8113-1AA05	8/2	N	N
8WH8113-6AA05	8/2	N	N
8WH8120-1A□□□	8/3	N	N
8WH8120-1XA05	8/3	N	N
8WH8120-2A□□□	8/4	N	N
8WH8120-2XA05	8/4	N	N
8WH8120-3A□□□	8/5	N	N
8WH8120-3XA05	8/5	N	N
8WH8120-4A□□□	8/6	N	N
8WH8120-4XA05	8/6	N	N
8WH8120-5A□□□	8/7	N	N
8WH8120-5XA05	8/7	N	N
8WH8120-7AA15	8/7	N	N
8WH8120-7XA05	8/7	N	N
8WH8121-1A□□□	8/3	N	N
8WH8121-1XA05	8/3	N	N
8WH8121-2A□□□	8/4	N	N
8WH8121-2XA05	8/4	N	N
8WH8121-3A□□□	8/5	N	N
8WH8121-3XA05	8/5	N	N
8WH8121-4A□□□	8/6	N	N
8WH8121-4XA05	8/6	N	N
8WH8121-5A□□□	8/7	N	N
8WH8121-5XA05	8/7	N	N
8WH8140-1A□□□	8/3	N	N
8WH8140-1XA05	8/3	N	N
8WH8140-2A□□□	8/4	N	N
8WH8140-2XA05	8/4	N	N
8WH8140-3A□□□	8/5	N	N
8WH8140-3XA05	8/5	N	N
8WH8140-4A□□□	8/6	N	N
8WH8140-4XA05	8/6	N	N
8WH8140-5A□□□	8/7	N	N
8WH8140-5XA05	8/7	N	N
8WH8140-7XA05	8/7	N	N
8WH8141-1A□□□	8/3	N	N
8WH8141-1XA05	8/3	N	N
8WH8141-2A□□□	8/4	N	N
8WH8141-2XA05	8/4	N	N
8WH8141-3AB05	8/5	N	N
8WH8141-3XA05	8/5	N	N
8WH8141-4A□□□	8/6	N	N
8WH8141-4XA05	8/6	N	N
8WH8141-5AB05	8/7	N	N
8WH8141-5XA05	8/7	N	N
8WH8210-0AA35	8/2, 11/2	N	N

## Appendix

## Article No. index incl. export markings

Article No.	Page	Export markings	
		ECCN	AL
8WH8210-0AA36	8/2, 11/2	N	N
8WH8210-0AA45	8/2, 11/2	N	N
8WH8210-0AA46	8/2, 11/2	N	N
8WH8210-0AA55	8/2, 11/2	N	N
8WH8210-0AA56	8/2, 11/2	N	N
<b>8WH9</b>			
8WH9000-0AA00	6/8, 6/12	N	N
8WH9000-0GA00	2/10, 4/17, 4/24, 4/26, 4/38	N	N
8WH9000-1AA00	6/8	N	N
8WH9000-1GA00	2/10, 4/17, 5/6, 5/7	N	N
8WH9000-1GD00	4/34	N	N
8WH9000-1GE00	4/36	N	N
8WH9000-1PA00	7/7	N	N
8WH9000-1QA00	7/14, 7/16, 7/23	N	N
8WH9000-1SA00	3/9	N	N
8WH9000-1VA00	4/32, 4/40	N	N
8WH9000-1WA00	3/5	N	N
8WH9000-2AA00	6/8, 6/12	N	N
8WH9000-2GA00	2/10, 4/17, 4/24, 4/26	N	N
8WH9000-2HA00	4/20	N	N
8WH9000-2PA00	7/20	N	N
8WH9000-2VA00	4/32	N	N
8WH9000-3SA00	3/14	N	N
8WH9000-3SC00	2/13, 2/15	N	N
8WH9000-3SD00	2/13, 2/15	N	N
8WH9000-3UA00	7/19	N	N
8WH9000-4GA00	2/10, 4/17, 4/24, 4/26, 4/38	N	N
8WH9000-4SE00	2/17	N	N
8WH9000-5GA00	2/13, 2/15, 4/24, 4/26	N	N
8WH9000-6SA00	3/14	N	N
8WH9001-0AA00	6/12	N	N
8WH9001-1AA00	6/8	N	N
8WH9001-1BA00	6/10	N	N
8WH9001-2AA00	6/8, 6/12	N	N
8WH9001-4AA00	6/8	N	N
8WH9002-8AC10	7/7, 7/9	N	N
8WH9002-8BC10	7/7	N	N
8WH9002-8CC10	7/7	N	N
8WH9002-8DC10	7/7	N	N
8WH9002-8EC10	7/7	N	N
8WH9002-8FC10	7/7	N	N
8WH9002-8GC10	7/7	N	N
8WH9002-8HC10	7/7	N	N
8WH9003-0GA00	4/17	N	N
8WH9003-1GA00	2/10, 2/11, 2/13, 2/15, 4/17	N	N
8WH9003-1SA00	3/9	N	N
8WH9003-1VA00	2/17, 4/32	N	N
8WH9003-2GA00	4/17	N	N
8WH9003-2HA00	4/20	N	N
8WH9003-2SA00	2/10	N	N
8WH9003-4GA00	4/17	N	N
8WH9003-4SA00	2/10	N	N
8WH9003-7WA00	3/5	N	N
8WH9004-1GA00	4/17	N	N
8WH9004-1SA00	3/9	N	N
8WH9004-1WA00	3/5	N	N

Article No.	Page	Export markings	
		ECCN	AL
8WH9004-2GA00	4/17	N	N
8WH9004-3SA00	2/10	N	N
8WH9005-1GA00	4/17	N	N
8WH9005-1SA00	2/10	N	N
8WH9005-3PA00	3/7, 3/11	N	N
8WH9006-1GA00	4/17	N	N
8WH9006-1SA00	2/10	N	N
8WH9010-0BC08	7/19	N	N
8WH9010-0EB02	8/8	N	N
8WH9010-0FB02	8/8	N	N
8WH9010-0JB00	8/8	N	N
8WH9010-0MB03	7/19	N	N
8WH9010-0MB06	7/19	N	N
8WH9010-0MB11	7/19	N	N
8WH9010-0MB12	7/19	N	N
8WH9010-2BA02	8/8	N	N
8WH9010-2CA02	8/8	N	N
8WH9020-0AC10	8/8	N	N
8WH9020-0BC10	8/8	N	N
8WH9020-0CC10	8/8	N	N
8WH9020-0DC10	8/8	N	N
8WH9020-0EC10	8/8	N	N
8WH9020-0FC10	8/8	N	N
8WH9020-3AA00	7/27	N	N
8WH9020-3BA00	7/27	N	N
8WH9020-3CA00	7/27	N	N
8WH9020-3DA00	7/27	N	N
8WH9020-3EA00	7/27	N	N
8WH9020-3FA00	7/27	N	N
8WH9020-3MA00	7/27	N	N
8WH9020-3NA00	7/27	N	N
8WH9020-3PA00	7/27	N	N
8WH9020-6AC10	8/9	N	N
8WH9020-6AD10	8/9	N	N
8WH9020-6AE10	8/9	N	N
8WH9020-6AF10	8/9	N	N
8WH9020-6AL10	8/9	N	N
8WH9020-6AS10	8/9	N	N
8WH9020-6BC10	8/9	N	N
8WH9020-6BD10	8/9	N	N
8WH9020-6BE10	8/9	N	N
8WH9020-6BF10	8/9	N	N
8WH9020-6BL10	8/9	N	N
8WH9020-6BS10	8/9	N	N
8WH9020-6BT10	8/9	N	N
8WH9020-6CC10	8/9	N	N
8WH9020-6CD10	8/9	N	N
8WH9020-6CE10	8/9	N	N
8WH9020-6CF10	8/9	N	N
8WH9020-6CL10	8/9	N	N
8WH9020-6CS10	8/9	N	N
8WH9020-6CT10	8/9	N	N
8WH9020-6DC10	8/9	N	N
8WH9020-6DD10	8/9	N	N
8WH9020-6DE10	8/9	N	N
8WH9020-6DF10	8/9	N	N

## Article No. index incl. export markings

Article No.	Page	Export markings	
		ECCN	AL
8WH9020-6DL10	8/9	N	N
8WH9020-6EC10	8/9	N	N
8WH9020-6FC10	8/9	N	N
8WH9020-6GC10	8/9	N	N
8WH9020-6HC00	7/27	N	N
8WH9020-6HD00	7/27	N	N
8WH9020-8AB00	8/10	N	N
8WH9021-0AC00	7/19	N	N
8WH9021-0AL00	7/19	N	N
8WH9030-6AL00	3/7	N	N
8WH9030-6BC00	3/7	N	N
8WH9030-6BD00	3/7	N	N
8WH9040-0BB00	8/10	N	N
8WH9040-0DB04	8/10	N	N
8WH9040-1AB00	5/9	N	N
8WH9040-1AB01	5/9	N	N
8WH9040-1AB07	5/9	N	N
8WH9040-1BB00	5/9	N	N
8WH9040-1BB01	5/9	N	N
8WH9040-1CB00	5/9	N	N
8WH9040-1CB01	5/9	N	N
8WH9040-1CB07	5/9	N	N
8WH9040-1DB00	5/9	N	N
8WH9040-1DB01	5/9	N	N
8WH9040-1DB07	5/9	N	N
8WH9040-1EB00	5/9	N	N
8WH9040-1EB01	5/9	N	N
8WH9040-1EB07	5/9	N	N
8WH9040-1FB00	5/9	N	N
8WH9040-1FB01	5/9	N	N
8WH9040-1FB07	5/9	N	N
8WH9040-3AB08	8/10	N	N
8WH9040-3CB08	8/10	N	N
8WH9040-3DB08	8/10	N	N
8WH9050-2AA04	5/10	N	N
8WH9050-2BA04	5/10	N	N
8WH9060-4BA00	4/34	N	N
8WH9060-5AA06	4/17	N	N
8WH9060-5BA06	7/7	N	N
8WH9061-5AA06	4/17	N	N
8WH9063-5AA06	4/17	N	N
8WH9063-5BA06	7/7, 7/10, 7/20	N	N
8WH9064-5AA06	4/17	N	N
8WH9064-5BA06	7/7	N	N
8WH9065-5AA06	4/17	N	N
8WH9065-5BA06	7/7	N	N
8WH9066-5AA06	4/17	N	N
8WH9066-5BA06	7/7	N	N
8WH9067-5AA06	4/17	N	N
8WH9067-5BA06	7/7	N	N
8WH9070-0AA00	2/10, 2/13, 2/15, 4/17, 4/22, 4/24, 4/26, 5/6	N	N
8WH9070-0BA00	2/17, 4/32, 4/40	N	N
8WH9070-0DA00	4/17	N	N
8WH9070-0GA00	2/10, 2/15, 4/17, 4/24, 4/26, 4/38	N	N
8WH9070-0HA00	2/10, 4/17, 4/24, 4/26, 5/7	N	N

Article No.	Page	Export markings	
		ECCN	AL
8WH9070-0JA00	6/8	N	N
8WH9070-0KA00	4/22, 6/8, 6/12	N	N
8WH9070-0LA00	6/8	N	N
8WH9070-0MA00	6/10	N	N
8WH9070-6BA00	7/7	N	N
8WH9070-6FA00	7/14, 7/16, 7/23	N	N
8WH9070-6GA00	3/7	N	N
8WH9070-6HA00	3/7	N	N
8WH9076-1PA00	7/7	N	N
8WH9120-0AA00	7/27	N	N
8WH9120-0BA00	7/27	N	N
8WH9120-0CA00	7/27	N	N
8WH9120-0DB08	5/10	N	N
8WH9126-0BA01	3/11	N	N
8WH9130-0AA00	7/29	N	N
8WH9130-0BA00	7/29	N	N
8WH9130-0CA00	7/30	N	N
8WH9130-0DA00	7/30	N	N
8WH9130-0LA00	7/29	N	N
8WH9130-0MA00	7/29	N	N
8WH9130-0NA00	7/30	N	N
8WH9130-0PA00	7/30	N	N
8WH9140-0BA00	7/31	N	N
8WH9140-0CA00	7/31	N	N
8WH9140-0DA00	7/31	N	N
8WH9141-0BA01	3/11	N	N
8WH9142-0AF01	3/14	N	N
8WH9143-0AF01	3/5, 3/9	N	N
8WH9143-0AH01	3/5, 3/9	N	N
8WH9150-0CA00	8/8	N	N
8WH9150-1CA00	8/8	N	N
8WH9160-0AA00	7/14, 7/16, 7/23	N	N
8WH9200-0AA00	8/9	N	N
8WH9200-0AB00	8/9	N	N
8WH9200-0AC00	8/9	N	N
8WH9200-0AD00	8/9	N	N

A product's export markings are updated daily at [www.siemens.com/industrymall](http://www.siemens.com/industrymall).

## Appendix

### Conditions of sale and delivery

#### 1. General standards

By using this catalog you can acquire hardware and software products described therein from Siemens AG subject to these conditions of sale and delivery (hereinafter: CSD). Please note: the scope, the quality and the conditions for supplies and services, including software products, by any Siemens group or Regional Company having a registered office outside of Germany, shall be subject exclusively to the General Terms and Conditions of the respective Siemens entity. These CSD apply exclusively for orders placed with Siemens AG, Germany.

##### 1.1 For customers with a seat or registered office in Germany

For customers with a seat or registered office in Germany, the following shall be subordinate to these CSD

- the "General Terms of Payment"<sup>1)</sup> and
- for software products, the "General License Conditions for Software Products for Automation and Drives for Customers with a Seat or Registered Office in Germany"<sup>1)</sup> and
- the "General Conditions for the Supply of Products and Services of the Electrical and Electronics Industry"<sup>1)</sup> for other deliveries and services.

##### 1.2 For customers with a seat or registered office outside of Germany

For customers with a seat or registered office outside of Germany, the following shall be subordinate to these CSD

- the "General Terms of Payment"<sup>1)</sup> and
- for software products, the "General License Conditions for Software Products for Automation and Drives for Customers with a Seat or Registered Office outside of Germany"<sup>1)</sup> and
- the "General Conditions for Supplies of Siemens Industry for Customers with a Seat or Registered Office outside of Germany"<sup>1)</sup> for other deliveries and services.

#### 2. Prices

The prices are in € (Euro) ex works, excluding packaging.

The sales tax (value added tax) is not included in the prices. It shall be debited separately at the respective rate according to the applicable legal regulations.

Prices are subject to change without prior notice. We will debit the prices valid at the time of delivery.

To compensate fluctuating prices of raw materials (for example silver, copper, aluminum, lead, gold, dysprosium and neodymium), surcharges are calculated on a daily basis for products containing these raw materials using the metal factor. A surcharge for the particular raw material is added to the price of a product if the basic quotations for this raw material are exceeded.

Each product's metal factor dictates for which raw materials the metal surcharges are calculated, from which quotation and with which calculation method (weight or percentage method).

An exact explanation of the metal factor can be found on the page entitled "Metal surcharges".

The surcharge will be calculated (except in the case of dysprosium and neodymium) on the basis of the official price on the day prior to receipt of the order or prior to the release order for calculation of the surcharge.

In the event of placement of an order, the relevant three-month average price from the quarter prior to order receipt or the release order shall be used with a one-month buffer to calculate the dysprosium and neodymium surcharge ("rare earths") (you will find details in the aforementioned explanation of the metal factor).

#### 3. Additional terms and conditions

All dimensions are in mm. In Germany, according to the German law on units in metrology, data in inches only apply to devices for export.

Illustrations are not binding.

Insofar as there are no remarks on the corresponding pages of this catalog - especially with regard to data, dimensions and weights given - these are subject to change without prior notice.

#### 4. Export regulations

We shall not be obligated to fulfill this agreement if such fulfillment is prevented by any impediments arising out of national or international foreign trade or customs requirements or any embargoes or other sanctions.

Export of the products listed in this catalog may be subject to authorization. In delivery information, we label authorization obligations according to German, European and US export lists. Goods labeled with an "AL" not equal to "N" are subject to European or German export authorization when being exported out of the EU. Goods labeled with "ECCN" not equal to "N" are subject to a US re-export authorization.

Please note that you can also preview the export designations in the respective product description via our "Industry Mall" online catalog system. The deciding factors, however, are the AL or ECCN export designations indicated on order confirmations, delivery notes and invoices.

Even if goods are not labeled, or labeled "AL:N" or "ECCN:N", they may still be subject to export authorization based on the final destination and end use of the goods.

If you transfer goods (hardware and/or software and/or technology as well as corresponding documentation, regardless of the mode of provision) delivered by us or works and services (including all kinds of technical support) performed by us to a third party worldwide, you shall comply with all applicable national and international (re-) export control regulations.

If required to conduct export control checks, you, at our request, shall promptly provide us with all information pertaining to particular end customers, destination and intended use of goods, works and services provided by us, as well as any relevant export control restrictions.

The products listed in this catalog may be subject to European/German and/or US export regulations. Therefore, any export requiring a license is subject to approval by the competent authorities.

Errors excepted and subject to change without prior notice.

<sup>1)</sup> You can download the text of the Siemens AG terms and conditions of trade at

[www.siemens.com/automation/salesmaterial-as/catalog/en/terms\\_of\\_trade\\_en.pdf](http://www.siemens.com/automation/salesmaterial-as/catalog/en/terms_of_trade_en.pdf)



Further information can be obtained from our branch offices listed at [www.siemens.com/automation/partner](http://www.siemens.com/automation/partner)

<b>Interactive Catalog on DVD</b> Products for Automation and Drives	<i>Catalog</i> <b>CA 01</b>	<b>Low-Voltage Power Distribution and Electrical Installation Technology</b> SENTRON · SIVACON · ALPHA Protection, Switching, Measuring and Monitoring Devices, Switchboards and Distribution Systems Standards-Compliant Components for Photovoltaic Plants Electrical Components for the Railway Industry TÜV-certified Power Monitoring System Components for Industrial Control Panels according to UL Standards 3WT Air Circuit Breakers up to 4000 A 3VT Molded Case Circuit Breakers up to 1600 A <i>Digital: SIVACON System Cubicles, System Lighting and System Air-Conditioning</i> <i>Digital: ALPHA Distribution Systems</i> ALPHA FIX Terminal Blocks SIVACON S4 Power Distribution Boards SIVACON 8PS Busbar Trunking Systems <i>Digital: DELTA Switches and Socket Outlets</i>	<i>Catalog</i> LV 10 LV 11 LV 12 LV 14 LV 16 LV 35 LV 36 LV 50 LV 51 LV 52 LV 56 LV 70 ET D1
<b>Building Control</b> GAMMA Building Control	ET G1	<b>Motion Control</b> SINUMERIK 840D sl Type 1B Equipment for Machine Tools SINUMERIK 808 Equipment for Machine Tools SINUMERIK 828 Equipment for Machine Tools SIMOTION, SINAMICS S120 & SIMOTICS Equipment for Production Machines <i>Digital: Drive and Control Components for Cranes</i>	NC 62 NC 81.1 NC 82 PM 21 CR 1
<b>Drive Systems</b> SINAMICS G130 Drive Converter Chassis Units SINAMICS G150 Drive Converter Cabinet Units SINAMICS GM150, SINAMICS SM150 Medium-Voltage Converters SINAMICS PERFECT HARMONY GH180 Medium-Voltage Air-Cooled Drives Germany Edition SINAMICS G180 Converters – Compact Units, Cabinet Systems, Cabinet Units Air-Cooled and Liquid-Cooled SINAMICS S120 Chassis Format Units and Cabinet Modules SINAMICS S150 Converter Cabinet Units SINAMICS DCM DC Converter, Control Module SINAMICS DCM Cabinet SINAMICS Inverters for Single-Axis Drives and SIMOTICS Motors SINAMICS G120P and SINAMICS G120P Cabinet pump, fan, compressor converters LOHER VARIO High Voltage Motors Flameproof, Type Series 1PS4, 1PS5, 1MV4 and 1MV5 Frame Size 355 to 1000, Power Range 80 to 7100 kW Three-Phase Induction Motors SIMOTICS HV, SIMOTICS TN • Series H-compact • Series H-compact PLUS High Voltage Three-phase Induction Motors SIMOTICS HV Series A-compact PLUS Three-Phase Induction Motors SIMOTICS HV, Series H-compact Synchronous Motors with Permanent-Magnet Technology, HT-direct DC Motors SIMOREG DC MASTER 6RA70 Digital Chassis Converters SIMOREG K 6RA22 Analog Chassis Converters <i>Digital: SIMOREG DC MASTER 6RM70 Digital Converter Cabinet Units</i> SIMOVERT PM Modular Converter Systems SIEMOSYN Motors MICROMASTER 420/430/440 Inverters MICROMASTER 411/COMBIMASTER 411 <u>Low-Voltage Three-Phase-Motors</u> SIMOTICS Low-Voltage Motors SIMOTICS FD Low-Voltage Motors LOHER Low-Voltage Motors MOTOX Geared Motors SIMOGEAR Geared Motors SIMOGEAR Gearboxes with adapter <u>Mechanical Driving Machines</u> FLENDER Standard Couplings FLENDER High Performance Couplings FLENDER Backlash-free Couplings FLENDER SIG Standard industrial gear units FLENDER SIP Standard industrial planetary gear units	D 11 D 12 D 15.1 D 18.1 D 21.3 D 23.1 D 23.2 D 31 D 35 D 83.2 D 84.1 D 84.9 D 86.1 D 86.2 DA 12 DA 21.1 DA 21.2 DA 22 DA 45 DA 48 DA 51.2 DA 51.3 D 81.1 D 81.8 D 83.1 D 87.1 MD 50.1 MD 50.11 MD 10.1 MD 10.2 MD 10.3 MD 30.1 MD 31.1	<b>Power Supply</b> SITOP Power supply	KT 10.1
<b>Process Instrumentation and Analytics</b> <i>Digital: Field Instruments for Process Automation</i> <i>Digital: SIPART Controllers and Software</i> Products for Weighing Technology <i>Digital: Process Analytical Instruments</i> <i>Digital: Process Analytics, Components for Continuous Emission Monitoring</i>	FI 01 MP 31 WT 10 AP 01 AP 11	<b>Safety Integrated</b> Safety Technology for Factory Automation	SI 10
		<b>SIMATIC HMI / PC-based Automation</b> Human Machine Interface Systems/ PC-based Automation	ST 80/ ST PC
		<b>SIMATIC Ident</b> Industrial Identification Systems	ID 10
		<b>SIMATIC Industrial Automation Systems</b> Products for Totally Integrated Automation SIMATIC PCS 7 Process Control System System components SIMATIC PCS 7 Process Control System Technology components Add-ons for the SIMATIC PCS 7 Process Control System	ST 70 ST PCS 7 ST PCS 7 T ST PCS 7 AO
		<b>SIMATIC NET</b> Industrial Communication	IK PI
		<b>SIRIUS Industrial Controls</b> SIRIUS Industrial Controls	IC 10
		<i>Digital: These catalogs are only available as a PDF.</i>	
		<b>Information and Download Center</b> Digital versions of the catalogs are available on the Internet at: <a href="http://www.siemens.com/lowvoltage/infomaterial">www.siemens.com/lowvoltage/infomaterial</a>	

Siemens AG  
Energy Management  
Low Voltage & Products  
Postfach 10 09 53  
93009 REGENSBURG  
GERMANY

Subject to change without prior notice  
PDF (E86060-K1852-A101-A5-7600)  
KG 0217 222 En  
Produced in Germany  
© Siemens AG 2017

The information provided in this catalog contains merely general descriptions or characteristics of performance which in case of actual use do not always apply as described or which may change as a result of further development of the products. An obligation to provide the respective characteristics shall only exist if expressly agreed in the terms of contract. Availability and technical specifications are subject to change without notice.

All product designations may be trademarks or product names of Siemens AG or supplier companies whose use by third parties for their own purposes could violate the rights of the owners.