

# Catalog Number: MM0202B1150RJB

## Features and Ratings

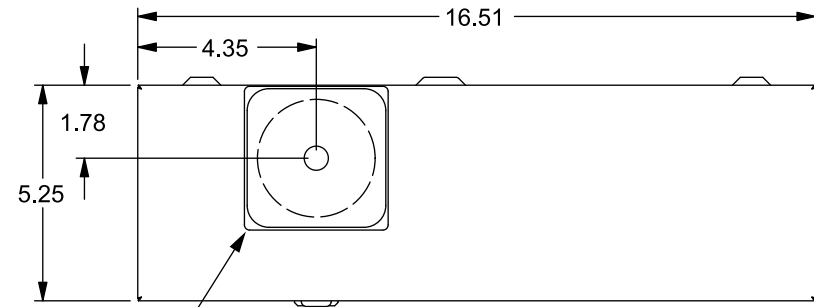

- Ringless Type Meter Cover
- 1 Phase, 3 Wire, 120/240V AC Max.
- 150A Main Breaker Factory Installed
- 200A Continuous Meter Socket Rating
- 5th Jaw Installed at 9 o'Clock
- 22,000 AIC Max. Rated (See Wiring Diagram for Details)
- Overhead or Underground Service Entrance
- RX Type Hub Provision on Top End Wall
- HC Type Hub Provision on Bottom End Wall
- Horn Bypass
- 7/8" Barrel Lock Provision



TYPE RX HUB OPENING COVER PLATE INSTALLED

View Shown with Doors, Deadfront, and Shields Removed

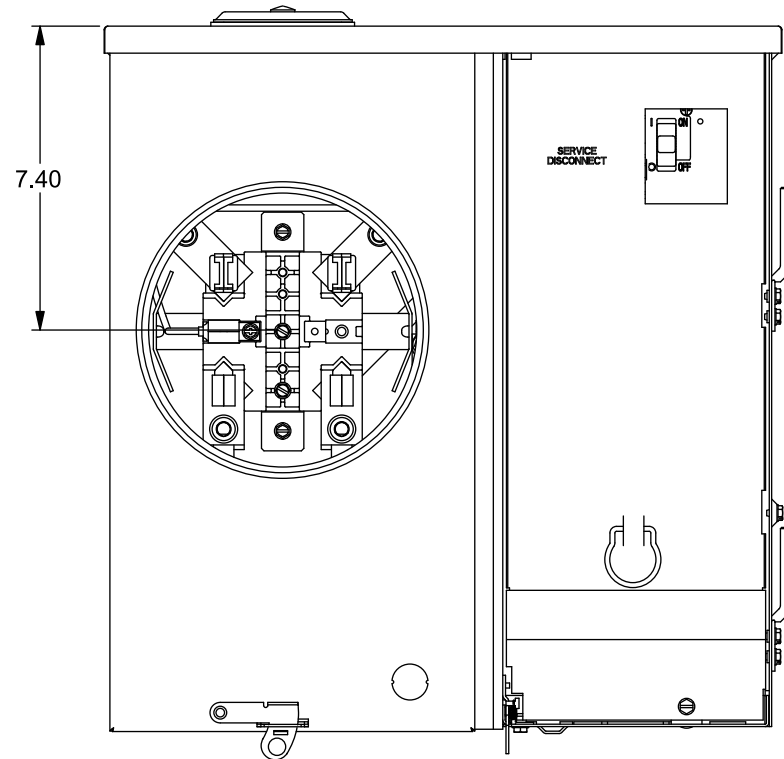

View Shown with Door Removed

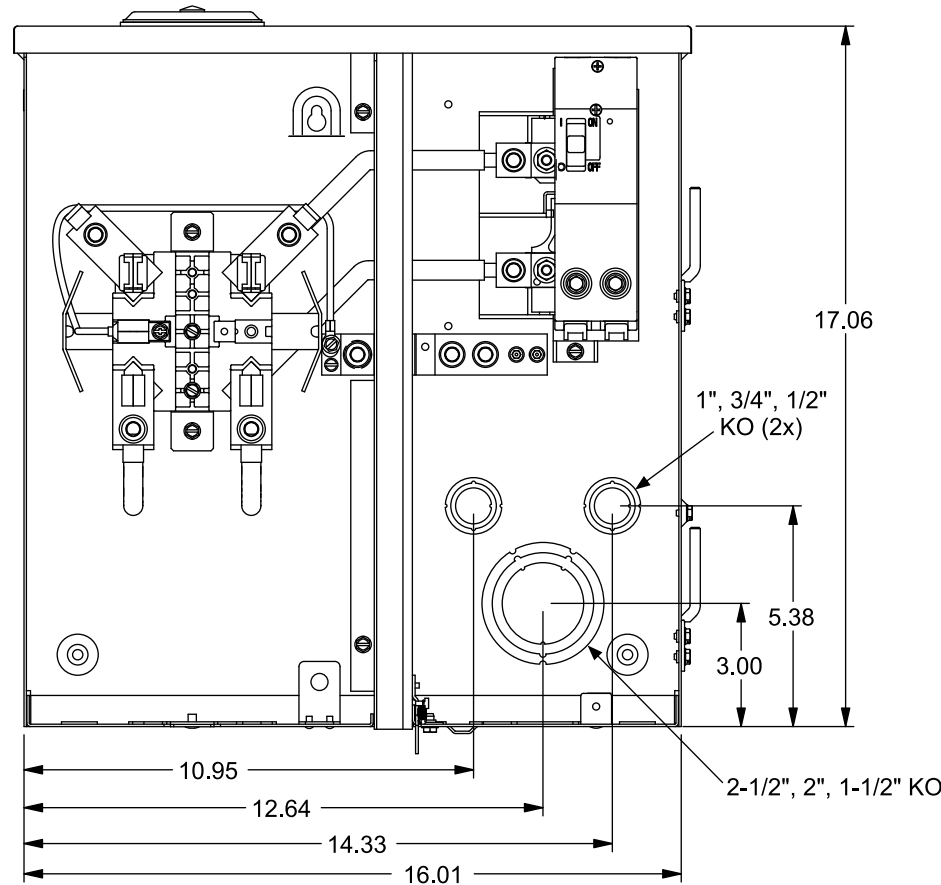

3", 2-1/2", 2", 1-1/2" KO Provision for HC Type Hub

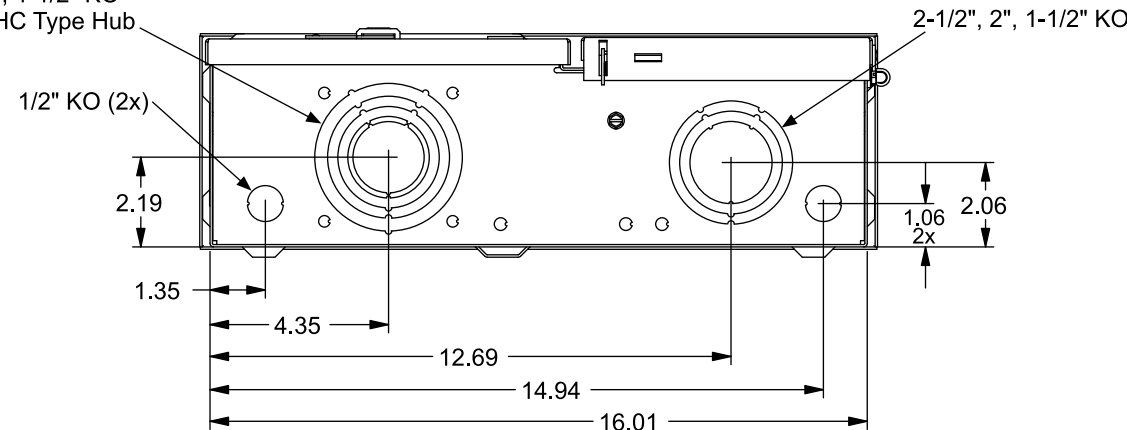

## Accessories

Trade size (in)	Catalog number
<i>RX Type Hub (top endwall)</i>	
1 1/4"	EC38597
1 1/2"	EC38598
2"	EC38599
2 1/2"	EC38600
RX Cover Plate	EC38595
<i>HC Type Hub (bottom endwall)</i>	
2"	ECHC200
2 1/2"	ECHC250
3"	ECHC300

## Schematic, Torques & Wire Sizes

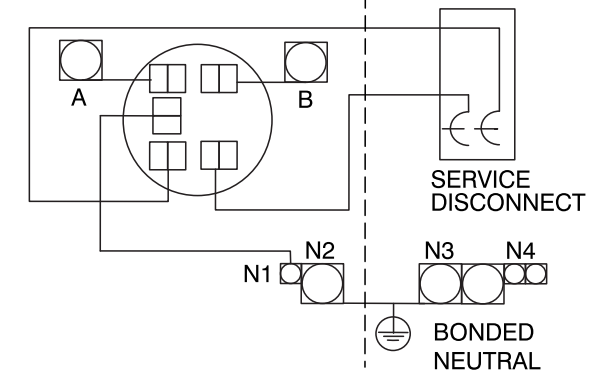

Terminal	Wire Size	Torque
A, B	250 kcmil - #6	275 lb in
N1	#2 - #3	50 lb in
	#4 - #6	45 lb in
	#8	40 lb in
	#10 - #14	35 lb in
N2	250 kcmil - #6	275 lb in
N3	250 kcmil - #4	275 lb in
N4	1/0 - #14	120 lb in

**MAIN BREAKER TERMINALS**  
See markings on breaker for torque requirements and conductor rating.

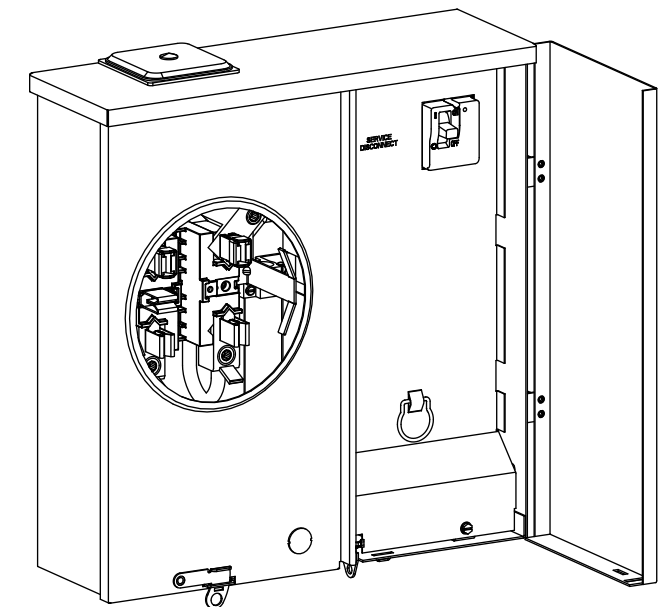

© 2018 Copyright Siemens Industry, Inc.

**SIEMENS**  
Siemens Industry, Inc.

### Meter/Breaker Combination

Description: **150A, Outdoor, OH/UG, Ringless, 5 Jaw, Horn Bypass, 7/8 BL Provision**

NH 5/3/18 Fam A DO NOT SCALE Dwg. No. **MM0202B1150RJB**