





Front rotary operating mechanism standard IEC IP30/40 Lighting kit
24 V DC Accessory for: 3VA6 400/600



Model	
Product brand name	SENTRON
Product designation	Accessories
Design of the product	Front rotary operating mechanism
accessories	FRONT ROTARY OPERATING MECHANISM
General technical data	
Degree of protection NEMA rating	NEMA 1
Mechanical Design	
Height	94 mm
Width	138 mm
Depth	108 mm
Certificates	

General Product Approval	EMC	Declaration of Conformity	other
 CSA	 UL		 RCM  EG-Konf. Miscellaneous

Further information

Information- and Downloadcenter (Catalogs, Brochures,...)

<http://www.siemens.com/lowvoltage/catalogs>

Industry Mall (Online ordering system)

<https://mall.industry.siemens.com/mall/en/en/Catalog/product?mlfb=3VA9447-0EK13>

Service&Support (Manuals, Certificates, Characteristics, FAQs,...)

<https://support.industry.siemens.com/cs/ww/en/ps/3VA9447-0EK13>

Image database (product images, 2D dimension drawings, 3D models, device circuit diagrams, ...)

http://www.automation.siemens.com/bilddb/cax_en.aspx?mlfb=3VA9447-0EK13

CAX-Online-Generator

<http://www.siemens.com/cax>

Tender specifications

<http://www.siemens.com/specifications>

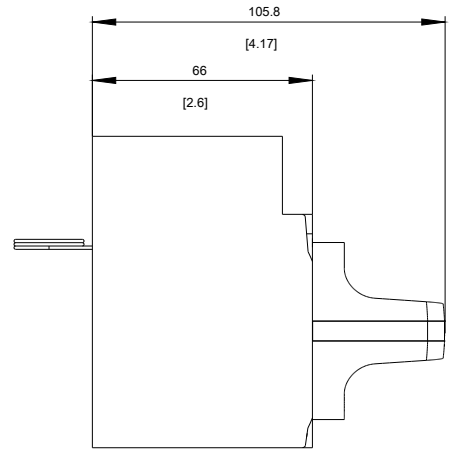
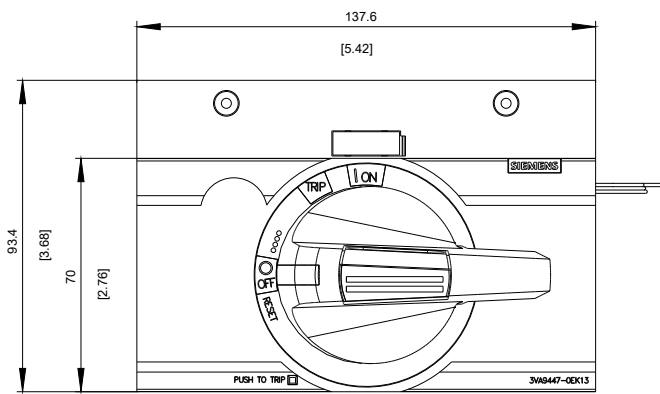

last modified:

12/05/2017