

Modernization Made Easy... And Code Conversion Made Simple

The Siemens **Totally Integrated Automation (TIA)** portfolio and the **TIA Portal**, a common software engineering framework, offer next-generation digitalization solutions to help you modernize your production infrastructure. Even more, our Migration Studio provides easy, no-charge code conversion, so you can reuse your code and turbocharge your company toward becoming a more competitive, more future-ready **Digital Enterprise**.

Five great reasons to **modernize now**

5



Boost ROI



Increase productivity

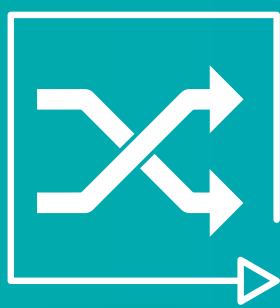

Enable transparency



Strengthen security



Improve safety

The code-conversion process: Easy as 1-2-3 ... and it's **free!**

1

The Siemens Migration Studio converts code to state-of-the-art code for use in the TIA Portal. It retains existing structures and naming conventions, keeping code familiar from the start.

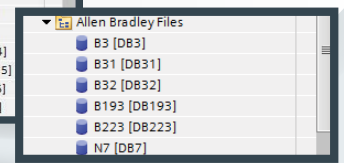
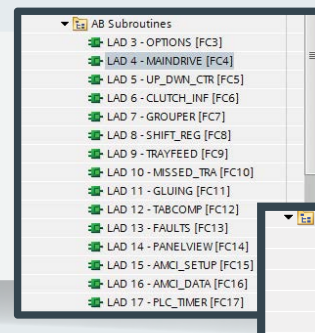
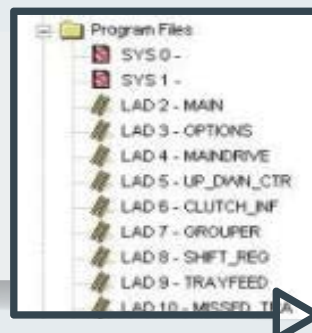

2

All ladder logic stays intact—including comments. By keeping code familiar, new TIA Portal users can get going right away. They can then start saving engineering time, up to 30 percent or more over conventional software engineering approaches.

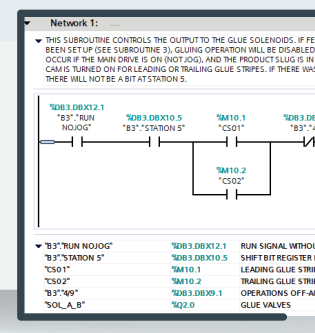
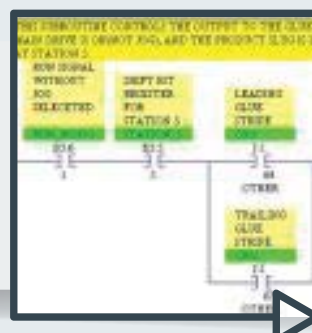

3

All tag names remain identical, too, while retaining comments. With the TIA Portal, you gain the advantages of consistent data management, global standards and uniform hardware and software interfaces.

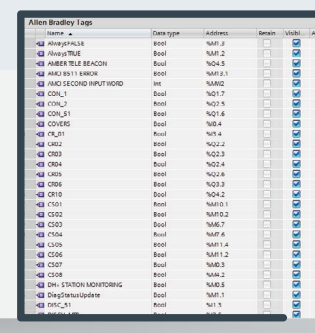
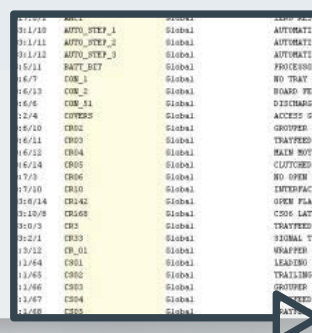

Our conversion experts will help you every step of the way

Interested? A bit unsure? Fear not! Our own code conversion experts will help you every step of the way. Get started by completing an online form you'll find at the following link: www.usa.siemens.com/code-conversion. You'll be asked to email a simple line drawing of your ICS architecture and an exported file of your code, which will be kept completely confidential. Within five business days of submitting the form, a Siemens code conversion expert will contact you to discuss your ICS modernization requirements and set up a convenient time to visit. This is a trained automation engineer—not a sales person or telemarketer—who will provide a no-charge, onsite consultation and assessment of your needs. Get started today. The sooner you act, the sooner your operations will become a more profitable, agile and competitive Digital Enterprise that's well positioned for many decades to come.

usa.siemens.com/code-conversion