

SIEMENS

DRY TYPE TRANSFORMERS

NOTES:

1. ALL UNITS ARE UL LISTED AND ARE DESIGNED IN ACCORDANCE WITH ANSI C89.2 AND NEMA ST-20 STANDARDS.
2. THESE TRANSFORMERS UTILIZE A UL RECOGNIZED 220°C INSULATION SYSTEM, TEMPERATURE RISE AS INDICATED IN THE TABLE.
3. TRANSFORMERS ARE DRY TYPE, CLASS AA, VENTILATED ENCLOSURE FOR INDOOR USE. OPTIONAL WEATHER KITS ARE AVAILABLE FOR ADAPTING THE UNIT FOR 3R USE WITHOUT VOIDING THE UL LABEL.
4. FOR LIFTING OTHER THAN WITH FORK TRUCK, REMOVE TOP COVER AND USE CORE CLAMPS FOR 100KVA & UP.
5. PAINT COLOR IS ANSI #61 GRAY.
6. FULL WIDTH COPPER ELECTROSTATIC SHIELD (OPTIONAL).
7. 6" REQUIRED CLEARANCE FROM THE WALLS.
8. HV/LV TERMINALS ARE TOP FRONT TERMINATED.

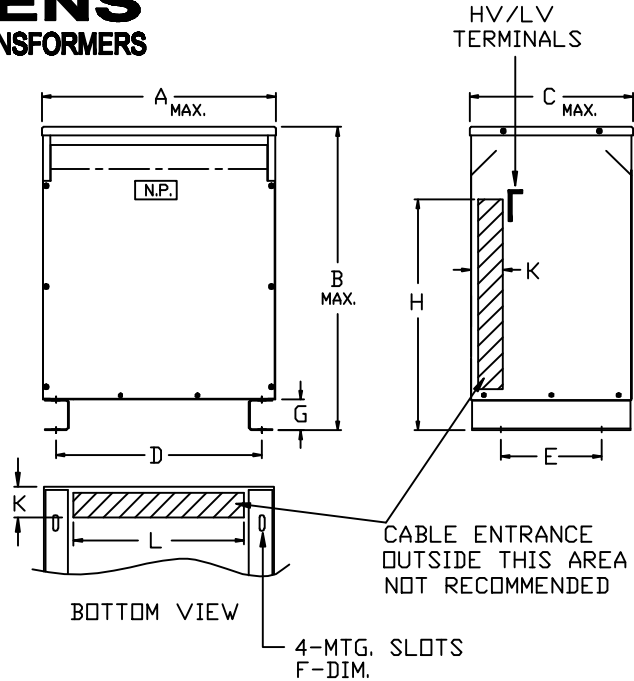

KVA	TEMP. RISE °C	NET WT. LBS.	DIMENSIONS IN INCHES									
			A	B	C	D	E	F	G	H	K	L
15	150	250	15.00	27.00	15.00	12.50	11.00	.56 x 1.13	3.00	19.00	3.00	10.00
25	150	340	17.00	29.00	17.00	14.00	13.00	.56 x 1.13	3.00	20.00	3.00	11.00
37.5	150	475	20.00	31.00	18.00	16.88	14.00	.56 x 1.13	3.00	20.00	3.00	14.00
50	150	600	22.00	32.00	20.00	19.00	16.00	.56 x 1.13	3.00	22.00	3.00	16.00
75	150	725	22.00	34.00	22.00	19.00	16.00	.56 x 1.13	3.00	26.00	3.00	16.00
100	150	900	22.00	36.00	24.00	19.00	18.00	.56 x 1.13	3.00	28.00	3.00	16.00
167	150	1225	35.00	46.00	30.00	31.50	25.00	.56 x 1.13	3.00	32.00	5.00	27.50
200	150	1635	35.00	52.00	30.00	31.50	25.00	.56 x 1.13	3.00	32.00	5.00	27.50
225	150	1790	35.00	52.00	30.00	31.50	25.00	.56 x 1.13	3.00	32.00	5.00	27.50
250	150	1925	35.00	52.00	30.00	31.50	25.00	.56 x 1.13	3.00	32.00	5.00	27.50
333	150	2825	48.00	60.00	33.00	42.00	27.00	.56 x 1.13	4.00	36.00	5.00	34.00

KVA	QTY.	CATALOG NO.	VOLTAGE		TAPS	DRAWING
			PRIMARY	SECONDARY		
						<input type="checkbox"/> APPROVAL
						<input type="checkbox"/> RECORD
						<input type="checkbox"/> OTHER

CUST.	DWN. BY:	Siemens Industry, Inc.
	DATE:	
JOB	CHK. BY:	GENERAL PURPOSE TRANSFORMERS SINGLE-PHASE, 600 VOLTS CLASS, 60 HZ. K-FACTOR (1) RATED - COPPER - TP1
P.O.	DATE:	
TIE	APVD. BY:	
S.O.	DATE:	DWG. NO. J-119
		REV. D DATE 06/22/11